

ENGLISH  
ELECTRIC  
VALVE  
CO LTD



Television Camera Tubes  
Storage Tubes  
Image Intensifiers  
Glow Modulators Flash Tubes

Product  
Data

1973

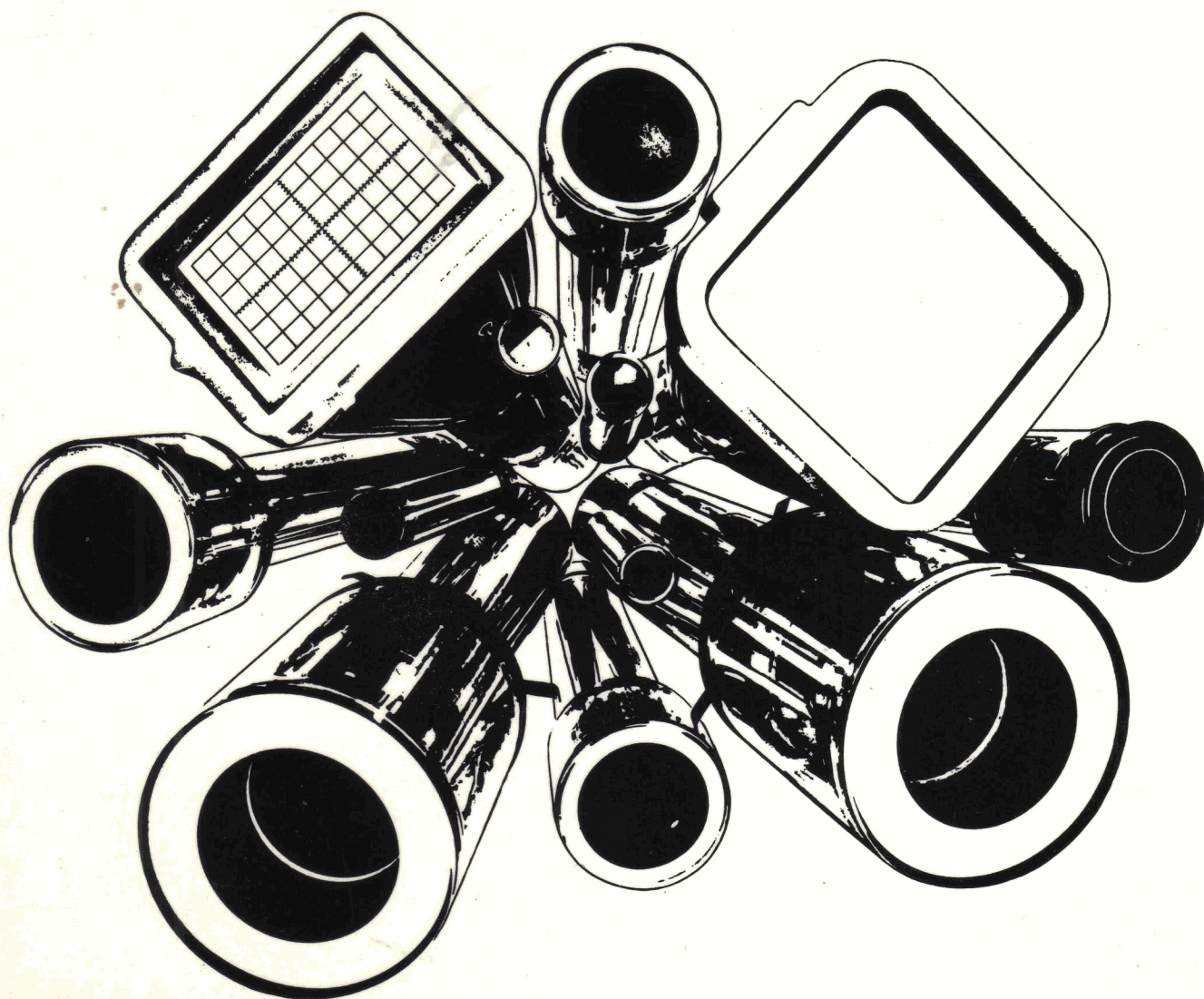

English Electric Valve Company Limited is a member of  
**THE GEC ELECTRONIC TUBE COMPANY LIMITED**, a management company  
which unites the activities of:

**The M-O Valve Company Limited**, Brook Green Works, Hammersmith, London W6 7PE  
Telephone: 01 603-3431 Telex: 23435 Cables: Thermionic London

**English Electric Valve Company Limited**, Waterhouse Lane, Chelmsford, Essex. CM1 2QU  
Telephone: Chelmsford (0245) 61777 Telex: 99103 Cables: Enelectico, Chelmsford.

---

**QUICK REFERENCE TABLES  
AND EQUIVALENTS INDEX**

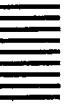

---

**STORAGE TUBES**

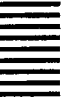

---

**IMAGE ORTHICONS**

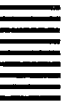

---

**IMAGE ISOCONS**

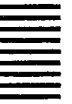

---

**LEDDICONS**

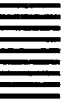

---

**SIDICONS**



---

**VIDICONS**

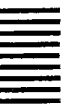

---

**IMAGE INTENSIFIERS  
AND SHUTTER TUBES**

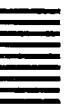

---

**GLOW MODULATORS**

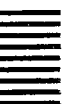

---

**FLASH TUBES**

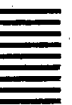

---

**OVERSEAS REPRESENTATIVES  
AND DISTRIBUTORS**

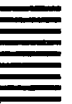

The Product Data Book comprises ten bound volumes, made up as follows:

- **IGNITRONS**  
**RECTIFIERS**  
**INDUSTRIAL THYRATRONS**  
**VOLTAGE STABILIZERS**  
**OTHER PRODUCTS**
- **TRIODES**
- **TETRODES AND PENTODE**
- **HYDROGEN THYRATRONS**  
**PULSE AMPLIFIER TETRODES**
- **MAGNETRONS**
- **AMPLIFIER KLYSTRONS**
- **OSCILLATOR KLYSTRONS**  
**TRAVELLING WAVE TUBES**  
**BACKWARD WAVE OSCILLATORS**
- **DUPLEXER DEVICES**  
**MONITOR DIODES**  
**NOISE TUBES**
- **ELECTRO-OPTICAL DEVICES**  
**Storage Cathode Ray Tubes**  
**Television Camera Tubes**  
**Image Intensifiers and Shutter Tubes**  
**Glow Modulators**  
**Flash Tubes**
- **VACUUM CAPACITORS**

These bound volumes replace the previous loose-leaf books and will be re-issued at intervals. When the most recent data are required for equipment design purposes, the individual sheets should be obtained.



**Quick Reference  
Tables and  
Equivalents Index**

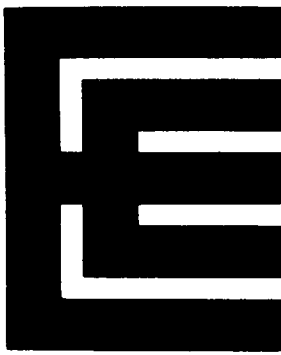

# QUICK REFERENCE TABLES

## ELECTRO-OPTICAL DEVICES

---

### STORAGE TUBES

---

Type	Description	Page no.
<b>E702A (CV5877)</b>	Direct view storage tube for radar applications. Electrostatic deflection, useful screen area 4.0 inches (101.6mm) diameter, typical brightness 900ft-lamberts.	<b>47</b>
<b>E702B (CV5987)</b>	Direct view storage tube with ruggedized construction, for radar applications under limited vibration and low pressure conditions. Electrostatic deflection, useful screen area 4.0 inches (101.6mm) diameter, typical brightness 2150ft-lamberts.	<b>63</b>
<b>E702E</b>	Direct view storage tube for radar, medical and picture storage applications. Similar to E702A but with improved uniformity of erasure. Electrostatic deflection, useful screen area 4.0 inches (101.6mm) diameter, typical brightness 900ft-lamberts.	<b>47</b>
<b>E712A</b>	Direct view storage tube for radar and data terminal applications, allowing selective erasure by voltage switching. Magnetic deflection, useful screen area 9.0 inches (228.6mm) diameter, typical brightness 1000ft-lamberts.	<b>79</b>
<b>E713B (CV9422)</b>	Direct view storage tube for radar applications under limited vibration conditions. Magnetic deflection, useful screen area 4.0 inches (101.6mm) diameter, typical brightness 1800ft-lamberts.	<b>95</b>
<b>E714A</b>	Direct view storage tube with split-beam writing gun, for oscilloscope applications. Normally used in half-tone mode, but will also operate as a P.D.A. oscilloscope tube without storage. Electrostatic deflection, useful screen area 10cm x 6cm rectangular, minimum brightness 90ft-lamberts.	<b>107</b>
<b>E714C</b>	Direct view storage oscilloscope tube with encapsulated screen lead and internal graticule. Normally used in half-tone mode, but will also operate as a P.D.A. oscilloscope tube without storage. Electrostatic deflection, useful screen area 10cm x 6cm rectangular, minimum brightness 90ft-lamberts.	<b>119</b>

Continued on page 6

December 1972

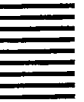

## STORAGE TUBES (Continued)

Type	Description	Page no.
<b>E714D</b>	Direct view storage oscilloscope tube, similar to E714C but without encapsulation or internal graticule. Electrostatic deflection, useful screen area 10cm x 6cm rectangular, minimum brightness 90ft-lamberts.	<b>131</b>
<b>E714G</b>	Direct view storage oscilloscope tube, similar to E714C but without internal graticule. Electrostatic deflection, useful screen area 10cm x 6cm rectangular, minimum brightness 90ft-lamberts.	<b>143</b>
<b>E714H</b>	Direct view storage oscilloscope tube, shorter than other E714 types with reduced deflection sensitivity and higher writing speed. Normally used in half-tone mode, but will also operate as a P.D.A. oscilloscope tube without storage. Electrostatic deflection, useful screen area 10cm x 6cm rectangular, minimum brightness 90ft-lamberts.	<b>153</b>
<b>E716A</b>	Direct view storage oscilloscope tube suitable for radar, sonar, ultrasonic and medical applications. Normally used in half-tone mode, but will also operate as a P.D.A. oscilloscope tube without storage. Electrostatic deflection, useful screen area 10cm x 10cm square, minimum brightness 90ft-lamberts.	<b>163</b>
<b>E719A</b>	Direct view storage oscilloscope tube, similar to E714 but with increased Y deflection sensitivity. Normally used in half-tone mode, but will also operate as a P.D.A. oscilloscope tube without storage. Electrostatic deflection, useful screen area 10cm x 6cm rectangular, minimum brightness 90ft-lamberts.	<b>173</b>
<b>E720A</b>	Direct view storage oscilloscope tube with encapsulated screen lead and internal graticule. Normally used in half-tone mode, but will also operate as a P.D.A. oscilloscope tube without storage. Electrostatic deflection, useful screen area 9cm x 7.2cm rectangular, minimum brightness 100ft-lamberts.	<b>183</b>
<b>EP750</b>	Single-gun electrical storage tube with silicon target, in a modified vidicon envelope. Suitable for video storage, scan conversion, image integration.	<b>195</b>

## IMAGE ORTHICONS

All the Image Orthicons listed incorporate the ELCON target, (Brit. pat. no. 1048390). The use of ELCON targets results in the virtual elimination of image retention (sticking) and gives stability of sensitivity throughout tube life.

Type ●	Description	Page no.
<b>7295C</b>	4½-inch tube for high quality studio and outdoor broadcasts.  Medium target capacitance producing approximately half power law gamma when operated one stop above the 'knee'. Unilateral replacement for 7295B. Higher signal-to-noise ratio and resolution than 3-inch tubes with similar target spacing.	<b>201</b>
<b>7389C</b>	4½-inch tube for use in studios where accurate control of lighting is possible. Recommended for use in cameras containing gamma correction circuits.  It has a higher target capacitance than 7295C, giving improved signal-to-noise ratio and extended linear transfer characteristics. Minimal spurious signals, enabling pictures of photographic quality to be produced. Unilateral replacement for 7389B.	<b>213</b>
<b>P858</b>	4½-inch tube for use as the luminance tube in colour cameras such as TK42/43. Target operates at up to 4V, giving improved signal-to-noise ratio.	<b>225</b>
<b>P874†</b>	3-inch tube for high quality studio and outdoor broadcast applications, monochrome or colour.  Replaces 8093B and has improved signal-to-noise ratio.	<b>227</b>
<b>P875†</b>	3-inch tube for high quality studio and outdoor broadcast applications, monochrome or colour.  Similar to P874 but with lower target capacitance. Unilaterally replaces 7293B and 4415, and has improved signal-to-noise ratio.	<b>243</b>

† Incorporates an anti-ghost image section, field mesh and suppressor electrode. Features resulting from the design include the elimination of dynode background in the picture and improved signal-to-noise ratio.



## IMAGE ISOCONS

(Made to special order only)

Type	Description	Page no.
P850	High sensitivity 4½-inch tube with a curved faceplate, intended for television pick-up from very low intensity images on X-ray fluoroscopic screens, and similar applications at very low light levels. With fixed beam current it reproduces scenes having a wide dynamic range, with good tonal response and without excess beam noise of image orthicons.	261
P880	High sensitivity 3-inch tube, externally similar to image orthicon, intended for television pick-up at very low light levels. It can also be used in X-ray applications. Most image orthicon cameras can readily be modified to accept it. With fixed beam current it reproduces scenes having a wide dynamic range, with good tonal response and without excess beam noise of image orthicons.	269
P887	Similar to P880 with fibre-optic faceplate for coupling to image intensifiers.	283
P8040‡	High sensitivity 55mm tube with plain glass faceplate. It is particularly suitable where high performance from a small camera is required. The tube can be supplied fitted with a deflection yoke.	289
P8041‡	High sensitivity 55mm tube, identical with P8040 but with fibre-optic faceplate.	289

‡ Test camera for this tube can be supplied to special order.

## LEDDICONS

Photoconductive camera tubes with high sensitivity lead oxide target, for high definition pick-up in monochrome and colour broadcast cameras. Features of these tubes include very short lag, low dark current and unity gamma. All types have 6.3V, 95mA heaters.

Type	Application	Construction	Page no.
<b>P8000</b> <b>P8000B</b> <b>P8000G</b> <b>P8000L</b> <b>P8000R</b>	Monochrome Blue channel Green channel Luminance channel Red channel	30mm diameter, integral mesh	<b>305</b>
<b>P8001</b> <b>P8001B</b> <b>P8001G</b> <b>P8001L</b> <b>P8001R</b>	Monochrome Blue channel Green channel Luminance channel Red channel	30mm diameter, separate mesh	<b>313</b>
<b>P8004</b> <b>P8004B</b> <b>P8004G</b> <b>P8004L</b> <b>P8004R</b>	Monochrome Blue channel Green channel Luminance channel Red channel	30mm diameter, integral mesh with light bias	<b>321</b>
<b>P8005</b> <b>P8005B</b> <b>P8005G</b> <b>P8005L</b> <b>P8005R</b>	Monochrome Blue channel Green channel Luminance channel Red channel	30mm diameter, separate mesh with light bias	<b>331</b>
<b>P8021</b> <b>P8021B</b> <b>P8021G</b> <b>P8021L</b> <b>P8021R</b>	Monochrome Blue channel Green channel Luminance channel Red channel	Mechanically interchangeable with 1-inch separate mesh vidicons	<b>341</b>

## SIDICONS

1-inch diameter tube with silicon diode array target. Operates in vidicon cameras with minor modifications.

Unaffected by extreme light overload and scan failure. No photoconductive lag. High sensitivity including near infra-red. Resistant to mechanical vibration.

Type	Application	Page no.
<b>P8011A</b> <b>P8011B</b> <b>P8011C</b>	High quality industrial television General purpose industrial Surveillance	<b>351</b>

## 1-INCH VIDICONS

Type	Application	Class (see foot of page 12)	Page no.
7038	• Telecine and caption scanning.	IMAH	365
7262A	Short tube for broadcast, educational and industrial use.	IMBL	377
7735	General purpose closed-circuit systems.	IMBH	393
7735A	Similar to 7735 but meets improved specification.	IMBH	393
7735B	High quality broadcast, educational, telecine and industrial use.	IMBH	395
8134	Broadcast and industrial, compact monochrome.	SEBL	421
8134V1	Selected 8134 for use in red, blue or green channels of colour cameras.	SEBL	435
8507A	Broadcast, educational and high quality industrial use.	SMBH	453
8541A	Broadcast, educational and high quality industrial use.	SMBL	483
8572A	Broadcast, telecine and caption scan- ning.	SMAH	499
8625	Broadcast, studio and educational.	SMCH	515
8626	Broadcast, studio and educational.	SMCL	515
P826/4478	Industrial.	IMB/CH	531
P831	Military and industrial, involving severe shock and vibration.	SMBL	533

Continued on page 11

## 1-INCH VIDICONS (Continued)

Type	Application	Class (see foot of page 12)	Page no.
<b>P844</b> ●	Broadcast, telecine and caption scanning.	SMAL	<b>545</b>
<b>P848</b>	Industrial and educational.	SMB/CH	<b>559</b>
<b>P848D</b>	Industrial.	SMB/CH	<b>573</b>
<b>P849</b>	Industrial and educational.	SMB/CL	<b>559</b>
<b>P849D</b>	Industrial.	SMB/CL	<b>573</b>
<b>P863</b>	Military and industrial, involving severe shock and vibration.	SMBL	<b>575</b>
<b>P866</b>	Short tube for broadcast, educational and high quality industrial use.	SMBL	<b>587</b>
<b>P893/4493</b>	Red channel of 4-tube colour cameras.	SEBL	<b>589</b>
<b>P894/4494</b>	Green channel of 4-tube colour cameras.	SEBL	<b>589</b>
<b>P895/4495</b>	Blue channel of 4-tube colour cameras.	SEBL	<b>589</b>
<b>P8018A</b>	Very short, rugged tube with integral focus and deflection coils, for military and industrial applications.	SMBL	<b>597</b>
<b>P8018B</b>	Version of P8018A with signal lead brought out at base end.	SMBL	<b>597</b>
<b>P8030</b>	Broadcast, educational and high quality industrial use.	SMBJ	—
<b>P8031</b>	Industrial and educational.	SMB/CJ	—
<b>P8034</b>	Long lag tube for X-ray and radar screen viewing.	IMDH	<b>611</b>
<b>P8034A</b>	Long lag tube for X-ray and radar screen viewing.	SMDL	<b>629</b>

## 1½-INCH VIDICONS

Type	Application	Class (see foot of page)	Page no.
8051	Broadcast telecine and data transmission.	SMAH	407
8480	Colour or monochrome cameras, telecine and high grade industrial use.	SEAL	439
8480V1	Selected 8480 for high quality colour cameras.	SEAL	451
8521	High resolution industrial.	SMAH	469

### CLASS

Mesh Connection		Focus Method		Heater Current	
S	Separate mesh	M	Magnetic focus	L	95mA
I	Integral mesh	E	Electrostatic focus	J	300mA
				H	600mA

### Vidicon Photosurfaces

**Photosurface A** The colour response peaks at the blue end of the spectrum providing panchromatic response when used with tungsten lighting. This layer has a very rapid decay time (short lag) when used at high light levels.

**Photosurface B** The colour response peaks in the green region and extends into the near infra-red; near panchromatic response is obtained in daylight. This photosurface provides higher sensitivity than type A and has high sensitivity at both high and low light levels. It must not be exposed to bright lights for long periods.

**Photosurface C** This photosurface is similar in sensitivity to type B but its colour response peaks in the blue region. It provides panchromatic response with tungsten illumination. It has extremely short lag when used at light levels of 1–10 ft-candles incident on the faceplate.

**Photosurface D** This photosurface has been specially designed with long lag characteristic. It is intended for integrating repetitive light of low level such as from X-ray image intensifier screens or c.r.t. displays.

## IMAGE INTENSIFIERS AND SHUTTER TUBES

Type	Application	Page no.
<b>P855*</b>	Tetrode image converter with electrostatic focus and deflection, for high-speed photography in pulse and sweep modes.	<b>649</b>
<b>P856*</b>	Triode image converter with electrostatic focus and deflection, for high-speed photography in pulse and sweep modes.	<b>661</b>
<b>P896</b>	3-stage, fibre-optic coupled image intensifier for night vision applications, with a luminous gain of $1.1 \times 10^4$ cd/lm. Encapsulated in silicone rubber complete with e.h.t. multiplier.	<b>669</b>
<b>P896B</b>	Similar to P896, with luminous gain $6.5 \times 10^3$ cd/lm.	<b>673</b>

## GLOW MODULATORS

Type	Luminance min. ‡ (candela/in <sup>2</sup> )	Luminous intensity min. ‡ (candela)	Operating voltage max. ‡ (V)	Page no.
<b>1B59</b>	110	0.3	150	<b>679</b>
<b>XL601</b>	550	0.27	150††	<b>683</b>
<b>XL602</b>	137	0.375	150	<b>687</b>
<b>XL603</b>	137	0.375	150	<b>691</b>
<b>XL627</b>	Rugged version of XL601 in metal envelope			<b>693</b>
<b>XL628</b>	800	0.4	150	<b>697</b>
<b>XL631</b>	550	0.27	150††	<b>699</b>
<b>XL632</b>	550	0.11	150††	<b>701</b>

\* Suitable camera available from:  
John Hadland Ltd.,  
Newhouse Laboratories,  
Bovingdon, Herts.

‡ At 30mA d.c.  
†† At 20mA d.c.

## FLASH TUBES

The XL615 and XL639 series of flash tubes are suitable for the excitation of ruby lasers.

Type	Energy input per flash max. (J)	Arc length (inches)	Typical operation		Page no.
			Voltage (kV)	Flash rate	
<b>XL615/4/2</b>	250	2.0	2.5	1 per 30s	<b>705</b>
<b>XL615/4/3</b>	400	3.0	2.5	1 per 30s	<b>707</b>
<b>XL615/7/1.75</b>	300	1.75	2.5	1 per 15s	<b>709</b>
<b>XL615/7/2</b>	400	2.0	2.5	1 per 15s	<b>711</b>
<b>XL615/7/3</b>	600	3.0	2.5	1 per 15s	<b>713</b>
<b>XL615/7/6</b>	1200	6.0	2.5	1 per 15s	<b>715</b>
<b>XL615/7/6.5</b>	1300	6.5	2.5	1 per 15s	<b>717</b>
<b>XL615/7-2/1.75TW</b>	100	1.75	2.5	1 per 15s	<b>719</b>
<b>XL615/9/4</b>	1500	4.0	2.5	1 per 30s	<b>721</b>
<b>XL615/9/10</b>	3500	10	2.5	1 per 30s	<b>723</b>
<b>XL615/10/5.5</b>	3500	5.5	2.5	1 per 60s	<b>725</b>
<b>XL615/10/6.5</b>	5000	6.5	2.5	1 per 2 min.	<b>727</b>
<b>XL615/10/12</b>	9000	12	2.5	1 per 2 min.	<b>729</b>
<b>XL615/10/40</b>	20 000	40	3.0	1 per 2 min.	<b>731</b>
<b>XL615/13/6.5</b>	10 000	6.5	2.5	1 per 2 min.	<b>733</b>
<b>XL615/13/9</b>	12 500	9.0	2.5	1 per 2 min.	<b>735</b>
<b>XL615/13/12</b>	18 000	12	2.5	1 per 2 min.	<b>737</b>
<b>XL630</b>	Spiral flash tube for stroboscopic applications. Average input power 40W max., operating frequency 300Hz max.				<b>739</b>
<b>XL639/4/1.75</b>	250	1.75	2.5	1 per 30s	<b>741</b>
<b>XL639/4/2.75</b>	400	2.75	2.5	1 per 30s	<b>743</b>

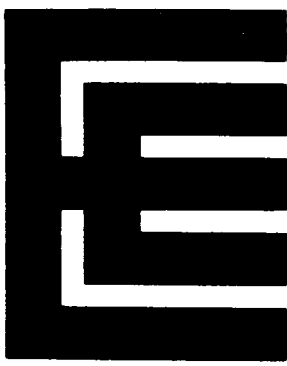

# EQUIVALENTS INDEX

## ELECTRO-OPTICAL DEVICES

Type to be replaced	EEV replacement	Type to be replaced	EEV replacement
1B59	1B59	5820A	P874
1255FIM*	7038		P875
1255NOR*	7038	5820A/E	P874
2255*	8626		P875
2255AMR*	P849D	5820A/L	P874
2255CG	P849D		P875
2255ED	P849	5960-00-082-4125	7262A
2255IND	P8031	5960-00-800-0602	7038
2255IND*	P849	5960-00-958-0083	7262A
2255SB	8541A	5960-17-035-0700	P849
2255SV	P849D	5960-99-037-2961	E702A
2700	8134	5960-99-037-3196	E702B
4415	P875	5960-99-037-4063	P831
4478	P826/4478	5960-99-037-4671	E713B
4493	P893/4493	5960-99-037-5321	8626
4494	P894/4494	5960-99-037-5879	P863
4495	P895/4495	5960-99-118-1616	P849
5820	P874	6198	7735A
	P875	6240-99-996-4114	XL615/4/3

\* Near equivalent



Type to be replaced	EEV replacement	Type to be replaced	EEV replacement
6326	7038	8093B	P874
6866*	E702B	8134	8134
7038	7038	8134V1	8134V1
7262A	7262A	8134VB	8134V1
7293	P875	8480	8480
7293A	P875	8480V1	8480V1
7293A/E	P875	8507	8507A
7293B	P875	8507A	8507A
7294	P874	8521	8521
7294/E	P874	8541	8541A
7295	7295C	8541A	8541A
7295/E	7295C	8566	8626
7295B	7295C	8572	8572A
7295B/E	7295C	8572A	8572A
7295C	7295C	8604	P844
7389	7389C	8625	8625
7389/E	7389C	8626	8626
7389B	7389C	9549	P874
7389B/E	7389C		P875
7389C	7389C	9564	7295C
7735	7735	9565	7389C
7735A	7735A	9677	8626
7735B	7735B	9677B	8541A
8051	8051	9677C	P849
8093A	P874	9677F1	P844
8093A/E	P874	9677F2	P844

\* Near equivalent

Type to be replaced	EEV replacement	Type to be replaced	EEV replacement
9677M	P849D	C9138A	P8031
9677P*	P849D	CV5207	1B59
9677S1	8626	CV5877	E702A
9677S2	8541A	CV5987	E702B
9812PA	P849	CV8797	P831
9814PA	P831	CV9422	E713B
9817PA	8626	E702A	E702A
10667B*	7735B	E702B	E702B
10667F	7038	E702E	E702E
10667G	7735A	E712A	E712A
55850*	7038	E713B	E713B
55850F	P844	E714A	E714A
55850N	P849	E714C	E714C
55850S	8541A	E714D	E714D
55875	P8000	E714G	E714G
55875B	P8000B	E714H	E714H
55875G	P8000G	E716A	E716A
55875L	P8000L	E719A	E719A
55875R	P8000R	E720A	E720A
C102A	P8031	EP750	EP750
C103A	P8030	FX38C-3	XL615/4/3
C932	7735A	FX42C-3	XL615/7/3
C933	7038	FX47A	XL615/13/6.5
C960	P874	FX47C-6.5	XL615/13/6.5
	P875	ML6198	7735A
C962	P874	OS20F	P874

\* Near equivalent

<b>Type to be replaced</b>	<b>EEV replacement</b>	<b>Type to be replaced</b>	<b>EEV replacement</b>
OS20H	P874	P848D	P848D
OS40F	P875	P849	P849
OS40H	P875	P849D	P849D
P807	P874	P850	P850
P807/E	P874	P851	P875
P810	7735A	P851/4415	P875
P811	7295C	P855	P855
P811/E	7295C	P856	P856
P813	7038	P858	P858
P816	P874	P863	P863
	P875	P866	P866
P816/E	P874	P874	P874
	P875	P875	P875
P820	7038	P880	P880
P822	7389C	P887	P887
P822/E	7389C	P893/4493	P893/4493
P826	P826/4478	P894/4494	P894/4494
P826/4478	P826/4478	P895/4495	P895/4495
P831	P831	P896	P896
P841	8507A	P896B	P896B
P842	8541A	P8000	P8000
P843	8572A	P8000B	P8000B
P844	P844	P8000G	P8000G
P846	8625	P8000L	P8000L
P847	8626	P8000R	P8000R
P848	P848	P8001	P8001

Type to be replaced	EEV replacement	Type to be replaced	EEV replacement
P8001B	P8001B	P8040	P8040
P8001G	P8001G	P8041	P8041
P8001L	P8001L	R1130B	1B59
P8001R	P8001R	R1169	XL601
P8004	P8004	TH9700	P875
P8004B	P8004B	TH9701	P874
P8004G	P8004G	TH9804	7038
P8004L	P8004L	TH9806PA	P849
P8004R	P8004R	TH9807PA	P844
P8005	P8005	TH9808PA	P849
P8005B	P8005B	TH9812PA	P849
P8005G	P8005G	TH9814PA	P831
P8005L	P8005L	TH9817PA	8626
P8005R	P8005R	TH9831	8480
P8011A	P8011A	XE1-3	XL615/4/3
P8011B	P8011B	XL601	XL601
P8011C	P8011C	XL602	XL602
P8018A	P8018A	XL603	XL603
P8018B	P8018B	XL604	XL615/10/5.5
P8021	P8021	XL605	XL615/10/6.5
P8021B	P8021B	XL606	XL615/13/6.5
P8021G	P8021G	XL608	XL615/9/4
P8021L	P8021L	XL611	XL615/7/3
P8021R	P8021R	XL615/4/2	XL615/4/2
P8034	P8034	XL615/4/3	XL615/4/3
P8034A	P8034A	XL615/7/1.75	XL615/7/1.75

Type to be replaced	EEV replacement	Type to be replaced	EEV replacement
XL615/7/2	XL615/7/2	XQ1020B*	P8001B
XL615/7/3	XL615/7/3	XQ1020G*	P8001G
XL615/7/6	XL615/7/6	XQ1020L*	P8001L
XL615/7/6.5	XL615/7/6.5	XQ1020R*	P8001R
XL615/7-2/1.75TW	XL615/7-2/1.75TW	XQ1030	7262A
XL615/9/4	XL615/9/4	XQ1031	7262A
XL615/9/10	XL615/9/10	XQ1032	7262A
XL615/10/5.5	XL615/10/5.5	XQ1040	P844
XL615/10/6.5	XL615/10/6.5	XQ1042	8541A
XL615/10/12	XL615/10/12	XQ1043	P849
XL615/10/40	XL615/10/40	XQ1044	P849D
XL615/13/6.5	XL615/13/6.5	XQ1050*	8572A
XL615/13/9	XL615/13/9	XQ1052*	8507A
XL615/13/12	XL615/13/12	XQ1053*	P848
XL627	XL627	XQ1070	P8021
XL628	XL628	XQ1070B	P8021B
XL630	XL630	XQ1070G	P8021G
XL631	XL631	XQ1070L	P8021L
XL632	XL632	XQ1070R	P8021R
XL639/4/1.75	XL639/4/1.75	XQ1240	8541A
XL639/4/2.75	XL639/4/2.75	XQ1241	P849
XQ1020*	P8001		

\* Near equivalent

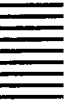

# Storage Tubes

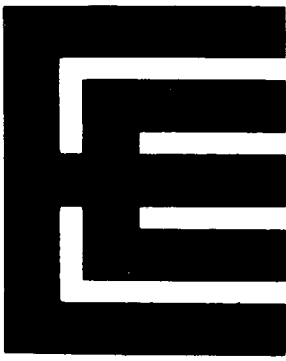

### INTRODUCTION

Although the conventional cathode ray tube can be adapted to a wide variety of visual display applications, it is not as versatile as might be desired and is far from ideal in many cases. The major limitation is the very short time during which a single trace is visible and in many applications this must be overcome by electronic storage circuitry, film photography or long persistence phosphors, all of which have disadvantages of their own.

The mesh type direct view storage tube is able to display an image at very high brightness levels with persistence variable during operation. By comparison with long persistence phosphors or the bistable phosphor storage tube it offers longer life and higher brightness, in addition to the variable persistence.

The current range of EEV storage tubes is effectively divided between radar and instrument tubes; enquiries are invited concerning modified or new types for specific applications. The practice of manufacturing tubes with a range of phosphors is not necessary when using storage tubes; all requirements can be met with the two high efficiency, long life phosphors in current use and the variable persistence of the tubes.

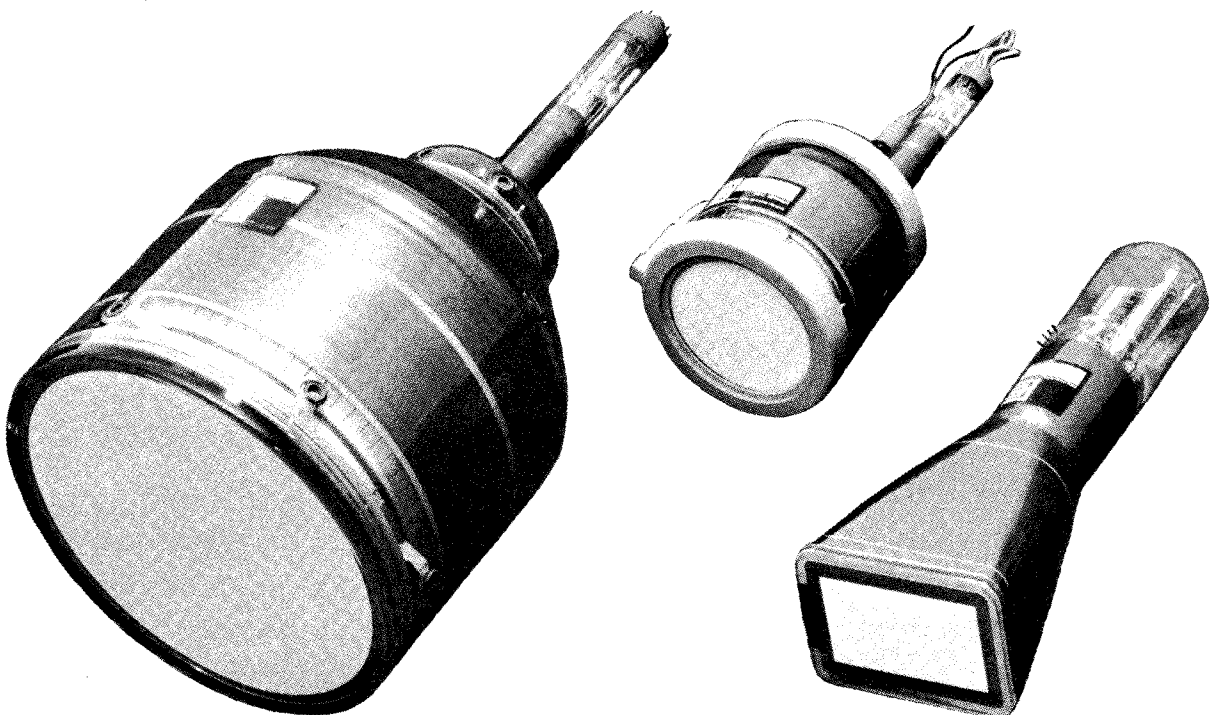

A selection from the EEV range of direct view storage tubes

## **Radar**

Storage tubes developed for radar displays have round faces and may be ruggedized for airborne operation. The screen luminance of up to  $7000\text{cd/m}^2$  (2000ft-lamberts) is high enough for operation without viewing hoods in full daylight, in areas such as airfield control towers, aircraft cockpits and the bridges of ships. The image persistence can be adjusted by the operator to suit different conditions, and the signal-integrating characteristic of the storage tube can give a valuable improvement in overall system performance by separating small echos from random noise.

## **Instrument**

The rectangular tubes developed for use in oscilloscopes have good deflection sensitivity and high writing speed using electrostatic deflection, and split-beam writing guns in some types. Internal faceplate graticules can be provided and the phosphor is P31, which is well suited to photography for permanent records. Oscilloscope service frequently calls for the display of slow-moving spots, and the current EEV series of oscilloscope tubes use a storage dielectric chosen for its ability to withstand this treatment without damage. They can also be operated in a non-storage mode when required, so that the storage oscilloscope can be used for routine waveform display in addition to transient studies.

The storage oscilloscope is especially valuable for the display of transient events, since a signal which may appear only once can be displayed long enough for examination and measurement. If a permanent record is required it can then be photographed. Successive traces can be displayed simultaneously for comparison, or the persistence can be reduced so that a slow trace is erased at the right speed to leave the screen clear for the next sweep. In the storage mode, fast repetitive traces can be integrated until a trace of convenient brightness is produced.

## **Special Applications**

The advantages of storage tubes can be applied to many specialized displays. Sonar, ultrasonic testing and medical research are typical examples. In computer graphic display terminals, the use of a storage tube eliminates both the flickering of the display and the rapid refreshing needed for conventional cathode ray tubes.



## PRINCIPLES OF OPERATION

The essential components of a typical storage tube are shown in Fig. 1. The writing beam is the same as the electron beam of a conventional cathode ray tube, but in addition to exciting the screen phosphor directly, it deposits a charge pattern on the storage surface. Low velocity flood beam electrons continuously approach the entire surface area of the storage mesh but are transmitted only where a charge has been deposited by the writing beam. Flood electrons which are transmitted are then accelerated by the screen voltage, and produce a visible, continuous image corresponding to the trace of the writing beam. The image can be erased in less than a second, leaving the screen clear, or a continuous train of short erase pulses may be used to give variable persistence with repetitive writing.

The description given above is greatly simplified; more comprehensive explanations of the behaviour of the storage mesh and the operation of the tube are given below.

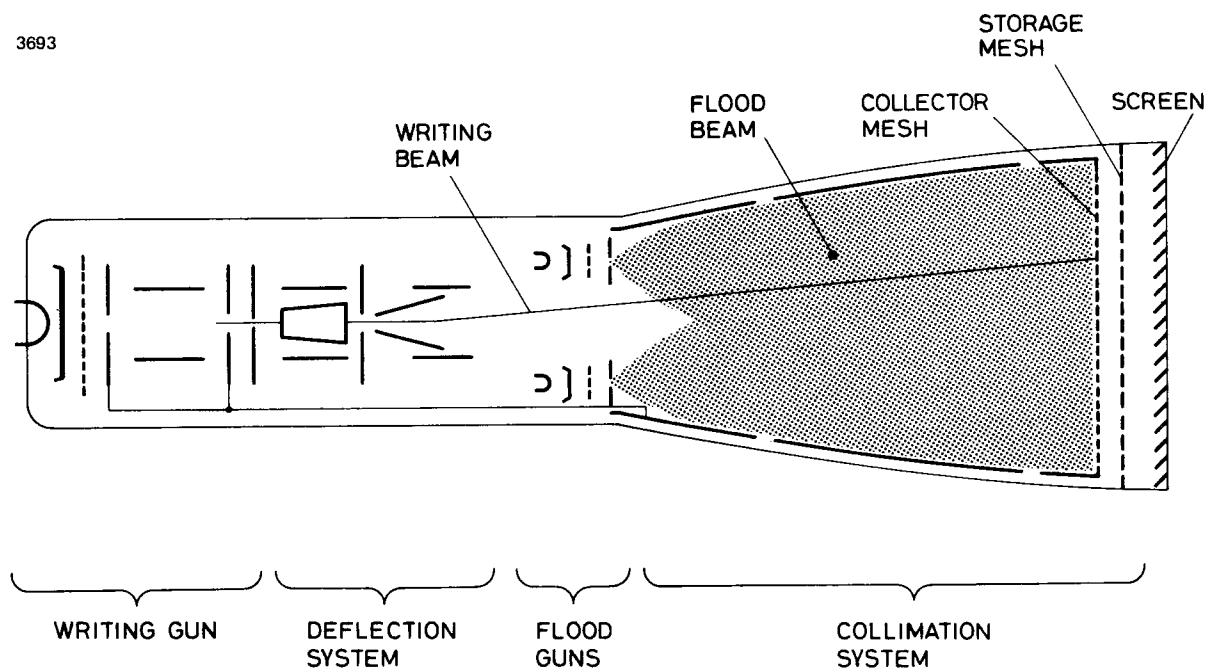

**Fig. 1.** Electrode system of typical direct view storage tube

## The Storage Mesh

Direct view storage tubes manufactured by EEV rely for their operation on the characteristics of the storage mesh, particularly the high leakage resistance and secondary emission characteristics of the storage surface. Fig. 2 shows the arrangement of the storage section of the tube in schematic form. The backing electrode is a fine metal mesh, typically having 250 or 500 lines per inch and an optical transmission of 30 to 60%. On one side of this mesh, facing the electron guns, is a thin layer of a high quality dielectric material. The resistivity of this dielectric is very high, so that adjacent positive and negative charges on the storage surface are effectively isolated.

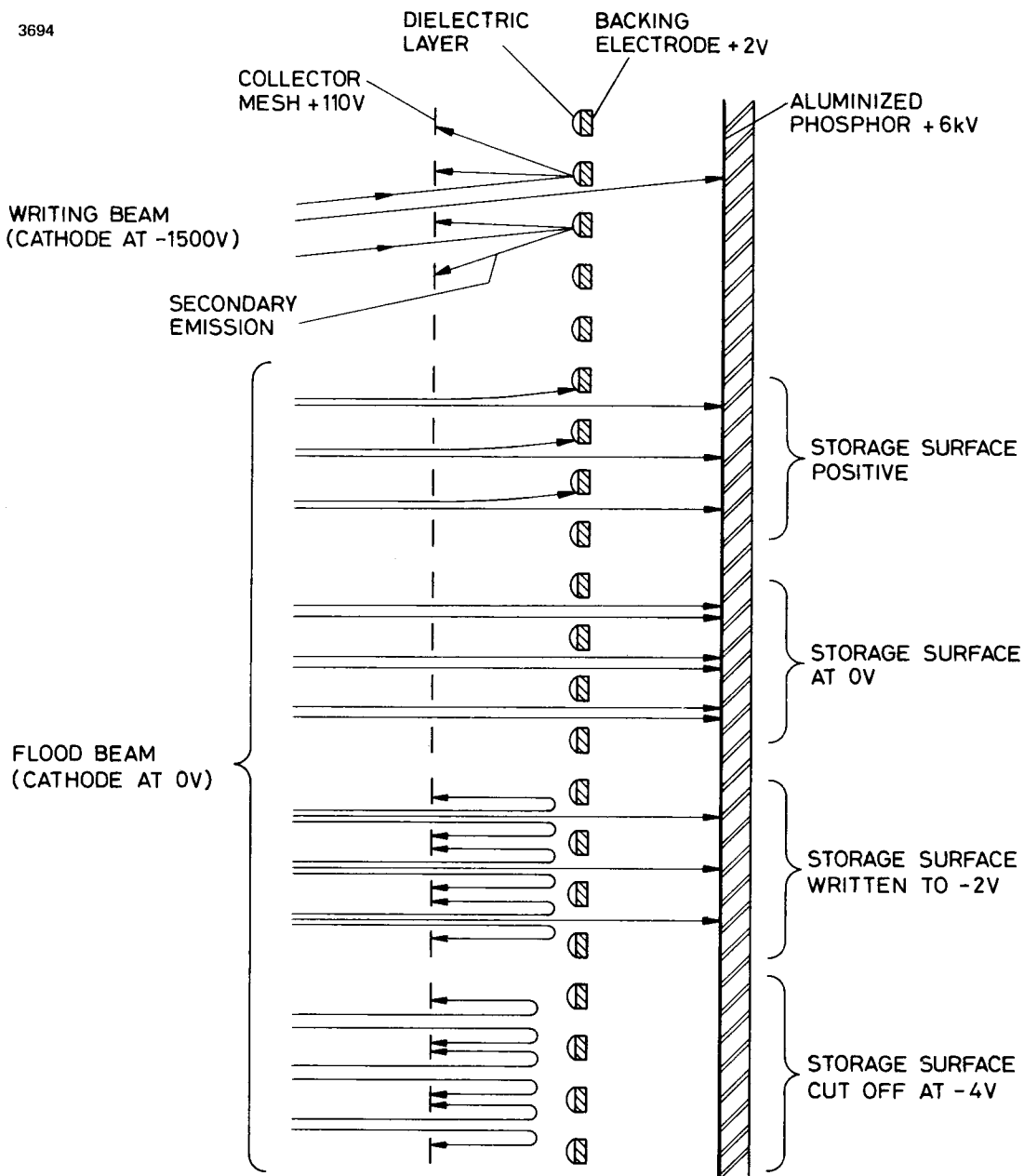

**Fig. 2.** Storage section operation

The storage mesh behaves as a control grid to the flood beam. The maximum brightness of any area on the screen depends on the screen and flood gun voltages but intermediate brightness values result from modulation of the flood beam by local storage surface potentials (see Fig. 3).

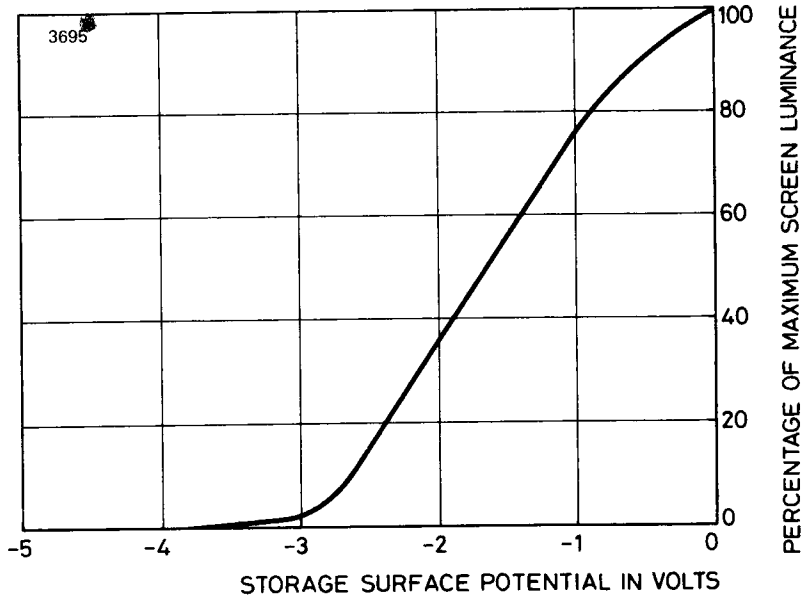

**Fig. 3.** Typical storage surface potential – screen luminance characteristic

Fig. 4 shows the secondary electron emission characteristic of the storage surface; electrons which land with energies between the first and second cross-over potentials result in the emission of secondary electrons in greater numbers than those arriving. The secondary electrons are attracted to the

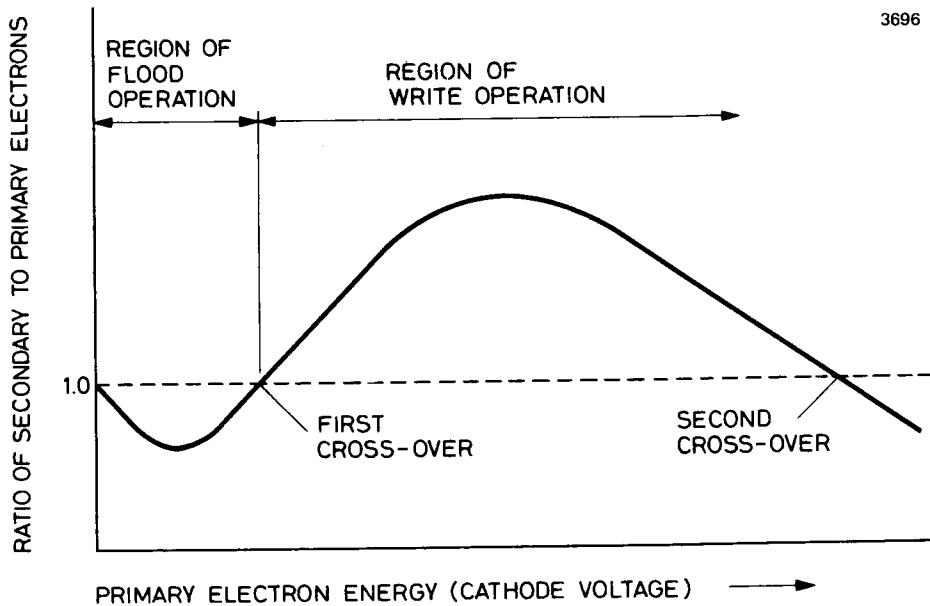

**Fig. 4.** Secondary emission characteristic

collector mesh, leaving a net positive charge on the storage surface. Electrons landing with energies below the first cross-over potential (i.e. the flood beam) generate less secondary electrons and produce a net negative charge.

During operation, the potential on any part of the storage surface is determined by four factors.

**a) Flood beam charging** An area which becomes positive with respect to the flood gun cathode will attract flood beam electrons; provided the initial positive voltage is below the first cross-over potential the flood beam will charge it negatively, back to zero (cathode potential).

**b) Writing beam operation** The cathode of the writing gun is typically 1500V negative, so that an area scanned by the writing beam is bombarded by electrons with an energy above the first cross-over potential and driven positive. The amount of positive charge deposited depends on the current density of the writing beam and the speed with which it scans the storage surface (writing speed). The charge increments from successive low-current scans of the same point are integrated until the surface potential is limited by flood beam charging.

**c) Backing electrode voltage** The storage surface, dielectric layer and backing electrode form a capacitance, so that changes in the backing electrode voltage are capacitively coupled to the whole of the storage surface. The steady-state operating voltage of the backing electrode is typically +2V.

**d) Positive ion charging** Since the storage mesh is negative with respect to its surroundings, it will attract positive ions produced by collision of electrons with residual gas molecules within the tube. Only those ions produced between the collector mesh and the screen can reach the storage surface, the collector mesh repelling ions formed in the gun end of the tube.

This positive ion current is present whenever the electron beams are operating and tends to drive the whole storage surface slowly positive.

When studying the action of the storage mesh, it is important to remember that the ion and electron currents described above are not landing on a conducting electrode, as in most types of electron tube, but on an insulator surface where the local potential depends on the relative magnitudes and energies of the currents landing. The backing electrode, in addition to providing structural support for the dielectric layer, is used to shift the range of storage surface potential by capacitive coupling.

## The Writing Operation

The writing gun generates a high energy, narrow electron beam as in a conventional cathode ray tube. This beam is focused to a spot on the storage mesh and scanned over the surface of the mesh by electrostatic deflection plates (the example shown in Fig. 1 is an oscilloscope tube; other types may have magnetic deflection of the writing beam).

Although the writing spot is small enough for good resolution, it is considerably larger than the apertures in the storage mesh. Where the writing beam strikes the dielectric storage surface, the surface potential is driven in a positive direction by secondary electron emission and that part of the mesh becomes more transparent to the flood beam. The extent of this positive charging is normally limited by the flood beam to flood gun cathode potential and in most applications a single scan of the writing beam is sufficient to drive the mesh to zero (fully bright), or intermediate half tone levels. If a trace is written at very high writing speed, or slowly at a lower level, successive positive charges may be integrated on the storage surface by repeated scans.

The resistivity of the dielectric used is so high that leakage from adjacent negatively charged areas or the backing electrode is not a significant factor in the normal operation of the tube. A written trace can normally be stored, with the tube switched off, for up to a week before being displayed.

## Viewing

Once a trace has been written on the storage mesh, it is continuously displayed on the screen by transmitted flood electrons until erased. The time during which it can be clearly seen, however, is limited by the positive ion current mentioned earlier. This current drives the whole storage surface slowly towards zero, and this results in a gradually increasing background illumination until the original trace is swamped and the whole screen is at saturation brightness. An erasure operation is then necessary before another trace can be written.

The viewing time can be extended if a reduction in brightness is accepted. Since the positive ion current results almost entirely from flood gun operation, pulsing the flood beam increases the viewing time in inverse proportion to the flood beam duty cycle. The viewing time can also be extended, at the cost of a reduction in maximum writing speed, by erasing beyond black.

## Erasure

Erasure of the display may be carried out either in a single operation taking less than one second and known as manual, or single pulse erasure, or over an extended period by pulse train erasure (variable persistence).

**Single Pulse Erasure** To erase the display completely in one operation, a positive pulse of about 4V amplitude and one second duration is applied to the backing electrode. This pulse is capacitively coupled to the storage surface, where it produces an instantaneous 4V increase in potential (see Fig. 5). This enables flood beam electrons to land, charging the entire surface to zero, so that when the backing electrode returns to +2V at the end of the erase pulse the storage surface is driven uniformly to  $-4V$  which cuts off the flood beam. The screen will be at maximum brightness during the erase pulse, unless the screen voltage is simultaneously removed; switching off the screen voltage makes more of the flood beam electrons available to stabilize the storage surface and speeds up the erasing process.

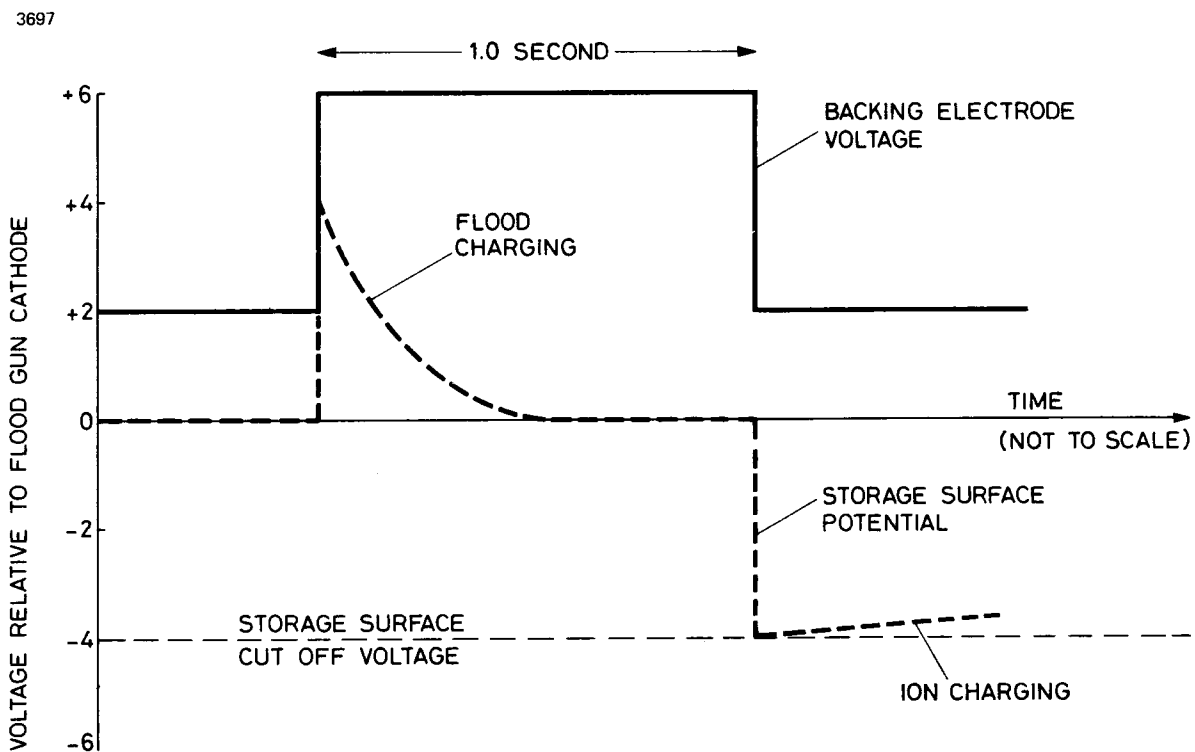

**Fig. 5.** Single pulse erase potentials

The erase time can also be reduced by using a pulse of greater amplitude and controlled duration. In this case the pulse duration determines the storage surface potential after erasure (see Fig. 6).

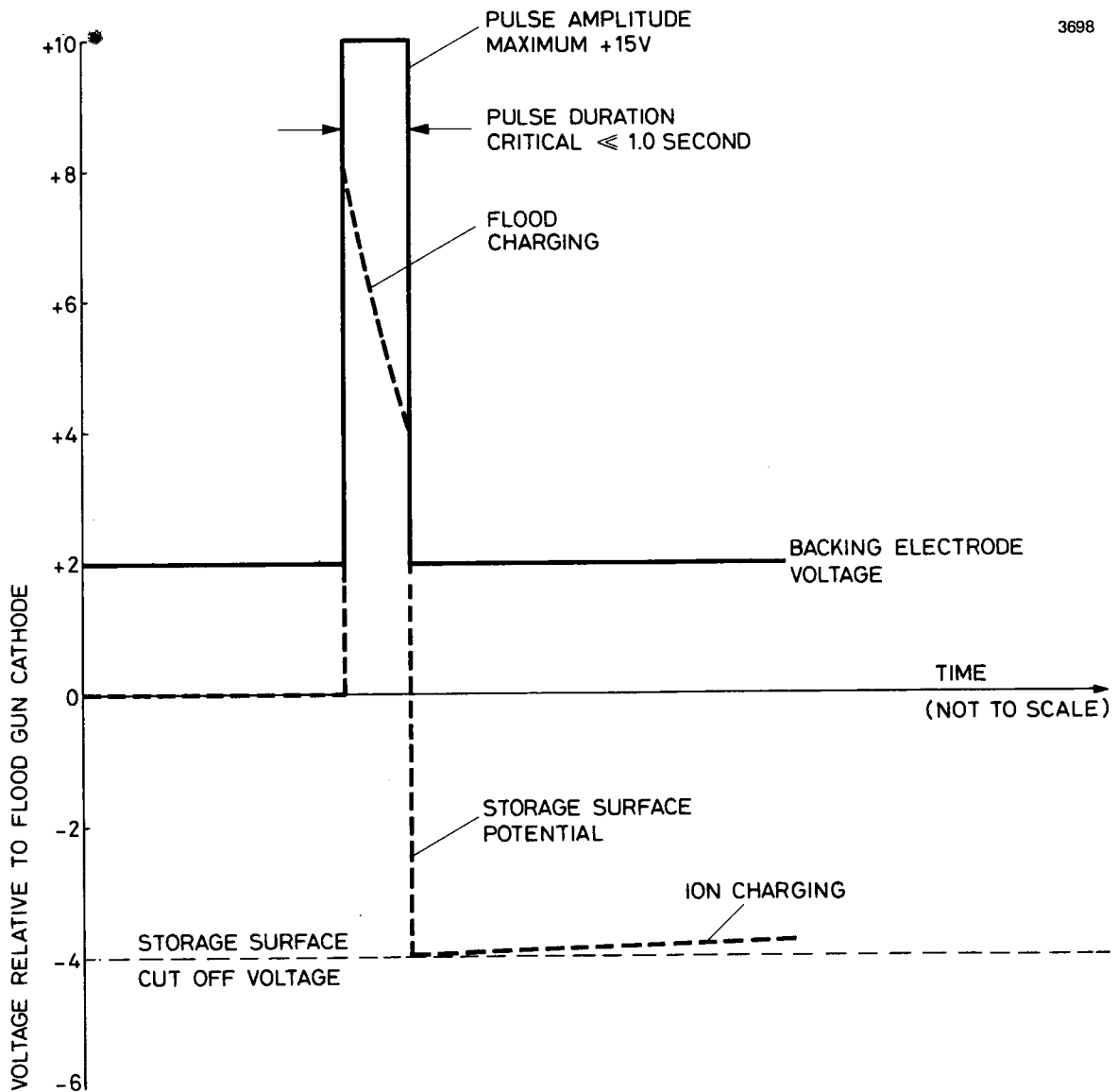

**Fig. 6.** Short-pulse erase potentials

**Pulse Train Erasure** A train of positive pulses above visible flicker frequency applied to the backing electrode has a cumulative erasure effect on the written areas of the storage surface, causing them to be erased in discrete steps. The small amount of ion charging between erase pulses is cancelled out

during the pulse (see Fig. 7). The unwritten areas can be held below cut off if required, by increasing the amplitude of the erase pulse train.

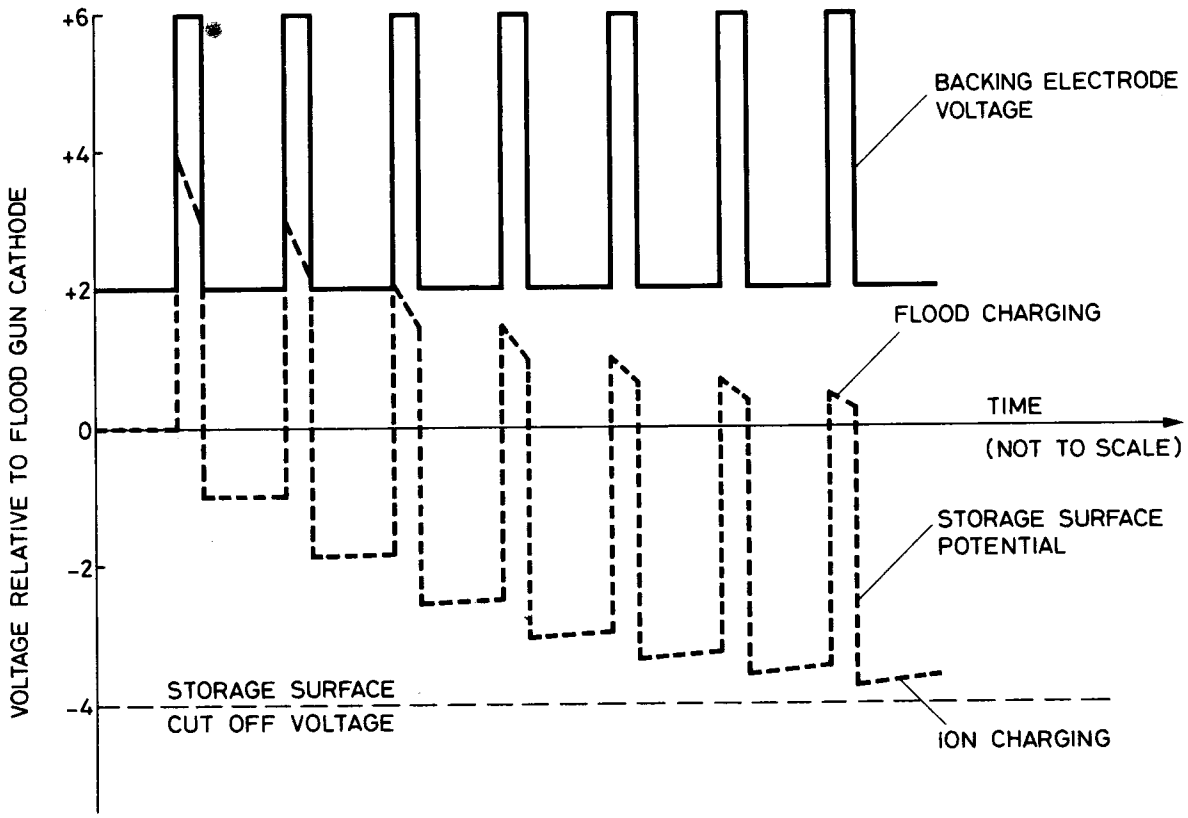

**Fig. 7.** Pulse train erasure potentials

If the screen voltage is maintained, there will be a corresponding train of pulses of light output at maximum brightness being averaged by the eye to give an apparent background illumination; if the screen voltage is removed during the erase pulse the rate of erasure is increased and contrast improved. In either case a pulse repetition rate of 200 to 1000p.p.s. will avoid visible flickering of the display.

The rate of erasure is determined by the duration, amplitude and repetition rate of the erase pulses; control of persistence is normally achieved by varying the pulse duration. Fig. 8 shows a typical set of erase curves with various duty cycles. The pulse amplitude also controls the potential of unwritten areas but must be limited to avoid runaway charging.



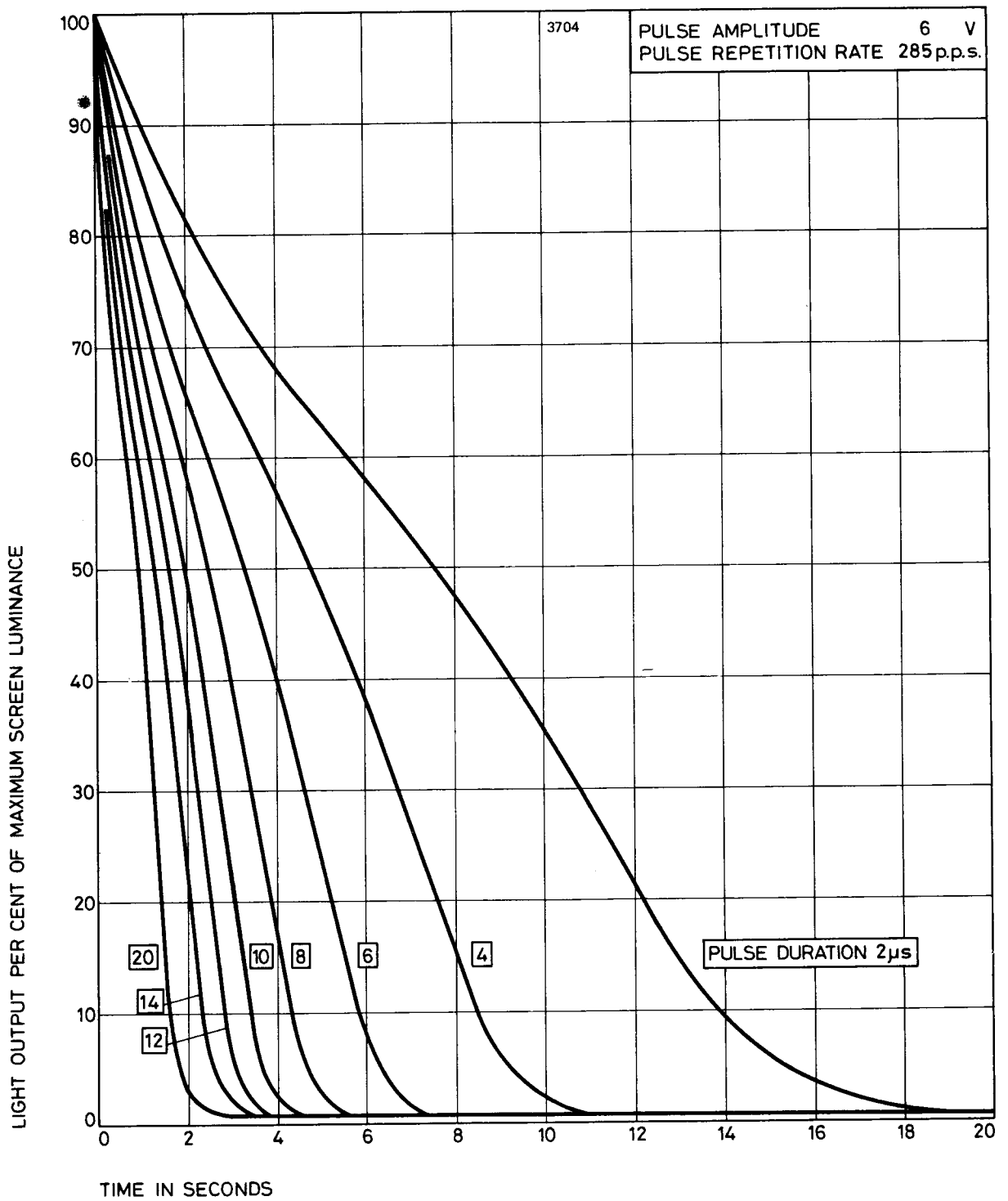

Fig. 8. Typical erase curves at various duty cycles.

## Clearance

In some circumstances, usually as a result of incorrect operation, the normal erase methods may be ineffective and a procedure known as clearance becomes necessary. The conditions which lead to ineffective erasure may be as follows:

- a) An excessively high writing beam intensity can cause electrons to penetrate the storage surface and build up charges within the dielectric layer. The low velocity flood beam electrons cannot neutralize these charges and after normal erasure has been carried out the image may still be visible at certain levels of background illumination.
- b) It is possible for an area of the storage surface to be driven to a positive potential above the first crossover of the secondary emission characteristic, when the flood beam will add to the positive charge instead of cancelling it. Once this happens the affected area will be charged up to collector mesh potential; this creates a high potential difference between the affected area and the surrounding surface, and damage due to spark discharges can occur if the fault is not quickly corrected. This effect is known as runaway charging and produces very bright images on the screen, which are not removed by normal erasure. It can be caused by a transient pulse exceeding 20V applied to the backing electrode, or by writing a stationary spot or line, or writing with the flood beam cut off.
- c) Pulse train erasure to well below cut off may leave unwritten areas at a potential which cannot be normalized by manual erasure.

Clearance is achieved by disconnecting the backing electrode from its normal supply and connecting it to the collector mesh via a protective resistor for a period of 100ms. This short pulse is sufficient to charge the entire storage surface up to the collector potential by the secondary emission process; the collector mesh attracts the secondary electrons until the storage surface reaches collector mesh potential but prevents any further positive excursion. When the backing electrode is returned to +2V the storage surface follows and is then returned to zero by the flood beam. Normal manual erasure then prepares the tube for operation. For some types of tube it is necessary to remove the screen voltage during the clearance operation. The clearance procedure may be carried out automatically prior to each erasure if required.

## DEFINITIONS OF TERMS

**Collimation** The process by which the flood beam is made to approach the storage mesh at right angles to the surface and with uniform current density over the viewing area.

**Erasure** Removal from the storage mesh of a charge pattern, leaving the entire storage surface at the same potential (normally cut off), ready for further writing.

**Half-tones** Display brightness levels, each related to a different input level and visually distinguishable from each other.

**Runaway Charging** When a part of the storage surface is driven excessively positive, so that flood beam electrons land at a potential above the first cross-over and drive the surface still more positive. This produces a very bright image which is not removed by normal erasure.

**Saturation luminance** The screen luminance obtained with the storage surface stabilized at flood gun cathode potential.

**Viewing time (Storage time)** The time during which the tube presents a visible image, corresponding to the stored information. In EEV data sheets, viewing time is defined as the time taken for an area of specified size anywhere on the screen to reach 10% of saturation following erasure to just black.

**Writing speed** The linear speed across the storage surface of the writing beam.

## OPERATING NOTES

### Screen Brightness

In a storage tube the image on the screen results from continuous excitation of the phosphor by a steady stream of flood electrons, unlike other types of display tube which use a high intensity scanning spot and rely on afterglow in the phosphor and persistence of vision to give an apparently continuous image. This enables the storage tube to give a very high screen luminance and simultaneously a longer life, since the peak power dissipated in the phosphor is far below that necessary in a scanning display. The maximum, or saturated, luminance of the screen is determined by the screen and flood gun voltages whilst modulations of brightness below saturation are controlled by the

charge pattern on the storage mesh. Fig. 9 shows a typical screen voltage-luminance characteristic. The saturated luminance may be adjusted to suit ambient lighting conditions by variation of the screen voltage or flood beam duty cycle.

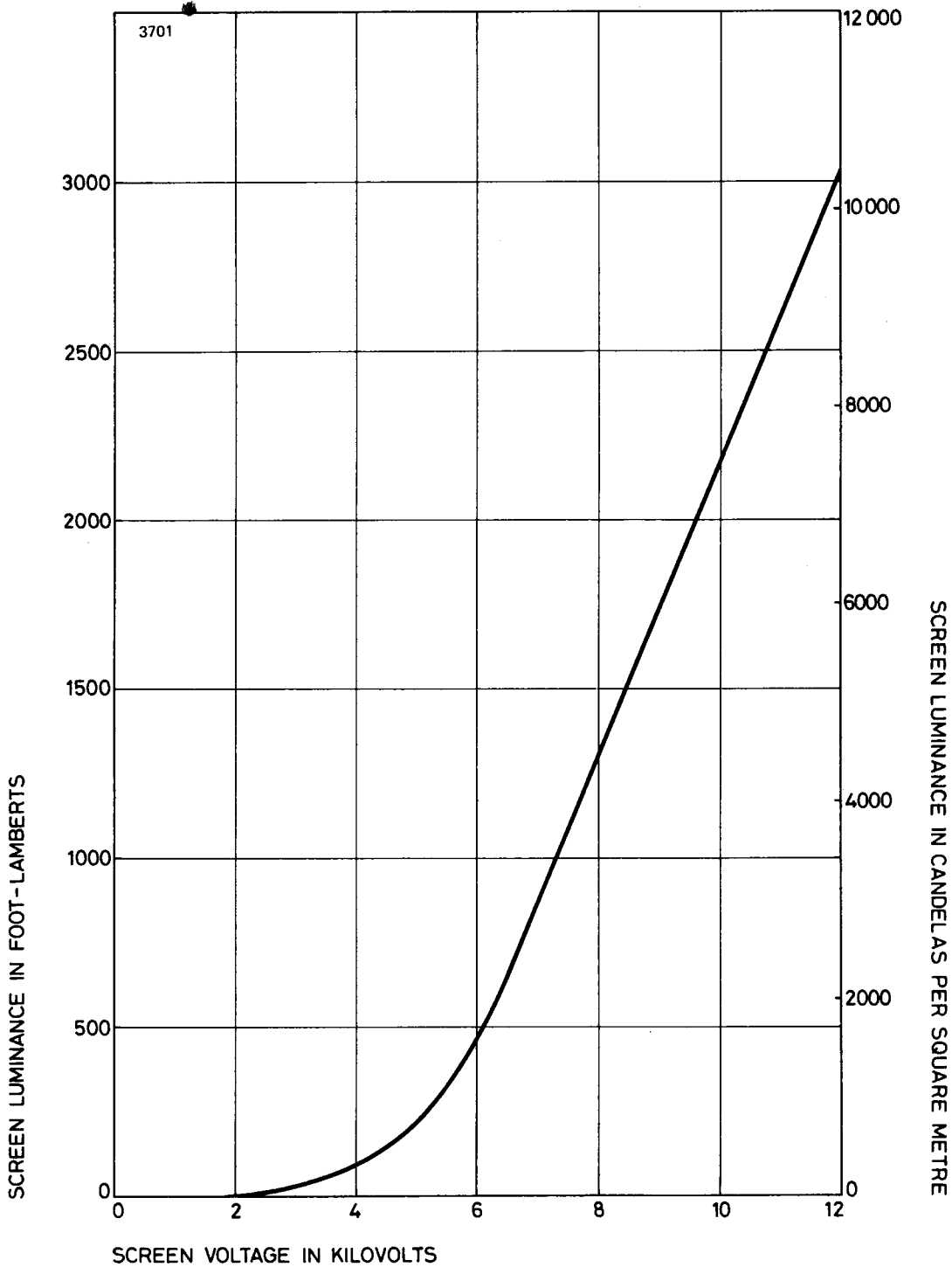

**Fig. 9.** Typical radar tube screen luminance – screen voltage characteristic

## Phosphor Characteristics

The rectangular tubes developed for use in oscilloscopes have a P31 phosphor, which is well suited to photography for permanent records (see Fig. 10). The radar tubes have round faces with a P20 phosphor (see Fig. 11); this can give a picture bright enough for operation in full daylight without viewing hoods, in areas such as airfield control towers, aircraft cockpits and ships' bridges. These phosphors are of medium short persistence, but the variable persistence characteristic of the storage section allows a range of viewing times far exceeding the capabilities of long persistence phosphors in conventional tubes.

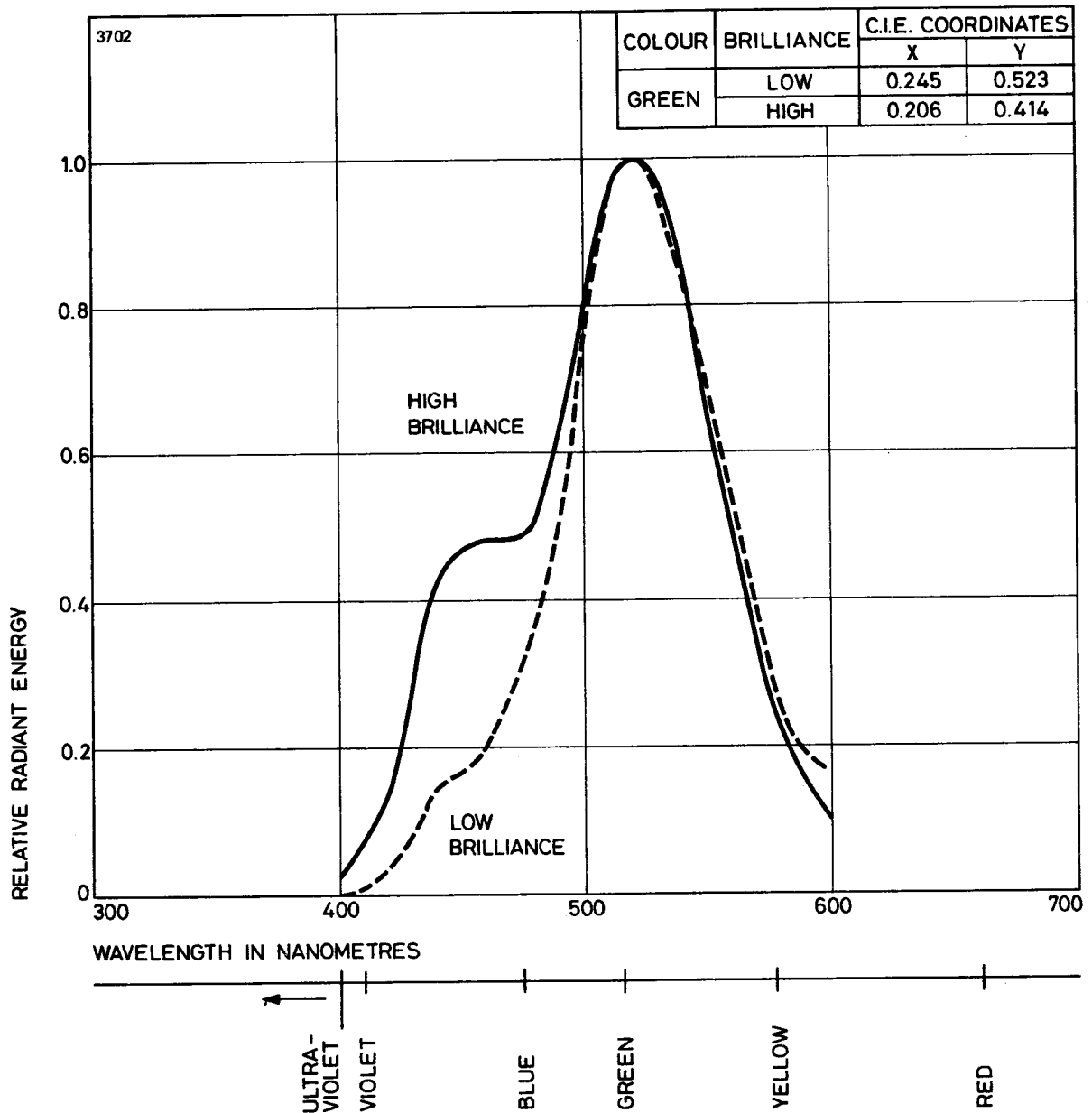

**Fig. 10.** Typical P31 spectral characteristic

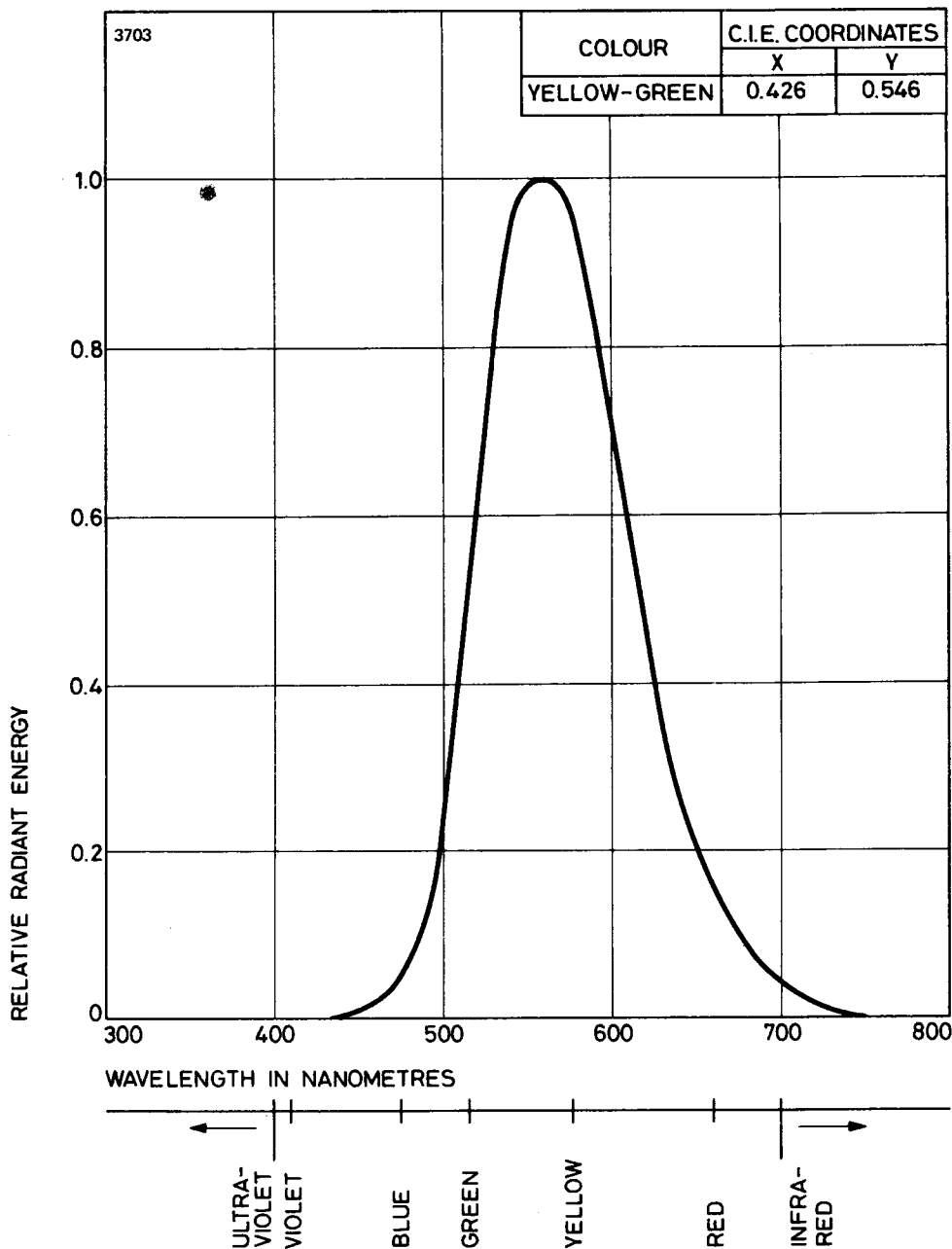

Fig. 11. Typical P20 spectral characteristic

### Writing Speed

The maximum writing speed for a single trace to be visible varies with the writing beam current and the potential to which the storage surface has been erased. A typical value for a current oscilloscope tube is  $0.2\text{cm}/\mu\text{s}$  with the screen erased to just black. This may be increased to  $1.0\text{cm}/\mu\text{s}$  approximately by not erasing to cut off, in which case the trace will appear initially

against a faint background and the viewing time is correspondingly reduced. There is a wide range of possible compromise between maximum writing speed and viewing time.

A suitable method of achieving this is to fix the erase pulse level with respect to flood gun cathode potential, and vary the backing electrode d.c. voltage. This method has the advantage that, if a trace written at high speed is found to be of low brightness, the backing electrode voltage can be increased as necessary.

### Erase Pulse Shape

Application of a rectangular pulse train results in the erasure of all parts of the charge pattern at a similar rate, so that bright areas remain visible for longer than half tones. A more uniform persistence can be achieved by using sawtooth pulses, which allow the flood beam to land on the brightest (more positive) areas for a greater proportion of the pulse duration than on the darker tone areas (see Fig. 12). A similar effect can be achieved by using two pulse levels, for example one pulse in ten at 10V and the remainder at 6V.

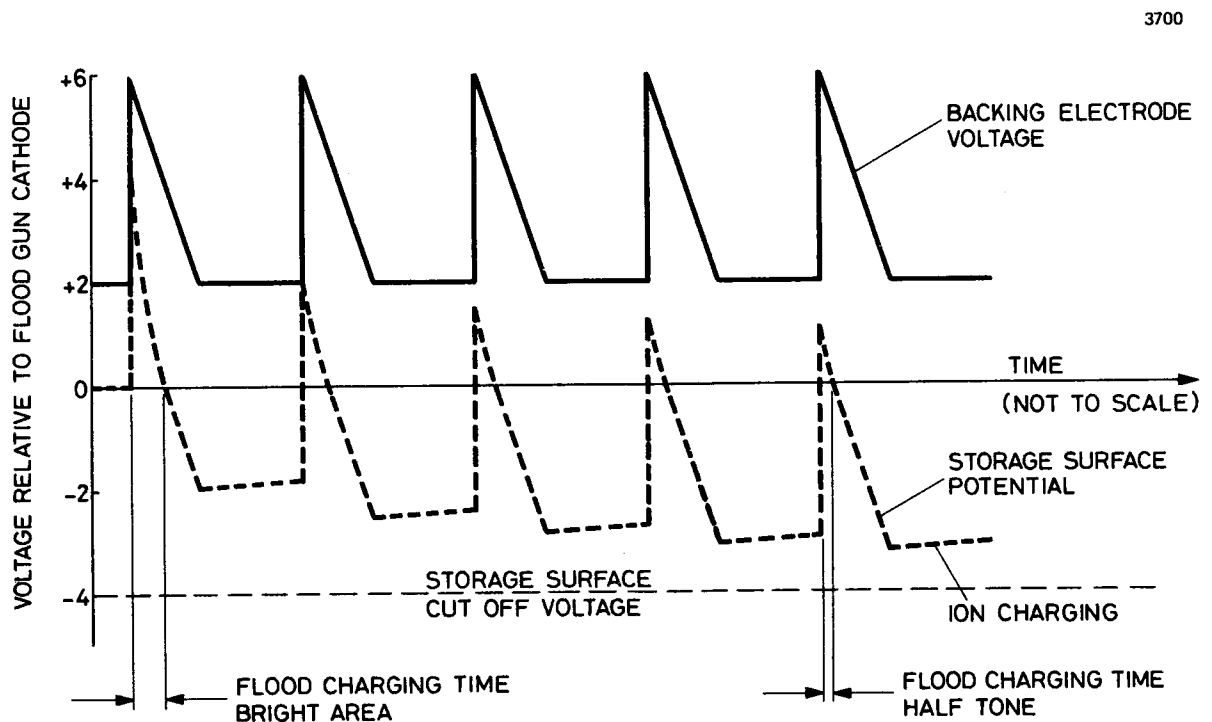

**Fig. 12.** Sawtooth erase pulse potentials

## **Extended Viewing Time**

The basic viewing time for a single trace is typically 2 minutes, but this can be extended up to 1 hour by suitable operating modes. As described briefly under 'Principles of Operation – Viewing', the flood beam can be interrupted at a frequency high enough to prevent flicker, giving extended viewing time at reduced brightness. A pulse frequency in the range 200 to 1000p.p.s. should be used. The maximum luminance of direct view storage tubes is so high that in many applications the viewing time can be extended by a factor of ten or more while retaining adequate brightness.

The deflection sensitivity of the writing beam changes in the absence of the flood beam. Either the writing beam modulation circuits should include an interlock to cut off the writing beam when this mode of extended viewing is in use, or deflection correction will be required.

If pulse operation of the flood gun is used with pulse train erasure the erase pulses, to be effective, must occur when the flood beam is on.

The viewing time of a single trace can also be extended if the tube is previously erased to beyond cut-off potential by increasing the amplitude of the erase pulse. This increases the time taken for positive ion charging to produce a visible background, but also reduces the maximum writing speed for the same reason.

Long term retention of a trace, without viewing, for up to one week may be achieved simply by switching off the electron guns as soon as the trace has been written. When the flood gun is switched on again the trace will appear and can be displayed for the normal viewing time.

## **Noise Suppression**

The signal integrating characteristic of the storage tube can be used to improve the signal to noise ratio of repetitive signals such as radar scans. By increasing the amplitude of the erase pulse train above that needed to reach storage mesh cut off, the potential of the storage surface can be driven to a level such that a single scan of the writing beam will not produce a visible image. Fixed echos in the signal will be written at each scan and integrated until visible, but noise is randomly distributed over the storage surface and therefore not displayed.



Increasing the erase pulse amplitude will reduce the image persistence unless the duty cycle is reduced appropriately; the display may be optimized by successive adjustment of pulse amplitude and duty cycle.

To avoid runaway charging, the range of adjustment of the erase pulse amplitude must not permit the use of pulses exceeding the maximum backing electrode voltage given in the tube data.

### **Non-Storage Operation**

EEV instrument tubes, because of their robust storage dielectric, can be used in a non-storage (normal) mode of operation. The backing electrode is switched to  $-50V$ , preventing passage of the flood beam to the screen. The tube then behaves as a conventional cathode ray tube with front mesh p.d.a.

### **Commissioning a Tube after Shelf Storage**

If a tube is installed after a long period of shelf storage, the viewing time may be temporarily reduced. This is caused by a deterioration of the vacuum within the tube and does not necessarily indicate any fault; normal operation of the tube should quickly restore its full performance. The duration of the 'conditioning' period necessary may be an hour or more, depending on tube type and shelf storage time. If a tube cannot be made operational by conditioning, it should be returned to EEV with the warranty form completed. During the conditioning period, magnified images of minute particles may be seen moving across the screen; these are not important and will quickly disappear.

### **Handling Precautions**

Whenever storage tubes are handled for any reason they should be kept screen upwards if possible, or horizontal. In the screen downwards position, any minute loose particles within the tube might fall onto the meshes and cause spots in the display. Care must also be taken not to damage glass to metal seals or scratch the glass, particularly the faceplate.

Simple safety precautions are also necessary for the person handling any large, evacuated glass envelope. The minimum recommended protection consists of industrial safety goggles.

## **POWER SUPPLIES**

Power supply requirements naturally vary from type to type and data sheets should be consulted for specific voltage and current values, but there are some common features. Detailed information for equipment design can be obtained from EEV.

### **Heater Supplies**

The writing and flood guns require separate heater supplies, principally because the writing gun cathode is at a high negative voltage. The writing gun heater transformer must have an adequate voltage insulation rating. It is also advisable to operate the flood gun heater from a d.c. supply, to prevent deflection of the writing beam by an alternating magnetic field. When switching tubes on or off, the writing gun should be biased so that heavy writing which might damage the mesh or screen cannot occur.

### **Flood Gun**

The voltages of the flood beam collimating electrodes, including the collector mesh, should be stabilized to maintain the uniformity of brightness and persistence achieved on setting up the tube. Electrode potentials are normally specified with respect to flood gun cathode, but the mean potential of the writing gun deflection system is usually tied to one of the flood gun electrodes, so that if direct-coupled deflection amplifiers are used it will be necessary to shift the flood gun voltages with respect to earth. In either case the potential of the backing electrode relative to flood gun cathode is critical and must be closely controlled at all times. Most of the flood gun electrode voltages are normally adjustable for optimum collimation.

For some tube types, generally those developed for radar rather than oscilloscope service, the flood beam must be operating before the writing gun voltages are applied. Failure to observe this precaution can lead to runaway charging.

### **Writing Gun**

The cathode supply should be free from ripple, to prevent modulation of the writing beam; stabilization of this voltage is desirable to prevent changes in deflection sensitivity. For tubes other than instrument types with robust storage dielectric, an interlock should cut off the writing beam in the event of scan failure.



## **Screen**

A normal e.h.t. supply is required for the screen, variable if brightness control is required. High voltage pulse control will be necessary if the screen voltage is to be pulsed for improved contrast during pulse train erasure. The screen supply impedance should lie within the range given in the individual data sheets; this provides sufficient current limiting in the event of a flashover and prevents excessive changes in screen voltage during erasure.

## **Other Supplies**

According to the application, one or more erase pulse supplies will be necessary, and should be designed so that the pulse amplitude cannot exceed the maximum value given in the tube data sheet. If pulse train erasure is used then controls will be required for pulse duration and possibly pulse amplitude and repetition rate.

For rectangular oscilloscope tubes, an alignment coil must be fitted around the envelope and this will require a variable, low voltage d.c. supply.

## **ENVIRONMENTAL REQUIREMENTS**

### **Mechanical**

Storage tubes built in glass envelopes must be protected from shock and mechanical impact. They have complex internal structures which may be damaged by excessive vibration. The mounting and shelf storage arrangements must provide adequate protection at all times. Sockets in equipment must not be used to support the tube and must be free to move with flexible leads.

### **Magnetic**

The electrons in the flood beam travel at relatively low velocities and are easily deflected by external magnetic fields, resulting in a non-uniform display. A magnetic shield is necessary for the whole of the viewing section and it is advisable to shield the writing gun also. Details of suitable shields for individual tubes are available from EEV.

If parts of the tube should become magnetized this will have a similar effect, visible as a non-uniform background which may be irregular or eccentric in outline. In such cases the tube must be demagnetized by passing it slowly through a coil carrying a.c. current. Further details of suitable coils and procedures can be supplied on request.

## **Pressure**

The tube envelope is able to withstand a wide range of pressures, but if operation at high altitudes is required then special precautions may be necessary to prevent voltage breakdown at the screen connection.

## **Temperature**

Extremes of temperature should be avoided during operation and shelf storage; a range of 0 to +35°C is acceptable for all types. Severe thermal shocks which could cause cracking of the envelope or seals must be avoided. Storage tubes do not dissipate large amounts of power and forced cooling is not normally required. Some provision should be made for natural convection currents, particularly in the region of the flood gun cathode of larger tubes.

## **Shelf Storage Conditions**

Tubes should preferably be stored in their original packing, either horizontally or screen upwards. The temperature should be in the range 0 to +35°C and the tube must be shielded from strong sunlight.

Inflammable materials, acids etc., which may have harmful effects on the tubes, must not be located in the vicinity. It is particularly important that storage tubes are not kept near strong magnetic fields, for example packaged magnetrons.

When tubes are transported they should be kept screen upwards if possible, or horizontal, but never with the screen downwards, or minute loose particles may fall onto the mesh and cause spots on the display.

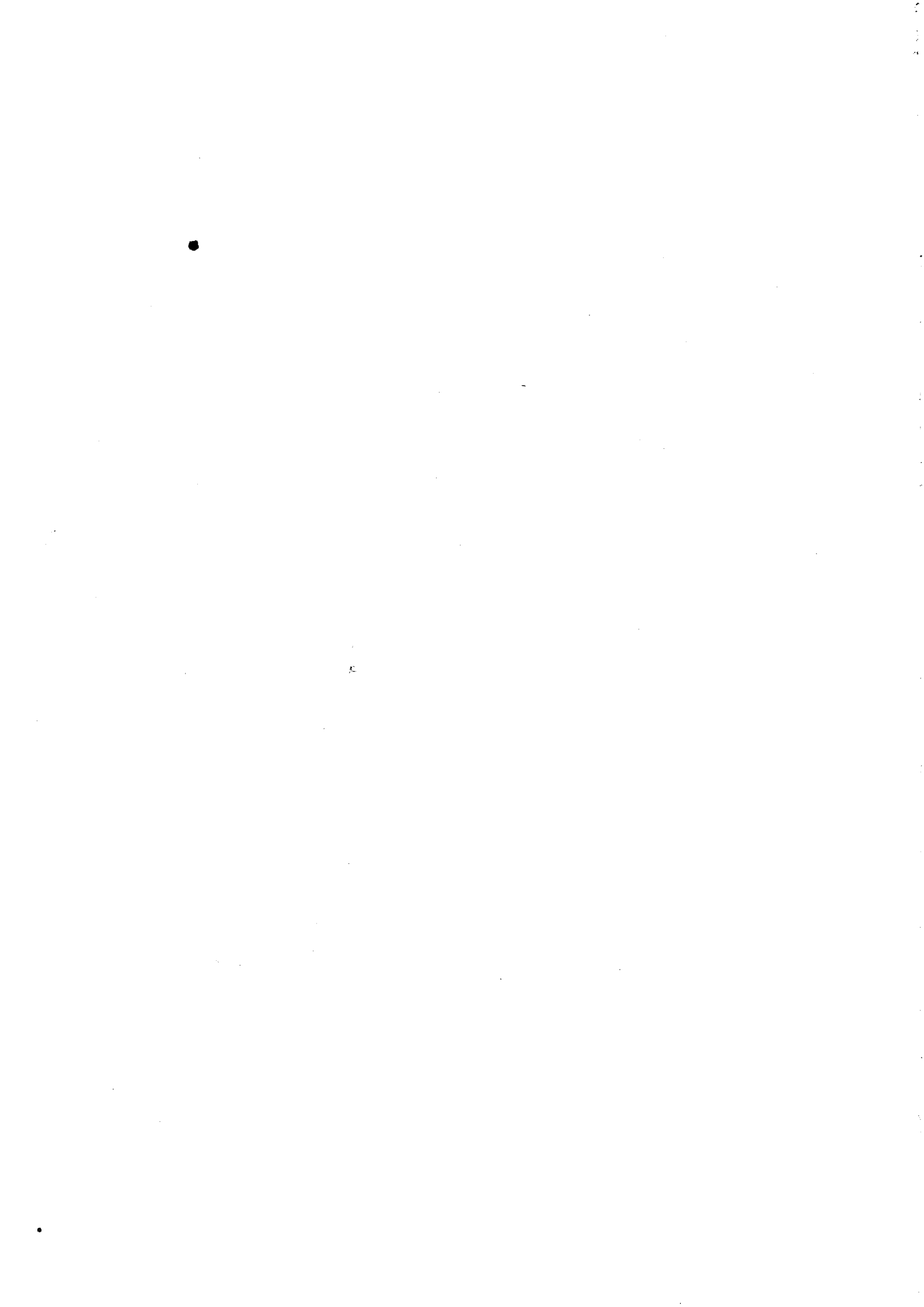



# E702A

# E702E

## DIRECT VIEW STORAGE TUBES

---

### Service Type CV5877 (E702A)

The data should be read in conjunction with the Storage Tube Preamble.

### INTRODUCTION

The E702A and E702E are direct view storage tubes with a useful viewing screen diameter of 4 inches (102mm). They are designed to provide very bright displays of information ranging from single transients and recurrent waveforms to half-tone pictures. The writing gun beam is electrostatically deflected, and high stored writing speeds, 1.0 inch per microsecond, can be achieved.

The two types are of the same construction but the E702E is selected for improved uniformity of erasure.

The tubes have two electron guns, one for writing the signal on to the storage surface and the other, the flood gun, for displaying written information on the viewing screen. The writing gun is similar to that in a conventional cathode ray tube, except that it need only be operated for a single trace. In writing, a charge pattern is deposited on the storage surface, which consists of an insulator coating on a metal mesh (the backing electrode). Low velocity electrons from the flood gun approach the storage mesh normally and at constant current density over the useful area. They penetrate the mesh in those areas where a charge pattern has been written, the number doing so being determined by the amount of charge deposited, and are then accelerated to the viewing screen where they produce an image.

Since the flood gun is normally continuously operative, the image on the viewing screen persists without deterioration for one to two minutes, and is visible for periods up to ten minutes. The charge pattern written on the storage surface can be retained for extended periods by switching off the flood beam until viewing is required, provided that no writing takes place while the flood gun is inoperative. The image can be completely erased in a fraction of a second by applying a small positive pulse to the backing electrode; controlled persistence can be obtained by varying the duration of shorter repetitive pulses.

## GENERAL

### Electrical and General

	Writing Gun	Flood Gun	
Cathodes, indirectly heated, oxide coated . . . . .	one	one	
Heater voltage . . . . .	6.3	6.3	V
Heater current . . . . .	0.6	0.6	A
Cathode heating time (minimum) . . . . .	see note 1	45	s
Inter-electrode capacitances:			
cathode to all other electrodes . . . . .	4.0	—	pF
grid 1 to all other electrodes . . . . .	7.0	24	pF
X1 plate to all other electrodes . . . . .	11.5	—	pF
X2 plate to all other electrodes . . . . .	11.5	—	pF
Y1 plate to all other electrodes . . . . .	6.5	—	pF
Y2 plate to all other electrodes . . . . .	9.5	—	pF
X1 to X2 plates* . . . . .	2.0	—	pF
Y1 to Y2 plates* . . . . .	2.0	—	pF
writing gun grid 1 to writing gun cathode* . . . . .	1.5	—	pF
backing electrode to all other electrodes . . . . .	—	74	pF
screen to all other electrodes . . . . .	—	32	pF
Focus method . . . . .	electrostatic	electrostatic	
Deflection method . . . . .	electrostatic	none	
Phosphor . . . . .	—	aluminised P20	
Fluorescent colour (see spectral characteristic) . . . . .		yellow-green	

### Mechanical

Overall length . . . . .	15.500 inches (393.7mm) max
Overall diameter (excluding flexible lead) . . . . .	5.437 inches (138.1mm) max
Bulb diameter . . . . .	5.312 inches (134.9mm) max
Useful viewing screen diameter . . . . .	4.000 inches (101.6mm) min
Net weight . . . . .	2½ pounds (1.15kg) approx
Mounting position . . . . .	any
Base . . . . .	31-pin small button thirty-five (JEDEC no. E31-36)
Bulb cavity caps (six) . . . . .	B.S.448-CT8 (JEDEC no. J1-21)
Viewing screen connection . . . . .	flexible lead

\* With all other electrodes earthed



## MAXIMUM AND MINIMUM RATINGS (Absolute values)

No individual rating should be exceeded

All voltages are with respect to the flood gun cathode unless otherwise stated

### Writing Gun

	Min	Max	
Heater voltage . . . . .	6.0	6.6	V
Grid 4 voltage . . . . .			see note 2
Grid 3 voltage (negative value) . . . . .	—	2500	V
Grid 2 voltage . . . . .	—	200	V
Grid 1 voltage:			
negative bias* . . . . .	0	200	V
positive peak * . . . . .	—	2.0	V
Cathode voltage (negative value) . . . . .	—	2800	V
Peak heater to cathode voltage:			
heater positive with respect to cathode . . . . .	—	125	V
heater negative with respect to cathode . . . . .	—	125	V
Cathode current (peak) . . . . .	—	1.0	mA
Grid to cathode circuit impedance . . . . .	—	1.0	MΩ
Deflection plate circuit impedance . . . . .	—	0.1	MΩ

### Flood Gun

	Min	Max	
Heater voltage . . . . .	6.0	6.6	V
Viewing screen voltage . . . . .	—	12	kV
Backing electrode voltage (peak) (see note 3) . . . . .	—	20	V
Grid 4 (collector mesh) voltage . . . . .	—	300	V
Grid 3 voltage . . . . .	—	300	V
Grid 2 voltage (see note 2) . . . . .	—	200	V
Grid 1 voltage:			
negative bias (never positive) . . . . .	2.0	150	V
Peak heater to cathode voltage:			
heater positive with respect to cathode . . . . .	—	125	V
heater negative with respect to cathode . . . . .	—	125	V
Cathode current (mean) . . . . .	—	2.0	mA
Viewing screen dissipation . . . . .	—	6.0	W
Backing electrode supply impedance . . . . .	—	5000	Ω
Grid to cathode circuit impedance . . . . .	—	0.5	MΩ
Viewing screen supply impedance (see note 4) . . . . .	1.0	5.0	MΩ

\* With respect to Writing Gun Cathode.

## TYPICAL OPERATION

All voltages are with respect to the flood gun cathode unless otherwise stated

### WRITING GUN

#### Operational Conditions

Grid 4 voltage . . . . .		see note 2
Grid 3 voltage (usual range for focus)* . . . . .	550 to 850	V
Grid 2 voltage . . . . .	0	V
Grid 1 voltage (range for writing beam cut-off)* . . . . .	-60 to -140	V
Cathode voltage . . . . .	-2300	V

#### Typical Performance

Writing beam current (50V modulation) (see note 5) . . . . .	41	$\mu$ A
Cathode current (50V modulation) . . . . .	550	$\mu$ A
Deflection factor, X plates . . . . .	110	V/inch
Deflection factor, Y plates . . . . .	105	V/inch
Stored writing speed (see note 5) . . . . .	1	inch/ $\mu$ s

### FLOOD GUN

#### Operational Conditions

Screen voltage . . . . .	7.0	kV
Backing electrode d.c. voltage . . . . .	2.0	V
Erase pulse amplitude for screen cut-off (see notes 6 and 7) . . . . .	3.3	V
Grid 4 (collector mesh) voltage . . . . .	210	V
Grid 3 voltage (see note 8) . . . . .	85	V
Grid 2 voltage . . . . .	105	V
Grid 1 voltage (see note 8) . . . . .	-15	V
Grid 1 voltage (cut-off) . . . . .	-100	V
Cathode voltage . . . . .	0	V

#### Typical Performance

Screen current for full brightness . . . . .	0.3	mA
Cathode current . . . . .	1.0	mA
Screen luminance (see note 9) . . . . .	900	ft-lamberts
	3087	cd/m <sup>2</sup>
Viewing time (see note 10) . . . . .	60	s min
Resolution (see note 11) . . . . .	100	lines/inch
Erase uniformity (see note 12):		
E702A . . . . .	0.7	max
E702E . . . . .	0.4	max

\* With respect to Writing Gun Cathode.

## NOTES

1. To prevent the occurrence of transients when switching on or off, the writing gun heater voltage may be applied simultaneously with, or after, the other writing gun voltages, and switched off before these voltages are removed, provided the writing gun is biased to beyond cut-off.
2. Grid 4 (writing gun) is internally connected to grid 2 (flood gun).
3. Except when the faults mentioned under Pulse Erasure, part (c), of the General Instructions on page 7 are being corrected.
4. The viewing screen supply impedance should be less than  $5M\Omega$  to prevent excessive changes in screen voltage during erasure.
5. Writing is a charge deposition process and the current required for a given brightness level is proportional to the writing speed and inversely proportional to the number of times the information is written in one place.
6. With manual erasure (approximately 1 second) and the screen voltage simultaneously removed.
7. Maximum screen brightness is obtained when the storage mesh surface has stabilized at approximately zero potential, i.e. flood gun cathode potential. The application of a positive manual erase pulse to the backing electrode produces a corresponding positive increase in the storage mesh surface potential. This surface potential is reduced to near flood gun cathode potential by flood beam electrons. When the erase pulse is removed the surface acquires a negative potential relative to that at full brightness and equal in value to the erase pulse amplitude.
8. To achieve collimation of the flood beam, the voltages applied to the flood gun grids 2, 3 and 4 should be preset to the fixed values given on page 4. The voltage of grid 1 should then be adjusted to just give maximum uniform display over the screen. The voltage of grid 3 should then be adjusted to give the most uniform erasure when a train of erasing pulses is applied to the backing electrode. Slight readjustment of grid 1 voltage may assist in obtaining the most uniform erasure.
9. The meter used for measuring screen luminance has been corrected to the frequency response of the human eye.
10. Time for background to rise from cut-off to 10% of maximum brightness. An increase in viewing time can be obtained by switching off the

flood beam by pulses at a frequency sufficiently high to prevent flicker, the apparent brightness of the display being proportionately reduced.

11. Using a test card C pattern produced from a monoscope generator and written for one frame only at a level to display all five half-tones.
12. With the screen at uniform full brightness a train of erase pulses is applied such that all parts of the screen are just black in 10 seconds ( $t_2$ ). The screen is then returned to full brightness and with the same train of erase pulses applied, the time ( $t_1$ ) for the first part of the screen larger than a circle of 0.500 inch (12.7mm) diameter to become black is noted. From this the erase uniformity is calculated as follows:—

$$\text{Erase uniformity} = \frac{t_2 - t_1}{t_2}$$

It should be noted that with perfect erase uniformity the value obtained would be zero; lower grades of uniformity give values approaching unity.

## GENERAL INSTRUCTIONS

### Handling

The tube should be transported screen upwards to prevent particles falling on the storage elements. It should be handled with care to avoid damage to the metal seals and the encapsulated screen lead.

### Magnetic Shielding

Because of the low voltage of the flood gun beam, it is essential to shield the whole of the viewing section from magnetic fields; shielding of the writing gun is also advisable. Details of suitable Mumetal shields are available from English Electric Valve Company Ltd.

### Demagnetization

The tube may become magnetized during transportation and this will cause non-uniform illumination under full brightness conditions. In this event, a degaussing coil should be drawn slowly over the tube taking one minute for the operation. Such a coil may be made up of 900 turns of no. 16 s.w.g. enamelled wire wound on a 6½-inch diameter former 2 inches long. The coil supply voltage should be 115 volts 50 to 60Hz a.c. Stronger fields should not be used.

## Pulse Erasure

(a) The speed of erasure is controlled by the adjustment of the pulse duration in conjunction with the pulse repetition rate, which should be sufficiently high to prevent flicker, and preferably in the range between 100 and 2000 pulses per second. By increasing the pulse duration or the pulse repetition rate, the erasure time may be reduced proportionately. The pulse amplitude also alters the erase rate but primarily determines the final potential to which the storage mesh is driven in the absence of writing (see pages 11 and 12). Normally a pulse amplitude two to three times the manual erase value is applied, which gives an approximately uniform rate of erasure for visible signals but tends to suppress small non-integrating signals such as noise. A much lower pulse amplitude must be used if the grey scale is to be preserved with no loss of information.

(b) If it can be conveniently arranged for the screen h.t. to be switched off simultaneously with either manual or pulse train erase then two advantages will ensue:

- (i) Contrast during pulse train erase will improve.
- (ii) The time taken for erasure will decrease.

(c) The normal erasure procedure may be inadequate or ineffective under the following conditions:

- (i) When writing beam electrons have penetrated the surface of the storage insulator and have built up charges within it. Low velocity flood beam electrons cannot neutralize these charges and after the normal erasure procedure has been carried out the original screen image may still be faintly visible as the background illumination increases.
- (ii) When parts of the storage mesh surface are driven so positive that the number of secondary electrons produced by the flood beam exceeds those arriving at the surface. This condition is known as runaway charging and can occur when a pulse exceeding 20 volts in amplitude is applied to the backing electrode. It can also occur when an excessively high writing charge is deposited, e.g. with a stationary spot or line and particularly when writing takes place in the absence of flood beam current. Damage may be done to the storage mesh if this fault is not quickly corrected.

Both faults can be corrected by operating a switch to disconnect the backing electrode from its supply and connecting it to the flood gun grid 4 through a protective resistor; this switch must make and break quickly and need

be operated once only. The screen should then be at uniform full brilliance and normal erasure will prepare the tube for operation. Care should be taken to ensure that this switch cannot be left in the 'on' condition. The above procedure is known as 'clearance'.

### **Flood Gun**

The flood gun supplies must be held relatively stable. The flood gun grid 2 is internally connected to the writing gun grid 4 and the potential of this point relative to earth is normally fixed by the mean potential of the deflecting system (see Deflection Supplies below).

To prevent the occurrence of runaway charging, the flood gun beam must always be operative before the writing gun supplies are switched on.

### **Writing Gun**

The writing gun cathode is operated at a potential in the region of  $-1.5$  to  $-2.8\text{kV}$ ; consequently the heater supply should be adequately insulated. The cathode supply must be free from ripple to prevent modulation of the writing beam and have good stability to maintain constant modulation depth and focus.

Care should be taken to prevent heavy transient writing beam currents when switching on. The writing beam should be adjusted so that the highlight brightness of the display is not saturated as this will result in a rapid deterioration in resolution.

### **Deflection Supplies**

The mean potentials of the deflecting plates should be held very close to the writing gun grid 4 voltage, and astigmatism of the writing beam may be minimized by small adjustments of the potential differences between them.

The undeflected writing beam will normally focus to a spot at the centre of the storage mesh. To compensate for variations between individual tubes, however, an adjustable and reversible supply to the deflection plates should be provided for centring the writing beam spot.

Any failure of the deflection drive that may result in the production of a stationary spot or line may cause runaway charging, even with the flood beam on. Provision should be made for automatically cutting off the writing gun beam in the event of any such failure.

# TYPICAL WRITING GUN CHARACTERISTIC

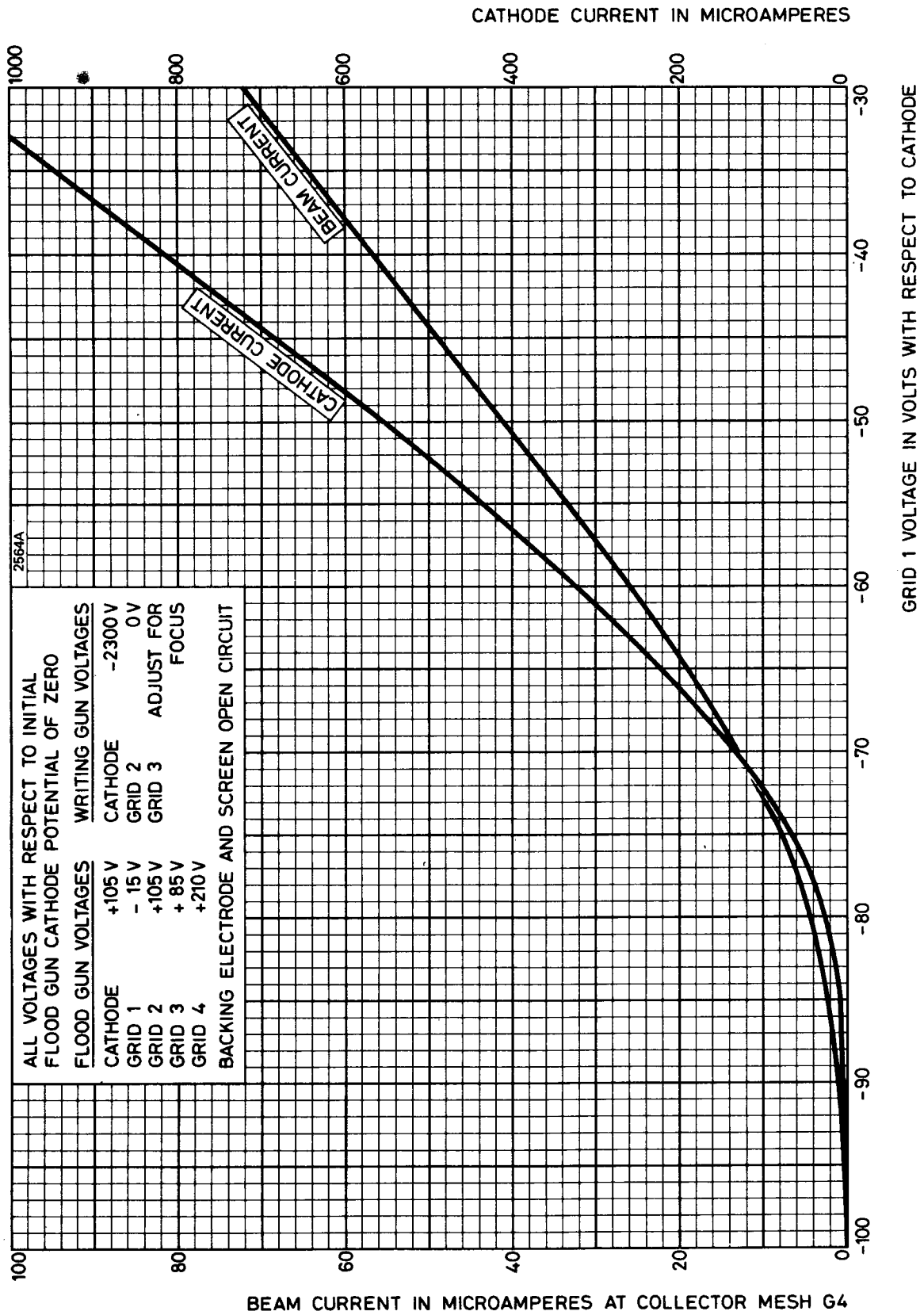

# TYPICAL SCREEN BRIGHTNESS CHARACTERISTIC

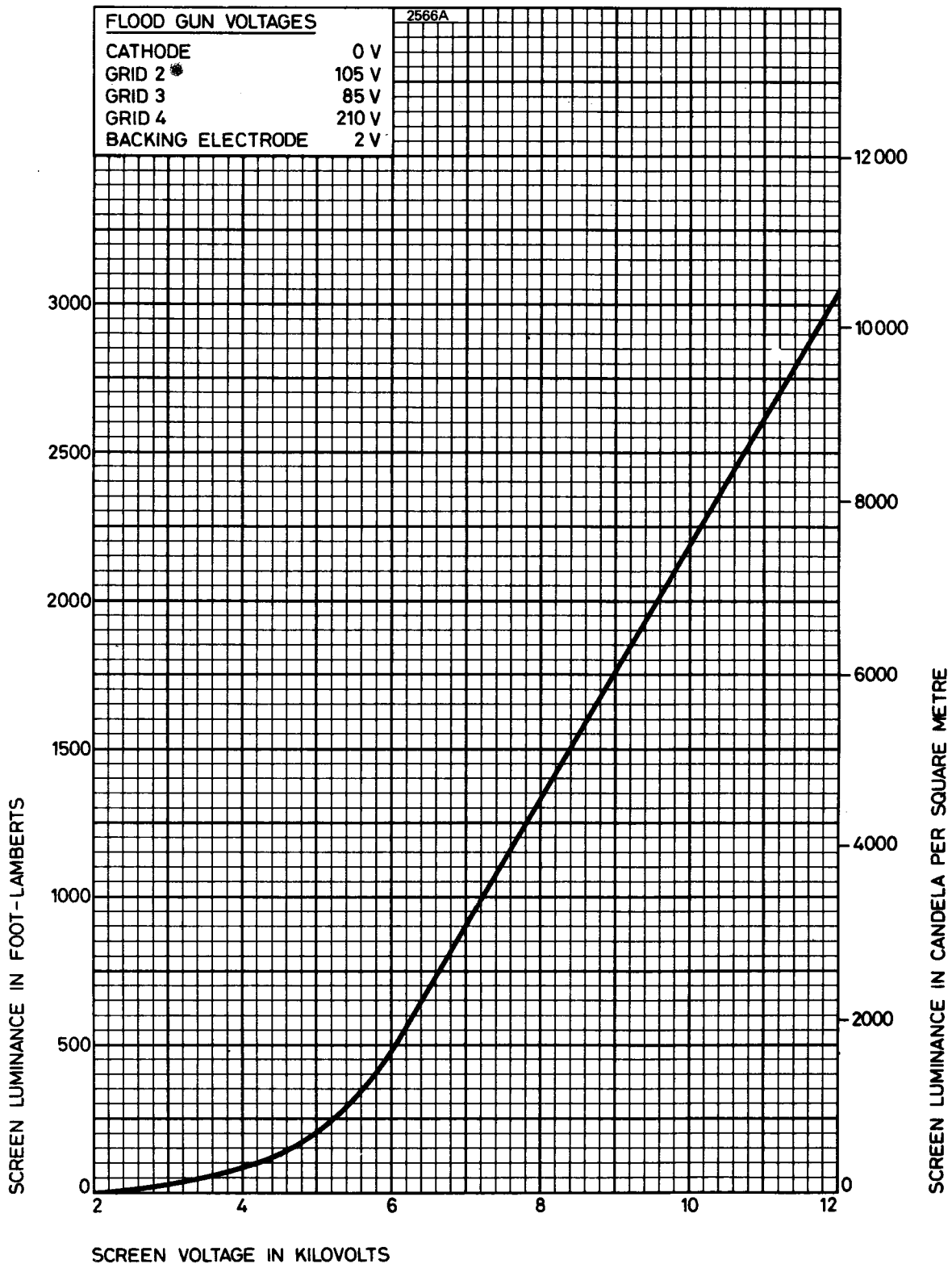



# TYPICAL RELATIVE BRIGHTNESS CHARACTERISTICS

Obtained by applying repetitive erase pulses

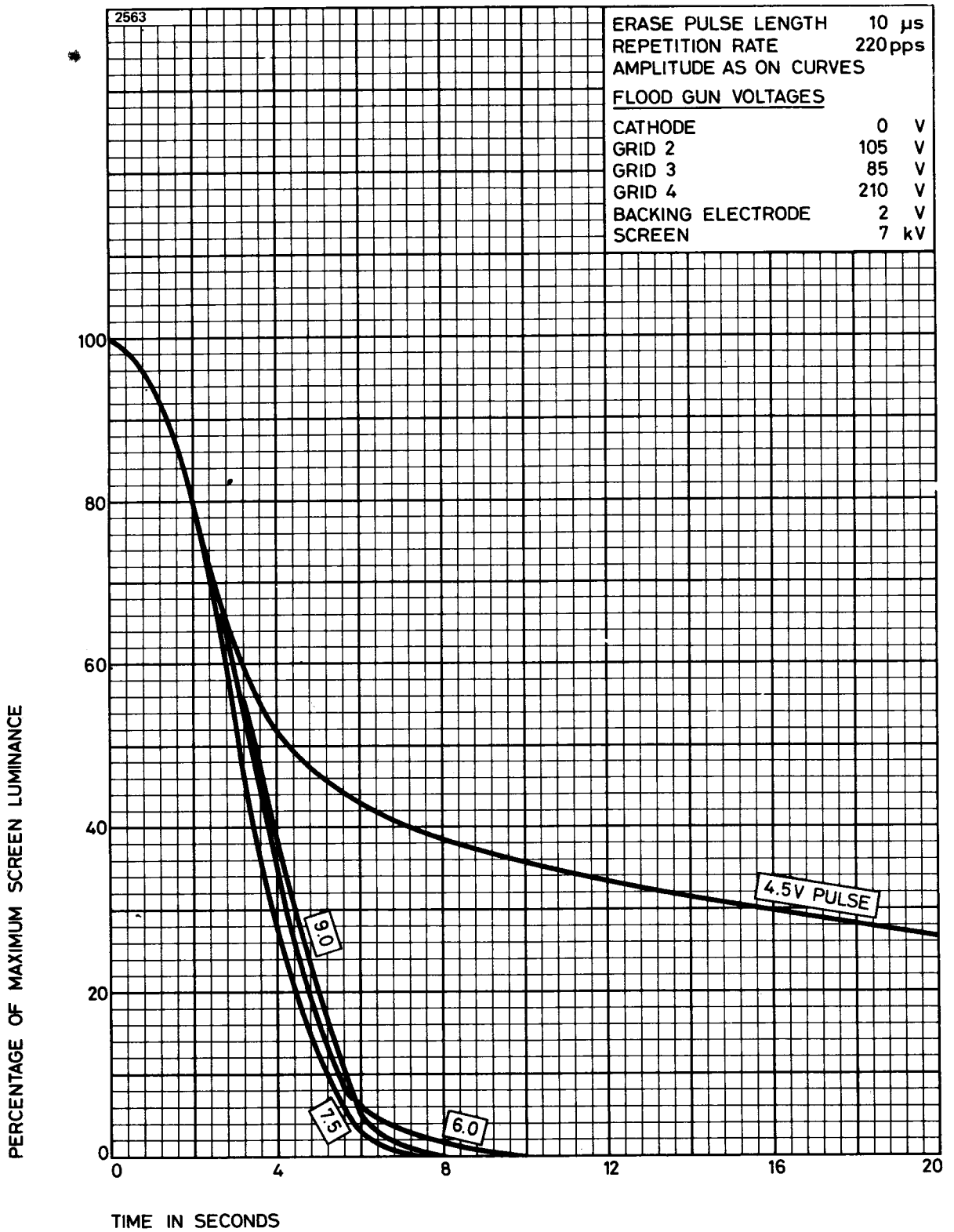

# TYPICAL STORAGE MESH CHARACTERISTIC

Obtained by applying manual erase pulses

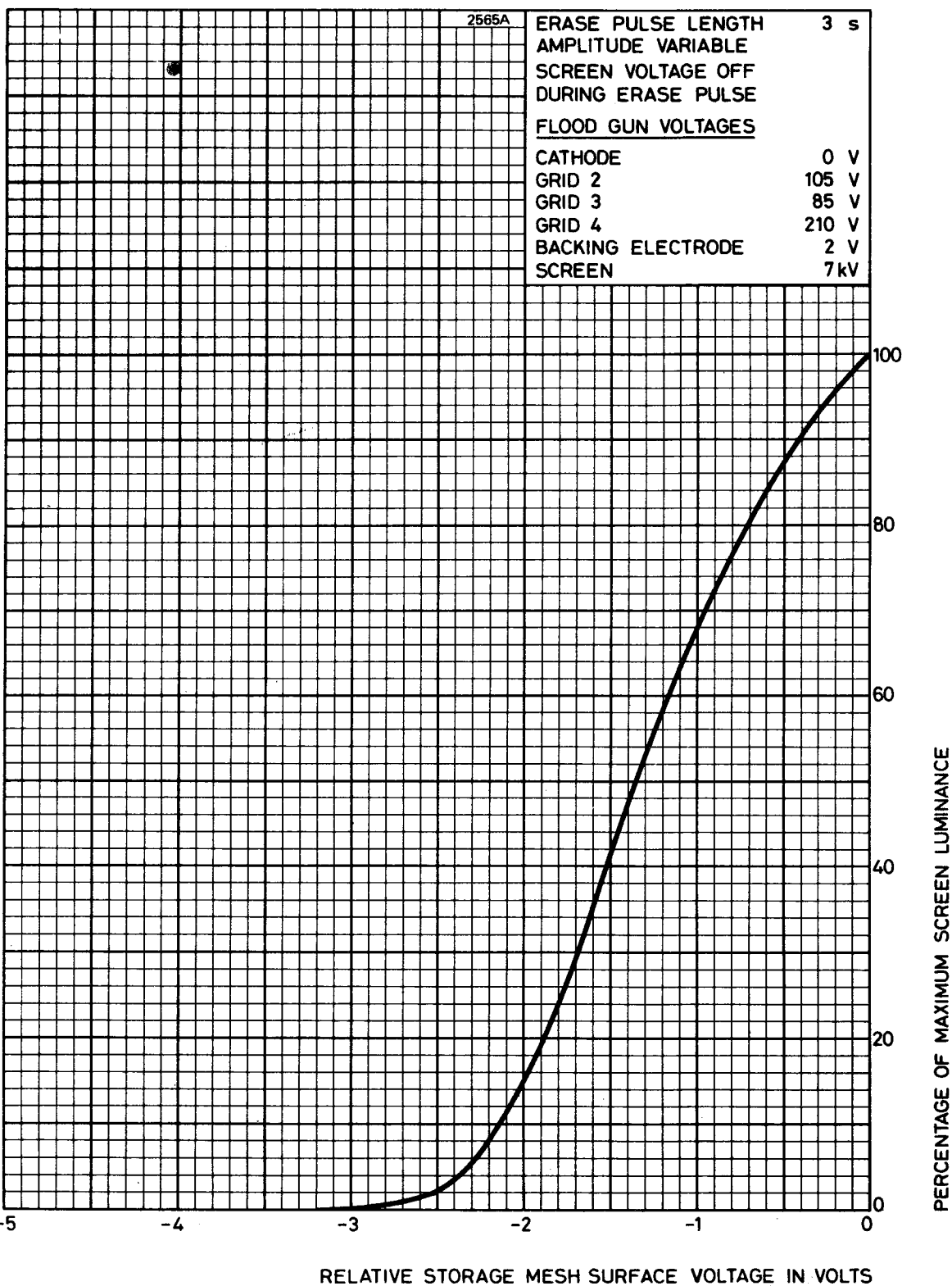

The storage mesh surface potential is arbitrarily considered zero at full brightness for the purpose of this graph.

# TYPICAL SPECTRAL OUTPUT CHARACTERISTIC FOR P20 PHOSPHOR

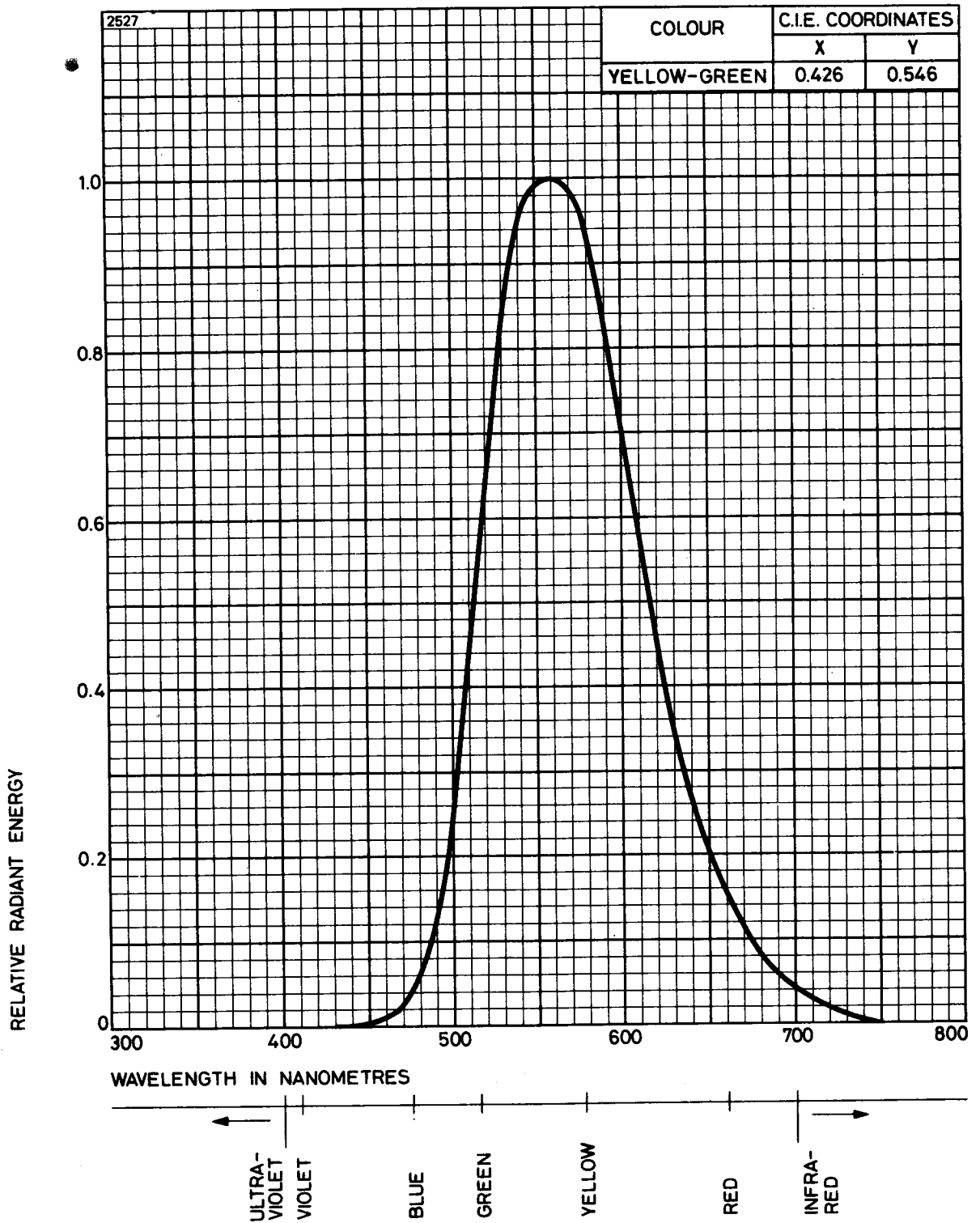

# OUTLINE

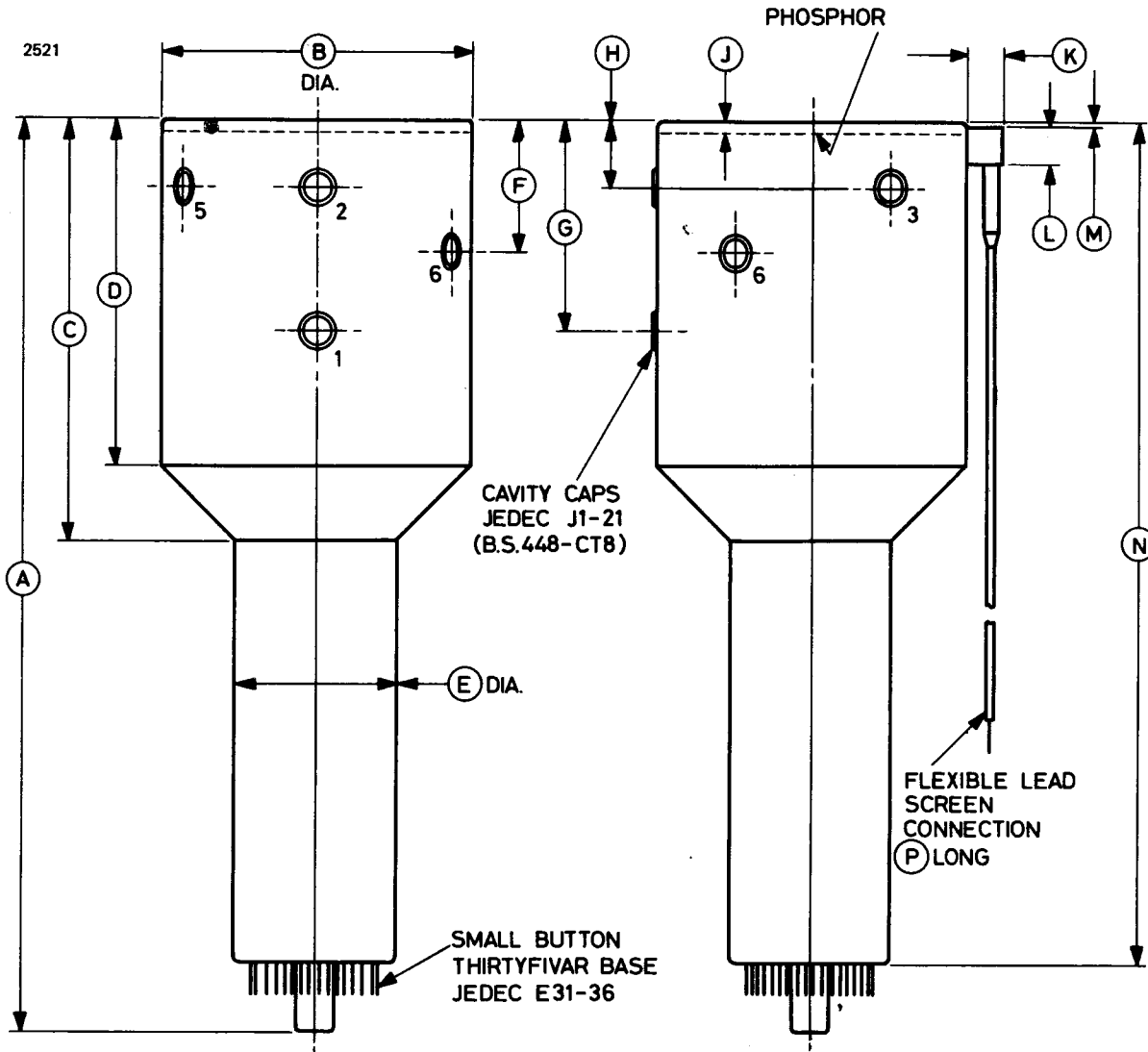

Ref	Inches	Millimetres	Ref	Inches	Millimetres
A	15.250 ± 0.250	387.4 ± 6.4	K	0.625 max	15.88 max
B	5.312 max	134.9 max	L	0.563 max	14.30 max
C	7.000 max	177.8 max	M	0.062	1.58
D	5.750 max	146.1 max	N	14.125 ± 0.250	358.8 ± 6.4
E	3.094 max	78.59 max	P	22.5	571.5
F	2.188 ± 0.125	55.58 ± 3.18	Q	0.062 max	1.58 max
G	3.500 ± 0.125	88.90 ± 3.18	R	0.625 max	15.88 max
H	1.125 ± 0.125	28.58 ± 3.18	S	5.437 max	138.1 max
J	0.250 ± 0.025	6.35 ± 0.64			

Millimetre dimensions have been derived from inches.

# OUTLINE

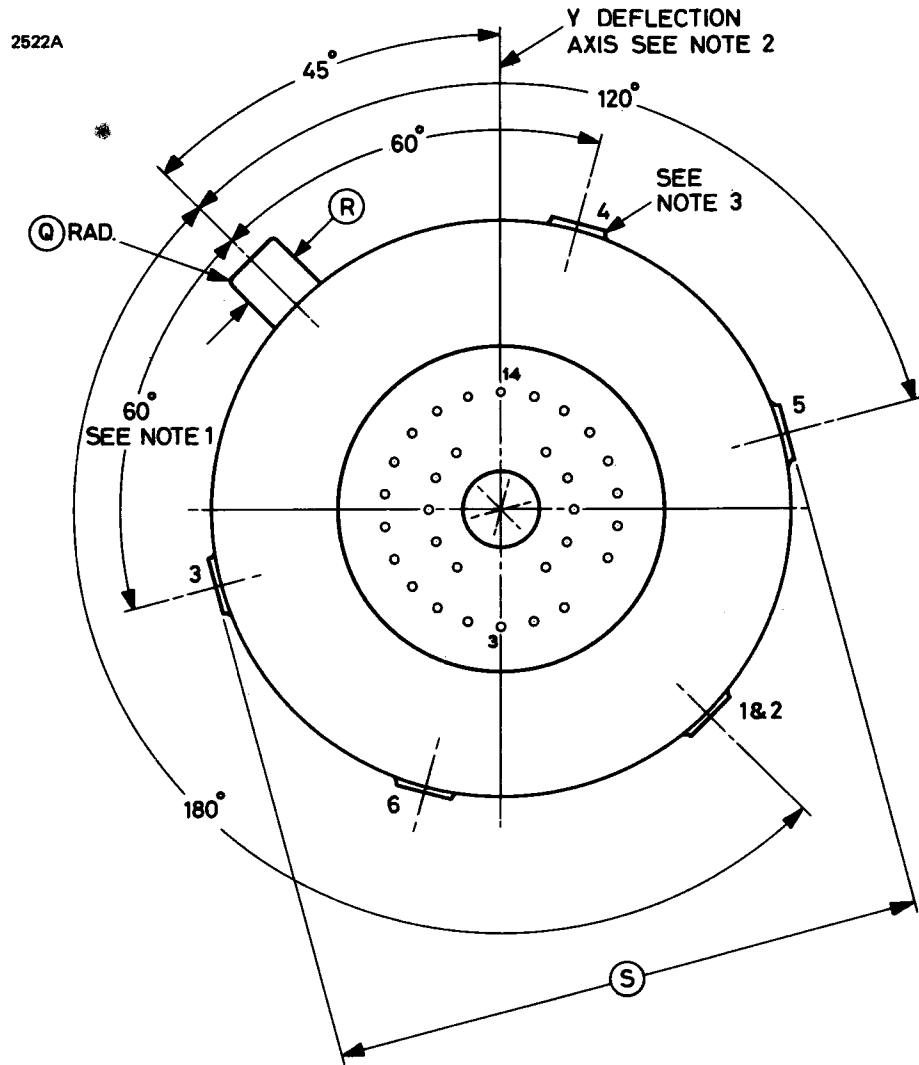

## Outline Notes

1. Tolerance on angles  $\pm 7^\circ$ .
2. The centre line passing through base pins 3 and 14 and the Y-deflection axis are in line within  $10^\circ$ .
3. Cavity cap 4 is on the same plane as cavity caps 2, 3 and 5.

## Cavity Cap Connections

Cap	Element	Cap	Element
1	Grid 3 (flood gun)	4	Grid 4 (flood gun)
2	Grid 4 (flood gun)	5	Backing electrode
3	Grid 4 (flood gun)	6	Grid 3 (flood gun)

## Base Connections

2523A

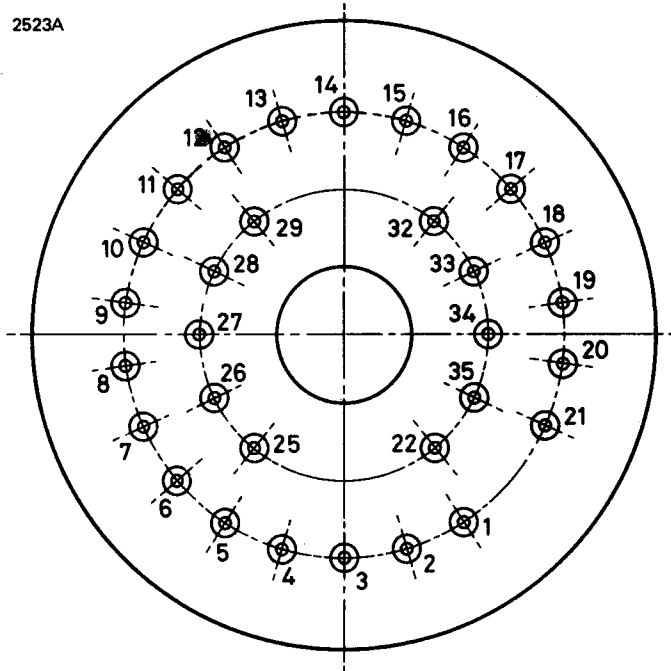

Pin	Element	Pin	Element
1	No connection	19	No connection
2	No connection	20	Internal connection. Do not use
3	Deflection plate X1	21	No connection
4	Deflection plate X2	22	Heater (flood gun)
5	No connection	23	Omitted
6	Grid 3 (writing gun)	24	Omitted
7	Internal connection. Do not use	25	No connection
8	Heater (writing gun)	26	Internal connection. Do not use
9	Heater (writing gun)	27	Cathode (writing gun)
10	Grid 1 (writing gun)	28	Internal connection. Do not use
11	No connection	29	No connection
12	No connection	30	Omitted
13	Deflection plate Y1	31	Omitted
14	Deflection plate Y2	32	Grid 1 (flood gun)
15	Grid 2 (writing gun)	33	Cathode (flood gun)
16	No connection	34	No connection
17	Grid 2 (flood gun) and grid 4 (writing gun)	35	Heater (flood gun)
18	No connection		

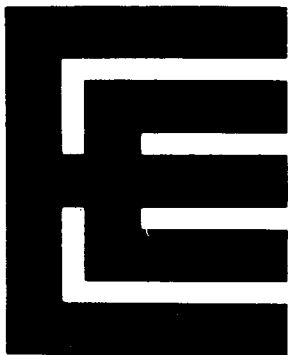

## DIRECT VIEW STORAGE TUBE

---

### Service Type CV5987

The data should be read in conjunction with the Storage Tube Preamble.

### INTRODUCTION

The E702B is a direct view storage tube with a useful viewing screen diameter of 4 inches (102mm). It is designed to provide very bright displays of information ranging from single transients and recurrent waveforms to half-tone pictures. The writing gun beam is electrostatically deflected, and high stored writing speeds, 1.0 inch per microsecond, can be achieved. The tube is of ruggedized construction and is recommended for airborne and other radar applications where vibration and low pressure conditions may be encountered.

The tube has two electron guns, one for writing the signal on to the storage surface and the other, the flood gun, for displaying written information on the viewing screen. The writing gun is similar to that in a conventional cathode ray tube, except that it need only be operated for a single trace. In writing, a charge pattern is deposited on the storage surface, which consists of an insulator coating on a metal mesh (the backing electrode). Low velocity electrons from the flood gun approach the storage mesh normally and at constant current density over the useful area. They penetrate the mesh in those areas where a charge pattern has been written, the number doing so being determined by the amount of charge deposited, and are then accelerated to the viewing screen where they produce an image.

Since the flood gun is normally continuously operative, the image on the viewing screen persists without deterioration for one to two minutes, and is visible for periods up to ten minutes. The charge pattern written on the storage surface can be retained for extended periods by switching off the flood beam until viewing is required, provided that no writing takes place while the flood gun is inoperative. The image can be completely erased in a fraction of a second by applying a small positive pulse to the backing electrode; controlled persistence can be obtained by varying the duration of shorter repetitive pulses.

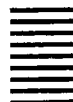

## GENERAL

### Electrical and General

	Writing Gun	Flood Gun	
Cathodes, indirectly heated, oxide coated . . . . .	one	one	
Heater voltage . . . . .	6.3	6.3	V
Heater current . . . . .	0.6	0.6	A
Cathode heating time (minimum) . . . . .	see note 1	45	s
Inter-electrode capacitances:			
cathode to all other electrodes . . . . .	4.0	—	pF
grid 1 to all other electrodes . . . . .	7.0	24	pF
X1 plate to all other electrodes . . . . .	11.5	—	pF
X2 plate to all other electrodes . . . . .	11.5	—	pF
Y1 plate to all other electrodes . . . . .	6.5	—	pF
Y2 plate to all other electrodes . . . . .	9.5	—	pF
X1 to X2 plates* . . . . .	2.0	—	pF
Y1 to Y2 plates* . . . . .	2.0	—	pF
writing gun grid 1 to writing gun cathode* . . . . .	1.5	—	pF
backing electrode to all other electrodes . . . . .	—	74	pF
screen to all other electrodes . . . . .	—	32	pF
Focus method . . . . .	electrostatic	electrostatic	
Deflection method . . . . .	electrostatic	none	
Phosphor . . . . .	—	aluminized P20	
Fluorescent colour (see spectral characteristic) . . . . .			yellow-green

### Mechanical

Overall length . . . . .	15.500 inches (393.7mm) max
Overall diameter (excluding flexible lead) . . . . .	5.437 inches (138.1mm) max
Bulb diameter . . . . .	5.312 inches (134.9mm) max
Useful viewing screen diameter . . . . .	4.000 inches (101.6mm) min
Net weight . . . . .	2½ pounds (1.15kg) approx
Mounting position . . . . .	any
Base . . . . .	31-pin small button thirty-five (JEDEC no. E31-36)
Bulb cavity caps (six) . . . . .	B.S.448-CT8 (JEDEC no. J1-21)
Viewing screen connection . . . . .	flexible lead

\* With all other electrodes earthed



## MAXIMUM AND MINIMUM RATINGS (Absolute values)

No individual rating should be exceeded

All voltages are with respect to the flood gun cathode unless otherwise stated

### Writing Gun

	Min	Max	
Heater voltage . . . . .	6.0	6.6	V
Grid 4 voltage . . . . .			see note 2
Grid 3 voltage (negative value) . . . . .	—	2500	V
Grid 2 voltage . . . . .	—	200	V
Grid 1 voltage:			
negative bias* . . . . .	0	200	V
positive peak* . . . . .	—	2.0	V
Cathode voltage (negative value) . . . . .	—	2800	V
Peak heater to cathode voltage:			
heater positive with respect to cathode . . . . .	—	125	V
heater negative with respect to cathode . . . . .	—	125	V
Cathode current (peak) . . . . .	—	1.0	mA
Grid to cathode circuit impedance . . . . .	—	1.0	MΩ
Deflection plate circuit impedance . . . . .	—	0.1	MΩ

### Flood Gun

	Min	Max	
Heater voltage . . . . .	6.0	6.6	V
Viewing screen voltage . . . . .	—	12	kV
Backing electrode voltage (peak) (see note 3) . . . . .	—	20	V
Grid 4 (collector mesh) voltage . . . . .	—	300	V
Grid 3 voltage . . . . .	—	300	V
Grid 2 voltage (see note 2) . . . . .	—	200	V
Grid 1 voltage:			
negative bias (never positive) . . . . .	2.0	150	V
Peak heater to cathode voltage:			
heater positive with respect to cathode . . . . .	—	125	V
heater negative with respect to cathode . . . . .	—	125	V
Cathode current (mean) . . . . .	—	2.0	mA
Viewing screen dissipation . . . . .	—	6.0	W
Backing electrode supply impedance . . . . .	—	5000	Ω
Grid to cathode circuit impedance . . . . .	—	0.5	MΩ
Viewing screen supply impedance (see note 4) . . . . .	1.0	5.0	MΩ

\* With respect to Writing Gun Cathode.

## TYPICAL OPERATION

All voltages are with respect to the flood gun cathode unless otherwise stated

### WRITING GUN

#### Operational Conditions

Grid 4 voltage . . . . .		see note 2
Grid 3 voltage (usual range for focus)* . . . . .	450 to 650	V
Grid 2 voltage . . . . .	0	V
Grid 1 voltage (range for writing beam cut-off)* . . . . .	-45 to -110	V
Cathode voltage . . . . .	-1800	V

#### Typical Performance

Writing beam current (50V modulation) (see note 5) . . . . .	49	$\mu$ A
Cathode current (50V modulation) . . . . .	700	$\mu$ A
Deflection factor, X plates . . . . .	90	V/inch
Deflection factor, Y plates . . . . .	87	V/inch
Stored writing speed (see note 5) . . . . .	1	inch/ $\mu$ s

### FLOOD GUN

#### Operational Conditions

Screen voltage . . . . .	10	kV
Backing electrode d.c. voltage . . . . .	2.0	V
Erase pulse amplitude for screen cut-off (see notes 6 and 7) . . . . .	3.9	V
Grid 4 (collector mesh) voltage . . . . .	225	V
Grid 3 voltage (see note 8) . . . . .	90	V
Grid 2 voltage . . . . .	150	V
Grid 1 voltage (see note 8) . . . . .	-35	V
Cathode voltage . . . . .	0	V

#### Typical Performance

Screen current for full brightness . . . . .	0.48	mA
Cathode current . . . . .	1.3	mA
Screen luminance (see note 9) . . . . .	2150	ft-lamberts
	7375	cd/m <sup>2</sup>
Viewing time (see note 10):		
minimum . . . . .	30	s
typical . . . . .	60	s
Resolution (see note 11) . . . . .	100	lines/inch

\* With respect to Writing Gun Cathode.

## NOTES

1. To prevent the occurrence of transients when switching on or off, the writing gun heater voltage may be applied simultaneously with, or after, the other writing gun voltages, and switched off before these voltages are removed, provided the writing gun is biased to beyond cut-off.
2. Grid 4 (writing gun) is internally connected to grid 2 (flood gun).
3. Except when the faults mentioned under Pulse Erasure, part (c), of the General Instructions on page 7 are being corrected.
4. The viewing screen supply impedance should be less than  $5M\Omega$  to prevent excessive changes in screen voltage during erasure.
5. Writing is a charge deposition process and the current required for a given brightness level is proportional to the writing speed and inversely proportional to the number of times the information is written in one place.
6. With manual erasure (approximately 1 second) and the screen voltage simultaneously removed.
7. Maximum screen brightness is obtained when the storage mesh surface has stabilized at approximately zero potential, i.e. flood gun cathode potential. The application of a positive manual erase pulse to the backing electrode produces a corresponding positive increase in the storage mesh surface potential. This surface potential is reduced to near flood gun cathode potential by flood beam electrons. When the erase pulse is removed the surface acquires a negative potential relative to that at full brightness and equal in value to the erase pulse amplitude.
8. To achieve collimation of the flood beam, the voltages applied to the flood gun grids 2, 3 and 4 should be preset to the fixed values given on page 4. The voltage of grid 1 should then be adjusted to just give maximum uniform display over the screen. The voltage of grid 3 should then be adjusted to give the most uniform erasure when a train of erasing pulses is applied to the backing electrode. Slight readjustment of grid 1 voltage may assist in obtaining the most uniform erasure.
9. The meter used for measuring screen luminance has been corrected to the frequency response of the human eye.

10. Time for background to rise from cut-off to 10% of maximum brightness. An increase in viewing time can be obtained by switching off the flood beam by pulses at a frequency sufficiently high to prevent flicker, the apparent brightness of the display being proportionately reduced.
11. Using a test card C pattern produced from a monoscope generator and written for one frame only at a level to display all five half-tones.

## **GENERAL INSTRUCTIONS**

### **Handling**

The tube should be transported screen upwards to prevent particles falling on the storage elements. It should be handled with care to avoid damage to the metal seals and the encapsulated screen lead.

### **Magnetic Shielding**

Because of the low voltage of the flood gun beam, it is essential to shield the whole of the viewing section from magnetic fields; shielding of the writing gun is also advisable. Details of suitable Mumetal shields are available from English Electric Valve Company Ltd.

### **Demagnetization**

The tube may become magnetized during transportation and this will cause non-uniform illumination under full brightness conditions. In this event, a degaussing coil should be drawn slowly over the tube taking one minute for the operation. Such a coil may be made up of 900 turns of no. 16 s.w.g. enamelled wire wound on a 6½-inch diameter former 2 inches long. The coil supply voltage should be 115 volts 50 to 60Hz a.c. Stronger fields should not be used.

### **Pulse Erasure**

(a) The speed of erasure is controlled by the adjustment of the pulse duration in conjunction with the pulse repetition rate, which should be sufficiently high to prevent flicker, and preferably in the range between 100 and 2000 pulses per second. By increasing the pulse duration or the pulse repetition rate, the erasure time may be reduced proportionately. The pulse amplitude also alters the erase rate but primarily determines the final potential to which the storage mesh is driven in the absence of writing (see pages 11 and 12).

Normally a pulse amplitude two to three times the manual erase value is applied, which gives an approximately uniform rate of erasure for visible signals but tends to suppress small non-integrating signals such as noise. A much lower pulse amplitude must be used if the grey scale is to be preserved with no loss of information.

(b) If it can be conveniently arranged for the screen h.t. to be switched off simultaneously with either manual or pulse train erase then two advantages will ensue:

- (i) Contrast during pulse train erase will improve.
- (ii) The time taken for erasure will decrease.

(c) The normal erasure procedure may be inadequate or ineffective under the following conditions:

- (i) When writing beam electrons have penetrated the surface of the storage insulator and have built up charges within it. Low velocity flood beam electrons cannot neutralize these charges and after the normal erasure procedure has been carried out the original screen image may still be faintly visible as the background illumination increases.
- (ii) When parts of the storage mesh surface are driven so positive that the number of secondary electrons produced by the flood beam exceeds those arriving at the surface. This condition is known as runaway charging and can occur when a pulse exceeding 20 volts in amplitude is applied to the backing electrode. It can also occur when an excessively high writing charge is deposited, e.g. with a stationary spot or line and particularly when writing takes place in the absence of flood beam current. Damage may be done to the storage mesh if this fault is not quickly corrected.

Both faults can be corrected by operating a switch to disconnect the backing electrode from its supply and connecting it to the flood gun grid 4 through a protective resistor; this switch must make and break quickly and need be operated once only. The screen should then be at uniform full brightness and normal erasure will prepare the tube for operation. Care should be taken to ensure that this switch cannot be left in the 'on' condition. The above procedure is known as 'clearance'.

## **Flood Gun**

The flood gun supplies must be held relatively stable. The flood gun grid 2 is internally connected to the writing gun grid 4 and the potential of this point relative to earth is normally fixed by the mean potential of the deflecting system (see Deflection Supplies below).

To prevent the occurrence of runaway charging, the flood gun beam must always be operative before the writing gun supplies are switched on.

## **Writing Gun**

The writing gun cathode is operated at a potential in the region of  $-1.5$  to  $-2.8\text{kV}$ ; consequently the heater supply should be adequately insulated. The cathode supply must be free from ripple to prevent modulation of the writing beam and have good stability to maintain constant modulation depth and focus.

Care should be taken to prevent heavy transient writing beam currents when switching on. The writing beam should be adjusted so that the highlight brightness of the display is not saturated as this will result in a rapid deterioration in resolution.

## **Deflection Supplies**

The mean potentials of the deflecting plates should be held very close to the writing gun grid 4 voltage, and astigmatism of the writing beam may be minimized by small adjustments of the potential differences between them.

The undeflected writing beam will normally focus to a spot at the centre of the storage mesh. To compensate for variations between individual tubes, however, an adjustable and reversible supply to the deflection plates should be provided for centring the writing beam spot.

Any failure of the deflection drive that may result in the production of a stationary spot or line may cause runaway charging, even with the flood beam on. Provision should be made for automatically cutting off the writing gun beam in the event of any such failure.

# TYPICAL WRITING GUN CHARACTERISTIC

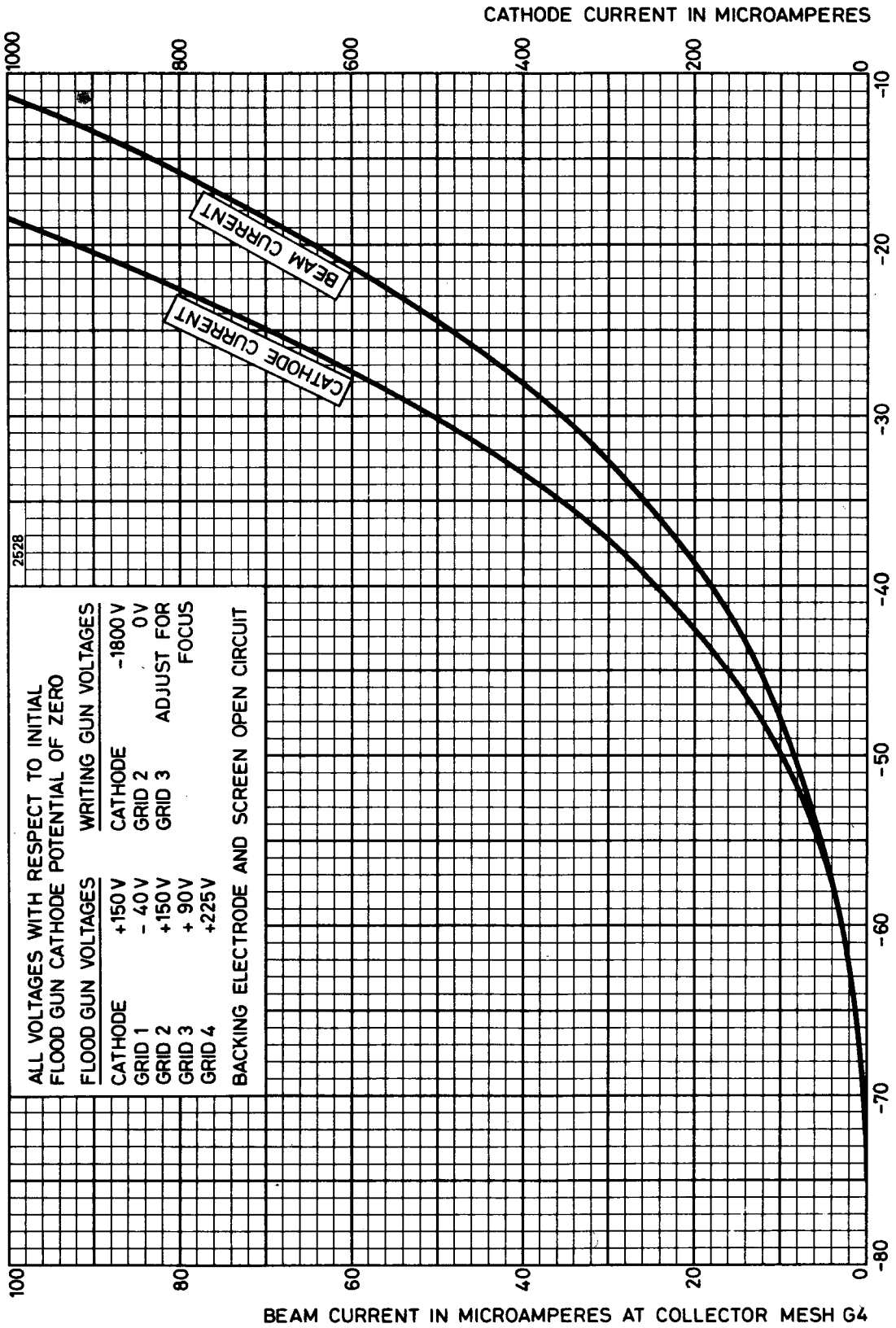

# TYPICAL SCREEN BRIGHTNESS CHARACTERISTIC

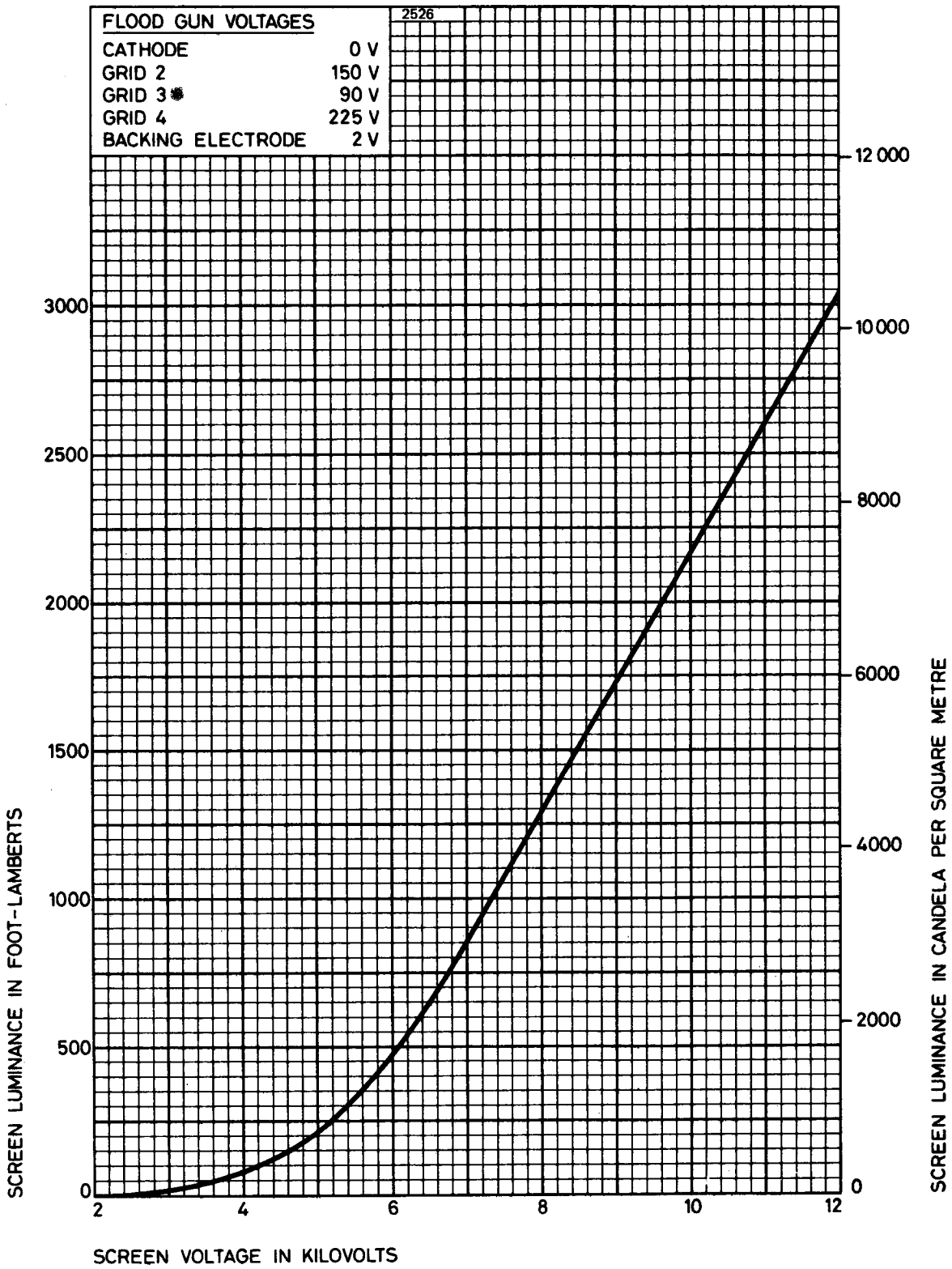



# TYPICAL RELATIVE BRIGHTNESS CHARACTERISTICS

Obtained by applying repetitive erase pulses

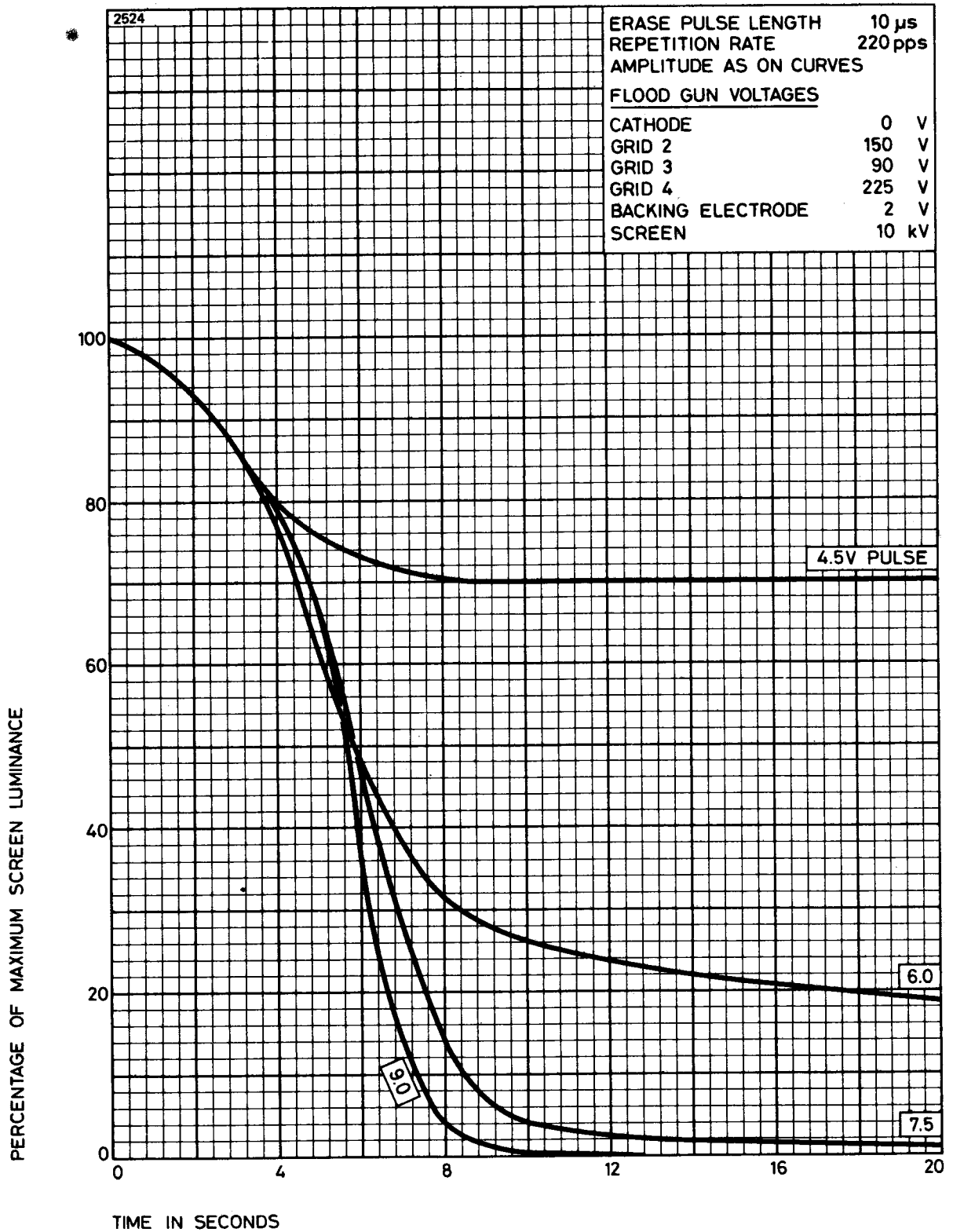

# TYPICAL STORAGE MESH CHARACTERISTIC

Obtained by applying manual erase pulses

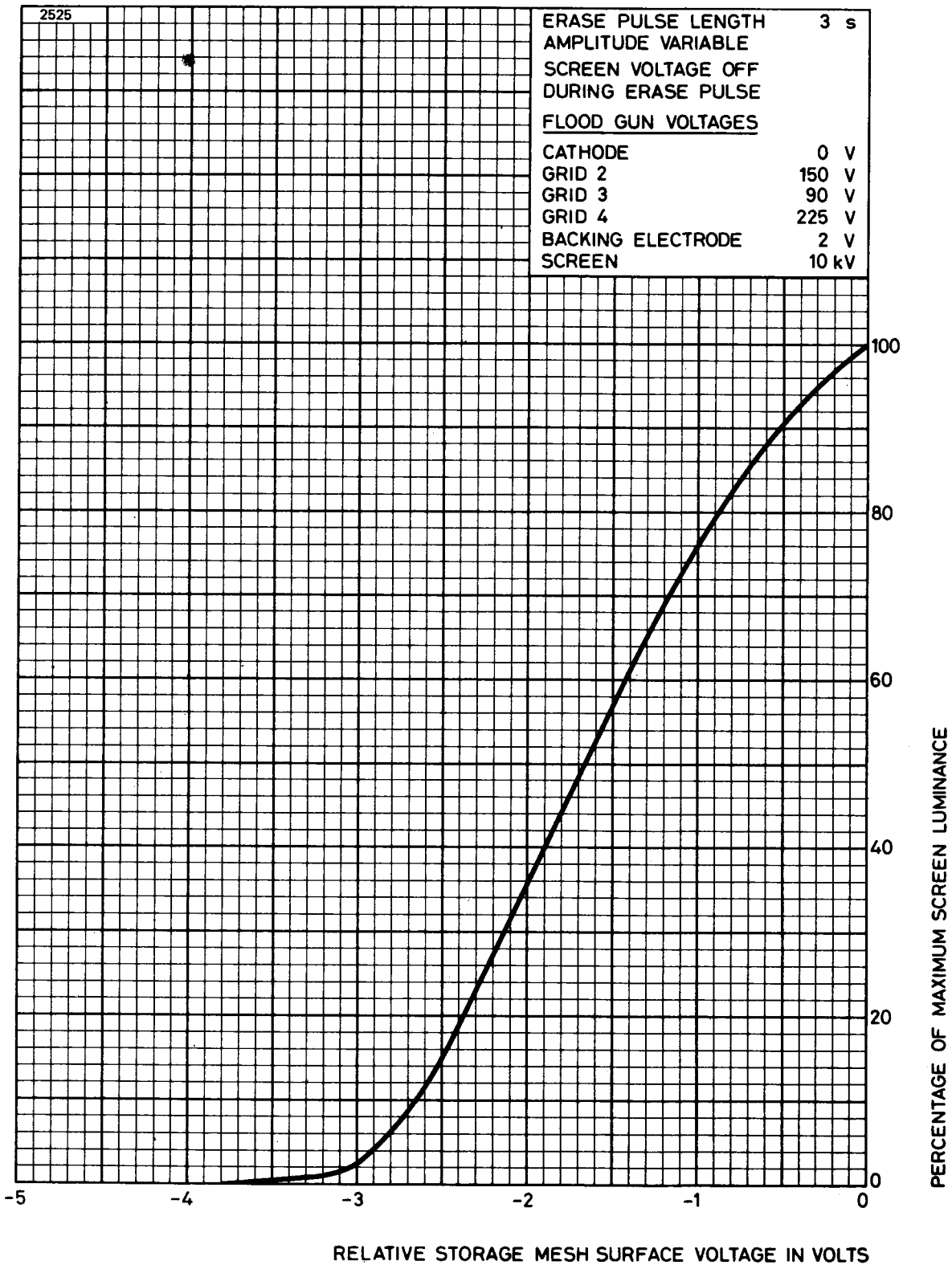

The storage mesh surface potential is arbitrarily considered zero at full brightness for the purpose of this graph.

# TYPICAL SPECTRAL OUTPUT CHARACTERISTIC FOR P20 PHOSPHOR

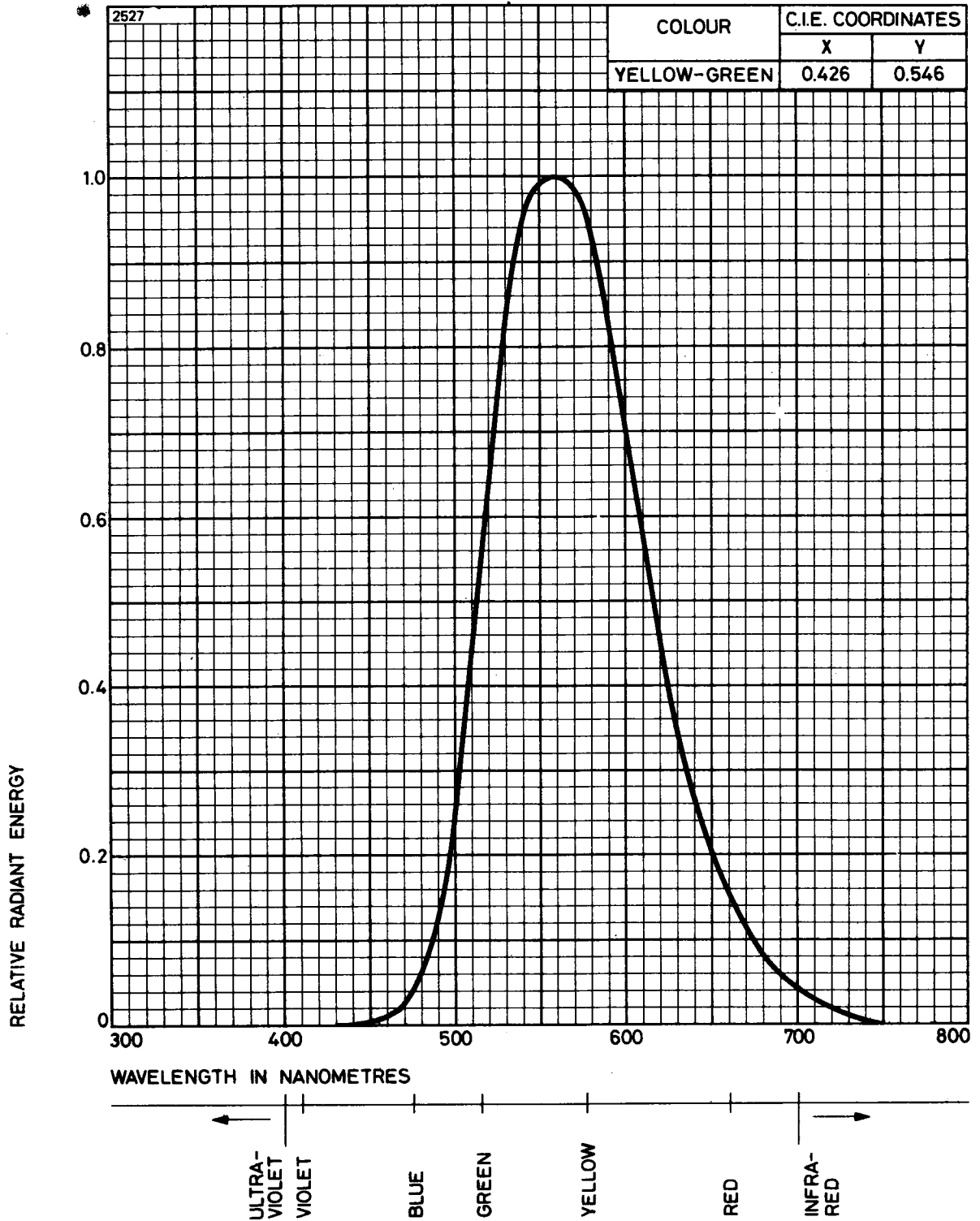

# OUTLINE

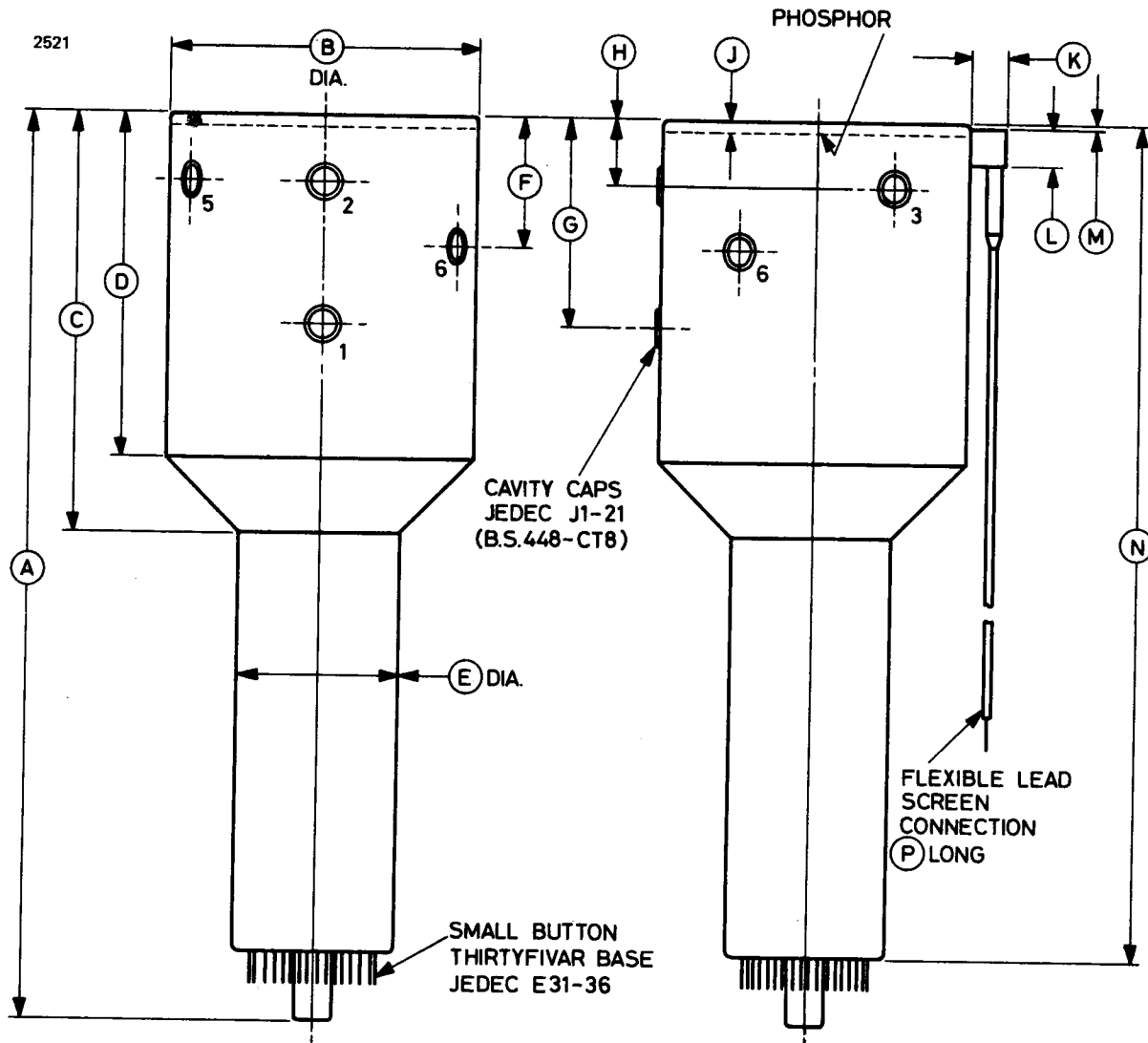

Ref	Inches	Millimetres	Ref	Inches	Millimetres
A	15.250 ± 0.250	387.4 ± 6.4	K	0.625 max	15.88 max
B	5.312 max	134.9 max	L	0.563 max	14.30 max
C	7.000 max	177.8 max	M	0.062	1.58
D	5.750 max	146.1 max	N	14.125 ± 0.250	358.8 ± 6.4
E	3.094 max	78.59 max	P	22.5	571.5
F	2.188 ± 0.125	55.58 ± 3.18	Q	0.062 max	1.58 max
G	3.500 ± 0.125	88.90 ± 3.18	R	0.625 max	15.88 max
H	1.125 ± 0.125	28.58 ± 3.18	S	5.437 max	138.1 max
J	0.250 ± 0.025	6.35 ± 0.64			

Millimetre dimensions have been derived from inches.

# OUTLINE

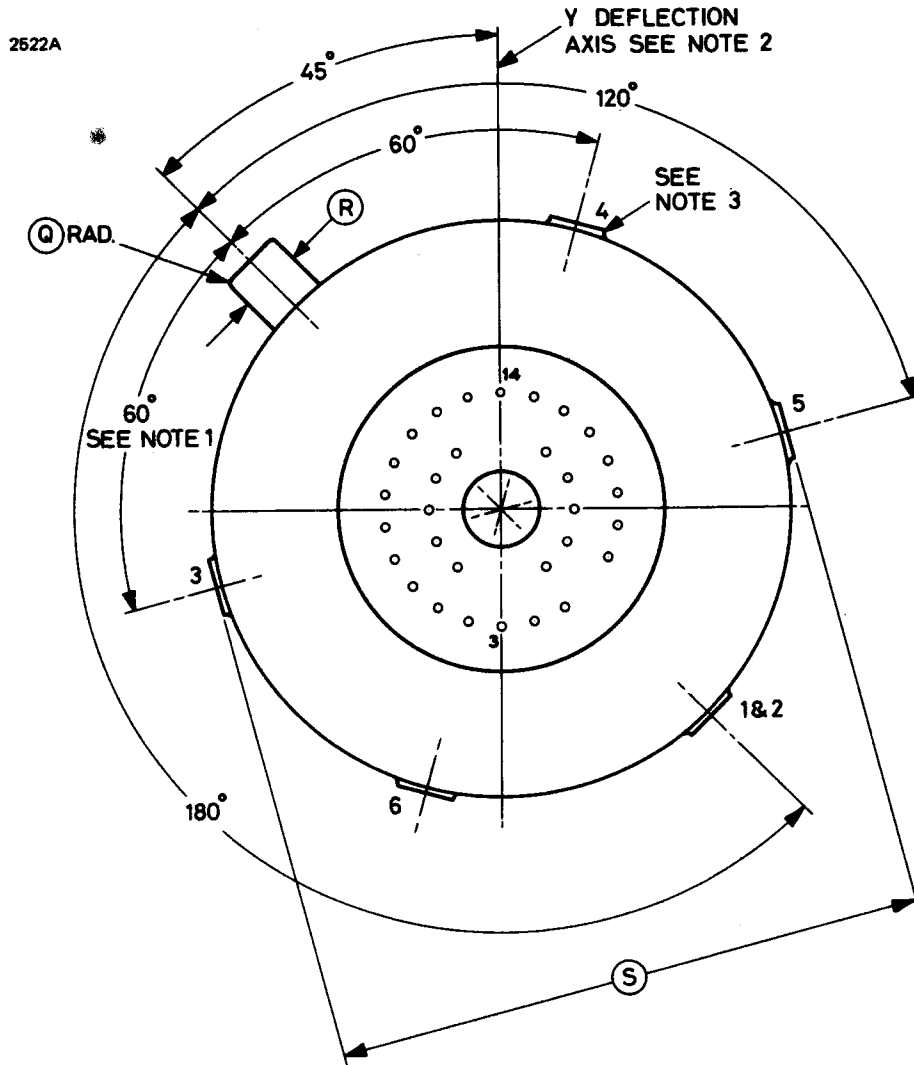

## Outline Notes

1. Tolerance on angles  $\pm 7^\circ$ .
2. The centre line passing through base pins 3 and 14 and the Y-deflection axis are in line within  $10^\circ$ .
3. Cavity cap 4 is on the same plane as cavity caps 2, 3 and 5.

## Cavity Cap Connections

Cap	Element	Cap	Element
1	Grid 3 (flood gun)	4	Grid 4 (flood gun)
2	Grid 4 (flood gun)	5	Backing electrode
3	Grid 4 (flood gun)	6	Grid 3 (flood gun)

## Base Connections

2523A

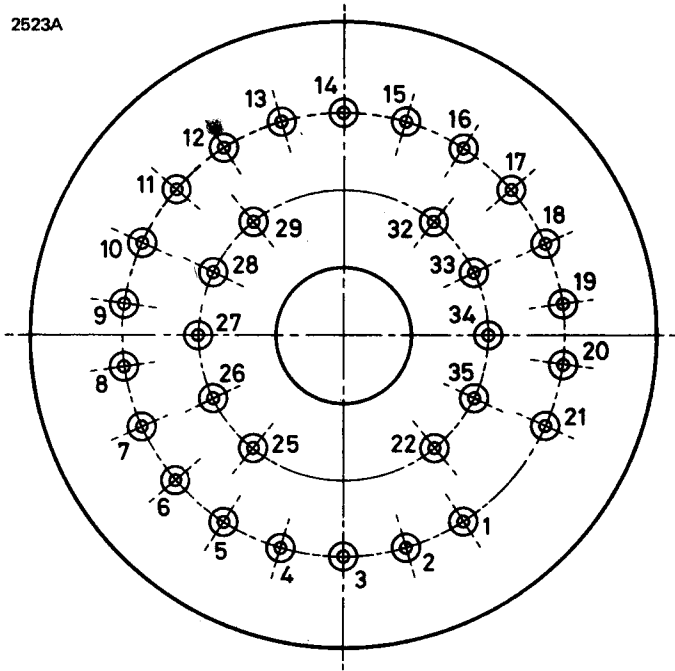

Pin	Element	Pin	Element
1	No connection	19	No connection
2	No connection	20	Internal connection.
3	Deflection plate X1		Do not use
4	Deflection plate X2	21	No connection
5	No connection	22	Heater (flood gun)
6	Grid 3 (writing gun)	23	Omitted
7	Internal connection.	24	Omitted
	Do not use	25	No connection
8	Heater (writing gun)	26	Internal connection.
9	Heater (writing gun)		Do not use
10	Grid 1 (writing gun)	27	Cathode (writing gun)
11	No connection	28	Internal connection.
12	No connection		Do not use
13	Deflection plate Y1	29	No connection
14	Deflection plate Y2	30	Omitted
15	Grid 2 (writing gun)	31	Omitted
16	No connection	32	Grid 1 (flood gun)
17	Grid 2 (flood gun) and grid 4 (writing gun)	33	Cathode (flood gun)
18	No connection	34	No connection
		35	Heater (flood gun)



## DIRECT VIEW STORAGE TUBE

---

The data should be read in conjunction with the Storage Tube Preamble.

### INTRODUCTION

The E712A is an 11 inch (279mm) direct view storage tube designed to provide very bright displays of information ranging from single transients and recurrent waveforms to half tone pictures. The useful viewing screen diameter is 9 inches (228.6mm), making the tube particularly suitable for the daylight-viewing of displays in radar, medical, television and tabular display applications.

The tube has two electron guns, one for writing the signal on to the storage surface and the other, the flood gun, for displaying written information on the viewing screen. The writing gun is similar to that in a conventional cathode ray tube, except that it need only be operative for a single trace, and is coaxial with the viewing screen so that relatively simple deflection circuits may be used. In writing, a charge pattern is deposited on the storage surface, which consists of an insulator coating on a metal mesh (the backing electrode). Low velocity electrons from the flood gun approach the storage mesh normally and at constant current density over the useful area. They penetrate the mesh in those areas where a charge pattern has been written, the number doing so being determined by the amount of charge deposited, and are then accelerated to the viewing screen where they produce an image.

Since the flood gun is normally continuously operative, the image on the viewing screen persists without deterioration for one to two minutes, and is visible for periods up to ten minutes. Extended storage periods may be obtained by switching off the flood beam until viewing is required, provided that no writing takes place while the flood gun is inoperative. The image can be completely erased in a fraction of a second by applying a small positive pulse to the backing electrode and controlled persistence can be obtained by varying the duration of shorter repetitive pulses.

Selective erasure is possible by electronic switching of appropriate electrode voltages.



## GENERAL DATA

### Electrical

	Writing Gun	Flood Gun	
Cathodes, indirectly heated, oxide coated . . . . .	one	one	
Heater voltage (see note 1) . . . . .	6.3	32	V
Heater current . . . . .	0.3	1.2	A
Cathode heating time (minimum) (see note 2) . . . . .	45	120	s
Inter-electrode capacitances:			
cathode to all other electrodes . . . . .	8.0	—	pF
grid 1 to all other electrodes . . . . .	10	—	pF
grid 1A to all other electrodes . . . . .	—	90	pF
grid 1 to cathode, all other electrodes earthed . . . . .	5.0	—	pF
backing electrode to all other electrodes . . . . .	—	250	pF
screen to all other electrodes . . . . .	—	110	pF
Focus method . . . . .	electrostatic	electrostatic	
Deflection method . . . . .	magnetic	none	
Phosphor . . . . .		aluminized P20	
Fluorescent colour (see spectral output characteristic on page 12) . . . . .		yellow	

### Mechanical

Overall length . . . . .	575mm (22.64 inches) max
Overall diameter . . . . .	284mm (11.18 inches) max
Useful viewing screen diameter . . . . .	228.6mm (9 inches) min
Net weight . . . . .	11 pounds (5kg) approx
Mounting position . . . . .	any, except with base up and with tube axis at an angle less than 20° from vertical
Base . . . . .	B.S.448-B12A
Bulb connectors . . . . .	12 B.S.448-CT8 cavity caps (JEDEC no. J1-21) and 2 special caps (see page 14)



## MAXIMUM AND MINIMUM RATINGS (Absolute values)

No individual rating should be exceeded

All voltages are with respect to the flood gun cathode unless otherwise stated

### Writing Gun

	Min	Max	
Heater voltage . . . . .	6.0	6.6	V
Grid 4 voltage . . . . .			see note 3
Grid 3 voltage (negative value) . . . . .	—	6.0	kV
Grid 2 voltage . . . . .			see note 3
Grid 1 voltage:			
negative bias* . . . . .	0	250	V
positive peak* . . . . .	—	2.0	V
Cathode voltage (negative value) . . . . .	—	6.0	kV
Peak heater to cathode voltage . . . . .	—	125	V
Cathode current (peak) . . . . .	—	1.0	mA
Grid to cathode circuit impedance . . . . .	—	1.0	MΩ

### Flood Gun

	Min	Max	
Heater voltage . . . . .	28	32	V
Viewing screen voltage (see note 4) . . . . .	—	12	kV
Backing electrode voltage (peak) (see note 5) . . . . .	—	20	V
Grid 4 (collector mesh) voltage . . . . .	—	300	V
Grid 3 voltage . . . . .	—	300	V
Grid 3A voltage . . . . .	—	300	V
Grid 2 voltage . . . . .	—	200	V
Grid 2A voltage . . . . .	—	200	V
Grid 1 voltage . . . . .	—	50	V
Grid 1A voltage . . . . .	—	10	V
Grid shield voltage (negative value) . . . . .	—	75	V
Heater to cathode voltage (see note 1) . . . . .	—	0	V

\* With respect to Writing Gun Cathode.

## TYPICAL OPERATION

All voltages are with respect to flood gun cathode unless otherwise stated.

### WRITING GUN

#### Operational Conditions

Grid 4 voltage (see note 3)	0	V
Grid 3 voltage (normal range for focus)*	200 to 600	V
Grid 2 voltage (see note 3)	0	V
Grid 1 voltage (normal range for writing beam cut-off)*	-85 to -150	V
Cathode voltage	-5000	V max

#### Typical Performance

Writing beam current	see curves on page 9
Cathode current	see curves on page 9
Stored writing speed	see curves on page 10 and 11

### FLOOD GUN

#### Operational Conditions

Screen voltage (see note 4)	10	kV max
Backing electrode d.c. voltage	5.0	V
Erase pulse amplitude for screen cut-off (normal range)	3.0 to 5.0	V
Grid 4 (collector mesh) voltage	250	V
Grid 3A voltage (normal range, see note 6)	200 to 250	V
Grid 3 voltage (normal range, see note 6)	70 to 120	V
Grid 2A voltage (normal range, see note 6)	20 to 60	V
Grid 2 voltage (normal range, see note 6)	60 to 140	V
Grid 1A voltage (normal range, see note 6)	0 to 10	V
Grid 1 voltage (normal range, see note 6)	0 to 10	V
Shield voltage (normal range, see note 6)	0 to -60	V
Cathode voltage	0	V
Backing electrode supply impedance	1500	$\Omega$ max

\* With respect to Writing Gun Cathode.

## Typical Performance

Viewing screen current for full brightness all over screen . . . . .	2.0	mA max
Grid 4 current . . . . .	3.5	mA max
Grid 3A current . . . . .	1.5	mA max
Grid 3 current . . . . .	0.5	mA max
Grid 2A current . . . . .	2.0	mA max
Grid 2 current . . . . .	2.0	mA max
Grid 1A current . . . . .	10	mA max
Grid 1 current . . . . .	0.5	mA max
Shield current . . . . .	0.1	mA max
Cathode current . . . . .	15	mA max
Maximum screen luminance (at the centre) . . . . .	1000	ft-lambert
	3430	cd/m <sup>2</sup>
Viewing time (see note 7) . . . . .	60	s min
Stored line width . . . . .	see note 8 and curves on page 10	
Peak line brightness . . . . .	see note 8 and curves on page 11	

## NOTES

1. The writing gun cathode is operated at a potential of  $-5.0\text{kV}$ ; the writing gun heater supply should therefore be adequately insulated.

A d.c. supply should be used for the flood gun heater, with the negative side connected externally to the flood gun cathode via a  $4.7\text{k}\Omega$  resistor.

2. To prevent the possibility of runaway charging of the storage mesh surface, flood gun operation must be established before the writing gun e.h.t. is applied.

The flood gun heater is a relatively massive structure and the gradual application of the full heater voltage is recommended, via a thermistor for example.

Care must be taken when switching the tube on and off to ensure that the writing gun is so biased that heavy writing, which might damage the storage mesh or the screen, cannot occur.

3. Grid 4 and grid 2 (writing gun) are connected internally to flood gun cathode.
4. The viewing screen supply impedance must lie between  $0.3$  and  $1.0\text{M}\Omega$ .

- 
5. Except when the Clearance Procedure is being used; see General Instructions, Pulse Erasure Part (c) on pages 7 and 8.
  6. The 'Normal Ranges' given are the specification limits. Each tube is accompanied by a sheet specifying the voltages required to give optimum performance on test for the particular tube. These voltages will be within the specification limits shown. The test values supplied should be used when setting up the tube initially, but some slight adjustment may be necessary to optimize the display uniformity for a particular application.
  7. The viewing time is the time taken for any area of the screen of 6cm minimum diameter to reach an average brightness of 10% of the maximum light output for that area, immediately after the tube has been erased to just black.

The specification limit for viewing time is 60 seconds minimum. Longer viewing times can be obtained by erasing beyond black or pulsing the flood gun above flicker frequency, but with a reduction in writing speed and brightness respectively.

8. The typical stored line width and peak line brightness characteristics given on pages 10 and 11 were measured at the centre of the display area after erasing to just black and writing a single field of a raster of widely spaced lines at the stated modulator drives and writing speeds.

## **GENERAL INSTRUCTIONS**

### **Handling**

The tube should be transported screen upwards to prevent particles falling on the storage elements. It should be handled with care to avoid damage to the metal seals.

### **Magnetic Shielding**

Because of the low voltage of the flood gun beam, it is essential to shield the whole of the viewing section from magnetic fields; shielding of the writing gun is also advisable. Details of suitable Mumetal shields are available from English Electric Valve Company Ltd.

## Demagnetization

Although the carrying pack contains magnetic shielding, the tube may become magnetized during transportation and this will cause severe non-uniformity of the display. In this event English Electric Valve Company should be consulted.

## Pulse Erasure

(a) The speed of erasure is controlled by the adjustment of the pulse width in conjunction with the pulse repetition rate, which should be sufficiently high to prevent flicker, and preferably in the range between 200 and 1000 pulses per second. By increasing the pulse length or the pulse repetition rate, the erasure time may be reduced proportionately. The pulse amplitude also alters the erase rate but primarily determines the final potential to which the storage mesh is driven in the absence of writing. Normally a pulse amplitude two to three times the manual erase value is applied, which gives an approximately uniform rate of erasure for visible signals but tends to suppress small non-integrating signals such as noise. A much lower pulse amplitude must be used if the grey scale is to be preserved with no loss of information.

(b) If it can be conveniently arranged for the screen h.t. to be switched off simultaneously with either manual or pulse train erase then two advantages will ensue:

- (i) Contrast during pulse train erase will improve.
- (ii) The time taken for erasure will decrease.

(c) The normal erasure procedure may be inadequate or ineffective under the following conditions:

- (i) When writing beam electrons have penetrated the surface of the storage insulator and have built up charges within it. Low velocity beam electrons cannot neutralize these charges and after the normal erasure procedure has been carried out the original screen image may still be faintly visible as the background illumination increases.
- (ii) When parts of the storage mesh surface are driven so positive that the number of secondary electrons produced by the flood beam exceeds those arriving at the surface. This condition is known as runaway charging and can occur when a pulse exceeding 20 volts in amplitude

is applied to the backing electrode. It can also occur when an excessively high writing charge is deposited, e.g. with a stationary spot or line and particularly when writing takes place in the absence of flood beam current. Damage may be done to the storage mesh if this fault is not quickly corrected.

Both faults can be corrected by operating a switch to disconnect the backing electrode from its supply and connecting it to the flood gun grid 4 through a protective resistor; this switch must make and break quickly and need be operated once only. The screen should then be at uniform full brightness and normal erasure will prepare the tube for operation. Care should be taken to ensure that this switch cannot be left in the 'on' condition. This procedure is known as clearance.

The clearance procedure may be carried out automatically prior to each complete erasure if required.

### **Deflection Supplies**

Any failure of the deflection drive that may result in the production of a stationary spot or line may cause runaway charging, even with the flood beam on. Provision should be made for automatically cutting off the writing gun beam in the event of any such failure.

### **Mesh Tension**

Any effect due to a reduction of mesh tension which may be evident soon after first switch-on will not be noticeable after an initial warm-up period and will not noticeably reappear when the tube is switched on again after a period of up to 24 hours switched off i.e. when used on a normal daily duty cycle.

# TYPICAL WRITING GUN CHARACTERISTIC

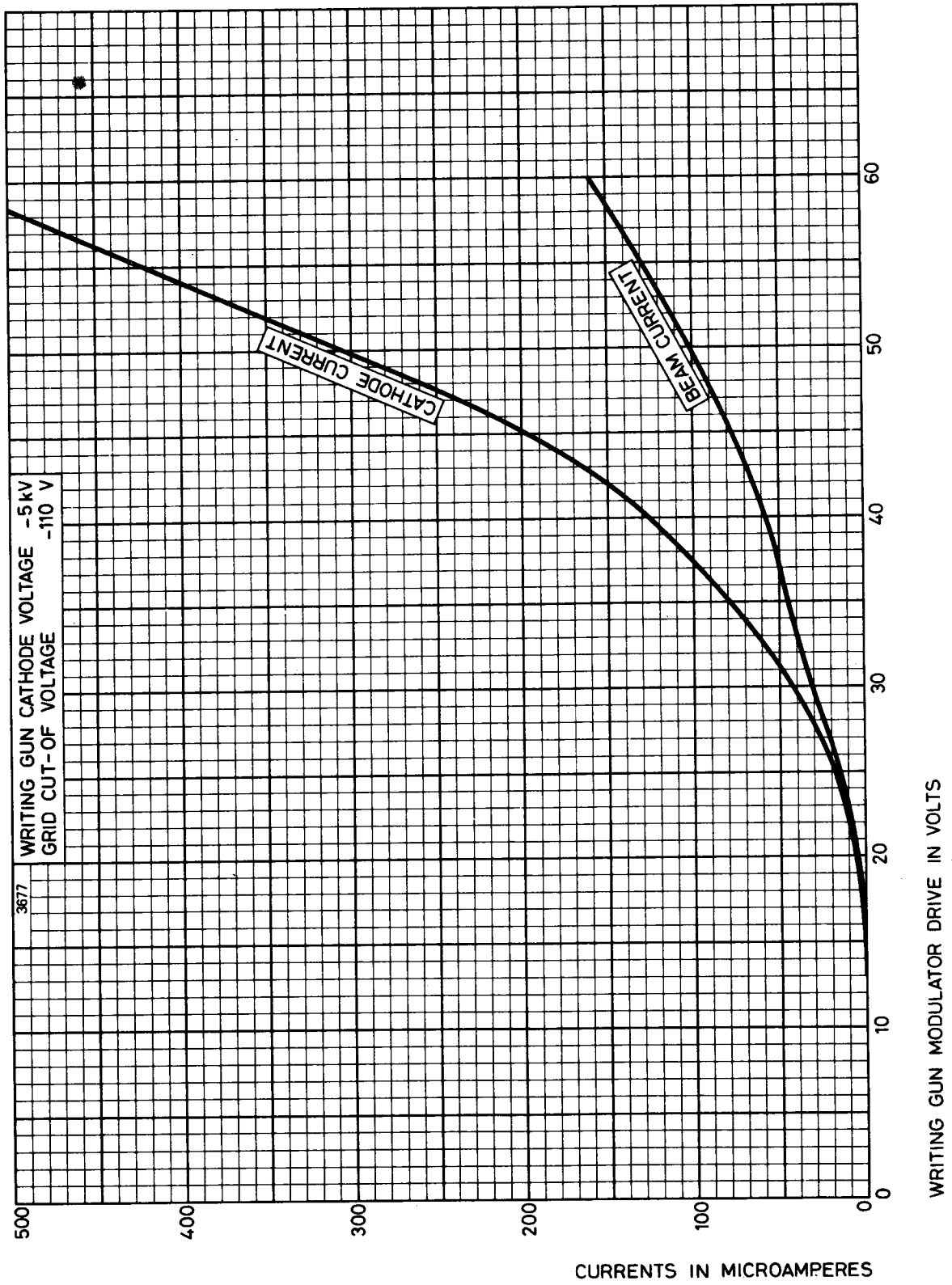

**TYPICAL SINGLE SHOT STORED LINE WIDTH CHARACTERISTICS**  
 See Note 8 on page 6

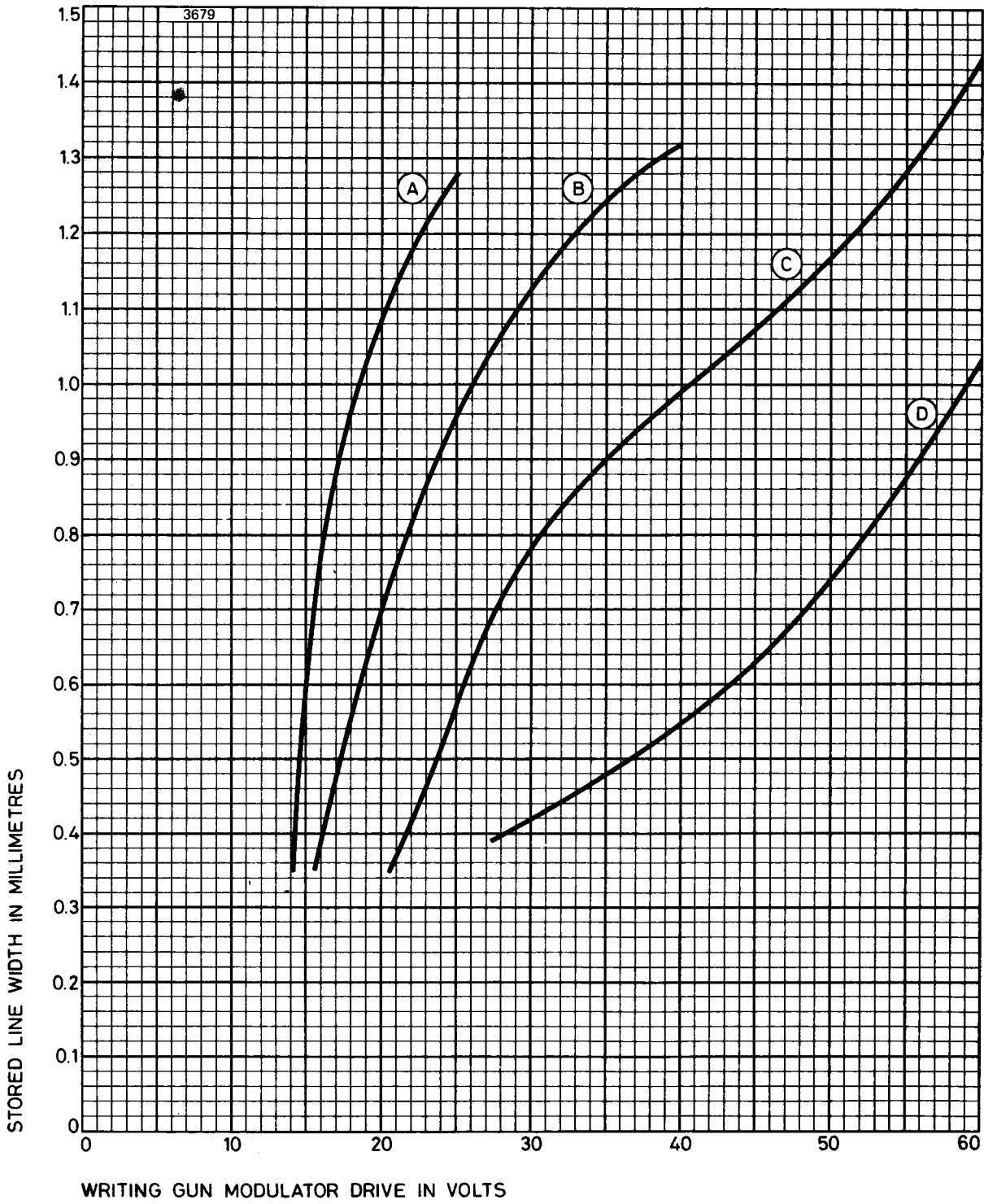

Curve	Writing Speed (inch/second)
A	$2.5 \times 10^3$
B	$1.0 \times 10^4$
C	$5.0 \times 10^4$
D	$2.5 \times 10^5$



**TYPICAL PEAK LINE BRIGHTNESS CHARACTERISTICS**  
 See Note 8 on page 6

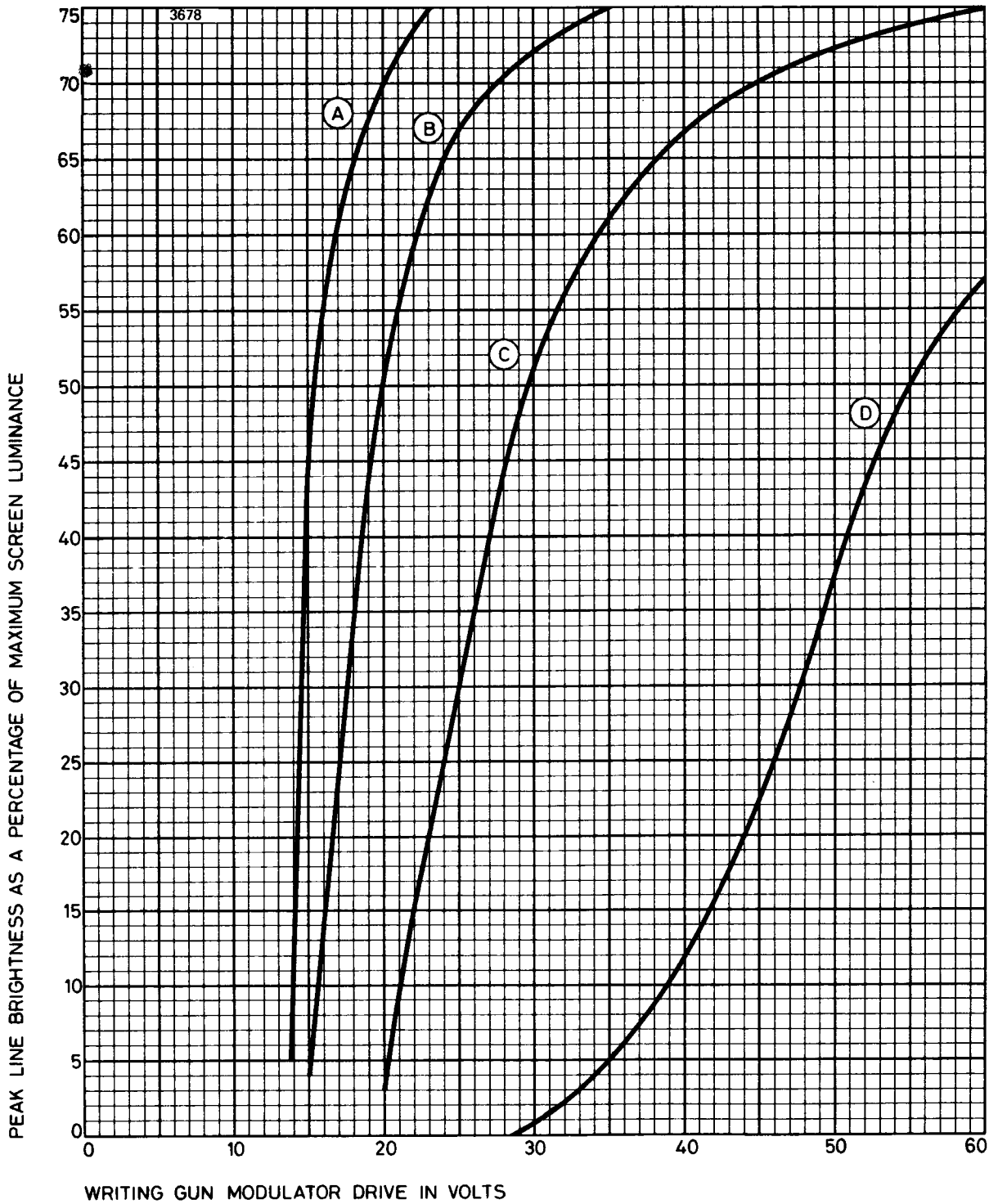

Curve	Writing Speed (inch/second)
A	$2.5 \times 10^3$
B	$1.0 \times 10^4$
C	$5.0 \times 10^4$
D	$2.5 \times 10^5$

# TYPICAL SPECTRAL OUTPUT CHARACTERISTIC

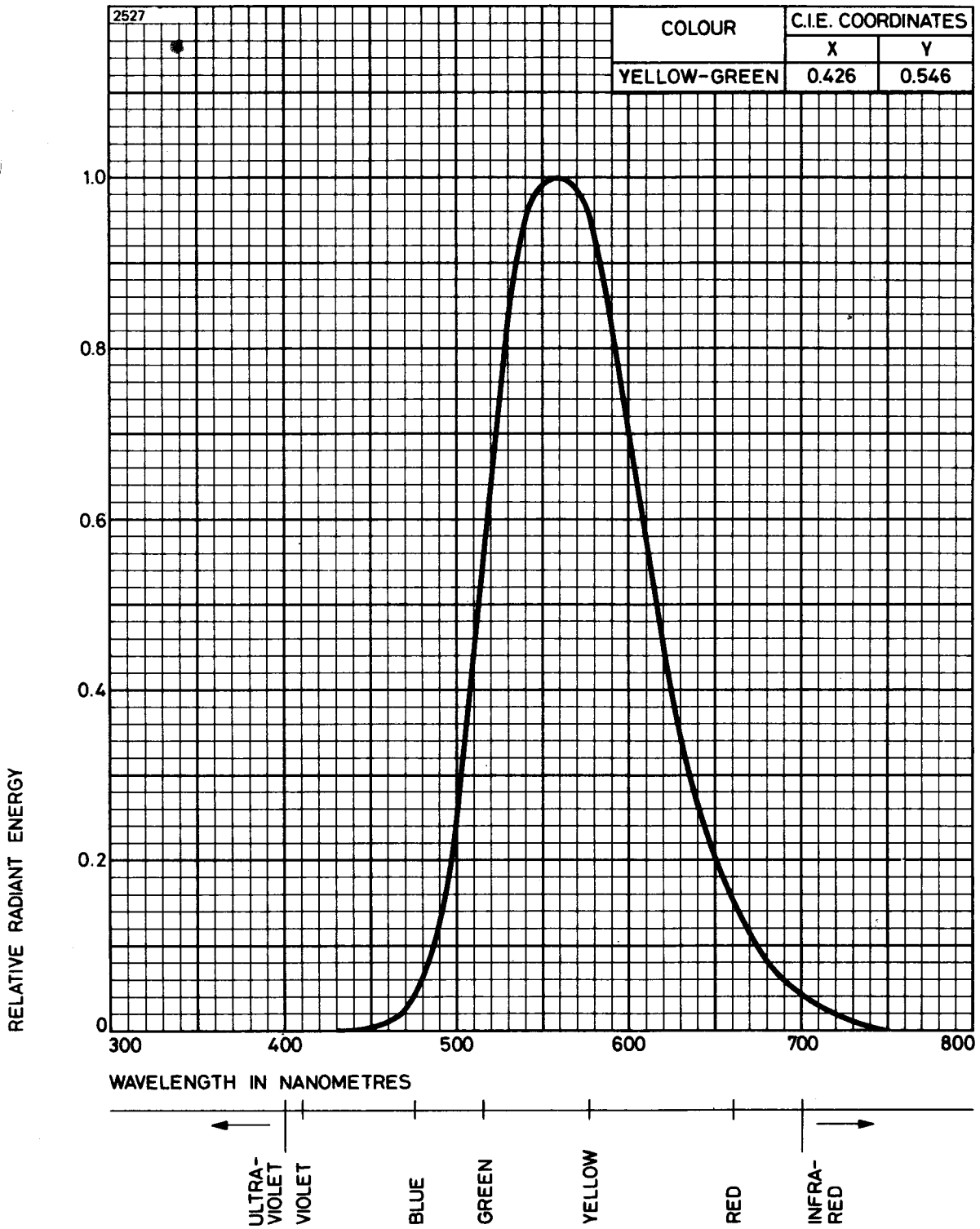

# OUTLINE

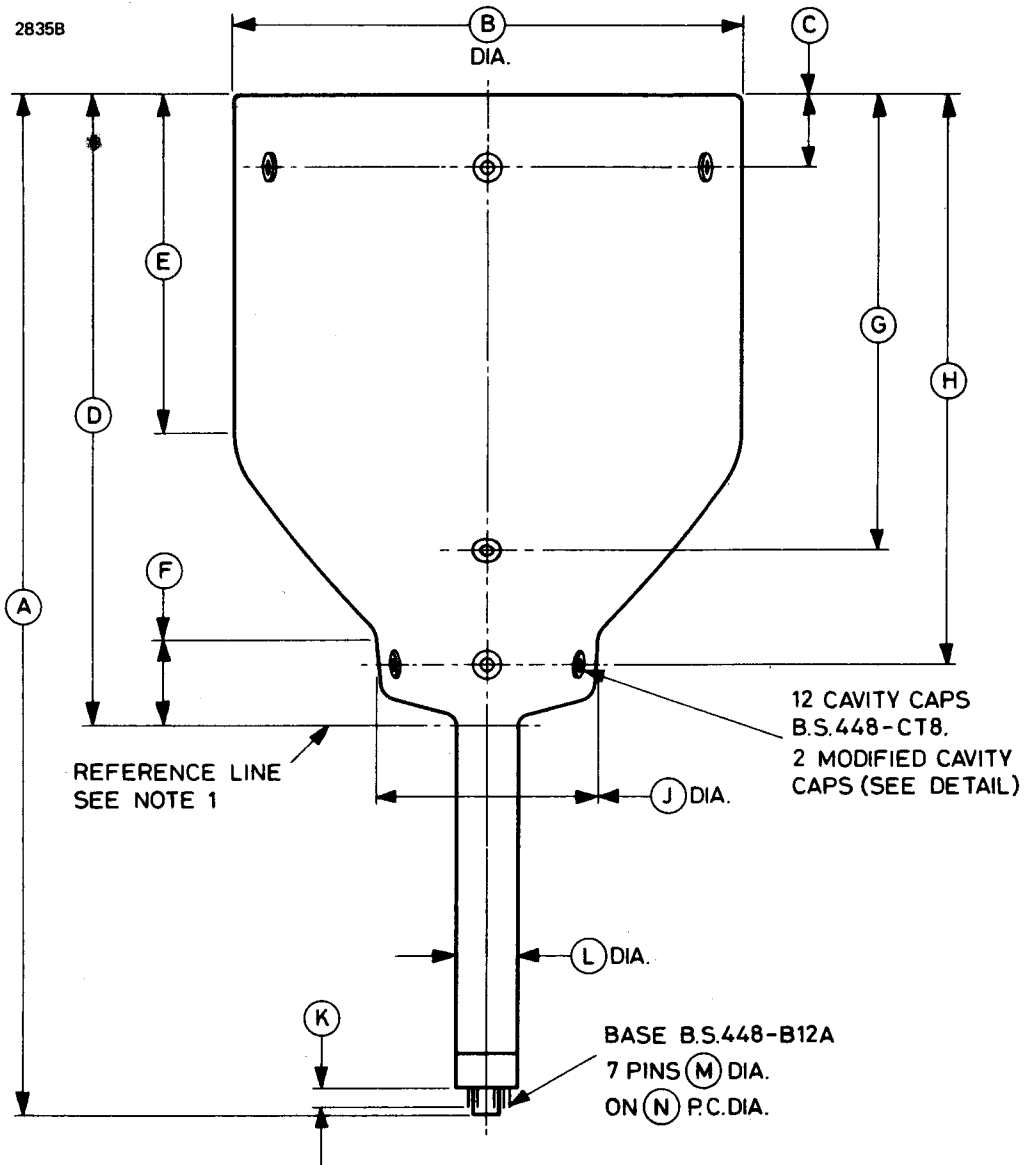

Ref	Millimetres	Inches	Ref	Millimetres	Inches
A	560.0 ± 15.0	22.05 ± 0.59	J	120.0 ± 5.0	4.724 ± 0.197
B	280.0 ± 4.0	11.02 ± 0.16	K*	11.35 max	0.447 max
C	40.0 ± 6.0	1.575 ± 0.236	L	35.5 max	1.398 max
D	350.0 ± 15.0	13.78 ± 0.59	M*	2.362 ± 0.076	0.093 ± 0.003
E	205.0 max	8.07 max	N*	27.00	1.063
F	44.0 ± 3.0	1.732 ± 0.118	AA	9.0 ± 0.5	0.354 ± 0.020
G	250.0 ± 15.0	9.843 ± 0.590	AB	1.5 ± 0.1	0.059 ± 0.004
H	315.0 ± 15.0	12.40 ± 0.59			

Inch dimensions have been derived from millimetres except where indicated thus \*.

## Cavity Cap Connections (See Note 2)

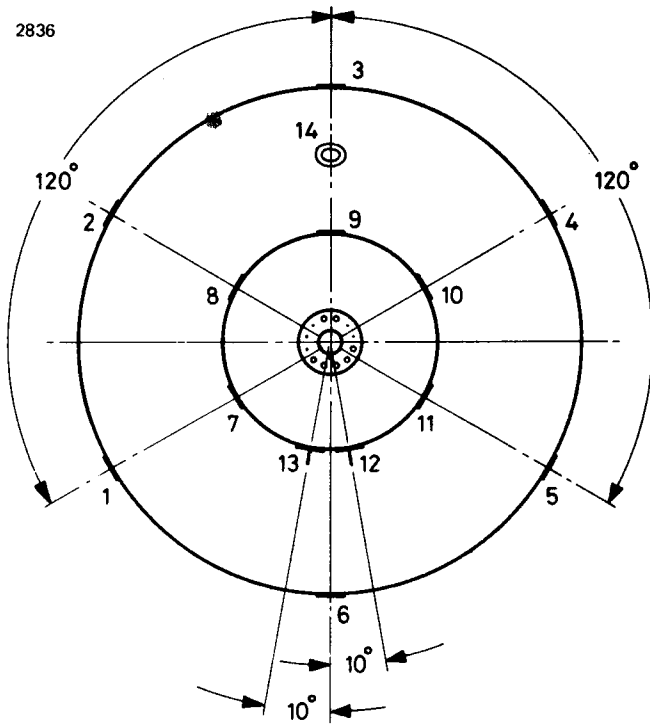

## Detail of Caps 12 and 13

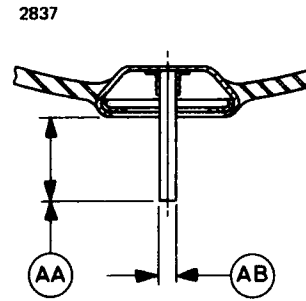

Cavity Cap	Element
1	Grid 3A (flood gun)
2	Grid 4 (flood gun)
3	Internal connection
4	Backing electrode
5	Grid 3 (flood gun)
6	Screen
7	Cathode (flood gun), grid 2 (writing gun), grid 4 (writing gun)

Cavity Cap	Element
8	Grid 2 (flood gun)
9	Shield (flood gun)
10	Grid 1A (flood gun)
11	Grid 1 (flood gun)
12	Heater (flood gun) negative
13	Heater (flood gun) positive
14	Grid 2A (flood gun)

### Outline Notes

1. The reference line is defined by a ring gauge 36.0mm internal diameter.
2. The cavity caps to be within  $3^\circ$  of the angular positions indicated.

## Base Connections

2838

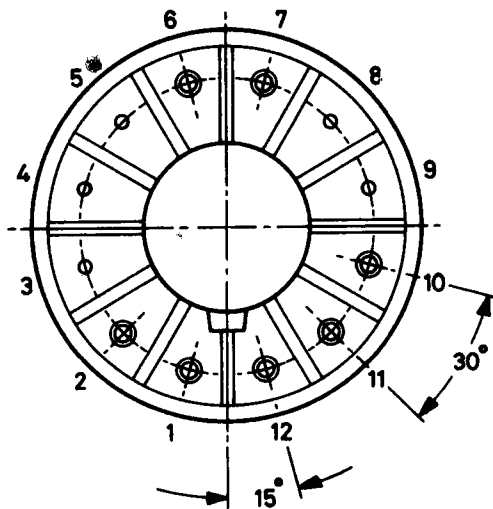

Pin	Element
1	Heater (writing gun)
2	Grid 1 (writing gun)
3	No pin
4	No pin
5	No pin
6	No connection
7	No connection
8	No pin
9	No pin
10	Grid 3 (writing gun)
11	Cathode (writing gun)
12	Heater (writing gun)

**Note** The base key will be in line with cavity cap 6 within 15°.



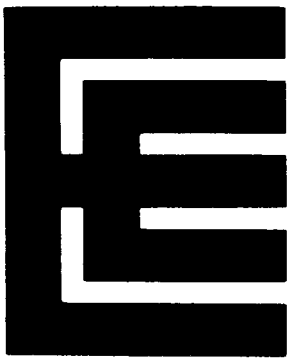

## DIRECT VIEW STORAGE TUBE

**Service Type CV9422**

The data should be read in conjunction with the Storage Tube Preamble.

### INTRODUCTION

The E713B is a direct view storage tube with a useful viewing screen diameter of 4 inches (102mm). It is of ruggedized construction and is designed to provide very bright displays of information ranging from single transients and recurrent waveforms to half tone pictures. The writing gun beam is magnetically deflected. E713B is particularly suitable for the daylight viewing of radar displays and is recommended for airborne and other applications where vibration and low pressure conditions may be encountered.

The tube has two electron guns, one for writing the signal on to the storage surface and the other, the flood gun, for displaying written information on the viewing screen. The writing gun is similar to that in a conventional cathode ray tube, except that it need only be operated for a single trace. In writing, a charge pattern is deposited on the storage surface, which consists of an insulator coating on a metal mesh (the backing electrode). Low velocity electrons from the flood gun approach the storage mesh normally and at constant current density over the useful area. They penetrate the mesh in those areas where a charge pattern has been written, the number doing so being determined by the amount of charge deposited, and are then accelerated to the viewing screen where they produce an image.

Since the flood gun is normally continuously operative, the image on the viewing screen persists without deterioration for about one minute and is visible for periods up to ten minutes. Extended storage periods may be obtained by switching off the flood beam until viewing is required, provided that no writing takes place while the flood gun is inoperative. The image can be completely erased in a fraction of a second by applying a small positive pulse to the backing electrode and controlled persistence can be obtained by varying the duration of shorter repetitive pulses.

## GENERAL

### Electrical and General

	Writing Gun	Flood Gun	
Cathodes, indirectly heated, oxide coated . . . . .	one	one	
Heater voltage . . . . .	6.3	6.3	V
Heater current . . . . .	0.6	0.6	A
Cathode heating time (minimum) . . . . .	see note 1	45	s
Inter-electrode capacitances:			
cathode to all other electrodes . . . . .	4.0	—	pF
grid 1 to all other electrodes . . . . .	7.0	—	pF
writing gun grid 1 to writing gun cathode* . . . . .	1.5	—	pF
backing electrode to all other electrodes . . . . .	—	66	pF
screen to all other electrodes . . . . .	—	32	pF
Focus method . . . . .	electrostatic	electrostatic	
Deflection method . . . . .	magnetic	none	
Phosphor . . . . .	—	aluminized P20	
Fluorescent colour (see spectral characteristic) . . . . .		yellow-green	

### Mechanical

Overall length . . . . .	12.187 inches (309.6mm) max
Overall diameter (excluding flexible lead) . . . . .	5.635 inches (143.1mm) max
Bulb diameter . . . . .	5.300 inches (134.6mm) max
Useful viewing screen diameter . . . . .	4.000 inches (101.6mm) min
Net weight . . . . .	2 pounds (0.9kg) approx
Mounting position (see note 2) . . . . .	any, except with base up and with the tube axis at an angle less than 20° from vertical
Connections:	
writing gun . . . . .	flexible leads
flood gun . . . . .	flexible leads
Bulb cavity caps (five) . . . . .	B.S.448-CT8 (JEDEC no. J1-21)
Viewing screen connection . . . . .	flexible lead

\* With all other electrodes earthed



## MAXIMUM AND MINIMUM RATINGS (Absolute values)

No individual rating should be exceeded

All voltages are with respect to the flood gun cathode unless otherwise stated

### Writing Gun

	Min	Max	
Heater voltage . . . . .	6.0	6.6	V
Grid 4 voltage . . . . .			see note 3
Grid 3 voltage (negative value) . . . . .	—	2000	V
Grid 2 voltage . . . . .	—	200	V
Grid 1 voltage:			
negative bias* . . . . .	0	200	V
positive peak* . . . . .	—	2.0	V
Cathode voltage (negative value) . . . . .	—	2300	V
Peak heater to cathode voltage:			
heater positive with respect to cathode . . . . .	—	125	V
heater negative with respect to cathode . . . . .	—	125	V
Cathode current (peak) . . . . .	—	1.0	mA
Grid to cathode circuit impedance . . . . .	—	1.0	MΩ

### Flood Gun

	Min	Max	
Heater voltage . . . . .	6.0	6.6	V
Viewing screen voltage . . . . .	—	12	kV
Backing electrode voltage (peak) (see note 4) . . . . .	—	20	V
Grid 4 (collector mesh) voltage . . . . .	—	300	V
Grid 3A voltage . . . . .	—	300	V
Grid 3 voltage . . . . .	—	300	V
Grid 2 voltage (see note 3) . . . . .	—	150	V
Grid 1 voltage . . . . .	—	150	V
Peak heater to cathode voltage:			
heater positive with respect to cathode . . . . .	—	125	V
heater negative with respect to cathode . . . . .	—	125	V
Cathode current . . . . .	—	10	mA
Viewing screen dissipation . . . . .	—	6.0	W
Backing electrode supply impedance . . . . .	—	5000	Ω
Viewing screen supply impedance (see note 5) . . . . .	1.0	5.0	MΩ

\* With respect to Writing Gun Cathode.

## TYPICAL OPERATION

All voltages are with respect to the flood gun cathode unless otherwise stated

### WRITING GUN

#### Operational Conditions

Grid 4 voltage . . . . .		see note 3
Grid 3 voltage (usual range for focus)* . . . . .	400 to 700	V
Grid 2 voltage . . . . .	0	V
Grid 1 voltage (range for writing beam cut-off)* . . . . .	-30 to -55	V
Cathode voltage . . . . .	-1800	V

#### Typical Performance

Writing beam current (50V modulation) (see note 6) . . . . .	45	$\mu$ A
Cathode current (50V modulation) (see note 6) . . . . .	550	$\mu$ A

### FLOOD GUN

#### Operational Conditions

Screen voltage . . . . .	10	kV
Backing electrode d.c. voltage . . . . .	5.0	V
Erase pulse amplitude for screen cut-off (see notes 7 and 8) . . . . .	3.9	V
Grid 4 (collector mesh) voltage . . . . .	225	V
Grid 3A voltage . . . . .	150	V
Grid 3 voltage (see note 9) . . . . .	65	V
Grid 2 voltage (see note 3) . . . . .	70	V
Grid 1 voltage . . . . .	30	V
Cathode voltage . . . . .	0	V

#### Typical Performance

Screen current for full brightness . . . . .	0.4	mA
Cathode current . . . . .	3.75	mA
Screen luminance (see note 10) . . . . .	1800	ft-lamberts
	6170	cd/m <sup>2</sup>
Viewing time (see note 11) . . . . .	20	s min

\* With respect to Writing Gun Cathode.

## NOTES

1. To prevent the occurrence of transients when switching on or off, the writing gun heater voltage may be applied simultaneously with, or after, the other writing gun voltages, and switched off before these voltages are removed, provided the writing gun is biased to beyond cut-off.
2. Two silicone rubber rings are bonded to the bulb (see outline drawing) and these provide means for positive location of the tube in equipment.
3. Grid 4 (writing gun) is internally connected to grid 2 (flood gun).
4. Except when the faults mentioned under Pulse Erasure, part (c), of the General Instructions on pages 6 and 7 are being corrected.
5. The viewing screen supply impedance should be less than  $5M\Omega$  to prevent excessive changes in screen voltage during erasure.
6. Writing is a charge deposition process and the current required for a given brightness level is proportional to the writing speed and inversely proportional to the number of times the information is written in one place.
7. With manual erasure (approximately 1 second) and the screen voltage simultaneously removed.
8. Maximum screen brightness is obtained when the storage mesh surface has stabilized at approximately zero potential, i.e. flood gun cathode potential. The application of a positive manual erase pulse to the backing electrode produces a corresponding positive increase in the storage mesh surface potential. This surface potential is reduced to near flood gun cathode potential by flood beam electrons. When the erase pulse is removed the surface acquires a negative potential relative to that at full brightness and equal in value to the erase pulse amplitude.
9. To achieve collimation of the flood beam, the voltages applied to the flood gun grids 2, 3, 3A and 4 should be preset to the fixed values given on page 4. The voltage of grid 1 should then be adjusted to just give maximum uniform display over the screen. The voltage of grid 3 should be adjusted to give the most uniform erasure when a train of erasing pulses is applied to the backing electrode. Slight readjustment of grid 1 and grid 3A voltages may assist in obtaining the most uniform erasure.
10. The meter used for measuring screen luminance has been corrected to the frequency response of the human eye.

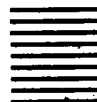

11. Time for background to rise from cut-off to 10% of maximum brightness. An increase in viewing time can be obtained by switching off the flood beam by pulses at a frequency sufficiently high to prevent flicker, the apparent brightness of the display being proportionately reduced.

## **GENERAL INSTRUCTIONS**

### **Handling**

The tube should be transported screen upwards to prevent particles falling on the storage elements. It should be handled with care to avoid damage to the metal seals and the encapsulated screen lead.

### **Pulse Erasure**

(a) The speed of erasure is controlled by the adjustment of the pulse duration in conjunction with the pulse repetition rate, which should be sufficiently high to prevent flicker, and preferably in the range between 100 and 2000 pulses per second. By increasing the pulse duration or the pulse repetition rate, the erasure time may be reduced proportionately. The pulse amplitude also alters the erase rate but primarily determines the final potential to which the storage mesh is driven in the absence of writing. Normally a pulse amplitude two to three times the manual erase value is applied, which gives an approximately uniform rate of erasure for visible signals but tends to suppress small non-integrating signals such as noise. A much lower pulse amplitude must be used if the grey scale is to be preserved with no loss of information.

(b) If it can be conveniently arranged for the screen h.t. to be switched off simultaneously with either manual or pulse train erase then two advantages will ensue:

- (i) Contrast during pulse train erase will improve.
- (ii) The time taken for erasure will decrease.

(c) The normal erasure procedure may be inadequate or ineffective under the following conditions:

- (i) When writing beam electrons have penetrated the surface of the storage insulator and have built up charges within it. Low velocity flood beam electrons cannot neutralize these charges and after the normal erasure procedure has been carried out the original screen image may still be faintly visible as the background illumination increases.

- (ii) When parts of the storage mesh surface are driven so positive that the number of secondary electrons produced by the flood beam exceeds those arriving at the surface. This condition is known as runaway charging and can occur when a pulse exceeding 20 volts in amplitude is applied to the backing electrode. It can also occur when an excessively high writing charge is deposited, e.g. with a stationary spot or line and particularly when writing takes place in the absence of flood beam current. Damage may be done to the storage mesh if this fault is not quickly corrected.

Both faults can be corrected by operating a switch to disconnect the backing electrode from its supply and connecting it to the flood gun grid 4 through a protective resistor; this switch must make and break quickly and need be operated once only. The screen should then be at uniform full brightness and normal erasure will prepare the tube for operation. Care should be taken to ensure that this switch cannot be left in the 'on' condition. The above procedure is known as 'clearance'.

### **Flood Gun**

To prevent the occurrence of runaway charging, the flood gun beam must always be operative before the writing gun supplies are switched on.

### **Writing Gun**

The writing gun cathode is operated at a potential in the region of  $-1.5$  to  $-2.3$  kV; consequently the heater supply should be adequately insulated. The cathode supply must be free from ripple to prevent modulation of the writing beam and have good stability to maintain constant modulation depth and focus.

Care should be taken to prevent heavy transient writing beam currents when switching on. The writing beam should be adjusted so that the highlight brightness of the display is not saturated as this will result in a rapid deterioration in resolution.

### **Deflection Supplies**

Any failure of the deflection drive that may result in the production of a stationary spot or line may cause runaway charging, even with the flood beam on. Provision should be made for automatically cutting off the writing gun beam in the event of any such failure.

# TYPICAL SPECTRAL OUTPUT CHARACTERISTIC FOR P20 PHOSPHOR

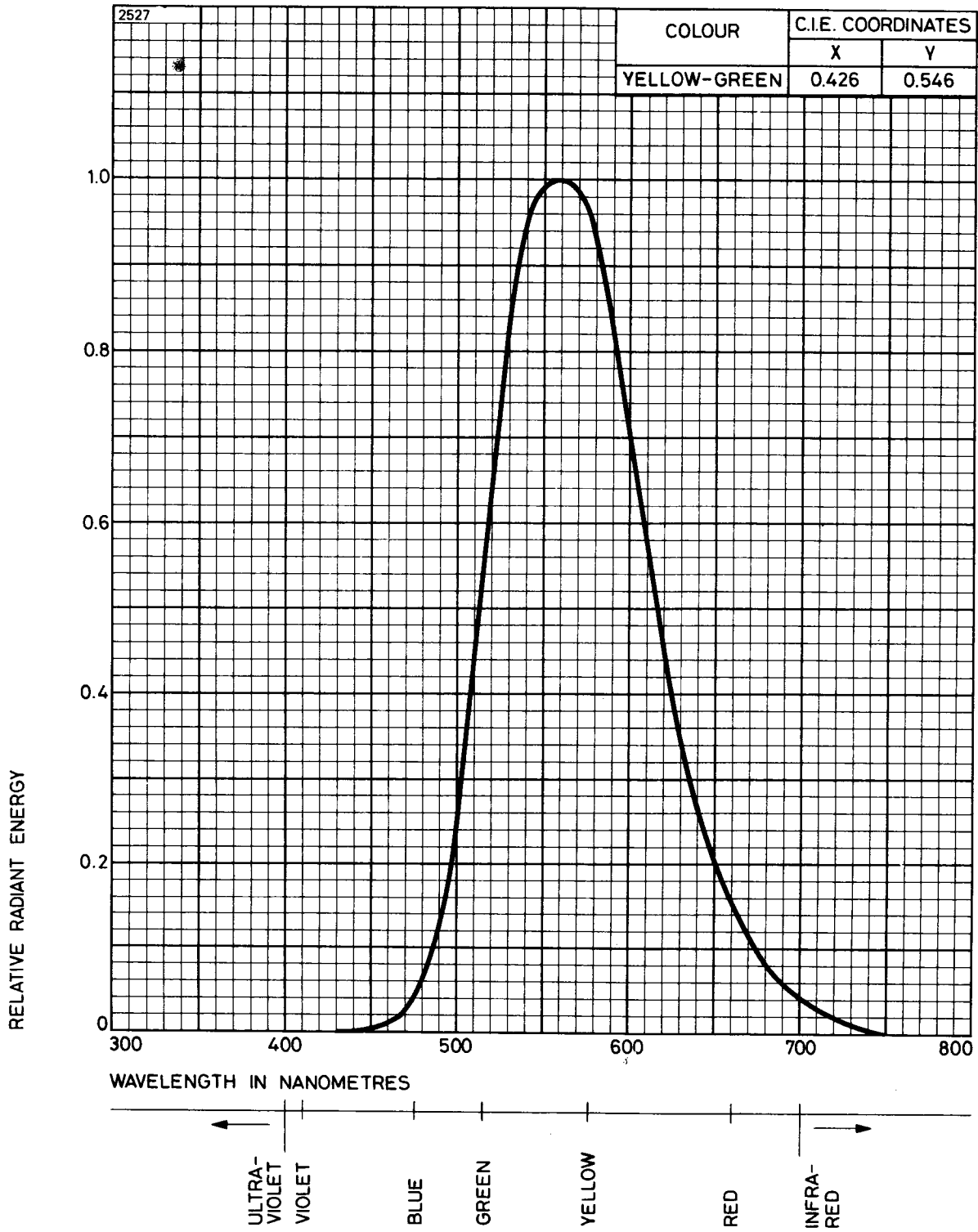

**OUTLINE (See page 11 for dimensions)**

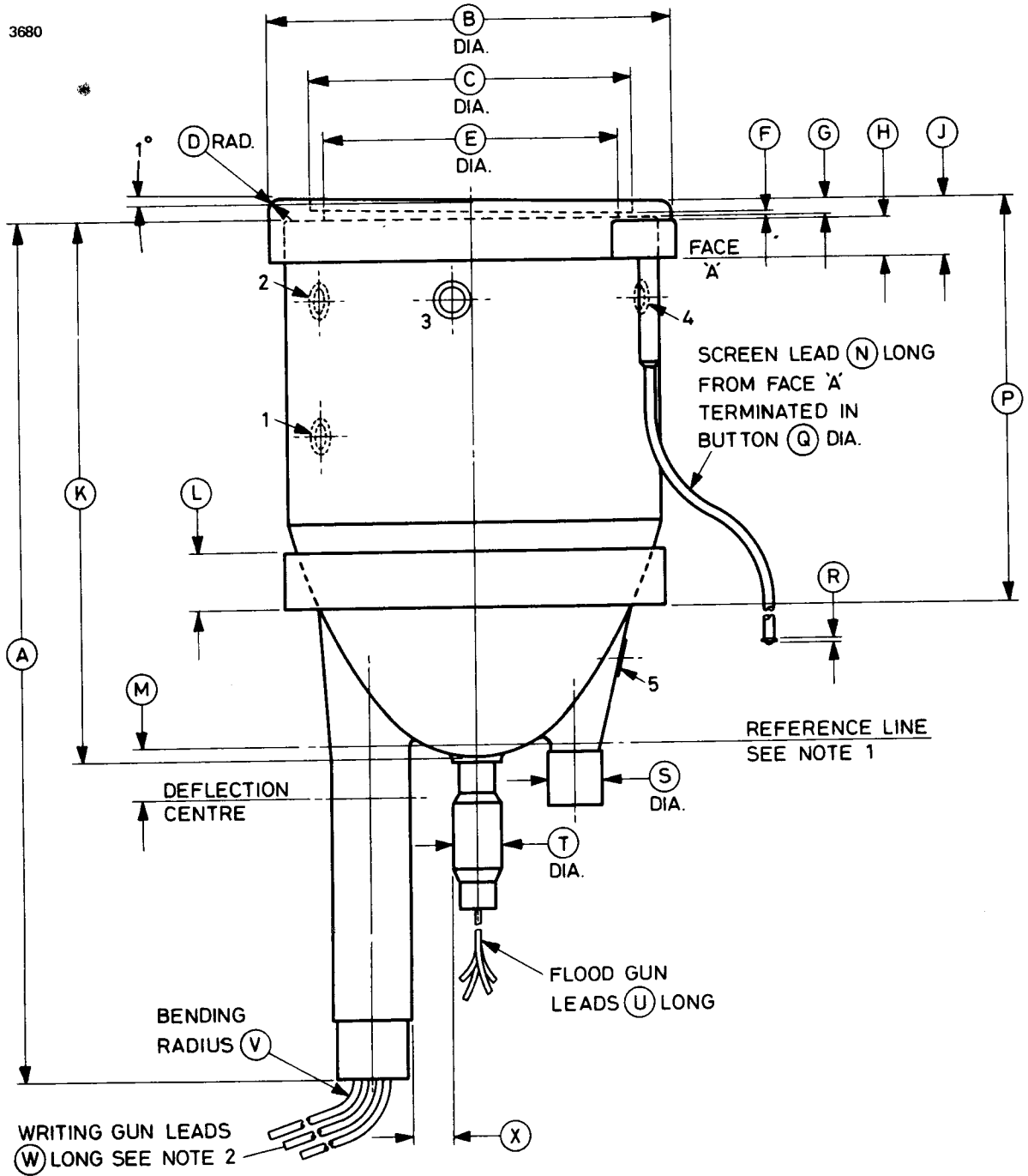

**Outline Notes**

1. The reference line is defined by the position of the end of the gauge shown on page 11.
2. The leads to the writing gun are tinned copper wire, 0.50mm<sup>2</sup>, stranded 16/0.20mm, silicone rubber insulated to 3.20mm diameter.

# OUTLINE

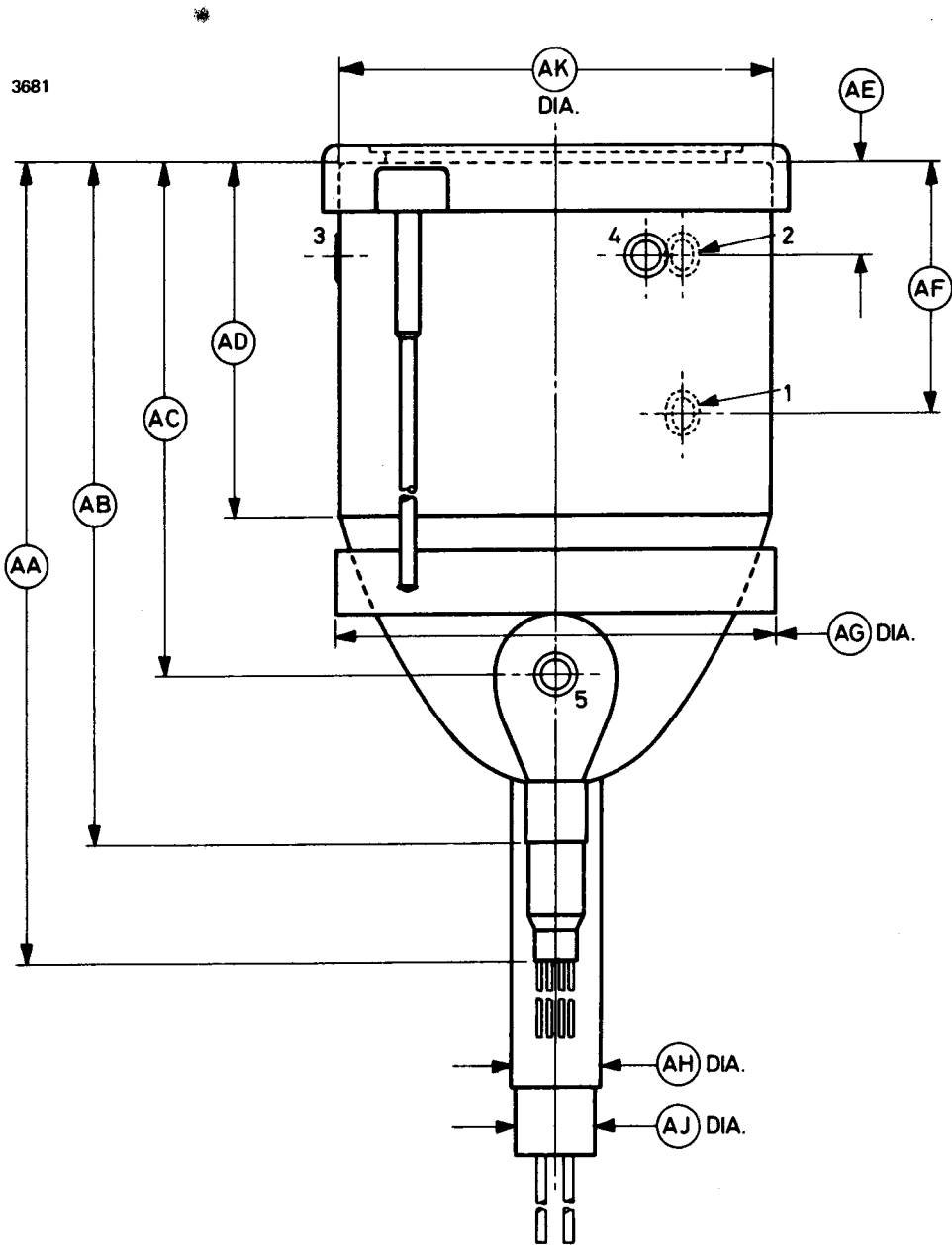



## Outline Dimensions

Ref	Inches	Millimetres	Ref	Inches	Millimetres
A	12.000 max	304.8 max	U	8.000 min	203.2 min
B	5.625 $\begin{smallmatrix} + 0.010 \\ - 0.020 \end{smallmatrix}$	142.9 $\begin{smallmatrix} + 0.25 \\ - 0.51 \end{smallmatrix}$	V	0.250 min	6.35 min
C	4.525 $\pm 0.010$	114.9 $\pm 0.25$	W	6.000 min	152.4 min
D	0.187	4.75	X	0.562 min	14.27 min
E	4.125 $\pm 0.030$	104.8 $\pm 0.76$	AA	9.625 max	244.5 max
F	0.040 $\pm 0.005$	1.02 $\pm 0.13$	AB	8.187 max	208.0 max
G	0.165 $\pm 0.015$	4.19 $\pm 0.38$	AC	6.125 $\pm 0.250$	155.6 $\pm 6.35$
H	0.563 max	14.30 max	AD	4.250 $\pm 0.250$	108.0 $\pm 6.35$
J	0.800 $\pm 0.050$	20.32 $\pm 1.27$	AE	1.125 $\pm 0.125$	28.58 $\pm 3.18$
K	7.500 max	190.5 max	AF	3.000 $\pm 0.375$	76.20 $\pm 9.53$
L	0.800 $\pm 0.050$	20.32 $\pm 1.27$	AG	5.300 $\begin{smallmatrix} + 0.010 \\ - 0.020 \end{smallmatrix}$	134.6 $\begin{smallmatrix} + 0.25 \\ - 0.51 \end{smallmatrix}$
M	0.750	19.05	AH	1.055 max	26.80 max
N	12.125 $\pm 0.250$	308.0 $\pm 6.35$	AJ	1.010 $\pm 0.010$	25.65 $\pm 0.25$
P	5.625 $\pm 0.150$	142.9 $\pm 3.8$	AK	5.250	133.4
Q	0.188	4.78	AN	0.625 max	15.88 max
R	0.063	1.60	AP	0.625 max	15.88 max
S	0.750 max	19.05 max	AQ	1.500 $\pm 0.063$	38.10 $\pm 1.60$
T	0.688 max	17.48 max	AR	1.375 $\pm 0.063$	34.93 $\pm 1.60$

Millimetre dimensions have been derived from inches.

## Reference Line Gauge

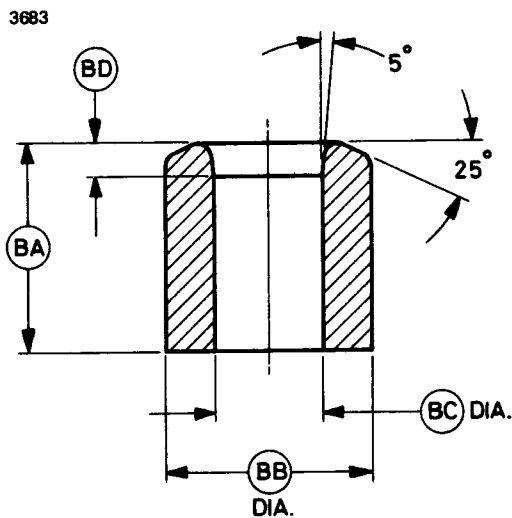

Ref	Inches	Millimetres
BA	2.000 $\pm 0.010$	50.80 $\pm 0.25$
BB	2.000 $\pm 0.010$	50.80 $\pm 0.25$
BC	1.055	26.80
BD	0.312	7.92

Millimetre dimensions have been derived from inches.

## OUTLINE (View on base end of tube)

See page 11 for outline dimensions.

3682

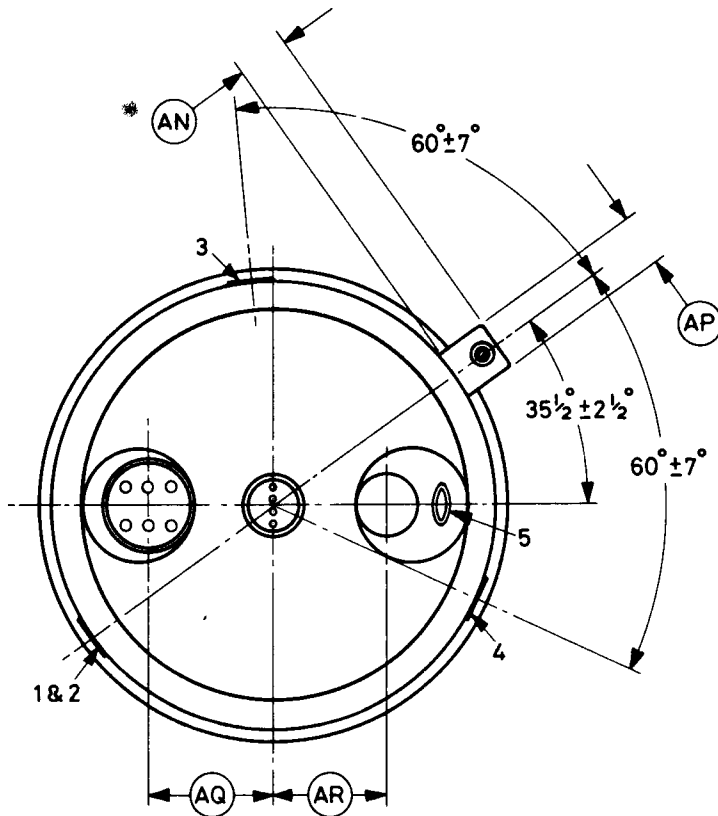

### Lead Connections, Writing Gun

Lead	Element
Yellow	Cathode
Green	Grid 1
Brown	Heater
Brown	Heater
White	Grid 3
Grey	Grid 2

### Lead Connections, Flood Gun

Lead	Element
Yellow	Cathode
Brown	Heater
Brown	Heater
Green	Grid 1

### Cavity Cap Connections

Cap	Element
1	Grid 3 (flood gun)
2	Backing electrode
3	Grid 3A (flood gun)
4	Grid 4 (flood gun)
5	Grid 2 (flood gun)

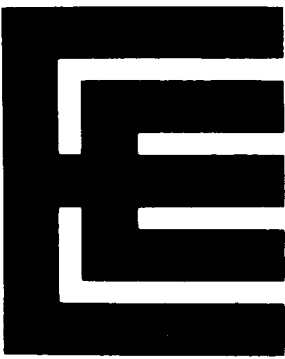

# E714A

## STORAGE CATHODE RAY TUBE

---

The data should be read in conjunction with the Storage Tube Preamble.

### INTRODUCTION

The E714A is a direct view storage cathode ray tube with a 10cm x 6cm viewing area and a split-beam writing gun. It is designed for oscilloscope use and is particularly suitable for compact transistorized equipment. It is normally used in the half-tone storage mode, but it will also operate as a p.d.a. oscilloscope c.r.t. without storage.

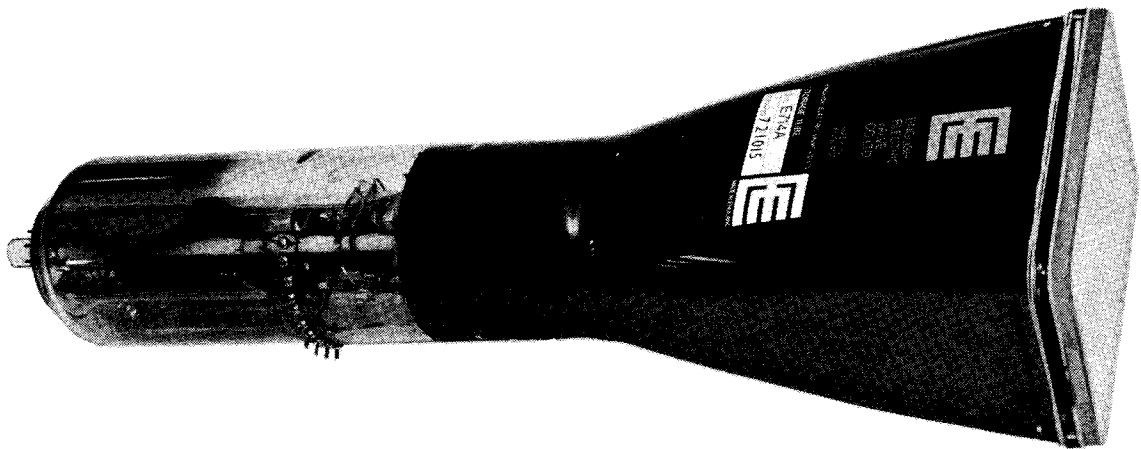

The principal features of the tube are as follows:

- Light output in excess of 90 ft-lamberts ( $309\text{cd/m}^2$ ) in the storage mode.
- Variable persistence — the persistence can be varied from several minutes to less than one second.
- Writing speed of  $0.5\text{cm}/\mu\text{s}$  in the storage mode.
- Good resolution, with typical spot size of 0.5mm in CRT mode.
- Good deflection sensitivity.
- Two beams with independent Y deflection systems.

## GENERAL DATA

### Electrical and General

	Writing Gun	Flood Gun	
Cathodes; indirectly heated oxide coated . . . . .	one	one	
Heater voltage <sup>Ⓢ</sup> (see notes 1 and 2) . . . . .	6.3	6.3	V
Heater current . . . . .	0.3	0.6	A
Focus method . . . . .	electrostatic	electrostatic	
Deflection method . . . . .	electrostatic	—	
Anode modulation (see note 3) . . . . .	electrostatic	—	
Minimum useful scan:			
Y1' to Y2' . . . . .	5.0		cm
Y1'' to Y2'' . . . . .	5.0		cm
X1 to X2 . . . . .	9.8		cm
Faceplate . . . . .		flat, clear glass	
Screen . . . . .		aluminized P31	
Inter-electrode capacitances:			
writing gun grid 1 to all other electrodes . . . . .		10	pF
writing gun cathode to all other electrodes . . . . .		6.0	pF
Y1' to Y2' plate . . . . .		1.3	pF
Y1'' to Y2'' plate . . . . .		1.3	pF
Y1' plate to all other electrodes except Y2' . . . . .		2.1	pF
Y1'' plate to all other electrodes except Y2'' . . . . .		3.2	pF
Y2' plate to all other electrodes except Y1' . . . . .		3.2	pF
Y2'' plate to all other electrodes except Y1'' . . . . .		2.1	pF
X1 to X2 plate . . . . .		2.7	pF
X1 plate to all other electrodes except X2 . . . . .		7.1	pF
X2 plate to all other electrodes except X1 . . . . .		6.0	pF
flood gun grid 1 to all other electrodes . . . . .		15	pF
backing electrode to all other electrodes . . . . .		150	pF

### Mechanical

Overall length . . . . .	442mm (17.40 inches) max
Faceplate overall dimensions (excluding side pip) . . . . .	140 x 102.5mm max 5.512 x 4.035 inches max
Neck diameter . . . . .	78mm (3.071 inches) max
Net weight . . . . .	1.8kg (4 pounds) approx
Base . . . . .	B.S.448-B12F
Mounting position (see note 4) . . . . .	any

## MAXIMUM AND MINIMUM RATINGS (Absolute values)

No individual rating should be exceeded

**Flood Gun** (All voltages are with respect to the flood gun cathode unless otherwise stated. See note 5).

	Min	Max	
Heater voltage (across heater)	6.0	6.6	V
Viewing screen voltage	see note 6	7.0	kV
Backing electrode positive voltage (except on clearance)	—	20	V
Backing electrode negative voltage	—	60	V
Grid 5 (collector mesh) voltage	—	150	V
Grid 4 (collimator) voltage	—	150	V
Grid 3 and grid 2 voltage (see notes 7 and 8)	—	100	V
Grid 1 voltage (negative value)	0	150	V
Peak heater to cathode voltage:			
heater positive with respect to cathode	—	125	V
heater negative with respect to cathode	—	125	V
Cathode current	—	2.0	mA
Viewing screen supply impedance	1.0	5.0	MΩ

**Writing Gun** (All voltages are with respect to anode 3 unless otherwise stated)

	Min	Max	
Heater voltage (across heater)	6.0	6.6	V
Mean deflection plate voltages (see note 8)†	—	200	V
Geometry control (S2) voltage (see note 9)†	—	200	V
Upper astigmatism control (S1') voltage (see note 10)†	—	200	V
Lower astigmatism control (S1'') voltage (see note 10)†	—	200	V
Anode 2 (focus) voltage (negative value)	—	2200	V
Anode 1 voltage †	—	200	V
Anode modulator (G3) voltage (see note 3)†	—	300	V
Beam equalizer (G2) voltage (see note 11)†	—	300	V
Grid 1 voltage with respect to writing gun cathode (negative value)	0	200	V
Cathode voltage (negative value)	—	2200	V
Peak heater to cathode voltage:			
heater positive with respect to cathode	—	125	V
heater negative with respect to cathode	—	125	V
Grid to cathode circuit impedance	—	1.0	MΩ

† Positive or negative values

## TYPICAL OPERATION

**Flood Gun** (All voltages with respect to flood gun cathode. See note 5)

Screen voltage (see note 6)	6000	V
Screen current	0.25	mA max
Backing electrode voltage:		
storage operation	2.0	V
non-storage operation	-50	V
Backing electrode current	0.5	mA max
Grid 5 voltage	125	V
Grid 5 current	0.55	mA max
Grid 4 voltage	40 to 100	V
Grid 4 current	0.5	mA max
Grid 3 and grid 2 voltage (see note 7)	40 to 100	V
Grid 3 and grid 2 current	0.2	mA max
Grid 1 voltage	0 to -13	V
Grid 1 cut-off voltage	-50	V max
Cathode current	0.7	mA

**Writing Gun** (All voltages with respect to anode 3 unless otherwise stated)

Mean deflection plate voltages (see note 8)	0	V
Geometry control (S2) voltage (see note 9)	-50 to +50	V
Upper astigmatism control (S1') voltage (see note 10)	0 to -50	V
Lower astigmatism control (S1'') voltage (see note 10)	0 to -80	V
Anode 2 voltage (focus)	-800 to -1100	V
Anode 1 voltage	-100	V
Anode modulator (G3) voltage (see note 3):		
for zero modulation	-100	V
for extinction of stationary spot	-148	V max
Beam equalizer (G2) voltage (see note 11)	-50 to -150	V
Grid 1 voltage for cut-off (with respect to writing gun cathode)	-65 to -110	V
Cathode voltage (see note 12)	-1300	V
Cathode current (see note 13)	500	$\mu$ A max

## PERFORMANCE (Under Typical Operation conditions on page 4)

Screen luminance	90ft-lamberts min 309 cd/m <sup>2</sup> min
Viewing time (see note 14)	1.5 minutes min
Writing speed (stored) (see note 15)	0.5 cm/ $\mu$ s
Deflection factors:	
X direction	8.4 to 10.7 V/cm
Y direction	5.0 to 6.5 V/cm
Linearity of scan	2 % max
Raster distortion (see notes 9, 16 and 17):	
X direction	2 % max
Y direction	4 % max
Orthogonality (see note 17)	90 $\pm$ 1 degrees
Undelected spot position (see note 18):	
error in X direction	$\pm$ 1.0 cm max
error in Y direction	$\pm$ 0.6 cm max
Trace alignment (see note 19)	$\pm$ 5 degrees max
Angle between Y axes	1.5 degrees max
Line width (see note 20)	0.8 mm max
Orientation (looking at screen with surface contacts down)	a positive voltage on X1 deflects spot to right; a positive voltage on Y1' or Y1'' deflects spot down

## NOTES

1. The writing gun heater must be operated from a separate supply.
2. A d.c. supply is recommended for the flood gun heater.
3. The writing gun beam current may be modulated to obtain flyback suppression by applying a blanking signal to pin 12 of the 12 pin base (grid 3). However, increased storage times can be achieved if it is possible to use grid modulation for flyback suppression. Grid 3 should not be used as a brightness control.
4. The tube should be supported near the screen and also on the parallel neck near the base. The tube should not be supported by the base only. The socket should not be mounted rigidly, and should have flexible

leads. To avoid the need for excessive magnetic shielding the tube should be mounted as far as possible from sources of magnetic field.

5. Flood gun grid 2 and grid 3 are operated near the mean X-plate potential (see notes 7 and 8). Floating supplies are required for flood gun cathode, collimating and backing electrodes; the collimating and backing electrode potentials must be referenced to flood gun cathode.
6. The screen may be operated below 6.0kV but the brightness will be reduced.
7. The writing gun anode 3 is internally connected to flood gun grid 2 and grid 3.
8. The deflection plates should be operated near writing gun anode 3 potential (see note 7); it is normally most convenient to operate close to earth potential. The maximum difference in mean deflection plate potentials should not exceed 20V otherwise some deterioration in performance will result.
9. Adjustment of the potential on S2 about the X-plate mean potential may be used for correction of raster distortion, but this should be kept to a minimum.
10. Adjustment of potentials on S1' and S1'' relative to their nominal values may be used for the purpose of independent astigmatism control.
11. The brightness of the traces may be equalized at low level by the application of a suitable potential to the beam equalizing electrode (writing gun grid 2) at pin 11 of the 12 pin base.
12. If a lower voltage is applied to the writing gun cathode the spot size will be degraded and the plate sensitivities enhanced. The voltage required on anode 2 for optimum focus will also change.
13. For continuous d.c. operation the cathode current should not exceed  $500\mu\text{A}$  or shortened tube life is likely to result. If the cathode current is pulsed, higher currents may safely be drawn from the cathode.
14. The viewing time is measured as the time for a 3cm diameter circular area of the background to come up to 10% of full brightness from just black. Longer viewing times can be obtained by erasing beyond black or pulsing the flood gun, at the cost of writing speed and brightness respectively.
15. The specification writing speed limit of  $0.05\text{cm}/\mu\text{s}$  min is the maximum speed that a trace can be written just visibly at any part of a viewing



area 9.8cm x 5.0cm starting from just black. An increase in writing speed to approximately 0.5cm/ $\mu$ s can be obtained if some background is tolerated over the viewing area.

16. The edges of a 9.4cm x 4.9cm raster will fall between two concentric rectangles 9.5cm x 5.0cm and 9.3cm x 4.8cm.
17. The X and Y deflection electrodes are designed primarily for symmetrical operation. Some degradation of focus and trace geometry will result if the tube is operated under asymmetric conditions.
18. The tolerances give the size of a rectangle centred on the geometric centre of the screened area.
19. The angle measured is that between the lower edge of the screened area and a trace filling the viewing area in the X direction while the Y plates are at anode 3 potential. Any small alignment error may be corrected by passing d.c. (4 ampere-turns/degree) through a suitable coil around the tube near the narrow end of the cone (see outline).
20. The line width is measured by means of a shrinking raster, with 5 $\mu$ A in each beam.

## SCHEMATIC DIAGRAM

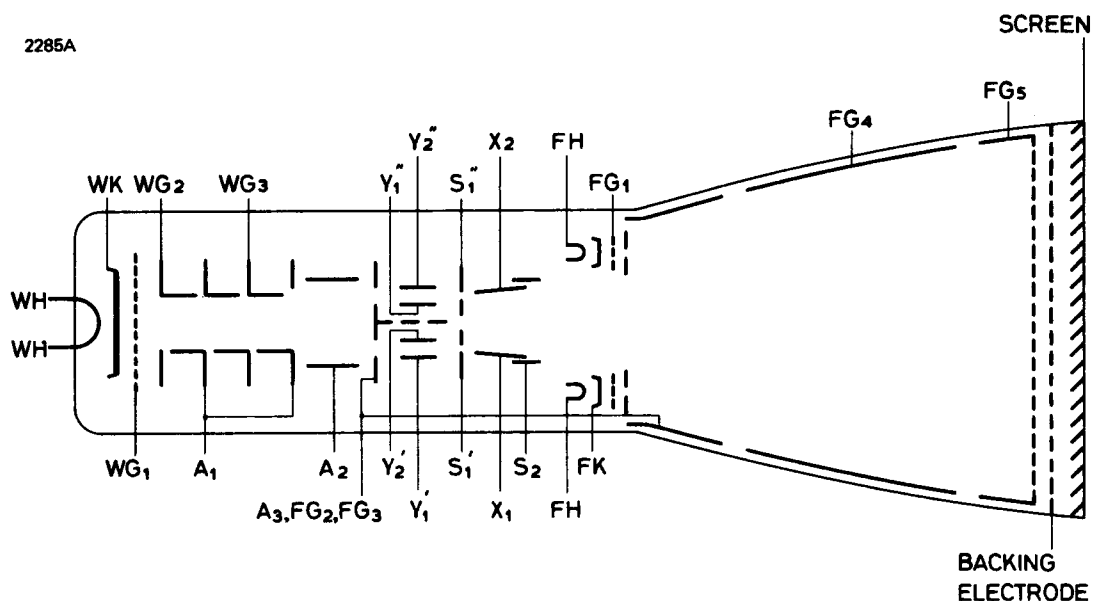

**OUTLINE (All dimensions without limits are nominal)**

2283B

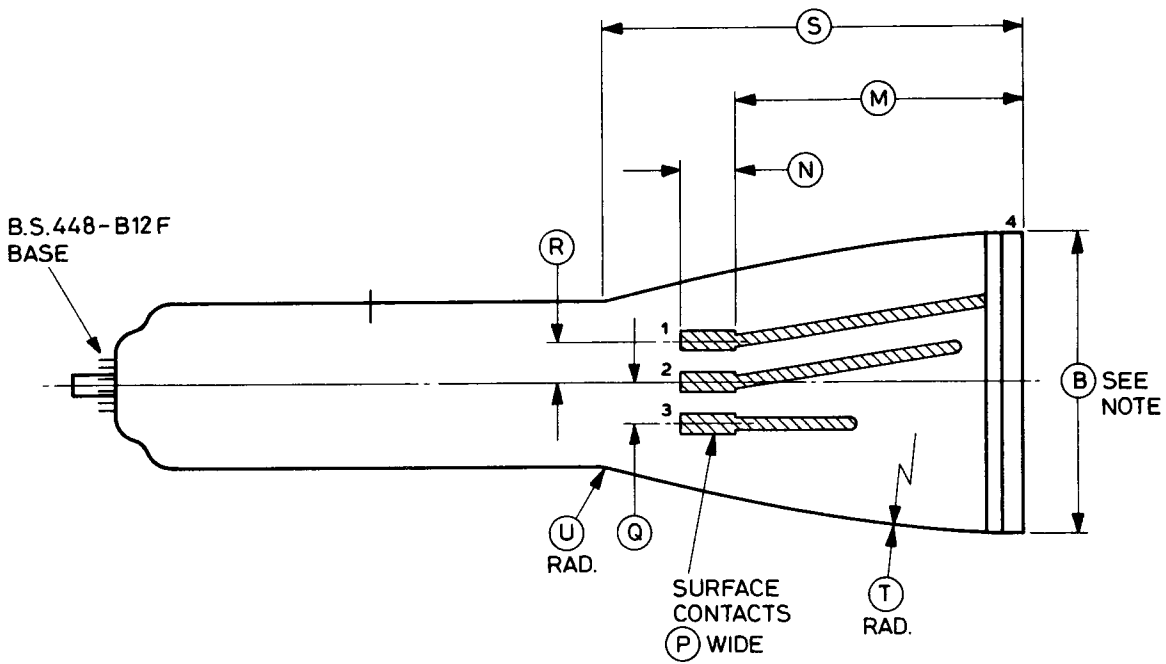
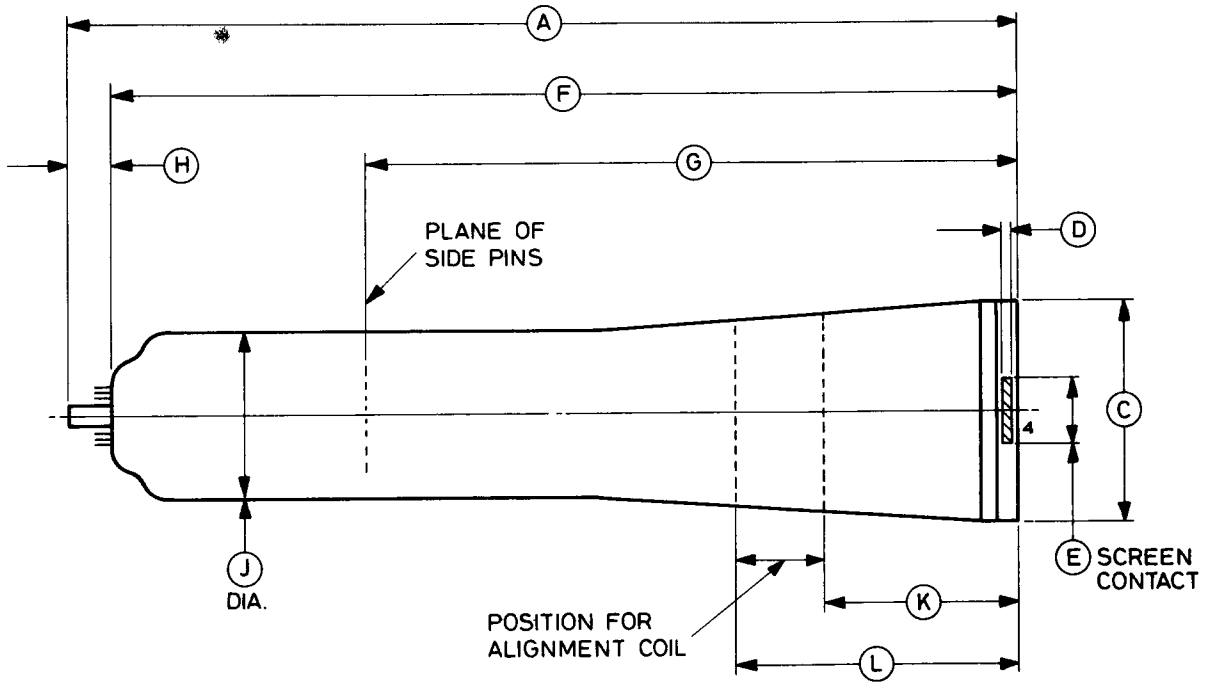

## OUTLINE (Enlarged view on base end)

2284B

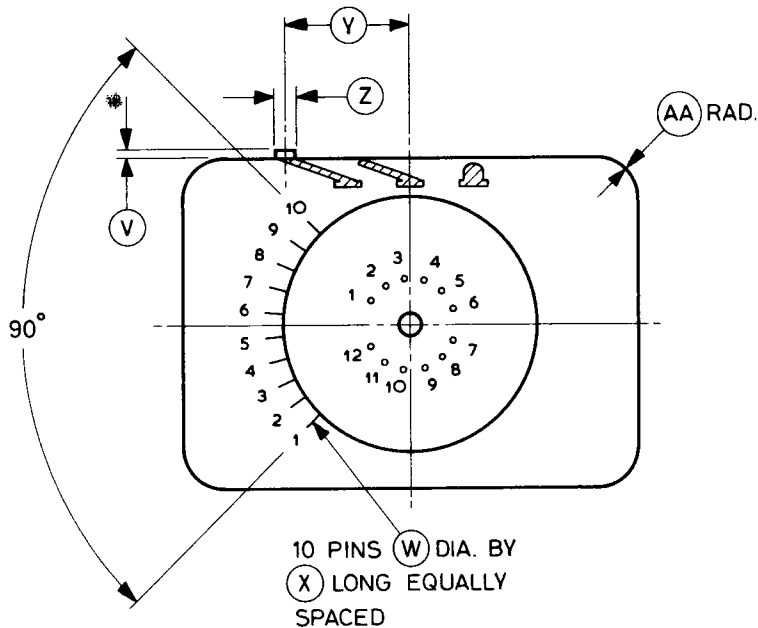

### Outline Note

The tube will pass through the acceptance gauge shown on page 11.

Ref	Millimetres	Inches	Ref	Millimetres	Inches
A	442.0 max	17.402 max	P	9.5 ± 1.0	0.374 ± 0.039
B	140.0 max	5.512 max	Q	19.0 ± 1.5	0.748 ± 0.059
C*	102.5 max	4.035 max	R	19.0 ± 1.5	0.748 ± 0.059
D	5.0 ± 0.5	0.197 ± 0.020	S	193.0	7.598
E	30.0 ± 1.0	1.181 ± 0.039	T	750.0	29.528
F	418.0 <sup>+ 3.0</sup> - 7.0	16.457 <sup>+ 0.118</sup> - 0.276	U	50.0	1.969
G	300.0 ± 4.0	11.811 ± 0.157	V	2.5 max	0.098 max
H	23.0 max	0.906 max	W	1.00	0.039
J	78.0 max	3.071 max	X	6.5 max	0.256 max
K	90.0	3.543	Y	38.0 ± 1.5	1.496 ± 0.059
L	130.0	5.118	Z	6.35 ± 0.25	0.250 ± 0.010
M	133.4 ± 1.5	5.252 ± 0.059	AA	13.0 ± 1.0	0.512 ± 0.039
N	25.4 ± 1.0	1.000 ± 0.039			

Inch dimensions have been derived from millimetres.

\* Excluding dimension V.

† Minimum useful length

## 12-Pin Base Connections

---

Pin	Element
1	Writing gun grid 1
2	Writing gun cathode
3	Writing gun heater
4	Writing gun heater
5	Writing gun anode 2
6	Flood gun heater
7	Flood gun heater
8	Flood gun grid 1
9	Flood gun cathode
10	Writing gun anode 1
11	Writing gun grid 2
12	Writing gun grid 3

---

## Side Pin Connections

---

Pin	Element
1	Y1''
2	Y2''
3	S1''
4	S1'
5	Writing gun anode 3
6	X1
7	X2
8	Y2'
9	Y1'
10	S2

---

## Surface Contact Connections

---

Contact	Element
1	Backing electrode
2	Flood gun grid 5
3	Flood gun grid 4
4	Screen

---

**FACEPLATE ACCEPTANCE GAUGE**  
 (All dimensions without limits are nominal)

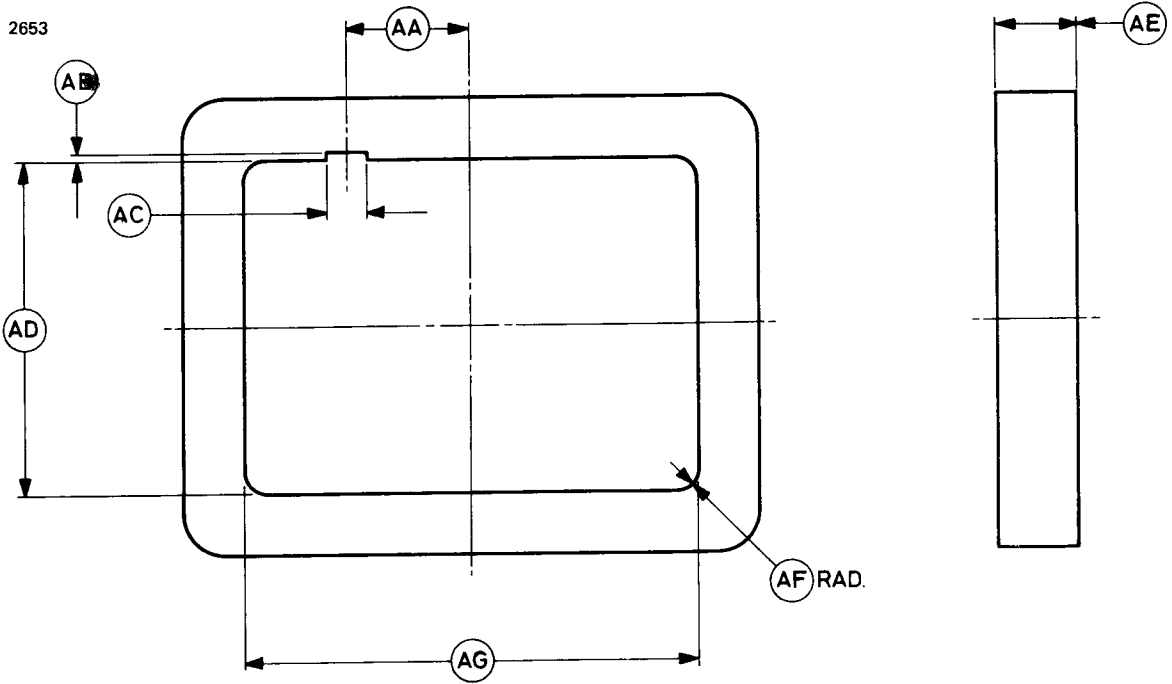

Ref	Millimetres	Inches
AA	38.00 ± 0.25	1.496 ± 0.010
AB	2.0 max	0.079 max
AC	13.0 max	0.512 max
AD	102.5 max	4.035 max
AE	25.4	1.000
AF	6.35	0.250
AG	140.0 max	5.512 max

Inch dimensions have been derived from millimetres.

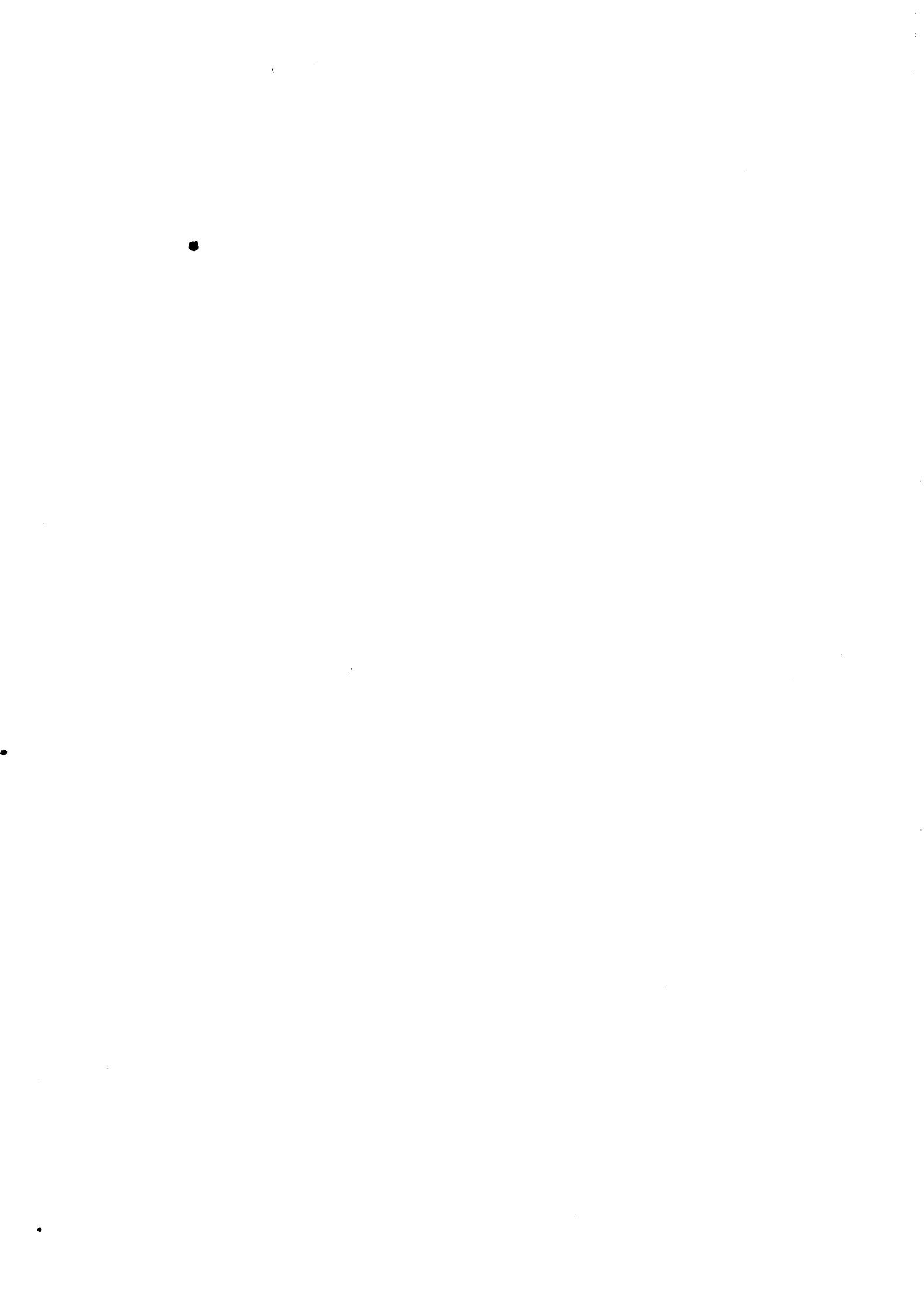

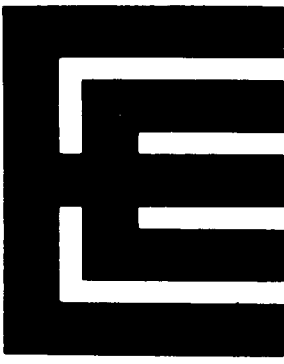

# E714C

## STORAGE CATHODE RAY TUBE

---

The data should be read in conjunction with the Storage Tube Preamble.

### INTRODUCTION

The E714C is a direct view storage cathode ray tube with a 10cm x 6cm viewing area. It is designed for oscilloscope use and is particularly suitable for compact transistorized equipment. It is normally used in the half-tone storage mode, but it will also operate as a p.d.a. oscilloscope tube without storage.

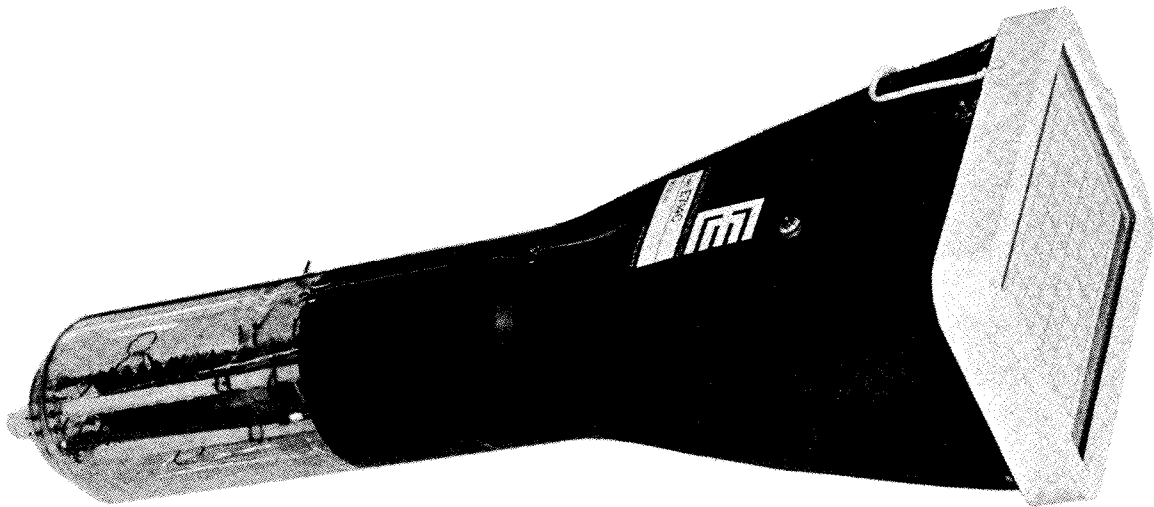

The principal features of the tube are as follows:

- Light output in excess of 90 ft-lamberts ( $309\text{cd/m}^2$ ) in the storage mode.
- Variable persistence — the persistence can be varied from several minutes to less than one second.
- Writing speed of  $1.0\text{cm}/\mu\text{s}$  in the storage mode.
- Good resolution, with typical spot size of 0.4mm.
- Good deflection sensitivity.
- Encapsulated screen lead.
- Internal graticule.
- Suitable mumetal shield, rotation coil, base socket and connectors can be supplied.

## GENERAL DATA

### Electrical and General

	Writing Gun	Flood Gun	
Cathodes; indirectly heated oxide coated . . . . .	one	one	
Heater voltage (see notes 1 and 2) . . . . .	6.3	6.3	V
Heater current . . . . .	0.3	0.6	A
Focus method . . . . .	electrostatic	electrostatic	
Deflection method . . . . .	electrostatic	none	
Minimum useful scan:			
Y1 to Y2 . . . . .	6.0		cm
X1 to X2 . . . . .	9.8		cm
Faceplate . . . . .		flat, clear glass	
Screen . . . . .		aluminized P31	
Internal graticule . . . . .		see page 11	
Inter-electrode capacitances:			
writing gun grid 1 to all other electrodes . . . . .		10	pF
writing gun cathode to all other electrodes . . . . .		6.0	pF
Y1 to Y2 plate . . . . .		1.2	pF
Y1 plate to all other electrodes except Y2 . . . . .		3.6	pF
Y2 plate to all other electrodes except Y1 . . . . .		3.6	pF
X1 to X2 plate . . . . .		2.6	pF
X1 plate to all other electrodes except X2 . . . . .		6.0	pF
X2 plate to all other electrodes except X1 . . . . .		6.0	pF
flood gun grid 1 to all other electrodes . . . . .		15	pF
backing electrode to all other electrodes . . . . .		150	pF

### Mechanical

Overall length . . . . .	445mm (17.52 inches) max
Overall dimensions, screen end, excluding side pips . . . . .	142.9 x 104.8mm max 5.625 x 4.125 inches max
Neck diameter . . . . .	78mm (3.071 inches) max
Net weight . . . . .	1.8kg (4 pounds) approx
Base . . . . .	B.S.448-B12F
Mounting position (see note 3) . . . . .	any



## MAXIMUM AND MINIMUM RATINGS (Absolute values)

No individual rating should be exceeded

**Flood Gun** (All voltages are with respect to the flood gun cathode unless otherwise stated)

	Min	Max	
Heater voltage (across heater) . . . . .	6.0	6.6	V
Viewing screen voltage . . . . .	see note 4	7.0	kV
Backing electrode positive voltage (except on clearance) . . . . .	—	20	V
Backing electrode negative voltage . . . . .	—	60	V
Grid 5 (collector mesh) voltage . . . . .	—	150	V
Grid 4 (collimator) voltage . . . . .	—	150	V
Grid 3 and grid 2 voltage (see notes 5 and 6) . . . . .	—	100	V
Grid 1 voltage (negative value) . . . . .	0	150	V
Peak heater to cathode voltage:			
heater positive with respect to cathode . . . . .	—	125	V
heater negative with respect to cathode . . . . .	—	125	V
Cathode current . . . . .	—	2.0	mA
Viewing screen supply impedance . . . . .	1.0	5.0	MΩ

**Writing Gun** (All voltages are with respect to anode 1 and anode 3 unless otherwise stated. See note 5).

	Min	Max	
Heater voltage (across heater) . . . . .	6.0	6.6	V
Mean deflection plate voltages (see note 6)† . . . . .	—	200	V
X-plate shield (geometry control) voltage (see note 7)† . . . . .	—	200	V
Inter-plate shield voltage (see note 8)† . . . . .	—	200	V
Y-plate shield voltage (see note 9)† . . . . .	—	200	V
Anode 4 (astigmatism control) voltage (see note 10)† . . . . .	—	200	V
Anode 2 (focus) voltage (negative value) . . . . .	—	2200	V
Grid 1 voltage with respect to writing gun cathode (negative value) . . . . .	0	200	V
Cathode voltage (negative value) . . . . .	—	2200	V
Peak heater to cathode voltage:			
heater positive with respect to cathode . . . . .	—	125	V
heater negative with respect to cathode . . . . .	—	125	V
Grid to cathode circuit impedance . . . . .	—	1.0	MΩ

† Positive or negative values

## TYPICAL OPERATION

### Flood Gun (All voltages with respect to flood gun cathode)

Screen voltage (see note 4)	6.0	kV
Screen current	0.25	mA max
Backing electrode voltage:		
storage operation	2.0	V
non-storage operation	-50	V
Backing electrode current	0.5	mA max
Grid 5 voltage	110	V
Grid 5 current	0.75	mA max
Grid 4 voltage	40 to 80	V
Grid 4 current	0.5	mA max
Grid 3 and grid 2 voltage (see note 5)	40	V
Grid 3 and grid 2 current	0.2	mA max
Grid 1 voltage	0 to -10	V
Grid 1 cut-off voltage	-50	V max
Cathode current	0.7	mA

### Writing Gun

All voltages with respect to anode 1 and anode 3 unless otherwise stated (see note 5)

Mean deflection plate voltages (see note 6)	0	V
X-plate shield (geometry control) voltage (see note 7)	-70 to +42	V
Inter-plate shield voltage (see note 8)	0	V
Y-plate shield voltage (see note 9)	0	V
Anode 4 (astigmatism control) voltage (see note 10)	-50 to +50	V
Anode 2 (focus) voltage (with respect to writing gun cathode)	70 to 370	V
Grid 1 voltage for cut-off (with respect to writing gun cathode)	-35 to -75	V
Cathode voltage (see note 11)	-1500	V
Cathode current (see note 12)	300	$\mu$ A max



6. The deflection plates should be operated near writing gun anode 1 and anode 3 potential (see note 5); it is normally most convenient to operate close to earth potential. The difference between mean X-plate and mean Y-plate potentials should not exceed 5V otherwise some deterioration in performance will result.
7. Adjustment of the potential on the X-plate shield about mean X-plate potential may be used to correct raster distortion.
8. The inter-plate shield should be at mean deflection plate potential.
9. The Y-plate shield should be at mean Y-plate potential.
10. Adjustment of anode 4 voltage about mean Y-plate potential is used to correct astigmatism.
11. If a lower voltage is applied to the writing gun cathode the spot size will be degraded and the plate sensitivities enhanced. The voltage required on anode 2 for optimum focus will also change.
12. For continuous d.c. operation the cathode current should not exceed  $300\mu\text{A}$  or shortened tube life is likely to result. If the cathode current is pulsed, higher currents may safely be drawn from the cathode.
13. The viewing time is measured as the time for a 3cm diameter circular area of the background to come up to 10% of full brightness from just black. Longer viewing times can be obtained by erasing beyond black or pulsing the flood gun, at the cost of writing speed and brightness respectively.
14. The specification writing speed limit of  $0.1\text{cm}/\mu\text{s}$  min is the maximum speed that a trace can be written just visibly at any part of a viewing area  $9.0\text{cm} \times 5.0\text{cm}$  starting from just black. An increase in writing speed to approximately  $1.0\text{cm}/\mu\text{s}$  can be obtained if some background is tolerated over the viewing area.
15. The edges of a  $9.5\text{cm} \times 5.7\text{cm}$  raster will fall between two concentric rectangles  $9.6\text{cm} \times 5.8\text{cm}$  and  $9.4\text{cm} \times 5.6\text{cm}$ .
16. The X and Y deflection electrodes are designed primarily for symmetrical operation. Some degradation of focus and trace geometry will result if the tube is operated under asymmetric conditions.

17. The distance of the undeflected spot from the graticule centre will be 5mm maximum.
18. The angle measured is that between the centre horizontal line of the graticule and a trace filling the viewing area in the X direction while the Y-plates are at anode 1 and anode 3 potential. Any small alignment error may be corrected by passing d.c. (4 ampere-turns/degree) through a suitable coil around the tube near the narrow end of the cone (see outline).
19. The line width is measured by means of a shrinking raster, with  $10\mu\text{A}$  beam current in the non-storage mode.

## SCHEMATIC DIAGRAM

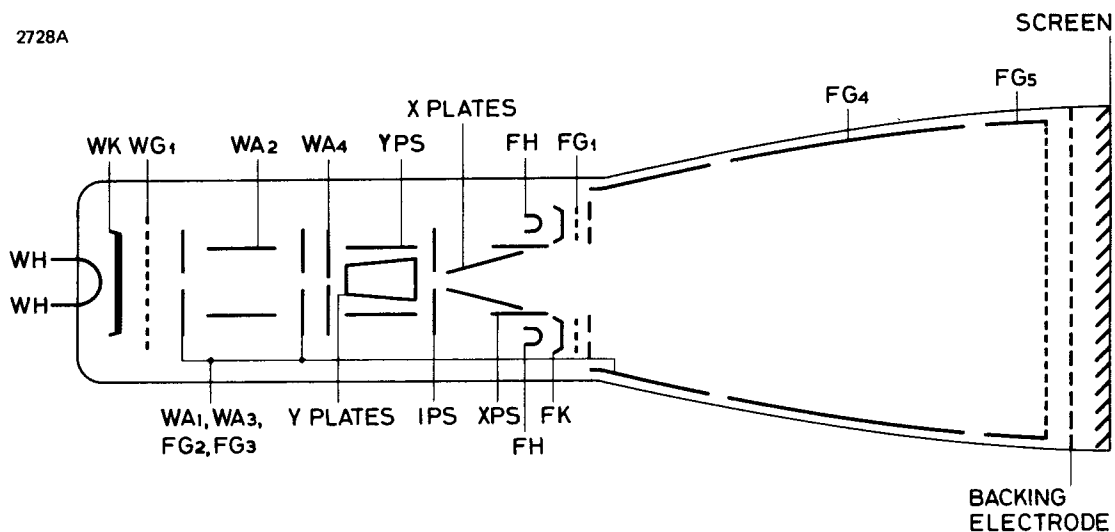

**OUTLINE (All dimensions without limits are nominal)**

3306A

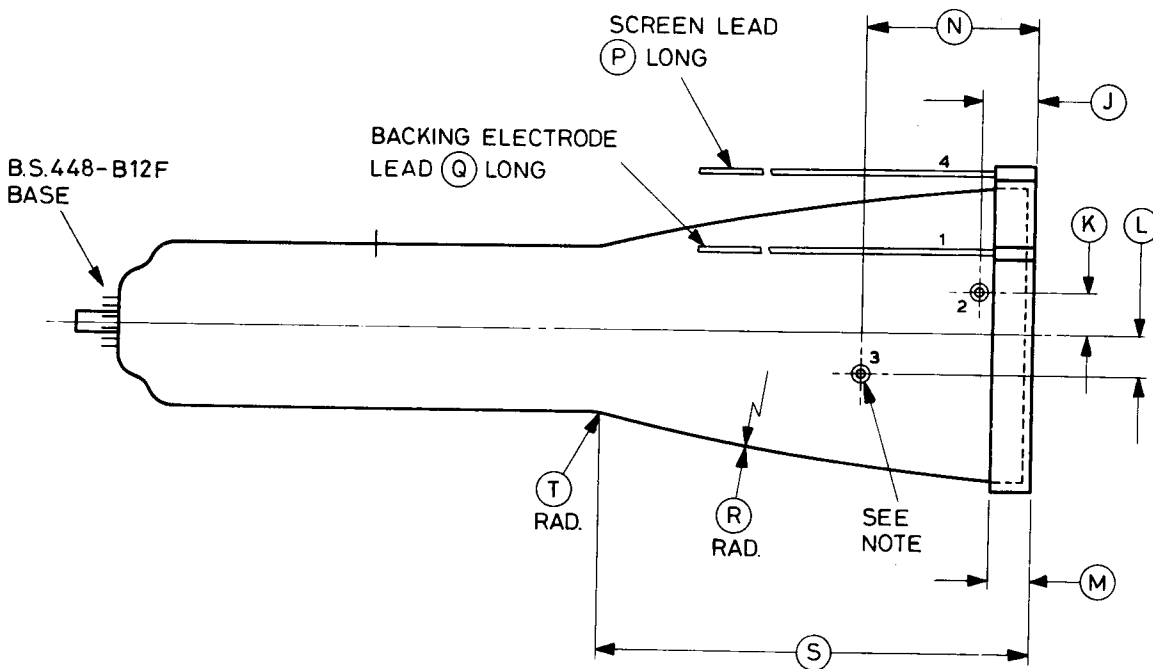
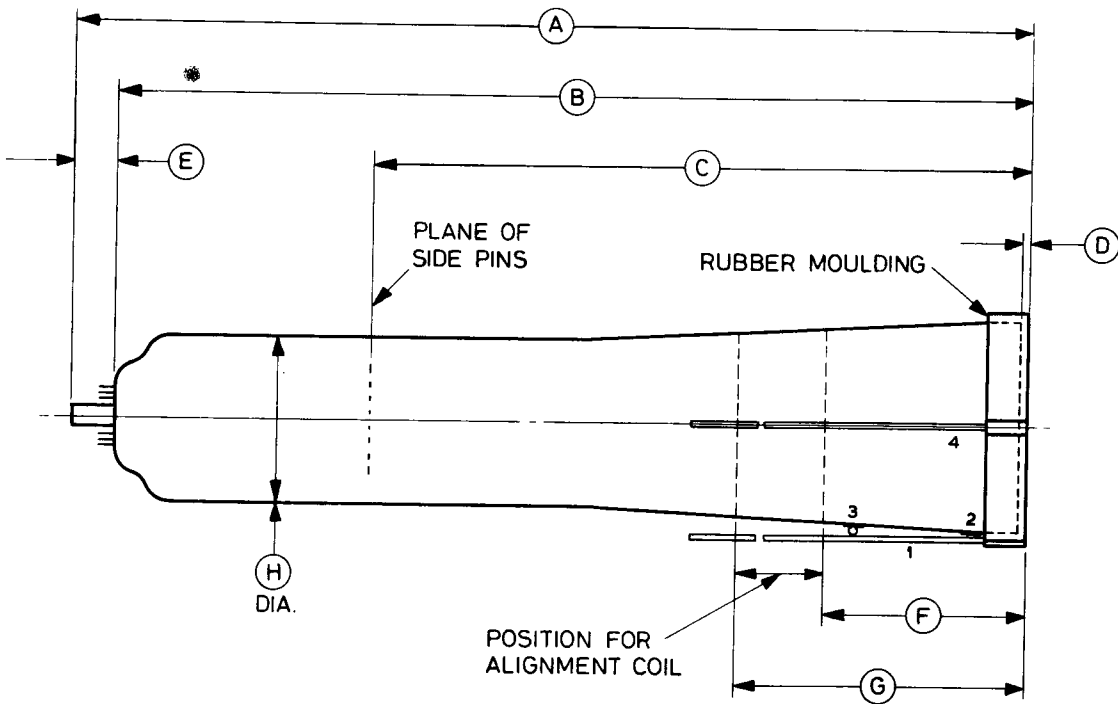

**Outline Note** Ball connections from B.S.448-CT7. Positional tolerance 8.0mm (0.315 inch) diameter.

## OUTLINE (Enlarged view on screen end)

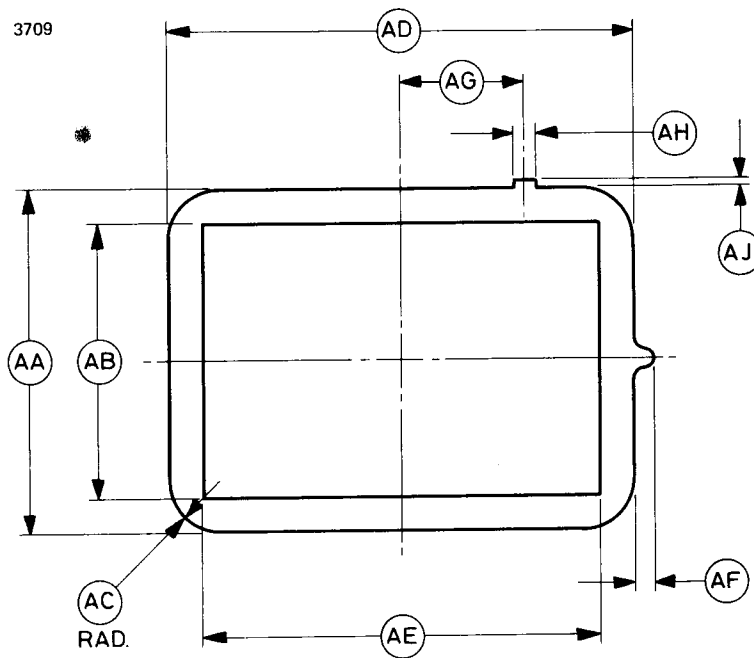

Ref	Millimetres	Inches	Ref	Millimetres	Inches
A	445.0 max	17.520 max	R	750.0	29.528
B	421.0 <sup>+ 3.0</sup> - 7.0	16.575 <sup>+ 0.118</sup> - 0.276	S	196.0	7.717
C	303.0 ± 4.0	11.929 ± 0.158	T	50.0	1.969
D	3.0	0.118	AA*	104.8 max	4.125 max
E	23.0 max	0.905 max	AB*	84.15	3.313
F	93.0	3.661	AC*	15.88	0.625
G	133.0	5.236	AD*	142.9 max	5.625 max
H	78.0 max	3.071 max	AE*	122.3	4.813
J	24.0	0.945	AF*	5.56	0.219
K	19.0	0.748	AG*	38.10	1.500
L	19.0	0.748	AH*	6.35	0.250
M	19.0	0.748	AJ*	2.39	0.094
N	79.0	3.110	AN	1.00	0.039
P	450.0	17.717	AP	6.5 max	0.256 max
Q	450.0	17.717		3.00 min†	0.118 min†

Inch dimensions have been derived from millimetres except where indicated thus \*.

† Minimum useful length.

## OUTLINE (Enlarged view on base end)

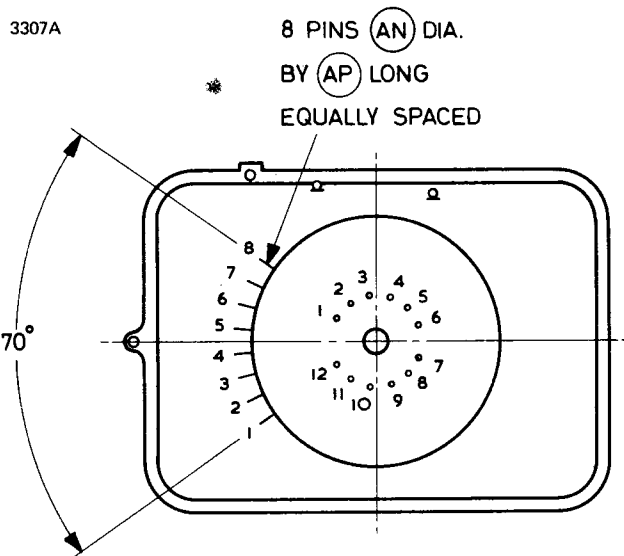

### 12-Pin Base Connections

Pin	Element
1	Writing gun grid 1
2	Writing gun cathode
3	Writing gun heater
4	Writing gun heater
5	Writing gun anode 2
6	Flood gun heater
7	Flood gun heater
8	Flood gun grid 1
9	Flood gun cathode
10	Writing gun anode 1 and anode 3
11	Internal connection
12	Internal connection

### Side Pin Connections

Pin	Element
1	X2 deflection plate
2	X1 deflection plate
3	Writing gun anode 4
4	Inter-plate shield
5	Y-plate shield
6	Y1 deflection plate
7	Y2 deflection plate
8	X-plate shield

### Ball Contact and Lead Connections

Contact	Element
1	Backing electrode
2	Flood gun grid 5
3	Flood gun grid 4
4	Screen



# INTERNAL GRATICULE (All dimensions are nominal)

3308

GRATICULE DIVIDED 10 BY 6  
SUB-DIVIDED INTO 0.2 DIVISIONS

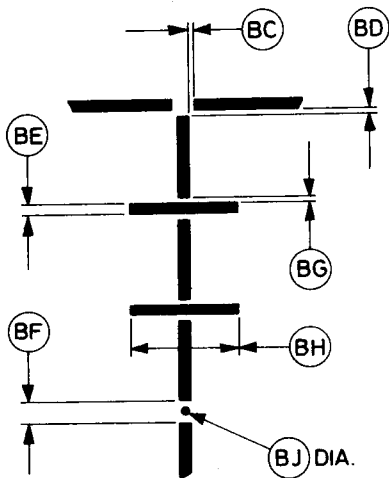
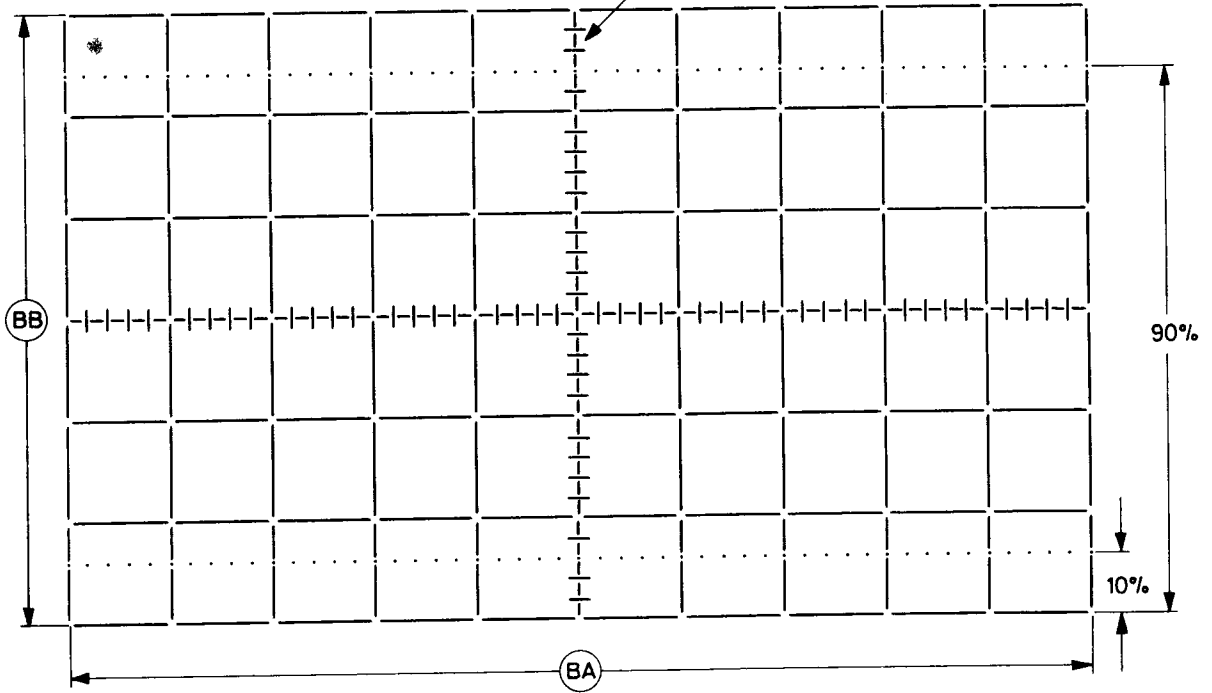

Ref	Millimetres	Inches
BA	94.0	3.701
BB	56.4	2.220
BC	0.1	0.004
BD	0.1	0.004
BE	0.2	0.008
BF	0.4	0.016
BG	0.1	0.004
BH	2.0	0.079
BJ	0.15	0.006

Inch dimensions have been derived from millimetres.





# E714D

## STORAGE CATHODE RAY TUBE

---

The data should be read in conjunction with the Storage Tube Preamble.

### INTRODUCTION

The E714D is a direct view storage cathode ray tube with a 10cm x 6cm viewing area. It is designed for oscilloscope use and is particularly suitable for compact transistorized equipment. It is normally used in the half-tone storage mode, but it will also operate as a p.d.a. oscilloscope tube without storage.



The principal features of the tube are as follows:

- Light output in excess of 90 ft-lamberts ( $309\text{cd/m}^2$ ) in the storage mode.
- Variable persistence — the persistence can be varied from several minutes to less than one second.
- Writing speed of  $1.0\text{cm}/\mu\text{s}$  in the storage mode.
- Good resolution, with typical spot size of 0.4mm.
- Good deflection sensitivity.

## GENERAL DATA

### Electrical and General

	Writing Gun	Flood Gun
Cathodes; indirectly heated oxide coated . . . . .	one	one
Heater voltage (see notes 1 and 2) . . . . .	6.3	6.3 V
Heater current . . . . .	0.3	0.6 A
Focus method . . . . .	electrostatic	electrostatic
Deflection method . . . . .	electrostatic	
Minimum useful scan:		
Y1 to Y2 . . . . .	6.0	cm
X1 to X2 . . . . .	9.8	cm
Faceplate . . . . .		flat, clear glass
Screen . . . . .		aluminized.P31
Inter-electrode capacitances:		
writing gun grid 1 to all other electrodes . . . . .	10	pF
writing gun cathode to all other electrodes . . . . .	6.0	pF
Y1 to Y2 plate . . . . .	1.2	pF
Y1 plate to all other electrodes except Y2 . . . . .	3.6	pF
Y2 plate to all other electrodes except Y1 . . . . .	3.6	pF
X1 to X2 plate . . . . .	2.6	pF
X1 plate to all other electrodes except X2, . . . . .	6.0	pF
X2 plate to all other electrodes except X1 . . . . .	6.0	pF
flood gun grid 1 to all other electrodes . . . . .	15	pF
backing electrode to all other electrodes . . . . .	150	pF

### Mechanical

Overall length . . . . .	442mm (17.40 inches) max
Faceplate overall dimensions (excluding side pip) . . . . .	140 x 102.5mm max 5.512 x 4.035 inches max
Neck diameter . . . . .	78mm (3.071 inches) max
Net weight . . . . .	1.8kg (4 pounds) approx
Base . . . . .	B.S.448-B12F
Mounting position (see note 3) . . . . .	any

## MAXIMUM AND MINIMUM RATINGS (Absolute values)

No individual rating should be exceeded

**Flood Gun** (All voltages are with respect to the flood gun cathode unless otherwise stated. See note 4)

	Min	Max	
Heater voltage (across heater) . . . . .	6.0	6.6	V
Viewing screen voltage . . . . .	see note 5	7.0	kV
Backing electrode positive voltage (except on clearance) . . . . .	—	20	V
Backing electrode negative voltage . . . . .	—	60	V
Grid 5 (collector mesh) voltage . . . . .	—	150	V
Grid 4 (collimator) voltage . . . . .	—	150	V
Grid 3 and grid 2 voltage (see notes 6 and 7) . . . . .	—	100	V
Grid 1 voltage (negative value) . . . . .	0	150	V
Peak heater to cathode voltage:			
heater positive with respect to cathode . . . . .	—	125	V
heater negative with respect to cathode . . . . .	—	125	V
Cathode current . . . . .	—	2.0	mA
Viewing screen supply impedance . . . . .	1.0	5.0	MΩ

**Writing Gun** (All voltages are with respect to anode 1 and anode 3 unless otherwise stated. See note 6)

	Min	Max	
Heater voltage (across heater) . . . . .	6.0	6.6	V
Mean deflection plate voltages (see note 7)† . . . . .	—	200	V
X-plate shield (geometry control) voltage (see note 8)† . . . . .	—	200	V
Inter-plate shield voltage (see note 9)† . . . . .	—	200	V
Y-plate shield voltage (see note 10)† . . . . .	—	200	V
Anode 4 (astigmatism control) voltage (see note 11)† . . . . .	—	200	V
Anode 2 (focus) voltage (negative value) . . . . .	—	2200	V
Grid 1 voltage with respect to writing gun cathode (negative value) . . . . .	0	200	V
Cathode voltage (negative value) . . . . .	—	2200	V
Peak heater to cathode voltage:			
heater positive with respect to cathode . . . . .	—	125	V
heater negative with respect to cathode . . . . .	—	125	V
Grid to cathode circuit impedance . . . . .	—	1.0	MΩ

† Positive or negative values

## TYPICAL OPERATION

**Flood Gun** (All voltages with respect to flood gun cathode. See note 4)

Screen voltage (see note 5)	6.0	kV
Screen current	0.25	mA max
Backing electrode voltage:		
storage operation	2.0	V
non-storage operation	-50	V
Backing electrode current	0.5	mA max
Grid 5 voltage	110	V
Grid 5 current	0.75	mA max
Grid 4 voltage	40 to 100	V
Grid 4 current	0.5	mA max
Grid 3 and grid 2 voltage (see note 6)	40 to 100	V
Grid 3 and grid 2 current	0.2	mA max
Grid 1 voltage	0 to -20	V
Grid 1 cut-off voltage	-50	V max
Cathode current	0.7	mA

## Writing Gun

All voltages with respect to anode 1 and anode 3 unless otherwise stated (see note 6)

Mean deflection plate voltages (see note 7)	0	V
X-plate shield (geometry control) voltage (see note 8)	-70 to +60	V
Inter-plate shield voltage (see note 9)	0	V
Y-plate shield voltage (see note 10)	0	V
Anode 4 (astigmatism control) voltage (see note 11)	-50 to +50	V
Anode 2 (focus) voltage (with respect to writing gun cathode)	70 to 370	V
Grid 1 voltage for cut-off (with respect to writing gun cathode)	-35 to -75	V
Cathode voltage (see note 12)	-1500	V
Cathode current (see note 13)	300	$\mu$ A max

**PERFORMANCE (Under Typical Operation conditions on page 4)**

Screen luminance . . . . .	90ft-lamberts min 309 cd/m <sup>2</sup> min
Viewing time (see note 14) . . . . .	90 seconds min
Writing speed (stored) (see note 15) . . . . .	1.0 cm/ $\mu$ s
Deflection factors:	
X direction . . . . .	10 $\pm$ 1 V/cm
Y direction . . . . .	8 $\pm$ 1 V/cm
Linearity of scan . . . . .	2.0 %
Raster distortion (see notes 8, 16 and 17):	
X direction . . . . .	2.1 % max
Y direction . . . . .	3.5 % max
Orthogonality . . . . .	90 $\pm$ 1 degrees
Undelected spot position (see note 18):	
error in X direction . . . . .	$\pm$ 1.0 cm max
error in Y direction . . . . .	$\pm$ 0.6 cm max
Trace alignment (see note 19) . . . . .	$\pm$ 5 degrees max
Line width (see note 20) . . . . .	0.8 mm max
Orientation (looking at screen with surface contacts down) . . . . .	a positive voltage on X1 deflects spot to left a positive voltage on Y1 deflects spot up



**NOTES**

1. The writing gun heater must be operated from a separate supply.
2. A d.c. supply is recommended for the flood gun heaters.
3. The tube should be supported near the screen and also on the parallel neck near the base. The tube should not be supported by the base only. The socket should not be mounted rigidly, and should have flexible leads. To avoid the need for excessive magnetic shielding the tube should be mounted as far as possible from sources of magnetic field.
4. Flood gun grid 2 and grid 3 are operated near the mean X-plate potential (see notes 6 and 7). Floating supplies are required for flood

gun cathode, collimating and backing electrodes; the collimating and backing electrode potentials must be referenced to flood gun cathode.

5. The screen may be operated below 6.0kV but the brightness will be reduced.
6. The writing gun anode 1 and anode 3 are internally connected to flood gun grid 2 and grid 3.
7. The deflection plates should be operated near writing gun anode 1 and anode 3 potential (see note 6); it is normally most convenient to operate close to earth potential. The difference between mean X-plate and mean Y-plate potentials should not exceed 5V otherwise some deterioration in performance will result.
8. Adjustment of the potential on the X-plate shield about mean X-plate potential may be used to correct raster distortion.
9. The inter-plate shield should be at mean deflection plate potential.
10. The Y-plate shield should be at mean Y-plate potential.
11. Adjustment of anode 4 voltage about mean Y-plate potential is used to correct astigmatism.
12. If a lower voltage is applied to the writing gun cathode the spot size will be degraded and the plate sensitivities enhanced. The voltage required on anode 2 for optimum focus will also change.
13. For continuous d.c. operation the cathode current should not exceed  $300\mu\text{A}$  or shortened tube life is likely to result. If the cathode current is pulsed, higher currents may safely be drawn from the cathode.
14. The viewing time is measured as the time for a 3cm diameter circular area of the background to come up to 10% of full brightness from just black. Longer viewing times can be obtained by erasing beyond black or pulsing the flood gun, at the cost of writing speed and brightness respectively.
15. The specification writing speed limit of  $0.1\text{cm}/\mu\text{s}$  min is the maximum speed that a trace can be written just visibly at any part of a viewing area  $9.0\text{cm} \times 5.0\text{cm}$  starting from just black. An increase in writing speed to approximately  $1.0\text{cm}/\mu\text{s}$  can be obtained if some background is tolerated over the viewing area.



16. The edges of a 9.5cm x 5.7cm raster will fall between two concentric rectangles 9.6cm x 5.8cm and 9.4cm x 5.6cm.
17. The X and Y deflection electrodes are designed primarily for symmetrical operation. Some degradation of focus and trace geometry will result if the tube is operated under asymmetric conditions.
18. The tolerances give the size of a rectangle centred on the geometric centre of the screened area.
19. The angle measured is that between the lower edge of the screened area and a trace filling the viewing area in the X direction while the Y-plates are at anode 1 and anode 3 potential. Any small alignment error may be corrected by passing d.c. (4 ampere-turns/degree) through a suitable coil around the tube near the narrow end of the cone (see outline).
20. The line width is measured by means of a shrinking raster, with 10 $\mu$ A beam current in the non-storage mode.

## SCHEMATIC DIAGRAM

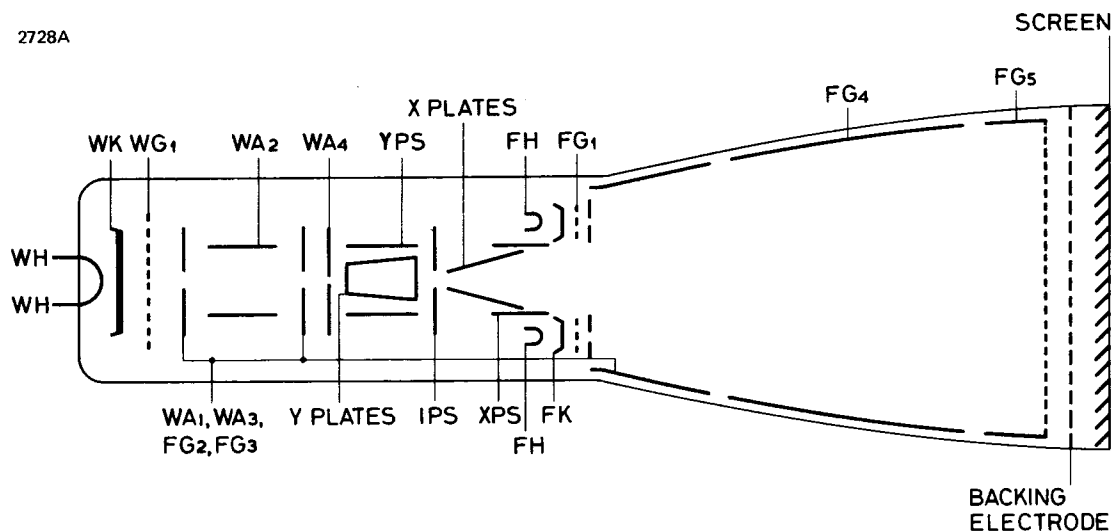

**OUTLINE (All dimensions without limits are nominal)**

2283B

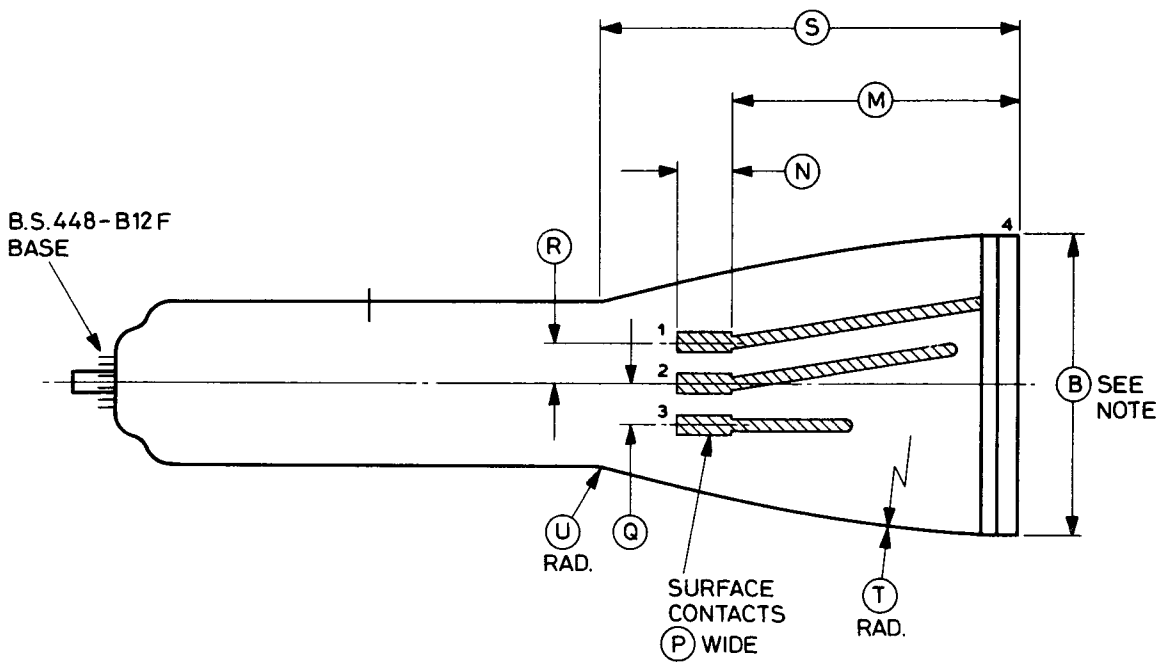
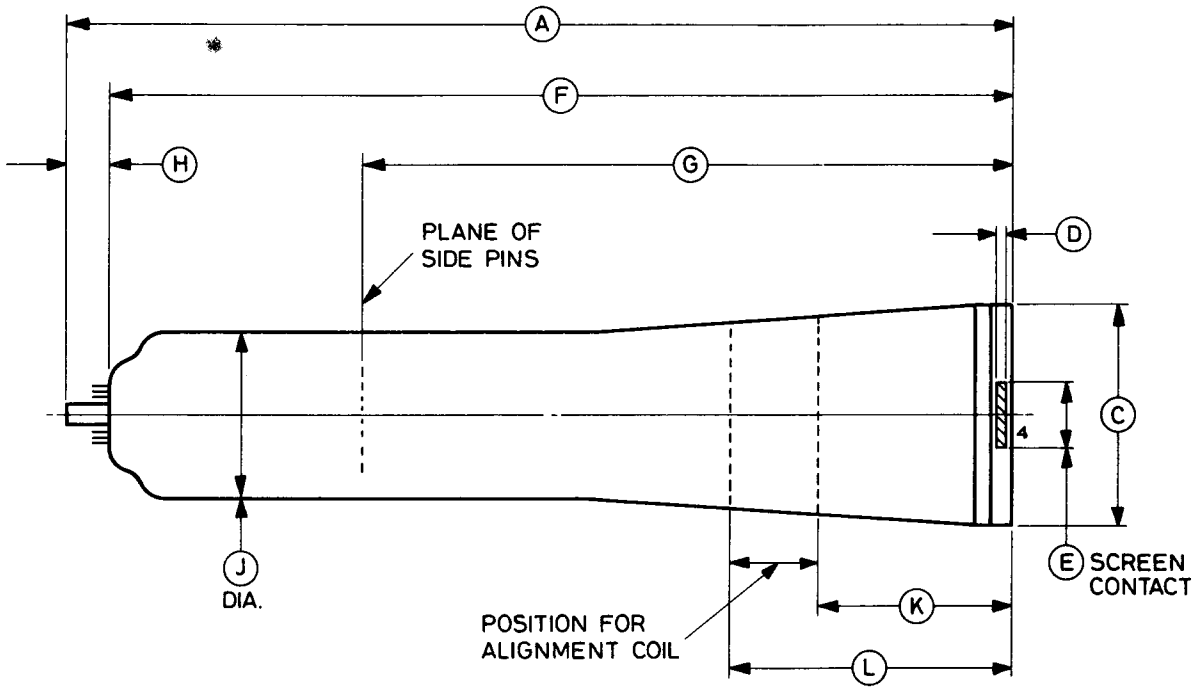

## OUTLINE (Enlarged view on base end)

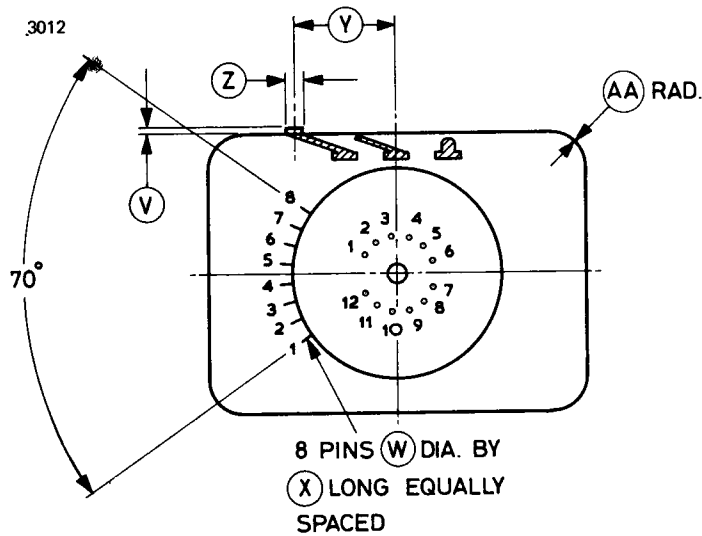

### Outline Note

The tube will pass through the acceptance gauge shown on page 11.

Ref	Millimetres	Inches	Ref	Millimetres	Inches
A	442.0 max	17.402 max	P	9.5 ± 1.0	0.374 ± 0.039
B	140.0 max	5.512 max	Q	19.0 ± 1.5	0.748 ± 0.059
C*	102.5 max	4.035 max	R	19.0 ± 1.5	0.748 ± 0.059
D	5.0 ± 0.5	0.197 ± 0.020	S	193.0	7.598
E	30.0 ± 1.0	1.181 ± 0.039	T	750.0	29.528
F	418.0 <sup>+ 3.0</sup> - 7.0	16.457 <sup>+ 0.118</sup> - 0.276	U	50.0	1.969
G	300.0 ± 4.0	11.811 ± 0.157	V	2.5 max	0.098 max
H	23.0 max	0.906 max	W	1.00	0.039
J	78.0 max	3.071 max	X	6.5 max	0.256 max
K	90.0	3.543		3.00 min †	0.118 min †
L	130.0	5.118	Y	38.0 ± 1.5	1.496 ± 0.059
M	133.4 ± 1.5	5.252 ± 0.059	Z	6.35 ± 0.25	0.250 ± 0.010
N	25.4 ± 1.0	1.000 ± 0.039	AA	13.0 ± 1.0	0.512 ± 0.039

Inch dimensions have been derived from millimetres.

\* Excluding dimension V

† Minimum useful length

## 12-Pin Base Connections

---

Pin	Element
1	Writing gun grid 1
2	Writing gun cathode
3	Writing gun heater
4	Writing gun heater
5	Writing gun anode 2
6	Flood gun heater
7	Flood gun heater
8	Flood gun grid 1
9	Flood gun cathode
10	Writing gun anode 1 and anode 3
11	Internal connection
12	Internal connection

---

## Side Pin Connections

---

Pin	Element
1	X2 deflection plate
2	X1 deflection plate
3	Writing gun anode 4
4	Inter-plate shield
5	Y-plate shield
6	Y1 deflection plate
7	Y2 deflection plate
8	X-plate shield

---

## Surface Contact Connections

---

Contact	Element
1	Backing electrode
2	Flood gun grid 5
3	Flood gun grid 4
4	Screen

---

**FACEPLATE ACCEPTANCE GAUGE**  
**(All dimensions without limits are nominal)**

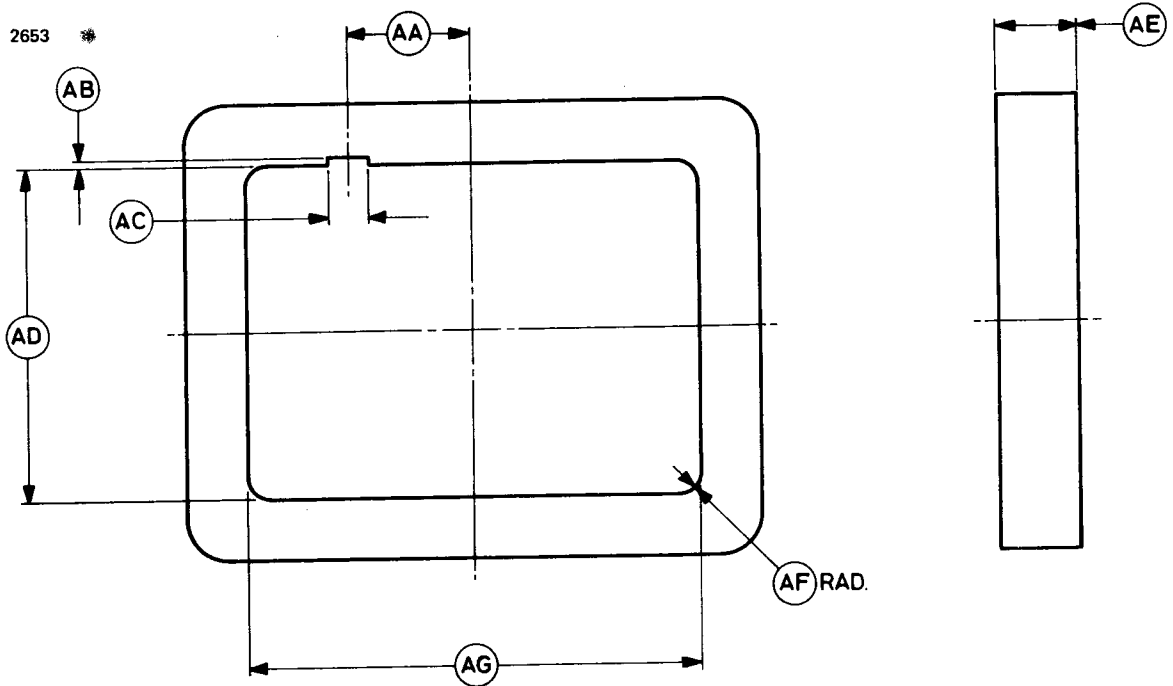

Ref	Millimetres	Inches
AA	38.00 ± 0.25	1.496 ± 0.010
AB	2.0 max	0.079 max
AC	13.0 max	0.512 max
AD	102.5 max	4.035 max
AE	25.4	1.000
AF	6.35	0.250
AG	140.0 max	5.512 max

Inch dimensions have been derived from millimetres.



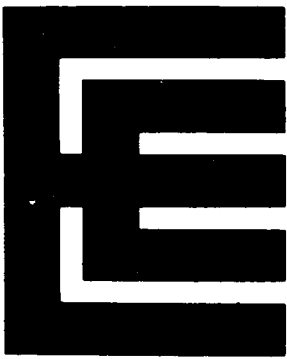

# E714G

## STORAGE CATHODE RAY TUBE

---

The data should be read in conjunction with the Storage Tube Preamble.

### INTRODUCTION

The E714G is a direct view storage cathode ray tube with a 10cm x 6cm viewing area. It is designed for oscilloscope use and is particularly suitable for compact transistorized equipment. It is normally used in the half-tone storage mode, but it will also operate as a p.d.a. oscilloscope tube without storage.



The principal features of the tube are as follows:

- Light output in excess of 90 ft-lamberts ( $309\text{cd/m}^2$ ) in the storage mode.
- Variable persistence — the persistence can be varied from several minutes to less than one second.
- Writing speed of  $1.0\text{cm}/\mu\text{s}$  in the storage mode.
- Good resolution, with typical spot size of 0.4mm.
- Good deflection sensitivity.
- Encapsulated screen lead.
- Suitable mumetal shield, rotation coil, base socket and connectors can be supplied.

## GENERAL DATA

### Electrical and General

	Writing Gun	Flood Gun	
Cathodes; indirectly heated oxide coated . . . . .	one	one	
Heater voltage (see notes 1 and 2) . . . . .	6.3	6.3	V
Heater current . . . . .	0.3	0.6	A
Focus method . . . . .	electrostatic	electrostatic	
Deflection method . . . . .	electrostatic	none	
Minimum useful scan:			
Y1 to Y2 . . . . .	6.0		cm
X1 to X2 . . . . .	9.8		cm
Faceplate . . . . .		flat, clear glass	
Screen . . . . .		aluminized P31	
Inter-electrode capacitances:			
writing gun grid 1 to all other electrodes . . . . .	10		pF
writing gun cathode to all other electrodes . . . . .	6.0		pF
Y1 to Y2 plate . . . . .	1.2		pF
Y1 plate to all other electrodes except Y2 . . . . .	3.6		pF
Y2 plate to all other electrodes except Y1 . . . . .	3.6		pF
X1 to X2 plate . . . . .	2.6		pF
X1 plate to all other electrodes except X2 . . . . .	6.0		pF
X2 plate to all other electrodes except X1 . . . . .	6.0		pF
flood gun grid 1 to all other electrodes . . . . .	15		pF
backing electrode to all other electrodes . . . . .	150		pF

### Mechanical

Overall length . . . . .	445mm (17.52 inches) max
Overall dimensions, screen end, excluding side pips . . . . .	142.9 x 104.8mm max 5.625 x 4.125 inches max
Neck diameter . . . . .	78mm (3.071 inches) max
Net weight . . . . .	1.8kg (4 pounds) approx
Base . . . . .	B.S.448-B12F
Mounting position (see note 3) . . . . .	any



**MAXIMUM AND MINIMUM RATINGS (Absolute values)**

No individual rating should be exceeded

**Flood Gun** (All voltages are with respect to the flood gun cathode unless otherwise stated)

	<b>Min</b>	<b>Max</b>	
Heater voltage (across heater) . . . . .	6.0	6.6	V
Viewing screen voltage . . . . .	see note 4	7.0	kV
Backing electrode positive voltage (except on clearance) . . . . .	—	20	V
Backing electrode negative voltage . . . . .	—	60	V
Grid 5 (collector mesh) voltage . . . . .	—	150	V
Grid 4 (collimator) voltage . . . . .	—	150	V
Grid 3 and grid 2 voltage (see notes 5 and 6) . . . . .	—	100	V
Grid 1 voltage (negative value) . . . . .	0	150	V
Peak heater to cathode voltage:			
heater positive with respect to cathode . . . . .	—	125	V
heater negative with respect to cathode . . . . .	—	125	V
Cathode current . . . . .	—	2.0	mA
Viewing screen supply impedance . . . . .	1.0	5.0	MΩ

**Writing Gun** (All voltages are with respect to anode 1 and anode 3 unless otherwise stated. See note 5)

	<b>Min</b>	<b>Max</b>	
Heater voltage (across heater) . . . . .	6.0	6.6	V
Mean deflection plate voltages (see note 6)† . . . . .	—	200	V
X-plate shield (geometry control) voltage (see note 7)† . . . . .	—	200	V
Inter-plate shield voltage (see note 8)† . . . . .	—	200	V
Y-plate shield voltage (see note 9)† . . . . .	—	200	V
Anode 4 (astigmatism control) voltage (see note 10)† . . . . .	—	200	V
Anode 2 (focus) voltage (negative value) . . . . .	—	2200	V
Grid 1 voltage with respect to writing gun cathode (negative value) . . . . .	0	200	V
Cathode voltage (negative value) . . . . .	—	2200	V
Peak heater to cathode voltage:			
heater positive with respect to cathode . . . . .	—	125	V
heater negative with respect to cathode . . . . .	—	125	V
Grid to cathode circuit impedance . . . . .	—	1.0	MΩ

† Positive or negative values

## TYPICAL OPERATION

### Flood Gun (All voltages with respect to flood gun cathode)

Screen voltage (see note 4)	6.0	kV
Screen current	0.25	mA max
Backing electrode voltage:		
storage operation	2.0	V
non-storage operation	-50	V
Backing electrode current	0.5	mA max
Grid 5 voltage	110	V
Grid 5 current	0.75	mA max
Grid 4 voltage	40 to 80	V
Grid 4 current	0.5	mA max
Grid 3 and grid 2 voltage (see note 5)	40	V
Grid 3 and grid 2 current	0.2	mA max
Grid 1 voltage	0 to -10	V
Grid 1 cut-off voltage	-50	V max
Cathode current	0.7	mA

### Writing Gun

All voltages with respect to anode 1 and anode 3 unless otherwise stated (see note 5)

Mean deflection plate voltages (see note 6)	0	V
X-plate shield (geometry control) voltage (see note 7)	-70 to +42	V
Inter-plate shield voltage (see note 8)	0	V
Y-plate shield voltage (see note 9)	0	V
Anode 4 (astigmatism control) voltage (see note 10)	-50 to +50	V
Anode 2 (focus) voltage (with respect to writing gun cathode)	70 to 370	V
Grid 1 voltage for cut-off (with respect to writing gun cathode)	-35 to -75	V
Cathode voltage (see note 11)	-1500	V
Cathode current (see note 12)	300	$\mu$ A max

**PERFORMANCE (Under Typical Operation conditions on page 4)**

Screen luminance . . . . .	90ft-lamberts min	
	309	cd/m <sup>2</sup> min
Viewing time (see note 13) . . . . .	90	seconds min
Writing speed (stored) (see note 14) . . . . .	1.0	cm/ $\mu$ s
Deflection factors:		
X direction . . . . .	10 $\pm$ 1	V/cm
Y direction . . . . .	8 $\pm$ 1	V/cm
Linearity of scan . . . . .	2.0	%
Raster distortion (see notes 7, 15 and 16):		
X direction . . . . .	2.1	% max
Y direction . . . . .	3.5	% max
Orthogonality . . . . .	90 $\pm$ 1	degrees
Undelected spot position . . . . .		see note 17
Trace alignment (see note 18) . . . . .	$\pm$ 5	degrees max
Line width (see note 19) . . . . .	0.7	mm max
Orientation (looking at screen with ball contacts down) . . . . .	a positive voltage on X1 deflects spot to left a positive voltage on Y1 deflects spot up	



**NOTES**

1. The writing gun heater must be operated from a separate supply.
2. A d.c. supply is recommended for the flood gun heaters.
3. The tube should be supported near the screen and also on the parallel neck near the base. The tube should not be supported by the base only. The socket should not be mounted rigidly, and should have flexible leads. To avoid the need for excessive magnetic shielding the tube should be mounted as far as possible from sources of magnetic field.
4. The screen may be operated below 6.0kV but the brightness will be reduced.
5. The writing gun anode 1 and anode 3 are internally connected to flood gun grid 2 and grid 3.

- 
6. The deflection plates should be operated near writing gun anode 1 and anode 3 potential (see note 5); it is normally most convenient to operate close to earth potential. The difference between mean X-plate and mean Y-plate potentials should not exceed 5V otherwise some deterioration in performance will result.
  7. Adjustment of the potential on the X-plate shield about mean X-plate potential may be used to correct raster distortion.
  8. The inter-plate shield should be at mean deflection plate potential.
  9. The Y-plate shield should be at mean Y-plate potential.
  10. Adjustment of anode 4 voltage about mean Y-plate potential is used to correct astigmatism.
  11. If a lower voltage is applied to the writing gun cathode the spot size will be degraded and the plate sensitivities enhanced. The voltage required on anode 2 for optimum focus will also change.
  12. For continuous d.c. operation the cathode current should not exceed  $300\mu\text{A}$  or shortened tube life is likely to result. If the cathode current is pulsed, higher currents may safely be drawn from the cathode.
  13. The viewing time is measured as the time for a 3cm diameter circular area of the background to come up to 10% of full brightness from just black. Longer viewing times can be obtained by erasing beyond black or pulsing the flood gun, at the cost of writing speed and brightness respectively.
  14. The specification writing speed limit of  $0.1\text{cm}/\mu\text{s}$  min is the maximum speed that a trace can be written just visibly at any part of a viewing area  $9.0\text{cm} \times 5.0\text{cm}$  starting from just black. An increase in writing speed to approximately  $1.0\text{cm}/\mu\text{s}$  can be obtained if some background is tolerated over the viewing area.
  15. The edges of a  $9.5\text{cm} \times 5.7\text{cm}$  raster will fall between two concentric rectangles  $9.6\text{cm} \times 5.8\text{cm}$  and  $9.4\text{cm} \times 5.6\text{cm}$ .
  16. The X and Y deflection electrodes are designed primarily for symmetrical operation. Some degradation of focus and trace geometry will result if the tube is operated under asymmetric conditions.

17. The distance of the undeflected spot from the geometric centre of the screen area will be 5mm maximum.
18. The angle measured is that between the lower edge of the screened area and a trace filling the viewing area in the X direction while the Y-plates are at anode 1 and anode 3 potential. Any small alignment error may be corrected by passing d.c. (4 ampere-turns/degree) through a suitable coil around the tube near the narrow end of the cone (see outline).
19. The line width is measured by means of a shrinking raster, with  $10\mu\text{A}$  beam current in the non-storage mode.

## SCHEMATIC DIAGRAM

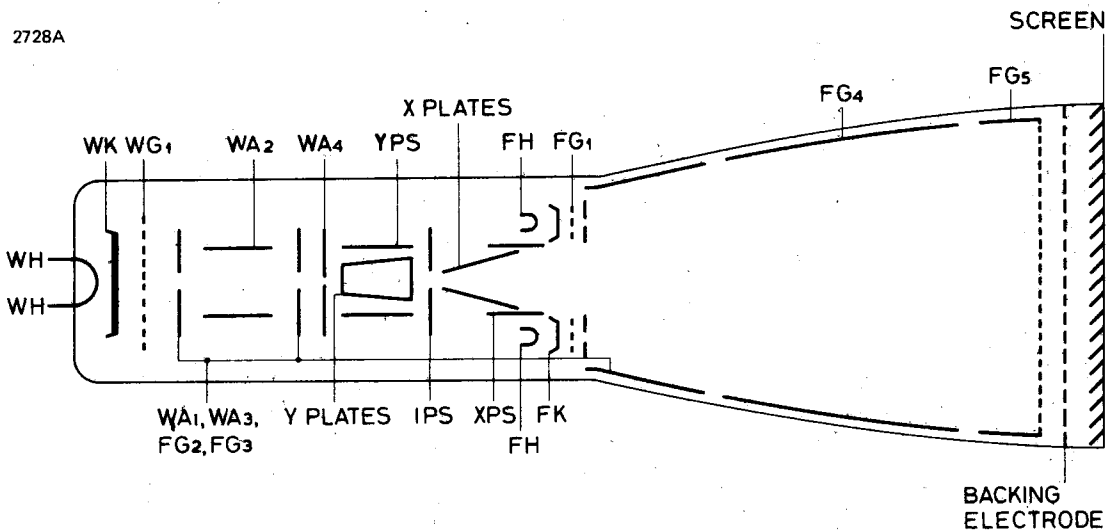

**OUTLINE (All dimensions without limits are nominal)**

3306A

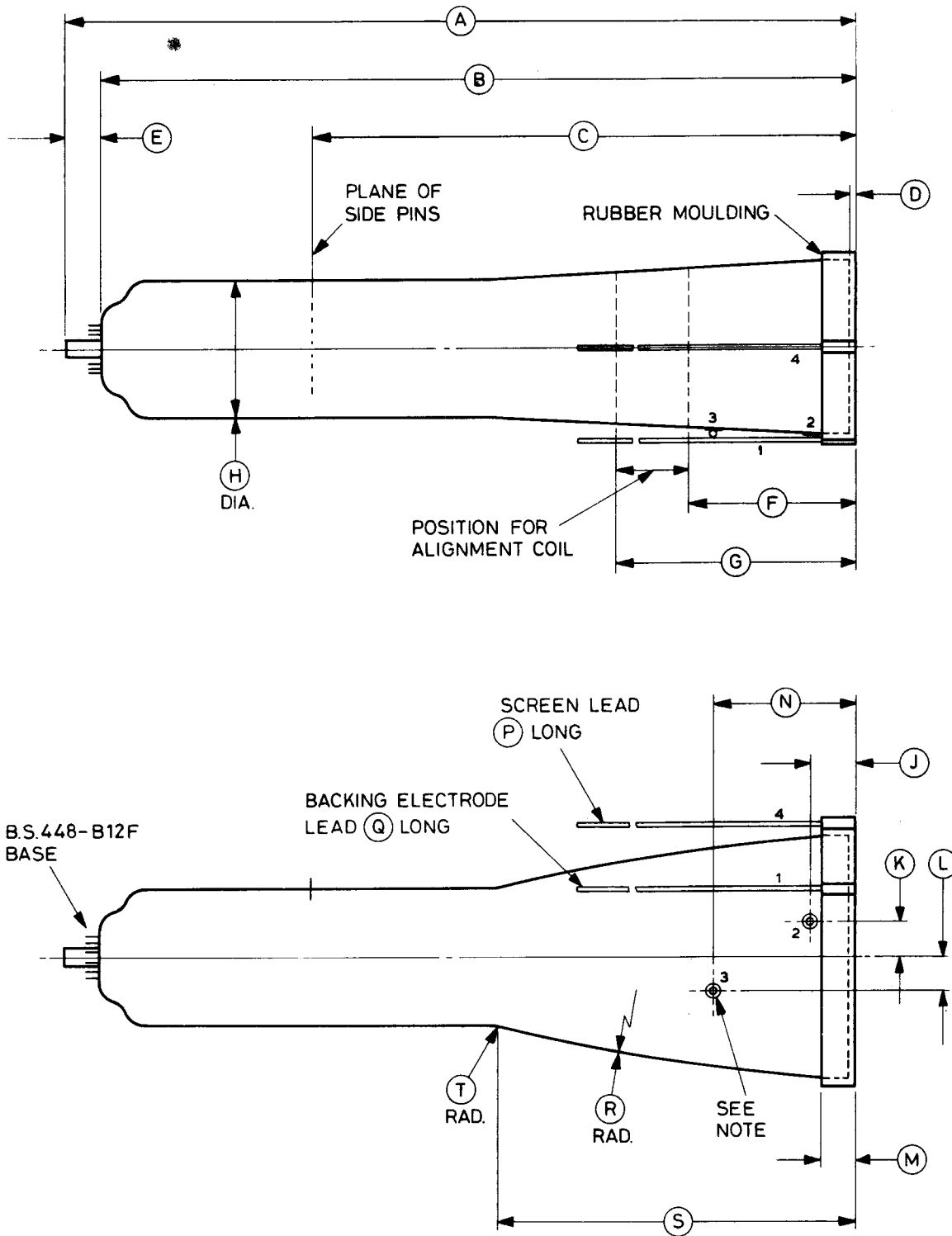

**Outline Note** Ball connections from B.S.448-CT7. Positional tolerance 8.0mm (0.315 inch) diameter.

## OUTLINE (Enlarged view on screen end)

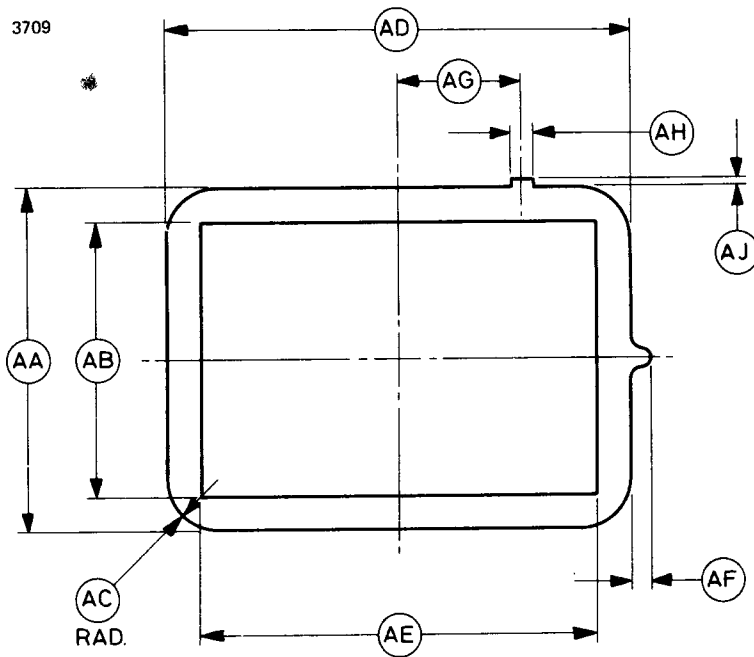

Ref	Millimetres	Inches	Ref	Millimetres	Inches
A	445.0 max	17.520 max	R	750.0	29.528
B	421.0 <sup>+ 3.0</sup> - 7.0	16.575 <sup>+ 0.118</sup> - 0.276	S	196.0	7.717
C	303.0 ± 4.0	11.929 ± 0.158	T	50.0	1.969
D	3.0	0.118	AA*	104.8 max	4.125 max
E	23.0 max	0.905 max	AB*	84.15	3.313
F	93.0	3.661	AC*	15.88	0.625
G	133.0	5.236	AD*	142.9 max	5.625 max
H	78.0 max	3.071 max	AE*	122.3	4.813
J	24.0	0.945	AF*	5.56	0.219
K	19.0	0.748	AG*	38.10	1.500
L	19.0	0.748	AH*	6.35	0.250
M	19.0	0.748	AJ*	2.39	0.094
N	79.0	3.110	AN	1.00	0.039
P	450.0	17.717	AP	6.5 max	0.256 max
Q	450.0	17.717		3.00 min †	0.118 min †

Inch dimensions have been derived from millimetres except where indicated thus \*.

† Minimum useful length.

## OUTLINE (Enlarged view on base end)

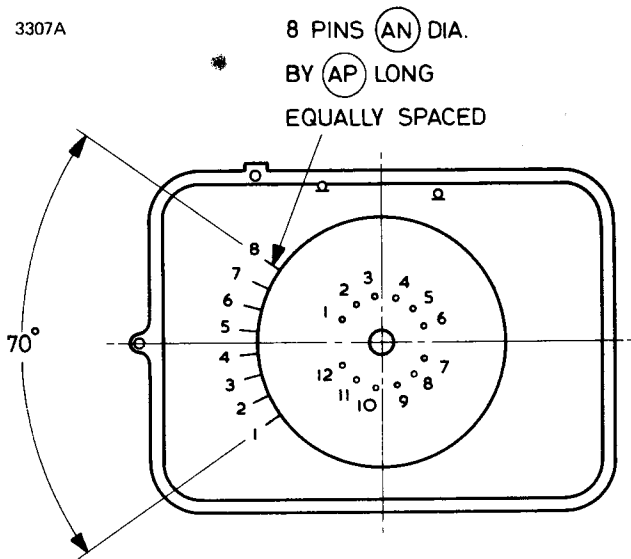

### 12-Pin Base Connections

Pin	Element
1	Writing gun grid 1
2	Writing gun cathode
3	Writing gun heater
4	Writing gun heater
5	Writing gun anode 2
6	Flood gun heater
7	Flood gun heater
8	Flood gun grid 1
9	Flood gun cathode
10	Writing gun anode 1 and anode 3
11	Internal connection
12	Internal connection

### Side Pin Connections

Pin	Element
1	X2 deflection plate
2	X1 deflection plate
3	Writing gun anode 4
4	Inter-plate shield
5	Y-plate shield
6	Y1 deflection plate
7	Y2 deflection plate
8	X-plate shield

### Ball Contact and Lead Connections

Contact	Element
1	Backing electrode
2	Flood gun grid 5
3	Flood gun grid 4
4	Screen



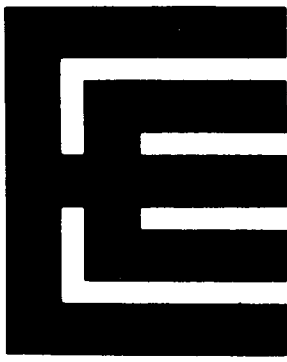

# E714H

## STORAGE CATHODE RAY TUBE

---

The data should be read in conjunction with the Storage Tube Preamble.

### INTRODUCTION

The E714H is a direct view storage cathode ray tube with a 10cm x 6cm viewing area. It is designed for oscilloscope use and is particularly suitable for compact transistorized equipment. It is normally used in the half-tone storage mode, but it will also operate as a p.d.a. oscilloscope tube without storage.

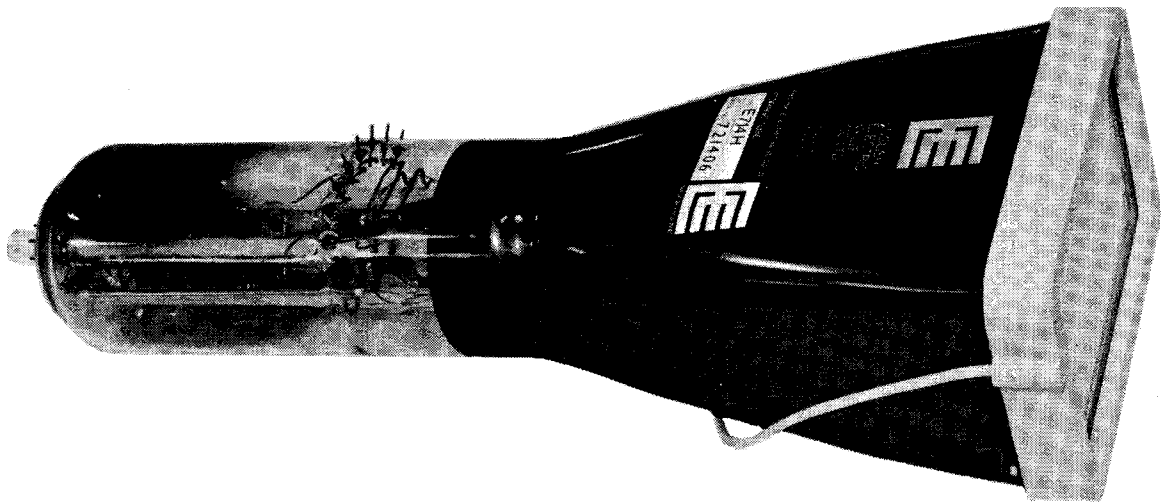

The principal features of the tube are as follows:

- Light output in excess of 90 ft-lamberts ( $309\text{cd/m}^2$ ) in the storage mode.
- Variable persistence — the persistence can be varied from several minutes to less than one second.
- Writing speed of  $1.0\text{cm}/\mu\text{s}$  in the storage mode.
- Good resolution, with typical spot size of 0.4mm.
- Good deflection sensitivity.
- Encapsulated screen lead.

## GENERAL DATA

### Electrical and General

	Writing Gun	Flood Gun	
Cathodes; indirectly heated oxide coated . . . . .	one	one	
Heater voltage (see notes 1 and 2) . . . . .	6.3	6.3	V
Heater current . . . . .	0.3	0.6	A
Focus method . . . . .	electrostatic	electrostatic	
Deflection method . . . . .	electrostatic	—	
Minimum useful scan:			
Y1 to Y2 . . . . .	6.0		cm
X1 to X2 . . . . .	9.8		cm
Faceplate . . . . .		flat, clear glass	
Screen . . . . .		aluminized P31	
Inter-electrode capacitances:			
writing gun grid 1 to all other electrodes . . . . .		10	pF
writing gun cathode to all other electrodes . . . . .		6.0	pF
Y1 to Y2 plate . . . . .		1.0	pF
Y1 plate to all other electrodes except Y2 . . . . .		3.8	pF
Y2 plate to all other electrodes except Y1 . . . . .		3.8	pF
X1 to X2 plate . . . . .		2.6	pF
X1 plate to all other electrodes except X2 . . . . .		6.0	pF
X2 plate to all other electrodes except X1 . . . . .		6.0	pF
flood gun grid 1 to all other electrodes . . . . .		15	pF
backing electrode to all other electrodes . . . . .		150	pF

### Mechanical

Overall length . . . . .	412mm (16.220 inches) max
Overall dimensions, screen end, excluding side pip . . . . .	142.9 x 104.8mm max 5.625 x 4.125 inches max
Neck diameter . . . . .	78mm (3.071 inches) max
Net weight . . . . .	4 pounds (1.8kg) approx
Base . . . . .	B.S.448-B12F
Mounting position (see note 3) . . . . .	any

## MAXIMUM AND MINIMUM RATINGS (Absolute values)

No individual rating should be exceeded

**Flood Gun** (All voltages are with respect to the flood gun cathode unless otherwise stated. See note 4)

	Min	Max	
Heater voltage (across heater) . . . . .	6.0	6.6	V
Viewing screen voltage . . . . .	see note 5	7.0	kV
Backing electrode positive voltage (except on clearance) . . . . .	—	20	V
Backing electrode negative voltage . . . . .	—	60	V
Grid 5 (collector mesh) voltage . . . . .	—	150	V
Grid 4 (collimator) voltage . . . . .	—	150	V
Grid 3 and grid 2 voltage (see notes 6 and 7) . . . . .	—	100	V
Grid 1 voltage (negative value) . . . . .	0	150	V
Peak heater to cathode voltage:			
heater positive with respect to cathode . . . . .	—	125	V
heater negative with respect to cathode . . . . .	—	125	V
Cathode current . . . . .	—	2.0	mA
Viewing screen supply impedance . . . . .	1.0	5.0	MΩ

**Writing Gun** (All voltages are with respect to anode 1 and anode 3 unless otherwise stated. See note 6)

	Min	Max	
Heater voltage (across heater) . . . . .	6.0	6.6	V
Mean deflection plate voltages (see note 7)† . . . . .	—	200	V
X-plate shield (geometry control) voltage (see note 8)† . . . . .	—	200	V
Inter-plate shield voltage (see note 9)† . . . . .	—	200	V
Y-plate shield voltage (see note 10)† . . . . .	—	200	V
Anode 4 (astigmatism control) voltage (see note 11)† . . . . .	—	200	V
Anode 2 (focus) voltage (negative value) . . . . .	—	2200	V
Grid 1 voltage with respect to writing gun cathode (negative value) . . . . .	0	200	V
Cathode voltage (negative value) . . . . .	—	2200	V
Peak heater to cathode voltage:			
heater positive with respect to cathode . . . . .	—	125	V
heater negative with respect to cathode . . . . .	—	125	V
Grid to cathode circuit impedance . . . . .	—	1.0	MΩ

† Positive or negative values

## TYPICAL OPERATION

**Flood Gun** (All voltages with respect to flood gun cathode. See note 4)

Screen voltage (see note 5)	6000	V
Screen current	0.25	mA max
Backing electrode voltage:		
storage operation	0 to 11	V
non-storage operation	-50	V
Backing electrode current	0.5	mA max
Grid 5 voltage	110	V
Grid 5 current	0.75	mA max
Grid 4 voltage	40 to 100	V
Grid 4 current	0.5	mA max
Grid 3 and grid 2 voltage (see note 6)	40 to 100	V
Grid 3 and grid 2 current	0.2	mA max
Grid 1 voltage	0 to -20	V
Grid 1 cut-off voltage	-50	V max
Cathode current	0.7	mA

## Writing Gun

All voltages with respect to anode 1 and anode 3 unless otherwise stated (see note 6)

Mean deflection plate voltages (see note 7)	0	V
X-plate shield (geometry control) voltage (see note 8)	-70 to +60	V
Inter-plate shield voltage (see note 9)	0	V
Y-plate shield voltage (see note 10)	0	V
Anode 4 (astigmatism control) voltage (see note 11)	-50 to +50	V
Anode 2 (focus) voltage (with respect to writing gun cathode)	70 to 370	V
Grid 1 voltage for cut-off (with respect to writing gun cathode)	-35 to -75	V
Cathode voltage (see note 12)	-1500	V
Cathode current (see note 13)	500	$\mu$ A max

**PERFORMANCE (Under Typical Operation conditions on page 4)**

Screen luminance . . . . .	90ft-lamberts min 309 cd/m <sup>2</sup> min
Viewing time (see note 14) . . . . .	60 seconds min
Writing speed (stored) (see note 15) . . . . .	1.0 cm/ $\mu$ s
Deflection factors:	
X direction . . . . .	11.5 $\pm$ 1.0 V/cm
Y direction . . . . .	11.5 $\pm$ 1.0 V/cm
Linearity of scan . . . . .	2 %
Raster distortion (see notes 8, 16 and 17):	
X direction . . . . .	2.1 % max
Y direction . . . . .	3.5 % max
Orthogonality . . . . .	90 $\pm$ 1 degrees
Undelected spot position (see note 18):	
error in X direction . . . . .	$\pm$ 1.0 cm max
error in Y direction . . . . .	$\pm$ 0.6 cm max
Trace alignment (see note 19) . . . . .	$\pm$ 5 degrees max
Line width (see note 20) . . . . .	0.7 mm max
Orientation (looking at screen with surface contacts down) . . . . .	a positive voltage on X1 deflects spot to left a positive voltage on Y1 deflects spot up

**NOTES**

1. The writing gun heater must be operated from a separate supply.
2. A d.c. supply is recommended for the flood gun heaters.
3. The tube should be supported near the screen and also on the parallel neck near the base. The tube should not be supported by the base only. The socket should not be mounted rigidly, and should have flexible leads. To avoid the need for excessive magnetic shielding the tube should be mounted as far as possible from sources of magnetic field.
4. Flood gun grid 2 and grid 3 are operated near the mean X-plate potential (see notes 6 and 7). Floating supplies are required for flood

gun cathode, collimating and backing electrodes; the collimating and backing electrode potentials must be referenced to flood gun cathode.

5. The screen may be operated below 6.0kV but the brightness will be reduced.
6. The writing gun anode 1 and anode 3 are internally connected to flood gun grid 2 and grid 3.
7. The deflection plates should be operated near writing gun anode 1 and anode 3 potential (see note 6); it is normally most convenient to operate close to earth potential. The difference between mean X-plate and mean Y-plate potentials should not exceed 5V otherwise some deterioration in performance will result.
8. Adjustment of the potential on the X-plate shield about mean X-plate potential may be used to correct raster distortion.
9. The inter-plate shield should be at mean deflection plate potential.
10. The Y-plate shield should be at mean Y-plate potential.
11. Adjustment of anode 4 voltage about mean Y-plate potential is used to correct astigmatism.
12. If a lower voltage is applied to the writing gun cathode the spot size will be degraded and the plate sensitivities enhanced. The voltage required on anode 2 for optimum focus will also change.
13. For continuous d.c. operation the cathode current should not exceed  $500\mu\text{A}$  or shortened tube life is likely to result. If the cathode current is pulsed, higher currents may safely be drawn from the cathode.
14. The viewing time is measured as the time for a 3cm diameter circular area of the background to come up to 10% of full brightness from just black. Longer viewing times can be obtained by erasing beyond black or pulsing the flood gun, at the cost of writing speed and brightness respectively.
15. The specification writing speed limit of  $0.1\text{cm}/\mu\text{s}$  min is the maximum speed that a trace can be written just visibly at any part of a viewing area  $9.0\text{cm} \times 5.0\text{cm}$  starting from just black. An increase in writing speed to approximately  $1.0\text{cm}/\mu\text{s}$  can be obtained if some background is tolerated over the viewing area.

16. The edges of a 9.5cm x 5.7cm raster will fall between two concentric rectangles 9.6cm x 5.8cm and 9.4cm x 5.6cm.
17. The X and Y deflection electrodes are designed primarily for symmetrical operation. Some degradation of focus and trace geometry will result if the tube is operated under asymmetric conditions.
18. The tolerances give the size of a rectangle centred on the geometric centre of the screened area.
19. The angle measured is that between the lower edge of the screened area and a trace filling the viewing area in the X direction while the Y-plates are at anode 1 and anode 3 potential. Any small alignment error may be corrected by passing d.c. (4 ampere-turns/degree) through a suitable coil around the tube near the narrow end of the cone (see outline).
20. The line width is measured by means of a shrinking raster, with 10 $\mu$ A beam current in the non-storage mode.

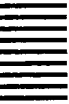

## SCHEMATIC DIAGRAM

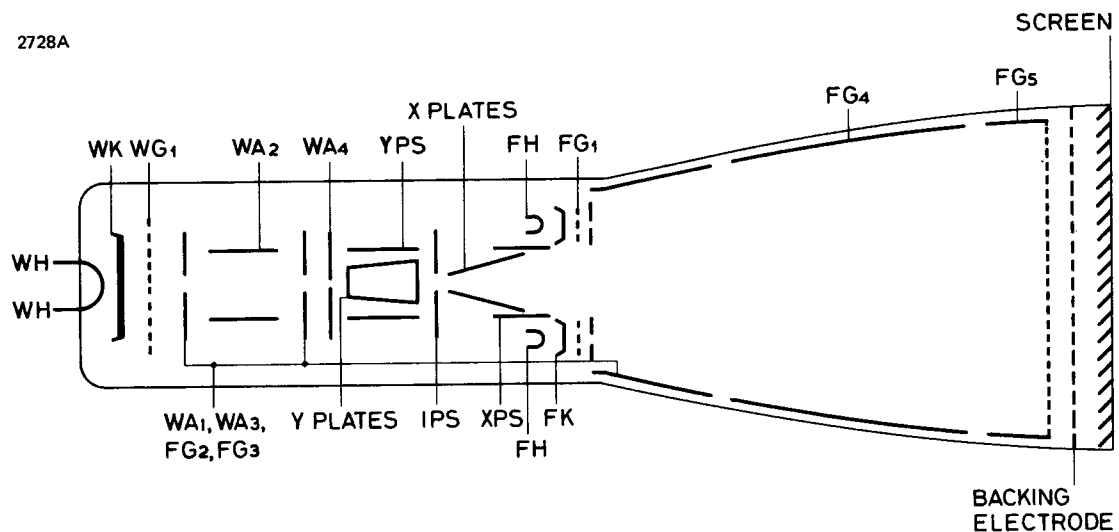

**OUTLINE (All dimensions without limits are nominal)**

3710

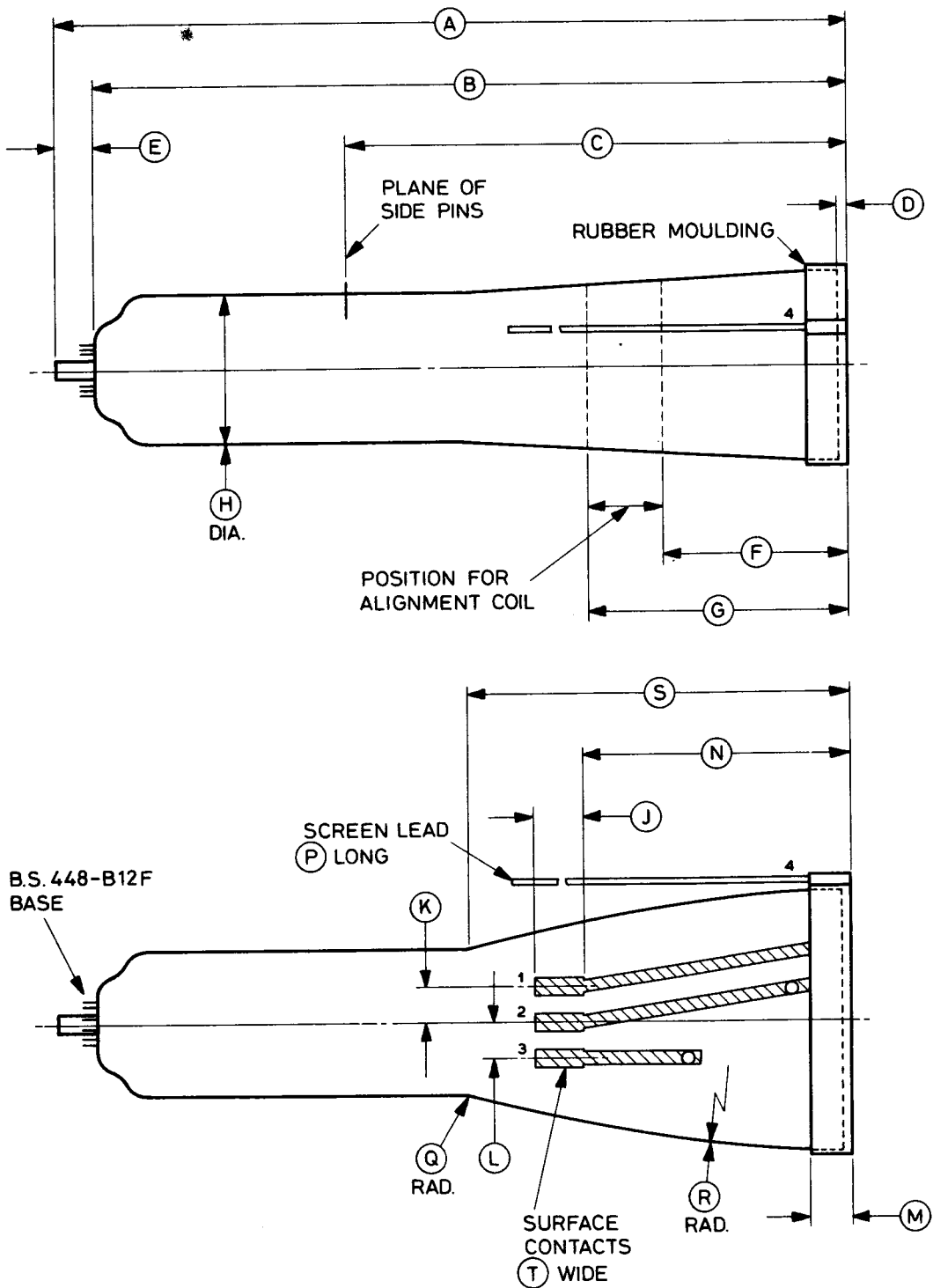



## OUTLINE (Enlarged view on screen end)

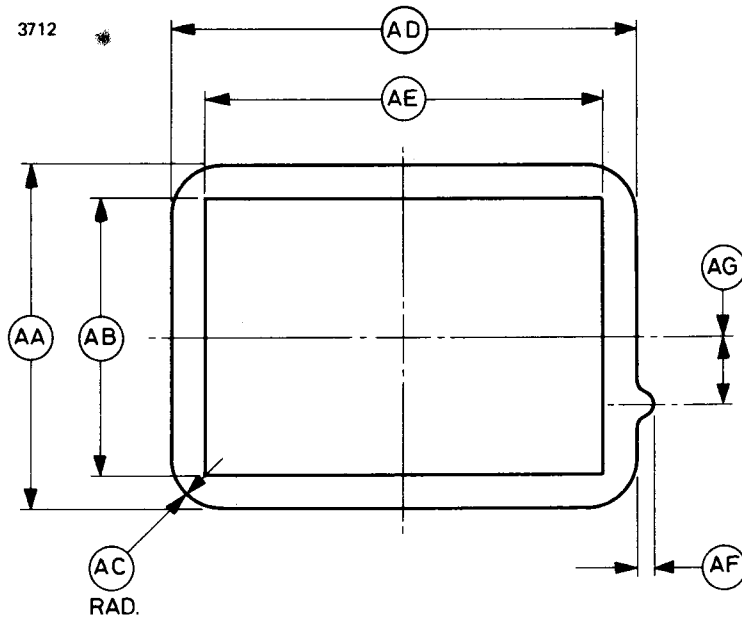

Ref	Millimetres	Inches	Ref	Millimetres	Inches
A	412.0 max	16.220 max	Q	50.0	1.969
B	388.0 + 3.00 - 7.00	15.276 + 0.118 - 0.276	R	750.0	29.528
C	260.5 ± 10.0	10.256 ± 0.394	S	198.5	7.815
D	5.5	0.217	T	9.5 ± 1.0	0.374 ± 0.039
E	23.0 max	0.905 max	AA*	104.8 max	4.125 max
F	95.5	3.760	AB*	84.15	3.313
G	135.5	5.335	AC*	15.9	0.625
H	78.0 max	3.071 max	AD*	142.9 max	5.625 max
J	25.4 ± 1.0	1.000 ± 0.039	AE*	122.3	4.813
K	19.0 ± 3.0	0.748 ± 0.118	AF*	5.56	0.219
L	19.0 ± 3.0	0.748 ± 0.118	AG	20.0	0.787
M	21.5	0.846	AN	1.0	0.039
N	139.0 ± 3.0	5.472 ± 0.118	AP	6.5 max	0.256 max
P	450.0 min	17.717 min		3.0 min †	0.118 min †

Inch dimensions have been derived from millimetres except where indicated thus \*.

† Minimum useful length

## OUTLINE (Enlarged view on base end)

3711

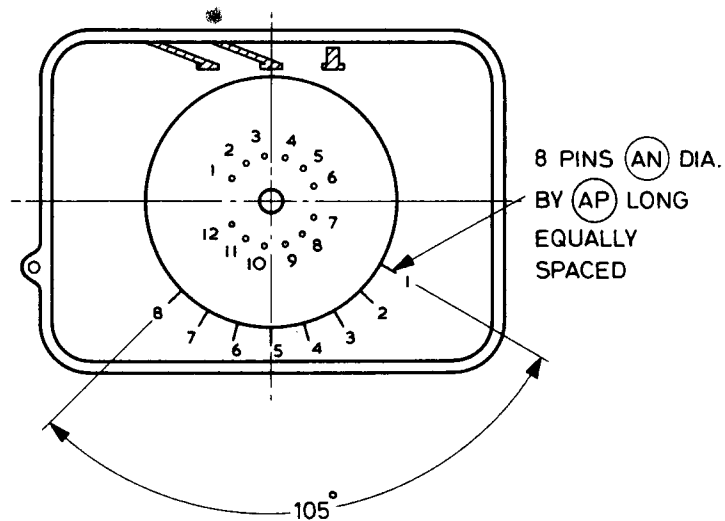

### 12-Pin Base Connections

Pin	Element
1	Writing gun grid 1
2	Writing gun cathode
3	Writing gun heater
4	Writing gun heater
5	Writing gun anode 2
6	Flood gun heater
7	Flood gun heater
8	Flood gun grid 1
9	Flood gun cathode
10	Writing gun anode 1 and anode 3
11	Internal connection
12	Internal connection

### Side Pin Connections

Pin	Element
1	X2 deflection plate
2	X1 deflection plate
3	Writing gun anode 4
4	Inter-plate shield
5	Y-plate shield
6	Y1 deflection plate
7	Y2 deflection plate
8	X-plate shield

### Surface Contact and Lead Connections

Contact	Element
1	Backing electrode
2	Flood gun grid 5
3	Flood gun grid 4
4	Screen

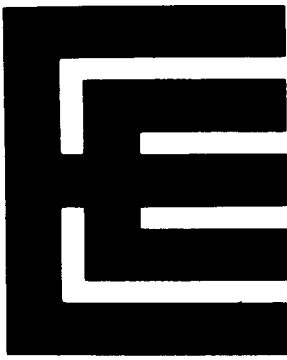

## STORAGE CATHODE RAY TUBE

### PROVISIONAL INFORMATION

The data should be read in conjunction with the Storage Tube Preamble.

### INTRODUCTION

The E716A is a direct view storage cathode ray tube with a 10cm x 10cm viewing area. It is designed for oscilloscope use and is particularly suitable for compact transistorized equipment. It is normally used in the half-tone storage mode, but it will also operate as a p.d.a. oscilloscope tube without storage.

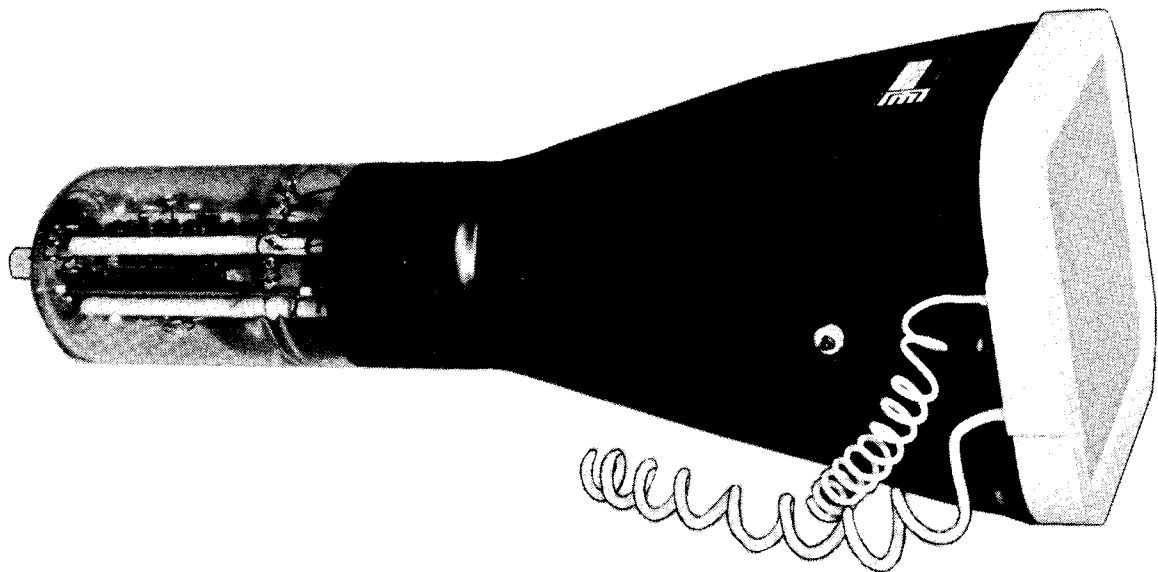

The principal features of the tube are as follows:

- Light output in excess of 90 ft-lamberts ( $309\text{cd/m}^2$ ) in the storage mode.
- Variable persistence — the persistence can be varied from several minutes to less than one second.
- Writing speed of  $1.0\text{cm}/\mu\text{s}$  in the storage mode.
- Good resolution, with typical spot size of 0.4mm.
- Good deflection sensitivity.
- Encapsulated screen lead.
- Suitable mumetal shield, rotation coil, base socket and connectors can be supplied.

## GENERAL DATA

### Electrical and General

	Writing Gun	Flood Gun
Cathodes; indirectly heated oxide coated . . . . .	one	one
Heater voltage (see notes 1 and 2) . . . . .	6.3	6.3 V
Heater current . . . . .	0.3	0.6 A
Focus method . . . . .	electrostatic	electrostatic
Deflection method . . . . .	electrostatic	none
Minimum useful scan:		
Y1 to Y2 . . . . .	10	cm
X1 to X2 . . . . .	10	cm
Faceplate . . . . .		flat, clear glass
Screen . . . . .		aluminized P31
Inter-electrode capacitances:		
writing gun grid 1 to all other electrodes . . . . .	10	pF
writing gun cathode to all other electrodes . . . . .	6.0	pF
Y1 to Y2 plate . . . . .	1.4	pF
Y1 plate to all other electrodes except Y2 . . . . .	4.2	pF
Y2 plate to all other electrodes except Y1 . . . . .	4.2	pF
X1 to X2 plate . . . . .	2.5	pF
X1 plate to all other electrodes except X2 . . . . .	5.5	pF
X2 plate to all other electrodes except X1 . . . . .	5.5	pF
flood gun grid 1 to all other electrodes . . . . .	15	pF
backing electrode to all other electrodes . . . . .	250	pF

### Mechanical

Overall length . . . . .	445mm (17.52 inches) max
Overall dimensions, screen end, excluding side pips . . . . .	143.2 x 143.2mm max 5.638 x 5.638 inches max
Neck diameter . . . . .	78mm (3.071 inches) max
Net weight . . . . .	2.0kg (4.4 pounds) approx
Base . . . . .	B.S.448-B12F
Mounting position (see note 3) . . . . .	any

## MAXIMUM AND MINIMUM RATINGS (Absolute values)

No individual rating should be exceeded

**Flood Gun** (All voltages are with respect to the flood gun cathode unless otherwise stated)

	Min	Max	
Heater voltage (across heater) . . . . .	6.0	6.6	V
Viewing screen voltage . . . . .	see note 4	7.0	kV
Backing electrode positive voltage (except on clearance) . . . . .	—	20	V
Backing electrode negative voltage . . . . .	—	60	V
Grid 5 (collector mesh) voltage . . . . .	—	150	V
Grid 4 (collimator) voltage . . . . .	—	150	V
Grid 3 and grid 2 voltage (see notes 5 and 6) . . . . .	—	100	V
Grid 1 voltage (negative value) . . . . .	0	150	V
Peak heater to cathode voltage:			
heater positive with respect to cathode . . . . .	—	125	V
heater negative with respect to cathode . . . . .	—	125	V
Cathode current . . . . .	—	2.0	mA
Viewing screen supply impedance . . . . .	1.0	5.0	MΩ

**Writing Gun** (All voltages are with respect to anode 1 and anode 3 unless otherwise stated. See note 5)

	Min	Max	
Heater voltage (across heater) . . . . .	6.0	6.6	V
Mean deflection plate voltages (see note 6)† . . . . .	—	200	V
X-plate shield (geometry control) voltage (see note 7)† . . . . .	—	200	V
Inter-plate shield voltage (see note 8)† . . . . .	—	200	V
Y-plate shield voltage (see note 9)† . . . . .	—	200	V
Anode 4 (astigmatism control) voltage (see note 10)† . . . . .	—	200	V
Anode 2 (focus) voltage (negative value) . . . . .	—	2200	V
Grid 1 voltage with respect to writing gun cathode (negative value) . . . . .	0	200	V
Cathode voltage (negative value) . . . . .	—	2200	V
Peak heater to cathode voltage:			
heater positive with respect to cathode . . . . .	—	125	V
heater negative with respect to cathode . . . . .	—	125	V
Grid to cathode circuit impedance . . . . .	—	1.0	MΩ

† Positive or negative values

## TYPICAL OPERATION

### Flood Gun (All voltages with respect to flood gun cathode)

Screen voltage (see note 4)	6.0	kV
Screen current	0.25	mA max
Backing electrode voltage:		
storage operation	2.0 to 5.0	V
non-storage operation	-50	V
Backing electrode current	0.5	mA max
Grid 5 voltage	110	V
Grid 5 current	0.75	mA max
Grid 4 voltage	40 to 80	V
Grid 4 current	0.5	mA max
Grid 3 and grid 2 voltage (see note 5)	40	V
Grid 3 and grid 2 current	0.2	mA max
Grid 1 voltage	0 to -10	V
Grid 1 cut-off voltage	-50	V max
Cathode current	0.8	mA

### Writing Gun

All voltages with respect to anode 1 and anode 3 unless otherwise stated (see note 5)

Mean deflection plate voltages (see note 6)	0	V
X-plate shield (geometry control) voltage (see note 7)	0 to +100	V
Inter-plate shield voltage (see note 8)	0	V
Y-plate shield voltage (see note 9)	0	V
Anode 4 (astigmatism control) voltage (see note 10)	-50 to +50	V
Anode 2 (focus) voltage (with respect to writing gun cathode)	70 to 370	V
Grid 1 voltage for cut-off (with respect to writing gun cathode)	-35 to -75	V
Cathode voltage (see note 11)	-1500	V
Cathode current (see note 12)	300	$\mu$ A max

**PERFORMANCE (Under Typical Operation conditions on page 4)**

Screen luminance . . . . .	90ft-lamberts min 309 cd/m <sup>2</sup> min
Viewing time (see note 13) . . . . .	90 seconds min
Writing speed (stored) (see note 14) . . . . .	1.0 cm/ $\mu$ s
Deflection factors:	
X direction . . . . .	13.5 $\pm$ 1.0 V/cm
Y direction . . . . .	7.0 $\pm$ 1.0 V/cm
Linearity of scan . . . . .	2.0 %
Raster distortion (see notes 7, 15 and 16):	
X direction . . . . .	3.0 % max
Y direction . . . . .	2.0 % max
Orthogonality . . . . .	90 $\pm$ 1 degrees
Undelected spot position . . . . .	see note 17
Trace alignment (see note 18) . . . . .	$\pm$ 5 degrees max
Line width (see note 19) . . . . .	0.7 mm max
Orientation (looking at screen with ball contacts on left) . . . . .	a positive voltage on X1 deflects spot to left a positive voltage on Y1 deflects spot up

**NOTES**

1. The writing gun heater must be operated from a separate supply.
2. A d.c. supply is recommended for the flood gun heater.
3. The tube should be supported near the screen and also on the parallel neck near the base. The tube should not be supported by the base only. The socket should not be mounted rigidly, and should have flexible leads. To avoid the need for excessive magnetic shielding the tube should be mounted as far as possible from sources of magnetic field.
4. The screen may be operated below 6.0kV but the brightness will be reduced.
5. The writing gun anode 1 and anode 3 are internally connected to flood gun grid 2 and grid 3.

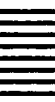
- 
6. The deflection plates should be operated near writing gun anode 1 and anode 3 potential (see note 5); it is normally most convenient to operate close to earth potential. The difference between mean X-plate and mean Y-plate potentials should not exceed 5V otherwise some deterioration in performance will result.
  7. Adjustment of the potential on the X-plate shield about mean X-plate potential may be used to correct raster distortion.
  8. The inter-plate shield should be at mean deflection plate potential.
  9. The Y-plate shield should be at mean Y-plate potential.
  10. Adjustment of anode 4 voltage about mean Y-plate potential is used to correct astigmatism.
  11. If a lower voltage is applied to the writing gun cathode the spot size will be degraded and the plate sensitivities enhanced. The voltage required on anode 2 for optimum focus will also change.
  12. For continuous d.c. operation the cathode current should not exceed  $300\mu\text{A}$  or shortened tube life is likely to result. If the cathode current is pulsed, higher currents may safely be drawn from the cathode.
  13. The viewing time is measured as the time for a 3cm diameter circular area of the background to come up to 10% of full brightness from just black. Longer viewing times can be obtained by erasing beyond black or pulsing the flood gun, at the cost of writing speed and brightness respectively.
  14. The specification writing speed limit of  $0.1\text{cm}/\mu\text{s}$  min is the maximum speed that a trace can be written just visibly at any part of a viewing area  $9.0\text{cm} \times 9.0\text{cm}$  starting from just black. An increase in writing speed to approximately  $1.0\text{cm}/\mu\text{s}$  can be obtained if some background is tolerated over the viewing area.
  15. The edges of a  $10.0\text{cm} \times 10.0\text{cm}$  raster will fall between two concentric rectangles  $10.15\text{cm} \times 10.1\text{cm}$  and  $9.85\text{cm} \times 9.9\text{cm}$ .
  16. The X and Y deflection electrodes are designed primarily for symmetrical operation. Some degradation of focus and trace geometry will result if the tube is operated under asymmetric conditions.



17. The distance of the undeflected spot from the centre of the viewing area will be 5mm maximum.
18. The angle measured is that between a horizontal line passing through the centre of the viewing area and a trace filling the viewing area in the X direction while the Y-plates are at anode 1 and anode 3 potential. Any small alignment error may be corrected by passing d.c. (4 ampere-turns/degree) through a suitable coil around the tube near the narrow end of the cone (see outline).
19. The line width is measured by means of a shrinking raster, with  $10\mu\text{A}$  beam current in the non-storage mode.

## SCHEMATIC DIAGRAM

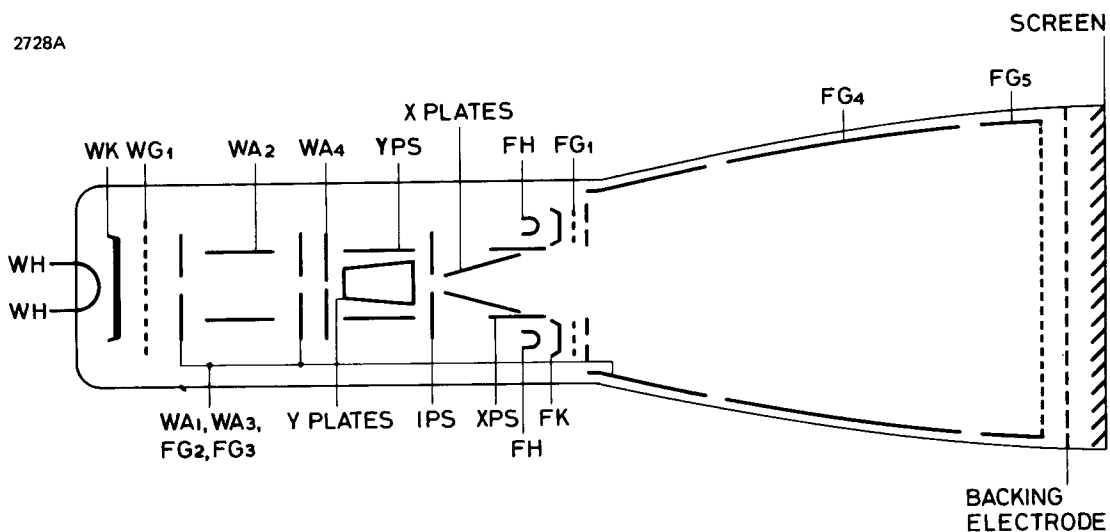

**OUTLINE (All dimensions without limits are nominal)**

3603A

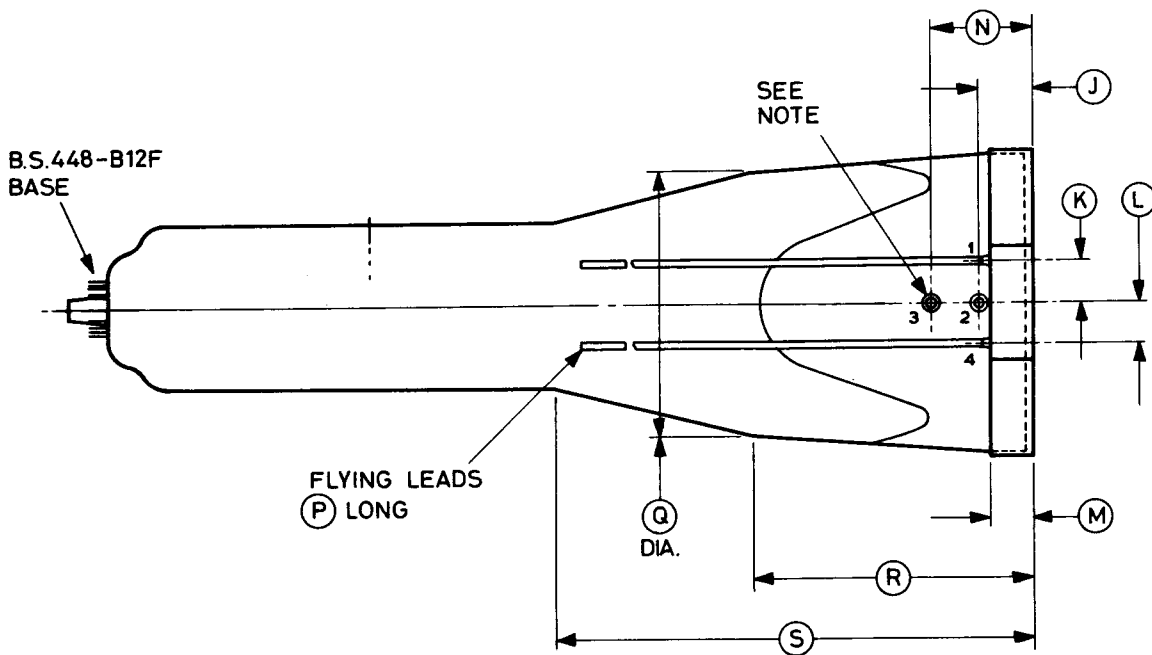
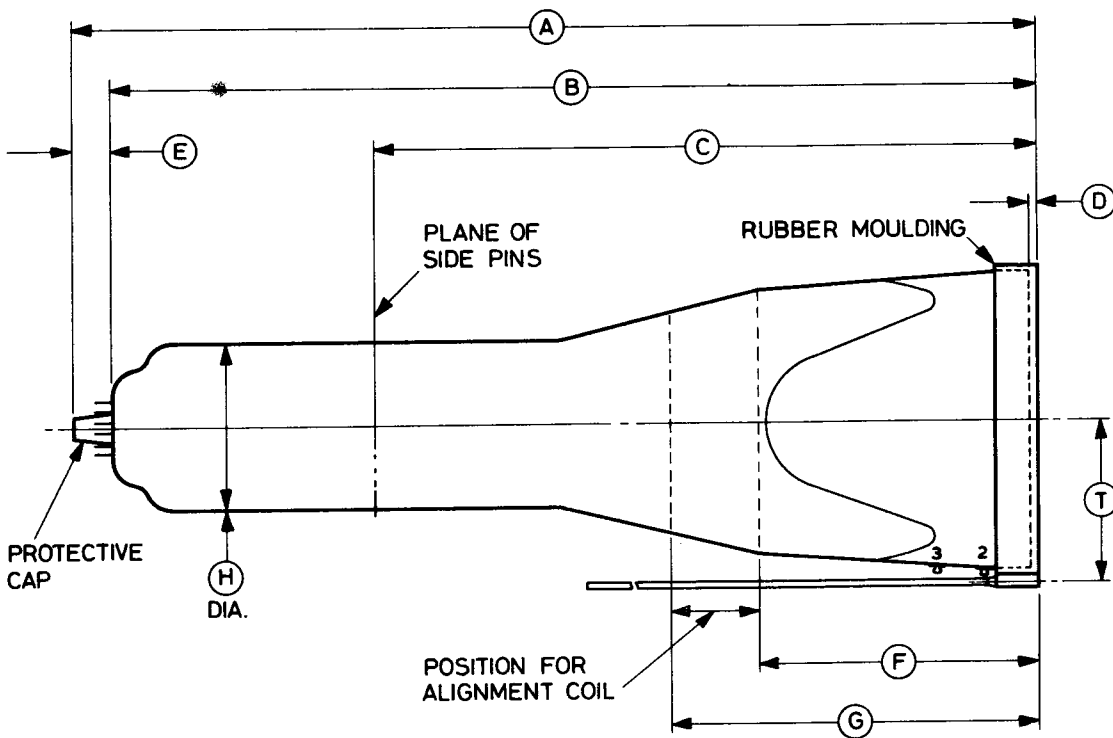

**Outline Note** Ball connections from B.S.448-CT7. Positional tolerance 8.0mm (0.315 inch) diameter.

## OUTLINE (Enlarged view on screen end)

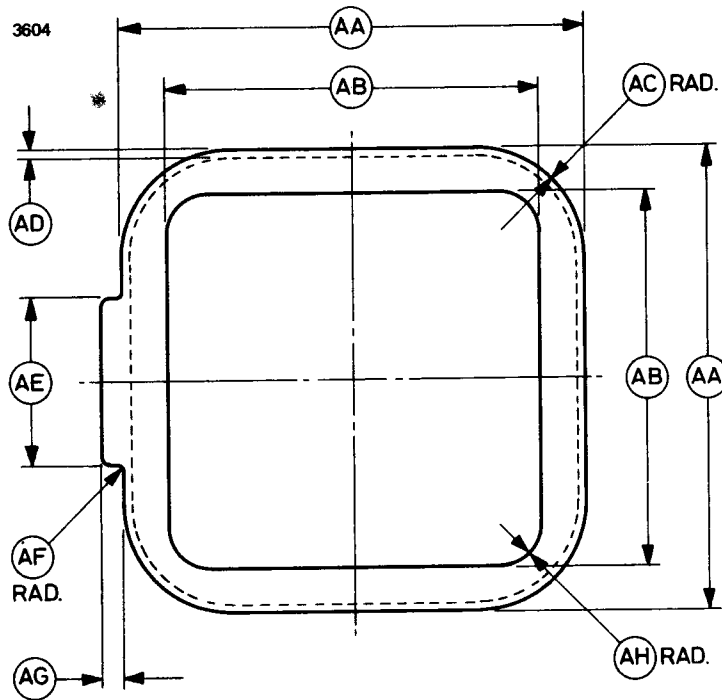

Ref	Millimetres	Inches	Ref	Millimetres	Inches
A	445.0 max	17.520 max	Q	122.0	4.803
B	421.0 <sup>+ 3.0</sup> - 7.0	16.575 <sup>+ 0.118</sup> - 0.276	R	131.0	5.157
C	303.0 ± 5.0	11.929 ± 0.197	S	221.0	8.701
D	3.0	0.118	T	73.5	2.894
E	23.0 max	0.906 max	AA	143.0	5.630
F	130.0	5.118	AB	115.0	4.528
G	170.0	6.693	AC	33.5	1.319
H	78.0 max	3.071 max	AD	2.5	0.098
J	24.0	0.945	AE	52.0	2.047
K	19.0	0.748	AF	1.0	0.039
L	19.0	0.748	AG	6.0	0.236
M	19.0	0.748	AH	12.5	0.492
N	47.0	1.850	AM	1.0	0.039
P	450.0	17.717	AN	6.5 max 3.0 min†	0.256 max 0.118 min†

Inch dimensions have been derived from millimetres.

† Minimum useful length

## OUTLINE (Enlarged view on base end)

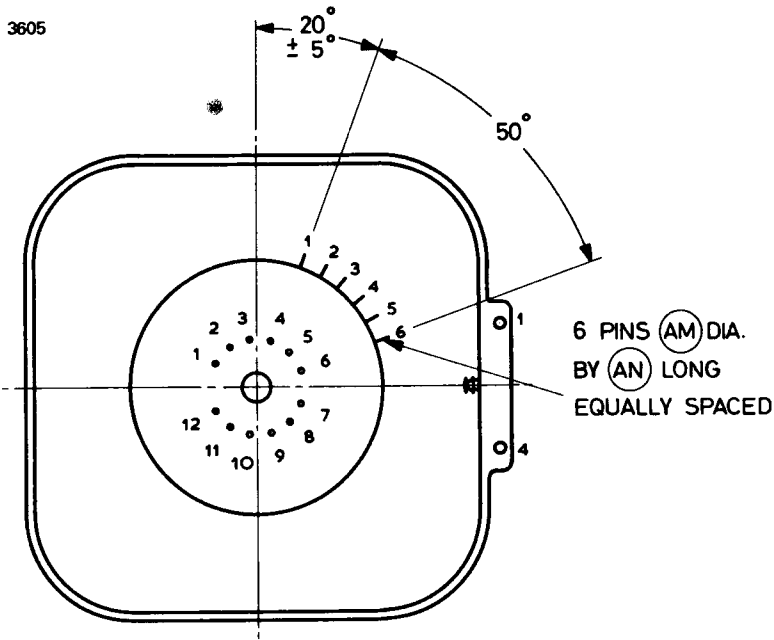

### 12-Pin Base Connections

Pin	Element
1	Writing gun grid 1
2	Writing gun cathode
3	Writing gun heater
4	Writing gun heater
5	Writing gun anode 2
6	Flood gun heater
7	Flood gun heater
8	Flood gun grid 1
9	Flood gun cathode
10	Writing gun anode 1
	Writing gun anode 3
	Flood gun grid 2
	Flood gun grid 3
11	Y-plate shield
12	Writing gun anode 4

### Ball Contact and Lead Connections

Contact	Element
1	Backing electrode
2	Flood gun grid 5
3	Flood gun grid 4
4	Screen

### Side Pin Connections

Pin	Element
1	X2 deflection plate
2	X1 deflection plate
3	Inter-plate shield
4	X-plate shield
5	Y1 deflection plate
6	Y2 deflection plate

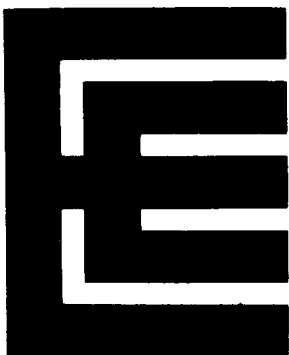

## STORAGE CATHODE RAY TUBE

---

### PROVISIONAL INFORMATION

The data should be read in conjunction with the Storage Tube Preamble.

### INTRODUCTION

The E719A is a direct view storage cathode ray tube with a 10cm x 6cm viewing area. It is designed for oscilloscope use and is particularly suitable for compact transistorized equipment. It is normally used in the half-tone storage mode, but it will also operate as a p.d.a. oscilloscope tube without storage.



The principal features of the tube are as follows:

- Light output in excess of 90 ft-lamberts ( $309\text{cd/m}^2$ ) in the storage mode.
- Variable persistence — the persistence can be varied from several minutes to less than one second.
- Writing speed of  $1.0\text{cm}/\mu\text{s}$  in the storage mode.
- Good resolution, with typical spot size of 0.4mm.
- Good deflection sensitivity.
- Encapsulated screen lead.
- Suitable mumetal shield, rotation coil, base socket and connectors can be supplied.

## GENERAL DATA

### Electrical and General

	Writing Gun	Flood Gun	
Cathodes; indirectly heated oxide coated . . . . .	one	one	
Heater voltage (see notes 1 and 2) . . . . .	6.3	6.3	V
Heater current . . . . .	0.3	0.6	A
Focus method . . . . .	electrostatic	electrostatic	
Deflection method . . . . .	electrostatic	none	
Minimum useful scan:			
Y1 to Y2 . . . . .	6.0		cm
X1 to X2 . . . . .	10.0		cm
Faceplate . . . . .		flat, clear glass	
Screen . . . . .		aluminized P31	
Inter-electrode capacitances:			
writing gun grid 1 to all other electrodes . . . . .	10		pF
writing gun cathode to all other electrodes . . . . .	6.0		pF
Y1 to Y2 plate . . . . .	1.5		pF
Y1 plate to all other electrodes except Y2 . . . . .	4.0		pF
Y2 plate to all other electrodes except Y1 . . . . .	4.0		pF
X1 to X2 plate . . . . .	2.5		pF
X1 plate to all other electrodes except X2 . . . . .	5.5		pF
X2 plate to all other electrodes except X1 . . . . .	5.5		pF
flood gun grid 1 to all other electrodes . . . . .	15		pF
backing electrode to all other electrodes . . . . .	150		pF

### Mechanical

Overall length . . . . .	445mm (17.52 inches) max
Overall dimensions, screen end, excluding side pips . . . . .	142.9 x 104.8mm max 5.625 x 4.125 inches max
Neck diameter . . . . .	78mm (3.071 inches) max
Net weight . . . . .	1.8kg (4 pounds) approx
Base . . . . .	B.S.448-B12F
Mounting position (see note 3) . . . . .	any

## MAXIMUM AND MINIMUM RATINGS (Absolute values)

No individual rating should be exceeded

**Flood Gun** (All voltages are with respect to the flood gun cathode unless otherwise stated)

	Min	Max	
Heater voltage (across heater) . . . . .	6.0	6.6	V
Viewing screen voltage . . . . .	see note 4	7.0	kV
Backing electrode positive voltage (except on clearance) . . . . .	—	20	V
Backing electrode negative voltage . . . . .	—	60	V
Grid 5 (collector mesh) voltage . . . . .	—	150	V
Grid 4 (collimator) voltage . . . . .	—	150	V
Grid 3 and grid 2 voltage (see notes 5 and 6) . . . . .	—	100	V
Grid 1 voltage (negative value) . . . . .	0	150	V
Peak heater to cathode voltage:			
heater positive with respect to cathode . . . . .	—	125	V
heater negative with respect to cathode . . . . .	—	125	V
Cathode current . . . . .	—	2.0	mA
Viewing screen supply impedance . . . . .	1.0	5.0	MΩ

**Writing Gun** (All voltages are with respect to anode 1 and anode 3 unless otherwise stated. See note 5)

	Min	Max	
Heater voltage (across heater) . . . . .	6.0	6.6	V
Mean deflection plate voltages (see note 6)† . . . . .	—	200	V
X-plate shield (geometry control) voltage (see note 7)† . . . . .	—	200	V
Inter-plate shield voltage (see note 8)† . . . . .	—	200	V
Y-plate shield voltage (see note 9)† . . . . .	—	200	V
Anode 4 (astigmatism control) voltage (see note 10)† . . . . .	—	200	V
Anode 2 (focus) voltage (negative value) . . . . .	—	2200	V
Grid 1 voltage with respect to writing gun cathode (negative value) . . . . .	0	200	V
Cathode voltage (negative value) . . . . .	—	2200	V
Peak heater to cathode voltage:			
heater positive with respect to cathode . . . . .	—	125	V
heater negative with respect to cathode . . . . .	—	125	V
Grid to cathode circuit impedance . . . . .	—	1.0	MΩ

† Positive or negative values

## TYPICAL OPERATION

### Flood Gun (All voltages with respect to flood gun cathode)

Screen voltage (see note 4)	6.0	kV
Screen current	0.25	mA max
Backing electrode voltage:		
storage operation	2.0 to 5.0	V
non-storage operation	-50	V
Backing electrode current	0.5	mA max
Grid 5 voltage	110	V
Grid 5 current	0.75	mA max
Grid 4 voltage	40 to 80	V
Grid 4 current	0.5	mA max
Grid 3 and grid 2 voltage (see note 5)	40	V
Grid 3 and grid 2 current	0.2	mA max
Grid 1 voltage	0 to -10	V
Grid 1 cut-off voltage	-50	V max
Cathode current	0.7	mA

### Writing Gun

All voltages with respect to anode 1 and anode 3 unless otherwise stated (see note 5)

Mean deflection plate voltages (see note 6)	0	V
X-plate shield (geometry control) voltage (see note 7)	0 to +100	V
Inter-plate shield voltage (see note 8)	0	V
Y-plate shield voltage (see note 9)	0	V
Anode 4 (astigmatism control) voltage (see note 10)	-50 to +50	V
Anode 2 (focus) voltage (with respect to writing gun cathode)	70 to 370	V
Grid 1 voltage for cut-off (with respect to writing gun cathode)	-35 to -75	V
Cathode voltage (see note 11)	-1500	V
Cathode current (see note 12)	300	$\mu$ A max



**PERFORMANCE (Under Typical Operation conditions on page 4)**

Screen luminance . . . . .	90ft-lamberts min 309 cd/m <sup>2</sup> min
Viewing time (see note 13) . . . . .	90 seconds min
Writing* speed (stored) (see note 14) . . . . .	1.0 cm/ $\mu$ s
Deflection factors:	
X direction . . . . .	13.5 $\pm$ 1 V/cm
Y direction . . . . .	5.6 $\pm$ 1 V/cm
Linearity of scan . . . . .	2.0 %
Raster distortion (see notes 7, 15 and 16):	
X direction . . . . .	2.1 % max
Y direction . . . . .	3.5 % max
Orthogonality . . . . .	90 $\pm$ 1 degrees
Undelected spot position . . . . .	see note 17
Trace alignment (see note 18) . . . . .	$\pm$ 5 degrees max
Line width (see note 19) . . . . .	0.7 mm max
Orientation (looking at screen with ball contacts up) . . . . .	
	a positive voltage on X1 deflects spot to left
	a positive voltage on Y1 deflects spot up

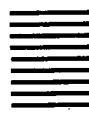

**NOTES**

1. The writing gun heater must be operated from a separate supply.
2. A d.c. supply is recommended for the flood gun heaters.
3. The tube should be supported near the screen and also on the parallel neck near the base. The tube should not be supported by the base only. The socket should not be mounted rigidly, and should have flexible leads. To avoid the need for excessive magnetic shielding the tube should be mounted as far as possible from sources of magnetic field.
4. The screen may be operated below 6.0kV but the brightness will be reduced.
5. The writing gun anode 1 and anode 3 are internally connected to flood gun grid 2 and grid 3.

- 
6. The deflection plates should be operated near writing gun anode 1 and anode 3 potential (see note 5); it is normally most convenient to operate close to earth potential. The difference between mean X-plate and mean Y-plate potentials should not exceed 5V otherwise some deterioration in performance will result.
  7. Adjustment of the potential on the X-plate shield about mean X-plate potential may be used to correct raster distortion.
  8. The inter-plate shield should be at mean deflection plate potential.
  9. The Y-plate shield should be at mean Y-plate potential.
  10. Adjustment of anode 4 voltage about mean Y-plate potential is used to correct astigmatism.
  11. If a lower voltage is applied to the writing gun cathode the spot size will be degraded and the deflection sensitivities enhanced. The voltage required on anode 2 for optimum focus will also change.
  12. For continuous d.c. operation the cathode current should not exceed  $300\mu\text{A}$  or shortened tube life is likely to result. If the cathode current is pulsed, higher currents may safely be drawn from the cathode.
  13. The viewing time is measured as the time for a 3cm diameter circular area of the background to come up to 10% of full brightness from just black. Longer viewing times can be obtained by erasing beyond black or pulsing the flood gun, at the cost of writing speed and brightness respectively.
  14. The specification writing speed limit of  $0.1\text{cm}/\mu\text{s}$  min is the maximum speed that a trace can be written just visibly at any part of a viewing area  $9.0\text{cm} \times 5.0\text{cm}$  starting from just black. An increase in writing speed to approximately  $1.0\text{cm}/\mu\text{s}$  can be obtained if some background is tolerated over the viewing area.
  15. The edges of a  $9.5\text{cm} \times 5.7\text{cm}$  raster will fall between two concentric rectangles  $9.6\text{cm} \times 5.8\text{cm}$  and  $9.4\text{cm} \times 5.6\text{cm}$ .
  16. The X and Y deflection electrodes are designed primarily for symmetrical operation. Some degradation of focus and trace geometry will result if the tube is operated under asymmetric conditions.

17. The distance of the undeflected spot from the geometric centre of the screen area will be 5mm maximum.
18. The angle measured is that between the lower edge of the screened area and a trace filling the viewing area in the X direction while the Y-plates are at anode 1 and anode 3 potential. Any small alignment error may be corrected by passing d.c. (4 ampere-turns/degree) through a suitable coil around the tube near the narrow end of the cone (see outline).
19. The line width is measured by means of a shrinking raster, with  $10\mu\text{A}$  beam current in the non-storage mode.



## SCHEMATIC DIAGRAM

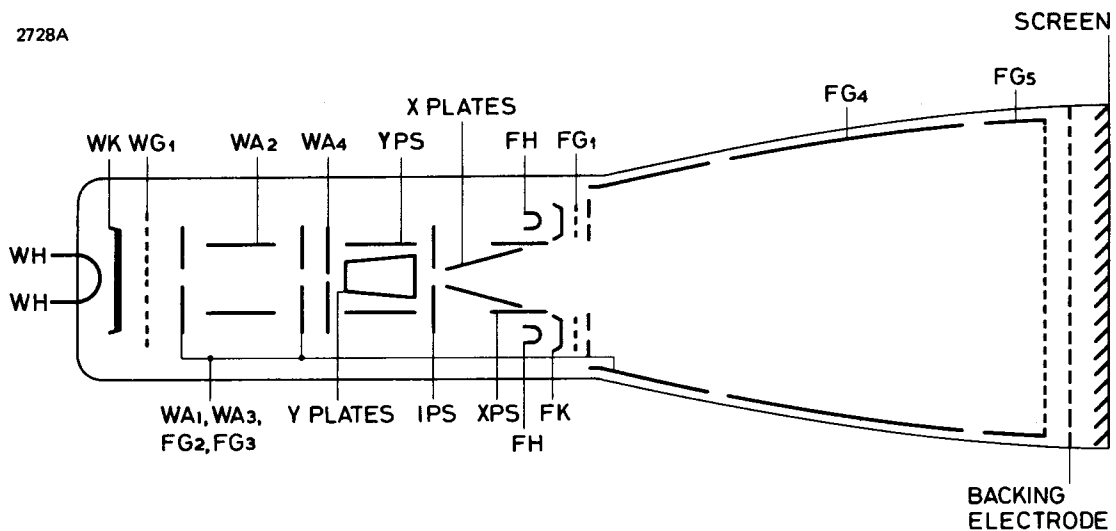

**OUTLINE (All dimensions without limits are nominal)**

3609A

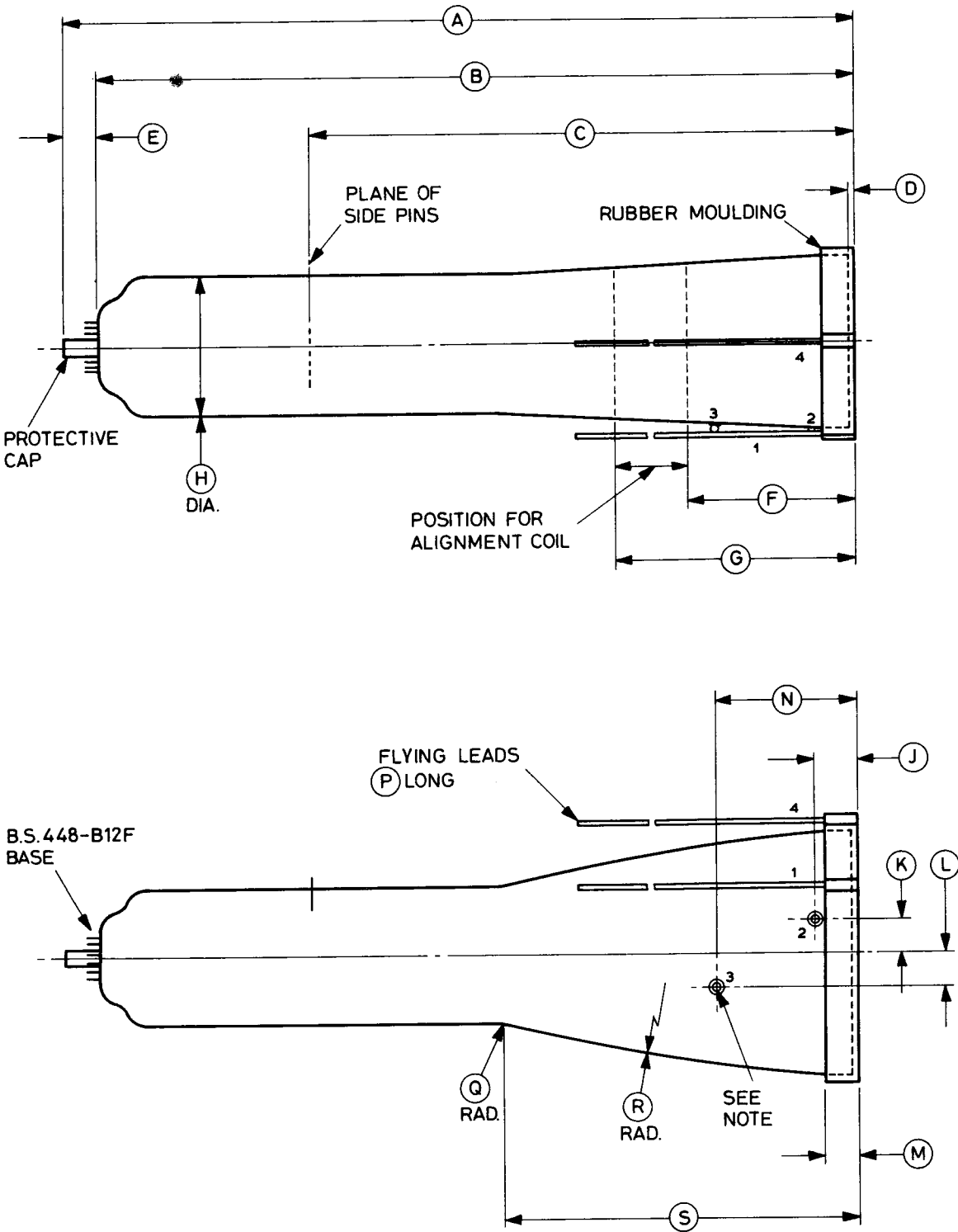

**Outline Note** Ball connections from B.S.448-CT7. Positional tolerance 8.0mm (0.315 inch) diameter.

## OUTLINE (Enlarged view on screen end)

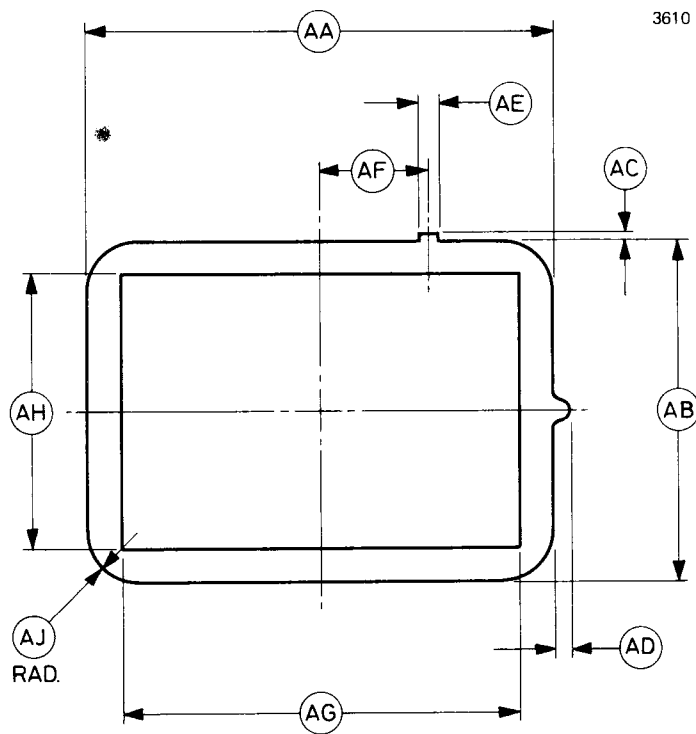

Ref	Millimetres	Inches	Ref	Millimetres	Inches
A	445.0 max	17.520 max	Q	50.0	1.969
B	421.0 <sup>+ 3.0</sup> - 7.0	16.575 <sup>+ 0.118</sup> - 0.276	R	750.0	29.528
C	303.0 ± 5.0	11.929 ± 0.197	S	196.0	7.717
D	3.0	0.118	AA*	142.9 max	5.625 max
E	23.0 max	0.905 max	AB*	104.8 max	4.125 max
F	93.0	3.661	AC*	2.39	0.094
G	133.0	5.236	AD*	5.56	0.219
H	78.0 max	3.071 max	AE*	6.35	0.250
J	24.0	0.945	AF*	38.10	1.500
K	19.0	0.748	AG*	122.3	4.813
L	19.0	0.748	AH*	84.15	3.313
M	19.0	0.748	AJ*	15.88	0.625
N	79.0	3.110	AM	1.00	0.039
P	450.0	17.717	AN	6.5 max	0.256 max
				3.0 min†	0.118 min†

Inch dimensions have been derived from millimetres except where indicated thus \*.

† Minimum useful length

## OUTLINE (Enlarged view on base end)

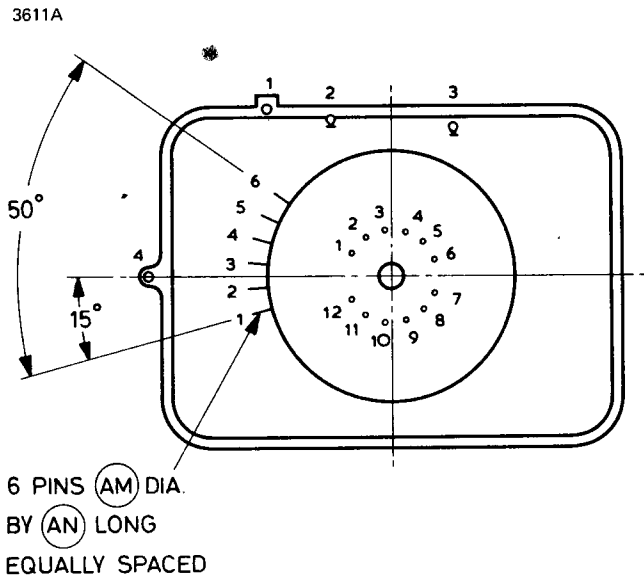

### 12-Pin Base Connections

Pin	Element
1	Writing gun grid 1
2	Writing gun cathode
3	Writing gun heater
4	Writing gun heater
5	Writing gun anode 2
6	Flood gun heater
7	Flood gun heater
8	Flood gun grid 1
9	Flood gun cathode
10	Writing gun anode 1
	Writing gun anode 3
	Flood gun grid 2
	Flood gun grid 3
11	Y-plate shield
12	Writing gun anode 4

### Ball Contact and Lead Connections

Contact	Element
1	Backing electrode
2	Flood gun grid 5
3	Flood gun grid 4
4	Screen

### Side Pin Connections

Pin	Element
1	Inter-plate shield
2	Y2 deflection plate
3	Y1 deflection plate
4	X-plate shield
5	X2 deflection plate
6	X1 deflection plate

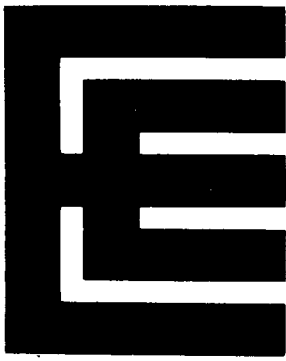

# E720A

## STORAGE CATHODE RAY TUBE

The data should be read in conjunction with the Storage Tube Preamble.

### INTRODUCTION

The E720A is a direct view storage cathode ray tube with a 12.0cm x 10.0cm rectangular faceplate and 9.0cm x 7.2cm viewing area (graticule 10 divisions x 8 divisions, each division 0.9cm). It is designed for oscilloscope use and is particularly suitable for compact transistorized equipment. It is normally used in the half-tone storage mode, but it will also operate as a p.d.a. oscilloscope tube without storage.

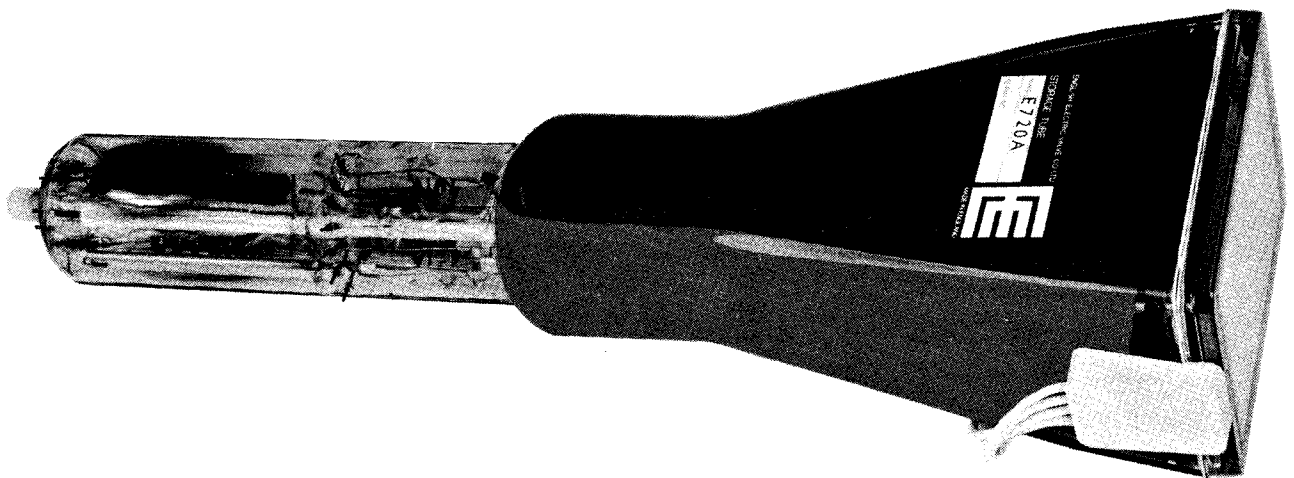

The principal features of the tube are as follows:

- Light output in excess of 100 ft-lamberts ( $343\text{cd/m}^2$ ) in the storage mode.
- Variable persistence — the persistence can be varied from several minutes to less than one second.
- Writing speed of  $1.0\text{cm}/\mu\text{s}$  in the storage mode.
- Good resolution, with typical spot size of 0.4mm.
- Good deflection sensitivity.
- Encapsulated screen lead.
- Internal graticule.

## GENERAL DATA

### Electrical and General

	Writing Gun	Flood Gun	
Cathodes; indirectly heated oxide coated . . . . .	one	one	
Heater voltage (see notes 1 and 2) . . . . .	6.3	6.3	V
Heater current . . . . .	0.3	0.6	A
Focus method . . . . .	electrostatic	electrostatic	
Deflection method . . . . .	electrostatic	none	
Minimum useful scan:			
Y1 to Y2 . . . . .		8 divisions at 0.9cm	
X1 to X2 . . . . .		10 divisions at 0.9cm	
Faceplate . . . . .		flat, clear glass	
Screen . . . . .		aluminized P31	
Internal graticule . . . . .		see page 11	
Inter-electrode capacitances:			
writing gun grid 1 to all other electrodes . . . . .		7.0	pF
writing gun cathode to all other electrodes . . . . .		7.0	pF
Y1 to Y2 plate . . . . .		2.0	pF
Y1 plate to all other electrodes except Y2 . . . . .		3.5	pF
Y2 plate to all other electrodes except Y1 . . . . .		3.5	pF
X1 to X2 plate . . . . .		3.0	pF
X1 plate to all other electrodes except X2 . . . . .		5.0	pF
X2 plate to all other electrodes except X1 . . . . .		5.0	pF
flood gun grid 1 to all other electrodes . . . . .		15	pF
backing electrode to all other electrodes . . . . .		100	pF

### Mechanical

Overall length . . . . .	442mm (17.402 inches) max
Overall dimensions, screen end, excluding encapsulation . . . . .	120 x 100mm max 4.724 x 3.937 inches max
Neck diameter . . . . .	58mm (2.283 inches) max
Net weight . . . . .	1.5kg (3.3 pounds) approx
Base . . . . .	B.S.448-B12F
Mounting position (see note 3) . . . . .	any



## MAXIMUM AND MINIMUM RATINGS (Absolute values)

No individual rating should be exceeded

**Flood Gun** (All voltages are with respect to the flood gun cathode unless otherwise stated)

	Min	Max	
Heater voltage (across heater) . . . . .	6.0	6.6	V
Viewing screen voltage . . . . .	see note 4	7.0	kV
Backing electrode positive voltage (except on clearance) . . . . .	—	15	V
Backing electrode negative voltage . . . . .	—	60	V
Grid 5 (collector mesh) voltage . . . . .	—	150	V
Grid 4 (collimator) voltage . . . . .	—	150	V
Grid 2 voltage (see notes 5 and 6) . . . . .	—	100	V
Grid 1 voltage (negative value) . . . . .	0	150	V
Peak heater to cathode voltage:			
heater positive with respect to cathode . . . . .	—	125	V
heater negative with respect to cathode . . . . .	—	125	V
Cathode current . . . . .	—	2.0	mA
Viewing screen supply impedance . . . . .	1.0	5.0	MΩ

**Writing Gun** (All voltages are with respect to anode 1 and anode 3 unless otherwise stated. See note 5)

	Min	Max	
Heater voltage (across heater) . . . . .	6.0	6.6	V
Mean deflection plate voltages (see note 6)† . . . . .	—	200	V
X-plate shield (geometry control) voltage (see note 7)† . . . . .	—	200	V
Inter-plate shield voltage (see note 8)† . . . . .	—	200	V
Y-plate shield voltage (see note 9)† . . . . .	—	200	V
Anode 4 (astigmatism control) voltage (see note 10)† . . . . .	—	200	V
Anode 2 (focus) voltage (negative value) . . . . .	—	2200	V
Grid 1 voltage with respect to writing gun cathode (negative value) . . . . .	0	200	V
Cathode voltage (negative value) . . . . .	—	2200	V
Peak heater to cathode voltage:			
heater positive with respect to cathode . . . . .	—	125	V
heater negative with respect to cathode . . . . .	—	125	V
Grid to cathode circuit impedance . . . . .	—	1.0	MΩ

† Positive or negative values

## TYPICAL OPERATION

### Flood Gun (All voltages with respect to flood gun cathode)

Screen voltage (see note 4)	6.0	kV
Screen current	0.25	mA max
Backing electrode voltage:		
storage operation	0 to 3.0	V
non-storage operation	-50	V
Backing electrode current	0.5	mA max
Grid 5 voltage	110	V
Grid 5 current	0.75	mA max
Grid 4 (collimator) voltage	40 to 80	V
Grid 4 current	0.75	mA max
Grid 2 voltage (see note 5)	40	V
Grid 2 current	0.2	mA max
Grid 1 voltage	0 to -10	V
Grid 1 cut-off voltage	-50	V max
Cathode current	0.8	mA

### Writing Gun (All voltages with respect to anode 1 and anode 3 unless otherwise stated) (see note 5)

Mean deflection plate voltages (see note 6)	0	V
X-plate shield (geometry control) voltage (see note 7)	0 to 100	V
Inter-plate shield voltage (see note 8)	0	V
Y-plate shield voltage (see note 9)	0	V
Anode 4 (astigmatism control) voltage (see note 10)	-50 to +50	V
Anode 2 (focus) voltage (with respect to writing gun cathode)	70 to 370	V
Grid 1 voltage for cut-off (with respect to writing gun cathode)	-35 to -75	V
Cathode voltage (see note 11)	-1500	V
Cathode current (see note 12)	300	$\mu$ A max

## PERFORMANCE (Under Typical Operation conditions on page 4)

Screen luminance . . . . .	100ft-lamberts min	
	343 cd/m <sup>2</sup> min	
Viewing time (see note 13) . . . . .	90	seconds min
Writing speed (stored) (see note 14) . . . . .	1.0	cm/ $\mu$ s
Deflection factors:		
X direction . . . . .	12.0 $\pm$ 1.5	V/division
Y direction . . . . .	4.5 $\pm$ 1	V/division
Linearity of scan . . . . .	2.0	%
Raster distortion (see notes 7, 15 and 16):		
X direction . . . . .	2.2	% max
Y direction . . . . .	2.8	% max
Orthogonality . . . . .	90 $\pm$ 1	degrees
Undelected spot position . . . . .		see note 17
Trace alignment (see note 18) . . . . .	$\pm$ 5	degrees max
Line width (see note 19) . . . . .	0.6	mm max
Orientation (looking at screen with flying leads on left) . . . . .	a positive voltage on X1 deflects spot to left a positive voltage on Y1 deflects spot up	

## NOTES

1. The writing gun heater must be operated from a separate supply.
2. A d.c. supply is recommended for the flood gun heaters.
3. The tube should be supported near the screen and also on the parallel neck near the base. The tube should not be supported by the base only. The socket should not be mounted rigidly, and should have flexible leads. To avoid the need for excessive magnetic shielding the tube should be mounted as far as possible from sources of magnetic field.
4. The screen may be operated below 6.0kV but the brightness will be reduced.
5. The writing gun anode 1 and anode 3 are internally connected to flood gun grid 2.

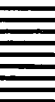
- 
6. The deflection plates should be operated near writing gun anode 1 and anode 3 potential (see note 5); it is normally most convenient to operate close to earth potential. The difference between mean X-plate and mean Y-plate potentials should not exceed 5V otherwise some deterioration in performance will result.
  7. Adjustment of the potential on the X-plate shields about mean X-plate potential may be used to correct raster distortion.
  8. The inter-plate shield should be at mean deflection plate potential.
  9. The Y-plate shield should be at mean Y-plate potential.
  10. Adjustment of anode 4 voltage about mean Y-plate potential is used to correct astigmatism.
  11. If a lower voltage is applied to the writing gun cathode the spot size will be degraded and the plate sensitivities enhanced. The voltage required on anode 2 for optimum focus will also change.
  12. For continuous d.c. operation the cathode current should not exceed  $300\mu\text{A}$  or shortened tube life is likely to result. If the cathode current is pulsed, higher currents may safely be drawn from the cathode.
  13. The viewing time is measured as the time for a 3cm diameter circular area of the background to come up to 10% of full brightness from just black. Longer viewing times can be obtained by erasing beyond black or pulsing the flood gun, at the cost of writing speed and brightness respectively.
  14. The specification writing speed limit of  $0.1\text{cm}/\mu\text{s}$  min is the maximum speed that a trace can be written just visibly at any part of a viewing area  $8.1\text{cm} \times 6.3\text{cm}$  starting from just black. An increase in writing speed to approximately  $1.0\text{cm}/\mu\text{s}$  can be obtained if some background is tolerated over the viewing area.
  15. The edges of a raster  $8.9\text{cm} \times 7.1\text{cm}$  will fall between two concentric rectangles  $9.0\text{cm} \times 7.2\text{cm}$  and  $8.8\text{cm} \times 7.0\text{cm}$ .
  16. The X and Y deflection electrodes are designed primarily for symmetrical operation. Some degradation of focus and trace geometry will result if the tube is operated under asymmetric conditions.
  17. The distance of the undeflected spot from the graticule centre will be 5mm maximum.

18. The angle measured is that between the centre horizontal line of the graticule and a trace filling the viewing area in the X direction while the Y-plates are at anode 1 and anode 3 potential. Any small alignment error may be corrected by passing d.c. (4 ampere-turns/degree) through a suitable coil around the tube near the narrow end of the cone (see outline).
19. The line width is measured by means of a shrinking raster, with  $5\mu\text{A}$  beam current in the non-storage mode.

### SCHEMATIC DIAGRAM

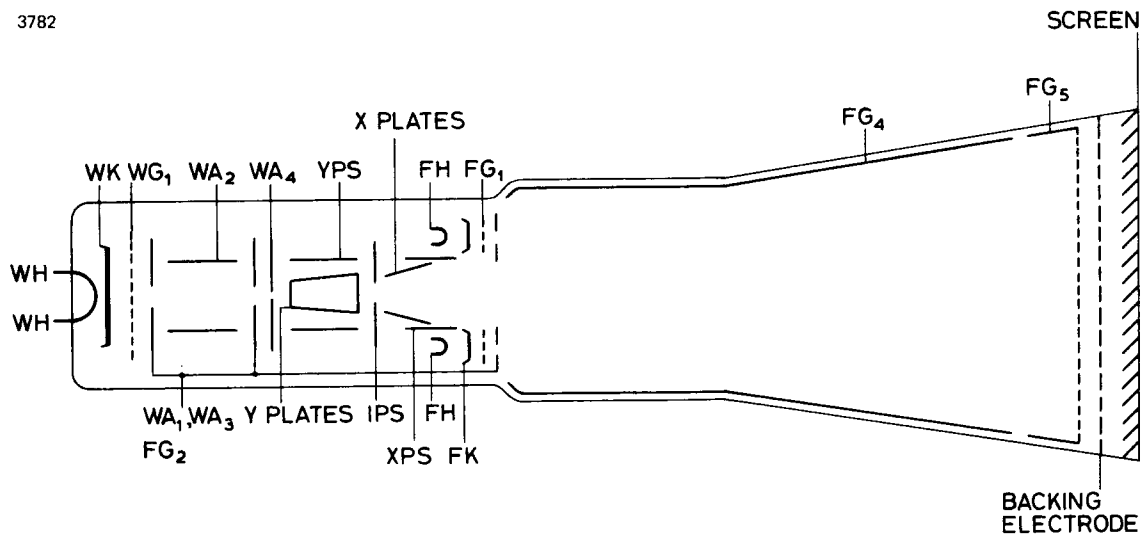

**OUTLINE (All dimensions without limits are nominal)**

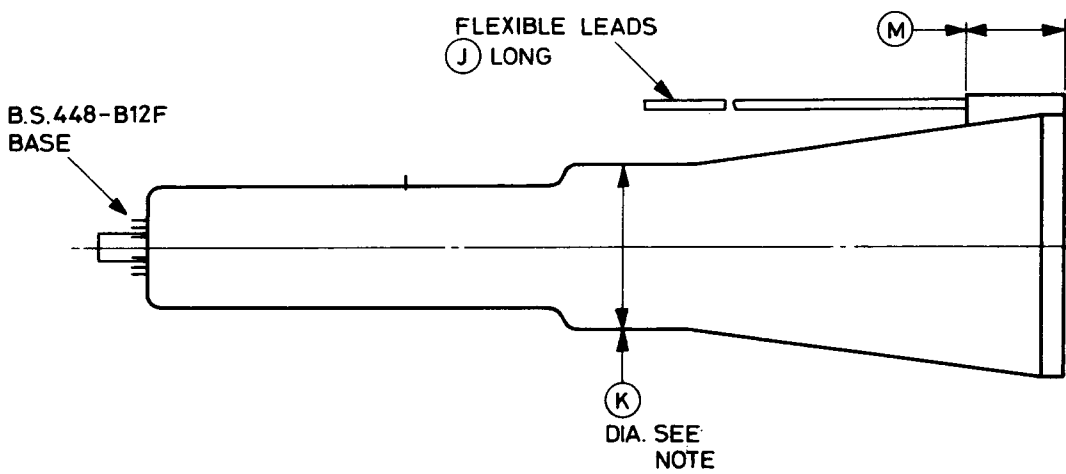
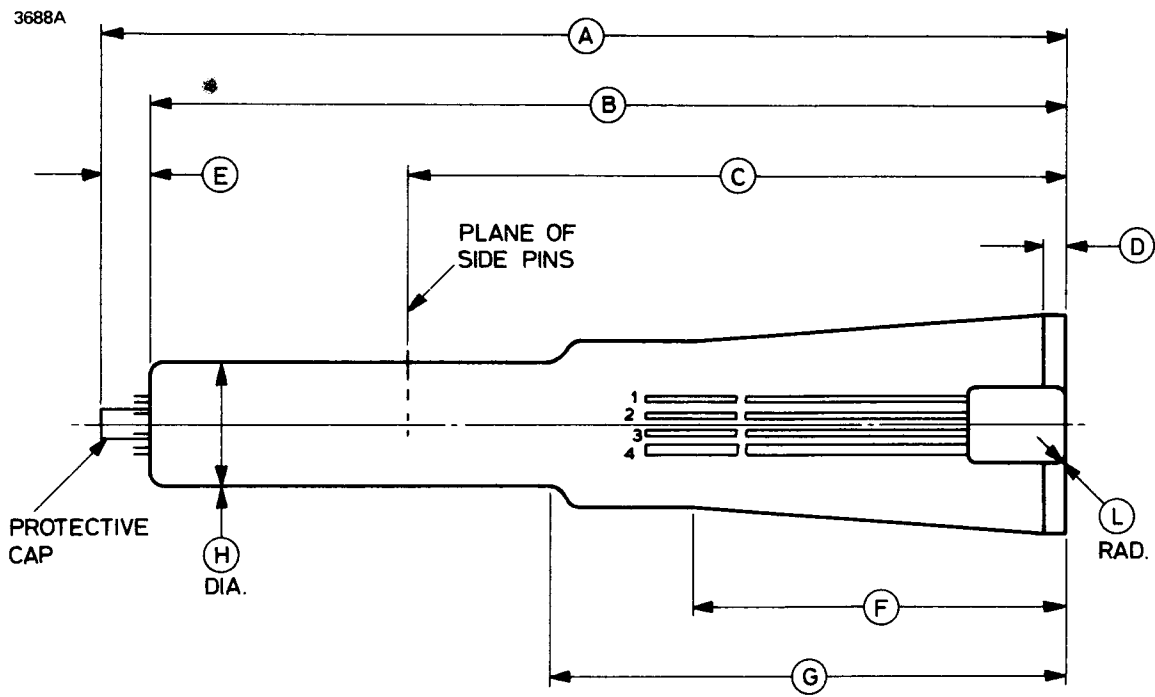

## OUTLINE (Enlarged view on screen end)

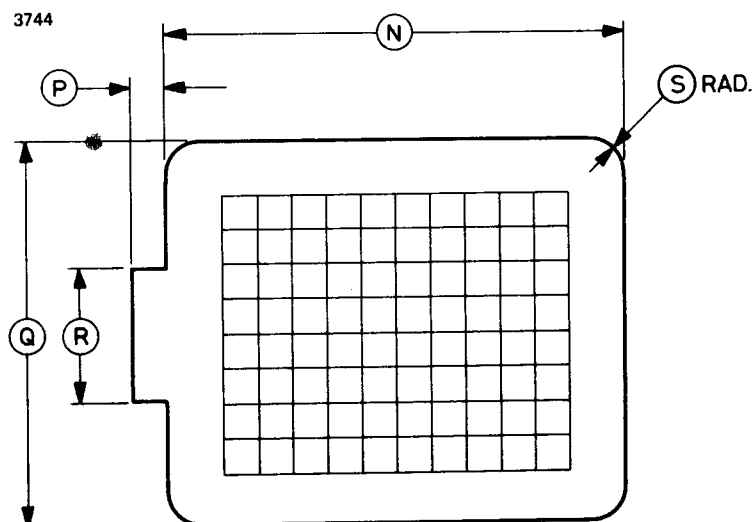

Ref	Millimetres	Inches
A	442.0 max	17.402 max
B	415.0 ± 5.0	16.339 ± 0.197
C	300.0 ± 4.0	11.811 ± 0.158
D	10.0	0.394
E	23.0 max	0.906 max
F	170.0	6.693
G	235.0	9.252
H	58.0 max	2.283 max
J	450.0	17.717
K	78.0 max	3.071 max
L	5.0	0.197
M	45.0	1.772
N	120.0 max	4.724 max
P	9.0	0.354
Q	100.0 max	3.937 max
R	35.0	1.378
S	9.0	0.354
V	1.0	0.039
W	6.5 max	0.256 max

Inch dimensions have been derived from millimetres.

**Note** The alignment coil is fitted to this part of the tube.

## OUTLINE (Enlarged view on base end)

3690A

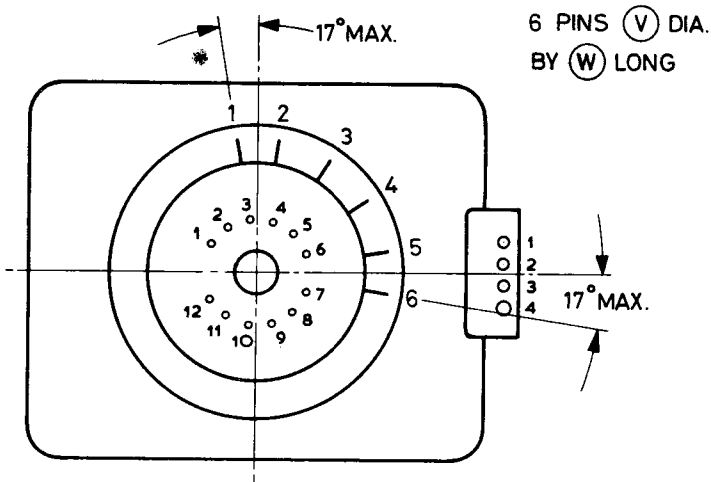

### 12-Pin Base Connections

Pin	Element
1	Writing gun grid 1
2	Writing gun cathode
3	Writing gun heater
4	Writing gun heater
5	Writing gun anode 2
6	Flood gun heater
7	Flood gun heater
8	Flood gun grid 1
9	Flood gun cathode
10	Writing gun anode 1 Writing gun anode 3 Flood gun grid 2
11	Y-plate shield
12	Writing gun anode 4

### Flying Lead Connections

Contact	Element
1	Backing electrode
2	Flood gun grid 5
3	Flood gun grid 4
4	Screen

### Side Pin Connections

Pin	Element
1	X2 deflection plate
2	X1 deflection plate
3	Inter-plate shield
4	X-plate shield
5	Y1 deflection plate
6	Y2 deflection plate



# INTERNAL GRATICULE (All dimensions are nominal)

3691

GRATICULE DIVIDED 10 BY 8  
SUB-DIVIDED INTO 0.2 DIVISIONS

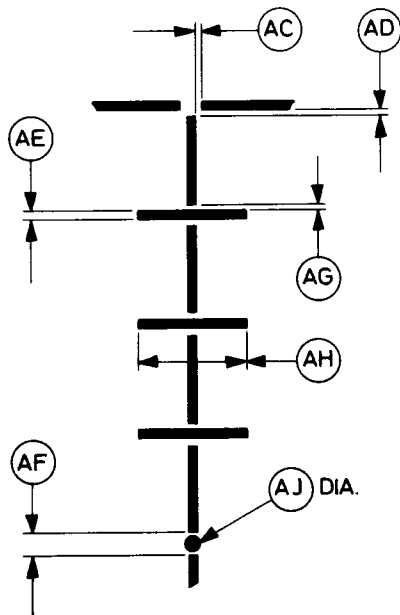
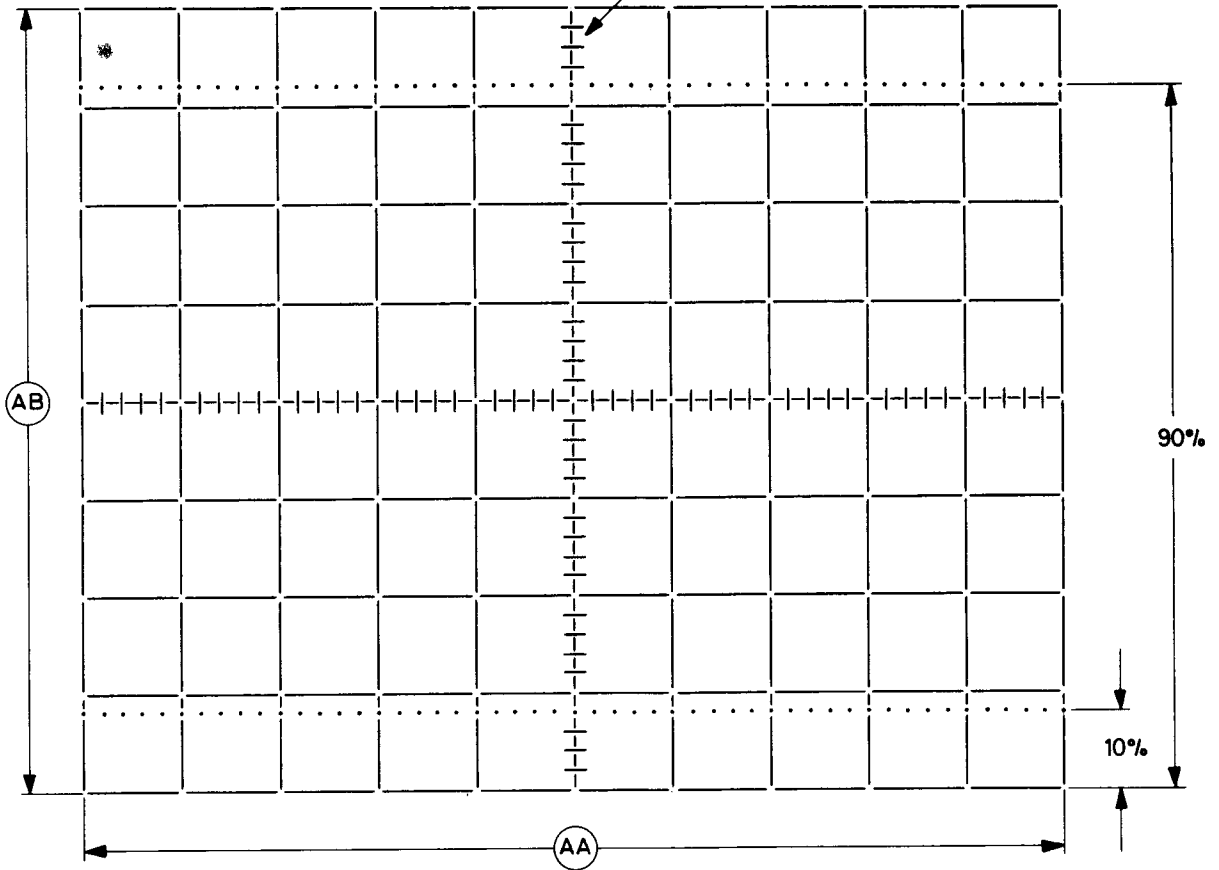

Ref	Millimetres	Inches
AA	90.0	3.543
AB	72.0	2.835
AC	0.1	0.004
AD	0.1	0.004
AE	0.15	0.006
AF	0.7	0.028
AG	0.1	0.004
AH	2.0	0.079
AJ	0.3	0.012

Inch dimensions have been derived from millimetres.



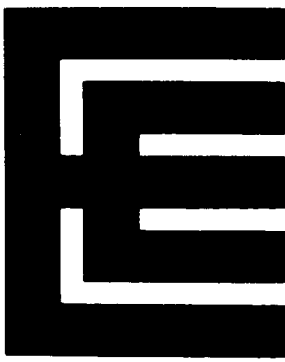

---

### PROVISIONAL INFORMATION

#### INTRODUCTION

The memicon is a single-gun storage tube which stores signals by a secondary emission process on a silicon target. The construction of the memicon closely resembles a standard vidicon camera tube, and it will operate in standard vidicon deflection systems. The target of the memicon is, however, different from that in a conventional vidicon. It is not photosensitive but operates with an electrical signal input generated by its scanning electron gun.

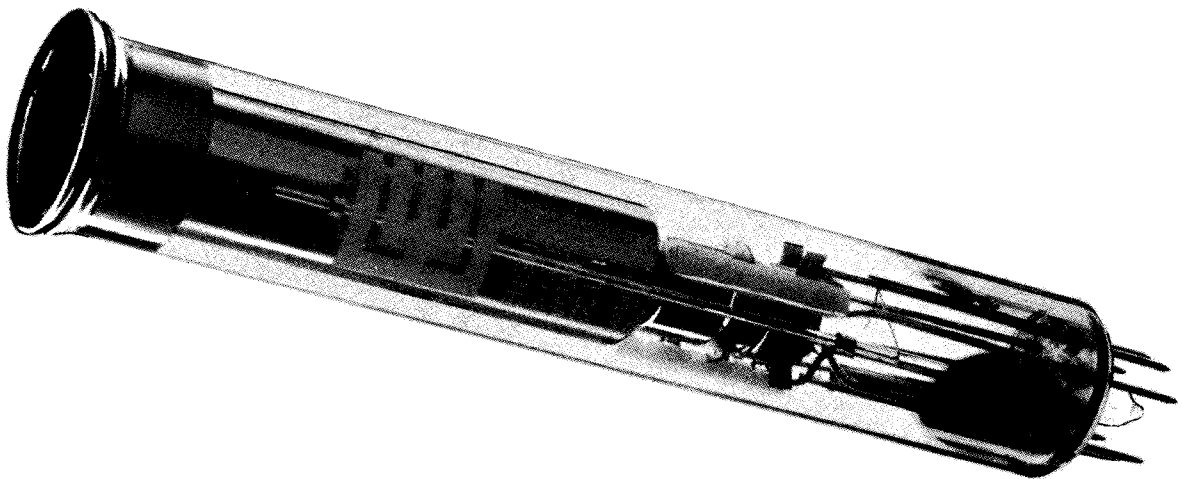

The tube has high resolution and an extended grey scale read-out capability. Storage of video information, selective read-out or full erasure can be performed at normal TV scan rates. A stored image can be read continuously for several minutes, or can be stored for several days.

The performance and operating conditions quoted in this data sheet are typical of current development tubes but are capable of modification to suit special circumstances.

## PRINCIPLES OF OPERATION

The image is stored on the silicon target as a pattern of positive charges generated by secondary emission. It is read off and displayed by normal vidicon technique. The three modes of operation are as follows:

- a) **Write** With the target at 150V, its secondary emission coefficient is greater than unity and scanned areas become positively charged. Grey-tone storage is achieved by modulating the beam current at grid 1.
- b) **Read** With the target at approximately 9V, the stored image can be discharged slowly by conventional vidicon read-out.
- c) **Erase** With the target at 20V and grid 1 at -50V, the beam is scanned over the area to be erased. The secondary emission ratio of the target at this voltage is less than unity, so that the scanned area is uniformly charged to cathode potential.

## TYPICAL OPERATION

Heater voltage . . . . .	6.3	V
Heater current . . . . .	95	mA
Focus field (see note) . . . . .	5.0	mT
	50	gauss
Grid 4 (mesh) voltage . . . . .	750	V
Grid 3 (beam focus) voltage . . . . .	450	V
Grid 2 voltage . . . . .	300	V
Grid 1 voltage for beam cut-off . . . . .	-45 to -100	V
Grid 1 drive voltage above cut-off in writing mode (peak) . . . . .	20	V
Target voltage:		
erase . . . . .	20	V
writing . . . . .	150	V
read-out . . . . .	5 to 10	V
Limiting resolution . . . . .	700	TV lines

**Note** A suitable coil assembly is Cleveland Electronics VY-111-3 deflection yoke, VF-115-12 focusing coil and VA-118 alignment coil.

# OUTLINE

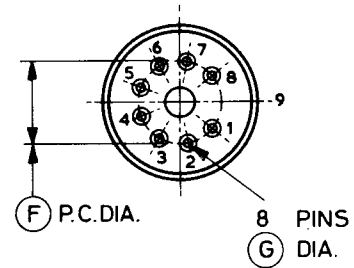
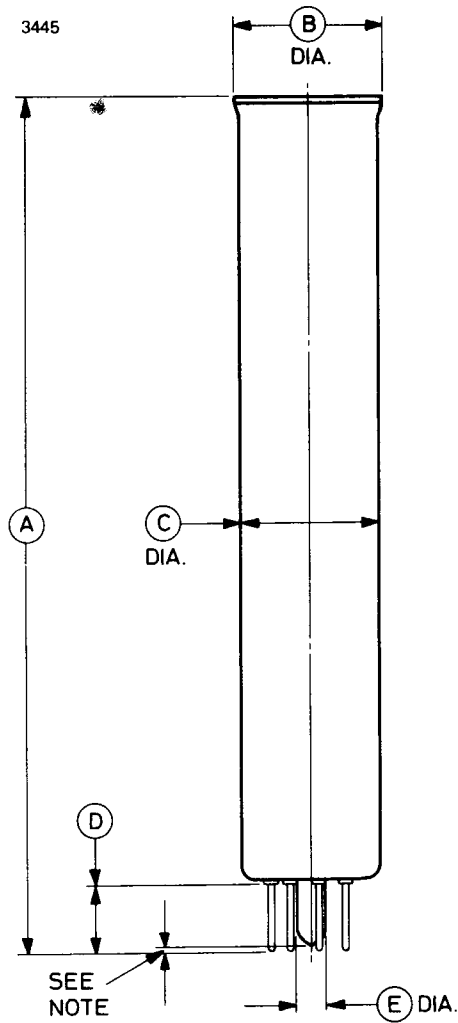

Pin	Element
1	Heater
2	Grid 1
3	Grid 4 (mesh)
4	Internal connection
5	Grid 2
6	Grid 3 (beam focus)
7	Cathode
8	Heater
9	Key pin position, blank
Flange	Signal electrode

Ref	Inches	Millimetres	Ref	Inches	Millimetres
A	$6.250 \pm 0.125$	$158.8 \pm 3.2$	E	0.265 max	6.73 max
B	$1.125 \pm 0.010$	$28.58 \pm 0.25$	F	0.600	15.24
C	$1.020 \begin{matrix} + 0.030 \\ - 0.035 \end{matrix}$	$25.91 \begin{matrix} + 0.76 \\ - 0.89 \end{matrix}$	G	$0.050 \begin{matrix} + 0.002 \\ - 0.004 \end{matrix}$	$1.270 \begin{matrix} + 0.051 \\ - 0.102 \end{matrix}$
D	0.503 max	12.78 max			

Millimetre dimensions have been derived from inches.

**Note** The seal-off will not project beyond the pins.



# Image Orthicons

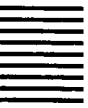





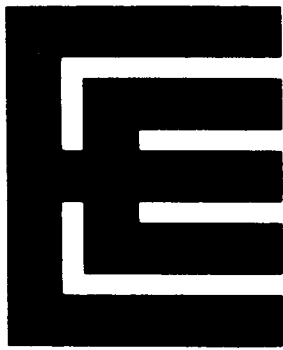

# 7295C

(P811/E)

## IMAGE ORTHICON

### INTRODUCTION

The 7295C is a 4½-inch image orthicon with an operational sensitivity in the region of f/5.6 at 15 foot-lamberts scene luminance and with the lens adjusted half to one calibration stop above the 'knee' of the transfer characteristic. While requiring a slightly higher light input than the 5820 or 7293 series, it is completely satisfactory for studio use and the sensitivity is adequate for outside broadcasts under normal conditions. The tube is very stable in performance over a wide range of light levels.

The tube has an improved target with electronic conducting properties\*; the performance of this target does not change significantly during life and therefore the 'gamma' and sensitivity remain substantially stable. Shading, normally associated with beam landing errors, is greatly reduced by the inclusion of a field mesh.

Relative to the 3-inch tube, the larger area of the target in the 4½-inch tube ensures an improvement in resolution and signal to noise ratio.

The photocathode has a spectral sensitivity which, when used with tungsten illumination, gives an overall response closely approaching that of the eye, so permitting the portrayal of colours in their true brightness levels.

This tube can be produced with a bialkali photocathode offering comparable performance



### GENERAL DATA

#### Electrical

Cathode . . . . .	indirectly heated, oxide coated	
Heater voltage . . . . .	6.3	V
Heater current . . . . .	0.6	A
Inter-electrode capacitance:		
anode to all other electrodes . . . . .	12	pF max

\* ELCON target (Brit. pat. no. 1048390). The name ELCON has been derived from the properties of the target material, namely ELectronic CONducting as opposed to ionic conducting as in the target materials formerly used. Normal exposures of the ELCON target to reasonable light levels as encountered in standard television camera practice will give negligible image retention (sticking).

February 1973

Supersedes November 1972 Issue

**Electrical (continued)**

Focusing method . . . . .	magnetic
Deflection method . . . . .	magnetic
Magnetic fields (see note 1):	
image section field, in plane of photocathode . . . . .	12mT (120G) approx
scanning section field, in plane of target . . . . .	7mT (70G) approx
alignment field, adjustable . . . . .	0 to 0.3mT (0 to 3G)

**Mechanical**

Overall length . . . . .	19.525 inches (496mm) max
Diameter of image section . . . . .	4.594 inches (116.7mm) max
Diameter of scanning section . . . . .	3.185 inches (80.9mm) max
Deflecting coil length . . . . .	7.0 inches (177.8mm)
Focusing coil length . . . . .	15.0 inches (381mm)
Alignment coil length . . . . .	0.75 to 1.5 inches (19 to 38mm)
Alignment coil location . . . . .	the alignment coil should be located on the tube so that its centre is at a distance of 15 inches (381mm) from the faceplate of the tube and so positioned that its axis is coincident with the axis of the tube, the deflecting yoke, and the focusing coil.

Useful size of rectangular image for standard operation . . . . . 1.6 inches (40.7mm) maximum diagonal at photocathode. Electron image magnified electron-optically to diagonal of 2.4 inches (61mm) approximately at the target.

Orientation of rectangular image . . . . . proper orientation is obtained when the vertical scan is essentially parallel to the plane passing through the centre of the faceplate and contact 3 of the shoulder base. This contact to be at the bottom.

Net weight . . . . . 2¼ pounds (1.1kg) approx  
Mounting position . . . . . any except with diheptal base up and with tube axis at an angle less than 20° from vertical.

End base . . . . . small shell diheptal 14-pin (JEDEC no. B14-45)

Shoulder base . . . . . special 5 contact

## Storage

Recommended store temperature . . . . . 25 to 35 °C

Tubes should be stored in darkness. All tubes must be operated for at least 5 hours each month; this is one of the conditions of warranty.

## WARNING

The following precautions should be observed when operating the tube:

1. Ensure that the temperature of the tube is within its recommended range.
2. Although image retention is virtually eliminated it is preferable to avoid long term exposure to high contrast test patterns, particularly before the tube has reached operating temperature.



## MAXIMUM AND MINIMUM RATINGS (Absolute values)

No individual rating to be exceeded

	Min	Max	
Heater voltage . . . . .	5.7	6.9	V
Photocathode voltage (image focus):			
negative value . . . . .	—	700	V
Grid 6 voltage (image accelerator):			
negative value . . . . .	—	700	V
Target voltage . . . . .	—	± 10	V
Grid 5 voltage (decelerator) . . . . .	—	300	V
Field mesh with respect to grid 4 voltage . . . . .	—	+ 30	V
Grid 4 voltage (beam focus) . . . . .	—	350	V
Grid 3 voltage (multiplier focus) . . . . .	—	400	V
Grid 2 and dynode 1 voltage . . . . .	—	350	V
Grid 1 voltage (negative value, never positive) . . . . .	0	125	V
Anode voltage . . . . .	—	1650	V
Voltage per multiplier stage . . . . .	—	350	V
Voltage between anode and dynode 5 when anode currents up to 100µA are drawn . . . . .	40	—	V
Peak heater to cathode voltage:			
heater negative with respect to cathode . . . . .	—	125	V
heater positive with respect to cathode . . . . .	—	10	V
Operating temperature of any part of bulb . . . . .	—	65	°C
Operating temperature of bulb at target section . . . . .	35	60	°C
Temperature difference between target section and any hotter part of bulb . . . . .	—	5	°C
Peak illumination of faceplate:			
non-operating . . . . .	—	50	ft-candles
operating . . . . .	—	10	ft-candles

## TYPICAL OPERATION

### Operational Conditions

Photocathode voltage (image focus) (see note 2)	−200 to −600	V
Grid 6 voltage (image accelerator) (see note 3)	−80 to −480	V
Target cut-off voltage	−2	V
Target voltage above cut-off (see note 4)	2.5 to 3	V
Target blanking voltage (peak to peak)	5	V min
Grid 5 voltage (decelerator) (see note 5)	−100 to +250	V
Field mesh voltage with respect to grid 4 voltage (see note 6)	5 to 15	V
Grid 4 voltage (beam focus) (see note 7)	100 to 200	V
Grid 3 voltage (multiplier focus) (see note 8)	215 to 350	V
Grid 2 and dynode 1 voltage	300	V
Grid 1 voltage:		
normal (see note 9)	−4 to −115	V
for picture cut-off	−45 to −115	V
Dynode 2 voltage	600	V
Dynode 3 voltage (see note 10)	600 to 800	V
Dynode 4 voltage	1050	V
Dynode 5 voltage	1250	V
Anode voltage (see note 10)	1300	V
Heater voltage	6.3	V
Recommended target temperature range (see note 11)	35 to 45	°C
Magnetic fields:		
image section field, in plane of photo- cathode	12mT (120G) approx	
scanning section field, in plane of target	7mT (70G) approx	
alignment field, adjustable (see page 5)	0 to 0.3mT (0 to 3G)	
Image size at target	see note 12	

### Performance Specification

The results given on page 5 are obtained by operating as follows:

- (i) With the operational conditions specified above but with an operating temperature of 35 to 50°C and the lens stop adjusted in accordance with Note 13. 625 Line System Standard.

(ii) Set up in accordance with the Sequence of Adjustments below.

	Min	Typical	Max	
Heater current . . . . .	540	—	660	mA
Signal current (see note 14) . . . . .	20	—	60	$\mu$ A
Signal to noise ratio (see note 15) . . . . .	37	39	—	db
Amplitude response (see note 17) . . . . .	60	75	—	%
Illumination required on photo-cathode to reach the 'knee' of the transfer characteristic (see notes 13 and 18) . . . . .	—	0.035	0.07	ft-candle
After image (see note 19) . . . . .	—	0	5	sec

The performance obtained may vary with the camera in which the tube is used.



**SEQUENCE OF ADJUSTMENTS**

- (a) Insert the tube in the camera, then verify that the equipment is functioning and allow the tube to warm up† with lens capped, target biased off and scanning amplitude controls set at maximum. Adjust the beam controls to give a small amount of beam current. For optimum operating conditions the tube temperature must be between 40°C and 45°C.
- (b) Adjust the beam bias and the gain control until noise appears on the monitor screen.
- (c) Uncap the camera lens.
- (d) Increase the target voltage until the picture appears.
- (e) Adjust the alignment controls so that the maximum area of picture at the centre goes in and out of focus and does not rotate as grid 4 (beam focus) voltage is varied about its focus value.
- (f) Adjust grid 6 (image accelerator) voltage for minimum 'S' distortion consistent with the highest photocathode focus voltage that can be obtained.
- (g) Adjust the target voltage to 2.5 to 3 volts above the cut-off condition (see note 16).
- (h) Adjust the beam current to the lowest value consistent with a satisfactory picture. Adjust the scanning raster to the correct size and aspect ratio (see note 12).

† Warm-up time can be considerably reduced if care is exercised with exposure in the first few minutes after switch-on. Slight adjustments to the tube electrode potentials may also be necessary as the camera equipment settles down. Optimum tube performance will only be obtained within the specified range of temperatures.

- (j) Adjust grid 5 (decelerator) for minimum corner shading and best geometry, if a variable control is provided on the camera.
- (k) Adjust the lens aperture so that the white content of the picture is at the 'knee' of the tube transfer characteristic and open the lens a further stop. Excessive white compression and a rapid decrease in signal indicate dynode saturation. Adjust dynode 3 to remove this effect. Attempts to eliminate the effect by decreasing the overall anode voltage will generally cause further deterioration unless the voltage difference between anode and dynode 5 is preserved independently of voltage changes in the multiplier chain. Dynode 3 may be operated at lower voltages within the typical range, to avoid overloading the head amplifier.
- (l) With the line and frame shading controls at zero, adjust grid 3 (multiplier focus) for maximum output.
- (m) Cap the lens and adjust as follows:
  - (i) Field mesh voltage should be adjusted to eliminate parabolic shading. In some cameras the field mesh voltage has to be adjusted to remove moiré patterns; this should also be checked with the lens uncapped, with scenes having a range of background brightness. In cases where this affects the focus, grid 4 (beam focus) voltage must be readjusted.
  - (ii) Line shading can be minimised by further slight adjustment of grid 3 (multiplier focus).
  - (iii) Line and frame shading correction can be employed if the black shading has not been minimised satisfactorily by the adjustments in (i) and (ii) above. The practice of correcting non-uniform lighting in a studio by adjusting the tube shading controls is not recommended, as it leads to the need for continued adjustment as the camera is panned and introduces errors in the black level.
- (n)
  - (i) Uncap the lens and expose to a plain white scene.
  - (ii) Readjust the beam current to just discharge the white.
  - (iii) If necessary, minimise white shading by slight adjustment of the alignment controls.
- (p) Readjust the photocathode and grid 4 (beam focus) voltages for best resolution.

## NOTES

1. The direction of the focusing current should be such that a north pole is attracted to the image end of the focusing coil.
  2. Adjusted for best focus but as near maximum as possible.
  3. 40 to 80% of photocathode voltage. Adjusted for minimum 'S' distortion.
-

4. Supply adjustable from  $-5$  to  $+5V$  with blanking voltage off.
5. Adjusted for minimum corner shading and best corner geometry.
6. Adjusted for minimum black shading. The supply for this electrode may be derived from that for grid 4.
7. Adjusted for picture focus. Focus may be obtained at several voltages in the range of adjustment provided, and a voltage should be selected to minimise moiré patterns and corner shading or to optimise geometry. This selection has to be made because of differences in yoke design between cameras of various manufacturers.
8. Adjusted to give the most uniform black shading near maximum signal. This adjustment must be made with the photocathode capped.
9. Adjusted for best picture. Excessive beam current increases noise.
10. The potential of dynode 3 relative to dynode 2 should be reduced to prevent the occurrence of a current reversal at the 5th dynode stage of tubes with a high d.c. output. The potential between the anode and dynode 5 must not drop below  $40V$  when anode currents up to  $100\mu A$  are drawn.
11. No part of the bulb may be more than  $5^{\circ}C$  hotter than the target section.
12. The size of the optical image of aspect ratio  $4 \times 3$  focused on the photocathode should be adjusted so that its maximum diagonal does not exceed 1.6 inches. The corresponding electron image on the target should have a size such that the corners of the rectangle just touch the target ring. Alternatively, a ring mask may be used, consisting of a perspex disc on which are inscribed two concentric circles of 0.96 and 1.28 inches diameter, placed in contact and concentric with the photocathode. Light is allowed to fall on the photocathode and an image of the rings obtained on the monitor. No lens is necessary. The scan amplitude and centring controls on the camera are adjusted until the diameter of the larger circle is equal to the width of the raster and the diameter of the small circle is equal to the height. Verify that the scanned patch is centrally located with respect to the target ring.
13. Lens stop. The light level is adjusted until the 'knee' of the transfer characteristic is reached by gradually opening the lens from its minimum aperture and observing the increase of the signal amplitude on the oscilloscope. The 'knee' is defined as the point at which the difference between signals from chips having densities 0 and 0.15, and from 0.15 and 0.3 are equal. The recommended operating point is obtained by increasing the aperture of the lens by one calibration stop. If a lower target voltage is used, lower illumination is required to reach the 'knee'.
14. Signal current. With the tube set up to give best overall resolution, the gain is adjusted to give  $0.7V$  output from the channel, measured from

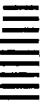

white to black level as determined with the lens capped. The tube signal is then removed from the head amplifier by biasing off the beam and a line frequency test signal (amplitude during active line period 0.7V) is injected to the head amplifier via an attenuator. The attenuator is adjusted to give 0.7V amplitude signal output from the channel. The attenuator setting is read and the input signal voltage to the amplifier is calculated. From the values for the amplifier input signal voltage and the image orthicon load resistor, the signal current is then calculated. Dynode 3 voltage may require adjustment to obtain a signal current below the specified maximum.

15. The peak white amplitude of the video waveform is set to 0.7V with respect to capped black to provide the reference signal and the signal to noise ratio is measured using a Rohde & Schwarz video noise meter type UPSF (or equivalent instrument). Other methods of measurement may produce different values.
16. Values of target voltage other than 3V can be used but a compromise must be made as signal to noise ratio and signal output increase with target voltage, while a decrease in target voltage improves sensitivity and resolution.
17. Amplitude at 400 lines per picture height at the centre of the picture, without aperture correction, relative to the large area black-white signal.
18. With illumination from a source of colour temperature 2854° K. Note that this is not the 'preferred operating point', which requires double this illumination.

The illumination required on the scene is given by

$$I_{sc} = \frac{I_{pc} \cdot 4f^2 (m + 1)^2}{TR}$$

where  $I_{sc}$  = scene illumination in foot-candles

$I_{pc}$  = photocathode illumination

$f$  = lens aperture number

$m$  = magnification from scene to photocathode

$T$  = lens transmission

$R$  = scene reflectance

For example, if a photocathode illumination of 0.035 ft-candle ( $I_{pc}$ ) is required for the 'knee', the illumination required at the operating point would be 0.07 ft-candle. For a lens aperture of  $f/5.6$  and transmission of 80%, scene reflectance of 60% and  $(m + 1)$  approximating closely to 1, the scene illumination required for a photocathode illumination of 0.07 ft-candle would be approximately 18 ft-candles (185 lux).

19. After an exposure of any reasonable duration to a scene, any after image will become insignificant within five seconds.



# TYPICAL SPECTRAL SENSITIVITY CHARACTERISTIC

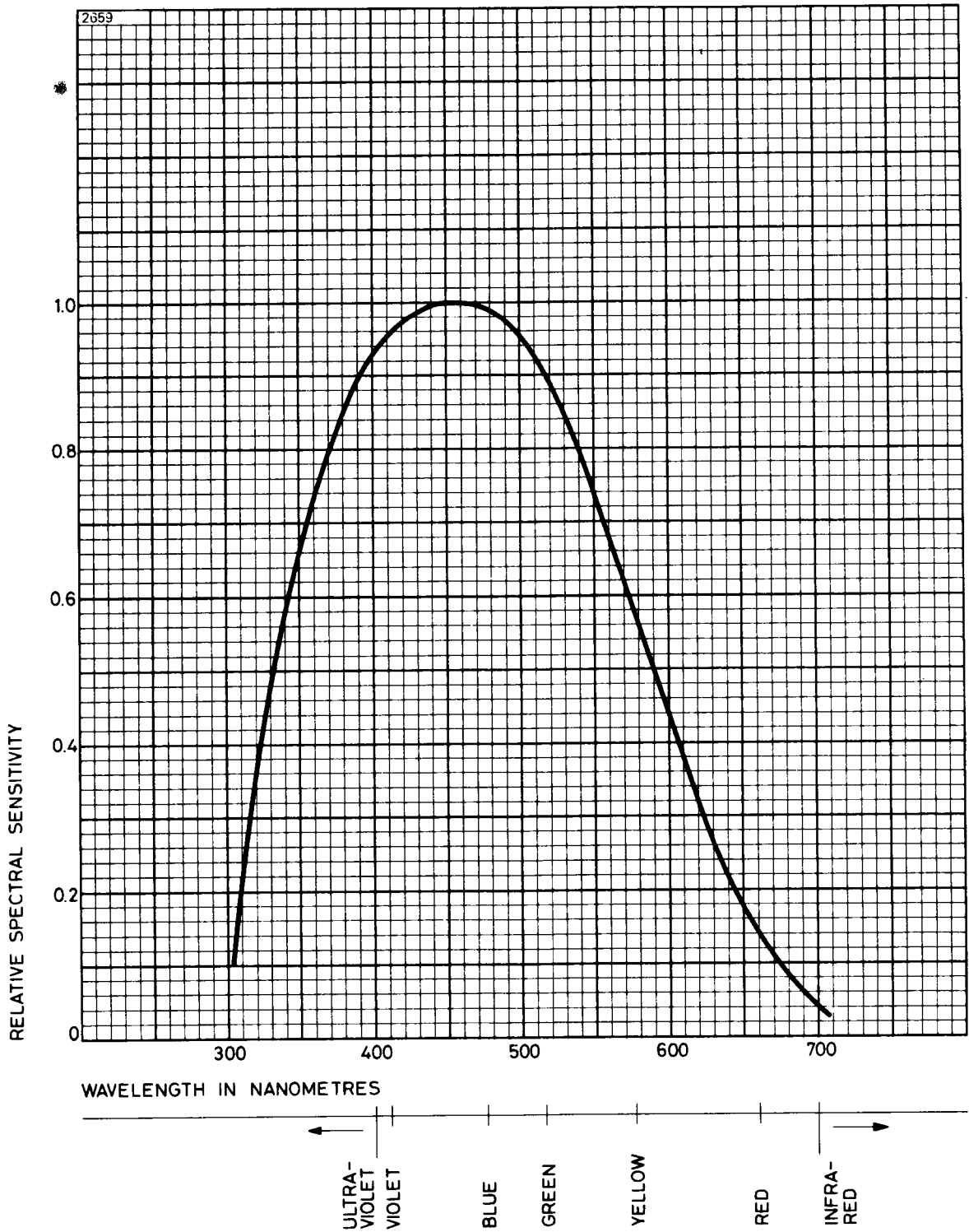

## TYPICAL TRANSFER CHARACTERISTIC

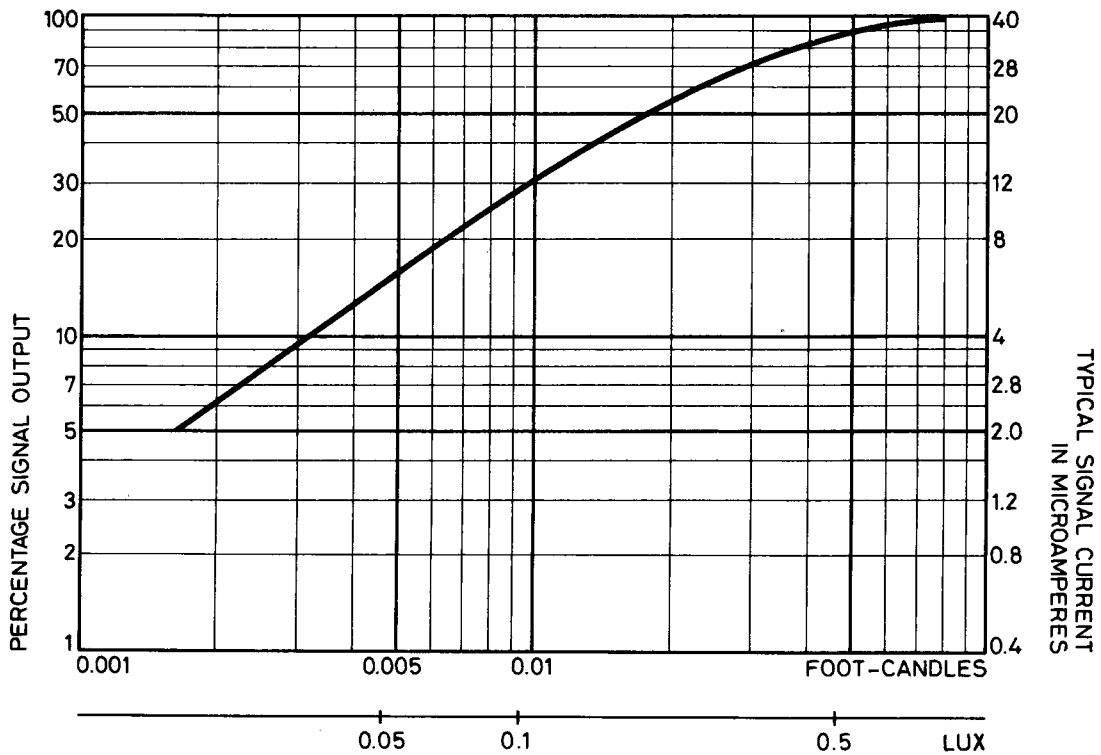
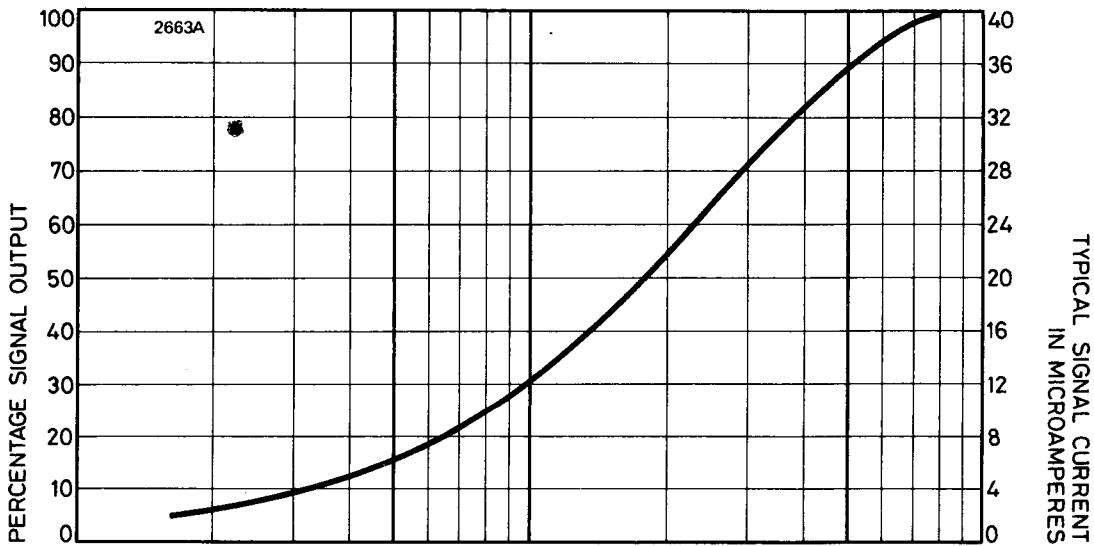

HIGHLIGHT ILLUMINATION ON PHOTOCATHODE

### Method of Obtaining 7295C Transfer Characteristic

The camera was accurately set up on a normal picture and then moved to view a scene comprising one step of a step wedge, surrounded by black. The method is described by D. C. Brothers in 'The Testing and Operation of 4½-inch Image Orthicon Tubes', Journal Brit. I.R.E. Vol. 19, p. 777 (1959).

**OUTLINE (All dimensions without limits are nominal)**

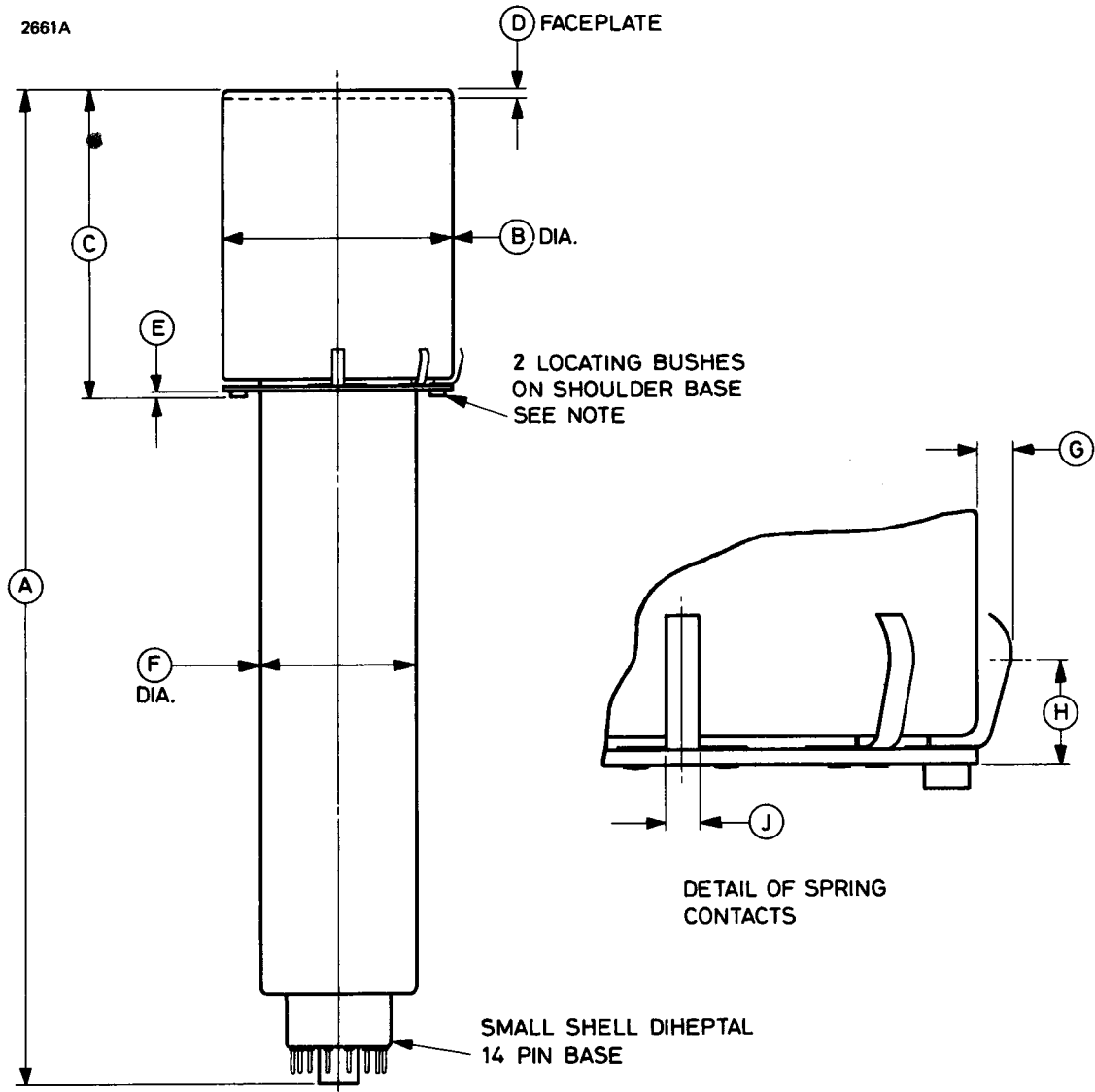

Ref	Inches	Millimetres	Ref	Inches	Millimetres
A	19.375 ± 0.150	492.1 ± 3.8	F	3.185 max	80.90 max
B	4.500 ± 0.094	114.3 ± 2.4	G	0.175 min	4.45 min
C	5.721 ± 0.125	145.3 ± 3.2	H	0.800	20.32
D	0.188	4.78	J	0.250	6.35
E	0.175 max	4.45 max			

Millimetre dimensions have been derived from inches.

**Note** These bushes are a push fit and may be removed by the customer if required. If this is done, the holes remaining are 0.311 inch (7.90mm) diameter, equally spaced on 4.000 inches (101.6mm) pitch circle diameter.

# OUTLINE DETAILS

## View on Base End of Tube

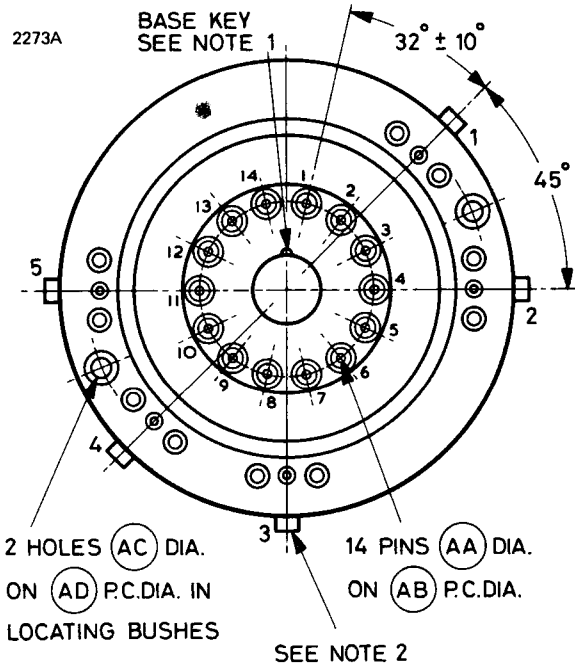

**Note 1.** The plane through the axis of the tube and the base key is coincident with the plane through shoulder base contact 3 and the axis of the tube to within 10°.

**Note 2.** The faceplate has an index mark in line with shoulder base contact 3.

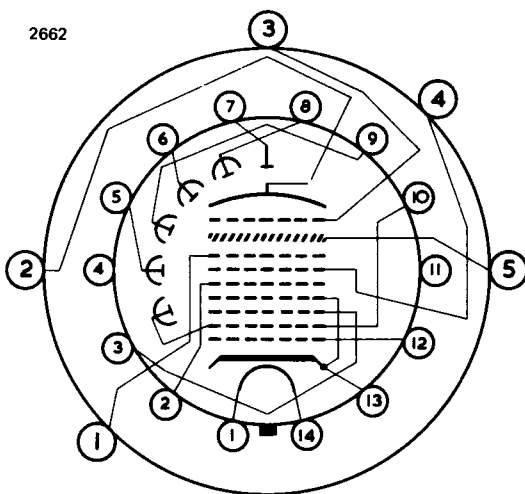

## Base Dimensions

Ref	Inches	Millimetres
AA	0.093 ± 0.002	2.362 ± 0.051
AB	1.750 ± 0.002	44.450 ± 0.051
AC	0.204	5.18
AD	4.000 ± 0.005	101.60 ± 0.13

Millimetre dimensions have been derived from inches.

## 14-Pin Base Connections

Pin	Element
1	Heater
2	Grid 4
3	Grid 3
4	Internal connection. Do not use
5	Dynode 2
6	Dynode 4
7	Anode
8	Dynode 5
9	Dynode 3
10	Dynode 1, Grid 2
11	Internal connection. Do not use
12	Grid 1
13	Cathode, Suppressor
14	Heater

## Shoulder Base Connections

Contact	Element
1	Field Mesh
2	Photocathode
3	Grid 6
4	Grid 5
5	Target



### INTRODUCTION

The 7389C is a 4½-inch image orthicon with high target capacitance, giving improved signal to noise ratio and reduced edge and halo effects when compared with the 7295 series.

In operation, the tube is more suited to studio productions where some measure of control over scene illumination is possible, so enabling the full benefits to be realised. Its sensitivity is, however, adequate for outside broadcasts under normal conditions.

The tube has an improved target with electronic conducting properties\*; the performance of this target does not change significantly during life and therefore the 'gamma' and sensitivity remain substantially stable. Shading, normally associated with beam landing errors, is greatly reduced by the inclusion of a field mesh.

The operational sensitivity is in the region of f/5.6 at 25 foot-lamberts scene luminance and with the lens adjusted to half a stop above the 'knee' of the transfer characteristic.

The photocathode has a spectral sensitivity which, when used with tungsten illumination, gives an overall response closely approaching that of the eye, so permitting the portrayal of colours in their true brightness levels.

This tube can be produced with a bialkali photocathode offering comparable performance.

### GENERAL DATA

#### Electrical

Cathode . . . . .	indirectly heated, oxide coated
Heater voltage . . . . .	6.3 V
Heater current . . . . .	0.6 A
Inter-electrode capacitance:	
anode to all other electrodes . . . . .	12 pF max

\* ELCON target (Brit. pat. no. 1048390). The name ELCON has been derived from the properties of the target material, namely ELectronic CONducting as opposed to ionic conducting as in the target material formerly used. Normal exposures of the ELCON target to reasonable light levels as encountered in standard television camera practice will give negligible image retention (sticking).



### Electrical (continued)

Focusing method . . . . .	magnetic
Deflection method . . . . .	magnetic
Magnetic fields (see note 1):	
image section field, in plane of photocathode . . . . .	12mT (120G) approx
scanning section field, in plane of target . . . . .	7mT (70G) approx
alignment field, adjustable . . . . .	0 to 0.3mT (0 to 3G)

### Mechanical

Overall length . . . . .	19.525 inches (496mm) max
Diameter of image section . . . . .	4.594 inches (116.7mm) max
Diameter of scanning section . . . . .	3.185 inches (80.9mm) max
Deflecting coil length . . . . .	7.0 inches (177.8mm)
Focusing coil length . . . . .	15.0 inches (381mm)
Alignment coil length . . . . .	0.75 to 1.5 inches (19 to 38mm)
Alignment coil location . . . . .	the alignment coil should be located on the tube so that its centre is at a distance of 15 inches (381mm) from the faceplate of the tube and so positioned that its axis is coincident with the axis of the tube, the deflecting yoke, and the focusing coil.

Useful size of rectangular image for standard operation . . . . . 1.6 inches (40.7mm) maximum diagonal at photocathode. Electron image magnified electron-optically to diagonal of 2.4 inches (61mm) approximately at the target.

Orientation of rectangular image proper orientation is obtained when the vertical scan is essentially parallel to the plane passing through the centre of the faceplate and contact 3 of the shoulder base. This contact to be at the bottom.

Net weight . . . . . 2¼ pounds (1.1kg) approx  
Mounting position . . . . . any except with diheptal base up and with tube axis at an angle less than 20° from vertical.

End base . . . . . small shell diheptal 14-pin (JEDEC No. B14-45)

Shoulder base . . . . . special 5 contact

**Storage**

Recommended store temperature . . . . . 25 to 35 °C

Tubes should be stored in darkness. All tubes must be operated for at least 5 hours each month; this is one of the conditions of warranty.

**WARNING**

The following precautions should be observed when operating the tube:

1. Ensure that the temperature of the tube is within its recommended range.
2. Although image retention is virtually eliminated it is preferable to avoid long term exposure to high contrast test patterns, particularly before the tube has reached operating temperature.

**MAXIMUM AND MINIMUM RATINGS (Absolute values)**

No individual rating to be exceeded

	<b>Min</b>	<b>Max</b>	
Heater voltage . . . . .	5.7	6.9	V
Photocathode voltage (image focus):			
negative value . . . . .	—	700	V
Grid 6 voltage (image accelerator):			
negative value . . . . .	—	700	V
Target voltage . . . . .	—	± 10	V
Grid 5 voltage (decelerator) . . . . .	—	300	V
Field mesh with respect to grid 4 voltage . . . . .	—	+ 30	V
Grid 4 voltage (beam focus) . . . . .	—	350	V
Grid 3 voltage (multiplier focus) . . . . .	—	400	V
Grid 2 and dynode 1 voltage . . . . .	—	350	V
Grid 1 voltage (negative value, never positive)	0	125	V
Anode voltage . . . . .	—	1650	V
Voltage per multiplier stage . . . . .	—	350	V
Voltage between anode and dynode 5 when anode currents up to 100µA are drawn . . . . .	40	—	V
Peak heater to cathode voltage:			
heater negative with respect to cathode . . . . .	—	125	V
heater positive with respect to cathode . . . . .	—	10	V
Operating temperature of any part of bulb . . . . .	—	65	°C
Operating temperature of bulb at target section . . . . .	35	60	°C
Temperature difference between target section and any hotter part of bulb . . . . .	—	5	°C
Peak illumination of faceplate:			
non-operating . . . . .	—	50	ft-candles
operating . . . . .	—	10	ft-candles

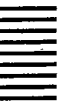

## TYPICAL OPERATION

### Operational Conditions

Photocathode voltage (image focus) (see note 2)	-200 to -600	V
Grid 6 voltage (image accelerator) (see note 3)	-80 to -480	V
Target cut-off voltage	-2	V approx
Target voltage above cut-off (see note 4)	2.5 to 3	V
Target blanking voltage (peak to peak)	5	V min
Grid 5 voltage (decelerator) (see note 5)	-100 to +250	V
Field mesh voltage with respect to grid 4 voltage (see note 6)	+5 to +15	V
Grid 4 voltage (beam focus) (see note 7)	100 to 200	V
Grid 3 voltage (multiplier focus) (see note 8)	215 to 350	V
Grid 2 and dynode 1 voltage	300	V
Grid 1 voltage:		
normal (see note 9)	-4 to -115	V
for picture cut-off	-45 to -115	V
Dynode 2 voltage	600	V
Dynode 3 voltage (see note 10)	600 to 800	V
Dynode 4 voltage	1050	V
Dynode 5 voltage	1250	V
Anode voltage (see note 10)	1300	V
Heater voltage	6.3	V
Recommended target temperature range (see note 11)	35 to 45	°C
Magnetic fields:		
image section field, in plane of photo- cathode	12mT (120G) approx	
scanning section field, in plane of target	7mT (70G) approx	
alignment field, adjustable (see page 5).	0 to 0.3mT (0 to 3G)	
Image size at target	see note 12	

### Performance Specification

The results given on page 5 are obtained by operating as follows:

- (i) With the operational conditions specified above but with an operating temperature of 35 to 50°C and the lens stop adjusted in accordance with Note 13. 625 Line System Standard.



(ii) Set up in accordance with the Sequence of Adjustments below.

	Min	Typical	Max	
Heater current . . . . .	540	—	660	mA
Signal current (see note 14) . . . . .	20	—	60	$\mu$ A
Signal to noise ratio (see note 15) . . . . .	39	41	—	db
Amplitude response (see note 17) . . . . .	60	75	—	%
Illumination required on photo-cathode to reach the 'knee' of the transfer characteristic (see notes 13 and 18) . . . . .	—	0.07	0.12	ft-candle
After image (see note 19) . . . . .	—	0	5	sec

The performance obtained may vary with the camera in which the tube is used.



### SEQUENCE OF ADJUSTMENTS

- (a) Insert the tube in the camera, then verify that the equipment is functioning and allow the tube to warm up† with lens capped, target biased off and scanning amplitude controls set at maximum. Adjust the beam controls to give a small amount of beam current. For optimum operating conditions the tube temperature must be between 40 and 45°C.
- (b) Adjust the beam bias and the gain control until noise appears on the monitor screen.
- (c) Uncap the camera lens.
- (d) Increase the target voltage until the picture appears.
- (e) Adjust the alignment controls so that the maximum area of picture at the centre goes in and out of focus and does not rotate as grid 4 (beam focus) voltage is varied about its focus value.
- (f) Adjust grid 6 (image accelerator) voltage for minimum 'S' distortion consistent with the highest photocathode focus voltage that can be obtained.
- (g) Adjust the target voltage to 2.5 to 3 volts above the cut-off condition (see note 16).
- (h) Adjust the beam current to the lowest value consistent with a satisfactory picture. Adjust the scanning raster to the correct size and aspect ratio (see note 12).

† Warm-up time can be considerably reduced if care is exercised with exposure in the first few minutes after switch-on. Slight adjustments to the tube electrode potentials may also be necessary as the camera equipment settles down. Optimum tube performance will only be obtained within the specified range of temperatures.

- (j) Adjust grid 5 (decelerator) for minimum corner shading and best geometry, if a variable control is provided on the camera.
- (k) Adjust the lens aperture so that the white content of the picture is at the 'knee' of the tube transfer characteristic and open the lens a further half stop. Excessive white compression and a rapid decrease in signal indicate dynode saturation. Adjust dynode 3 to remove this effect. Attempts to eliminate the effect by decreasing the overall anode voltage will generally cause further deterioration unless the voltage difference between anode and dynode 5 is preserved independently of voltage changes in the multiplier chain. Dynode 3 may be operated at lower voltages within the typical range, to avoid overloading the head amplifier.
- (l) With the line and frame shading controls at zero, adjust grid 3 (multiplier focus) for maximum output.
- (m) Cap the lens and adjust as follows:
  - (i) Field mesh voltage should be adjusted to eliminate parabolic shading. In some cameras the field mesh voltage has to be adjusted to remove moiré patterns; this should also be checked with the lens uncapped, with scenes having a range of background brightness. In cases where this affects the focus, grid 4 (beam focus) voltage must be readjusted.
  - (ii) Line shading can be minimised by further slight adjustment of grid 3 (multiplier focus).
  - (iii) Line and frame shading correction can be employed if the black shading has not been minimised satisfactorily by the adjustments in (i) and (ii) above. The practice of correcting non-uniform lighting in a studio by adjusting the tube shading controls is not recommended, as it leads to the need for continued adjustment as the camera is panned and introduces errors in the black level.
- (n)
  - (i) Uncap the lens and expose to a plain white scene.
  - (ii) Readjust the beam current to just discharge the white.
  - (iii) If necessary, minimise white shading by slight adjustment of the alignment controls.
- (p) Readjust the photocathode and grid 4 (beam focus) voltages for best resolution.

## NOTES

1. The direction of the focusing current should be such that a north pole is attracted to the image end of the focusing coil.
  2. Adjusted for best focus but as near maximum as possible.
  3. 40 to 80% of photocathode voltage. Adjusted for minimum 'S' distortion.
-

4. Supply adjustable from  $-5$  to  $+5V$  with blanking voltage off.
5. Adjusted for minimum corner shading and best corner geometry.
6. Adjusted for minimum black shading. The supply for this electrode may be derived from that for grid 4.
7. Adjusted for picture focus. Focus may be obtained at several voltages in the range of adjustment provided, and a voltage should be selected to minimise moiré patterns and corner shading or to optimise geometry. This selection has to be made because of differences in yoke design between cameras of various manufacturers.
8. Adjusted to give the most uniform black shading near maximum signal. This adjustment must be made with the photocathode capped.
9. Adjusted for best picture. Excessive beam current increases noise.
10. The potential of dynode 3 relative to dynode 2 should be reduced to prevent the occurrence of a current reversal at the 5th dynode stage of tubes with a high d.c. output. The potential between the anode and dynode 5 must not drop below  $40V$  when anode currents up to  $100\mu A$  are drawn.
11. No part of the bulb may be more than  $5^{\circ}C$  hotter than the target section.
12. The size of the optical image of aspect ratio  $4 \times 3$  focused on the photocathode should be adjusted so that its maximum diagonal does not exceed 1.6 inches. The corresponding electron image on the target should have a size such that the corners of the rectangle just touch the target ring. Alternatively, a ring mask may be used, consisting of a perspex disc on which are inscribed two concentric circles of 0.96 and 1.28 inches diameter, placed in contact and concentric with the photocathode. Light is allowed to fall on the photocathode and an image of the rings obtained on the monitor. No lens is necessary. The scan amplitude and centring controls on the camera are adjusted until the diameter of the larger circle is equal to the width of the raster and the diameter of the small circle is equal to the height. Verify that the scanned patch is centrally located with respect to the target ring.
13. Lens stop. The light level is adjusted until the 'knee' of the transfer characteristic is reached by gradually opening the lens from its minimum aperture and observing the increase of the signal amplitude on the oscilloscope. The 'knee' is defined as the point at which the difference between signals from chips having densities 0 and 0.15, and from 0.15 and 0.3 are equal. The recommended operating point is obtained by increasing the aperture of the lens by half a calibration stop. If a lower target voltage is used, lower illumination is required to reach the 'knee'.
14. Signal current. With the tube set up to give best overall resolution, the gain is adjusted to give  $0.7V$  output from the channel, measured from

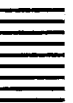

white to black level as determined with the lens capped. The tube signal is then removed from the head amplifier by biasing off the beam and a line frequency test signal (amplitude during active line period 0.7V) is injected to the head amplifier via an attenuator. The attenuator is adjusted to give 0.7V amplitude signal output from the channel. The attenuator setting is read and the input signal voltage to the amplifier is calculated. From the values for the amplifier input signal voltage and the image orthicon load resistor, the signal current is then calculated. Dynode 3 voltage may require adjustment to obtain a signal current below the specified maximum.

15. The peak white amplitude of the video waveform is set to 0.7V with respect to capped black to provide the reference signal and the signal to noise ratio is measured using a Rohde & Schwarz video noise meter type UPSF (or equivalent instrument). Other methods of measurement may produce different values.
16. Values of target voltage other than 3V can be used but a compromise must be made as signal to noise ratio and signal output increase with target voltage, while a decrease in target voltage improves sensitivity and resolution.
17. Amplitude at 400 lines per picture height at the centre of the picture, without aperture correction, relative to the large area black-white signal.
18. With illumination from a source of colour temperature 2854° K. Note that this is not the preferred operating point.

The illumination required on the scene is given by

$$I_{sc} = \frac{I_{pc} \cdot 4f^2 (m + 1)^2}{TR}$$

where  $I_{sc}$  = scene illumination in foot-candles

$I_{pc}$  = photocathode illumination

f = lens aperture number

m = magnification from scene to photocathode

T = lens transmission factor

R = scene reflectance.

For example, if a photocathode illumination of 0.072 ft-candle ( $I_{pc}$ ) is required for the 'knee', the illumination required at the operating point would be 0.10 ft-candle. For a lens aperture of f/5.6 and transmission of 80%, scene reflectance of 60% and (m + 1) closely approximating to 1, the scene illumination required for a photocathode illumination of 0.10 ft-candle would be approximately 26 ft-candles (265 lux).

19. After an exposure of any reasonable duration to a scene, any after image will become insignificant within 5 seconds.

# TYPICAL SPECTRAL SENSITIVITY CHARACTERISTIC

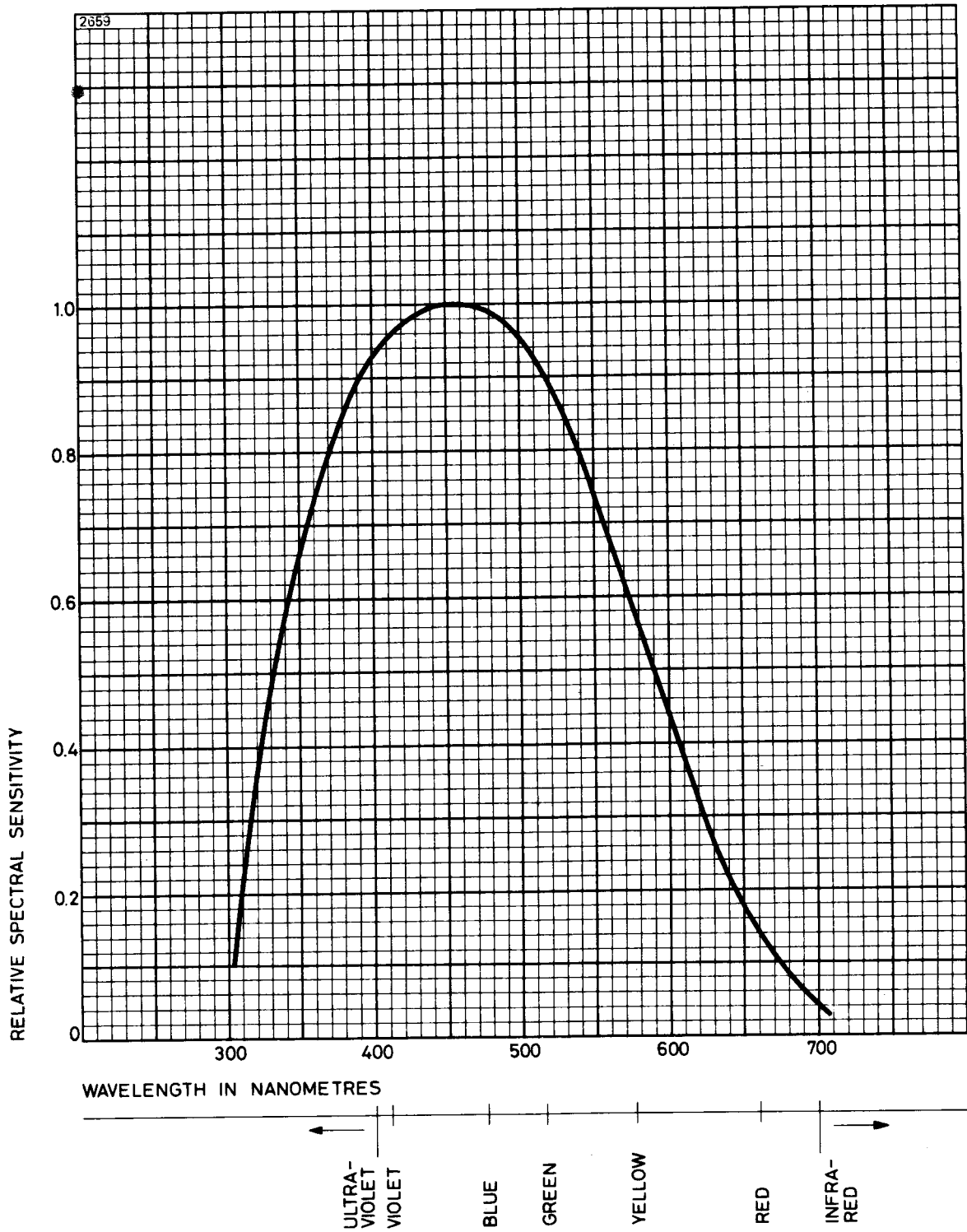

## TYPICAL TRANSFER CHARACTERISTIC

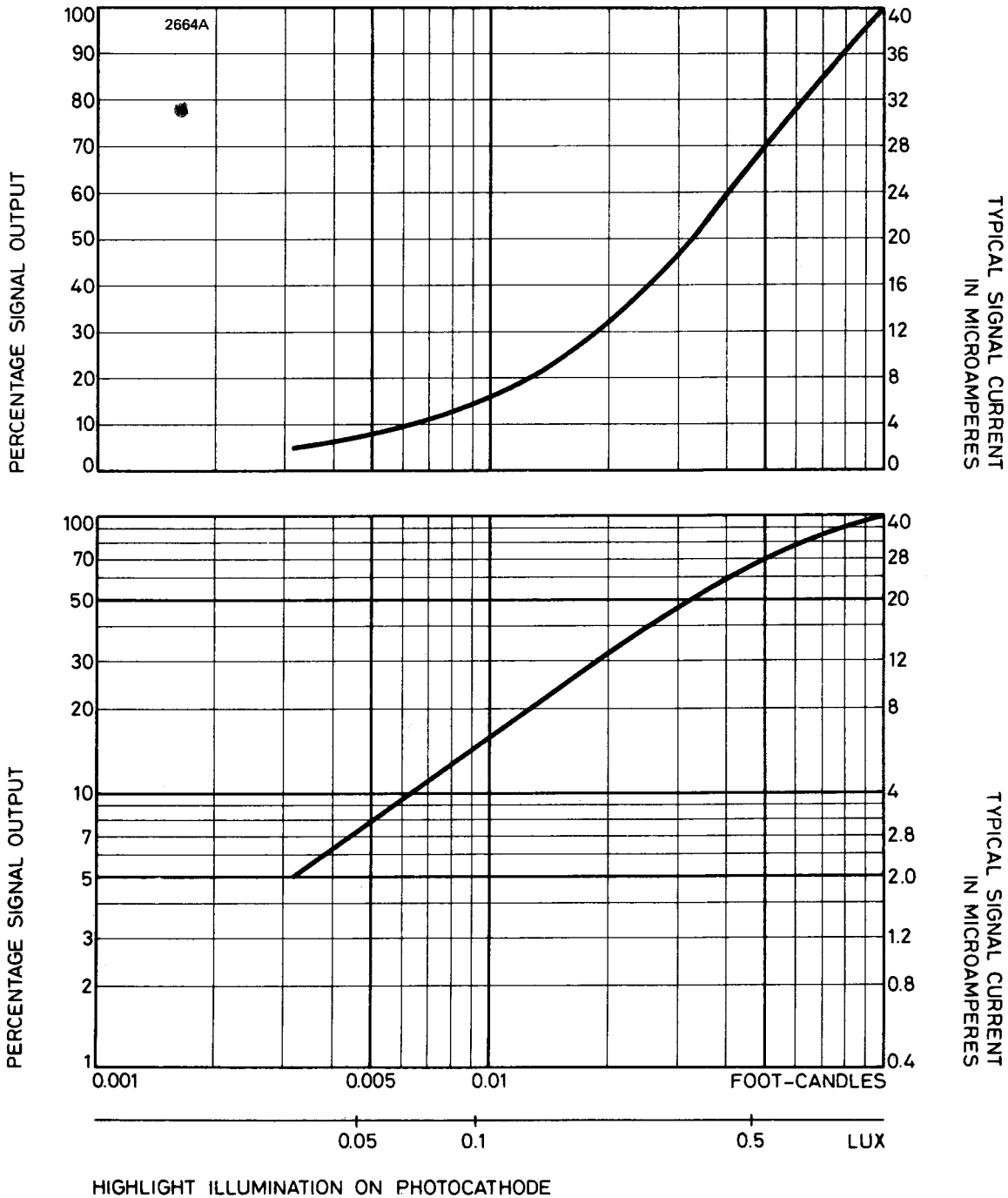

### Method of Obtaining 7389C Transfer Characteristic

The camera was accurately set up on a normal picture and then moved to view a scene comprising one step of a step wedge, surrounded by black. The method is described by D. C. Brothers in 'The Testing and Operation of 4½-inch Image Orthicon Tubes', Journal Brit. I.R.E. Vol. 19, p. 777 (1959).

**OUTLINE (All dimensions without limits are nominal)**

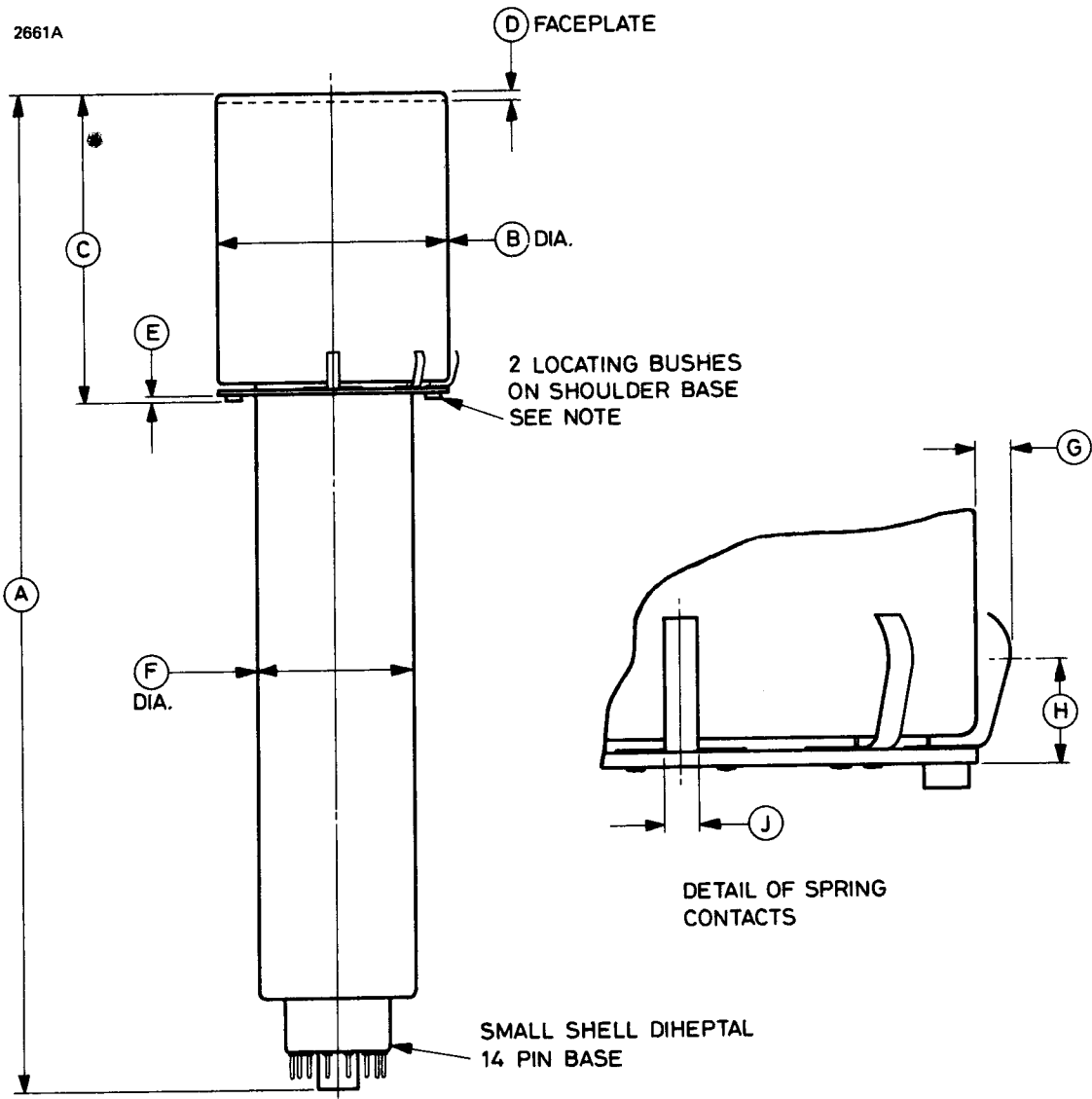

Ref	Inches	Millimetres	Ref	Inches	Millimetres
A	19.375 ± 0.150	492.1 ± 3.8	F	3.185 max	80.90 max
B	4.500 ± 0.094	114.3 ± 2.4	G	0.175 min	4.45 min
C	5.721 ± 0.125	145.3 ± 3.2	H	0.800	20.32
D	0.188	4.78	J	0.250	6.35
E	0.175 max	4.45 max			

Millimetre dimensions have been derived from inches.

**Note** These bushes are a push fit and may be removed by the customer if required. If this is done, the holes remaining are 0.311 inch (7.90mm) diameter, equally spaced on 4.000 inches (101.6mm) pitch circle diameter.

## OUTLINE DETAILS

### View on Base End of Tube

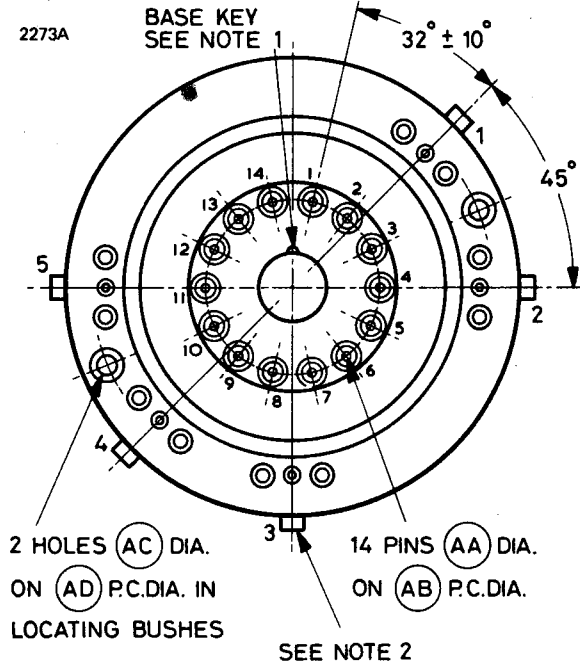

**Note 1.** The plane through the axis of the tube and the base key is coincident with the plane through shoulder base contact 3 and the axis of the tube to within  $10^\circ$ .

**Note 2.** The faceplate has an index mark in line with shoulder base contact 3.

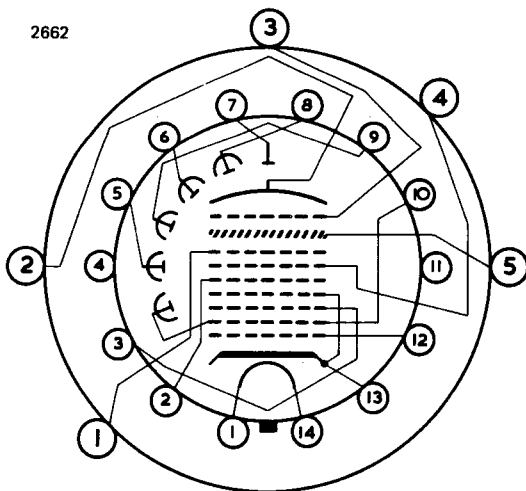

### Base Dimensions

Ref	Inches	Millimetres
AA	$0.093 \pm 0.002$	$2.362 \pm 0.051$
AB	$1.750 \pm 0.002$	$44.450 \pm 0.051$
AC	0.204	5.18
AD	$4.000 \pm 0.005$	$101.60 \pm 0.13$

Millimetre dimensions have been derived from inches.

### 14-Pin Base Connections

Pin	Element
1	Heater
2	Grid 4
3	Grid 3
4	Internal connection. Do not use
5	Dynode 2
6	Dynode 4
7	Anode
8	Dynode 5
9	Dynode 3
10	Dynode 1, Grid 2
11	Internal connection. Do not use
12	Grid 1
13	Cathode, Suppressor
14	Heater

### Shoulder Base Connections

Contact	Element
1	Field Mesh
2	Photocathode
3	Grid 6
4	Grid 5
5	Target



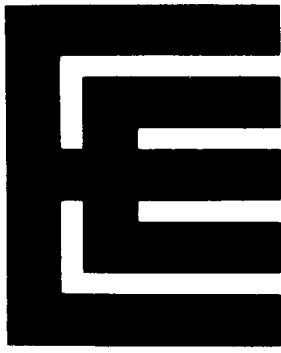

# P858

## IMAGE ORTHICON

---

The P858 is a 4½-inch image orthicon incorporating a high capacitance, improved ELCON (ELelectronically CONducting) target. This non-stick target has been designed to operate at voltages up to 4V, at which value a signal to noise ratio of 40db minimum can be achieved.

An important operational feature of the target is its ability to handle highlights without picture compression. Furthermore, throughout its life it will maintain constant gamma, sensitivity and resolution.

The maximum scene brightness required to reach the 'knee' of the transfer characteristic with a lens aperture of f/8 is 30ft-lamberts.

The P858 has been developed primarily for use as the luminance tube in colour cameras such as the TK42. It is equally suitable for monochrome cameras.

General operational details of the P858 are as for the 7389C, with which it is mechanically and electrically interchangeable.







## IMAGE ORTHICON

### INTRODUCTION

The P874 is a 3-inch image orthicon intended for use in studio and outside broadcast applications both for colour and monochrome. It gives stable performance over a wide range of light levels from deep shadows to bright sunlight.

New electron optical design principles have been applied to the electron gun of the P874. This results in a reduction of noise components in the beam and also a total absence of dynode background in the picture, giving pictures of considerably higher quality.

The long life Elcon\* target incorporated in the P874 produces pictures with virtually no image retention and results in stable sensitivity and gamma throughout the life of the tube. The special features of anti-ghost image design, suppressor electrode and field mesh developed for earlier types of tube are incorporated in this version.

The P874 has a high target capacitance relative to type P875 and may be used as a replacement for type 8093B. It will fit cameras using other types of 3-inch tube such as 7293B, 5820 etc. The operational sensitivity is in the region of f/5.6 at 8 foot-lamberts scene luminance with the lens adjusted to one stop above the 'knee' of the transfer characteristic.

The photocathode has a spectral sensitivity which when used with tungsten illumination gives an overall response closely approaching that of the eye.

This tube can be produced with a bialkali photocathode offering comparable performance

### GENERAL DATA

#### Electrical

Cathode . . . . .	indirectly heated, oxide coated
Heater voltage . . . . .	6.3 V
Heater current . . . . .	0.6 A
Inter-electrode capacitance:	
anode to all other electrodes . . . . .	12 pF max

\* Elcon target (Brit. pat. no. 1048390). The name Elcon has been derived from the properties of the target material, namely ELectronic CONducting as opposed to ionic conducting. Normal exposures of the Elcon target to reasonable light levels as encountered in standard television camera practice will give negligible image retention (sticking).



## Electrical (continued)

Focusing method . . . . .	magnetic
Deflection method . . . . .	magnetic
Magnetic fields:	
focusing field (see note 1) . . . . .	7.5mT (75G) approx
alignment field, adjustable . . . . .	0 to 0.3mT (0 to 3G)

## Mechanical

Overall length . . . . .	15.450 inches (393mm) max
Diameter of image section . . . . .	3.060 inches (77.8mm) max
Diameter of scanning section . . . . .	2.060 inches (52.4mm) max
Deflecting coil length . . . . .	5.000 inches (127mm)
Focusing coil length . . . . .	10.000 inches (254mm)
Photocathode distance inside end of focusing coil . . . . .	0.500 inch (12.7mm)
Alignment coil length . . . . .	0.940 inch (23.9mm)
Alignment coil location . . . . .	The alignment coil should be located on the tube so that its centre is at a distance of approximately 10.5 inches (267mm) from the faceplate of the tube and so positioned that its axis is coincident with the axis of the tube, the deflecting yoke, and the focusing coil. The precise distance depends on the coil design.

Useful size of rectangular image for standard operation:

Diagonal (centrally situated) . . . . .	1.800 inches (45.7mm) max
Orientation of rectangular image . . . . .	Proper orientation is obtained when the vertical scan is essentially parallel to the plane passing through the centre of the faceplate and Index Pin 7 of the shoulder base. Index Pin 7 should be at the bottom.

Net weight . . . . .	1 pound (454g) approx
Mounting position . . . . .	Any except with diheptal base up and with tube axis at an angle less than 20° from vertical.
End base . . . . .	small shell diheptal 14-pin (JEDEC No. B14-45)
Shoulder base . . . . .	keyed jumbo annular 7-pin

**Storage**

Recommended store temperature . . . . . 25 to 35 °C  
 Tubes should be stored in darkness. All tubes must be operated for at least 5 hours each month; this is one of the conditions of warranty.

**WARNING**

The following precautions should be observed when operating the tube:  
 1. Ensure that the temperature of the tube is within its recommended range.  
 2. Although image retention is virtually eliminated, it is preferable to avoid long term exposure to high contrast test patterns, particularly before the tube has reached operating temperature.

**MAXIMUM AND MINIMUM RATINGS (Absolute values)**

No individual rating should be exceeded

	<b>Min</b>	<b>Max</b>	
Heater voltage . . . . .	5.7	6.9	V
Photocathode voltage (image focus):			
negative value . . . . .	—	700	V
Grid 6 voltage (image accelerator):			
negative value . . . . .	—	700	V
Target voltage . . . . .	—	±10	V
Grid 5 voltage (decelerator) . . . . .	—	200	V
Grid 4 voltage (beam focus) . . . . .	—	350	V
Grid 3 voltage (multiplier focus) . . . . .	—	400	V
Grid 2 and dynode 1 voltage . . . . .	—	350	V
Grid 1 voltage (negative value, never positive) . . . . .	0	125	V
Anode voltage . . . . .	—	1350	V
Voltage per multiplier stage . . . . .	—	350	V
Peak heater to cathode voltage:			
heater negative with respect to cathode . . . . .	—	125	V
heater positive with respect to cathode . . . . .	—	10	V
Operating temperature of any part of bulb . . . . .	—	65	°C
Operating temperature of bulb at target section . . . . .	35	60	°C
Temperature difference between target section and any part of bulb hotter than target section . . . . .	—	5	°C
Peak illumination of faceplate:			
non-operating . . . . .	—	50	ft-candles
operating . . . . .	—	10	ft-candles



## TYPICAL OPERATION

### Operational Conditions

Photocathode voltage (image focus) (see note 2)	-300 to -500	V
Grid 6 voltage (image accelerator) (see note 3)	-150 to -350	V
Target cut-off voltage	-2	V
Target voltage above cut-off (see note 4)	2 to 4	V
Target blanking voltage (peak to peak)	5	V min
Grid 5 voltage (decelerator) (see note 5)	0 to 125	V
Grid 4 voltage (beam focus) (see note 6)	120 to 220	V
Grid 3 voltage (multiplier focus) (see note 7)	225 to 300	V
Grid 2 and dynode 1 voltage	300	V
Grid 1 voltage:		
normal (see note 8)	-25 to -115	V
for picture cut-off	-45 to -115	V
Dynode 2 voltage	600	V
Dynode 3 voltage (see note 9)	600 to 800	V
Dynode 4 voltage	1000	V
Dynode 5 voltage	1200	V
Anode voltage (see note 9)	1250	V
Heater voltage	6.3	V
Recommended target temperature range (see note 10)	35 to 45	°C
Magnetic fields:		
focusing field (see note 1)	7.5mT (75G)	
alignment field, adjustable (see page 5)	0 to 0.3mT (0 to 3G)	

### Performance Specification

The results given on page 5 are obtained by operating as follows:

- (i) With the operational conditions specified above but with the target voltage adjusted to 2V above cut-off,
- (ii) operating temperature 35 to 45°C,
- (iii) the lens stop adjusted in accordance with Note 11,
- (iv) 625-line operation,
- (v) set up in accordance with the Sequence of Adjustments on page 5.

	Min	Typical	Max	
Heater current . . . . .	540	600	660	mA
Signal current (see note 12) . . . .	10	15	30	$\mu$ A
Signal to noise ratio (see note 13):				
target 2V above cut-off . . . .	36	38	—	db
target 4V above cut-off . . . .	—	42	—	db
Amplitude response (see note 14) . .	60	75	—	%
Illumination required on photo-cathode to reach the 'knee' of the transfer characteristic (see notes 11 and 15) . . . . .	—	0.025	0.045	ft-candle
After image (see note 16) . . . . .	—	0	5	sec

The performance obtained may vary with the type of camera used.



### SEQUENCE OF ADJUSTMENTS

- (a) Insert the tube in the camera, then verify that the equipment is functioning and allow the tube to warm up† with lens capped, target biased off and scanning amplitude controls set at maximum. Adjust the beam controls to give a small amount of beam current. For optimum operating conditions the tube temperature must be between 40°C and 45°C.
- (b) Adjust the beam bias and the gain control until noise appears on the monitor screen.
- (c) Uncap the camera lens.
- (d) Increase the target voltage until the picture appears.
- (e) Adjust the alignment controls for maximum uniform video output. Approximately correct alignment setting is indicated by
  - (i) Superimposition of picture detail when using a 'wobulator' alignment aid.
  - (ii) minimum swirl of picture content when grid 4 (beam focus) voltage is varied.
- (f) Pan the camera so that a small area highlight moves horizontally across the picture. Adjust grid 6 (image accelerator) voltage to eliminate the 'ghost' image and adjust photocathode voltage for best focus. With the

† Warm-up time can be considerably reduced if care is exercised with exposure in the first few minutes after switch-on. Slight adjustments to the tube electrode potentials may also be necessary as the camera equipment settles down. Optimum tube performance will only be obtained within the specified range of temperatures.

camera stationary, slightly readjust grid 6 and photocathode voltages for best centre-to-corner resolution; this will be the setting for minimum 'S' distortion.

- (g) Set the target voltage approximately 2 volts above cut-off.
- (h) Adjust the beam current to the lowest value consistent with a satisfactory picture. Adjust the scanning raster to the correct size and aspect ratio (see note 17).
- (j) Adjust grid 5 (decelerator) for minimum corner shading and best geometry.
- (k) Adjust the lens aperture so that the white content of the picture is at the 'knee' of the tube transfer characteristic and open the lens a further stop. Excessive white compression and a rapid decrease in signal indicate dynode saturation. Adjust dynode 3 to remove this effect. Attempts to eliminate the effect by decreasing the overall anode voltage will generally cause further deterioration unless the voltage difference between anode and dynode 5 is preserved independently of voltage changes in the multiplier chain. Dynode 3 may be operated at lower voltages within the typical range, to avoid overloading the head amplifier.
- (l) With the line and frame shading controls at zero, adjust grid 3 (multiplier focus) for maximum output.
- (m) Cap the lens and adjust as follows:
  - (i) Line shading can be minimised by slight adjustment of grid 3 (multiplier focus)
  - (ii) Line and frame shading correction can be employed if the black shading has not been minimised satisfactorily by grid 3 adjustment.
- (n) Uncap the lens and expose to a plain white scene. Readjust the beam current to just discharge the white; if necessary minimise white shading by slight adjustments of the alignment controls.
- (p) Readjust the photocathode and grid 4 (beam focus) voltages for optimum resolution.

N.B. The practice of correcting non-uniform lighting in a studio by adjusting the tube shading controls is not recommended, as it leads to the need for continued adjustment as the camera is panned and introduces errors in the black level.



## NOTES

1. The direction of the focusing current should be such that a north pole is attracted to the image end of the focusing coil.
2. Adjusted for best focus.
3. 50% to 70% of photocathode voltage. Adjusted to eliminate 'ghost' image of highlight with the photocathode and grid 5 voltages at correct values.
4. Supply adjustable from  $-3$  to  $+5V$  with the blanking voltage off.
5. Adjusted for minimum corner shading and best corner geometry.
6. Adjusted for best focus. Focus may be obtained at several values of grid 4 (beam focus) voltage. Between these values small changes in shading, geometry and spurious signals may be observed, and the optimum value for the type of yoke should be chosen. This is usually 130 volts approximately.
7. Adjusted to give maximum signal.
8. Adjusted for best picture.
9. It is desirable to make provision for adjustments to the potential of dynode 3 relative to dynodes 2 and 4. It should be adjusted to prevent the occurrence of a current reversal at the 5th dynode stage of tubes with a high d.c. output. The potential between the anode and dynode 5 must not drop below 40V when anode currents up to  $100\mu A$  are drawn. This could occur at 4V target operation.
10. No part of the bulb may be more than  $5^{\circ}C$  hotter than the target section.
11. Lens stop. The light level is adjusted until the 'knee' of the transfer characteristic is reached by gradually opening the lens from its minimum aperture and observing the increase of the signal amplitude on the oscilloscope. The 'knee' is defined as the point at which the difference between signals from chips having densities 0 and 0.15, and from 0.15 and 0.3 are equal. The recommended operating point is obtained by increasing the aperture of the lens by one calibration stop.
12. Signal Current. With the tube set up to give best overall resolution, the gain is adjusted to give 0.7V output from the channel, measured from



white to black level as determined with the lens capped. The tube signal is then removed from the head amplifier by biasing off the beam and a line frequency test signal (amplitude during active line period 0.7V) is injected to the head amplifier via an attenuator. The attenuator is adjusted to give 0.7V amplitude signal output from the channel. The attenuator setting is read and the input signal voltage to the amplifier is calculated. From the values for the amplifier input signal voltage and the image orthicon load resistor, the signal current is then calculated. Dynode 3 voltage may require adjustment to obtain a signal current below the specified maximum.

13. The peak white amplitude of the video waveform is set to 0.7V with respect to capped black to provide the reference signal and the signal to noise ratio is measured using a Rohde & Schwarz video noise meter type UPSF (or equivalent instrument). A signal to noise ratio of 39db can be obtained with the target voltage adjusted to 4V above cut-off. Other methods of measurement may produce different values. See Note 9.
14. Amplitude at 400 lines per picture height at the centre of the picture, without aperture correction, relative to the large area black-white signal.
15. With illumination from a source of colour temperature 2854K. Note this is not the 'preferred operating point', which requires double this illumination.

The illumination required on the scene is given by

$$I_{sc} = \frac{I_{pc} \cdot 4f^2 (m + 1)^2}{TR}$$

where  $I_{sc}$  = scene illumination in foot-candles

$I_{pc}$  = photocathode illumination

$f$  = lens aperture number

$m$  = magnification from scene to photocathode

$T$  = lens transmission

$R$  = scene reflectance.

For example, if a photocathode illumination of 0.03 ft-candle ( $I_{pc}$ ) is required for the 'knee', the illumination required at the operating point would be 0.06 ft-candle. For a lens aperture of f/5.6 and transmission

of 80%, scene reflectance of 60% and  $(m + 1)$  approximating closely to 1, the scene illumination required for a photocathode illumination of 0.06 ft-candle would be approximately 16 ft-candles (160 lux).

16. After an exposure of any reasonable duration to a scene, any after image will become insignificant within five seconds.
17. The size of the optical image of aspect ratio 4 x 3 focused on the photocathode should be adjusted so that its maximum diagonal does not exceed 1.6 inches. The corresponding electron image on the target should have a size such that the corners of the rectangle just touch the target ring. Alternatively, a ring mask may be used, consisting of a perspex disc on which are inscribed two concentric circles of 0.96 and 1.28 inches diameter, placed in contact and concentric with the photocathode. Light is allowed to fall on the photocathode and an image of the rings obtained on the monitor. No lens is necessary. The scan amplitude and centring controls on the camera are adjusted until the diameter of the larger circle is equal to the width of the raster and the diameter of the small circle is equal to the height. Verify that the scanned patch is centrally located with respect to the target ring.

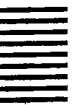

# TYPICAL SPECTRAL SENSITIVITY CHARACTERISTIC

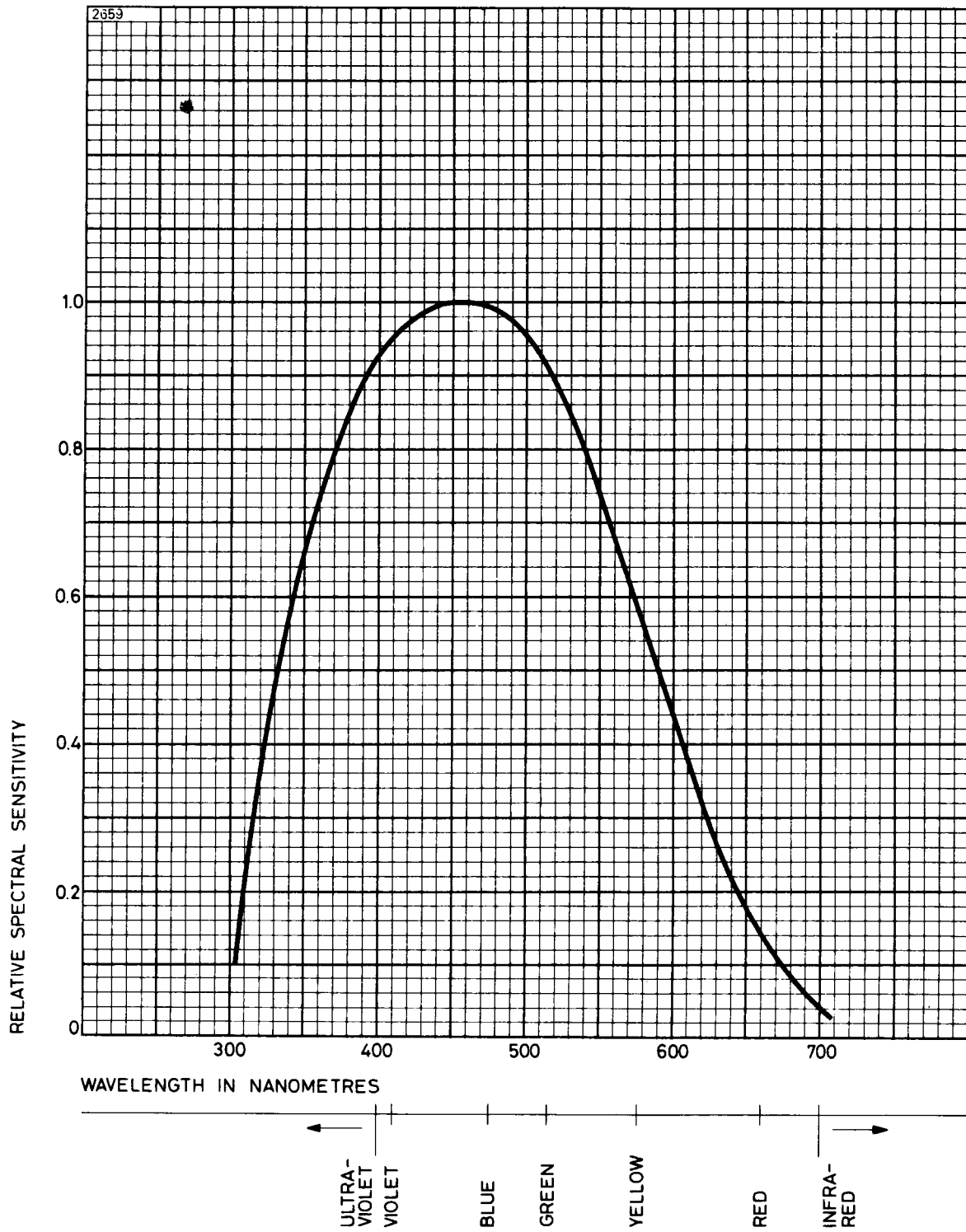

## TYPICAL TRANSFER CHARACTERISTIC

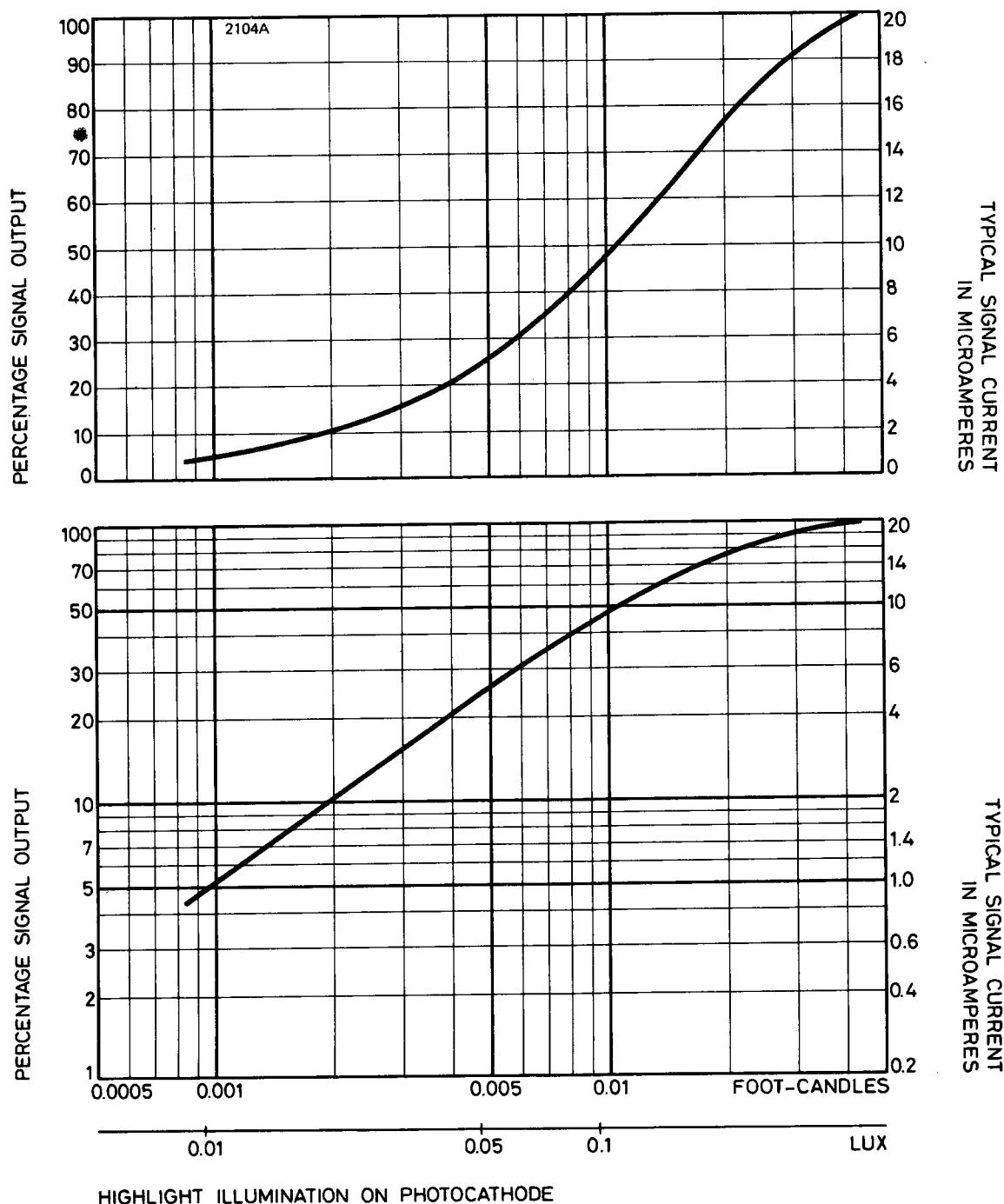

### Method of Obtaining P874 Transfer Characteristic

The camera was accurately set up on a normal picture and then moved to view a scene comprising one step of a step wedge, surrounded by black. The method is described by D. C. Brothers in 'The Testing and Operation of 4½-inch Image Orthicon Tubes', Journal Brit. I.R.E. Vol. 19, p. 777 (1959).

# OUTLINE

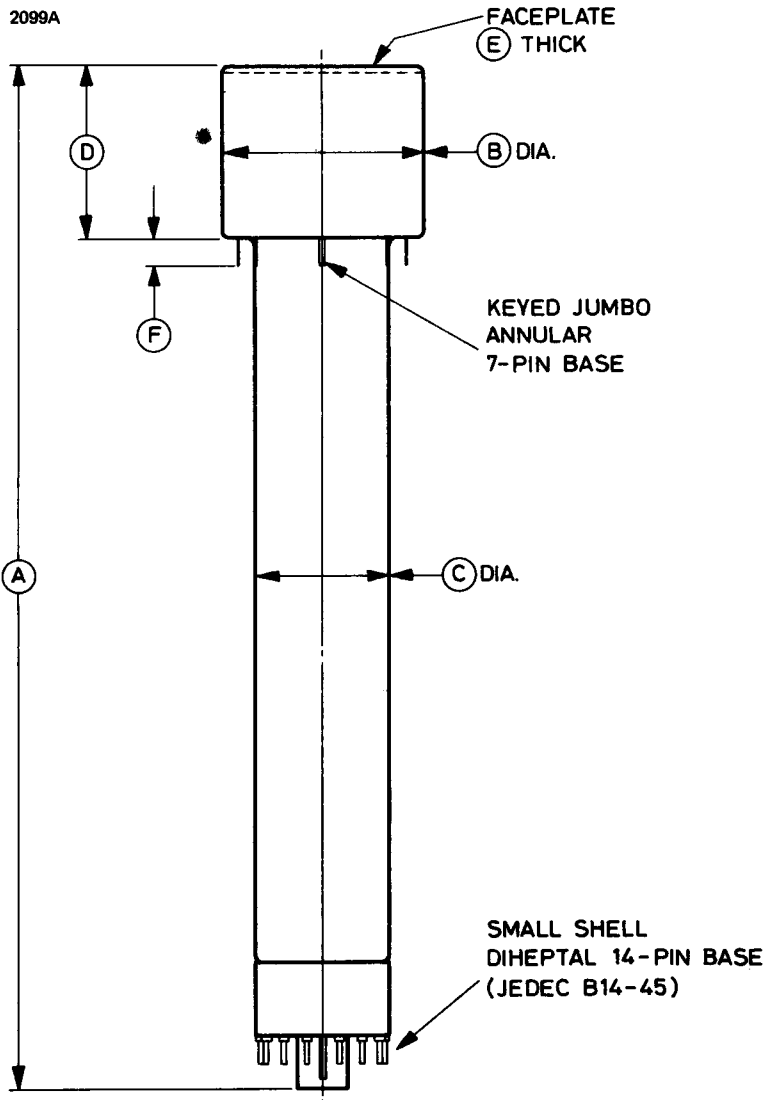

Ref	Inches	Millimetres
A	15.200 ± 0.250	386.1 ± 6.4
B	3.060 max	77.72 max
C	2.000 ± 0.060	50.80 ± 1.52
D	2.560 ± 0.120	65.02 ± 3.05
E	0.135 <sup>+0.015</sup> <sub>-0.025</sub>	3.43 <sup>+0.38</sup> <sub>-0.64</sub>
F	0.425 ± 0.025	10.80 ± 0.64

Millimetre dimensions have been derived from inches.

## OUTLINE DETAILS

2100A

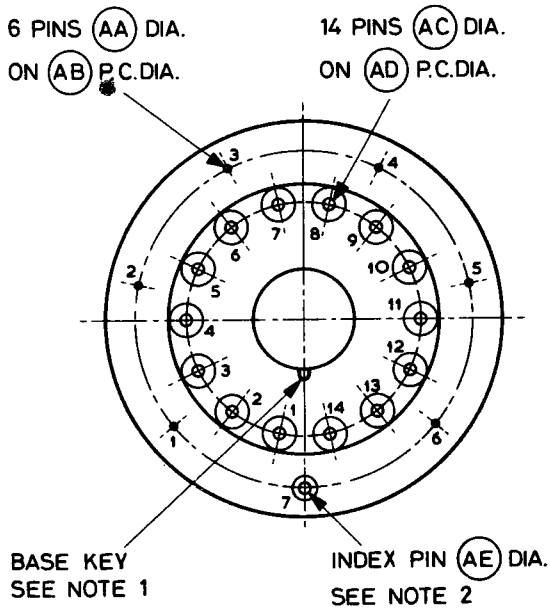

**Note 1.** The plane through the axis of the tube and the base key is coincident with the plane through the index pin of the 7 pin base and the axis of the tube to within  $10^\circ$ .

**Note 2.** The faceplate has an index mark in line with index pin 7.

2098

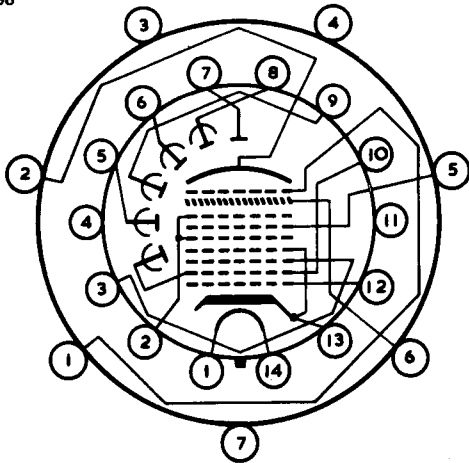

Ref	Inches	Millimetres
AA	$0.040 \pm 0.002$	$1.016 \pm 0.051$
AB	$2.500 \pm 0.015$	$63.50 \pm 0.38$
AC	$0.093 \pm 0.002$	$2.362 \pm 0.051$
AD	$1.750 \pm 0.002$	$44.450 \pm 0.051$
AE	$0.093 \pm 0.003$	$2.362 \pm 0.076$

Millimetre dimensions have been derived from inches.

## 14-PIN BASE CONNECTIONS

Pin	Element
1	Heater
2	Grid 4, Field Mesh
3	Grid 3
4	Internal connection. Do not use
5	Dynode 2
6	Dynode 4
7	Anode
8	Dynode 5
9	Dynode 3
10	Dynode 1, Grid 2
11	Internal connection. Do not use
12	Grid 1
13	Cathode, Suppressor
14	Heater

## 7-PIN ANNULAR BASE

Pin	Element
1	Grid 6
2	Photocathode
3	Internal connection. Do not use
4	Internal connection. Do not use
5	Grid 5
6	Target
7	Internal connection. Do not use

# OUTLINE DETAILS

## Detail of 7-pin Annular Base

2101A

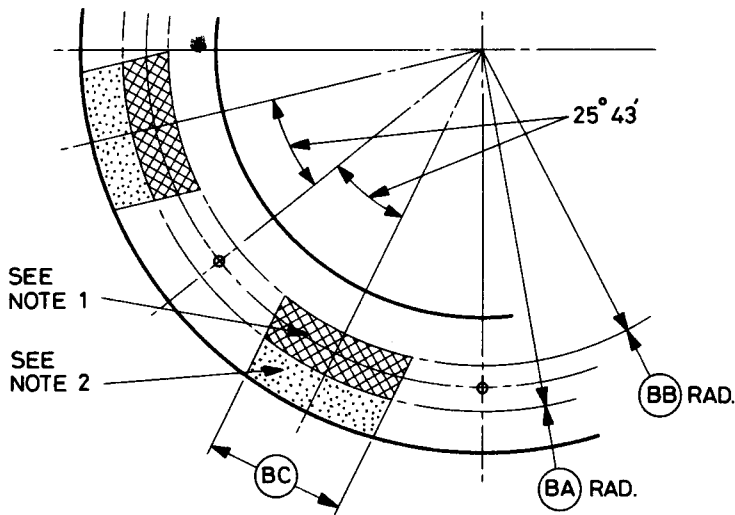

Ref	Inches	Millimetres
BA	1.315 min	33.40 min
BB	1.185 max	30.10 max
BC	0.500 min	12.70 min

Millimetre dimensions have been derived from inches.

### NOTES

1. The cross-hatched area is flat.
2. The dotted area is flat, or extends towards the diheptal-base end of the tube by 0.060 inch (1.52mm) maximum.
3. The angular variations between pins, as well as the eccentricity of the neck cylinder, are held to tolerances such that the pins and neck cylinder will fit the gauge shown on page 15.



# ANNULAR BASE GAUGE (All dimensions without limits are nominal)

2103A

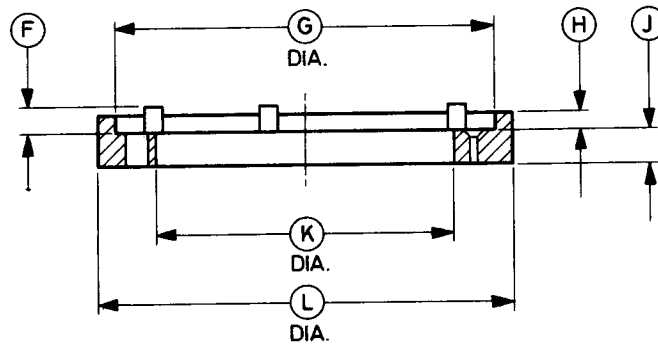
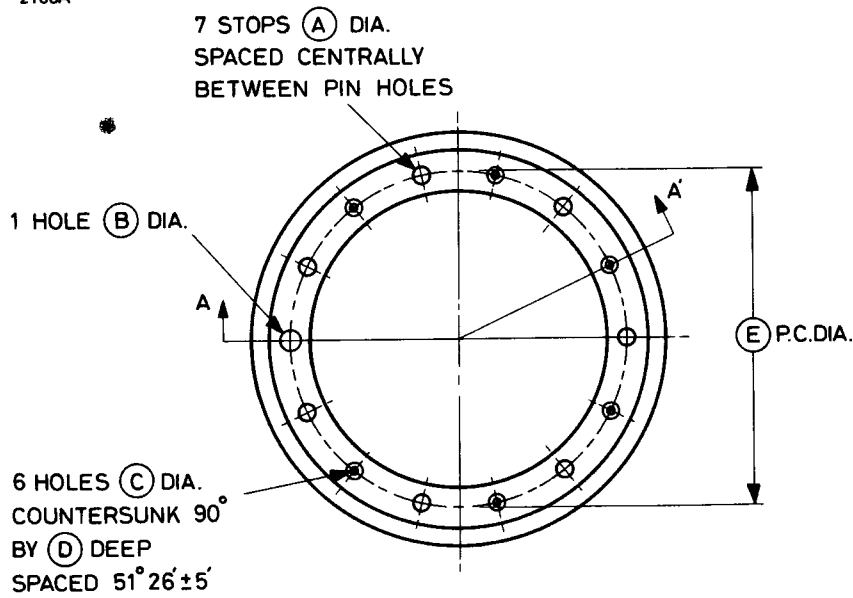

SECTION ON A-A'

Ref	Inches	Millimetres	Ref	Inches	Millimetres
A	0.125	3.18	G	2.812	71.42
B	0.150 ± 0.001	3.810 ± 0.025	H	0.126 ± 0.001	3.200 ± 0.025
C	0.065 ± 0.001	1.651 ± 0.025	J	0.265 ± 0.001	6.731 ± 0.025
D	0.047	1.19	K	2.200 ± 0.001	55.880 ± 0.025
E	2.500 ± 0.001	63.500 ± 0.025	L	3.062 min	77.77 min
F	0.187 ± 0.001	4.750 ± 0.025			

Millimetre dimensions have been derived from inches.





## IMAGE ORTHICON

### INTRODUCTION

The P875 is a 3-inch image orthicon intended for use in studio and outside broadcast applications both for colour and monochrome. It gives stable performance over a wide range of light levels from deep shadows to bright sunlight.

New electron optical design principles have been applied to the electron gun of the P875. This results in a reduction of noise components in the beam and also a total absence of dynode background in the picture, giving pictures of considerably higher quality.

The long life Elcon\* target incorporated in the P875 produces pictures with virtually no image retention and results in stable sensitivity and gamma throughout the life of the tube. The special features of anti-ghost image design, suppressor electrode and field mesh developed for earlier types of tube are incorporated in this version.

The P875 has a lower target capacitance relative to type P874 and may be used as a replacement for type 7293B. It will fit cameras using other types of 3-inch tube such as 8093B, 7293 and 5820 series. The operational sensitivity is in the region of f/5.6 at 6 foot-lamberts scene luminance with the lens adjusted to one stop above the 'knee' of the transfer characteristic.

The photocathode has a spectral sensitivity which when used with tungsten illumination gives an overall response closely approaching that of the eye.

This tube can be produced with a bialkali photocathode offering comparable performance.

### GENERAL DATA

#### Electrical

Cathode . . . . .	indirectly heated, oxide coated	
Heater voltage . . . . .	6.3	V
Heater current . . . . .	0.6	A
Inter-electrode capacitance:		
anode to all other electrodes . . . . .	12	pF max

\* Elcon target (Brit. pat. no. 1048390). The name Elcon has been derived from the properties of the target material, namely ELectronic CONducting as opposed to ionic conducting. Normal exposures of the Elcon target to reasonable light levels as encountered in standard television camera practice will give negligible image retention (sticking).



**Electrical (continued)**

Focusing method . . . . .	magnetic
Deflection method . . . . .	magnetic
Magnetic fields:	
focusing field (see note 1) . . . . .	7.5mT (75G) approx
alignment field, adjustable . . . . .	0 to 0.3mT (0 to 3G)

**Mechanical**

Overall length . . . . .	15.450 inches (393mm) max
Diameter of image section . . . . .	3.060 inches (77.8mm) max
Diameter of scanning section . . . . .	2.060 inches (52.4mm) max
Deflecting coil length . . . . .	5.000 inches (127mm)
Focusing coil length . . . . .	10.000 inches (254mm)
Photocathode distance inside end of focusing coil . . . . .	0.500 inch (12.7mm)
Alignment coil length . . . . .	0.940 inch (23.9mm)
Alignment coil location . . . . .	The alignment coil should be located on the tube so that its centre is at a distance of approximately 10.5 inches (267mm) from the faceplate of the tube and so positioned that its axis is coincident with the axis of the tube, the deflecting yoke, and the focusing coil. The precise distance depends on the coil design.

Useful size of rectangular image for standard operation:

Diagonal (centrally situated) . . . . .	1.800 inches (45.7mm) max
Orientation of rectangular image . . . . .	Proper orientation is obtained when the vertical scan is essentially parallel to the plane passing through the centre of the faceplate and Index Pin 7 of the shoulder base. Index Pin 7 should be at the bottom.

Net weight . . . . .	1 pound (454g) approx
Mounting position . . . . .	Any except with diheptal base up and with tube axis at an angle less than 20° from vertical.
End base . . . . .	small shell diheptal 14-pin (JEDEC No. B14-45)
Shoulder base . . . . .	keyed jumbo annular 7-pin

**Storage**

Recommended store temperature . . . . . 25 to 35 °C  
 Tubes should be stored in darkness. All tubes must be operated for at least 5 hours each month; this is one of the conditions of warranty.

**WARNING**

The following precautions should be observed when operating the tube:  
 1. Ensure that the temperature of the tube is within its recommended range.  
 2. Although image retention is virtually eliminated, it is preferable to avoid long term exposure to high contrast test patterns, particularly before the tube has reached operating temperature.

**MAXIMUM AND MINIMUM RATINGS (Absolute values)**

No individual rating should be exceeded

	<b>Min</b>	<b>Max</b>	
Heater voltage . . . . .	5.7	6.9	V
Photocathode voltage (image focus):			
negative value . . . . .	—	700	V
Grid 6 voltage (image accelerator):			
negative value . . . . .	—	700	V
Target voltage . . . . .	—	±10	V
Grid 5 voltage (decelerator) . . . . .	—	200	V
Grid 4 voltage (beam focus) . . . . .	—	350	V
Grid 3 voltage (multiplier focus) . . . . .	—	400	V
Grid 2 and dynode 1 voltage . . . . .	—	350	V
Grid 1 voltage (negative value, never positive) . . . . .	0	125	V
Anode voltage . . . . .	—	1350	V
Voltage per multiplier stage . . . . .	—	350	V
Peak heater to cathode voltage:			
heater negative with respect to cathode . . . . .	—	125	V
heater positive with respect to cathode . . . . .	—	10	V
Operating temperature of any part of bulb . . . . .	—	65	°C
Operating temperature of bulb at target section . . . . .	35	60	°C
Temperature difference between target section and any part of bulb hotter than target section . . . . .	—	5	°C
Peak illumination of faceplate:			
non-operating . . . . .	—	50	ft-candles
operating . . . . .	—	10	ft-candles



## TYPICAL OPERATION

### Operational Conditions

Photocathode voltage (image focus) (see note 2)	−300 to −500	V
Grid 6 voltage (image accelerator) (see note 3)	−150 to −350	V
Target cut-off voltage	−2	V
Target voltage above cut-off (see note 4)	2 to 4	V
Target blanking voltage (peak to peak)	5	V min
Grid 5 voltage (decelerator) (see note 5)	0 to 125	V
Grid 4 voltage (beam focus) (see note 6)	120 to 220	V
Grid 3 voltage (multiplier focus) (see note 7)	225 to 300	V
Grid 2 and dynode 1 voltage	300	V
Grid 1 voltage:		
normal (see note 8)	−25 to −115	V
for picture cut-off	−45 to −115	V
Dynode 2 voltage	600	V
Dynode 3 voltage (see note 9)	600 to 800	V
Dynode 4 voltage	1000	V
Dynode 5 voltage	1200	V
Anode voltage (see note 9)	1250	V
Heater voltage	6.3	V
Recommended target temperature range (see note 10)	35 to 45	°C
Magnetic fields:		
focusing field (see note 1)	7.5mT (75G)	
alignment field, adjustable (see page 5)	0 to 0.3mT (0 to 3G)	

### Performance Specification

The results given on page 5 are obtained by operating as follows:

- (a) with the operational conditions specified above but with the target voltage adjusted to 2V above cut-off,
- (b) operating temperature 35 to 45°C,
- (c) the lens stop adjusted in accordance with Note 11,
- (d) 625-line operation,
- (e) set up in accordance with the Sequence of Adjustments on page 5.

**Storage**

Recommended store temperature . . . . . 25 to 35 °C  
 Tubes should be stored in darkness. All tubes must be operated for at least 5 hours each month; this is one of the conditions of warranty.

**WARNING**

The following precautions should be observed when operating the tube:  
 1. Ensure that the temperature of the tube is within its recommended range.  
 2. Although image retention is virtually eliminated, it is preferable to avoid long term exposure to high contrast test patterns, particularly before the tube has reached operating temperature.

**MAXIMUM AND MINIMUM RATINGS (Absolute values)**

No individual rating should be exceeded

	<b>Min</b>	<b>Max</b>	
Heater voltage . . . . .	5.7	6.9	V
Photocathode voltage (image focus):			
negative value . . . . .	—	700	V
Grid 6 voltage (image accelerator):			
negative value . . . . .	—	700	V
Target voltage . . . . .	—	±10	V
Grid 5 voltage (decelerator) . . . . .	—	200	V
Grid 4 voltage (beam focus) . . . . .	—	350	V
Grid 3 voltage (multiplier focus) . . . . .	—	400	V
Grid 2 and dynode 1 voltage . . . . .	—	350	V
Grid 1 voltage (negative value, never positive) . . . . .	0	125	V
Anode voltage . . . . .	—	1350	V
Voltage per multiplier stage . . . . .	—	350	V
Peak heater to cathode voltage:			
heater negative with respect to cathode . . . . .	—	125	V
heater positive with respect to cathode . . . . .	—	10	V
Operating temperature of any part of bulb . . . . .	—	65	°C
Operating temperature of bulb at target section . . . . .	35	60	°C
Temperature difference between target section and any part of bulb hotter than target section . . . . .	—	5	°C
Peak illumination of faceplate:			
non-operating . . . . .	—	50	ft-candles
operating . . . . .	—	10	ft-candles



## TYPICAL OPERATION

### Operational Conditions

Photocathode voltage (image focus) (see note 2)	-300 to -500	V
Grid 6 voltage (image accelerator) (see note 3)	-150 to -350	V
Target cut-off voltage	-2	V
Target voltage above cut-off (see note 4)	2 to 4	V
Target blanking voltage (peak to peak)	5	V min
Grid 5 voltage (decelerator) (see note 5)	0 to 125	V
Grid 4 voltage (beam focus) (see note 6)	120 to 220	V
Grid 3 voltage (multiplier focus) (see note 7)	225 to 300	V
Grid 2 and dynode 1 voltage	300	V
Grid 1 voltage:		
normal (see note 8)	-25 to -115	V
for picture cut-off	-45 to -115	V
Dynode 2 voltage	600	V
Dynode 3 voltage (see note 9)	600 to 800	V
Dynode 4 voltage	1000	V
Dynode 5 voltage	1200	V
Anode voltage (see note 9)	1250	V
Heater voltage	6.3	V
Recommended target temperature range (see note 10)	35 to 45	°C
Magnetic fields:		
focusing field (see note 1)	7.5mT (75G)	
alignment field, adjustable (see page 5)	0 to 0.3mT (0 to 3G)	

### Performance Specification

The results given on page 5 are obtained by operating as follows:

- (a) with the operational conditions specified above but with the target voltage adjusted to 2V above cut-off,
- (b) operating temperature 35 to 45°C,
- (c) the lens stop adjusted in accordance with Note 11,
- (d) 625-line operation,
- (e) set up in accordance with the Sequence of Adjustments on page 5.



	Min	Typical	Max	
Heater current . . . . .	540	600	660	mA
Signal current (see note 12) . . . . .	10	12	30	$\mu$ A
Signal to noise ratio (see note 13):				
target 2V above cut-off . . . . .	34	36	—	db
target 4V above cut-off . . . . .	—	39	—	db
Amplitude response (see note 14) . . . . .	60	75	—	%
Illumination required on photo-cathode to reach the 'knee' of the transfer characteristic (see notes 11 and 15) . . . . .	—	0.015	0.035	ft-candle
After image (see note 16) . . . . .	—	0	5	sec

The performance obtained may vary with the type of camera used.

### SEQUENCE OF ADJUSTMENTS

- (a) Insert the tube in the camera, then verify that the equipment is functioning and allow the tube to warm up† with lens capped, target biased off and scanning amplitude controls set at maximum. Adjust the beam controls to give a small amount of beam current. For optimum operating conditions the tube temperature must be between 40°C and 45°C.
- (b) Adjust the beam bias and the gain control until noise appears on the monitor screen.
- (c) Uncap the camera lens.
- (d) Increase the target voltage until the picture appears.
- (e) Adjust the alignment controls for maximum uniform video output. Approximately correct alignment setting is indicated by
  - (i) Superimposition of picture detail when using a 'wobulator' alignment aid.
  - (ii) minimum swirl of picture content when grid 4 (beam focus) voltage is varied.
- (f) Pan the camera so that a small area highlight moves horizontally across the picture. Adjust grid 6 (image accelerator) voltage to eliminate the 'ghost' image and adjust photocathode voltage for best focus. With the

† Warm-up time can be considerably reduced if care is exercised with exposure in the first few minutes after switch-on. Slight adjustments to the tube electrode potentials may also be necessary as the camera equipment settles down. Optimum tube performance will only be obtained within the specified range of temperatures.

camera stationary, slightly readjust grid 6 and photocathode voltages for best centre-to-corner resolution; this will be the setting for minimum 'S' distortion.

- (g) Set the target voltage approximately 2 volts above cut-off.
- (h) Adjust the beam current to the lowest value consistent with a satisfactory picture. Adjust the scanning raster to the correct size and aspect ratio (see note 17).
- (j) Adjust grid 5 (decelerator) for minimum corner shading and best geometry.
- (k) Adjust the lens aperture so that the white content of the picture is at the 'knee' of the tube transfer characteristic and open the lens a further stop. Excessive white compression and a rapid decrease in signal indicate dynode saturation. Adjust dynode 3 to remove this effect. Attempts to eliminate the effect by decreasing the overall anode voltage will generally cause further deterioration unless the voltage difference between anode and dynode 5 is preserved independently of voltage changes in the multiplier chain. Dynode 3 may be operated at lower voltages within the typical range, to avoid overloading the head amplifier.
- (l) With the line and frame shading controls at zero, adjust grid 3 (multiplier focus) for maximum output.
- (m) Cap the lens and adjust as follows:
  - (i) Line shading can be minimised by slight adjustment of grid 3 (multiplier focus).
  - (ii) Line and frame shading correction can be employed if the black shading has not been minimised satisfactorily by grid 3 adjustment.
- (n) Uncap the lens and expose to a plain white scene. Readjust the beam current to just discharge the white; if necessary minimise white shading by slight adjustments of the alignment controls.
- (p) Readjust the photocathode and grid 4 (beam focus) voltages for optimum resolution.

N.B. The practice of correcting non-uniform lighting in a studio by adjusting the tube shading controls is not recommended, as it leads to the need for continued adjustment as the camera is panned and introduces errors in the black level.

## NOTES

1. The direction of the focusing current should be such that a north pole is attracted to the image end of the focusing coil.
2. Adjusted for best focus.
3. 50% to 70% of photocathode voltage. Adjusted to eliminate 'ghost' image of highlight with the photocathode and grid 5 voltages at correct values.
4. Supply adjustable from  $-3$  to  $+5V$  with the blanking voltage off.
5. Adjusted for minimum corner shading and best corner geometry.
6. Adjusted for best focus. Focus may be obtained at several values of grid 4 (beam focus) voltage. Between these values small changes in shading, geometry and spurious signals may be observed, and the optimum value for the type of yoke should be chosen. This is usually 130 volts approximately.
7. Adjusted to give maximum signal.
8. Adjusted for best picture.
9. It is desirable to make provision for adjustments to the potential of dynode 3 relative to dynodes 2 and 4. It should be adjusted to prevent the occurrence of a current reversal at the 5th dynode stage of tubes with a high d.c. output. The potential between the anode and dynode 5 must not drop below 40V when anode currents up to  $100\mu A$  are drawn. This could occur at 4V target operation.
10. No part of the bulb may be more than  $5^{\circ}C$  hotter than the target section.
11. Lens stop. The light level is adjusted until the 'knee' of the transfer characteristic is reached by gradually opening the lens from its minimum aperture and observing the increase of the signal amplitude on the oscilloscope. The 'knee' is defined as the point at which the difference between signals from chips having densities 0 and 0.15, and from 0.15 and 0.3 are equal. The recommended operating point is obtained by increasing the aperture of the lens by one calibration stop.
12. Signal Current. With the tube set up to give best overall resolution, the gain is adjusted to give 0.7V output from the channel, measured from

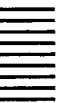

white to black level as determined with the lens capped. The tube signal is then removed from the head amplifier by biasing off the beam and a line frequency test signal (amplitude during active line period 0.7V) is injected to the head amplifier via an attenuator. The attenuator is adjusted to give 0.7V amplitude signal output from the channel. The attenuator setting is read and the input signal voltage to the amplifier is calculated. From the values for the amplifier input signal voltage and the image orthicon load resistor, the signal current is then calculated. Dynode 3 voltage may require adjustment to obtain a signal current below the specified maximum.

13. The peak white amplitude of the video waveform is set to 0.7V with respect to capped black to provide the reference signal and the signal to noise ratio is measured using a Rohde & Schwarz video noise meter type UPSF (or equivalent instrument). A signal to noise ratio of 39db can be obtained with the target voltage adjusted to 4V above cut-off. Other methods of measurement may produce different values. See Note 9.
14. Amplitude at 400 lines per picture height at the centre of the picture, without aperture correction, relative to the large area black-white signal.
15. With illumination from a source of colour temperature 2854K. Note this is not the 'preferred operating point', which requires double this illumination.

The illumination required on the scene is given by

$$I_{sc} = \frac{I_{pc} \cdot 4f^2 (m + 1)^2}{TR}$$

where  $I_{sc}$  = scene illumination in foot-candles

$I_{pc}$  = photocathode illumination

$f$  = lens aperture number

$m$  = magnification from scene to photocathode

$T$  = lens transmission

$R$  = scene reflectance.

For example, if a photocathode illumination of 0.028 ft-candle ( $I_{pc}$ ) is required for the 'knee', the illumination required at the operating point would be 0.056 ft-candle. For a lens aperture of  $f/5.6$  and transmission

of 80%, scene reflectance of 60% and  $(m + 1)$  approximating closely to 1, the scene illumination required for a photocathode illumination of 0.056 ft-candle would be approximately 14.5 ft-candles (145 lux).

16. After an exposure of any reasonable duration to a scene, any after image will become insignificant within five seconds.
17. The size of the optical image of aspect ratio 4 x 3 focused on the photocathode should be adjusted so that its maximum diagonal does not exceed 1.6 inches. The corresponding electron image on the target should have a size such that the corners of the rectangle just touch the target ring. Alternatively, a ring mask may be used, consisting of a perspex disc on which are inscribed two concentric circles of 0.96 and 1.28 inches diameter, placed in contact and concentric with the photocathode. Light is allowed to fall on the photocathode and an image of the rings obtained on the monitor. No lens is necessary. The scan amplitude and centring controls on the camera are adjusted until the diameter of the larger circle is equal to the width of the raster and the diameter of the small circle is equal to the height. Verify that the scanned patch is centrally located with respect to the target ring.

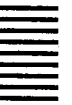

# TYPICAL SPECTRAL SENSITIVITY CHARACTERISTIC

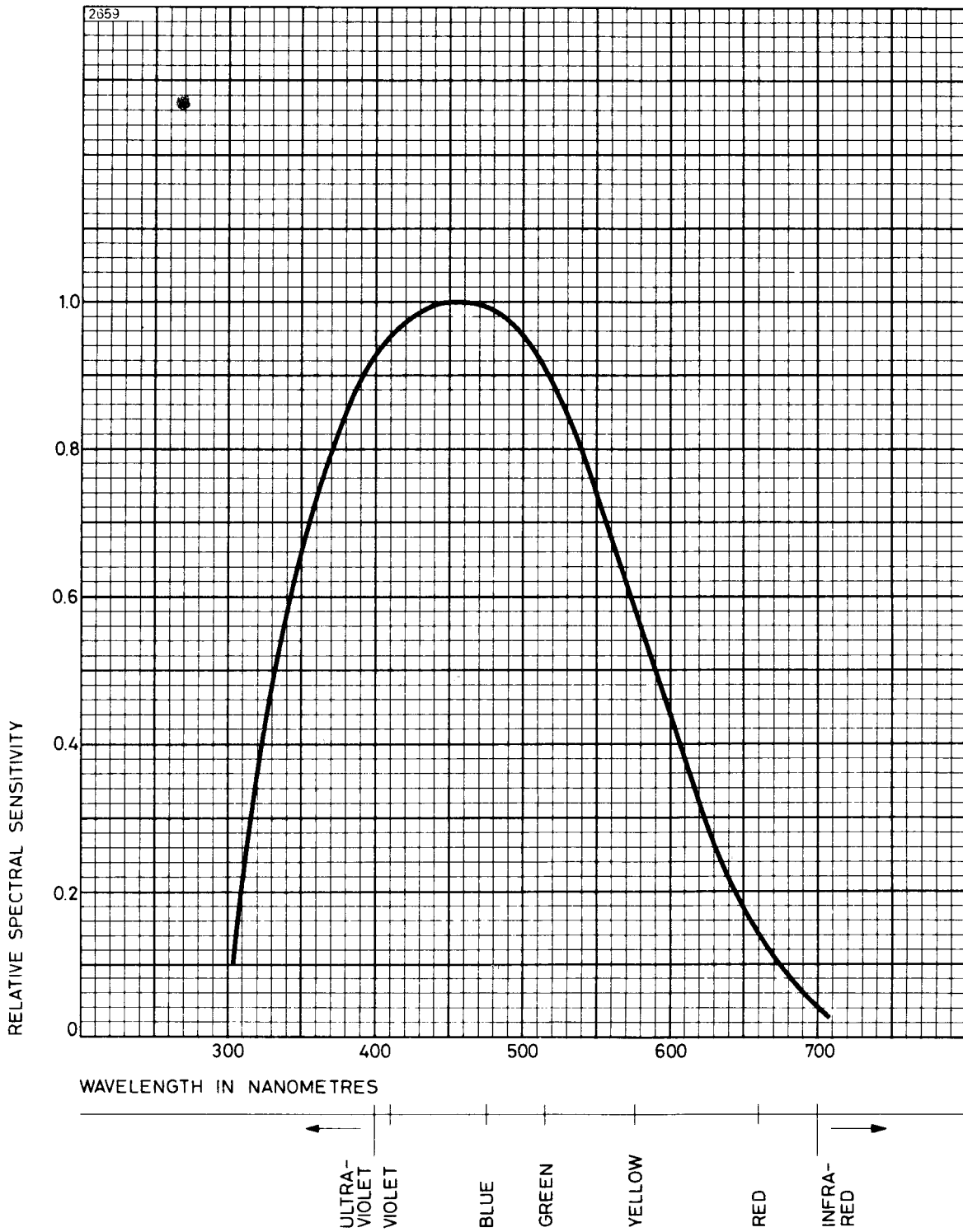

## TYPICAL TRANSFER CHARACTERISTIC

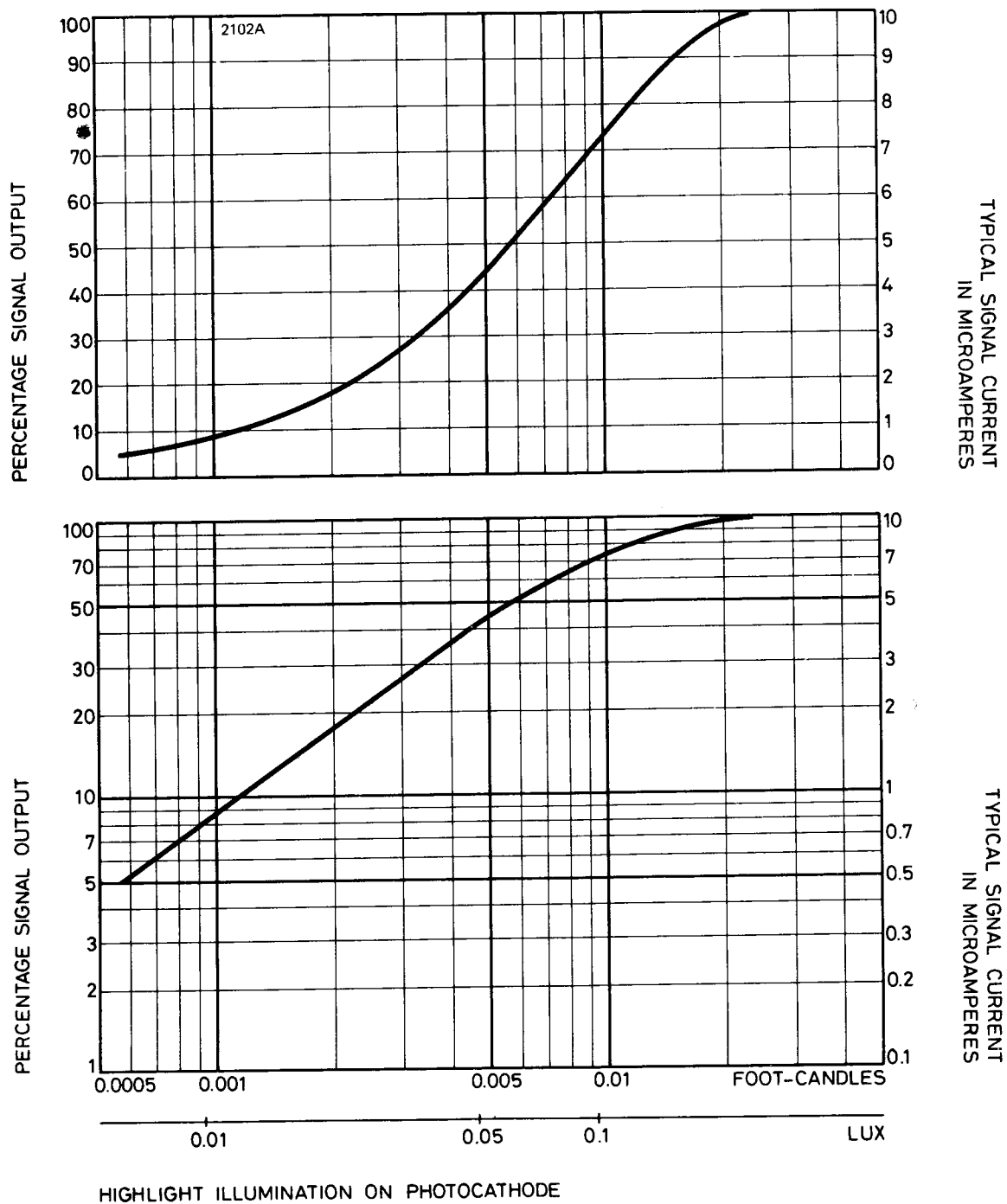

### Method of Obtaining P875 Transfer Characteristic

The camera was accurately set up on a normal picture and then moved to view a scene comprising one step of a step wedge, surrounded by black. The method is described by D. C. Brothers in 'The Testing and Operation of 4½-inch Image Orthicon Tubes', Journal Brit. I.R.E. Vol. 19, p. 777 (1959).

# OUTLINE

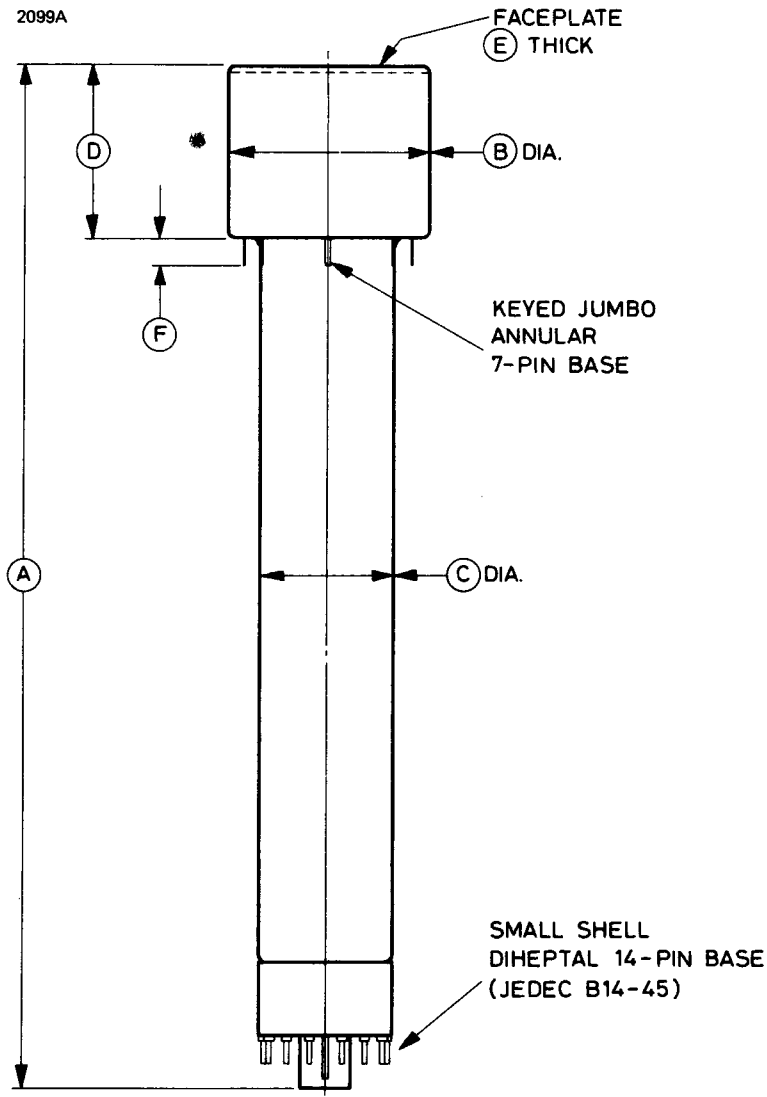

Ref	Inches	Millimetres
A	15.200 ± 0.250	386.1 ± 6.4
B	3.060 max	77.72 max
C	2.000 ± 0.060	50.80 ± 1.52
D	2.560 ± 0.120	65.02 ± 3.05
E	0.135 <sup>+ 0.015</sup> - 0.025	3.43 <sup>+ 0.38</sup> - 0.64
F	0.425 ± 0.025	10.80 ± 0.64

Millimetre dimensions have been derived from inches.



## OUTLINE DETAILS

2100A

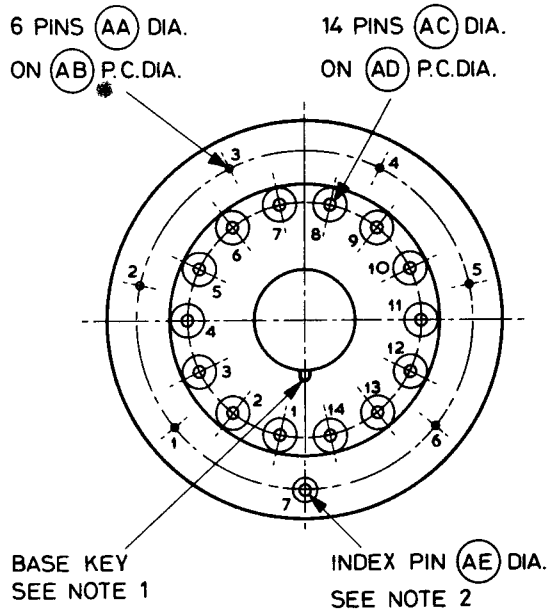

**Note 1.** The plane through the axis of the tube and the base key is coincident with the plane through the index pin of the 7-pin base and the axis of the tube to within  $10^\circ$ .

**Note 2.** The faceplate has an index mark in line with index pin 7.

2098

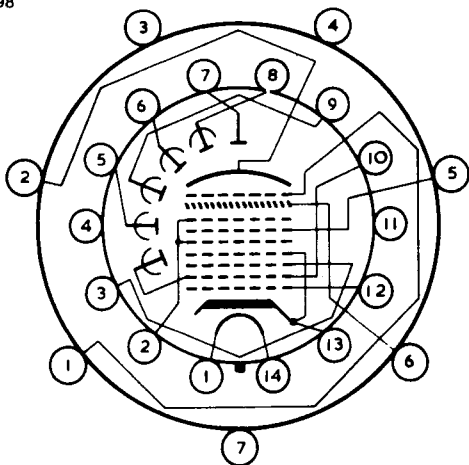

Ref	Inches	Millimetres
AA	$0.040 \pm 0.002$	$1.016 \pm 0.051$
AB	$2.500 \pm 0.015$	$63.50 \pm 0.38$
AC	$0.093 \pm 0.002$	$2.362 \pm 0.051$
AD	$1.750 \pm 0.002$	$44.450 \pm 0.051$
AE	$0.093 \pm 0.003$	$2.362 \pm 0.076$

Millimetre dimensions have been derived from inches.

### 14-PIN BASE CONNECTIONS

Pin	Element
1	Heater
2	Grid 4, Field Mesh
3	Grid 3
4	Internal connection. Do not use
5	Dynode 2
6	Dynode 4
7	Anode
8	Dynode 5
9	Dynode 3
10	Dynode 1, Grid 2
11	Internal connection. Do not use
12	Grid 1
13	Cathode, Suppressor
14	Heater

### 7-PIN ANNULAR BASE

Pin	Element
1	Grid 6
2	Photocathode
3	Internal connection. Do not use.
4	Internal connection. Do not use
5	Grid 5
6	Target
7	Internal connection. Do not use

# OUTLINE DETAILS

## Detail of 7-pin Annular Base

2101A

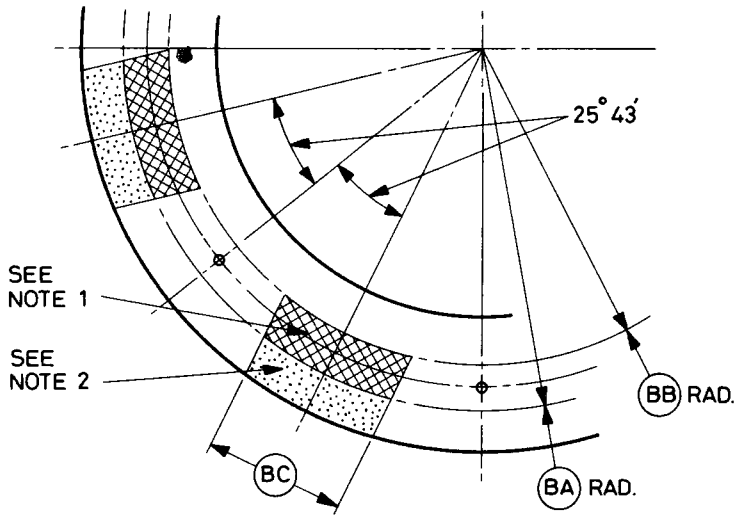

Ref	Inches	Millimetres
BA	1.315 min	33.40 min
BB	1.185 max	30.10 max
BC	0.500 min	12.70 min

Millimetre dimensions have been derived from inches.

### Notes

1. The cross-hatched area is flat.
2. The dotted area is flat, or extends towards the diheptal-base end of the tube by 0.060 inch (1.52mm) maximum.
3. The angular variations between pins, as well as the eccentricity of the neck cylinder, are held to tolerances such that the pins and neck cylinder will fit the gauge shown on page 15.

# ANNULAR BASE GAUGE (All dimensions without limits are nominal)

2103A

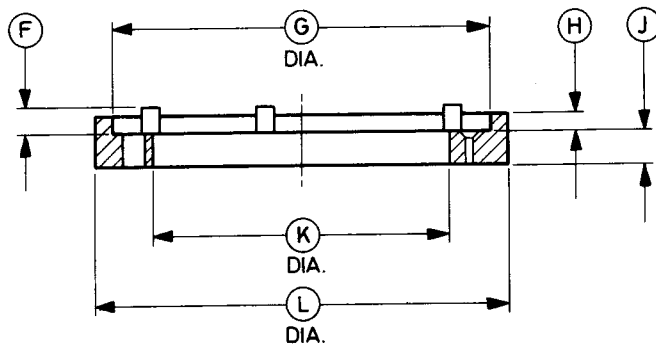
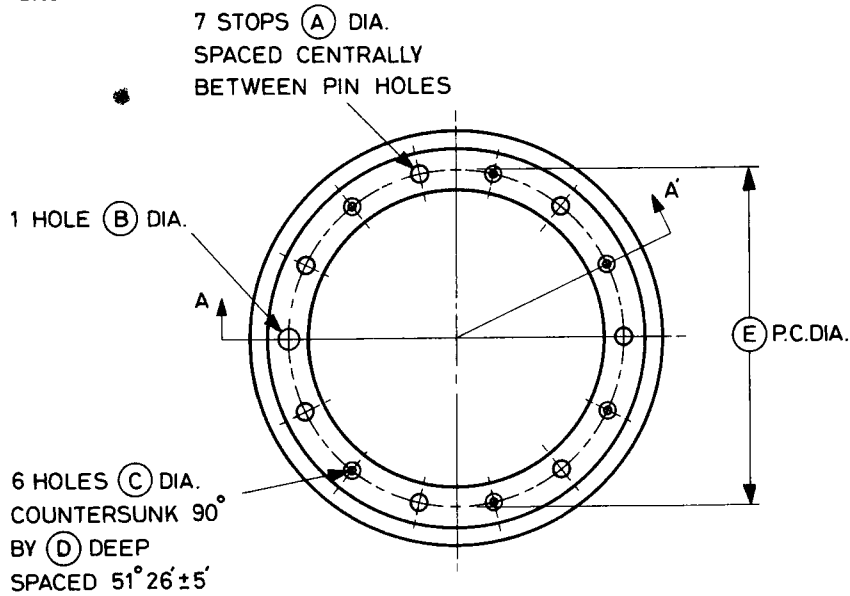

SECTION ON A-A'

Ref	Inches	Millimetres	Ref	Inches	Millimetres
A	0.125	3.18	G	2.812	71.42
B	0.150 ± 0.001	3.810 ± 0.025	H	0.126 ± 0.001	3.200 ± 0.025
C	0.065 ± 0.001	1.651 ± 0.025	J	0.265 ± 0.001	6.731 ± 0.025
D	0.047	1.19	K	2.200 ± 0.001	55.880 ± 0.025
E	2.500 ± 0.001	63.500 ± 0.025	L	3.062 min	77.77 min
F	0.187 ± 0.001	4.750 ± 0.025			

Millimetre dimensions have been derived from inches.



# Image Isocons





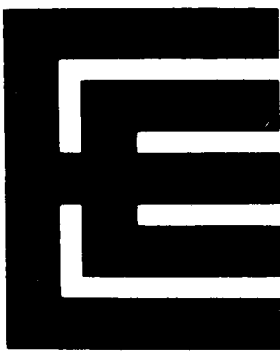

### INTRODUCTION

The P850 is a 4½-inch image isocon designed for television pick-up from the very low intensity images of X-ray fluoroscopic screens. It has a curved faceplate for use in conjunction with mirror optical systems. With a suitable corrector plate, a refractive optical system can also be used. With a fixed beam current it will reproduce scenes having a wide dynamic range, with good tonal response and without the beam noise associated with image orthicons.

### PRINCIPLES OF OPERATION

#### The Image Section

The image section and target operate as in an image orthicon to produce a charge pattern on the scanned side of the target.

#### The Scanning Beam

The scanning beam is generated, focused and scanned as in a conventional image orthicon but, on leaving the electron gun, it passes through an additional deflecting field generated by a set of electrodes termed steering plates. A voltage between these plates causes the whole beam to follow a helical path to the target.

At the target, the incident scanning beam divides into three components whose proportions depend on the elemental target charge.

- a) part lands on the target, neutralizing the charge on it
- b) part is specularly reflected with no loss of energy
- c) part is scattered near to or at the surface of the target.

The specularly reflected beam returns, as in an image orthicon, but still following a helical path. On passing again between the steering plates it assumes a larger radius to be intercepted by an annular electrode termed the separator, which is positioned between the steering plates and first dynode.

The scattered electrons, which are proportional in number to the elemental target charge, carry no memory of the helical motion of the forward scanning beam but are symmetrically distributed about the normal to the target. They form a beam which travels back along the magnetic field axis. This beam passes between the steering plates where the deflecting field causes it to follow a helical path with a smaller radius than that of the doubly deflected



specular beam. Almost all of the scattered beam passes through the aperture in the separator electrode and so enters the electron multiplier and is amplified to form the video signal.

This signal is proportional to the light input to the tube, therefore there is virtually no noise associated with the blacks of the picture. It is thus possible to set the scanning beam at a sufficiently high level to discharge very bright highlights of the picture, without loss of detail in the darker parts of the picture due to noise as is the case with the image orthicon.

### Dynamic Range

Let the input light level for the knee of the tube be  $I_K$ .  
 Let the input light level for a just-discernible picture be  $I_L$  (the beam being still set at a level sufficient to discharge the picture corresponding to  $I_K$ ).  
 Then the dynamic range is defined as:

$$\text{dynamic range} = \frac{I_K}{I_L}$$

This ratio is commonly greater than 2000:1 for an isocon whilst an image orthicon will give only of the order of 200:1.

## GENERAL DATA

### Electrical

Cathode . . . . .	indirectly heated, oxide coated
Heater voltage . . . . .	6.3 V
Heater current . . . . .	0.6 A
Inter-electrode capacitance, anode to all other electrodes . . . . .	18 pF max
Focusing method . . . . .	magnetic
Deflection method . . . . .	magnetic
Magnetic fields:	
scanning section field . . . . .	7.0mT (70 gauss) approx
alignment field, adjustable . . . . .	0 to 0.3mT (0 to 3 gauss)

### Mechanical

Overall length . . . . .	25.216 inches (640.5mm) max
Diameter of image section . . . . .	4.594 inches (116.7mm) max
Diameter of scanning section . . . . .	3.185 inches (80.9mm) max
Useful size of square image for standard operation . . . . .	3.25 inches (82.6mm) maximum diagonal at photocathode. Electron image contracted electron optically to a diagonal of 2.4 inches (61mm) approximately at the target.

Continued on page 3



**Mechanical (continued)**

Net weight . . . . .	3 pounds (1.36kg) approx
Mounting position . . . . .	Any except with bidecal base up and with tube axis at an angle less than 20° from the vertical.
End base . . . . .	small shell bidecal 20-pin (JEDEC no. B20-102)
Shoulder base . . . . .	special 5 contact

**MAXIMUM RATINGS AND TYPICAL OPERATING CONDITIONS**

	Min	Max	Typical	
Photocathode voltage (image focus) . . . . .	—	−700	−600	V
Grid 6 voltage (accelerator) . . . . .	—	−700	−475	V
Target voltage . . . . .	—	±10		V
Target voltage above cut-off . . . . .			+3	V
Field mesh with respect to grid 4 voltage . . . . .	+5	+20	15 to 20	V
Grid 5 voltage (decelerator) . . . . .	—	300	−100 to +250	V
Grid 4 voltage (beam focus) . . . . .	—	350	100 to 220	V
Steering plate voltage with respect to G4 . . . . .	—	+70	0 ± 70	V
Separator voltage . . . . .	—	250	20 to 150	V
Grid 3 voltage (multiplier focus) . . . . .	—	400	215 to 350	V
Intermediate grid 2 (G2A) voltage . . . . .	—	350	0 to 250	V
Grid 2 and dynode 1 voltage . . . . .	—	350	300	V
Grid 1 voltage (negative value, never positive) . . . . .			4 to 115	V
Anode supply voltage . . . . .	—	2000	1800	V
Voltage per multiplier stage . . . . .	—	350		V
Dynode 2 voltage . . . . .			600	V
Dynode 3 voltage . . . . .			800	V
Dynode 4 voltage . . . . .			1050	V
Dynode 5 voltage . . . . .			1250	V
Dynode 6 voltage . . . . .			1500	V
Dynode 7 voltage . . . . .			1750	V
Signal current . . . . .			less than 10	μA



## TYPICAL PERFORMANCE

### Resolution

see graph, page 6

Illumination on Faceplate (foot-candles)	Signal to Noise Ratio (db)	
	picture whites	picture blacks
$1 \times 10^{-4}$	30	50
$1 \times 10^{-5}$	25	35
$1 \times 10^{-6}$	16	20

## SETTING-UP PROCEDURE

- a) Initially the tube is set up to operate as an image orthicon, with the steering plate and separator voltages adjusted to grid 4 potential (140V approx) and the intermediate grid 2 electrode at 80V approx.
- b) Transfer to isocon operation is achieved by setting the separator voltage to 80V approx and then adjusting one or more steering plate voltages until a negative picture is obtained; this is the isocon picture. It may be necessary to adjust grid 4 voltage to achieve the transition.
- c) Adjust the intermediate grid 2 voltage for minimum noise, consistent with maximum signal output.
- d) Further adjustments are then made to the steering plate voltages and the beam alignment controls for most uniform shading, and to the grid 4, separator and intermediate grid 2 voltages for best resolution consistent with minimum noise.

# TYPICAL SPECTRAL SENSITIVITY CHARACTERISTIC

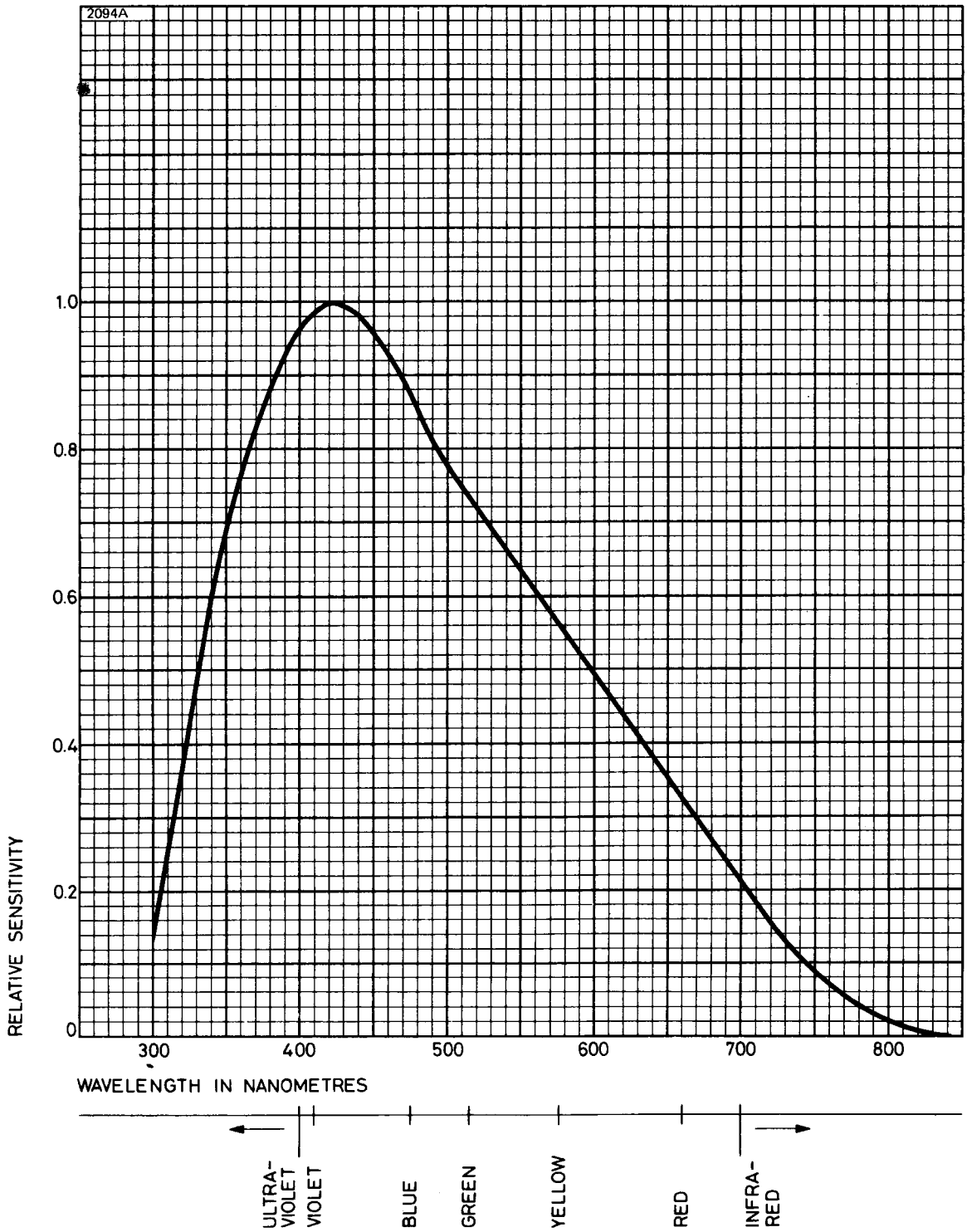

# TYPICAL RESOLUTION

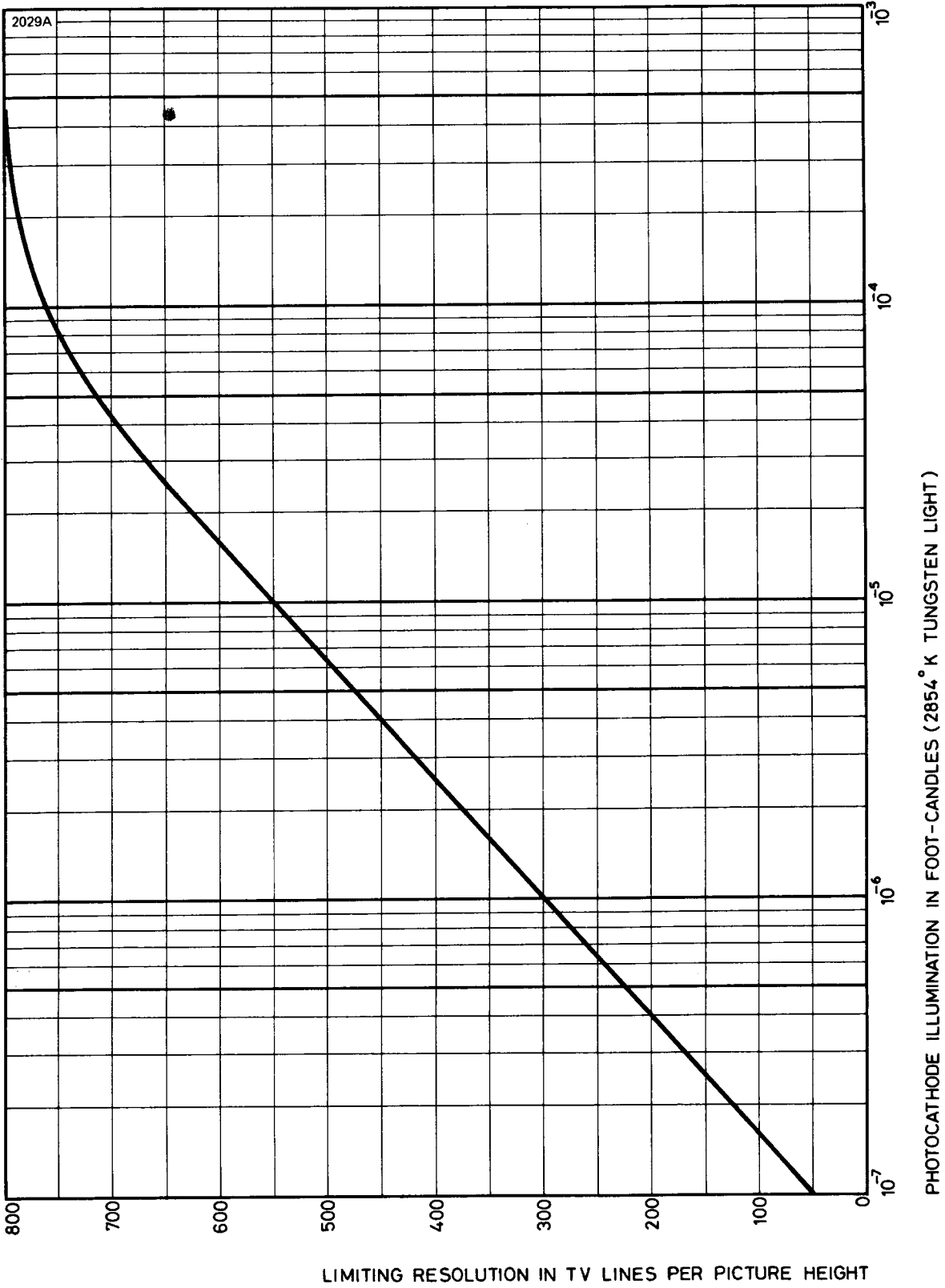

**OUTLINE (All dimensions without limits are nominal)**

2028

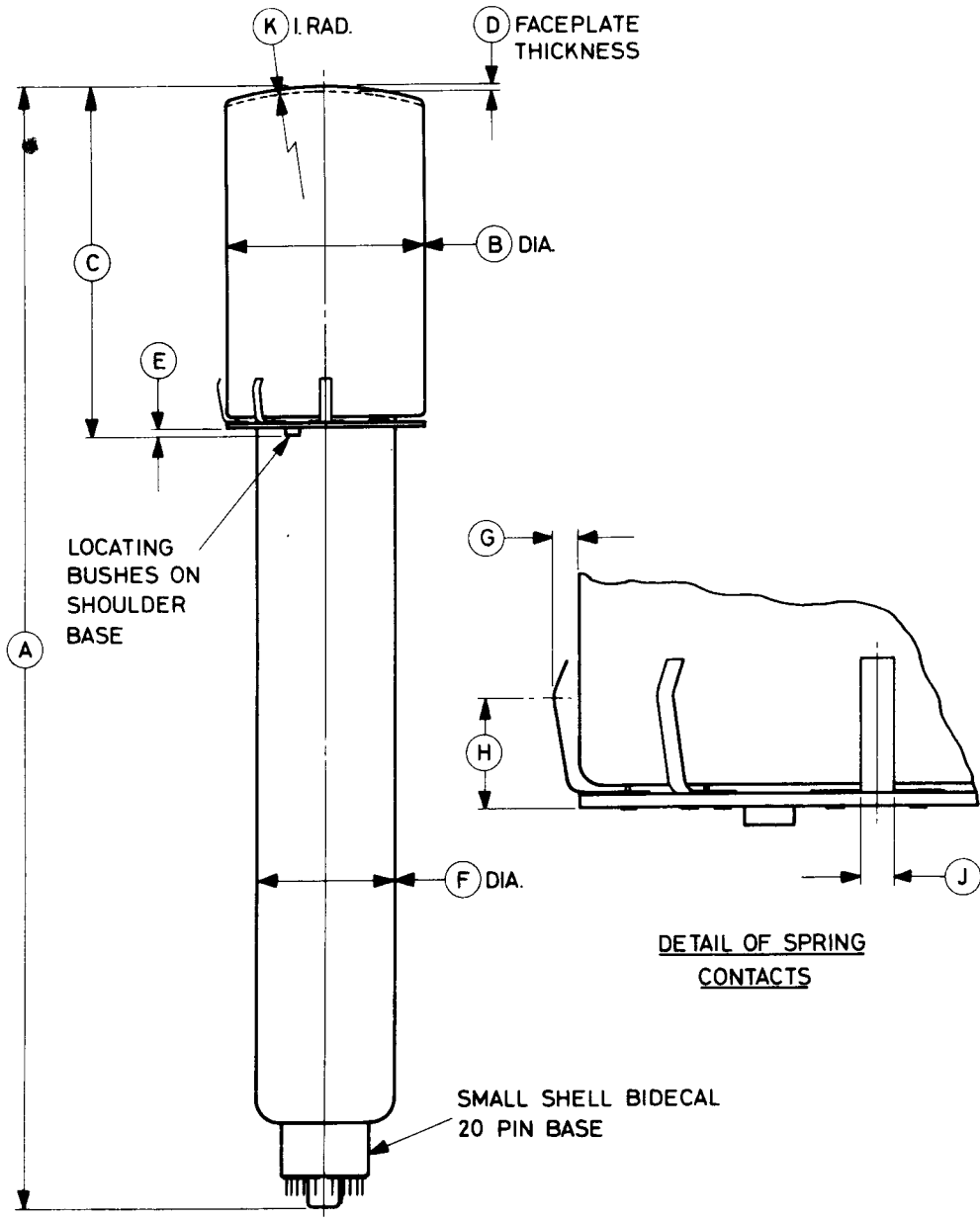

Ref	Inches	Millimetres	Ref	Inches	Millimetres
A	25.009 max	635.2 max	F	3.150 max	80.01 max
B	4.500 ± 0.094	114.3 ± 2.4	G	0.175 min	4.45 min
C	7.821 ± 0.077	198.7 ± 1.96	H	0.800	20.32
D	0.098	2.49	J	0.250	6.35
E	0.175 max	4.45 max	K	7.874	200.0

Millimetre dimensions have been derived from inches.

# OUTLINE DETAIL

2030

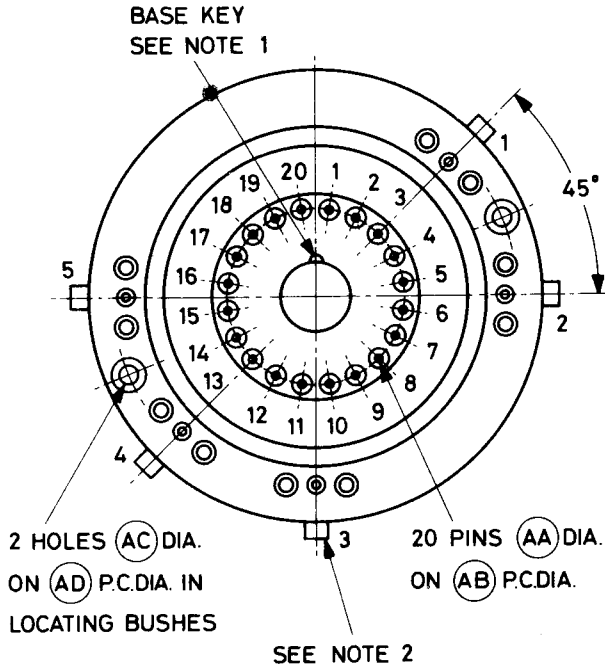

Ref	Inches	Millimetres
AA	0.093 ± 0.002	2.362 ± 0.051
AB	1.750 ± 0.002	44.450 ± 0.051
AC	0.204	5.18
AD	4.000 ± 0.005	101.60 ± 0.13

Millimetre dimensions have been derived from inches.

### NOTES

1. The plane through the axis of the tube and the base key is coincident with the plane through shoulder base contact 3 and the axis of the tube to within 10°.
2. The faceplate has an index mark in line with shoulder base contact 3.

### 20-Pin Base Connections

Pin	Element
1	Heater
2	Intermediate grid 2 (G <sub>2A</sub> )
3	Grid 4
4	Grid 3
5	Steering plate B
6	Separator
7	Dynode 2
8	Dynode 4
9	Anode
10	Steering plate C
11	Dynode 5
12	Dynode 7
13	Dynode 3
14	Dynode 1, grid 2
15	Internal connection
16	Steering plate D
17	Grid 1
18	Dynode 6
19	Cathode
20	Heater

### Shoulder Base Connections

Contact	Element
1	Field mesh
2	Photocathode
3	Grid 6
4	Grid 5
5	Target

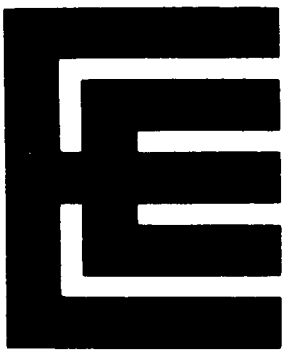

### INTRODUCTION

The P880 is a 3-inch image isocon designed for television pick-up at very low light levels. It has a low capacitance target and is able to produce useful pictures with a photocathode illumination in the region of  $10^{-5}$  foot-candles. With a fixed beam current it will reproduce scenes having a wide dynamic range, giving pictures of good tonal quality and without the excess beam noise associated with image orthicons.

The tube is externally similar to conventional 3-inch image orthicons and the circuits of most image orthicon cameras can readily be modified to accept it, the extent and precise nature of the modifications will depend on the original design.

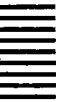

## **PRINCIPLES OF OPERATION**

### **The Image Section**

The image section and target operate as in an image orthicon to produce a charge pattern on the scanned side of the target.

### **The Scanning Beam**

The scanning beam is generated, focused and scanned as in a conventional image orthicon but, on leaving the electron gun, it passes through an additional deflecting field generated by a set of electrodes termed steering plates. A voltage between these plates causes the whole beam to follow a helical path to the target.

At the target, the incident scanning beam divides into three components whose proportions depend on the elemental target charge.

- a) part lands on the target, neutralizing the charge on it
- b) part is specularly reflected with no loss of energy
- c) part is scattered near to or at the surface of the target.

The specularly reflected beam returns, as in an image orthicon, but still following a helical path. On passing again between the steering plates it assumes a larger radius to be intercepted by an annular electrode termed the separator, which is positioned between the steering plates and first dynode.

The scattered electrons, which are proportional in number to the elemental target charge, carry no memory of the helical motion of the forward scanning beam but are symmetrically distributed about the normal to the target. They form a beam which travels back along the magnetic field axis. This beam passes between the steering plates where the deflecting field causes it to follow a helical path with a smaller radius than that of the doubly deflected specular beam. Almost all of the scattered beam passes through the aperture in the separator electrode and so enters the electron multiplier and is amplified to form the video signal.

This signal is proportional to the light input to the tube, therefore there is virtually no noise associated with the blacks of the picture. It is thus possible to set the scanning beam at a sufficiently high level to discharge very bright highlights of the picture, without loss of detail in the darker parts of the picture due to noise as is the case with the image orthicon.



## GENERAL DATA

### Electrical

Cathode . . . . .	indirectly heated, oxide coated	
Heater voltage . . . . .	6.3	V
Heater current . . . . .	0.6	A
Inter-electrode capacitance, anode to all other electrodes . . . . .	15	pF max
Focusing method . . . . .		magnetic
Deflection method . . . . .		magnetic
Alignment method . . . . .		magnetic
Focusing field . . . . .	7.5mT (75 gauss) approx	
Alignment field, adjustable . . . . .	0 to 0.3mT (0 to 3 gauss)	

### Mechanical

Overall length . . . . .	15.450 inches (392.4mm) max
Diameter of image section . . . . .	3.060 inches (77.8mm) max
Diameter of scanning section . . . . .	2.060 inches (52.4mm) max
Useful size of rectangular image, aspect ratio 4:3, for standard operation . . . . .	1.6 inches (40.6mm) diagonal at photocathode. Electron image is contracted electron optically (using the above format) to a diagonal of 1.4 inches (35.6mm) approximately at the target. A circular format of 1.6 inches diameter at the photocathode can be used in order to exploit the entire area of the target.
Maximum useful area of photocathode . . . . .	diagonal 1.8 inches (45.7mm). Under this condition some of the target structure will be visible in the corners of the picture
Net weight . . . . .	17 ounces (480g) approx
Mounting position . . . . .	any except with bidecal base up and with tube axis at an angle less than 20° from vertical.
End base . . . . .	small shell bidecal 20-pin (JEDEC no. B20-102)
Shoulder base . . . . .	keyed jumbo annular 7-pin



## Storage

Recommended store temperature . . . . . 15 to 35 °C

Tubes should be stored in darkness. All tubes must be operated for at least 5 hours each month; this is one of the conditions of warranty.

## MAXIMUM RATINGS AND TYPICAL OPERATING CONDITIONS

	Max	Typical	
Photocathode voltage (image focus) . . . . .	-700	-400	V
Grid 6 voltage (accelerator) . . . . .	-700	-300	V
Target voltage . . . . .	±10	+3.0	V
Grid 5 voltage (decelerator) . . . . .	200	0 to +125	V
Grid 4 voltage (beam focus) and field mesh . . . . .	350	140 to 280	V
Steering plate voltage with respect to grid 4 (plates B, C and D) . . . . .	+70	0 ± 70	V
Separator voltage . . . . .	250	20 to 180	V
Grid 3 voltage (multiplier focus) . . . . .	400	215 to 350	V
Intermediate grid 2 (G <sub>2A</sub> ) voltage . . . . .	350	0 to 250	V
Grid 2 and dynode 1 voltage . . . . .	350	300	V
Grid 1 voltage (negative value, never positive) . . . . .		4 to 115	V
Anode supply voltage . . . . .	2000	1800	V
Voltage per multiplier stage . . . . .	350		V
Dynode 2 voltage . . . . .		600	V
Dynode 3 voltage . . . . .		800	V
Dynode 4 voltage . . . . .		1050	V
Dynode 5 voltage . . . . .		1250	V
Dynode 6 voltage . . . . .		1500	V
Dynode 7 voltage . . . . .		1750	V

## SETTING-UP PROCEDURE

The setting-up process is simplified if the tube is made to operate as an image orthicon and then the additional potentials applied to convert to the isocon mode of operation. In an equipment arranged to give positive picture polarity with isocon scanning, the orthicon picture will be of negative polarity.

Before applying the specified voltages (shown under Typical Operating

Conditions) to the tube, provision for a nominal faceplate illumination of approximately  $10^{-3}$  ft-candles should be made.

1. Set the electrode potentials as follows:

- G4 to 200V\*
- Steering plates B, C and D to G4 potential
- G2A to 60V
- Separator to G4 potential

2. To obtain Orthicon picture

- 2.1 Reduce bias on grid 1 until video information appears on monitor.
- 2.2 Adjust alignment controls to give optimum orthicon picture, i.e. maximum output consistent with best uniformity. Target voltage is set 2 to 3V above cut off.
- 2.3 Adjust G3 for maximum output.
- 2.4 Adjust G2A for best resolution.
- 2.5 Adjust photocathode and G6 for optimum centre to corner resolution and minimum 'S' distortion.
- 2.6 Adjust G5 for least corner shading consistent with good overall geometry.

3. To obtain Isocon picture (see notes 1 and 2)

- 3.1 Adjust separator voltage to 50V.
- 3.2 Re-adjust potentials on steering plates B and D to obtain most uniform isocon picture which will now be of positive polarity (see note 3).
- 3.3 Re-check the target cut off voltage and reset the target 2 to 3V above cut off.
- 3.4 Re-adjust separator voltage for best resolution consistent with absence of any orthicon component.
- 3.5 Re-adjust G2A for minimum noise and best resolution.
- 3.6 Re-check alignment controls for optimum picture quality, in particular maximum output consistent with minimum shading.

\* This is the value required in the Marconi Mk 4 yoke. For other yokes the voltage may differ slightly but will generally be in the range 190 to 210V.

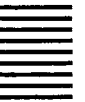

## NOTES

1. Whilst making adjustments to obtain Isocon picture, it is beneficial to either cap the lens or electronically cap the photocathode periodically to ensure that there is no orthicon component present. Ideally under 'capped' photocathode condition the black shading should be flat and noise at a minimum.

Redistribution effects caused by over exposure may be interpreted as incorrect orthicon/isocon transition. Reduce exposure to the knee of the light transfer characteristic.

2. If during the initial adjustment the picture disappears completely, this is due to the target assuming a high potential condition. To overcome this reduce the beam current and momentarily flood the photocathode with a highlight.

3. A simplified method of obtaining the optimum voltages on plates B and D is to adopt an arrangement where the single control of a tandem potentiometer will give equal and opposite potentials on the plates, e.g. steering plate B at +20V and steering plate D at -20V with respect to G4.

There are two combinations of the potentials applied to plates B and D where the transition from orthicon to isocon operation is apparent; the combination giving higher output and better uniformity should be used. A slight adjustment of steering plate C may further improve the overall isocon picture.

## CONVERSION OF 3-INCH IMAGE ORTHICON CAMERAS TO P880

### Yoke

The existing yoke should not require any modification.

### Separator

A voltage supply is required for the separator, variable from +20 to +180V relative to the cathode.

### Intermediate Grid 2

A voltage supply is required for the intermediate grid 2 ( $G_{2A}$ ), variable from 0 to +250V relative to the cathode.

The voltage supplies for the separator and  $G_{2A}$  can both be obtained from the existing  $G_2$  supply using  $250k\Omega$  potentiometers.

## Steering Plates

Voltage supplies are required for the three steering plates, independently variable from  $-70$  to  $+70$ V relative to grid 4. In most cameras these voltages can be derived from the existing  $G_4$  supply (see below).

## Anode\*

The anode supply voltage should be increased from 1250 to 1800V with two additional tapping points for dynodes 6 and 7 at approximately 1500 and 1750V.

## Connections

A twenty pin socket, Alden type 220FT C20-36, is required in the camera in place of the standard fourteen pin type. The seven pin socket for the shoulder connections does not require any modification.

## Video Amplifier

Phase inversion of the video signal is required and in most camera channels extra gain will be needed for operation at low light levels. An additional amplifier with a voltage gain of 10 to 100 may be required.



## Suggested Circuit for Steering Plate Supplies

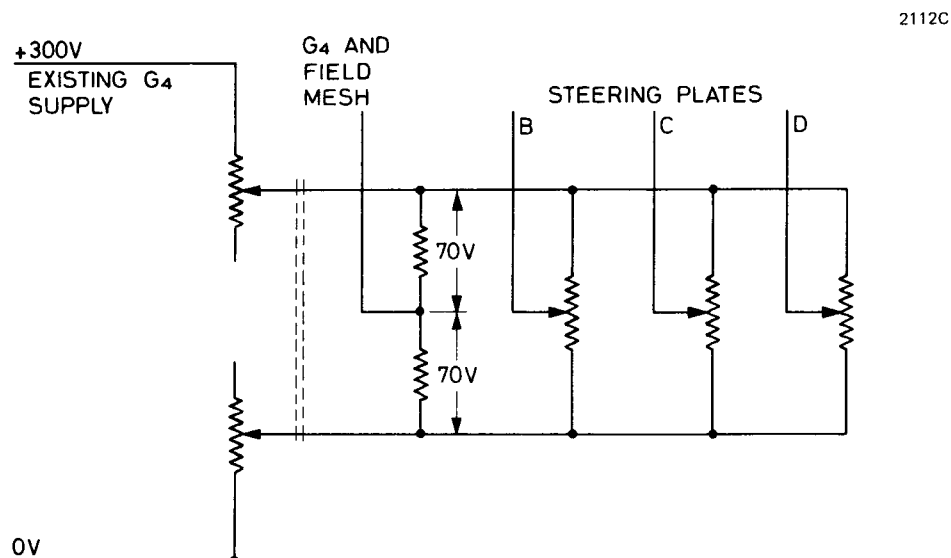

# TYPICAL SPECTRAL SENSITIVITY CHARACTERISTIC

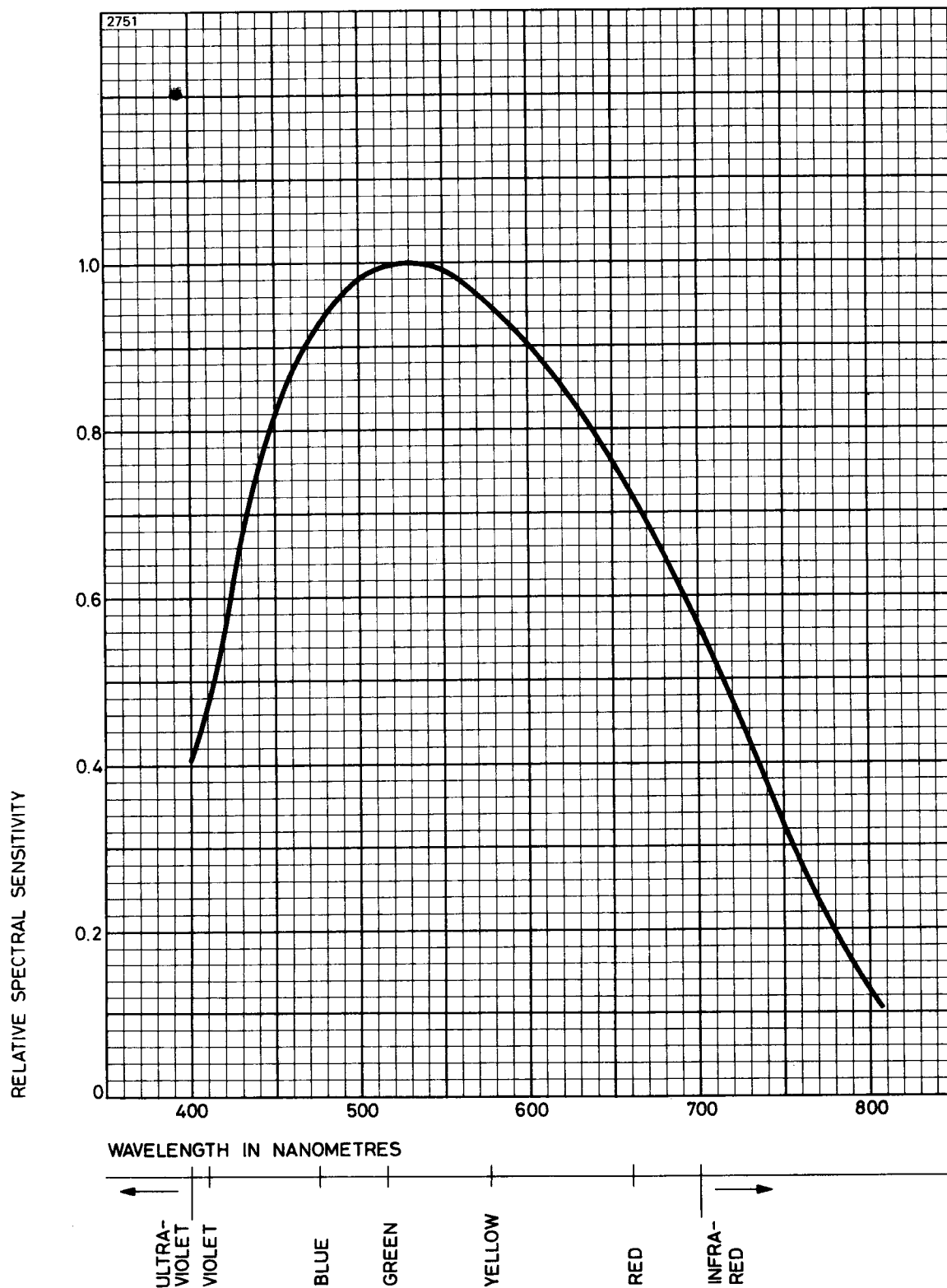

# TYPICAL RESOLUTION

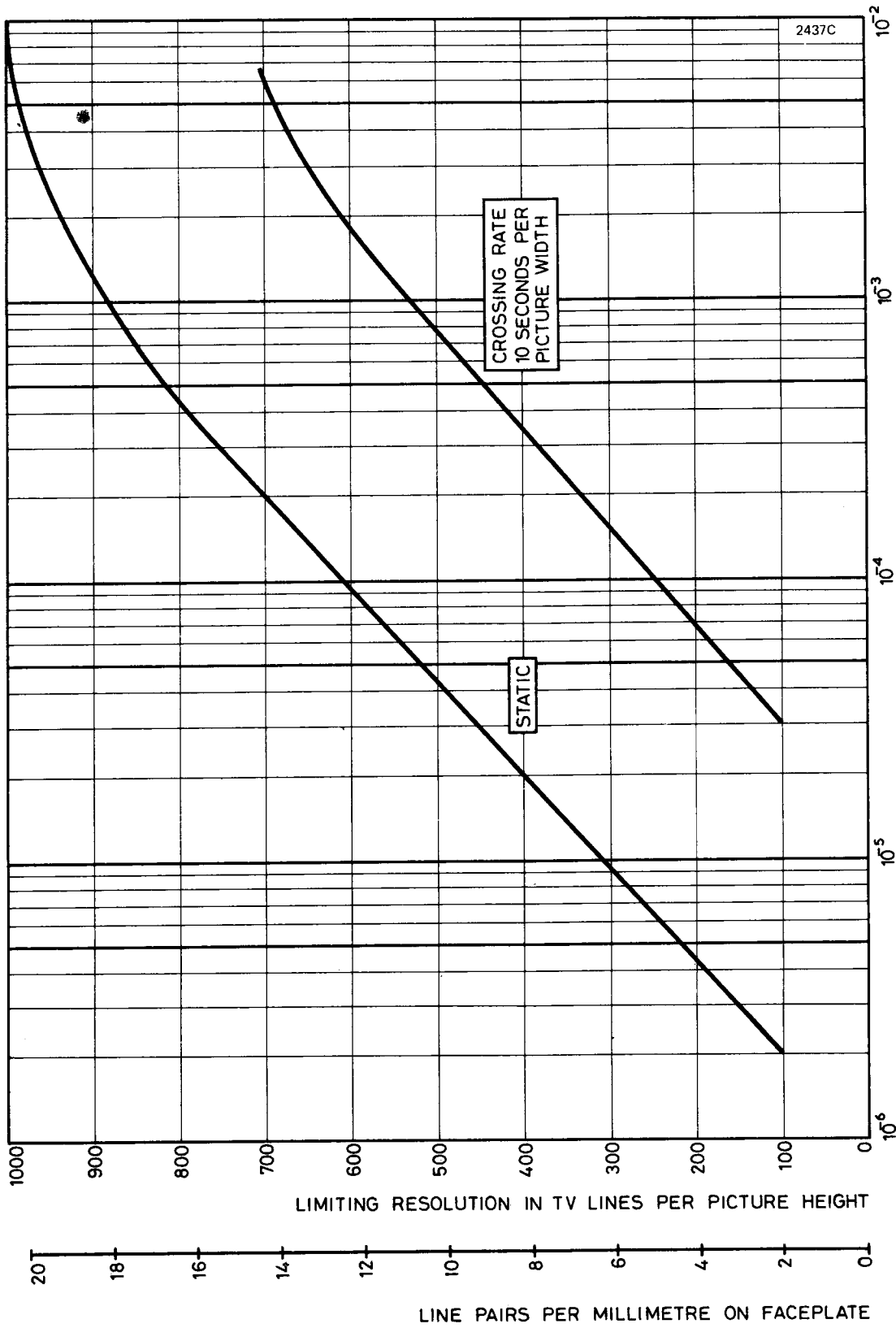

PHOTOCATHODE ILLUMINATION IN FOOT-CANDLES (2854° K TUNGSTEN LIGHT)



# TYPICAL SIGNAL TO NOISE RATIO

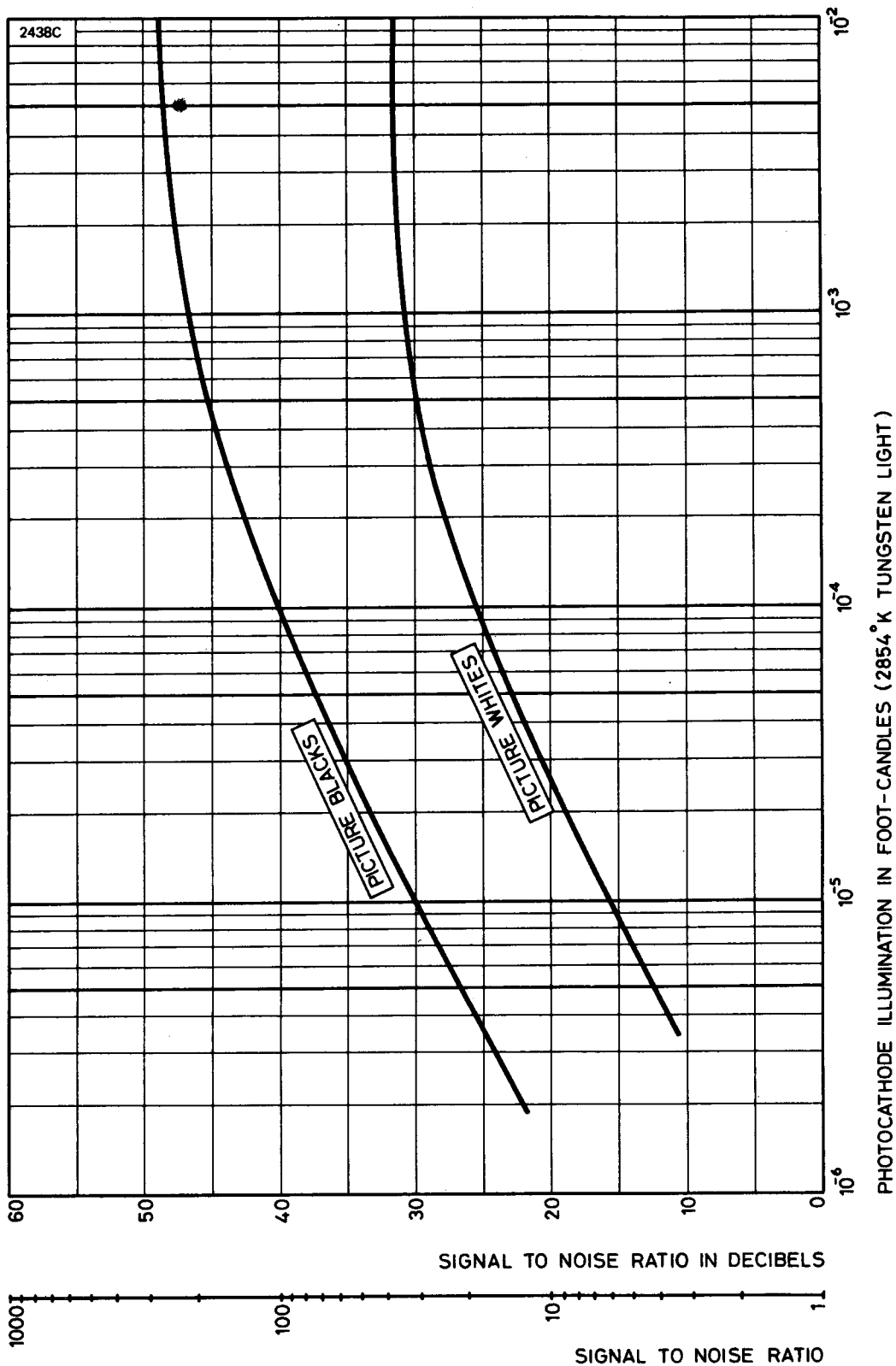



# TYPICAL LAG

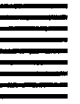
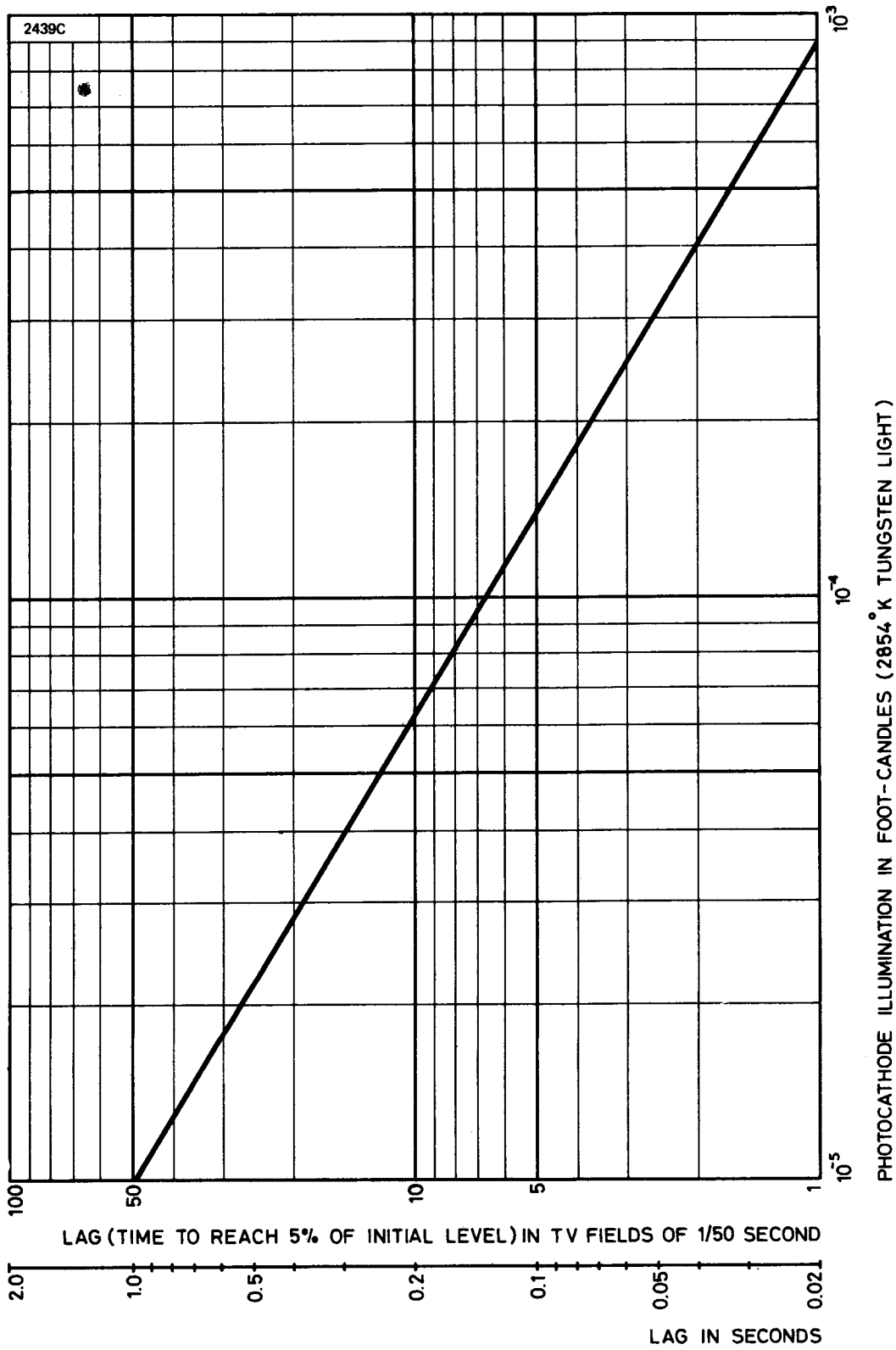

# TYPICAL SIGNAL CURRENT

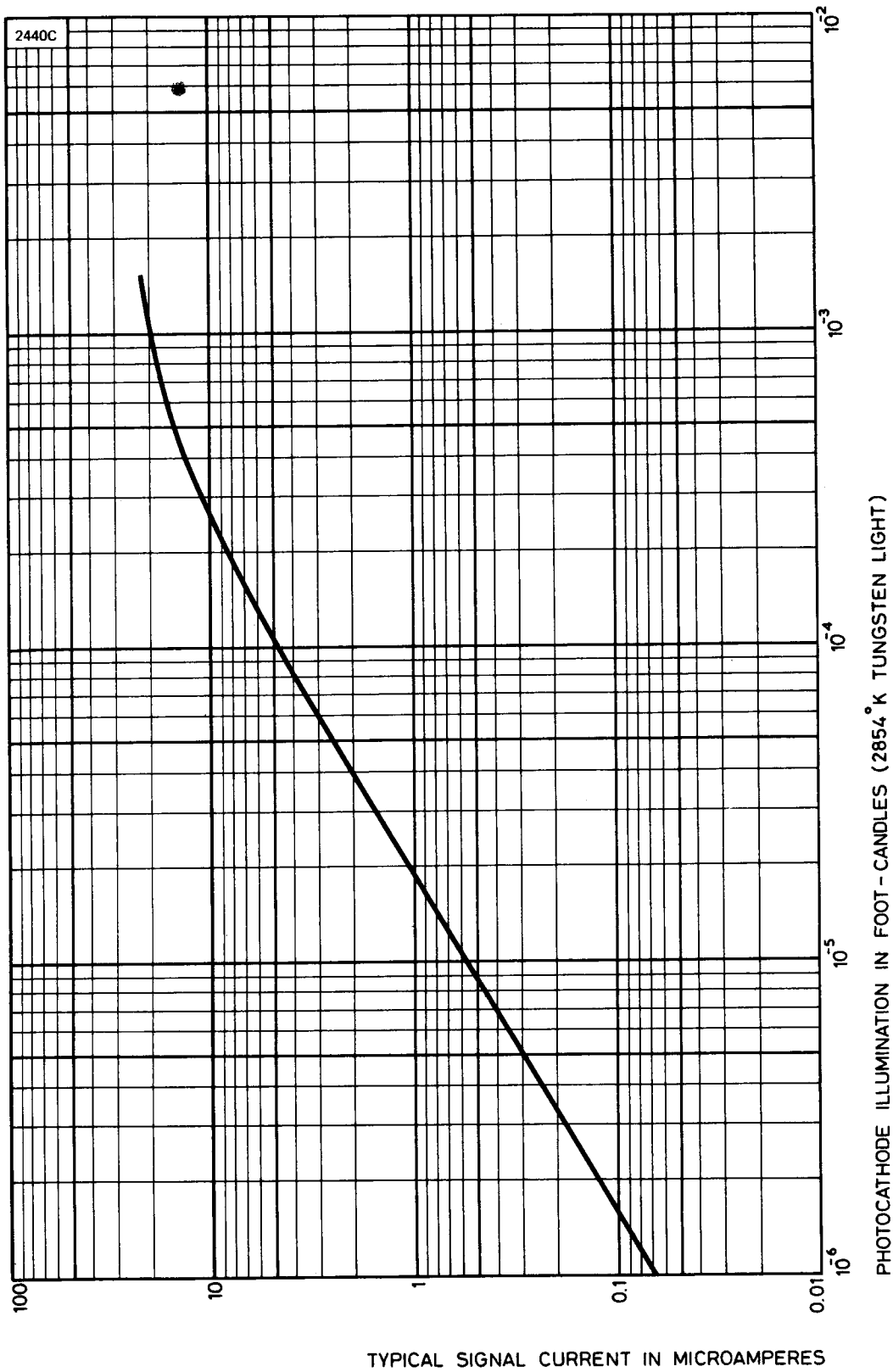

# OUTLINE

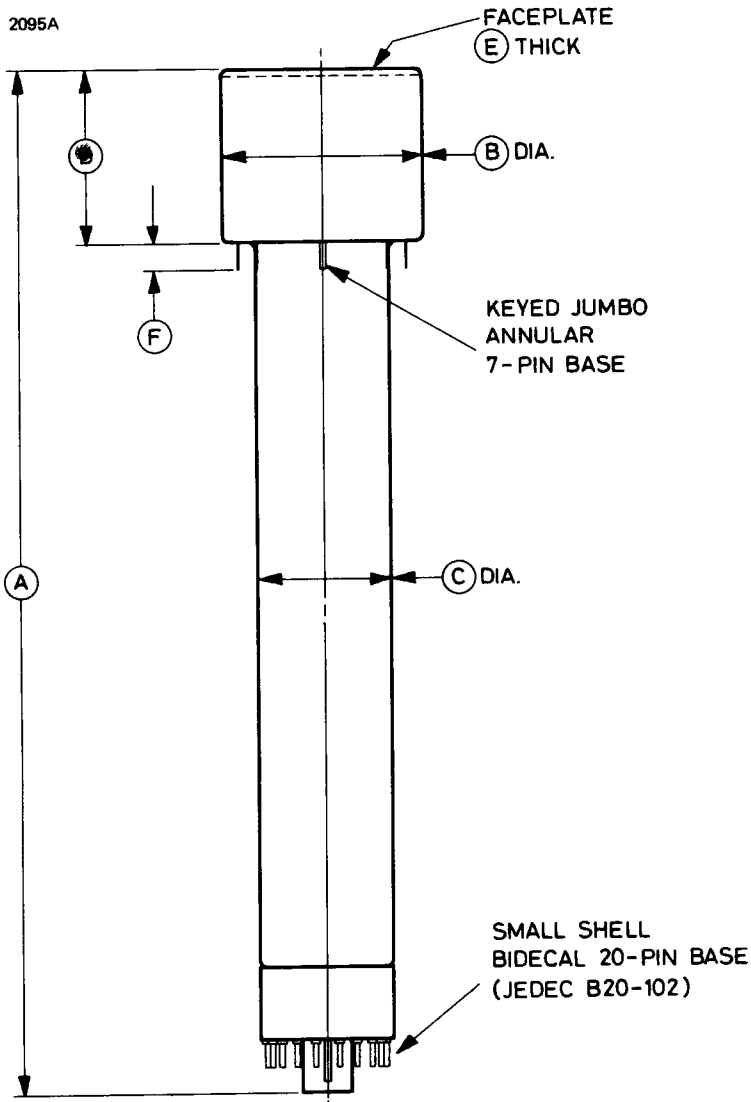

Ref	Inches	Millimetres
A	15.200 ± 0.250	386.1 ± 6.4
B	3.060 max	77.72 max
C	2.000 ± 0.060	50.80 ± 1.52
D	2.560 ± 0.120	65.02 ± 3.05
E	0.135 <sup>+0.015</sup> <sub>-0.025</sub>	3.43 <sup>+0.38</sup> <sub>-0.64</sub>
F	0.425 ± 0.025	10.80 ± 0.64

Millimetre dimensions have been derived from inches.

# OUTLINE DETAIL

2096A

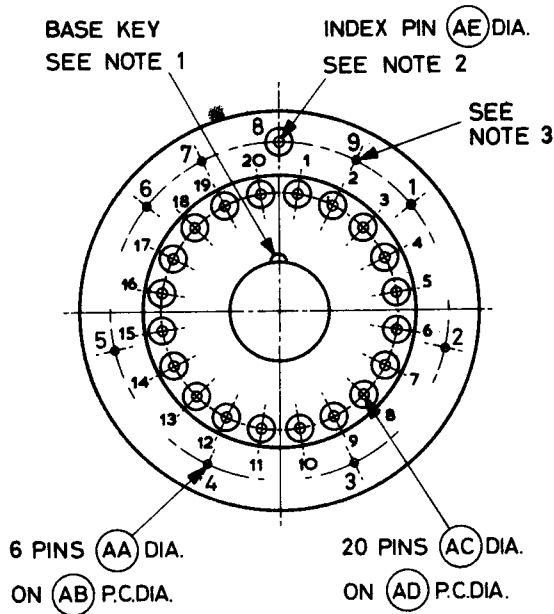

Ref	Inches	Millimetres
AA	0.040 ± 0.002	1.016 ± 0.051
AB	2.500 ± 0.015	63.50 ± 0.38
AC	0.093 ± 0.002	2.362 ± 0.051
AD	1.750 ± 0.002	44.450 ± 0.051
AE	0.093 ± 0.003	2.362 ± 0.076

Millimetre dimensions have been derived from inches.

## NOTES

1. The plane through the axis of the tube and the base key is coincident with the plane through the index pin of the 7 pin base and the axis of the tube to within 10°.
2. The faceplate has an index mark in line with index pin 8.
3. Maximum length of pins 7 and 9 is 0.040 inch (1.02mm).

## 7-Pin Annular Base Connections

Pin	Element
1	Grid 6
2	Photocathode
3	Internal connection. Do not use
4	Internal connection. Do not use
5	Grid 5
6	Target
7	Internal connection. Do not use
8	Internal connection. Do not use
9	Internal connection. Do not use

## 20-Pin Base Connections

Pin	Element
1	Heater
2	Intermediate grid 2 (G <sub>2A</sub> )
3	Grid 4 and field mesh
4	Grid 3
5	Steering plate B
6	Separator
7	Dynode 2
8	Dynode 4
9	Anode
10	Steering plate C
11	Dynode 5
12	Dynode 7
13	Dynode 3
14	Dynode 1, grid 2
15	Internal connection
16	Steering plate D
17	Grid 1
18	Dynode 6
19	Cathode
20	Heater

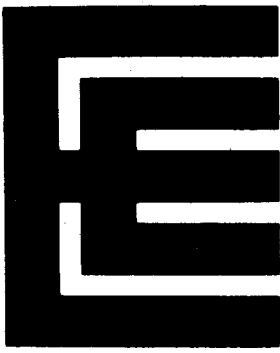

# P887

## FIBRE-OPTIC IMAGE ISOCON

### INTRODUCTION

The P887 is a 3-inch image isocon with a low capacitance target and fibre-optic faceplate, suitable for direct coupling to an image intensifier for very low light level television pick-up. It can also be used with other devices having suitable fibre-optic output, or it can be used by itself, when it is able to give useful pictures with a photocathode illumination in the region of  $10^{-5}$  ft-candles. With a fixed beam current it will reproduce scenes having a wide dynamic range, giving pictures of good tonal quality and without the excess beam noise associated with image orthicons. The photocathode is processed to give maximum efficiency of coupling to an intensifier with a P20 output phosphor.

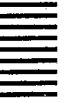

The tube is externally similar to conventional 3-inch image orthicons and can be operated in most image orthicon cameras without major modifications to the yoke or circuits.

November 1972

## PRINCIPLES OF OPERATION

### The Image Section

The image section and target operate as in an image orthicon to produce a charge pattern on the scanned side of the target.

### The Scanning Beam

The scanning beam is generated, focused and scanned as in a conventional image orthicon but, on leaving the electron gun, it passes through an additional deflecting field generated by a set of electrodes termed steering plates. A voltage between these plates causes the whole beam to follow a helical path to the target.

At the target, the incident scanning beam divides into three components whose proportions depend on the elemental target charge.

- a) part lands on the target, neutralizing the charge on it
- b) part is specularly reflected with no loss of energy
- c) part is scattered near to or at the surface of the target.

The specularly reflected beam returns, as in an image orthicon, but still following a helical path. On passing again between the steering plates it assumes a larger radius to be intercepted by an annular electrode termed the separator, which is positioned between the steering plates and first dynode.

The scattered electrons, which are proportional in number to the elemental target charge, carry no memory of the helical motion of the forward scanning beam but are symmetrically distributed about the normal to the target. They form a beam which travels back along the magnetic field axis. This beam passes between the steering plates where the deflecting field causes it to follow a helical path with a smaller radius than that of the doubly deflected specular beam. Almost all of the scattered beam passes through the aperture in the separator electrode and so enters the electron multiplier and is amplified to form the video signal.

This signal is proportional to the light input to the tube, therefore there is virtually no noise associated with the blacks of the picture. It is thus possible to set the scanning beam at a sufficiently high level to discharge very bright highlights of the picture, without loss of detail in the darker parts of the picture due to noise as is the case with the image orthicon.

## GENERAL DATA

### Electrical

Cathode . . . . .	indirectly heated, oxide coated	
Heater voltage . . . . .	6.3	V
Heater current . . . . .	0.6	A
Inter-electrode capacitance, anode to all other electrodes . . . . .	15	pF max
Focusing method . . . . .		magnetic
Deflection method . . . . .		magnetic
Alignment method . . . . .		magnetic

### Mechanical

Overall length . . . . .	15.590 inches (396mm) max
Diameter of image section . . . . .	3.060 inches (77.72mm) max
Diameter of scanning section . . . . .	2.060 inches (52.4mm) max
Useful size of image . . . . .	maximum diagonal 40mm
Net weight . . . . .	1¼ pounds (560g) approx
Mounting position . . . . .	Any except with bidecal base up and with tube axis at an angle less than 20° from vertical.
End base . . . . .	small shell bidecal 20-pin (JEDEC no. B20-102)
Shoulder base . . . . .	keyed jumbo annular 7-pin

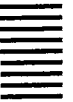

## MAXIMUM RATINGS AND TYPICAL OPERATING CONDITIONS

	Max	Typical	
Photocathode voltage (image focus) . . . . .	-700	-400	V
Grid 6 voltage (accelerator) . . . . .	-700	-300	V
Target voltage . . . . .	$\pm 10$	+3.0	V
Grid 5 voltage (decelerator) . . . . .	200	0 to +125	V
Grid 4 voltage (beam focus) and field mesh . . . . .	350	140 to 280	V
Steering plate voltage with respect to grid 4 (plates B, C and D) . . . . .	+70	$0 \pm 70$	V
Separator voltage . . . . .	250	20 to 180	V
Grid 3 voltage (multiplier focus) . . . . .	400	215 to 350	V
Intermediate grid 2 (G <sub>2A</sub> ) voltage . . . . .	350	0 to 250	V
Grid 2 and dynode 1 voltage . . . . .	350	300	V
Grid 1 voltage (negative value, never positive) . . . . .		4 to 115	V
Anode supply voltage . . . . .	2000	1800	V
Voltage per multiplier stage . . . . .	350		V
Dynode 2 voltage . . . . .		600	V
Dynode 3 voltage . . . . .		800	V
Dynode 4 voltage . . . . .		1050	V
Dynode 5 voltage . . . . .		1250	V
Dynode 6 voltage . . . . .		1500	V
Dynode 7 voltage . . . . .		1750	V
Signal current . . . . .		10	$\mu A$



# OUTLINE

2634A

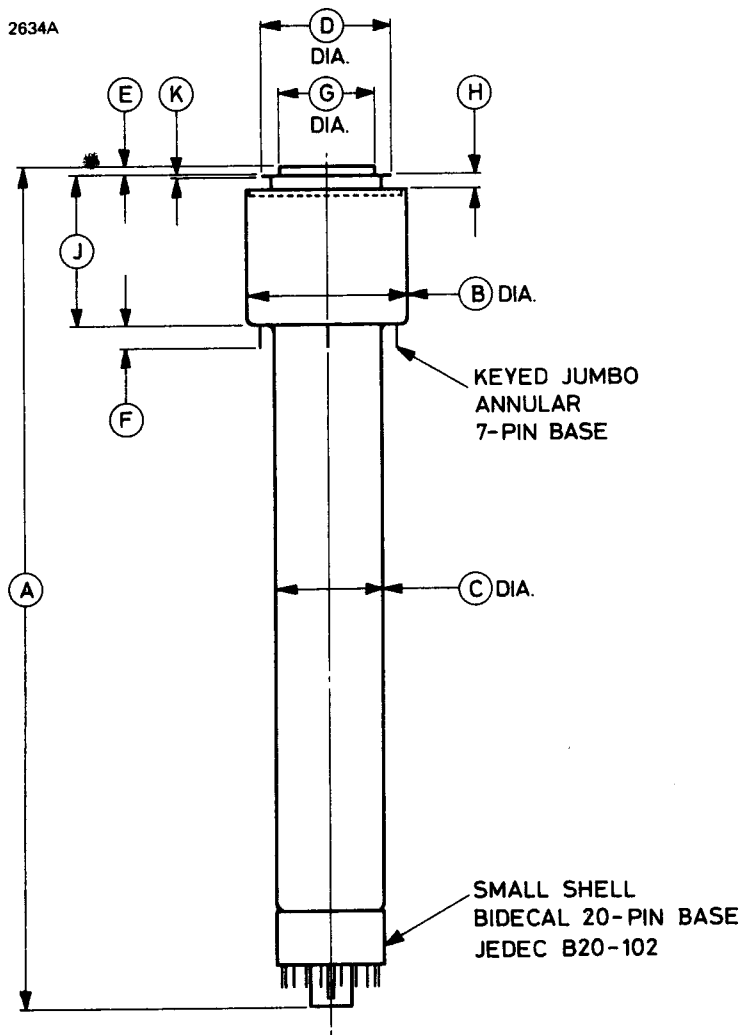

Ref	Inches	Millimetres
A	15.340 ± 0.250	389.6 ± 6.4
B	3.060 max	77.72 max
C	2.000 ± 0.060	50.80 ± 1.52
D	2.362 ± 0.016	60.00 ± 0.41
E	0.138 max	3.51 max
F	0.425 ± 0.025	10.80 ± 0.64
G	1.772 ± 0.016	45.009 ± 0.41
H	0.260 ± 0.016	6.60 ± 0.41
J	2.575 ± 0.120	65.41 ± 3.05
K	0.039 ± 0.012	0.99 ± 0.30

Millimetre dimensions have been derived from inches.

# OUTLINE DETAIL

2771A

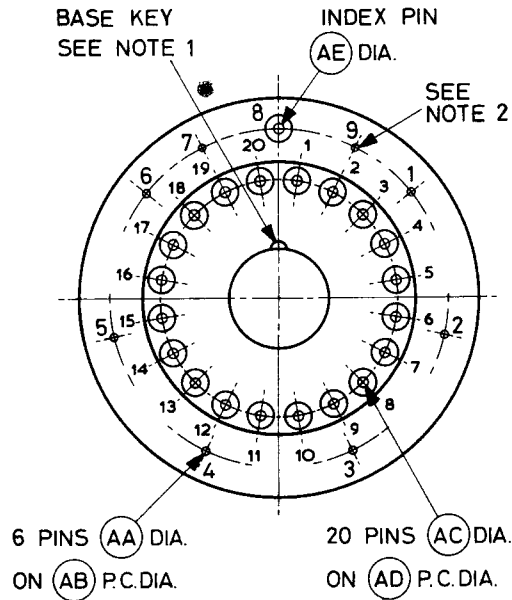

## 20-Pin Base Connections

Pin	Element
1	Heater
2	Intermediate grid 2 (G <sub>2A</sub> )
3	Grid 4 and field mesh
4	Grid 3
5	Steering plate B
6	Separator
7	Dynode 2
8	Dynode 4
9	Anode
10	Steering plate C
11	Dynode 5
12	Dynode 7
13	Dynode 3
14	Dynode 1, grid 2
15	Internal connection
16	Steering plate D
17	Grid 1
18	Dynode 6
19	Cathode
20	Heater

Ref	Inches	Millimetres
AA	0.040 ± 0.002	1.016 ± 0.051
AB	2.500 ± 0.015	63.50 ± 0.38
AC	0.093 ± 0.002	2.362 ± 0.051
AD	1.750 ± 0.002	44.450 ± 0.051
AE	0.093 ± 0.003	2.362 ± 0.076

Millimetre dimensions have been derived from inches.

## NOTES

- The plane through the axis of the tube and the base key is coincident with the plane through the index pin of the 7 pin base and the axis of the tube to within 10°
- Maximum length of pins 7 and 9 is 0.040 inch (1.02mm).

## 7-Pin Annular Base Connections

Pin	Element
1	Grid 6
2	Photocathode
3	Internal connection. Do not use
4	Internal connection. Do not use
5	Grid 5
6	Target
7	Internal connection. Do not use
8	Internal connection. Do not use
9	Internal connection. Do not use



# P8040 P8041

## IMAGE ISOCONS

---

### INTRODUCTION

The P8040 and P8041 are 55mm image isocons designed for television pick-up at very low light levels. The P8040 has a plain glass faceplate, while the P8041 has a fibre-optic faceplate suitable for direct coupling to an image intensifier; the two types are otherwise identical. Each has a low capacitance target and will produce useful pictures with a photocathode illumination in the region of  $10^{-5}$  foot-candles, corresponding to a scene brightness of about  $5 \times 10^{-5}$  foot-lamberts at f/1. With a fixed beam current the isocon will reproduce scenes having a wide dynamic range, giving pictures of good tonal quality and without the excess beam noise associated with image orthicons.

The tubes are particularly suitable for applications requiring high performance from a small camera. They can be supplied encapsulated in a focus and deflection yoke for optimum performance and ruggedness (see page 7).

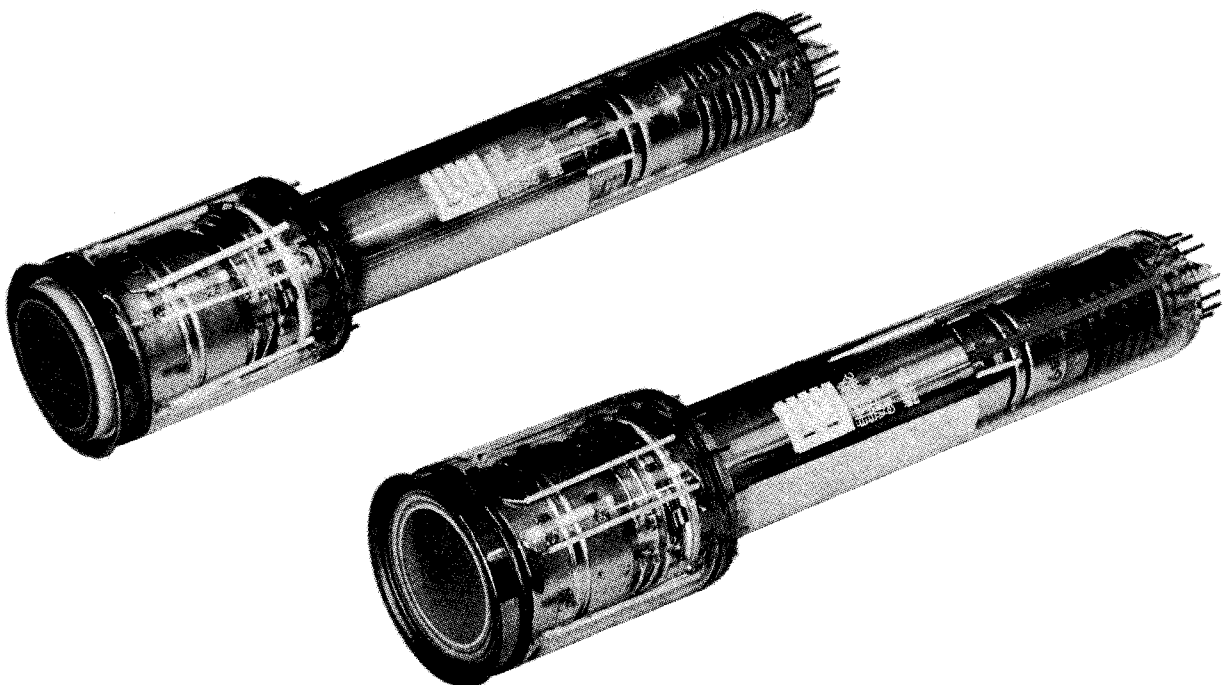
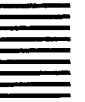

P8041 with fibre-optic faceplate, shown above a P8040

## **PRINCIPLES OF OPERATION**

### **The Image Section**

The image section and target operate as in an image orthicon to produce a charge pattern on the scanned side of the target.

### **The Scanning Beam**

The scanning beam is generated, focused and scanned as in a conventional image orthicon but, on leaving the electron gun, it passes through an additional deflecting field generated by a set of electrodes termed steering plates. A voltage between these plates causes the whole beam to follow a helical path to the target.

At the target, the incident scanning beam divides into three components whose proportions depend on the elemental target charge.

- a) part lands on the target, neutralizing the charge on it
- b) part is specularly reflected with no loss of energy
- c) part is scattered near to or at the surface of the target.

The specularly reflected beam returns, as in an image orthicon, but still following a helical path. On passing again between the steering plates it assumes a larger radius to be intercepted by an annular electrode termed the separator, which is positioned between the steering plates and first dynode.

The scattered electrons, which are proportional in number to the elemental target charge, carry no memory of the helical motion of the forward scanning beam but are symmetrically distributed about the normal to the target. They form a beam which travels back along the magnetic field axis. This beam passes between the steering plates where the deflecting field causes it to follow a helical path with a smaller radius than that of the doubly deflected specular beam. Almost all of the scattered beam passes through the aperture in the separator electrode and so enters the electron multiplier and is amplified to form the video signal.

This signal is proportional to the light input to the tube, therefore there is virtually no noise associated with the blacks of the picture. It is thus possible to set the scanning beam at a sufficiently high level to discharge very bright highlights of the picture, without loss of detail in the darker parts of the picture due to noise as is the case with the image orthicon.

## GENERAL DATA

### Electrical

Cathode . . . . .	indirectly heated, oxide coated	
Heater voltage . . . . .	6.3	V
Heater current . . . . .	0.1	A
Inter-electrode capacitance, anode to all other electrodes . . . . .	14	pF max
Focusing method . . . . .		magnetic
Deflection method . . . . .		magnetic
Focus field (see note 1) . . . . .	8.0mT (80 gauss)	

### Mechanical

Overall length:		
P8040 . . . . .	249mm (9.803 inches)	
P8041 . . . . .	251mm (9.882 inches)	
Overall diameter . . . . .	57mm (2.244 inches)	
Diameter of image section . . . . .	55mm (2.165 inches)	
Diameter of scanning section . . . . .	38mm (1.496 inches)	
Useful size of image . . . . .	maximum diagonal 36mm at photocathode	
Orientation for rectangular image . . . . .	the vertical scan should be parallel to a plane passing through the tube axis and the short index pin on the end base.	
Net weight:		
P8040 . . . . .	270g (9.5 ounces) approx	
P8041 . . . . .	300g (10.5 ounces) approx	
Mounting position . . . . .	any except with end base up and with tube axis at an angle less than 20° from vertical.	
End base (socket can be supplied by EEV) . . . . .	15-pin (JEDEC no. E15-95)	
Shoulder base . . . . .	11-pin special	

### Yoke MA355

Focus coil resistance . . . . .	23	Ω
Field coil inductance . . . . .	20	mH
Field coil resistance . . . . .	43	Ω
Line coil inductance . . . . .	1.0	mH
Line coil resistance . . . . .	2.2	Ω

## MAXIMUM RATINGS AND TYPICAL OPERATING CONDITIONS

All voltages with respect to cathode unless otherwise stated

	Max	Typical	
Photocathode voltage (image focus)	-700	-400 to -650	V
Grid 6 voltage (accelerator) (see note 2)	-700	-200 to -400	V
Target voltage	±10	±5	V
Target voltage above cut-off (recommended)		+4	V
Field mesh voltage above grid 4	+30	0	V
Grid 5 voltage with respect to grid 4	±100	-60 to 0	V
Grid 4 voltage (beam focus) (see note 3)	350	140 to 180	V
Steering plate voltage with respect to grid 4	±100	±40	V
Grid 3 voltage (multiplier focus)	450	300 to 400	V
Intermediate grid 2 (G <sub>2A</sub> ) voltage	350	50 to 200	V
Grid 2 and dynode 1 voltage	350	300	V
Grid 1 voltage (must never become positive)	-120	-5 to -100	V
Anode supply voltage (see note 4)	2000	1850	V
Voltage per multiplier stage	350	300	V
Dynode 2 voltage		600	V
Dynode 3 voltage (see note 4)		900	V
Dynode 4 voltage		1200	V
Dynode 5 voltage		1500	V
Dynode 6 voltage		1800	V
Focus coil current, yoke type MA355		610	mA
Field scan current (peak to peak) (see note 5)		125	mA
Line scan current (peak to peak) (see note 5)		800	mA

### Environmental Conditions

	Max	Typical	
Storage temperature	70	15 to 35	°C
Operating temperature of bulb	70	35 to 45	°C
Vibration	the tubes are designed to meet vibration specification BS3G.100, cat. 3		

## PERFORMANCE SPECIFICATION

	Min	Typical	Max	
<b>At knee of transfer characteristic</b>				
Photocathode illumination . . . . .	—	$10^{-3}$	$2 \times 10^{-3}$	ft-candle
Limiting resolution . . . . .	700	850	—	TV lines
Signal current . . . . .	5	15	50	$\mu\text{A}$
Signal to noise ratio (blacks) (see note 6) . . . . .	42	44	—	db
Signal to noise ratio (whites) (see note 6) . . . . .	28	30	—	db
<b>At <math>10^{-4}</math> foot-candles photocathode illumination</b>				
Limiting resolution . . . . .	500	575	—	TV lines
Signal current . . . . .	1	3	10	$\mu\text{A}$
Signal to noise ratio (blacks) (see note 6) . . . . .	32	34	—	db
Signal to noise ratio (whites) (see note 6) . . . . .	21	23	—	db
<b>At <math>10^{-5}</math> foot-candles photocathode illumination</b>				
Limiting resolution . . . . .	250	300	—	TV lines
Signal current . . . . .	0.1	0.3	1.0	$\mu\text{A}$
Signal to noise ratio (blacks) (see note 6) . . . . .	25	26	—	db
Signal to noise ratio (whites) (see note 6) . . . . .	15	16	—	db

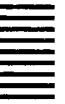

## NOTES

1. The direction of the focus current must be such that a north magnetic pole is attracted to the image end of the focus coil.
2. Normally about 60% of photocathode voltage.
3. Normally set for focus at about 160V.
4. Dynode 3 voltage may be made variable, from 600 to 900V, to provide a dynode gain control. Alternatively, the anode supply voltage may be varied, provided that the dynode 2 voltage is maintained at 600V and the voltage difference between dynode 6 and anode does not fall below 50V.
5. For normal raster operation.
6. Peak-to-peak signal divided by r.m.s. noise.

# TYPICAL RESOLUTION

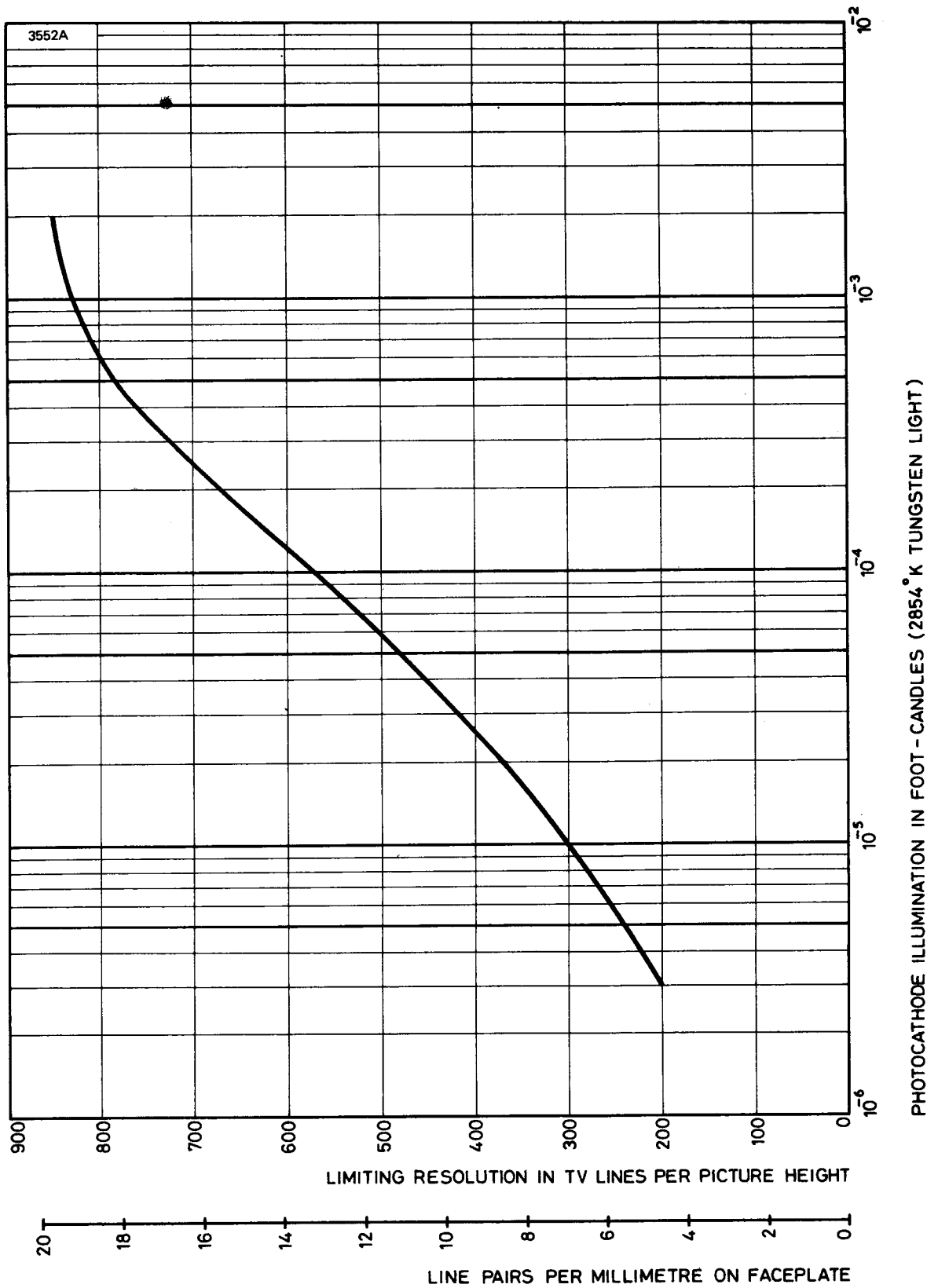



## OUTLINE OF YOKE TYPE MA355 WITH TUBE INSTALLED

All dimensions are nominal

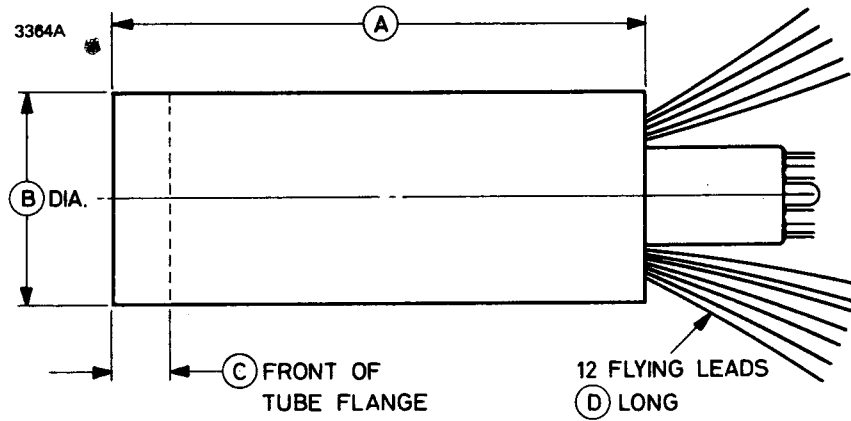

Ref	Millimetres	Inches
A	200.0	7.874
B	88.0	3.465
C	22.0	0.866
D	250.0	9.843

Inch dimensions have been derived from millimetres.

### Lead Connections

Colour	Element	Colour	Element
Grey/black	Earth	Blue	Grid 4
Orange/red	Line scan	Pink	Field mesh
Violet/red	Field scan	White	Grid 6
Violet	Photocathode	Red	Focus positive
Yellow	Grid 5	Black	Focus negative
Green	Target	Black/white	Thermistor

**P8040 OUTLINE (All dimensions are nominal)**

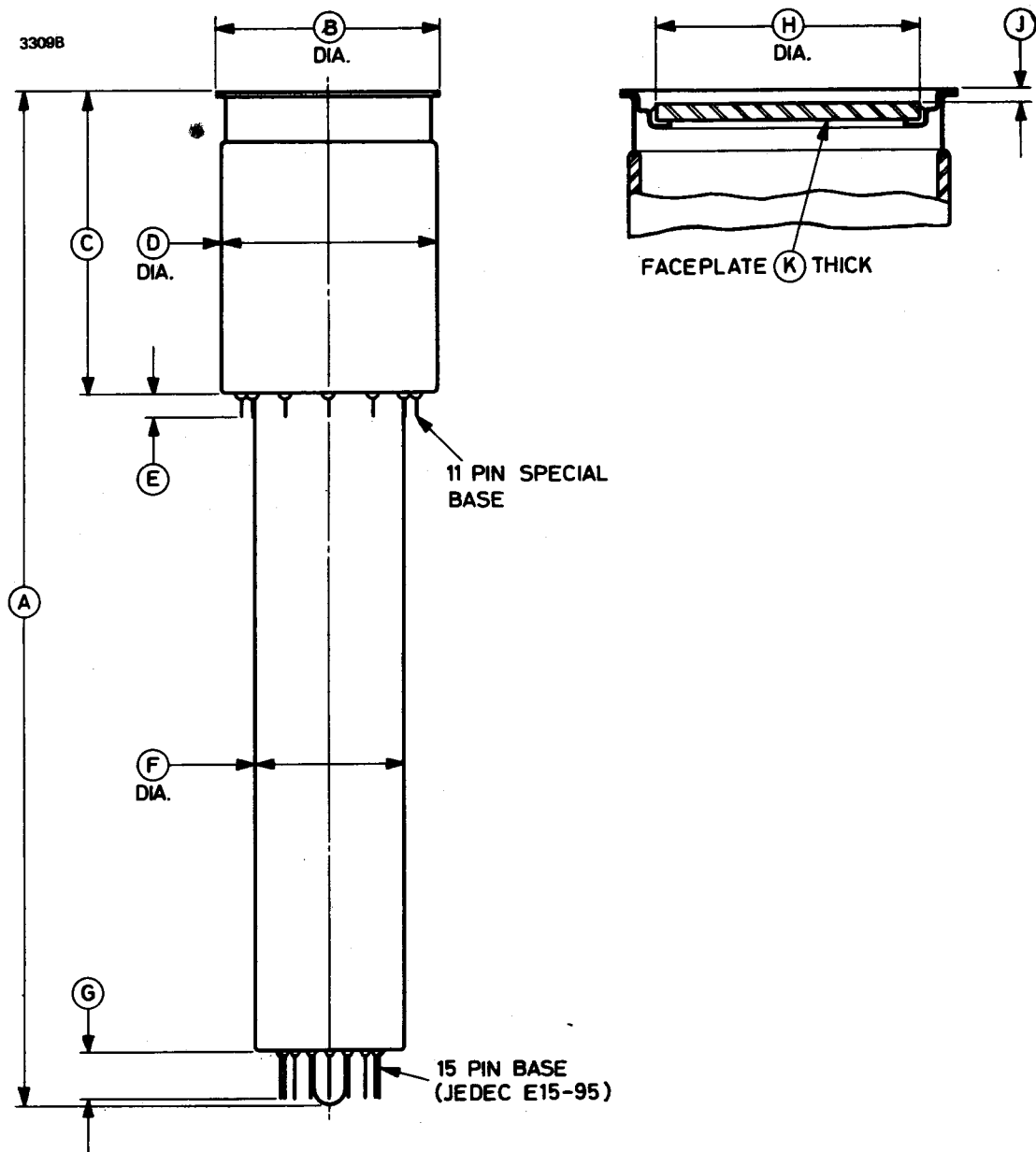

Ref	Millimetres	Inches	Ref	Millimetres	Inches
A	249.0	9.803	F	38.0	1.496
B	57.0	2.244	G	12.5	0.492
C	74.4	2.929	H	45.0	1.772
D	55.0	2.165	J	2.1	0.083
E	6.0	0.236	K	3.0	0.118

Inch dimensions have been derived from millimetres

**P8041 OUTLINE (All dimensions are nominal)**

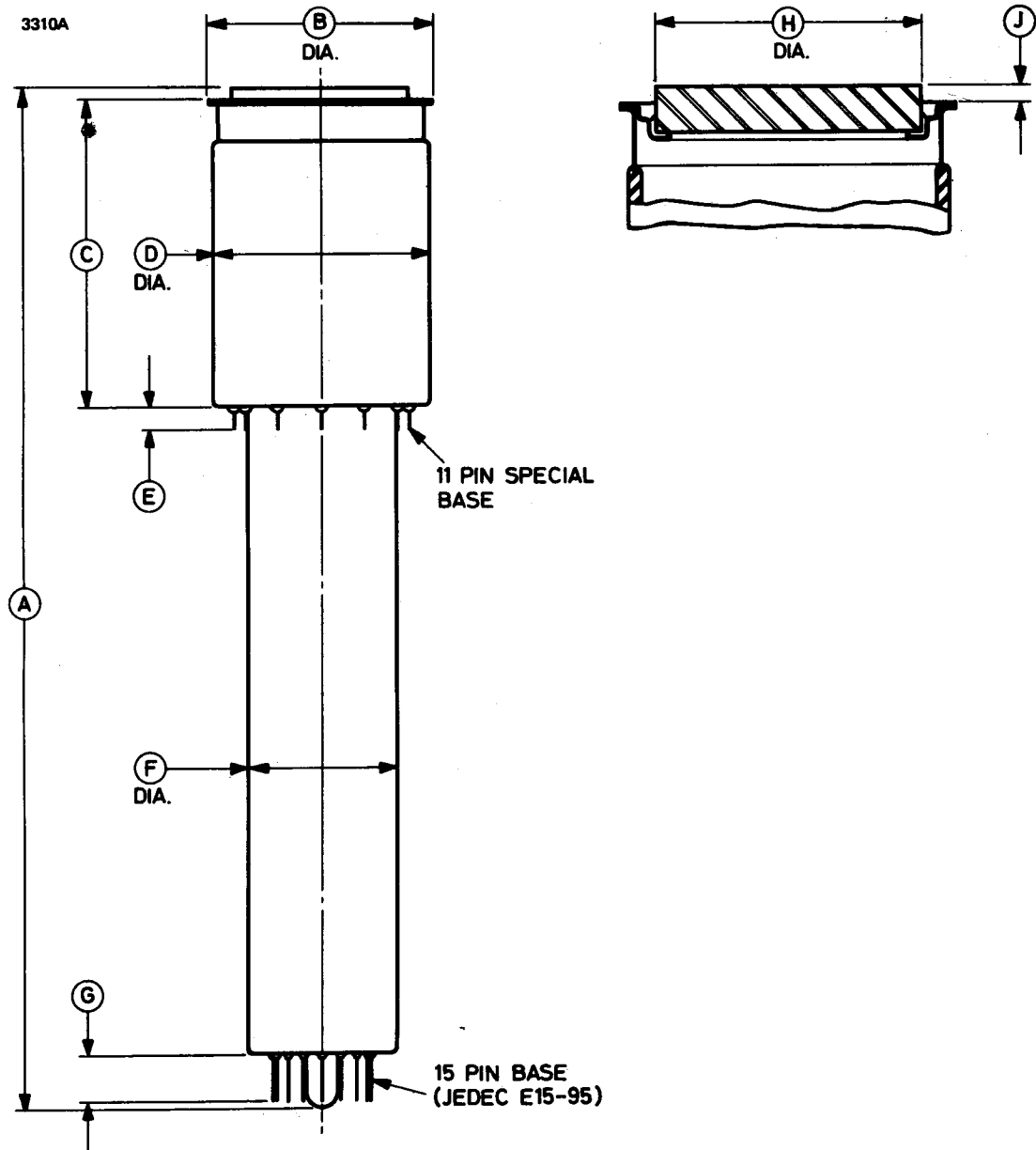

Ref	Millimetres	Inches	Ref	Millimetres	Inches
A	251.0	9.882	F	38.0	1.496
B	57.0	2.244	G	12.5	0.492
C	74.4	2.929	H	45.0	1.772
D	55.0	2.165	J	2.0	0.079
E	6.0	0.236			

Inch dimensions have been derived from millimetres

## BASE DETAILS (All dimensions without limits are nominal)

3311A

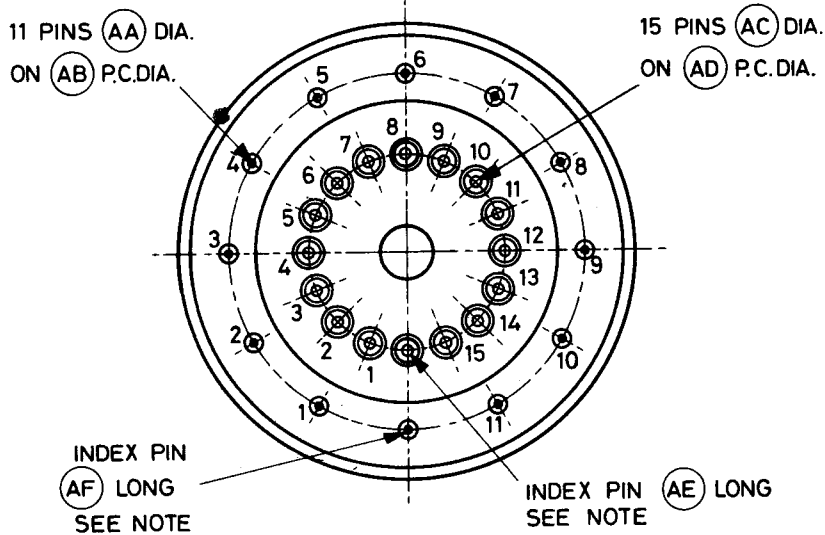

**Note** The index pins of the two bases will be aligned to within  $\pm 5^\circ$ .

Ref	Millimetres	Inches
AA	1.0	0.039
AB	47.5	1.870
AC	1.27	0.050
AD	24.6	0.969
AE	4.7 max	0.185 max
AF	3.2 max	0.126 max

Inch dimensions have been derived from millimetres.

### 11-Pin Shoulder Base Connections

Pin	Element
1	Internal connection. Do not use
2	Photocathode
3	Internal connection. Do not use
4	Grid 5
5	Target
6	Internal connection. Do not use
7	Grid 4
8	Internal connection. Do not use
9	Field mesh
10	Internal connection. Do not use
11	Grid 6

### 15-Pin End Base Connections

Pin	Element
1	Heater
2	Grid 1
3	Intermediate grid 2 (G2A)
4	Grid 3
5	Dynode 2
6	Dynode 4
7	Dynode 6
8	Anode
9	Dynode 5
10	Dynode 3
11	Dynode 1, Grid 2
12	Steering plate A
13	Steering plate B
14	Cathode
15	Heater

# Leddicons

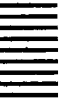





## INTRODUCTION

Picture blemishes are classified as either spots or smudges, according to size. Blemishes which exceed the limits given for size and contrast are cause for rejection. Within the limits given, spots may be present up to the number specified for each picture zone.

The contrast is measured on a waveform monitor, with black level taken as zero and maximum highlight as 100%.

The size of a blemish is measured as a percentage of the picture height and the equivalent number of raster lines quoted in the tables is a derived value. The maximum dimension of each blemish is the value to be measured.

## BROADCAST TUBES

### Test Conditions

Tubes are set up to the typical operating conditions given in the data sheets, using tungsten light of 2854°K colour temperature with the appropriate filters inserted for chrominance tubes. No gamma correction is used in the amplifier.

### Picture Zones

A transparency of the proportions shown below is used to define the picture zones.

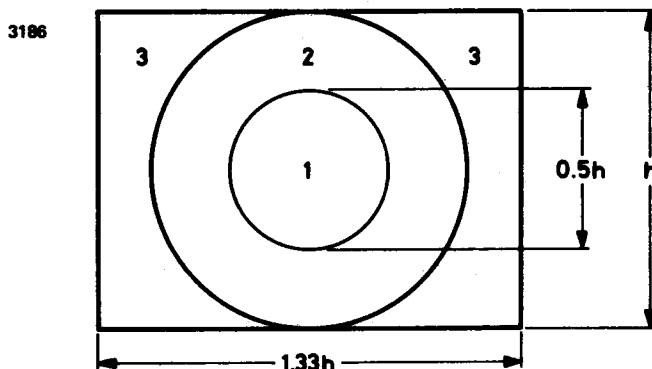

## Smudges

Blemishes having a dimension greater than 0.7% are classed as smudges and the maximum permitted contrast is as follows:

Size of Smudge		Maximum Contrast, %	
% of raster height	Number of lines (625 system)	Monochrome, luminance and green tubes	Red and blue tubes
> 6	38	2	3
>3 to 6	19 to 38	3.5	5.5
0.7 to 3	4 to 19	5	8

## Spots

Blemishes having dimensions 0.7% of picture height or less are classed as spots. The maximum permitted contrast and number of spots in each picture zone are given in the table below.

For monochrome, luminance and green tubes, spots of less than 5% contrast are ignored. For red and blue tubes, spots of less than 8% contrast are ignored.

Spot Size		Maximum Contrast, %		Maximum Number					
% of raster height	Number of lines (625 system)	black spots	white spots	Red, Green and Luminance tubes (See note 1)			Blue tubes (See notes 1 and 2)		
				Zone 1	Zone 2	Zone 3	Zone 1	Zone 2	Zone 3
$\leq 0.7$									
>0.45	3-4	25	12.5	0	0	1	0	1	3
$\leq 0.45$									
>0.2	1-2	60	30	0	2	2	1	2	4
$\leq 0.2$	$\leq 1$	100	50	see note 3			see note 3		



## INDUSTRIAL GRADE TUBES

### Test Conditions and Picture Zones

Industrial grade tubes are tested with the same operating conditions and picture zones as broadcast tubes.

### Smudges

Blemishes having a dimension greater than 1% and contrast greater than 10% will be cause for rejection.

### Spots

Blemishes having dimensions less than 1% and contrast greater than 10% are classed as spots. The maximum permitted number is as follows:

Spot Size		Maximum Number (See note 1)			
% of raster height	Number of lines (625 system)	Zone 1	Zone 2	Zone 3	Total
$>0.7 \leq 1$	5 to 6	0	1	2	2
$>0.45 \leq 0.7$	3 to 4	1	2	4	4
$>0.2 \leq 0.45$	1 to 2	2	4	6	6
$\leq 0.2$	$\leq 1$		see note 3		
Total number in each zone		2	4	6	6

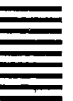

## MEDICAL X-RAY TUBES

### Test Conditions and Picture Zones

The light source used is a P20 phosphor. A transparency of the proportions shown is used to define the picture zones.

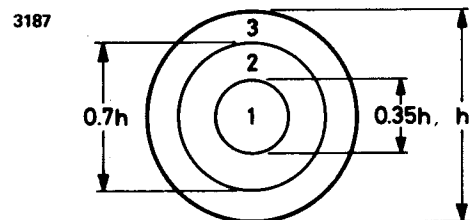

### Smudges

Blemishes having a dimension greater than 0.7% and a contrast greater than 3% are cause for rejection.

### Spots

Blemishes having dimensions less than 0.7% and contrast greater than 3% are classed as spots. The maximum permitted contrast and number of spots in each picture zone are given in the table on page 4.

---

**Spot Size**

---

% of raster height	* Number of lines (625 system)	Maximum Contrast, %	Maximum Number (See note 4)		
			Zone 1	Zone 2	Zone 3
$>0.45 \leq 0.7$	3 to 4	25	0	1	3
$>0.2 \leq 0.45$	1 to 2	50	2	3	6
$\leq 0.2$	$\leq 1$	100	see note 3		

---

**NOTES**

1. The distance between any two spots must be greater than 5%.
2. The total number of spots in zones 2 and 3 will not exceed 5.
3. Spots of this size are ignored, unless present in sufficient concentration to produce a smudge.
4. The total number of spots in zones 2 and 3 will not exceed 6.

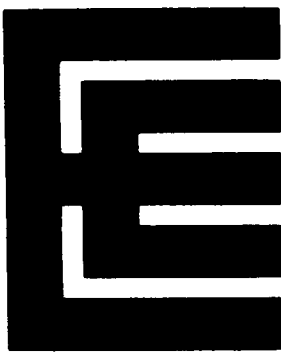

## LEDDICON CAMERA TUBES

### ABRIDGED DATA

The P8000 series comprises 30mm diameter camera tubes of integral mesh construction, with lead oxide photoconductive layers. They feature very short lag, high sensitivity and low dark current.

<b>Type</b>	<b>Application</b>
P8000	Monochrome cameras
P8000L	Luminance channel of colour cameras
P8000B	Blue channel of colour cameras
P8000G	Green channel of colour cameras
P8000R	Red channel of colour cameras

Dark current . . . . .	3.0	nA max
Limiting resolution . . . . .	>600	TV lines
Peak spectral response . . . . .	500	nm approx



### GENERAL

#### Electrical

Cathode . . . . .	indirectly heated
Heater voltage . . . . .	6.3 ± 5% V
Heater current at 6.3V . . . . .	95 ± 10% mA
Inter-electrode capacitance:	
signal electrode to all other electrodes (see note 1) . . . . .	3.0 to 6.0 pF
Focusing method . . . . .	magnetic
Deflection method . . . . .	magnetic

**Mechanical**

Size of quality rectangle on photoconductive layer (see note 2)	12.8 x 17.1mm
Orientation of quality rectangle	see note 3
Net weight	100 g approx
Mounting position	any
Base	see note 4 and Outline

**Storage and Handling Recommendations**

- a) For storage, handling or transport the longitudinal axis of the tube must be either vertical with the faceplate uppermost, or horizontal.
- b) The faceplate should be covered at all times with the plastic cap provided. Exposure to illumination unnecessarily may cause deterioration of the photosurface.
- c) The temperature during storage should not exceed 30°C.
- d) It is undesirable to store the tube for extended periods without use. To avoid deterioration each tube should be operated for several hours each month, in an overscanned condition with the target illuminated evenly at a light level sufficient to produce a signal current of 150nA. When a tube is to be used after a period of storage it may be necessary to carry out the same procedure, before optimum performance can be obtained.

**MAXIMUM AND MINIMUM RATINGS (Absolute values)**

No individual rating should be exceeded

	<b>Min</b>	<b>Max</b>	
Signal electrode voltage	—	50	V
Grid 4 and grid 3 voltage	—	750	V
Grid 2 voltage	—	450	V
Grid 1 voltage:			
positive bias	—	0	V
negative bias	—	125	V
Cathode current	—	3.0	mA
Peak heater to cathode voltage:			
heater negative with respect to cathode	—	125	V
heater positive with respect to cathode	—	10	V
Peak illumination of faceplate (see note 5)	—	500	lux
Faceplate temperature (storage or operation)	-30	50	°C
Ambient temperature (storage or operation)	-30	50	°C
Cathode heating time	60	—	s

**TYPICAL OPERATING CONDITIONS** (for scanned area 12.8 x 17.1mm)

Cathode voltage . . . . .	0	V
Grid 4 and grid 3 voltage . . . . .	550 to 600	V
Grid 2 voltage . . . . .	300	V
Grid 1 voltage for picture cut-off (with no blanking voltage on grid 1) . . . . .	-30 to -100	V
Blanking voltage (peak to peak):		
when applied to grid 1 (negative pulses) . . . . .	70	V min
when applied to cathode (positive pulses) . . . . .	25	V min
Signal electrode voltage (see note 6) . . . . .	45	V
Grid 2 current with normal beam currents . . . . .	0.5	mA max
Dark current . . . . .	<3.0	nA
Faceplate illumination . . . . .		see note 7
Faceplate temperature:		
operating . . . . .	20 to 45	°C
Highlight signal electrode current . . . . .	0.3	µA
Beam current . . . . .		see note 8
Amplitude response to a 400 TV line square wave test pattern at centre of picture (approx) . . . . .		
		see note 9
Limiting resolution at centre of picture . . . . .	>600	TV lines
Visual equivalent signal to noise ratio (see note 10) . . . . .		
	200:1	approx
'Gamma' of transfer characteristic . . . . .	0.95 ± 0.05	
Lag (see note 11):		
	P8000B	P8000L,G,R
after dark pulse of 60ms . . . . .	6.0	5.0   % max
after dark pulse of 200ms . . . . .	3.0	2.0   % max
Sensitivity (see note 12):		
P8000, P8000L . . . . .	>275	µA/lumen
P8000B . . . . .	>32	µA/lumen
P8000G . . . . .	>125	µA/lumen
P8000R . . . . .	>60	µA/lumen



**NOTES**

1. This capacitance, which effectively is the output impedance of the tube, is increased by approximately 5pF when the tube is inserted in the deflecting yoke and focusing coil assembly.

2. Failure of scanning or underscanning of the specified quality rectangle should be avoided. The area outside the quality rectangle should be masked to reduce the effects of internal reflections. The amplitude and position of scan should be adjusted so that the mesh ring does not appear in the corner of the picture.
3. The vertical scan should be parallel to the plane passing through the tube axis and the index mark on the tube base.
4. The base has tungsten pins and care must be taken when inserting the tube into a socket. A suitable socket is Philips type 56021.
5. For very short periods only. In general, unnecessary strong illumination of the faceplate should be avoided, to reduce risk of damage to the photolayer. For this reason, the faceplate should be covered with the plastic cap provided, whenever the tube is removed from the camera. When the camera is not in operation the lens should also be capped.
6. The tube is specified for operation at a target voltage of 45V. The televising of a scene of excessive contrast may be facilitated by operation at a target voltage of 25V. This may lead to a slight degradation in performance.
7. P8000 and P8000L typically require a faceplate illumination of 4 lux to produce a signal electrode current of  $0.3\mu\text{A}$ . The colour tubes will give the signal currents specified in note 9 with an incident white level (2854K) on the appropriate filter of approx. 10 lux.
8. The beam current is adjusted to discharge a highlight signal current of 600nA for monochrome, luminance and green tubes, and 300nA for red and blue tubes.
9. The typical figures given below represent the horizontal amplitude response after correction for optical system faults. Grid 3 and grid 4 voltage is adjusted for optimum focus.

	P8000	P8000L	P8000B	P8000G	P8000R
Highlight signal current	300	150	300	150	nA
Beam current set to discharge a signal current of . . . . .	600	300	600	300	nA
Amplitude response (grid 4 at 550 to 650V):					
typical . . . . .	40	50	40	35	%
minimum . . . . .	35	45	35	30	%

10. The visual equivalent signal to noise ratio is taken as the ratio of the highlight signal output current to the r.m.s. noise current, multiplied by a factor of 3, assuming an r.m.s. noise current of the video pre-amplifier of 2nA, bandwidth 5MHz.
11. Percentage of initial value of signal output current remaining after a dark pulse. Initial highlight signal output current of 0.1 $\mu$ A and with a white light source (2854K). Appropriate filters used with colour tubes. The beam current setting will be as indicated in note 9.
12. With faceplate illumination set to 4.54 lux (2854K tungsten light), the appropriate filter is inserted in the light path:

P8000B	Schott BG12	3mm thick
P8000G	Schott VG9	1mm thick
P8000R	Schott OG2	3mm thick

### SETTING-UP PROCEDURE

- a. Insert the tube in the camera, ensuring that the plane through the axis of the tube and the index mark on the base is parallel to the direction of the field scan. The P8000 has tungsten base pins and the socket must be fitted carefully to avoid excessive strains in the glass.
- b. Cap the lens and close the iris.
- c. Set the grid 1 voltage for maximum negative bias for picture cut-off and adjust the signal electrode voltage to the specified value. Adjust the scanning amplitude controls so that a maximum area of the photoconductive layer will be scanned.
- d. Switch on the camera equipment and allow it to warm up. The heater must operate for at least one minute at 6.3V before proceeding to step g.
- e. Adjust the monitor to produce a faint non-overscanned raster.
- f. Direct the camera at the scene to be televised and uncap the lens.
- g. Decrease grid 1 voltage from its maximum negative value until a picture appears on the monitor, increasing the lens aperture if the picture is too faint.
- h. Adjust grid 4 and grid 3 voltage and the optical focus alternately to obtain the best focused picture.
- j. Align the beam by adjusting the alignment fields so that the centre of the picture does not move as grid 4 and grid 3 voltage is varied.
- k. Adjust the deflection amplitude and position to scan an area 12.8mm x 17.1mm.

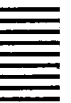

m. Adjust the lens iris to obtain sufficient signal output and adjust the beam current to a value at which highlights are stabilized.

In order to improve the highlight handling capability of the tube and reduce highlight retention effects, it is customary to use a beam current sufficient to discharge a signal double the working highlight level. This may be done by setting the beam to just discharge the highlights, with the lens iris opened one stop from the operating point. Some cameras incorporate an attenuator to assist in this process and the camera manufacturers' instructions should be consulted before making this adjustment. Still higher beam currents can be used but may produce slight degradation in resolution, lag and geometry.

n. Check alignment, beam focus and optical focus.

p. During a prolonged period of standby the following procedure should be adopted.

1. Cap camera lens.
2. Cut-off beam by adjusting grid 1 voltage to maximum negative value.
3. Reduce heater voltage to approximately 4V.

To resume normal operation the above sequence of operations should be reversed.

1. Restore heater voltage to 6.3V.
2. Allow heater to operate at 6.3V for at least one minute.
3. Adjust grid 1 voltage (beam control) to restore beam current to the required level.
4. Uncap camera lens.



## OUTLINE (All dimensions without limits are nominal)

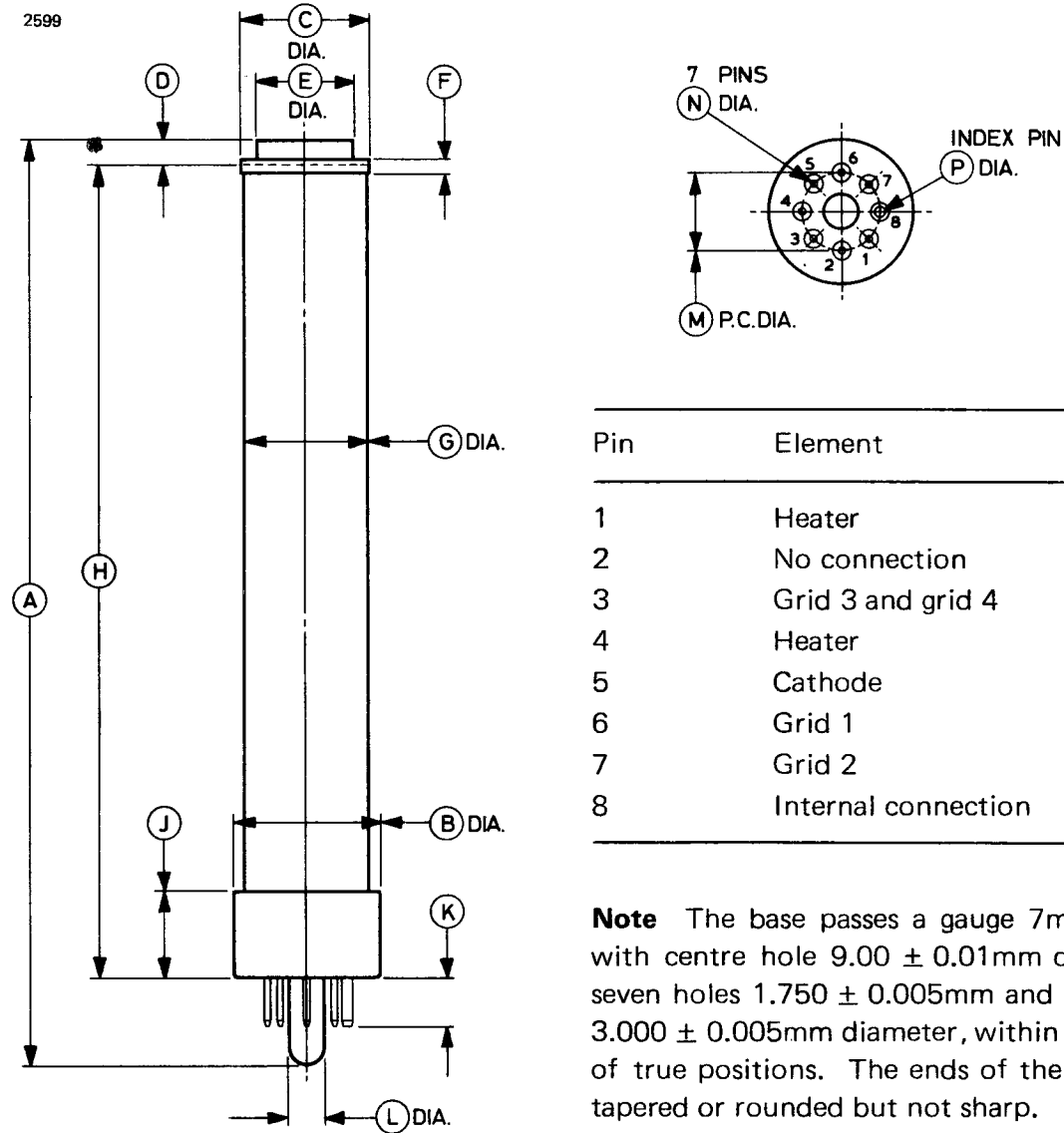

Pin	Element
1	Heater
2	No connection
3	Grid 3 and grid 4
4	Heater
5	Cathode
6	Grid 1
7	Grid 2
8	Internal connection

**Note** The base passes a gauge 7mm thick with centre hole  $9.00 \pm 0.01$ mm diameter, seven holes  $1.750 \pm 0.005$ mm and one hole  $3.000 \pm 0.005$ mm diameter, within 0.01mm of true positions. The ends of the pins are tapered or rounded but not sharp.

Ref	Millimetres	Inches	Ref	Millimetres	Inches
A	220.0 max	8.661 max	H	$190.0 \pm 2.0$	$7.480 \pm 0.079$
B	$34.5 \pm 0.3$	$1.358 \pm 0.012$	J	$21.0 \pm 0.5$	$0.827 \pm 0.020$
C	30.6 max	1.205 max	K	11.0 max	0.433 max
D	$6.0 \pm 0.2$	$0.236 \pm 0.008$	L	8.7 max	0.343 max
E	$23.0 \pm 0.1$	$0.906 \pm 0.004$	M	18.0	0.709
F	$3.2 \pm 0.1$	$0.126 \pm 0.004$	N	1.50	0.059
G	$30.15 \pm 0.30$	$1.187 \pm 0.012$	P	$2.5 \pm 0.2$	$0.098 \pm 0.008$

Inch dimensions have been derived from millimetres.

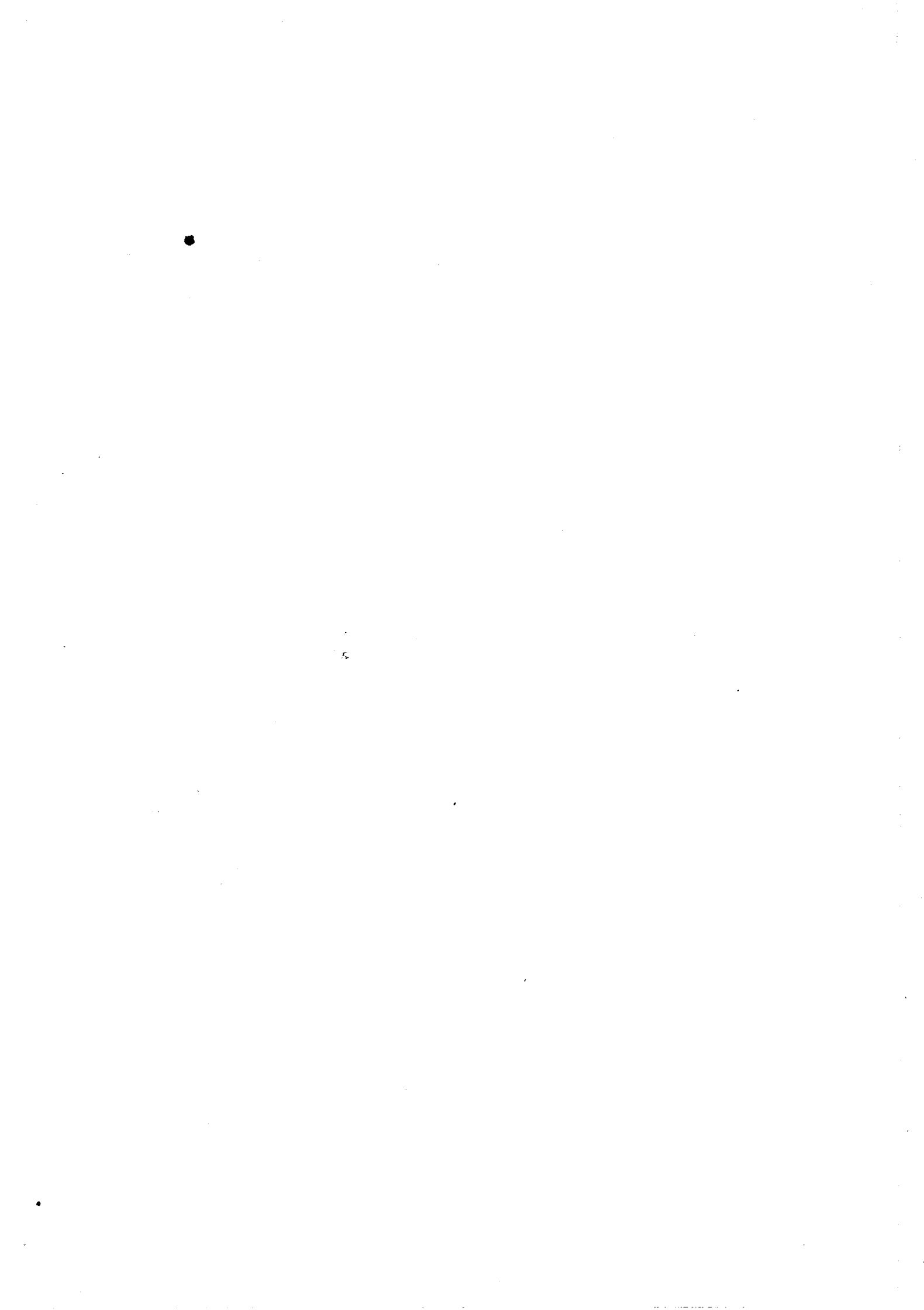

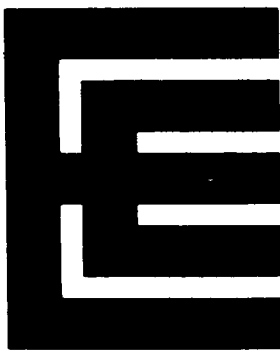

# P8001 Series

## LEDDICON CAMERA TUBES

### ABRIDGED DATA

The P8001 series comprises 30mm diameter camera tubes of separate mesh construction, with lead oxide photoconductive layers. They feature very short lag, high sensitivity and low dark current.

<b>Type</b>	<b>Application</b>		
P8001	Monochrome cameras		
P8001L	Luminance channel of colour cameras		
P8001B	Blue channel of colour cameras		
P8001G	Green channel of colour cameras		
P8001R	Red channel of colour cameras		
Dark current . . . . .		3.0	nA max
Limiting resolution . . . . .		>600	TV lines
Peak spectral response . . . . .		500	nm approx



### GENERAL

#### Electrical

Cathode . . . . .	indirectly heated	
Heater voltage . . . . .	$6.3 \pm 5\%$	V
Heater current at 6.3V . . . . .	$95 \pm 10\%$	mA
Inter-electrode capacitance:		
signal electrode to all other		
electrodes (see note 1) . . . . .	3.0 to 6.0	pF
Focusing method . . . . .		magnetic
Deflection method . . . . .		magnetic

## Mechanical

Size of quality rectangle on photoconductive layer (see note 2)	12.8 x 17.1mm
Orientation of quality rectangle	by means of index pin (see note 3)
Net weight	100 g approx
Mounting position	any
Base	see note 4 and Outline

## Storage and Handling Recommendations

- For storage, handling or transport the longitudinal axis of the tube must be either vertical with the faceplate uppermost, or horizontal.
- The faceplate should be covered at all times with the plastic cap provided. Exposure to illumination unnecessarily may cause deterioration of the photosurface.
- The temperature during storage should not exceed 30°C.
- It is undesirable to store the tube for extended periods without use. To avoid deterioration each tube should be operated for several hours each month, in an overscanned condition with the target illuminated evenly at a light level sufficient to produce a signal current of 150nA. When a tube is to be used after a period of storage it may be necessary to carry out the same procedure, before optimum performance can be obtained.

## MAXIMUM AND MINIMUM RATINGS (Absolute values)

No individual rating should be exceeded

	Min	Max	
Signal electrode voltage	—	50	V
Grid 4 (mesh) voltage	—	1100	V
Grid 3 voltage	—	800	V
Grid 4 to grid 3 voltage	—	350	V
Grid 2 voltage	—	350	V
Grid 1 voltage:			
positive bias	—	0	V
negative bias	—	125	V
Cathode current	—	6.0	mA
Peak heater to cathode voltage:			
heater negative with respect to cathode	—	50	V
heater positive with respect to cathode	—	50	V
Peak illumination of faceplate (see note 5)	—	500	lux
Faceplate temperature (storage or operation)	-30	50	°C
Ambient temperature (storage or operation)	-30	50	°C
Cathode heating time	60	—	s

**TYPICAL OPERATING CONDITIONS** (for scanned area 12.8 x 17.1mm)

Cathode voltage . . . . .	0	V	
Grid 4 (mesh) voltage . . . . .	550 to 650	V	
Grid 4 to grid 3 voltage (see note 6) . . . . .	50 to 100	V	
Grid 2 voltage . . . . .	300	V	
Grid 1 voltage for picture cut-off (with no blanking voltage on grid 1) . . . . .	-30 to -100	V	
Blanking voltage (peak to peak):			
when applied to grid 1 (negative pulses) . . . . .	70	V min	
when applied to cathode (positive pulses) . . . . .	25	V min	
Signal electrode voltage (see note 7) . . . . .	45	V	
Grid 2 current with normal beam currents . . . . .	2.0	mA max	
Dark current . . . . .	<3.0	nA	
Faceplate illumination . . . . .		see note 8	
Faceplate temperature:			
operating . . . . .	20 to 45	°C	
Highlight signal electrode current . . . . .	0.3	µA	
Beam current . . . . .		see note 9	
Amplitude response to a 400 TV line square wave test pattern at centre of picture (approx) . . . . .		see note 10	
Limiting resolution at centre of picture . . . . .	>600	TV lines	
Visual equivalent signal to noise ratio (see note 11) . . . . .	200:1	approx	
'Gamma' of transfer characteristic . . . . .	0.95 ± 0.05		
Lag (see note 12):			
	P8001B	P8001L,G,R	
after dark pulse of 60ms . . . . .	6.0	5.0	% max
after dark pulse of 200ms . . . . .	3.0	2.0	% max
Sensitivity (see note 13):			
P8001, P8001L . . . . .		>275	µA/lumen
P8001B . . . . .		>32	µA/lumen
P8001G . . . . .		>125	µA/lumen
P8001R . . . . .		>60	µA/lumen

**NOTES**

1. This capacitance, which effectively is the output impedance of the tube, is increased by approximately 5pF when the tube is inserted in the deflecting yoke and focusing coil assembly.

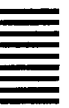

2. Failure of scanning or underscanning of the specified quality rectangle should be avoided. The area outside the quality rectangle should be masked to reduce the effects of internal reflections. The amplitude and position of scan should be adjusted so that the mesh ring does not appear in the corner of the picture.
3. The horizontal scan should be parallel to the plane passing through the tube axis and the index pin on the tube base.
4. The base has tungsten pins and care must be taken when inserting the tube into a socket. A suitable socket is Philips type 56021.
5. For very short periods only. In general, unnecessary strong illumination of the faceplate should be avoided, to reduce risk of damage to the photolayer. For this reason, the faceplate should be covered with the plastic cap provided, whenever the tube is removed from the camera. When the camera is not in operation the lens should also be capped.
6. Operation with grid 4 at a higher voltage than grid 3 gives improved corner resolution. The optimum ratio of grid 4 to grid 3 voltage depends upon the coil assembly used.
7. The tube is specified for operation at a target voltage of 45V. The televising of a scene of excessive contrast may be facilitated by operation at a target voltage of 25V. This may lead to a slight degradation in performance.
8. P8001 and P8001L typically require a faceplate illumination of 4 lux to produce a signal electrode current of  $0.3\mu\text{A}$ . The colour tubes will give the signal currents specified in note 10 with an incident white level (2854K) on the appropriate filter of approx. 10 lux.
9. The beam current is adjusted to discharge a highlight signal current of 600nA for monochrome, luminance and green tubes, and 300nA for red and blue tubes.
10. The typical figures given below represent the horizontal amplitude response after correction for optical system faults. Grid 3 and grid 4 voltages are adjusted for optimum focus.

	P8001	P8001L	P8001B	P8001G	P8001R	
Highlight signal current	300	150	300	150	nA	
Beam current set to discharge a signal current of . . . . .	600	300	600	300	nA	
Amplitude response (grid 4 at 550 to 650V):						
typical . . . . .	40	50	40	35	%	
minimum . . . . .	35	45	35	30	%	

11. The visual equivalent signal to noise ratio is taken as the ratio of the highlight signal output current to the r.m.s. noise current, multiplied by a factor of 3, assuming an r.m.s. noise current of the video pre-amplifier of 2nA, bandwidth 5MHz.
12. Percentage of initial value of signal output current remaining after a dark pulse. Initial highlight signal output current of 0.1 $\mu$ A and with a white light source (2854K). Appropriate filters used with colour tubes. The beam current setting will be as indicated in note 10.
13. With faceplate illumination set to 4.54 lux (2854K tungsten light), the appropriate filter is inserted in the light path:
 

P8001B	Schott BG12	3mm thick
P8001G	Schott VG9	1mm thick
P8001R	Schott OG2	3mm thick

### SETTING-UP PROCEDURE

- a. Insert the tube in the camera, ensuring that the plane through the axis of the tube and the index pin of the base is parallel to the direction of the line scan. Make connection to the base pins.
- b. Cap the lens and close the iris.
- c. Set the grid 1 voltage for maximum negative bias for picture cut-off and adjust the signal electrode voltage to the specified value. Adjust the scanning amplitude controls so that a maximum area of the photoconductive layer will be scanned.
- d. Switch on the camera equipment and allow it to warm up. The heater must operate for at least one minute at 6.3V before proceeding to step g.
- e. Adjust the monitor to produce a faint non-overscanned raster.
- f. Direct the camera at the scene to be televised and uncap the lens.
- g. Decrease grid 1 voltage from its maximum negative value until a picture appears on the monitor, increasing the lens aperture if the picture is too faint.
- h. Adjust grid 4 and grid 3 voltages and the optical focus alternately to obtain the best focused picture.
- j. Align the beam by adjusting the alignment fields so that the centre of the picture does not move as grid 4 and grid 3 voltages are varied.
- k. Adjust the deflection amplitude and position to scan an area 12.8mm x 17.1mm.

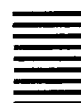

m. Adjust the lens iris to obtain sufficient signal output and adjust the beam current to a value at which highlights are stabilized.

In order to improve the highlight handling capability of the tube and reduce highlight retention effects, it is customary to use a beam current sufficient to discharge a signal double the working highlight level. This may be done by setting the beam to just discharge the highlights, with the lens iris opened one stop from the operating point. Some cameras incorporate an attenuator to assist in this process and the camera manufacturers' instructions should be consulted before making this adjustment. Still higher beam currents can be used but may produce slight degradation in resolution, lag and geometry.

n. Check alignment, beam focus and optical focus.

p. During a prolonged period of standby the following procedure should be adopted.

1. Cap camera lens.
2. Cut-off beam by adjusting grid 1 voltage to maximum negative value.
3. Reduce heater voltage to approximately 4V.

To resume normal operation the above sequence of operations should be reversed.

1. Restore heater voltage to 6.3V.
2. Allow heater to operate at 6.3V for at least one minute.
3. Adjust grid 1 voltage (beam control) to restore beam current to the required level.
4. Uncap camera lens.



**OUTLINE (All dimensions without limits are nominal)**

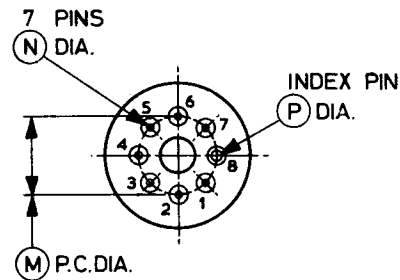
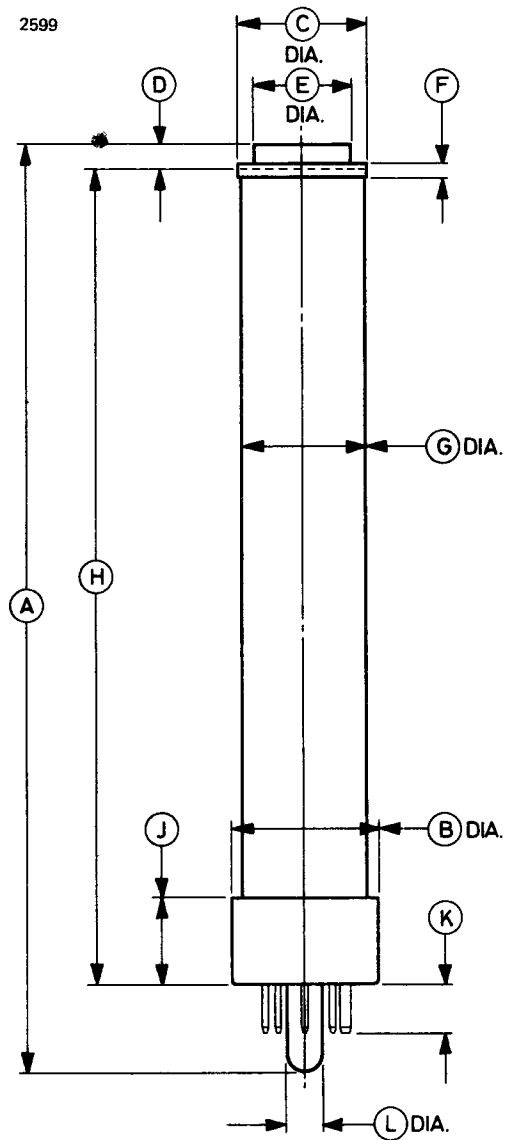

Pin	Element
1	Heater
2	Grid 4 (mesh)
3	Grid 3
4	Heater
5	Cathode
6	Grid 1
7	Grid 2
8	Internal connection

**Note** The base passes a gauge 7mm thick with centre hole  $9.00 \pm 0.01$ mm diameter, seven holes  $1.750 \pm 0.005$ mm and one hole  $3.000 \pm 0.005$ mm diameter, within 0.01mm of true positions. The ends of the pins are tapered or rounded but not sharp.

Ref	Millimetres	Inches	Ref	Millimetres	Inches
A	220.0 max	8.661 max	H	$190.0 \pm 2.0$	$7.480 \pm 0.079$
B	$34.5 \pm 0.3$	$1.358 \pm 0.012$	J	$21.0 \pm 0.5$	$0.827 \pm 0.020$
C	30.6 max	1.205 max	K	11.0 max	0.433 max
D	$6.0 \pm 0.2$	$0.236 \pm 0.008$	L	8.7 max	0.343 max
E	$23.0 \pm 0.1$	$0.906 \pm 0.004$	M	18.0	0.709
F	$3.2 \pm 0.1$	$0.126 \pm 0.004$	N	1.50	0.059
G	$30.15 \pm 0.30$	$1.187 \pm 0.012$	P	$2.5 \pm 0.2$	$0.098 \pm 0.008$

Inch dimensions have been derived from millimetres.



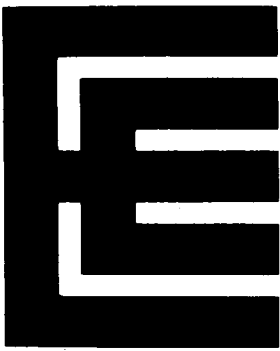

# P8004 Series

## LEDDICON CAMERA TUBES WITH LIGHT BIAS FACILITY

---

### OBJECTIVE DATA

#### INTRODUCTION

The P8004 Series comprises 30mm diameter lead oxide camera tubes of integral mesh construction, featuring an internal light source to permit light biased operation. This facility is effective in controlling lag, the smearing of moving objects, seen particularly when operating under low light conditions. Ingress of stray light is prevented by an opaque lacquer coating on the tube envelope.

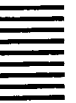
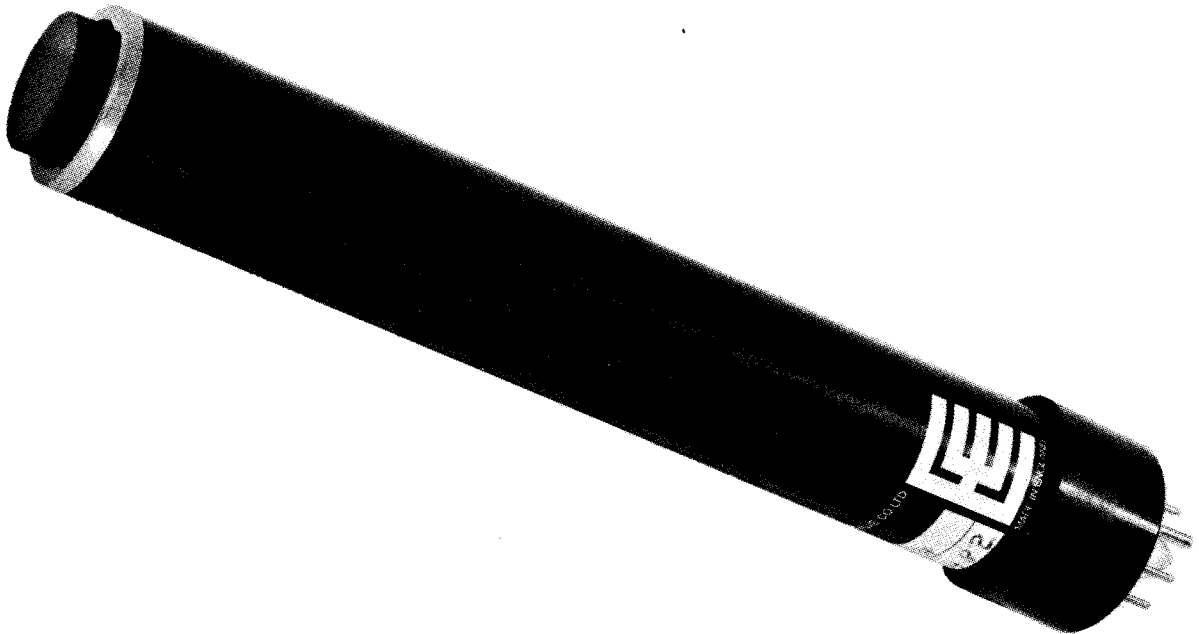

The tubes can be operated in three possible modes.

- 1) With bias light switched off.
- 2) With bias light operated at a fixed voltage not greater than 5.0V. Under these conditions the lamp can be operated in parallel with the heater by suitable connections at the camera socket, via a resistor, provided the camera power supplies are adequate.
- 3) With variable light bias individually adjustable to match the lag characteristics of each channel. Under these conditions colour fringing of moving objects will be minimized.

## TYPES AVAILABLE

The following types are available:

Type	Application
P8004	Monochrome cameras
P8004L	Luminance channel of colour cameras
P8004B	Blue channel of colour cameras
P8004G	Green channel of colour cameras
P8004R	Red channel of colour cameras

## GENERAL

### Electrical

Cathode	indirectly heated
Heater voltage	$6.3 \pm 5\%$ V
Heater current at 6.3V	$95 \pm 10\%$ mA
Bias lamp voltage	5.0 V max
Inter-electrode capacitance:	
signal electrode to all other electrodes (see note 1)	3.0 to 6.0 pF
Focusing method	magnetic
Deflection method	magnetic
Peak spectral response	500 nm approx

### Mechanical

Overall length	220mm (8.660 inches) max
Bulb diameter	30.45mm (1.200 inches) max
Useful size of photosurface	
image (see note 2)	12.8 x 17.1mm
Orientation of photosurface image	see note 3
Net weight	100g approx
Mounting position	any
Base	see note 4 and outline

### Storage and Handling Recommendations

- a) For storage, handling or transport the longitudinal axis of the tube must be either vertical with the faceplate uppermost, or horizontal.

- b) The faceplate must be covered at all times with the plastic cap provided. Unnecessary exposure to illumination may cause deterioration of the photosurface.
- c) The ambient temperature during storage must not exceed 30°C.
- d) It is undesirable to store the tube for extended periods without use. To avoid deterioration each tube should be operated for several hours each month, in an overscanned condition with the photosurface illuminated evenly, a signal current of 150nA and beam set to discharge 300nA.
- e) Care must be taken to avoid damaging the opaque coating on the tube envelope.

### LIGHT BIAS OPERATION

The light bias lamp is connected internally between pin 1 (heater) and pin 8 (index). The supply to the lamp can be a.c. or d.c. but d.c. is preferable as it can easily be stabilized and decoupled. The maximum voltage and current ratings of 5.0V and 250mA must not be exceeded under any conditions. The light bias should be adjusted on individual tubes to minimize differential lag; the required value of light bias dark current for each tube will vary according to the type of camera, colour temperature of the scene illuminant, etc. One method of obtaining the required supplies is to use the stabilized camera tube heater supply. This method is possible if the tube heater supply is capable of delivering 1.0A at 6.3V (3 tube camera) or 1.3A at 6.3V (4 tube camera). A suggested circuit is shown below.

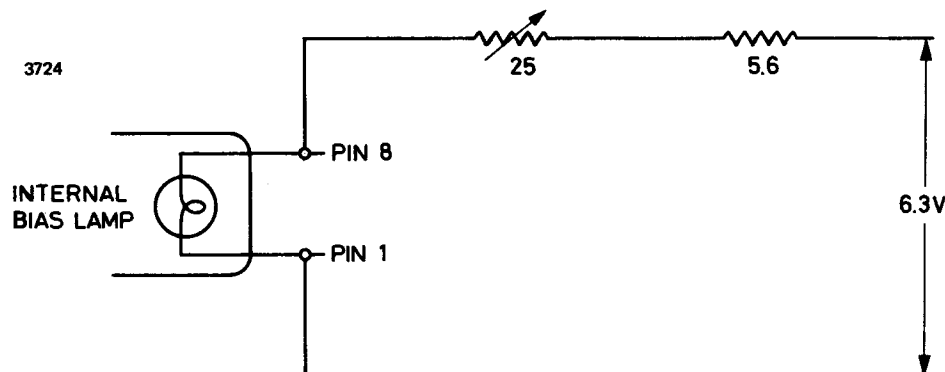

**Warning** The light bias connection to pin 8 must be disconnected before a standard Leddicon without light bias can be inserted. The reason for this is that pin 8 of the standard tube is connected internally to grid 1.

## MAXIMUM AND MINIMUM RATINGS (Absolute values)

	Min	Max	
Signal electrode voltage . . . . .	—	50	V
Grid 4 and grid 3 voltage . . . . .	—	750	V
Grid 2 voltage . . . . .	—	450	V
Grid 1 voltage:			
positive bias . . . . .	—	0	V
negative bias . . . . .	—	125	V
Cathode current . . . . .	—	3.0	mA
Peak heater to cathode voltage:			
heater negative with respect to cathode . . . . .	—	125	V
heater positive with respect to cathode . . . . .	—	10	V
Peak illumination of faceplate (see note 5) . . . . .	—	500	lux
Faceplate temperature (storage or operation) . . . . .	−30	50	°C
Cathode pre-heating time . . . . .	60	—	s
Bias lamp voltage (r.m.s.) . . . . .	—	5.0	V
Bias lamp current . . . . .	—	250	mA

## TYPICAL OPERATION

### Operating Conditions (for scanned area 12.8 x 17.1mm)

Cathode voltage . . . . .	0	V
Grid 4 and grid 3 voltage . . . . .	550 to 600	V
Grid 2 voltage . . . . .	300	V
Grid 1 voltage for picture cut-off (with no blanking voltage on grid 1) . . . . .	−30 to −100	V
Blanking voltage (peak to peak):		
when applied to grid 1 (negative pulses) . . . . .	70	V min
when applied to cathode (positive pulses) . . . . .	25	V min
Signal electrode voltage (see note 7) . . . . .	45	V
Grid 2 current with normal beam currents . . . . .	0.5	mA max
Signal electrode bias current (see note 6) . . . . .	8.0	nA
Faceplate illumination . . . . .		see note 8
Faceplate temperature, operating . . . . .	20 to 45	°C
Highlight signal electrode current . . . . .	0.3	μA
Beam current . . . . .		see note 9
Dark current (without bias) . . . . .	1.0	nA

## Typical Performance

Amplitude response to a 400 TV line square wave test pattern at centre of picture (approx) . . . . .		see note 10
Resolution capability at centre of picture . . . . .	>600	TV lines
Visual equivalent signal to noise ratio (see note 11) . . . . .	200:1	approx
'Gamma' of transfer characteristic . . . . .	0.95 ± 0.05	
Lag (with 8nA bias current) (see note 12 and graph):		
after dark interval of 60ms . . . . .	2.0	%
after dark interval of 200ms . . . . .	0.3	%
Sensitivity (see note 13):		
P8004, P8004L . . . . .	>275	μA/lumen
P8004B . . . . .	>32	μA/lumen
P8004G . . . . .	>125	μA/lumen
P8004R . . . . .	>60	μA/lumen



## NOTES

1. This capacitance, which in effect forms the output impedance of the tube, is increased when the tube is inserted in the deflecting yoke and focusing coil assembly. Usually the increase is of the order of 5pF.
2. Failure of scanning or underscanning of the specified photosurface area must be avoided. The effects of internal reflections are reduced by masking the area outside the useful rectangle.
3. The vertical scan is parallel to the plane passing through the tube axis and the index mark on the tube base.
4. The base has tungsten pins and care must be taken when inserting the tube into a socket.
5. For very short periods only. In general, unnecessary strong illumination of the faceplate must be avoided to reduce risk of damage to the photosurface. For this reason, and to avoid mechanical damage the faceplate must be protected with the plastic cap provided whenever the tube is removed from the camera. When the camera is not in operation the lens must also be capped.

6. The signal electrode bias current is defined as the signal electrode current from the tube with the bias lamp operative but with no faceplate illumination. Typically, a supply of 4.2V at 220mA is required to achieve 8nA dark current.
7. For scenes of excessive contrast, operation is facilitated by using a signal electrode voltage of 25V. This may, however, degrade some operating parameters.
8. P8004 and P8004L typically require a faceplate illumination of 4 lux to produce a signal electrode current of 0.3 $\mu$ A. Tubes in the colour channels will give the signal currents specified in note 10 with an incident white level (2854K) on the appropriate filter of approx. 10 lux.
9. The beam current is adjusted to discharge a highlight signal current of 600nA for monochrome, luminance and green tubes, and 300nA for red and blue tubes.
10. The typical figures given below represent the horizontal amplitude response after correction for losses introduced by the optical system. Grid 3 and grid 4 voltage is adjusted for optimum focus in the range 550 to 650V.

	<b>P8004</b>	<b>P8004L</b>	<b>P8004B</b>	<b>P8004G</b>	<b>P8004R</b>
<b>Measurement Conditions</b>					
Highlight signal current	300	150	300	300	150 nA
Beam current set to discharge a signal of	600	300	600	600	300 nA
<b>Amplitude response for 400 TV lines</b>					
Typical . . . . .	40	50	40	40	35 %
Minimum . . . . .	35	45	35	35	30 %

11. The visual equivalent signal to noise ratio is taken as the ratio of the highlight signal output current to the r.m.s. noise current, multiplied by a factor of 3, assuming an r.m.s. noise current of the video pre-amplifier of 2nA, bandwidth 5MHz.
12. The lag is the percentage of the initial value of signal output current remaining after a dark interval with an initial highlight signal output current of 0.1 $\mu$ A and a white light source (2854K). Appropriate filters are used with the colour tubes (see note 13). The beam current setting will be as indicated in note 10.



13. With the faceplate illumination set to 4.54 lux (2854K tungsten light), the appropriate filter is inserted in the light path:

P8004B	Schott BG12	3mm thick
P8004G	Schott VG9	1mm thick
● P8004R	Schott OG2	3mm thick

## SETTING-UP PROCEDURE

- (a) Insert the tube in the camera, ensuring that the plane through the axis of the tube and the index mark on the base is parallel to the direction of the field scan. The socket must be fitted carefully to avoid damage to the base pins and excessive strains in the glass.
- (b) Cap the lens and close the iris.
- (c) Set the grid 1 voltage control for maximum negative bias and adjust the scanning amplitude controls so that a maximum area of the photoconductive layer will be scanned.
- (d) Switch on the camera equipment and allow it to warm up. Adjust the signal electrode voltage to the specified value. The heater must operate for at least one minute at 6.3V before proceeding to step g.
- (e) Adjust the monitor to produce a faint raster scanning the normal area.
- (f) Direct the camera at the scene to be televised and uncap the lens.
- (g) Decrease grid 1 voltage from its maximum negative value until a picture appears on the monitor, increasing the lens aperture if the picture is faint.
- (h) Adjust grid 4 and grid 3 voltage and the optical focus in turn to obtain the best focused picture.
- (j) Align the beam by adjusting the alignment fields so that the centre of the picture does not move as grid 4 and grid 3 voltage is varied.
- (k) Adjust the deflection amplitude and position to scan an area 12.8mm x 17.1mm. This is facilitated by the use of a perspex mask inscribed with circles 12.8mm and 17.1mm diameter, placed in contact and concentric with the faceplate of the tube. Light is allowed to fall on the photoconductive layer and an image of the rings is obtained on the monitor. No lens is necessary. The scan amplitude and centring controls are adjusted until the diameter of the larger circle is equal to the width of the raster and that of the smaller equal to the height.



- (m) Adjust the lens iris to obtain sufficient signal output and adjust the beam current to a value at which highlights are stabilized.

In order to improve the highlight handling capability of the tube and reduce highlight retention effects, it is customary to use a beam current sufficient to discharge a signal of double the working highlight level. This may be done by setting the beam to just discharge the highlights, with the lens iris opened one stop above the operating point. Some cameras incorporate an attenuator to assist in this process and the camera manufacturers' instructions are a guidance in this respect. Higher beam currents can be used if desired but a slight degradation in resolution, lag and geometry will result.

- (n) Check alignment, beam focus and optical focus.
- (p) If variable light bias is to be used, adjust bias lamp voltage to reduce lag to the required level and then reset the black level control. If signal electrode bias currents greater than 10nA are used, there may be some degradation in black shading.

- (q) During a prolonged period of standby the following procedure is recommended.

1. Cap camera lens.
2. Cut off beam by adjusting grid 1 voltage to maximum negative value.
3. Reduce heater voltage to approximately 4V.

To resume normal operation the above sequence of operations should be reversed, as follows:

1. Restore heater voltage to 6.3V.
2. Allow heater to operate at 6.3V for at least one minute.
3. Adjust grid 1 voltage (beam control) to restore beam current to the required level.
4. Uncap camera lens.

# TYPICAL LAG – BIAS CURRENT CHARACTERISTICS

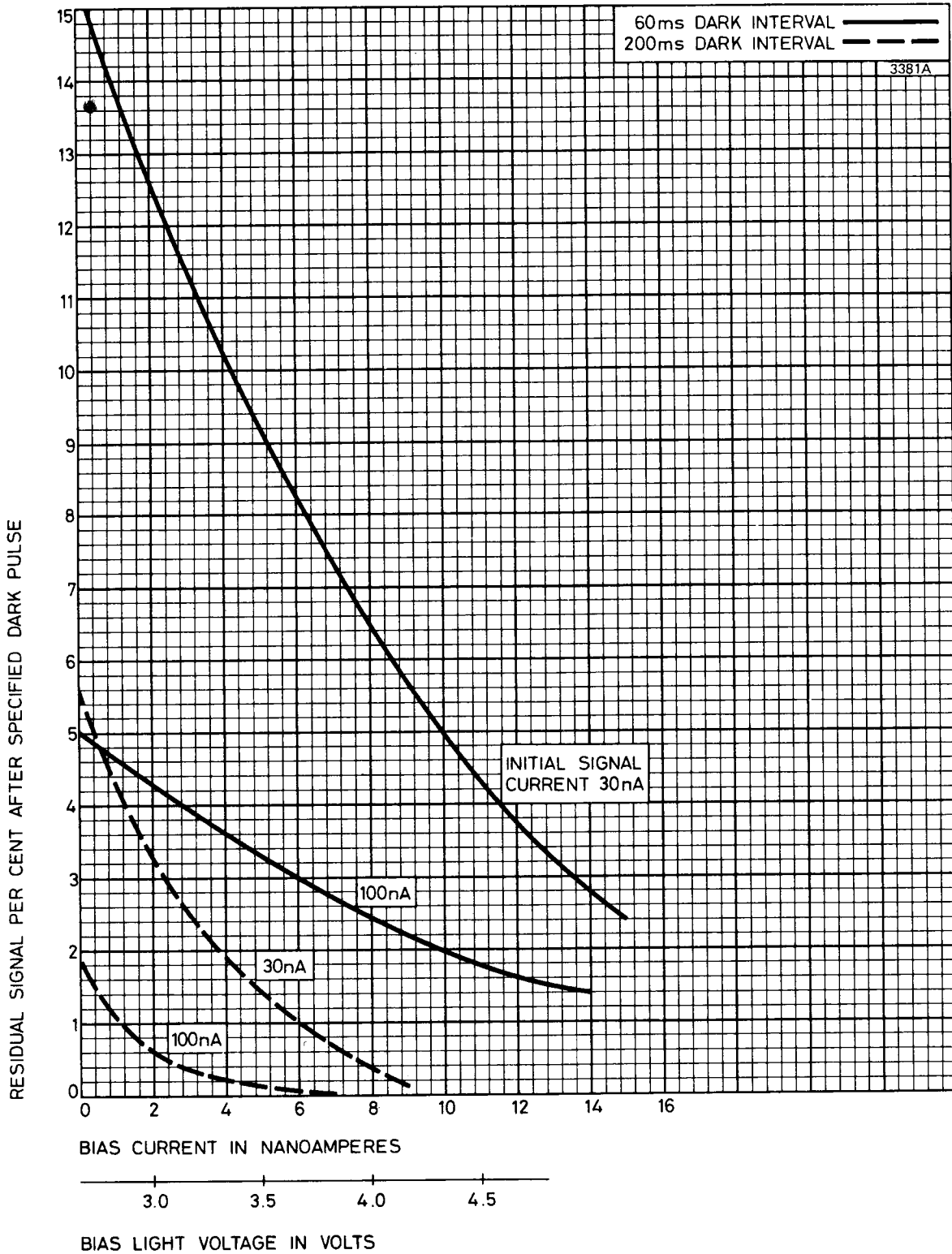

**Note** The relationship between bias lamp voltage and signal electrode bias current may vary from tube to tube.

**OUTLINE (All dimensions without limits are nominal)**

2599

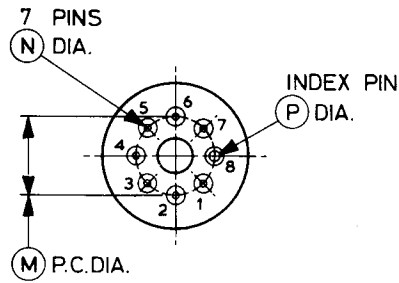
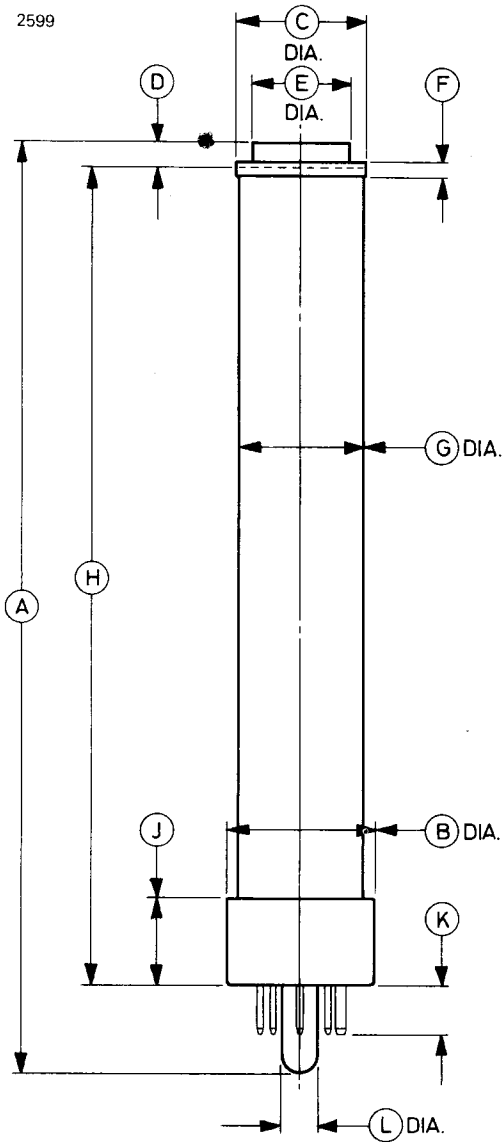

Pin	Element
1	Heater and bias lamp
2	No connection
3	Grid 3 and grid 4
4	Heater
5	Cathode
6	Grid 1
7	Grid 2
8	Bias lamp

**Note** The base passes a gauge 7mm thick with centre hole  $9.00 \pm 0.01$ mm diameter, seven holes  $1.750 \pm 0.005$ mm and one hole  $3.000 \pm 0.005$ mm diameter, within 0.01mm of true positions. The ends of the pins are tapered or rounded but not sharp.

Ref	Millimetres	Inches	Ref	Millimetres	Inches
A	220.0 max	8.661 max	H	$190.0 \pm 2.0$	$7.480 \pm 0.079$
B	$34.5 \pm 0.3$	$1.358 \pm 0.012$	J	$21.0 \pm 0.5$	$0.827 \pm 0.020$
C	30.6 max	1.205 max	K	11.0 max	0.433 max
D	$6.0 \pm 0.2$	$0.236 \pm 0.008$	L	8.7 max	0.343 max
E	$23.0 \pm 0.1$	$0.906 \pm 0.004$	M	18.0	0.709
F	$3.2 \pm 0.1$	$0.126 \pm 0.004$	N	1.50	0.059
G	$30.15 \pm 0.30$	$1.187 \pm 0.012$	P	$2.5 \pm 0.2$	$0.098 \pm 0.008$

Inch dimensions have been derived from millimetres.



# P8005 Series

## LEDDICON CAMERA TUBES WITH LIGHT BIAS FACILITY

---

### OBJECTIVE DATA

#### INTRODUCTION

The P8005 Series comprises 30mm diameter lead oxide camera tubes of separate mesh construction, featuring an internal light source to permit light biased operation. This facility is effective in controlling lag, the smearing of moving objects, seen particularly when operating under low light conditions. Ingress of stray light is prevented by an opaque lacquer coating on the tube envelope.



The tubes can be operated in three possible modes.

- 1) With bias light switched off.
- 2) With bias light operated at a fixed voltage not greater than 5.0V. Under these conditions the lamp can be operated in parallel with the heater by suitable connections at the camera socket, via a resistor, provided the camera power supplies are adequate.
- 3) With variable light bias individually adjustable to match the lag characteristics of each channel. Under these conditions colour fringing of moving objects will be minimized.

---

November 1972

## TYPES AVAILABLE

The following types are available:

Type	Application
P8005	Monochrome cameras
P8005L	Luminance channel of colour cameras
P8005B	Blue channel of colour cameras
P8005G	Green channel of colour cameras
P8005R	Red channel of colour cameras

## GENERAL

### Electrical

Cathode . . . . .	indirectly heated
Heater voltage . . . . .	$6.3 \pm 5\%$ V
Heater current at 6.3V . . . . .	$95 \pm 10\%$ mA
Bias lamp voltage . . . . .	5.0 V max
Inter-electrode capacitance:	
signal electrode to all other electrodes (see note 1) . . . . .	3.0 to 6.0 pF
Focusing method . . . . .	magnetic
Deflection method . . . . .	magnetic
Peak spectral response . . . . .	500 nm approx

### Mechanical

Overall length . . . . .	220mm (8.660 inches) max
Bulb diameter . . . . .	30.45mm (1.200 inches) max
Useful size of photosurface image (see note 2) . . . . .	12.8 x 17.1mm
Orientation of photosurface image . . . . .	see note 3
Net weight . . . . .	100g approx
Mounting position . . . . .	any
Base . . . . .	see note 4 and outline

### Storage and Handling Recommendations

- a) For storage, handling or transport the longitudinal axis of the tube must be either vertical with the faceplate uppermost, or horizontal.

- b) The faceplate must be covered at all times with the plastic cap provided. Unnecessary exposure to illumination may cause deterioration of the photosurface.
- c) The ambient temperature during storage must not exceed 30°C.
- d) It is undesirable to store the tube for extended periods without use. To avoid deterioration each tube should be operated for several hours each month, in an overscanned condition with the photosurface illuminated evenly, a signal current of 150nA and beam set to discharge 300nA.
- e) Care must be taken to avoid damaging the opaque coating on the tube envelope.

### LIGHT BIAS OPERATION

The light bias lamp is connected internally between pin 1 (heater) and pin 8 (index). The supply to the lamp can be a.c. or d.c. but d.c. is preferable as it can easily be stabilized and decoupled. The maximum voltage and current ratings of 5.0V and 250mA must not be exceeded under any conditions. The light bias should be adjusted on individual tubes to minimize differential lag; the required value of light bias dark current for each tube will vary according to the type of camera, colour temperature of the scene illuminant, etc. One method of obtaining the required supplies is to use the stabilized camera tube heater supply. This method is possible if the tube heater supply is capable of delivering 1.0A at 6.3V (3 tube camera) or 1.3A at 6.3V (4 tube camera). A suggested circuit is shown below.

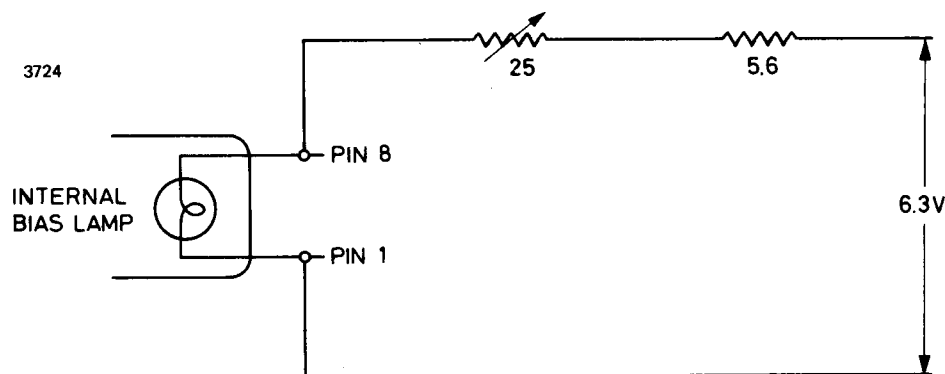

**Warning** The light bias connection to pin 8 must be disconnected before a standard Leddicon without light bias can be inserted. The reason for this is that pin 8 of the standard tube is connected internally to grid 1.

## MAXIMUM AND MINIMUM RATINGS (Absolute values)

	Min	Max	
Signal electrode voltage . . . . .	—	50	V
Grid 4 (mesh) voltage . . . . .	—	1100	V
Grid 3 voltage . . . . .	—	800	V
Grid 4 to grid 3 voltage . . . . .	—	350	V
Grid 2 voltage . . . . .	—	450	V
Grid 1 voltage:			
positive bias . . . . .	—	0	V
negative bias . . . . .	—	125	V
Cathode current . . . . .	—	3.0	mA
Peak heater to cathode voltage:			
heater negative with respect to cathode . . . . .	—	125	V
heater positive with respect to cathode . . . . .	—	10	V
Peak illumination of faceplate (see note 5) . . . . .	—	500	lux
Faceplate temperature (storage or operation) . . . . .	−30	50	°C
Cathode pre-heating time . . . . .	60	—	s
Bias lamp voltage (r.m.s.) . . . . .	—	5.0	V
Bias lamp current . . . . .	—	250	mA

## TYPICAL OPERATION

### Operating Conditions (for scanned area 12.8 x 17.1mm)

Cathode voltage . . . . .	0	V
Grid 4 (mesh) voltage . . . . .	550 to 650	V
Grid 4 to grid 3 voltage (see note 7) . . . . .	50 to 100	V
Grid 2 voltage . . . . .	300	V
Grid 1 voltage for picture cut-off (with no blanking voltage on grid 1) . . . . .	−30 to −100	V
Blanking voltage (peak to peak):		
when applied to grid 1 (negative pulses) . . . . .	70	V min
when applied to cathode (positive pulses) . . . . .	25	V min
Signal electrode voltage (see note 8) . . . . .	45	V
Grid 2 current with normal beam currents . . . . .	0.5	mA max
Signal electrode bias current (see note 6) . . . . .	8	nA
Faceplate illumination . . . . .		see note 9
Faceplate temperature, operating . . . . .	20 to 45	°C
Highlight signal electrode current . . . . .	0.3	μA
Beam current . . . . .		see note 10
Dark current (without bias) . . . . .	1.0	nA



## Typical Performance

Amplitude response to a 400 TV line square wave test pattern at centre of picture (approx)		see note 11
Resolution capability at centre of picture	>600	TV lines
Visual equivalent signal to noise ratio (see note 12)	200:1	approx
'Gamma' of transfer characteristic	0.95 ± 0.05	
Lag (with 8nA bias current) (see note 13 and graph):		
after dark interval of 60ms	2.0	%
after dark interval of 200ms	0.3	%
Sensitivity (see note 14):		
P8005, P8005L	>275	μA/lumen
P8005B	>32	μA/lumen
P8005G	>125	μA/lumen
P8005R	>60	μA/lumen

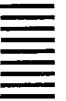

## NOTES

1. This capacitance, which in effect forms the output impedance of the tube, is increased when the tube is inserted in the deflecting yoke and focusing coil assembly. Usually the increase is of the order of 5pF.
2. Failure of scanning or underscanning of the specified photosurface area must be avoided. The effects of internal reflections are reduced by masking the area outside the useful rectangle.
3. The horizontal scan is parallel to the plane passing through the tube axis and the index pin on the tube base.
4. The base has tungsten pins and care must be taken when inserting the tube into a socket.
5. For very short periods only. In general, unnecessary strong illumination of the faceplate must be avoided to reduce risk of damage to the photosurface. For this reason, and to avoid mechanical damage the faceplate must be protected with the plastic cap provided whenever the tube is removed from the camera. When the camera is not in operation the lens must also be capped.

6. The signal electrode bias current is defined as the signal electrode current from the tube with the bias lamp operative but with no faceplate illumination. Typically, a supply of 4.2V at 220mA is required to achieve 8nA dark current.
7. Operation with grid 4 at a higher voltage than grid 3 gives improved corner resolution. The optimum ratio of grid 4 to grid 3 voltage depends upon the coil assembly used.
8. For scenes of excessive contrast, operation is facilitated by using a signal electrode voltage of 25V. This may, however, degrade some operating parameters.
9. P8005 and P8005L typically require a faceplate illumination of 4 lux to produce a signal electrode current of 0.3 $\mu$ A. Tubes in the colour channels will give the signal currents specified in note 11 with an incident white level (2854K) on the appropriate filter of approx. 10 lux.
10. The beam current is adjusted to discharge a highlight signal current of 600nA for monochrome, luminance and green tubes, and 300nA for red and blue tubes.
11. The typical figures given below represent the horizontal amplitude response after correction for losses introduced by the optical system. Grid 3 and grid 4 voltages are adjusted for optimum focus.

	<b>P8005</b>			
	<b>P8005L</b>	<b>P8005B</b>	<b>P8005G</b>	<b>P8005R</b>
<b>Measurement Conditions</b>				
Highlight signal current	300	150	300	150 nA
Beam current set to discharge a signal of	600	300	600	300 nA
<b>Amplitude response for 400TV lines (grid 4 at 550 to 650V)</b>				
Typical . . . . .	40	50	40	35 %
Minimum . . . . .	35	45	35	30 %

12. The visual equivalent signal to noise ratio is taken as the ratio of the highlight signal output current to the r.m.s. noise current, multiplied by a factor of 3, assuming an r.m.s. noise current of the video pre-amplifier of 2nA, bandwidth 5MHz.
13. The lag is the percentage of the initial value of signal output current remaining after a dark interval with an initial highlight signal output

current of  $0.1\mu\text{A}$  and a white light source (2854K). Appropriate filters are used with the colour tubes (see note 14). The beam current setting will be as indicated in note 11.

14. With the faceplate illumination set to 4.54 lux (2854K tungsten light), the appropriate filter is inserted in the light path:

P8005B	Schott BG12	3mm thick
P8005G	Schott VG9	1mm thick
P8005R	Schott OG2	3mm thick

### SETTING-UP PROCEDURE

- (a) Insert the tube in the camera, ensuring that the plane through the axis of the tube and the index pin on the base is parallel to the direction of the line scan. The socket must be fitted carefully to avoid damage to the base pins and excessive strains in the glass.
- (b) Cap the lens and close the iris.
- (c) Set the grid 1 voltage control for maximum negative bias and adjust the scanning amplitude controls so that a maximum area of the photoconductive layer will be scanned.
- (d) Switch on the camera equipment and allow it to warm up. Adjust the signal electrode voltage to the specified value. The heater must operate for at least one minute at 6.3V before proceeding to step g.
- (e) Adjust the monitor to produce a faint raster scanning the normal area.
- (f) Direct the camera at the scene to be televised and uncap the lens.
- (g) Decrease grid 1 voltage from its maximum negative value until a picture appears on the monitor, increasing the lens aperture if the picture is faint.
- (h) Adjust grid 4 and grid 3 voltages and the optical focus in turn to obtain the best focused picture.
- (j) Align the beam by adjusting the alignment fields so that the centre of the picture does not move as grid 4 and grid 3 voltages are varied.
- (k) Adjust the deflection amplitude and position to scan an area 12.8mm x 17.1mm. This is facilitated by the use of a perspex mask inscribed with circles 12.8mm and 17.1mm diameter, placed in contact and concentric with the faceplate of the tube. Light is allowed to fall on the photoconductive layer and an image of the rings is obtained on the



monitor. No lens is necessary. The scan amplitude and centring controls are adjusted until the diameter of the larger circle is equal to the width of the raster and that of the smaller equal to the height.

- (m) Adjust the lens iris to obtain sufficient signal output and adjust the beam current to a value at which highlights are stabilized.

In order to improve the highlight handling capability of the tube and reduce highlight retention effects, it is customary to use a beam current sufficient to discharge a signal of double the working highlight level. This may be done by setting the beam to just discharge the highlights, with the lens iris opened one stop above the operating point. Some cameras incorporate an attenuator to assist in this process and the camera manufacturers' instructions are a guidance in this respect. Higher beam currents can be used if desired but a slight degradation in resolution, lag and geometry will result.

- (n) Check alignment, beam focus and optical focus.
- (p) If variable light bias is to be used, adjust bias lamp voltage to reduce lag to the required level and then reset the black level control. If signal electrode bias currents greater than 10nA are used, there may be some degradation in black shading.
- (q) During a prolonged period of standby the following procedure is recommended.

1. Cap camera lens.
2. Cut off beam by adjusting grid 1 voltage to maximum negative value.
3. Reduce heater voltage to approximately 4V.

To resume normal operation the above sequence of operations should be reversed, as follows:

1. Restore heater voltage to 6.3V.
2. Allow heater to operate at 6.3V for at least one minute.
3. Adjust grid 1 voltage (beam control) to restore beam current to the required level.
4. Uncap camera lens.

# TYPICAL LAG – BIAS CURRENT CHARACTERISTICS

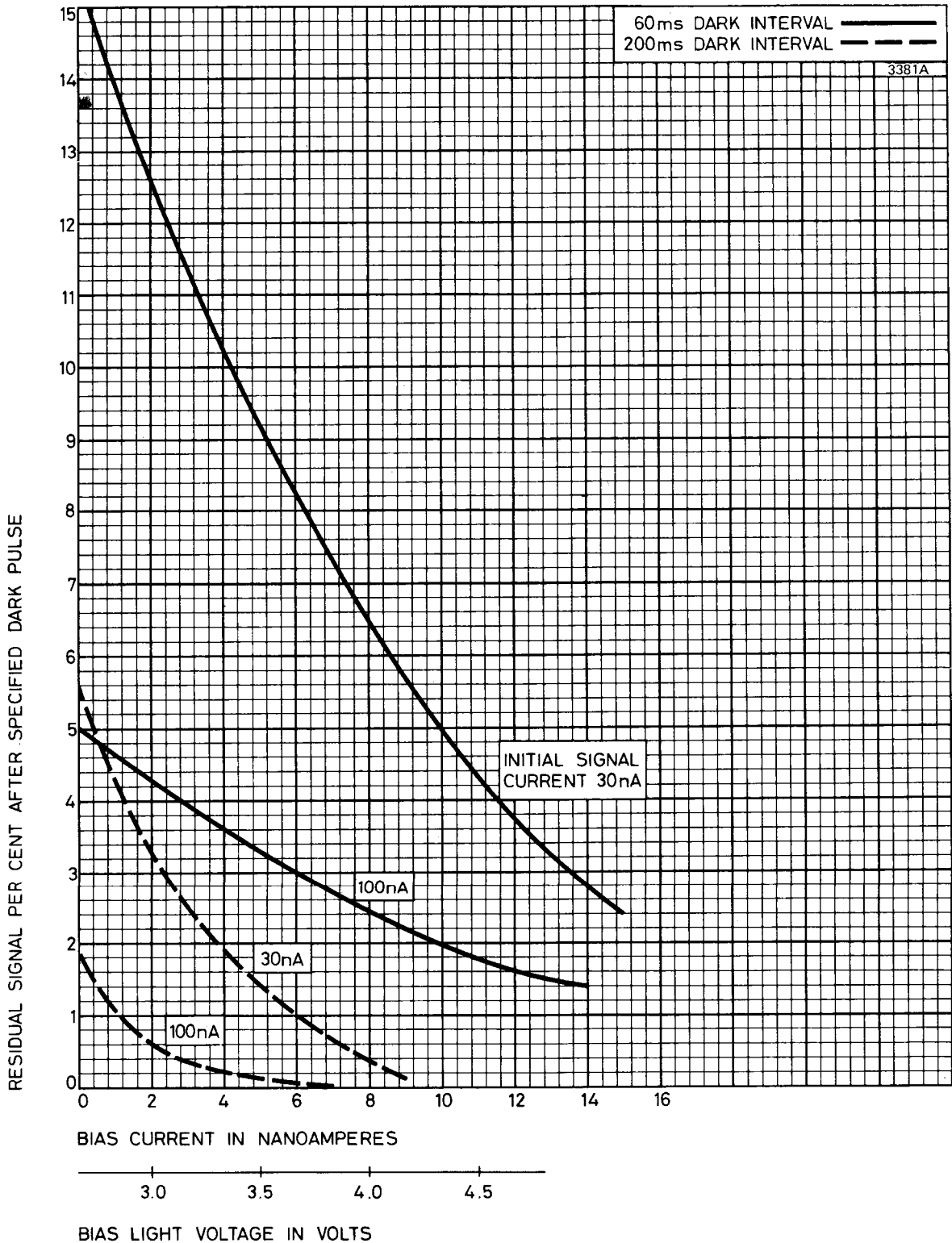

**Note** The relationship between bias lamp voltage and signal electrode bias current may vary from tube to tube.

# OUTLINE (All dimensions without limits are nominal)

2599

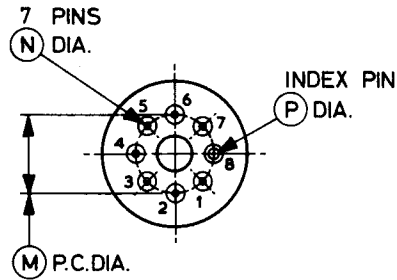
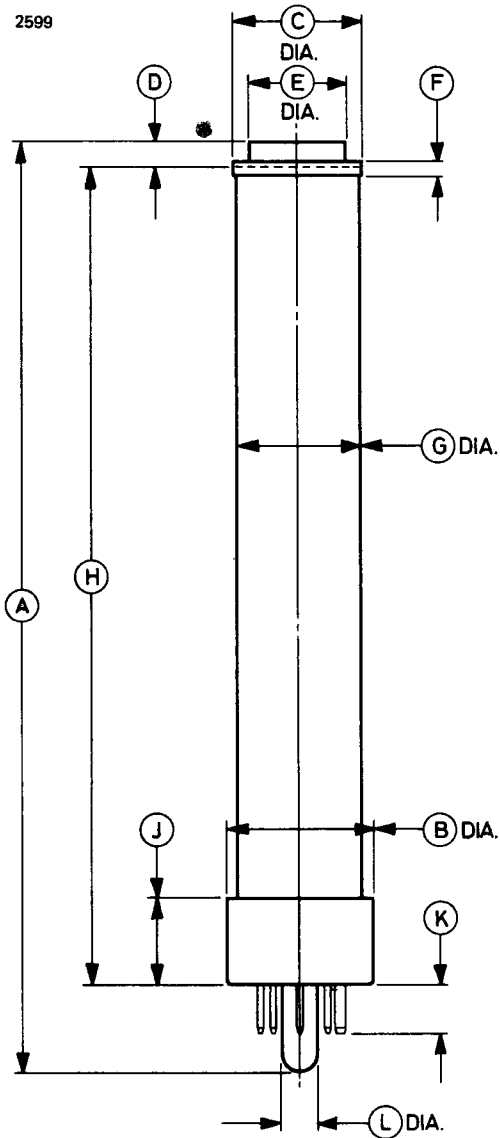

Pin	Element
1	Heater and bias lamp
2	Grid 4 (mesh)
3	Grid 3
4	Heater
5	Cathode
6	Grid 1
7	Grid 2
8	Bias lamp

**Note** The base passes a gauge 7mm thick with centre hole  $9.00 \pm 0.01$ mm diameter, seven holes  $1.750 \pm 0.005$ mm and one hole  $3.000 \pm 0.005$ mm diameter, within 0.01mm of true positions. The ends of the pins are tapered or rounded but not sharp.

Ref	Millimetres	Inches	Ref	Millimetres	Inches
A	220.0 max	8.661 max	H	$190.0 \pm 2.0$	$7.480 \pm 0.079$
B	$34.5 \pm 0.3$	$1.358 \pm 0.012$	J	$21.0 \pm 0.5$	$0.827 \pm 0.020$
C	30.6 max	1.205 max	K	11.0 max	0.433 max
D	$6.0 \pm 0.2$	$0.236 \pm 0.008$	L	8.7 max	0.343 max
E	$23.0 \pm 0.1$	$0.906 \pm 0.004$	M	18.0	0.709
F	$3.2 \pm 0.1$	$0.126 \pm 0.004$	N	1.50	0.059
G	$30.15 \pm 0.30$	$1.187 \pm 0.012$	P	$2.5 \pm 0.2$	$0.098 \pm 0.008$

Inch dimensions have been derived from millimetres.

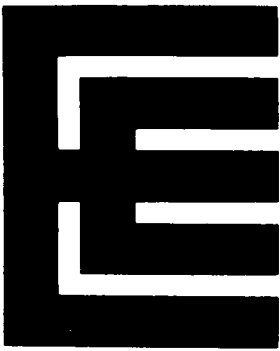

# P8021 Series

LEDDICON  
CAMERA TUBES

## ABRIDGED DATA

The P8021 series comprises 1-inch diameter camera tubes of separate mesh construction, with lead oxide photoconductive layers. They feature very short lag, high sensitivity and low dark current, and are mechanically interchangeable with 1-inch separate mesh vidicons.

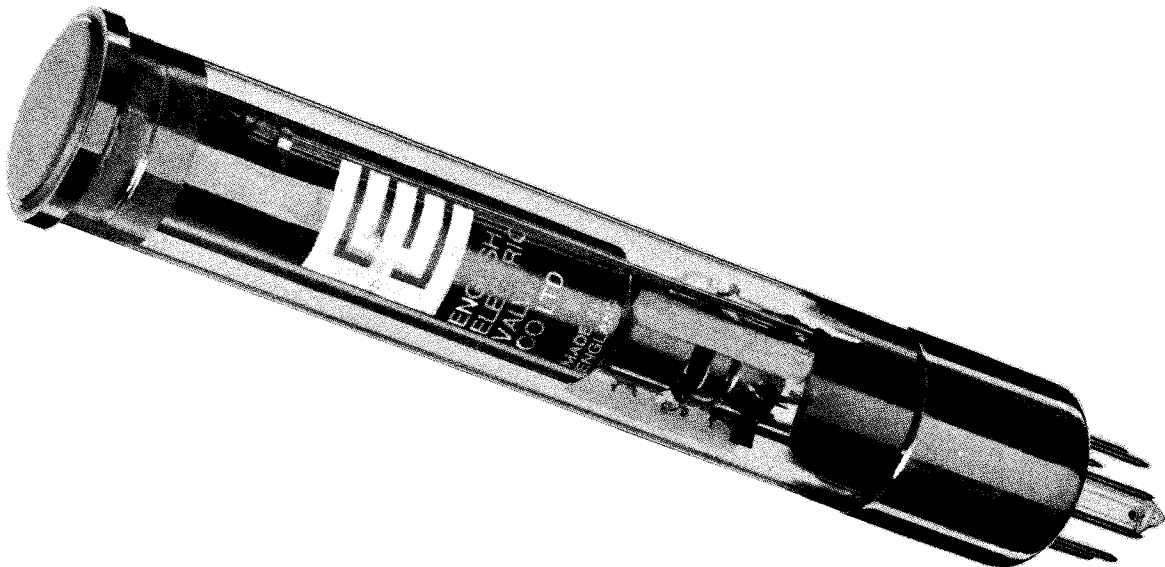

Type	Application		
P8021	Monochrome cameras		
P8021L	Luminance channel of colour cameras		
P8021B	Blue channel of colour cameras		
P8021G	Green channel of colour cameras		
P8021R	Red channel of colour cameras		
Dark current . . . . .		3.0	nA max
Limiting resolution . . . . .		>600	TV lines
Peak spectral response . . . . .		470	nm approx

December 1972

## GENERAL

### Electrical

Cathode . . . . .	indirectly heated
Heater voltage . . . . .	$6.3 \pm 5\%$ V
Heater current at 6.3V . . . . .	$95 \pm 10\%$ mA
Inter-electrode capacitance:	
signal electrode to all other electrodes (see note 1) . . . . .	3.5 to 5.5 pF
Focusing method . . . . .	magnetic
Deflection method . . . . .	magnetic

### Mechanical

Size of quality rectangle on photoconductive layer (see note 2) . . . . .	12.8 x 9.6mm
Orientation of quality rectangle . . . . .	by means of index pin (see note 3)
Net weight . . . . .	60 g approx
Mounting position . . . . .	any
Base . . . . .	see Outline
Mating socket . . . . .	Type R41-79502 by United Carr Fasteners Ltd. (or equivalent)

### Storage and Handling Recommendations

- a) For storage, handling or transport the longitudinal axis of the tube must be either vertical with the faceplate uppermost, or horizontal.
- b) The faceplate should be covered at all times with the plastic cap provided. Exposure to illumination unnecessarily may cause deterioration of the photosurface.
- c) The temperature during storage should not exceed 30°C.



d) It is undesirable to store the tube for extended periods without use. To avoid deterioration each tube should be operated for several hours each month, in an overscanned condition with the target illuminated evenly at a light level sufficient to produce a signal current of 150nA. When a tube is to be used after a period of storage it may be necessary to carry out the same procedure, before optimum performance can be obtained.

### WARNING

A surge limiting device must be incorporated if necessary to ensure that the heater current does not exceed 150mA when switching on or at any other time.

### MAXIMUM AND MINIMUM RATINGS (Absolute values)

No individual rating should be exceeded

	Min	Max	
Signal electrode voltage . . . . .	—	50	V
Grid 4 (mesh) voltage . . . . .	—	1100	V
Grid 3 voltage . . . . .	—	800	V
Grid 4 to grid 3 voltage . . . . .	—	450	V
Grid 2 voltage . . . . .	—	350	V
Grid 1 voltage:			
positive bias . . . . .	—	0	V
negative bias . . . . .	—	125	V
Cathode current . . . . .	—	3.0	mA
Peak heater to cathode voltage:			
heater negative with respect to cathode . . . . .	—	50	V
heater positive with respect to cathode . . . . .	—	125	V
Peak illumination of faceplate (see note 4) . . . . .	—	500	lux
		46.5	ft-candle
Faceplate temperature (storage or operation)	—30	50	°C
Ambient temperature (storage or operation)	—30	50	°C
Cathode heating time . . . . .	60	—	s

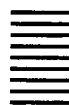

**TYPICAL OPERATING CONDITIONS** (for scanned area 12.8 x 9.6mm)

Cathode voltage . . . . .	0	V
Grid 4 (mesh) voltage . . . . .	850	V
Grid 4 to grid 3 voltage (see note 5) . . . . .	250	V
Grid 2 voltage . . . . .	300	V
Grid 1 voltage for picture cut-off (with no blanking voltage on grid 1) . . . . .	-30 to -100	V
Blanking voltage (peak to peak):		
when applied to grid 1 (negative pulses) . . . . .	70	V min
when applied to cathode (positive pulses) . . . . .	25	V min
Signal electrode voltage (see note 6) . . . . .	45	V
Grid 2 current with normal beam currents . . . . .	1.0	mA max
Dark current . . . . .	<3.0	nA
Faceplate illumination . . . . .		see note 7
Faceplate temperature (operating) . . . . .	20 to 45	°C
Beam current . . . . .		see note 8
Amplitude response to a 400 TV line square wave test pattern at centre of picture (approx) . . . . .		see note 9
Limiting resolution at centre of picture . . . . .	>600	TV lines
'Gamma' of transfer characteristic . . . . .	0.95 ± 0.05	
Lag (see note 10):		
	P8021B	P8021L,G,R
after dark pulse of 60ms . . . . .	6.0	5.0 % max
after dark pulse of 200ms . . . . .	3.0	2.0 % max
Sensitivity (see note 11):		
P8021, P8021L . . . . .	>275	μA/lumen
P8021B . . . . .	>32	μA/lumen
P8021G . . . . .	>125	μA/lumen
P8021R . . . . .	>60	μA/lumen

**NOTES**

1. This capacitance, which effectively is the output impedance of the tube, is increased by approximately 5pF when the tube is inserted in the deflecting yoke and focusing coil assembly.
2. Failure of scanning or underscanning of the specified quality rectangle should be avoided. The area outside the quality rectangle should be masked to reduce the effects of internal reflections. The amplitude and position of scan should be adjusted so that the mesh ring does not appear in the corner of the picture.
3. The horizontal scan should be parallel to the plane passing through the tube axis and the index pin on the tube base.

4. For very short periods only. In general, unnecessary strong illumination of the faceplate should be avoided, to reduce risk of damage to the photolayer. For this reason, the faceplate must be covered with the plastic cap provided, whenever the tube is removed from the camera. When the camera is not in operation the lens is also capped.
5. Operation with grid 4 at a higher voltage than grid 3 gives improved corner resolution. The optimum ratio of grid 4 to grid 3 voltage depends upon the coil assembly used.
6. The tube is specified for operation at a target voltage of 45V. The televising of a scene of excessive contrast may be facilitated by operation at a target voltage of 25V; this may lead to a slight degradation in performance.

If the P8021 is fitted in a camera intended for vidicon tubes, the automatic sensitivity control should be by-passed and the signal electrode voltage made variable between 25 and 45V.

7. P8021 and P8021L typically require a faceplate illumination of 5 lux to produce a signal electrode current of  $0.2\mu\text{A}$ . The colour tubes will give the signal currents specified in note 9 with an incident white level (2854K) on the appropriate filter of approx. 12.5 lux.
8. The beam current is adjusted to discharge a highlight signal current of 400nA for monochrome, luminance and green tubes, and 200nA for red and blue tubes.
9. The typical figures given below represent the horizontal amplitude response after correction for optical system faults. Grid 3 and grid 4 voltages are adjusted for optimum focus.

	P8021	P8021B	P8021G	P8021R
Highlight signal current	200	100	200	100 nA
Beam set to discharge a signal current of	400	200	400	200 nA
Amplitude response (grid 4 at 850V)	30	35	30	25 %

10. Percentage of initial value of signal output current remaining after a dark pulse. Initial highlight signal output current of  $0.1\mu\text{A}$  and with a white light source (2854K). Appropriate filters used with colour tubes. The beam current setting will be as indicated in note 9.
11. With faceplate illumination set to 8.15 lux (2854K tungsten light), the appropriate filter is inserted in the light path:

P8021B	Schott BG12	3mm thick
P8021G	Schott VG9	1mm thick
P8021R	Schott OG2	3mm thick

## SETTING-UP PROCEDURE

- a. Insert the tube in the camera, ensuring that the plane through the axis of the tube and the index pin of the base is parallel to the direction of the line scan. Make connection to the base pins.
- b. Cap the lens and close the iris.
- c. Set the grid 1 voltage for maximum negative bias for picture cut-off and adjust the signal electrode voltage to the specified value. Adjust the scanning amplitude controls so that a maximum area of the photoconductive layer will be scanned.
- d. Switch on the camera equipment and allow it to warm up. The heater must operate for at least one minute at 6.3V before proceeding to step g.
- e. Adjust the monitor to produce a faint non-overscanned raster.
- f. Direct the camera at the scene to be televised and uncap the lens.
- g. Decrease grid 1 voltage from its maximum negative value until a picture appears on the monitor, increasing the lens aperture if the picture is faint.
- h. Adjust grid 4 and grid 3 voltages and the optical focus alternately to obtain the best focused picture.
- j. Align the beam by adjusting the alignment fields so that the centre of the picture does not move as grid 4 and grid 3 voltages are varied.
- k. Adjust the deflection controls to scan an area 12.8mm x 9.6mm.
- m. Adjust the lens iris to obtain sufficient signal output and adjust the beam current to a value at which highlights are stabilized.

In order to improve the highlight handling capability of the tube and reduce highlight retention effects, it is customary to use a beam current sufficient to discharge a signal double the working highlight level. This may be done by setting the beam to just discharge the highlights, with the lens iris opened one stop from the operating point. Some cameras incorporate an attenuator to assist in this process and the camera manufacturers' instructions must be consulted before making this adjustment. Still higher beam currents can be used but may produce slight degradation in resolution, lag and geometry.

- n. Check alignment, beam focus and optical focus.
- p. During a long standby period the following procedure is recommended.
  1. Cap camera lens.
  2. Cut-off beam by adjusting grid 1 voltage to maximum negative value.
  3. Reduce heater voltage to approximately 4V.

To resume normal operation the above sequence of operations is reversed.

1. Restore heater voltage to 6.3V.
2. Allow heater to operate at 6.3V for at least one minute.
3. Adjust grid 1 voltage (beam control) to restore beam current to the required level.
4. Uncap camera lens.

# TYPICAL SPECTRAL SENSITIVITY CHARACTERISTIC

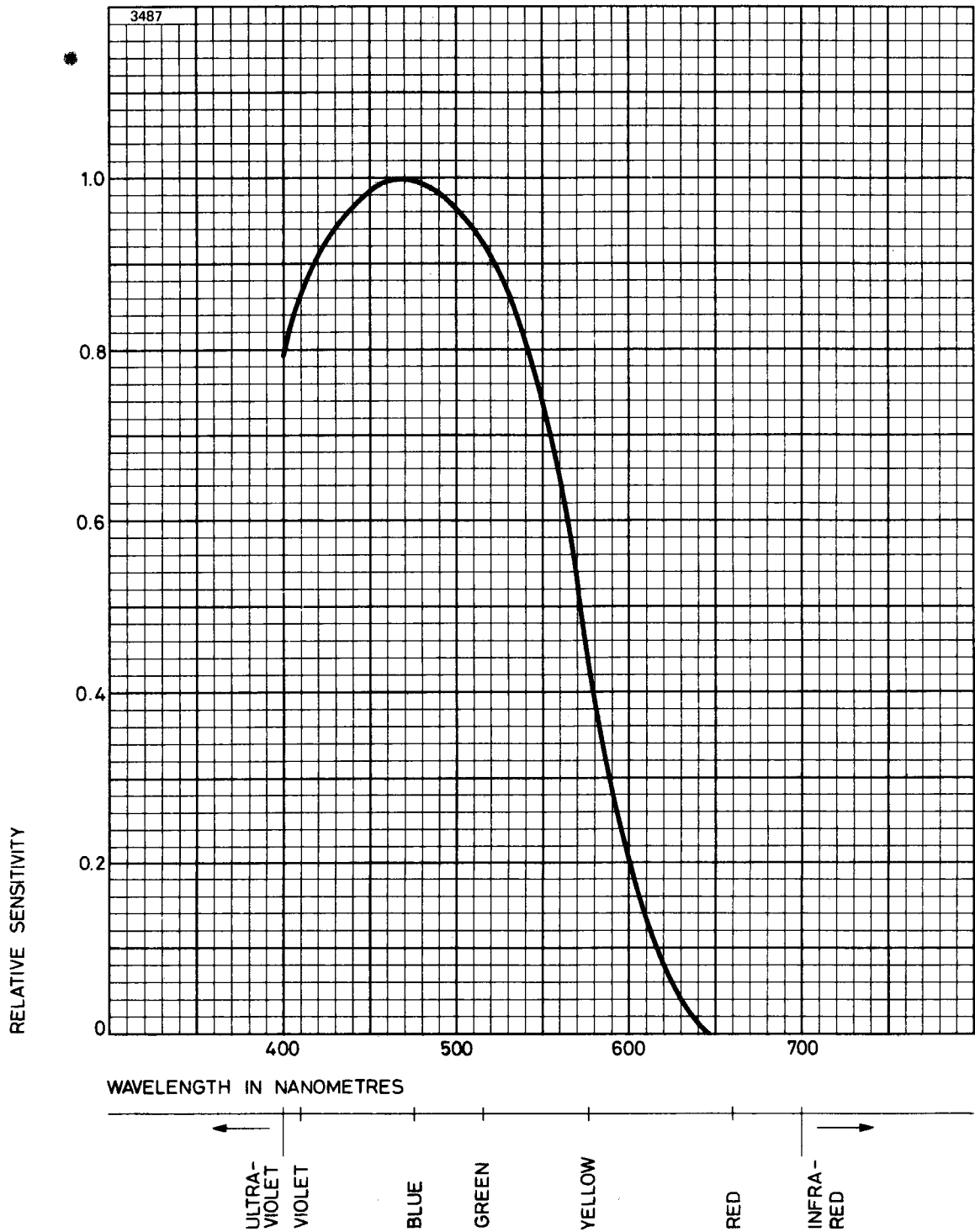

**OUTLINE (All dimensions without limits are nominal)**

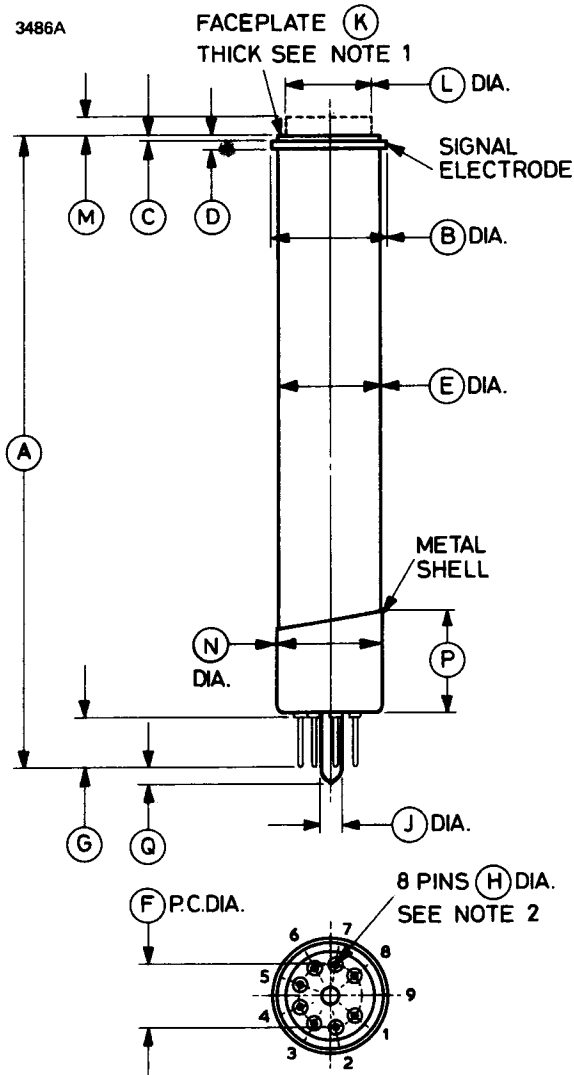

Pin	Element
1	Heater
2	Grid 1
3	Grid 4
4	Internal connection
5	Grid 2
6	Grid 3
7	Cathode
8	Heater
9	Key pin position, blank
Flange	Signal electrode

**Notes**

1. The tube can be supplied with an anti-halation disc (broken lines).
2. The base conforms to JEDEC E8-11 except for the seal-off length.

Ref	Millimetres	Inches	Ref	Millimetres	Inches
A	158.0 ± 4.0	6.220 ± 0.158	J*	6.73 max	0.265 max
B	28.4 ± 0.2	1.118 ± 0.008	K	1.2 ± 0.05	0.047 ± 0.002
C	1.3 ± 0.1	0.051 ± 0.004	L	20.4 max	0.803 max
D	4.3	0.169	M	5.0 ± 0.1	0.197 ± 0.004
E	25.5 ± 0.5	1.004 ± 0.020	N	26.6 max	1.047 max
F*	15.24	0.600	P	26.0 max	1.024 max
G*	12.77 max	0.503 max	Q	3.0 max	0.118 max
H*	1.27 + 0.05 - 0.10	0.050 + 0.002 - 0.004			

Inch dimensions have been derived from millimetres except where indicated thus \*.

# Sidicons







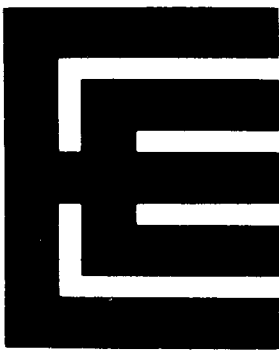

---

### OBJECTIVE DATA

#### INTRODUCTION

The sidicon incorporates a silicon diode array target in a standard 1-inch vidicon envelope. It is sensitive to visible and near infra-red light, and offers the following advantages over conventional vidicons.

- Unaffected by extreme light overload
- No photoconductive lag
- Unaffected by scan failure
- Unity gamma characteristic
- Much higher sensitivity
- Longer life

Most vidicons in the EEV range of standard 1-inch tubes can be manufactured with a silicon diode array target and the company invites enquiries for other types.

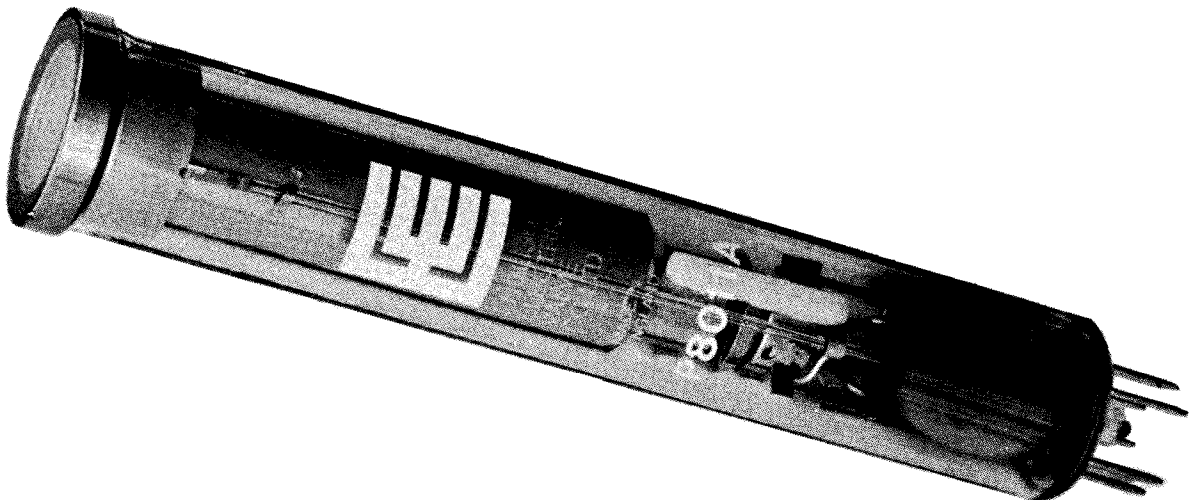

The P8011 uses conventional magnetic focusing and deflection, is of separate mesh construction and has a low power heater. It has high sensitivity throughout the visible and near infra-red spectrum, and produces high contrast pictures with a low operating dark current.

## TYPICAL PERFORMANCE

Spectral response . . . . .	see curve on page 7	
Sensitivity (see note 1) . . . . .	>4000	$\mu\text{A/lumen}$
Gamma of operating characteristic . . . . .		unity
Dark current (see note 2):		
typical . . . . .	25	nA
maximum . . . . .	40	nA
Limiting resolution . . . . .	650	TV lines
Amplitude response at 400 TV lines . . . . .	30	%
Lag (capacitive) (see note 3) . . . . .	$\leq 8$	%

## OPERATING CONDITIONS (See Note 4) (for scanned area 0.5 x 0.375 inch)

Heater voltage . . . . .	6.3	V
Heater current . . . . .	95	mA
Target voltage (see note 2):		
typical . . . . .	20	V
range . . . . .	10 to 40	V
Grid 4 (mesh) voltage . . . . .	350	V max
Grid 3 (beam focus) voltage (typical) . . . . .	300	V
Grid 2 (accelerator) voltage . . . . .	300	V
Grid 1 voltage . . . . .	-30 to -70	V
Focus coil . . . . .	Cleveland Electronics VF-115-12	
Deflection yoke . . . . .	Cleveland Electronics VY-111-3	
Alignment coil . . . . .	Cleveland Electronics VA-118	

## Orientation of Picture Area

The horizontal scan should be parallel to the plane through the tube axis and the blank key pin position on the base.

## PICTURE BLEMISHES

Tubes are graded according to the blemish content, as shown in the table on page 3. Under typical operating conditions, the number and size of spurious signal spots as represented by an equivalent number of raster lines in a 625 TV line system with an aspect ratio of 4:3, conform to the limits shown. To be classified as a white spot, the amplitude of the spurious signal from it with the lens capped must be at least 10% of the peak white signal, and for a black spot 10% of peak white when viewing a uniformly illuminated white scene.

Spot size in TV lines	Maximum Number					
	Zone 1		Zone 2		Zone 3	
	white	black	white	black	white	black
<b>P8011A</b>						
>4	0	0	0	0	0	2
>1	0	0	1	2	2	3
<b>P8011B</b>						
>4	0	0	0	0	1	4
>1	1	2	3	5	5	8
<b>P8011C</b>						
>4	1	2	2	4	4	8
>1	2	5	8	12	10	15

No spot will exceed 6 TV lines.

Zones are defined as:—

Zone 1 is the area inside a circle of diameter 50% of picture height central on the axis.

Zone 2 is the annular area outside zone 1 but inside a circle of diameter equal to the picture height central on the axis.

Zone 3 is the remainder of the picture.

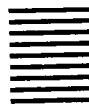

### GENERAL NOTES ON THE USE OF SIDICONS

The sidicon has unity gamma and its sensitivity is not affected by changes in target voltage. Automatic sensitivity control facilities in conventional vidicon cameras must be switched off or disconnected when using this tube. The grid 4 voltage must also be limited to 350V and this may require modifications to the camera. EEV or the camera manufacturer should be consulted regarding camera modifications.

Although the diode array target is not mounted directly on the faceplate of the tube, the range of lens focus control in conventional vidicon cameras is adequate for use with sidicons.

## SETTING UP PROCEDURE

- a. Insert the tube in the camera, ensuring that the plane through the axis of the tube and the key pin position is parallel to the direction of the line scan. Make connection to the base pins.
- b. Cap the lens and close the iris.
- c. Set the grid 1 voltage for maximum negative bias for picture cut-off and adjust the target voltage to the specified value. Adjust the scanning amplitude controls so that a maximum area of the photoconductive layer will be scanned.
- d. Switch on the camera equipment and allow it to warm up. The heater must operate for at least one minute at 6.3V before proceeding to step g.
- e. Adjust the monitor to produce a faint non-overscanned raster.
- f. Direct the camera at the scene to be televised and uncap the lens.
- g. Decrease grid 1 voltage from its maximum negative value until a picture appears on the monitor, increasing the lens aperture if the picture is faint.
- h. Adjust grid 3 voltage and the optical focus alternately to obtain the best focused picture.
- j. Align the beam by adjusting the alignment fields so that the centre of the picture does not move as grid 4 and grid 3 voltages are varied.
- k. Adjust the deflection controls to scan an area 12.8mm x 9.6mm.
- m. Adjust the lens iris to obtain sufficient signal output and adjust the beam current to a value at which highlights are stabilized.

In order to improve the highlight handling capability of the tube and reduce highlight retention effects, it is customary to use a beam current sufficient to discharge a signal double the working highlight level. This may be done by setting the beam to just discharge the highlights, with the lens iris opened one stop from the operating point. Some cameras incorporate an attenuator to assist in this process and the camera manufacturers' instructions must be consulted before making this adjustment. Still higher beam currents can be used but may produce slight degradation in resolution, lag and geometry.

- n. Check alignment, beam focus and optical focus.

## NOTES

1. Measured using 2854K tungsten light, including the infra-red component.
2. Tube sensitivity is not affected by change of target potential, but operation at higher voltages significantly reduces lag. The target voltage is therefore adjusted so that the tube operates on the saturated region of the dark current characteristic (see page 6), typically at about 20V.
3. Percentage of initial value of signal current remaining after a dark interval of 60ms, with an initial highlight signal current of 200nA.
4. The maximum electrode potentials must not be exceeded if normal tube life expectancy is to be achieved.

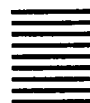

# TYPICAL SILICON TARGET CHARACTERISTICS

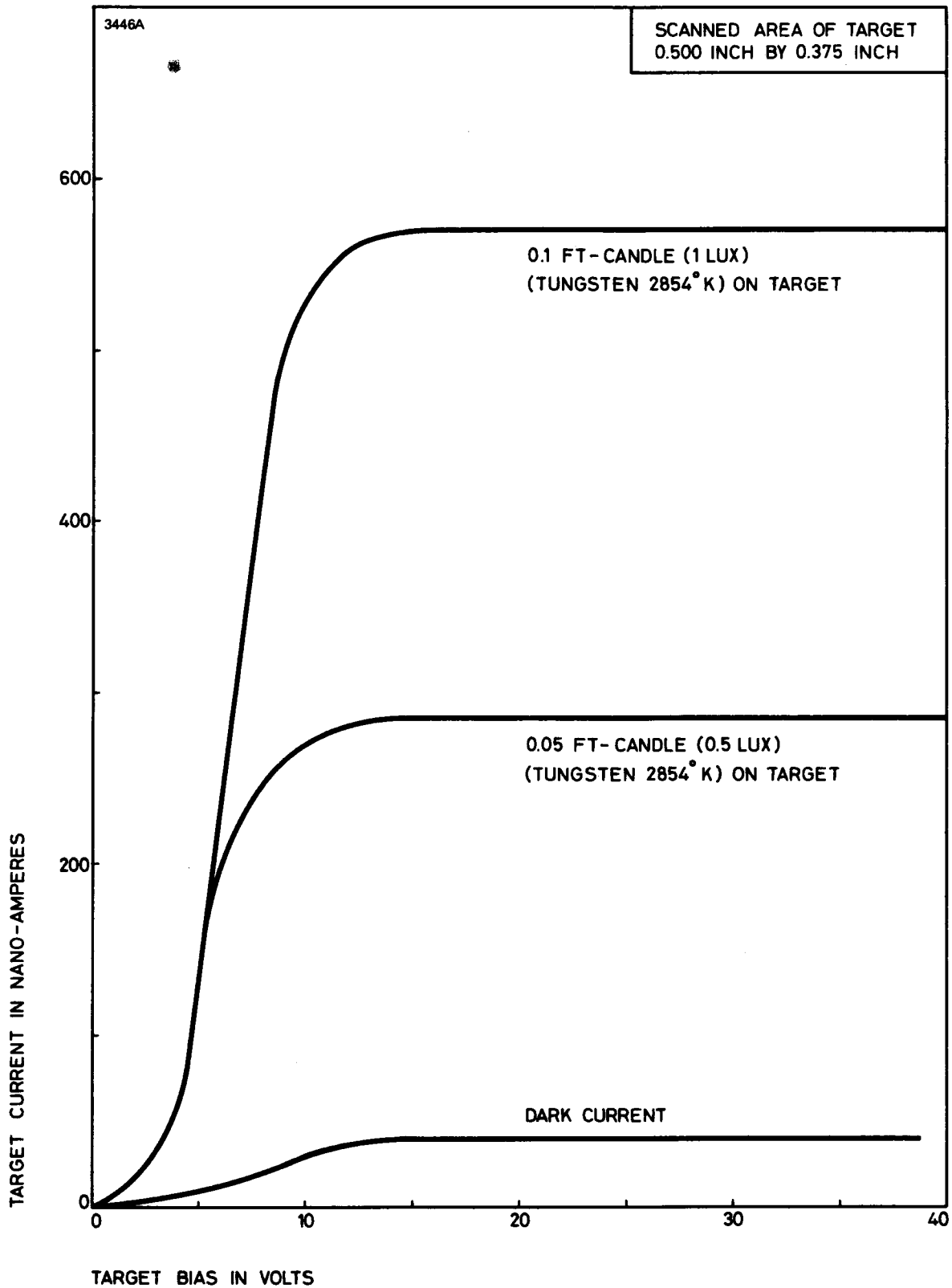

# TYPICAL SPECTRAL SENSITIVITY CHARACTERISTIC

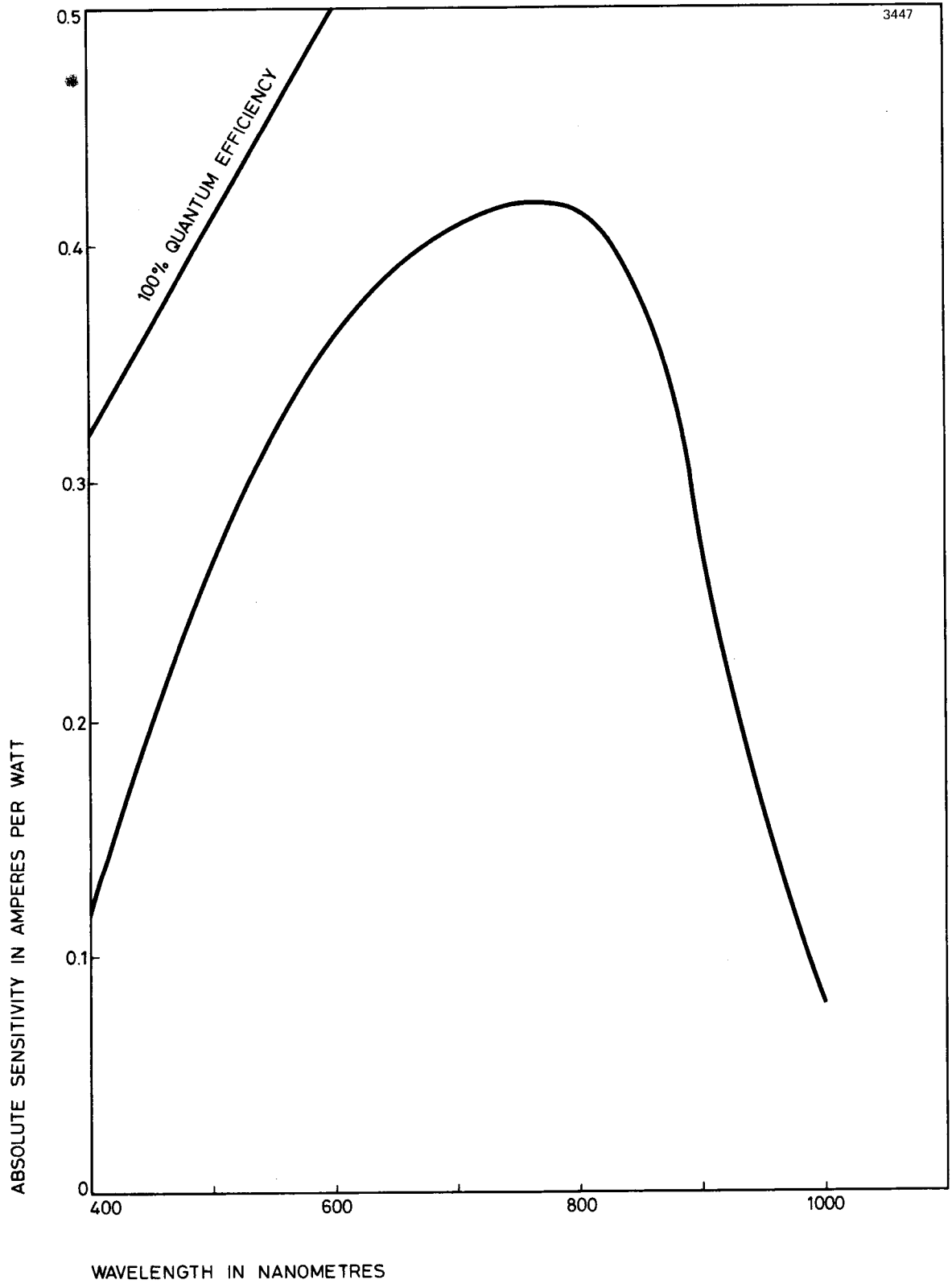

This information relates to a developmental device and is subject to change without notice. Please consult the Company regarding state of development and future manufacture before proceeding with equipment design.

This information relates to a developmental device and is subject to change without notice. Please consult the Company regarding state of development and future manufacture before proceeding with equipment design.

**OUTLINE (All dimensions without limits are nominal)**

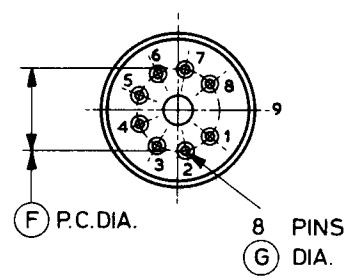
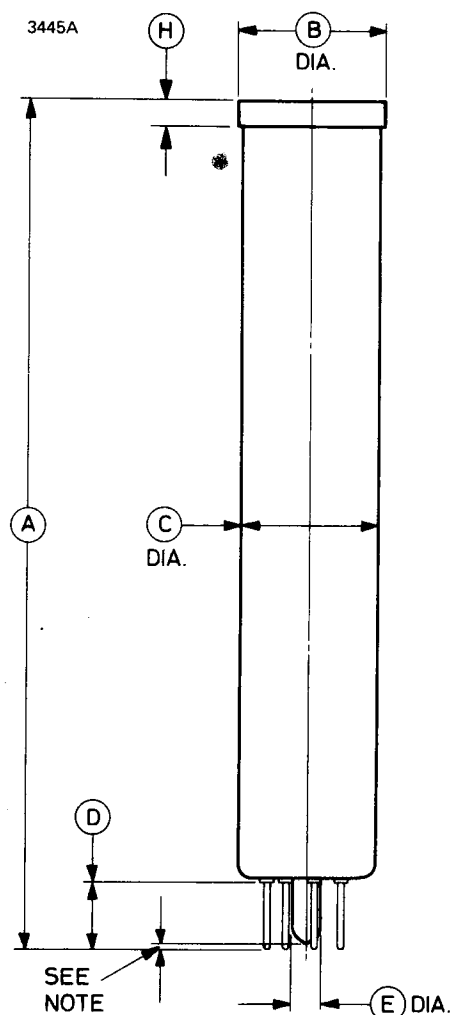

Pin	Element
1	Heater
2	Grid 1
3	Grid 4 (mesh)
4	Internal connection
5	Grid 2
6	Grid 3 (beam focus)
7	Cathode
8	Heater
9	Key pin position, blank
Flange	Signal electrode

Ref	Inches	Millimetres	Ref	Inches	Millimetres
A	6.250 ± 0.125	158.8 ± 3.2	E	0.265 max	6.73 max
B	1.133	28.78	F	0.600	15.24
C	1.020 <sup>+0.030</sup> -0.035	25.91 <sup>+0.76</sup> -0.89	G	0.050 <sup>+0.002</sup> -0.004	1.270 <sup>+0.051</sup> -0.102
D	0.503 max	12.78 max	H	0.188	4.78

Millimetre dimensions have been derived from inches.

**Note** The seal-off will not project beyond the pins.



# Vidicons







---

## INTRODUCTION

The majority of the EEV range of vidicons can be manufactured with a fibre-optic faceplate to special order. This type of construction is particularly suitable for applications where the vidicon views a device having a phosphor screen output, such as the EEV image intensifier type P896.

By using fibre-optic faceplates on both devices and coupling them together in direct optical contact, the proportion of the phosphor light output reaching the vidicon photo-layer may be considerably improved. The fibre-optic coupling is also more compact than a lens system and unaffected by atmospheric pollution.

## NOMENCLATURE

The type numbers of EEV fibre-optic vidicons will consist of the original tube number with the addition of the suffix F, e.g. the 8541 (P842) when manufactured with a fibre-optic faceplate becomes the P842F.

## FACEPLATE DIMENSIONS

Fibre size 5 microns nominal diameter.

Faceplate diameter 1.03 inch (standard 1-inch vidicon size)

## SENSITIVITY

With 7735B type photosurface and 1ft-candle (10.8 lux) illumination on the faceplate, the signal current will be at least  $0.15\mu\text{A}$  when the target voltage is set to produce  $0.02\mu\text{A}$  dark current.

## BLEMISHES

The photosurface will be similar in quality to the 7735B but black spots may be present when the vidicon is exposed to light due to imperfections in the fibres. Under these conditions picture quality will be of a standard generally accepted for industrial grade tubes.





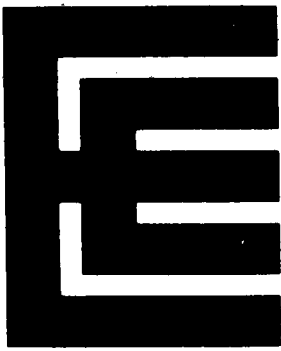

# VIDICONS with FACEPLATE RETICLES

---

## INTRODUCTION

The whole range of EEV vidicons can be manufactured with faceplate reticles to special order.

The reticle is designed to show up as black on a light background and as white on a black background. It is intended to provide reference points for determining object position, size, etc.

## NOMENCLATURE

The type numbers of EEV vidicons with reticles will consist of the original type number with the addition of the suffix N. For example, the P831 when manufactured with a faceplate reticle becomes the P831N.

## RETICLE DIMENSIONS

Some examples of designs available are shown below. Others can be supplied to suit customers' requirements and enquiries are invited. If detail or line width less than 0.001 inch is required (equivalent to 375 TV lines resolution), the price of the finished tube will be higher.

2858

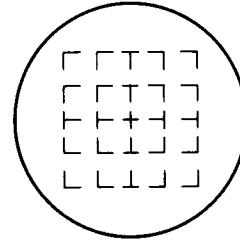
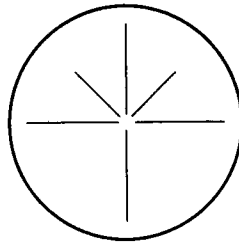
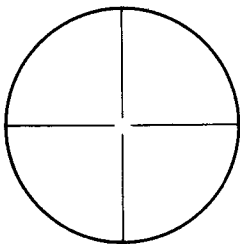

## BLEMISHES

Normally an industrial grade blemish specification will apply.



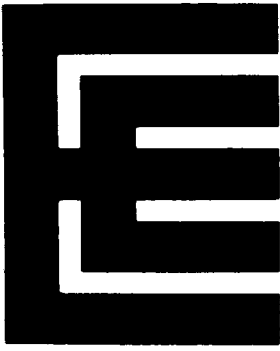

**INTRODUCTION**

The 7038 is a 1-inch diameter vidicon of integral mesh construction, with magnetic deflection and focusing.

The photoconductive layer of the 7038 may be exposed to bright stationary scenes for long periods without risk of burn-in or long term after image. This, together with a very short image retention time at high light levels, makes the tube particularly suitable for caption scanning and telecine applications. The spectral response is substantially panchromatic when used with tungsten illumination.

**GENERAL DATA**

**Electrical**

Cathode . . . . .	indirectly heated, oxide coated	
Heater voltage . . . . .	6.3	V
Heater current . . . . .	0.6	A
Inter-electrode capacitance, signal electrode to all other electrodes (average value) (see note 1) . . . . .	4.6	pF
Spectral response . . . . .	see spectral sensitivity curve	
Focusing method . . . . .	magnetic	
Deflection method . . . . .	magnetic	

**Mechanical**

Overall length . . . . .	6.375 inches (162mm) max
Overall diameter . . . . .	1.135 inches (28.9mm) max
Useful size of rectangular image; diagonal, centrally situated . . . . .	0.63 inches (15.9mm) max
Orientation of rectangular image . . . . .	see note 2
Net weight . . . . .	2 ounces (60g) approx
Mounting position (see note 3) . . . . .	any
Base . . . . .	small button ditetrap 8-pin (JEDEC no. E8-11)



### Associated Components

Focusing coil (see note 4)	Cleveland Electronics VF-115-5
Deflection yoke	Cleveland Electronics VY-111-3
Alignment coil (see note 5)	Cleveland Electronics VA-118
Base socket	Type R41-79502 by United Carr Fasteners Ltd. (or equivalent)

### Storage

Recommended store temperature . . . . . 15 to 35 °C  
 Tubes should be stored in darkness.

### WARNING

Ensure that the temperature of the tube is within its recommended range.

### MAXIMUM AND MINIMUM RATINGS (Absolute values)

No individual rating to be exceeded.

	Min	Max	
Heater voltage	5.7	6.9	V
Signal electrode voltage	—	100	V
Grid 3 (beam focus) voltage (see note 6)	—	1000	V
Grid 2 (accelerator) voltage	—	1000	V
Grid 1 voltage:			
negative bias value	—	300	V
positive bias value	—	0	V
Blanking voltage, peak to peak (see note 7):			
when applied to grid 1 (negative pulses)	40	—	V
when applied to cathode (positive pulses)	10	—	V
Peak heater to cathode voltage:			
heater negative with respect to cathode	—	125	V
heater positive with respect to cathode	—	10	V
Dark current	—	0.25	μA
Peak signal electrode current (see note 8)	—	0.55	μA
Faceplate temperature	—	71	°C
Peak illumination of faceplate	—	1000	ft-candles
	—	10 760	lux



## TYPICAL OPERATION

### Operating Conditions (for scanned area of 0.5 x 0.375 inch)

The following values and notes are for general guidance and may vary from tube to tube.

	Low Voltage Operation	High Voltage Operation	
Grid 3 (beam focus) voltage (see note 6) . . . . .	250 to 300	750	V
Grid 2 (accelerator) voltage . . . . .	300	300	V
Grid 1 voltage for picture cut-off (with no blanking voltage on grid 1) . . . . .	-45 to -100	-45 to -100	V
Blanking voltage, peak to peak:			
when applied to grid 1 (negative pulses) . . . . .	75	75	V
when applied to cathode (positive pulses) . . . . .	20	20	V
Field strength at centre of focusing coil (see note 4) . . . . .	5.3 53	6.8 68	mT gauss
Peak deflection coil currents:			
horizontal . . . . .	185	375	mA
vertical . . . . .	25	43	mA
Alignment field, adjustable (see note 9) . . . . .	0 to 0.4 0 to 4	0 to 0.4 0 to 4	mT gauss
Faceplate temperature (see note 10) . . . . .	30 to 35	30 to 35	°C

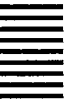

### Typical Performance

Limiting resolution at centre of picture (approx) . . . . .	750	900	TV lines
'Gamma' of transfer characteristic for signal output between 0.02 and 0.2 $\mu$ A . . . . .	0.65		
Visual equivalent signal to noise ratio (see note 11) . . . . .	300:1		approx

(Continued on page 4)

## Typical Performance (continued)

	Condition		
	1*	2†	
Faceplate illumination (highlights) (see note 14) . . . . .	10	100	ft-candles
	108	1076	lux
Signal output current (highlights) (see note 15) . . . . .	0.3	0.3	$\mu\text{A}$
Approximate range of signal electrode voltage (see note 16) . . . . .	25–60	12–30	V
Dark current (see note 17) . . . . .	0.02	0.004	$\mu\text{A}$

\* See note 12

† See note 13

## SEQUENCE OF CAMERA ADJUSTMENTS

### (For Typical Operating Conditions as shown on page 3)

- (a) Set the grid 1 voltage for the maximum negative bias for picture cut-off and apply the other voltages given under Typical Operating Conditions.
- (b) Check that the deflection circuits are functioning properly and adjust the scanning amplitude controls so that a maximum area of the photoconductive layer will be scanned.
- (c) Set the signal electrode voltage to give the signal current specified for the particular condition of operation. The table above gives an indication of the ranges of signal electrode voltage required for two conditions of operation. For other conditions of operation, reference should be made to the light transfer characteristic and the graph showing the range of signal electrode voltage to produce a given dark current and therefore a given sensitivity. It is preferable, if possible, to adjust the dark current to the specified value for the particular condition of operation; 7038 tubes will have substantially identical performances when operated with identical values of dark current.

The magnitude of non-uniformities of dark current, as well as lag, tend to increase with signal electrode voltage; therefore operation at low values of signal electrode voltage helps to minimize these effects.

- (d) Decrease grid 1 voltage from its maximum negative value until a signal is produced.
- (e) Adjust grid 3 (beam focus) voltage, the lens stop and the optical focus alternately to obtain the best focused picture with the peak signal output current specified under Typical Performance.
- (f) Adjust the lens aperture and signal electrode voltage to produce the desired output signal. Lag decreases with increase in illumination on the faceplate.
- (g) Adjust the alignment field so that the centre of the picture does not move as grid 3 (beam focus) voltage is rocked slightly. Adjust grid 1 (beam current) voltage to provide just sufficient beam to discharge the highlights. It is permissible to set the alignment fields slightly off the minimum movement position to maintain signal uniformity.
- (h) Adjust the deflection amplitude and position to scan an area 0.500 inch x 0.375 inch. This is facilitated by the use of a perspex mask inscribed with circles 0.500 inch and 0.375 inch diameter, placed in contact and concentric with the faceplate of the tube. Light is allowed to fall on the photoconductive layer and an image of the rings is obtained on the monitor. No lens is necessary. The scan amplitude and centring controls are adjusted until the diameter of the larger circle is equal to the width of the raster and that of the smaller equal to the height.
- (j) Centre the raster in the useful area of the photoconductive layer and check the alignment (step g).
- (k) If the picture is faint, even with adequate video gain, open the lens iris more and, if necessary, increase the signal electrode voltage.
- (l) Repeat steps (e) to (g) until optimum picture reproduction is obtained.

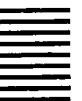

## NOTES

1. This capacitance, which in effect forms the output impedance of the tube, is increased when the tube is mounted in a deflecting yoke and focusing coil assembly. The resistive component of the output impedance is of the order of 100 megohms.
2. The horizontal scan should be parallel to the plane passing through the tube axis and the blank key-pin position. The masking is for orientation only and does not define the proper scanned area.
3. When the tube is subjected to vibration the mounting position must not be vertical with the base uppermost.
4. The direction of the focusing current should be such that a north pole is attracted to the image end of the focusing coil. The distance from the faceplate to the beginning of the winding is 0.75 inch approximately.
5. The alignment coil is located to the rear of the focusing coil directly over the electron gun. It should be located so that its centre is 3.69 inches from the faceplate of the tube and its axis should be coincident with the axis of the tube, the deflecting yoke and the focusing coil.
6. Grid 3 voltage is adjusted for the best focus. The resolution, uniformity of focus and picture quality decrease with decreasing grid 3 voltage and in general grid 3 should not be operated below 250V.
7. The blanking voltage required when applied to the cathode is less than that required when applied to grid 1 as the former reduces the potential difference between the cathode and the scanned side of the target.
8. The video amplifier must be designed to handle signal currents of this magnitude, to avoid picture distortion due to overloading of the amplifier.
9. Adjust the current through the alignment coils until the centre of the test pattern does not move as grid 3 voltage is varied through focus.
10. Unless the temperature of the faceplate is maintained at a constant value within this range, the dark current and performance will drift from the optimum performance established on initial setting up.

11. Measured with a high gain, low noise, cascode type pre-amplifier having a bandwidth of 5.1MHz and a peak signal output current of  $0.35\mu\text{A}$ . The visual equivalent signal to noise ratio is taken as the ratio of the highlight signal output current to the r.m.s. noise current, multiplied by a factor of 3 (ref. Otto H. Schade, 'Electro-optical Characteristics of Television Systems; Introduction and Part 1 – Characteristics of Vision and Visual Systems', RCA Review, March 1948).
12. Intermediate sensitivity operation.
13. Highlight level operation.
14. For example, a scene brightness of approximately 860 foot-lamberts ( $2950\text{cd}/\text{m}^2$ ) with lens aperture  $f/4$  and a transmission of 75% produces 10 foot-candles (108 lux) illumination on the faceplate.
15. The signal output current is the highlight signal electrode current during one frame after the dark current component has been subtracted. Signal currents higher than  $0.3\mu\text{A}$  may be used depending on requirements.
16. The signal electrode voltage for each tube is adjusted to that value which gives the desired operating signal current; the indicated range of signal electrode voltage for each operational condition is given to illustrate the variation normally encountered.
17. The deflecting circuits must provide linear scanning for good black level reproduction under these conditions. Dark current is proportional to the scanning velocity. Any change in scanning velocity produces a black level error in direct proportion to the change in velocity of scanning.



# TYPICAL SPECTRAL SENSITIVITY CHARACTERISTIC

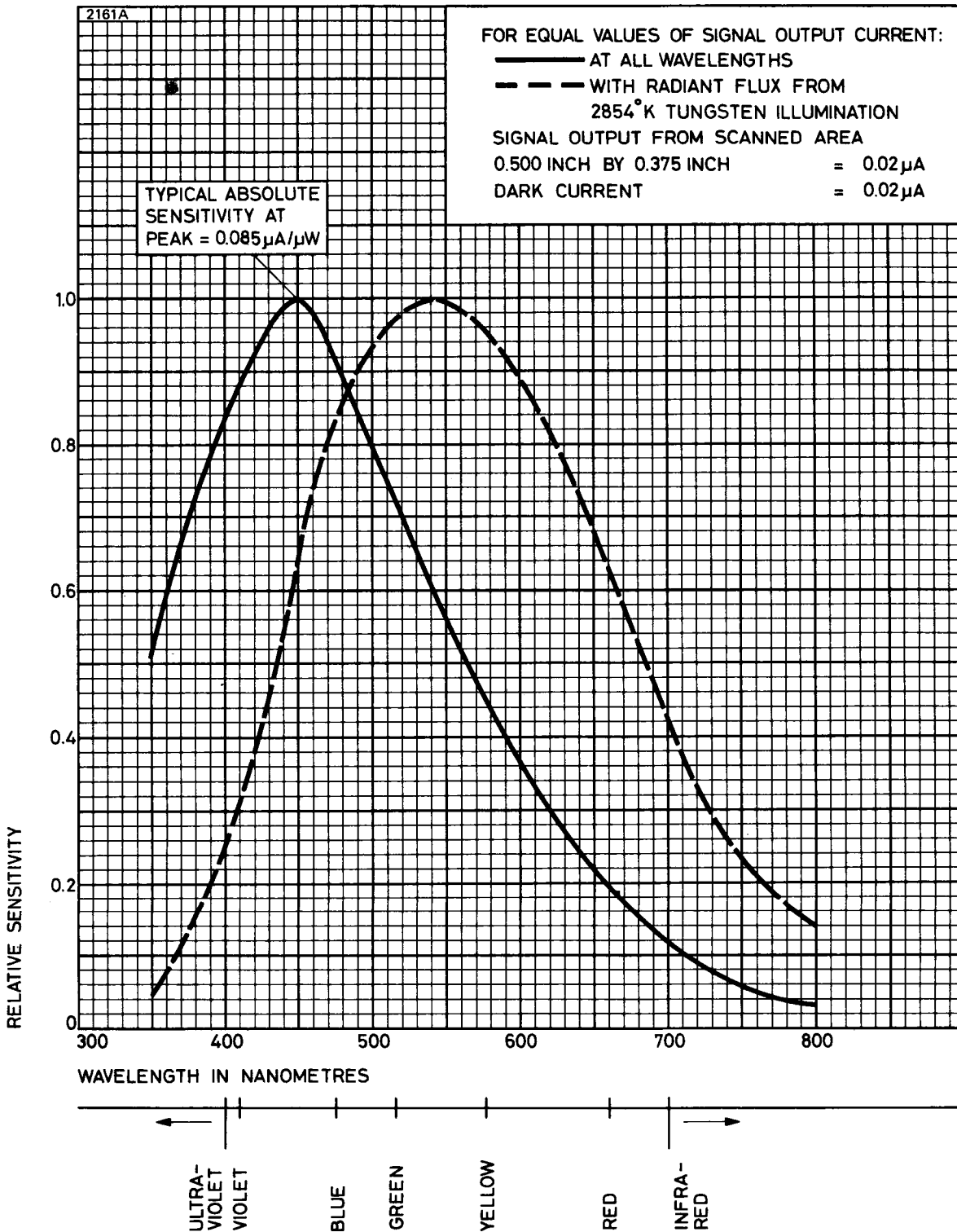

# TYPICAL RESOLUTION

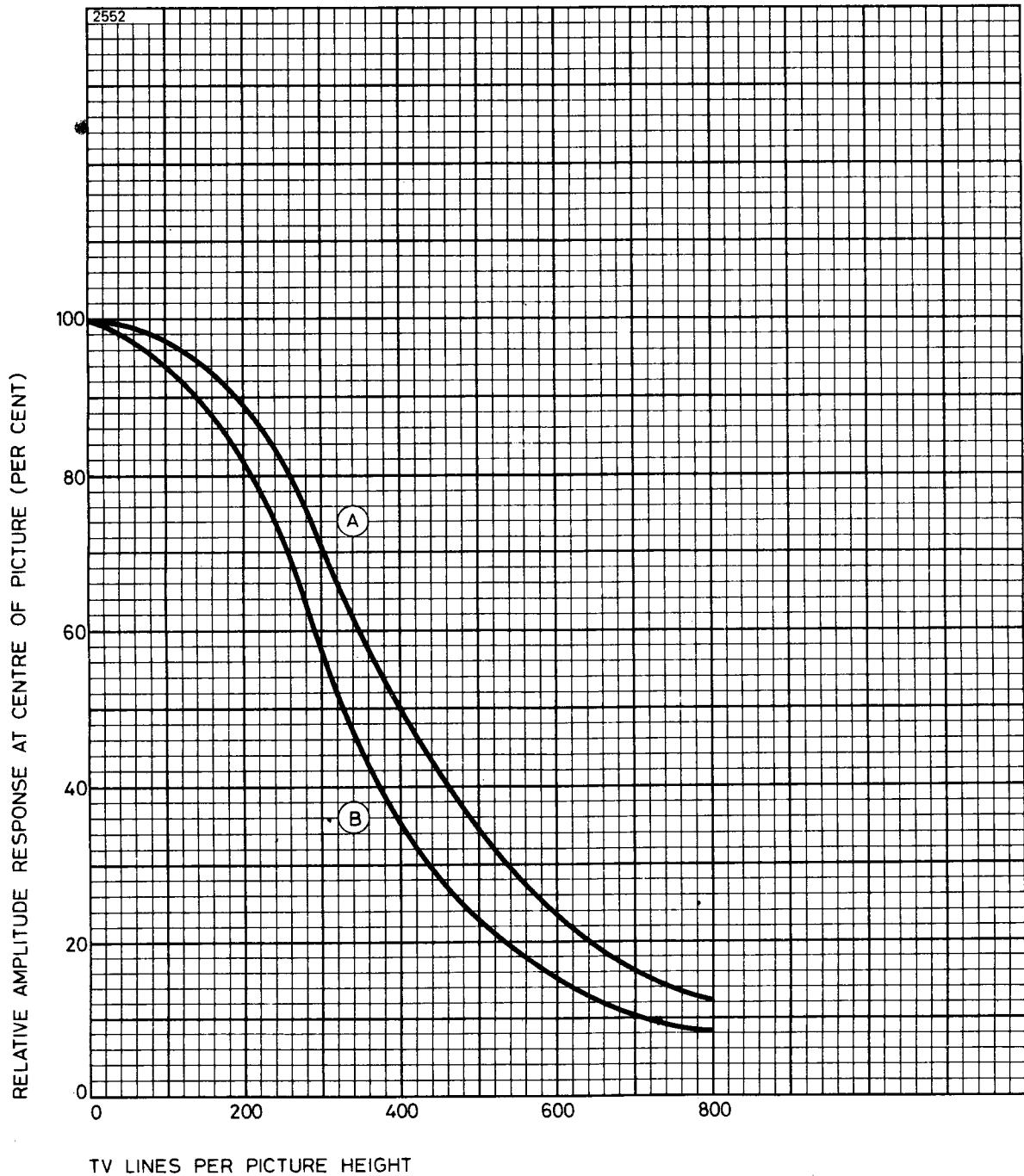

Highlight signal electrode current . . . . .	0.35	$\mu$ A
Dark current . . . . .	0.02	$\mu$ A
Test pattern . . . . .	square wave resolution wedge transparency	
Video amplifier response . . . . .	flat	
Curve A . . . . .	grid 3 at 750V	
Curve B . . . . .	grid 3 at 300V	



# TYPICAL LIGHT TRANSFER CHARACTERISTICS

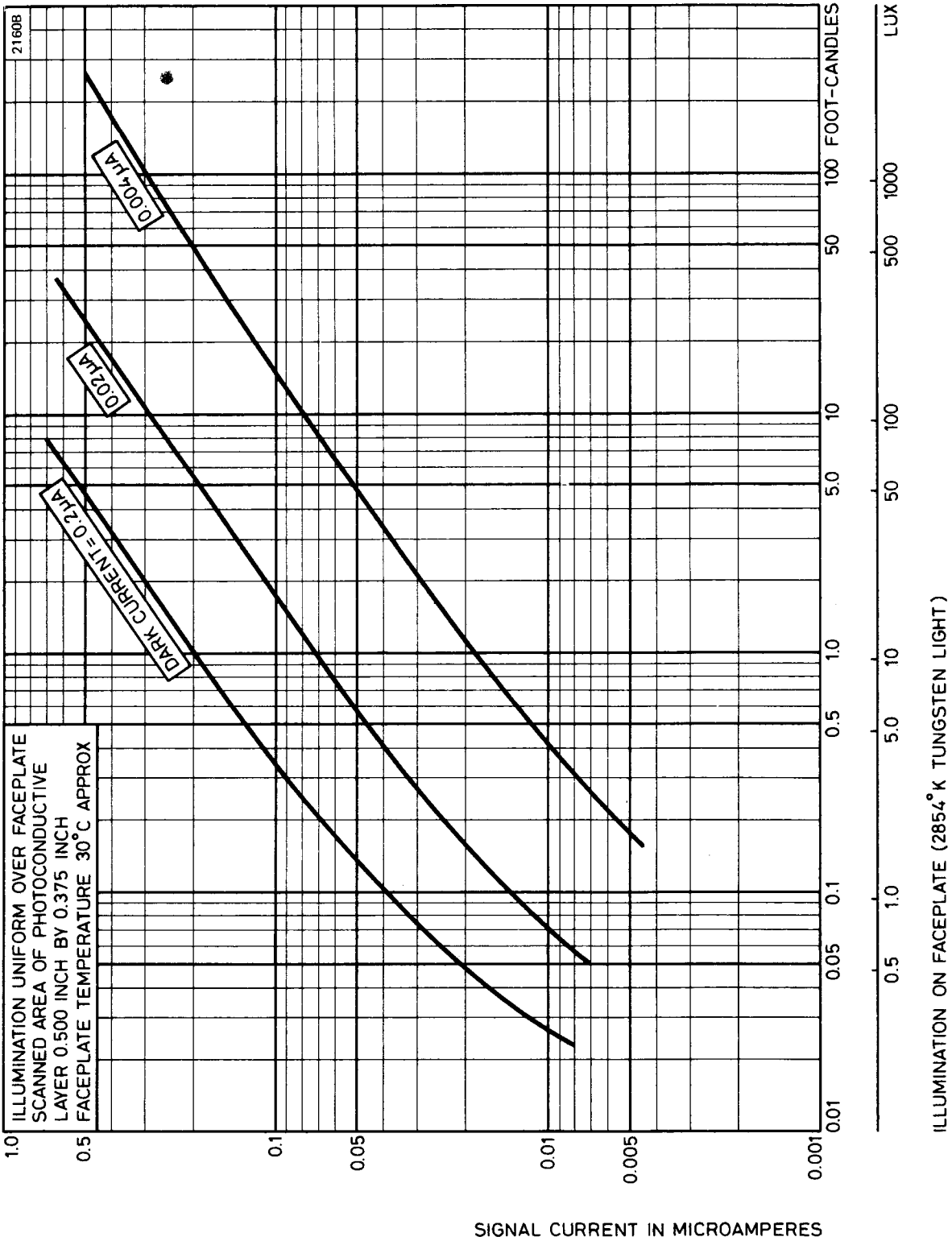



# TYPICAL RANGE OF DARK CURRENT

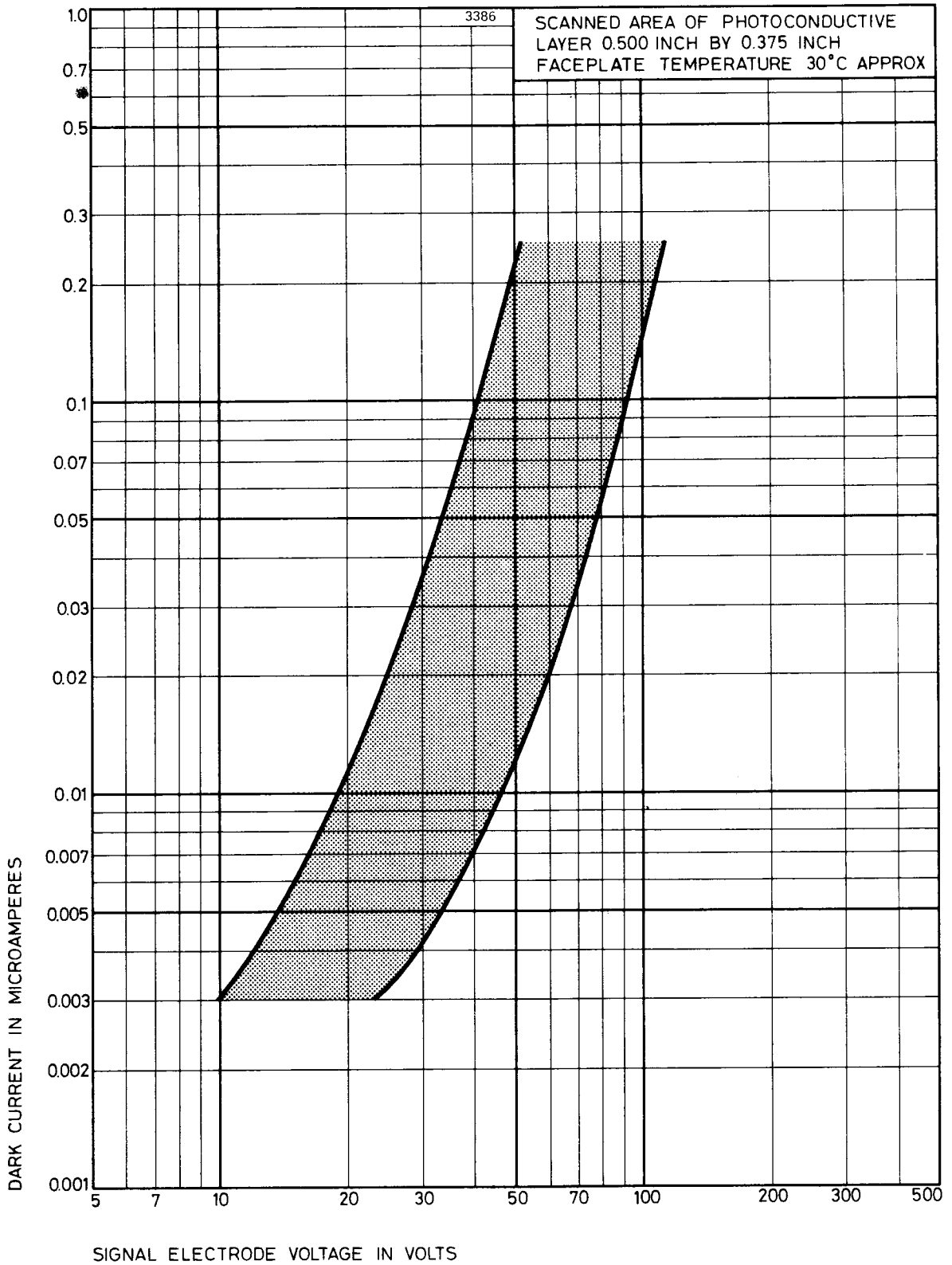

**OUTLINE (All dimensions without limits are nominal)**

2157A

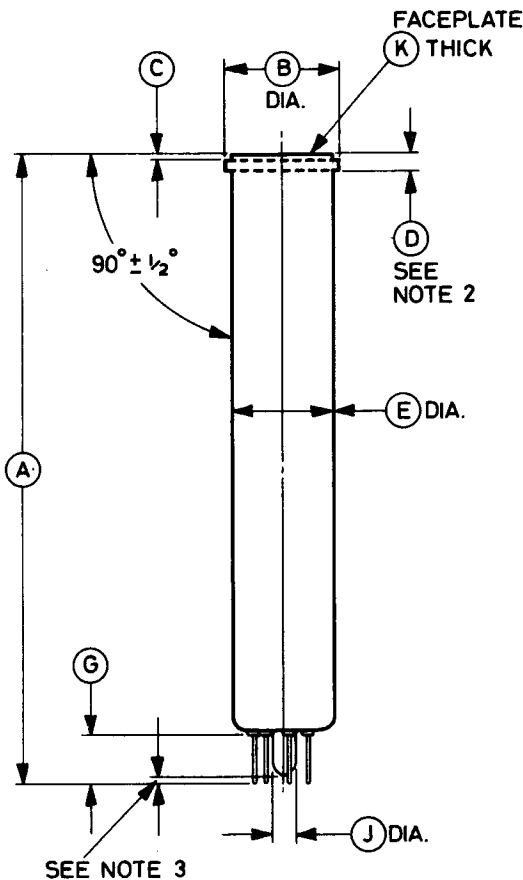
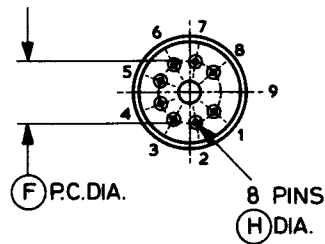
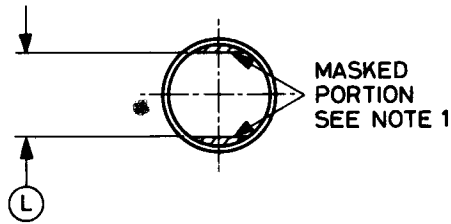

Pin	Element
1	Heater
2	Grid 1
3	Internal connection
4	Internal connection
5	Grid 2
6	Grid 3
7	Cathode
8	Heater
9	Key pin position, blank
Flange	Signal electrode

**NOTES**

1. The straight sides are parallel to the plane passing through the tube axis and pin position 9.
2. Signal electrode contact flange may be located along the tube axis in any part of or all of the space between the dashed lines.
3. The seal-off will not project beyond the pins.

Ref	Inches	Millimetres	Ref	Inches	Millimetres
A	6.250 ± 0.125	158.8 ± 3.2	G	0.503 max	12.78 max
B	1.125 ± 0.010	28.58 ± 0.25	H	0.050 <sup>+0.002</sup> <sub>-0.004</sub>	1.270 <sup>+0.051</sup> <sub>-0.102</sub>
C	0.050 max	1.27 max	J	0.265 max	6.73 max
D	0.175	4.45	K	0.093 ± 0.005	2.36 ± 0.13
E	1.020 <sup>+0.030</sup> <sub>-0.035</sub>	25.91 <sup>+0.76</sup> <sub>-0.89</sub>	L	0.835 ± 0.035	21.21 ± 0.89
F	0.600	15.24			

Millimetre dimensions have been derived from inches.

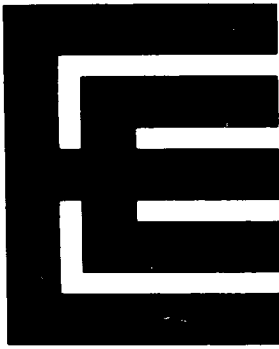

### INTRODUCTION

The 7262A is a short, 1-inch diameter vidicon with magnetic focus and deflection, intended for use in compact closed-circuit television systems in either black and white or colour.

This vidicon is of integral mesh construction and employs a low lag, high sensitivity photoconductive surface giving high resolution and signal uniformity over the scanned area. These properties enable high quality pictures to be obtained under normal room lighting conditions, with a signal output of  $0.2\mu\text{A}$  at 1 foot-candle illumination on the tube faceplate. Limiting resolutions in the region of 1000 TV lines may be obtained in the centre of the picture when the tube is operated with 1000V on grids 3 and 4. When operated at voltages as low as 250V, with minimum focus and deflection power, the centre resolution will normally exceed 650 TV lines.

The 7262A has a 0.6 watt heater (95mA heater current) and this, together with its reduced length, allows the tube to be used in small cameras employing solid state circuits.

### GENERAL DATA

#### Electrical

Cathode . . . . .	indirectly heated, oxide coated	
Heater voltage . . . . .	6.3	V
Heater current . . . . .	95	mA
Inter-electrode capacitance, signal electrode to all other electrodes (average value) (see note 1) . . . . .	4.6	pF
Spectral response . . . . .	see spectral sensitivity curve	
Focusing method . . . . .	magnetic	
Deflection method . . . . .	magnetic	
Magnetic fields:		
focusing field, at centre of focusing device (see note 2) . . . . .	3.6 to 6.4mT (36 to 64 gauss)	
alignment field, adjustable . . . . .	0 to 0.4mT (0 to 4 gauss)	

**Continued on page 2**



## Mechanical

Overall length . . . . .	5.180 inches (131.6mm) max
Overall diameter . . . . .	1.135 inches (28.9mm) max
Useful size of rectangular image; diagonal, centrally situated . . . . .	0.63 inches (15.9mm) max
Orientation . . . . .	The horizontal scan should be parallel to the plane passing through the tube axis and the blank key-pin position. The masking is for orientation only and does not define the proper scanned area.
Alignment coil location . . . . .	The centre of the alignment coil should be 3.69 inches (94mm) from the faceplate of the tube.
Net weight . . . . .	2 ounces (60g) approx
Mounting position (see note 3) . . . . .	any
Base . . . . .	small button ditetrar 8-pin (JEDEC no. E8-11)
Mating socket . . . . .	Type R41-79502 by United Carr Fasteners Ltd. (or equivalent)

## Storage

Recommended store temperature . . . . .	15 to 35 °C
---	-------------

Tubes should be stored in darkness.

## WARNING

When operating a tube the following precautions should be observed:

1. Ensure that the temperature of the tube is within its recommended range.
2. Avoid excessive exposure to high levels of illumination otherwise permanent damage to the photoconductive surface may result.
3. A surge limiting device must be incorporated if necessary to ensure that the heater current does not exceed 150mA when switching on or at any other time.

## MAXIMUM AND MINIMUM RATINGS (Absolute values)

No individual rating to be exceeded.

	Min	Max	
Heater voltage . . . . .	5.7	6.9	V
Signal electrode voltage . . . . .	—	100	V
Grid 3 (beam focus) voltage (see note 4) . . . . .	—	1000	V
Grid 2 (accelerator) voltage . . . . .	—	750	V
Grid 1 voltage:			
negative bias value . . . . .	—	300	V
positive bias value . . . . .	—	0	V
Blanking voltage, peak to peak (see note 5):			
when applied to grid 1 (negative pulses) . . . . .	40	—	V
when applied to cathode (positive pulses) . . . . .	20	—	V
Peak heater to cathode voltage:			
heater negative with respect to cathode . . . . .	—	125	V
heater positive with respect to cathode . . . . .	—	10	V
Dark current . . . . .	—	0.25	$\mu$ A
Peak signal electrode current (see note 6) . . . . .	—	0.55	$\mu$ A
Faceplate temperature . . . . .	—	71	$^{\circ}$ C
Peak illumination of faceplate . . . . .	—	5000	ft-candles
	—	53 820	lux



## TYPICAL OPERATION

### Operating Conditions (for scanned area of 0.5 x 0.375 inch)

The following values and notes are for general guidance and may vary from tube to tube.

	Low Voltage Operation	High Voltage Operation	
Grid 3 (beam focus) voltage (see note 4)	250–300	750	V
Grid 2 (accelerator) voltage	300	300	V
Grid 1 voltage for picture cut-off (with no blanking voltage on grid 1)	–45 to –100	–45 to –100	V
Blanking voltage, peak to peak:			
when applied to grid 1 (negative pulses)	75	75	V
when applied to cathode (positive pulses)	20	20	V
Field strength at centre of focusing coil (see notes 2 and 7)	40	60	gauss
Peak deflection coil currents (approx) (see note 8):			
horizontal	185	375	mA
vertical	25	43	mA
Alignment field, adjustable (see notes 7 and 8)	0 to 4	0 to 4	gauss
Faceplate temperature (see note 9)	30 to 35	30 to 35	°C

### Typical Performance

Limiting resolution at centre of picture (approx)	750	900 TV lines	
Amplitude response to a 400 TV line square wave test pattern at centre of picture (approx)	30	45	%
Lag (see note 10)		21	% max
'Gamma' of transfer characteristic for signal output between 0.02 and 0.2 $\mu$ A		0.65	
Visual equivalent signal to noise ratio (see note 11)		300:1	approx
Picture defects			see note 12

Continued on page 4

**Typical Performance — continued**

	Condition			
	1*	2†	3‡	
Faceplate illumination (highlights) (see note 16)	0.1	1.0	10	ft-candles
Signal output current (peak) (see note 17):				
typical	0.11	0.20	0.30	μA
Approximate range of signal electrode voltage (see note 18)	30–60	20–40	10–22	V
Dark current (see note 19)	0.1	0.02	0.005	μA

\* See note 13

† See note 14

‡ See note 15

**SEQUENCE OF CAMERA ADJUSTMENTS**

**(For general operational conditions as shown on page 4)**

- (a) Set the grid 1 voltage for the maximum negative bias for picture cut-off and apply the other voltages given under Typical Operating Conditions.
- (b) Check that the deflection circuits are functioning properly and adjust the scanning amplitude controls so that a maximum area of the photoconductive layer will be scanned.
- (c) Set the signal electrode voltage to give the signal current specified for the particular condition of operation. The range of signal electrode voltage above gives an indication of the voltage required.

The magnitude of dark current non-uniformities as well as lag increase with signal electrode voltage; therefore operation at low values of signal electrode voltage helps to minimise these effects. The table above gives an indication of the ranges of signal electrode voltage required for three conditions of operation. For other conditions of operation, reference should be made to the light transfer characteristic and the graph showing range of signal electrode voltage to produce a given dark current and therefore a given sensitivity. It is preferable, if possible, to adjust the dark current to the specified value for the particular condition of operation; 7262A tubes will have substantially identical performances when operated with identical values of dark current.

- (d) Decrease grid 1 voltage from its maximum negative value until a signal is produced.

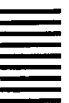

- (e) Adjust grid 3 (beam focus) voltage, the lens stop and the optical focus alternately to obtain the best focused picture with the peak signal output current specified under Typical Performance Data.
- (f) Adjust the lens aperture and signal electrode voltage to produce the desired output signal. Lag decreases with increase in illumination on the faceplate.
- (g) Adjust the alignment field so that the centre of the picture does not move as grid 3 (beam focus) voltage is rocked slightly. Adjust grid 1 (beam current) voltage to provide sufficient beam to just discharge the highlights. It is permissible to set the alignment fields slightly off the minimum movement position to maintain signal uniformity.
- (h) Adjust the deflection amplitude and position to scan an area 0.500 inch x 0.375 inch. This is facilitated by the use of a perspex mask inscribed with circles 0.500 inch and 0.375 inch diameter, placed in contact and concentric with the faceplate of the tube. Light is allowed to fall on the photoconductive layer and an image of the rings is obtained on the monitor. No lens is necessary. The scan amplitude and centring controls are adjusted until the diameter of the larger circle is equal to the width of the raster and that of the smaller equal to the height.
- (j) Centre the raster in the useful area of the photoconductive layer and check the alignment (step g).
- (k) If the picture is faint, even with adequate video gain, open the lens iris more and, if necessary, increase the signal electrode voltage.
- (l) Repeat steps (e) to (g) until optimum picture reproduction is obtained.



## NOTES

1. This capacitance, which effectively is the output impedance of the 7262A, is increased when the tube is mounted in a deflecting yoke and focusing coil assembly. The resistive component of the output impedance is of the order of 100 megohms.
2. The direction of the focusing current should be such that a north pole is attracted to the image end of the focusing coil.
3. When the tube is subjected to vibration the mounting position should not be vertical with the base uppermost.
4. Grid 3 voltage is adjusted for the best focus. The resolution, uniformity of focus and picture quality decrease with decreasing grid 3 voltage and in general grid 3 should not be operated below 250V.
5. The blanking voltage required when applied to the cathode is less than that required when applied to grid 1 as the former reduces the potential difference between the cathode and the scanned side of the target.
6. The video amplifier must be designed to handle signal currents of this magnitude.
7. Use an approved deflection yoke, focusing coil and alignment coil assembly such as Cleveland Electronics VYFA-355-1 or equivalent. For the focusing coil, the distance from the faceplate to the beginning of the winding is 0.75 inch approx. The alignment coil should be located so that its centre is 3.69 inches from the faceplate of the tube. Its axis should be coincident with the axis of the tube, the deflecting yoke and the focusing coil.
8. Adjust the current through the alignment coils until the centre of the test pattern does not move as grid 3 voltage is varied through focus.
9. Unless the temperature of the faceplate is maintained at a constant value within this range, the dark current and performance will drift from the optimum performance established on initial setting up.
10. Percentage of initial value of signal output current remaining 3 field periods after light is cut off (i.e. 50ms in American standard systems and 60ms in European systems) with a faceplate illumination of 2 foot-candles and a total signal current of  $0.3\mu\text{A}$ .
11. Measured with a high gain, low noise, cascode type pre-amplifier having a bandwidth of 5.1MHz and a peak signal output current of  $0.35\mu\text{A}$ . The visual equivalent signal to noise ratio is taken as the ratio of the highlight signal output current to the r.m.s. noise current, multiplied by a factor of 3. (Ref. Otto H. Schade, 'Electro-optical Characteristics of

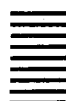

Television Systems; Introduction and Part 1 - Characteristics of Vision and Visual Systems', RCA Review, March 1948.)

12. This test is carried out with a faceplate illumination of 0.5 foot-candle (e.g. a scene brightness of 100ft-lamberts with lens aperture f/6.3 and transmission 75%), scanned area of 0.5 by 0.375 inch and signal current 0.3 $\mu$ A. The test pattern shown is used to define the picture zones.

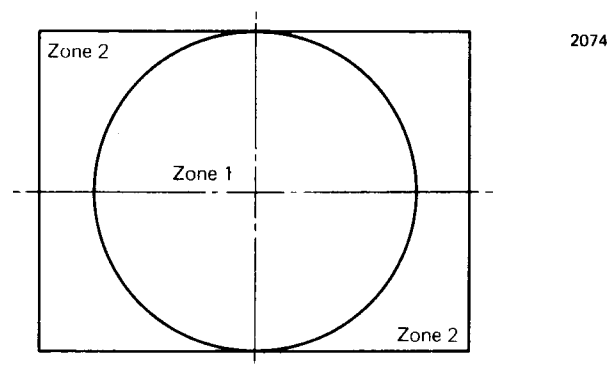

The limitations on size and number of spots will be according to the following table. Spots having a contrast ratio less than 1.5:1 for white spots and 2:1 for black spots are not counted. Smudges, streaks, or mottled or grainy background must have a contrast ratio of 1.5:1 to be cause for rejection.

<b>Method A.</b> Measurement in inches using a monitor with 10 <sup>3</sup> / <sub>4</sub> x 8 <sup>1</sup> / <sub>8</sub> inch raster	<b>Method B.</b> Equivalent number of raster lines in a 525 line system	Number allowed	
		Zone 1	Zone 2
over 0.060	over 4	0	0
0.060 to but not including 0.050	4 to but not including 3	0	1
0.050 to but not including 0.015	3 to but not including 1	2	3
0.015 and under	1 and under	*	*

Minimum separation between any two spots greater than 0.015 inch (1 line) is 0.25 inch (16 lines).

\* Spots of this size may be present in unlimited numbers unless their concentration causes a smudged appearance.

13. High sensitivity operation.
14. Average sensitivity operation.
15. High light level operation.
16. For example, a scene brightness of approximately 100ft-lamberts with lens aperture f/4 and a transmission of 75% produces 1 foot-candle illumination on the faceplate.
17. The signal output current is the highlight signal electrode current during one frame after the dark current component has been subtracted. Signal currents higher than  $0.3\mu\text{A}$  may be used depending on requirements.
18. The signal electrode voltage for each 7262A must be adjusted to that value which gives the desired operating current. The indicated range of target voltage for each operational condition is given to illustrate the operating voltage range normally encountered. See also step (c) in Sequence of Camera Adjustments.
19. The deflecting circuits must provide extremely linear scanning for good black level reproduction under these conditions. Dark current is proportional to the scanning velocity. Any change in scanning velocity produces a black level error in direct proportion to the change in velocity of scanning.

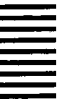

# TYPICAL SPECTRAL SENSITIVITY CHARACTERISTIC

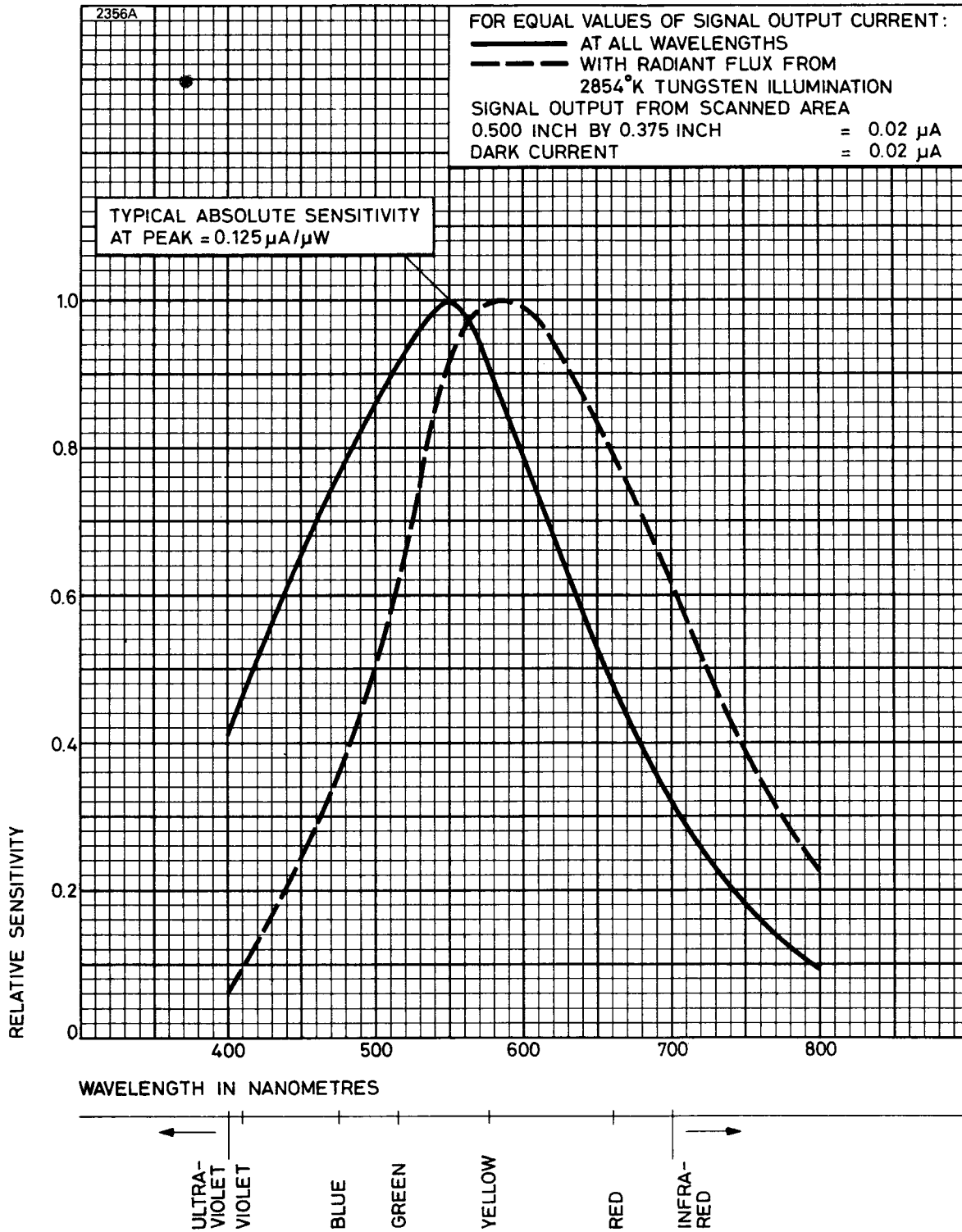

# TYPICAL RESOLUTION

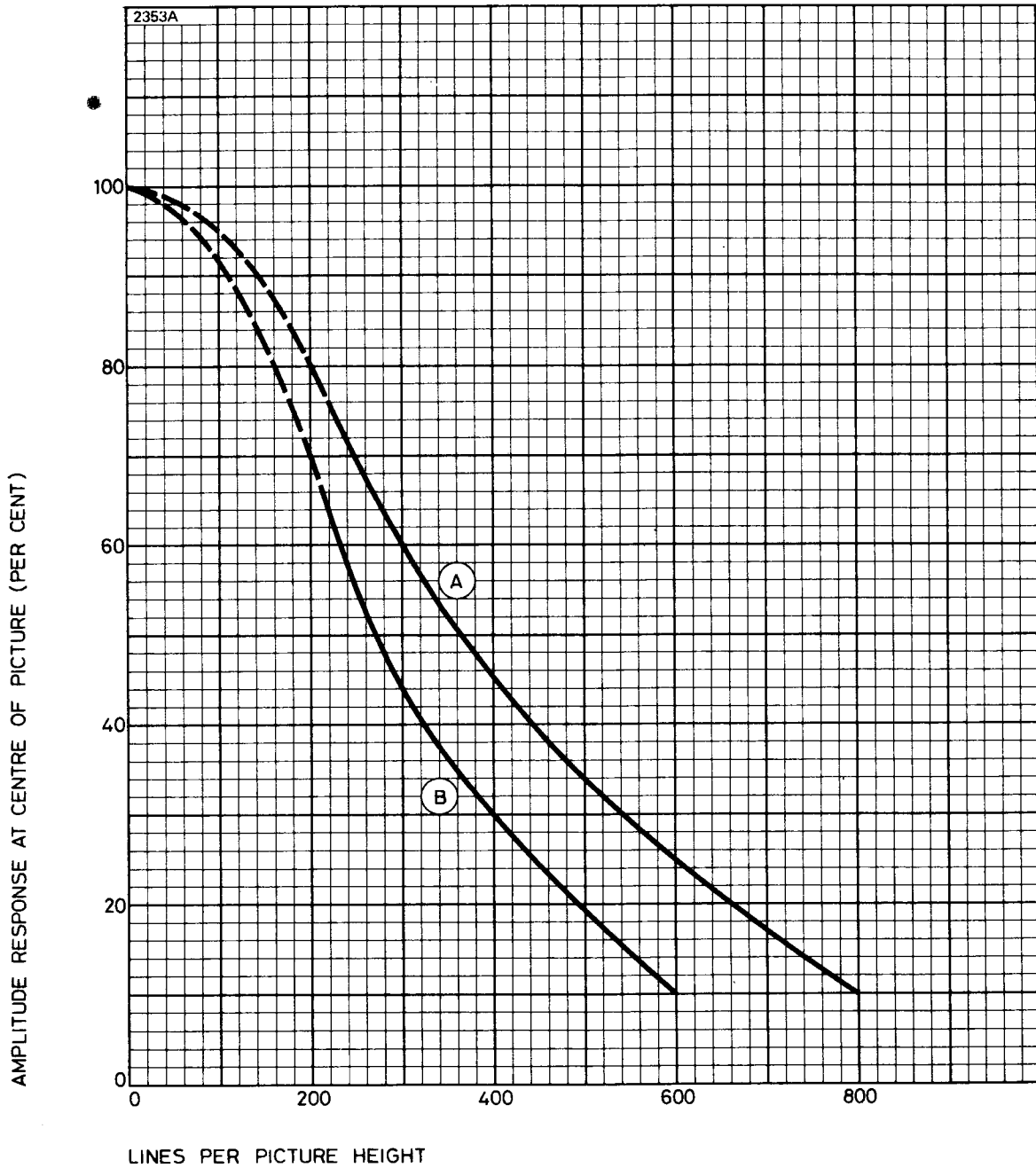

	Curve A	Curve B	
Grid 3 voltage	750	300	V
Highlight signal electrode current	0.35	0.35	$\mu$ A
Dark current	0.02	0.02	$\mu$ A
Test pattern	square wave resolution wedge transparency		
Video amplifier response			flat

# TYPICAL LIGHT TRANSFER CHARACTERISTICS

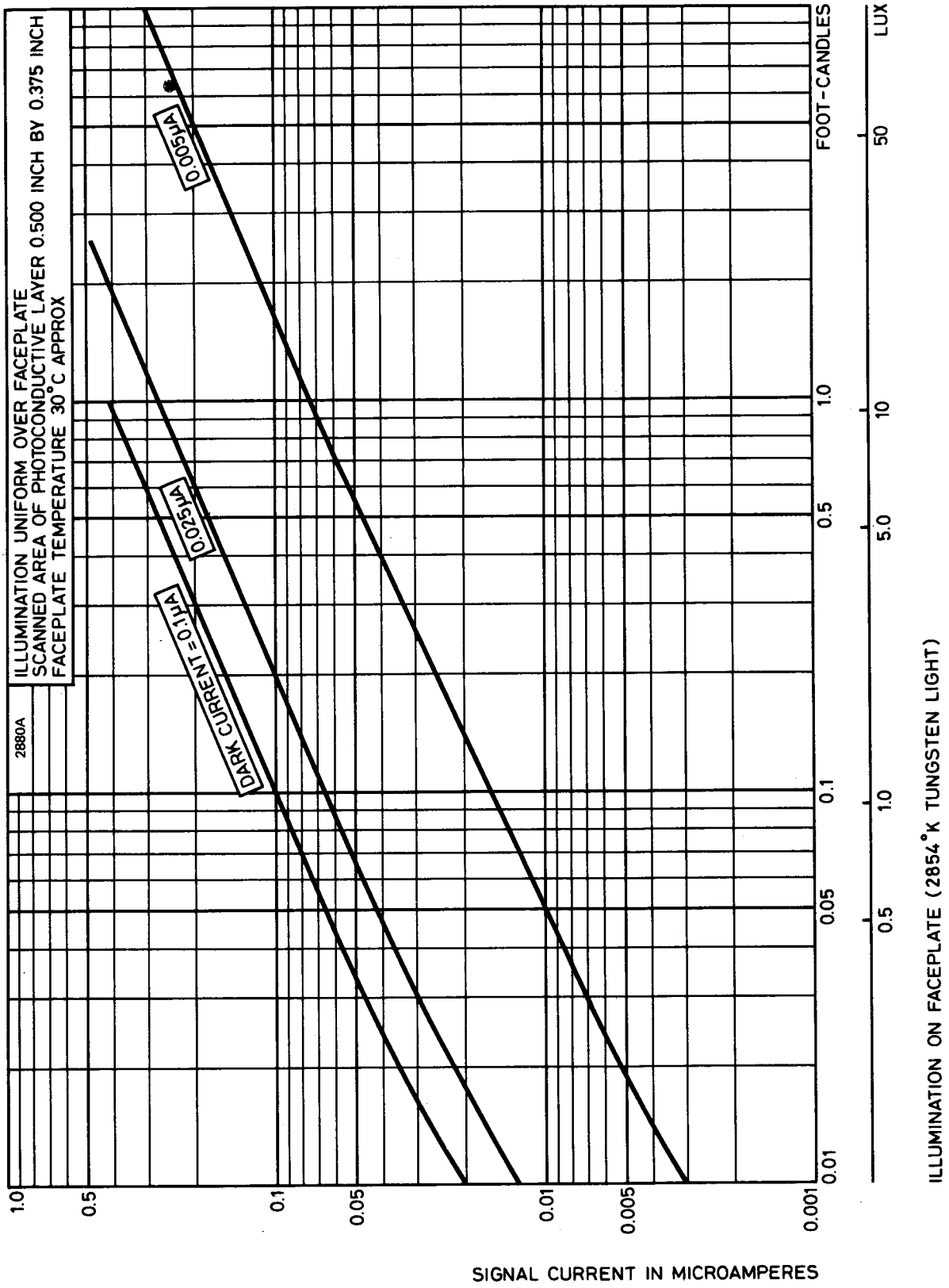

# TYPICAL RANGE OF DARK CURRENT

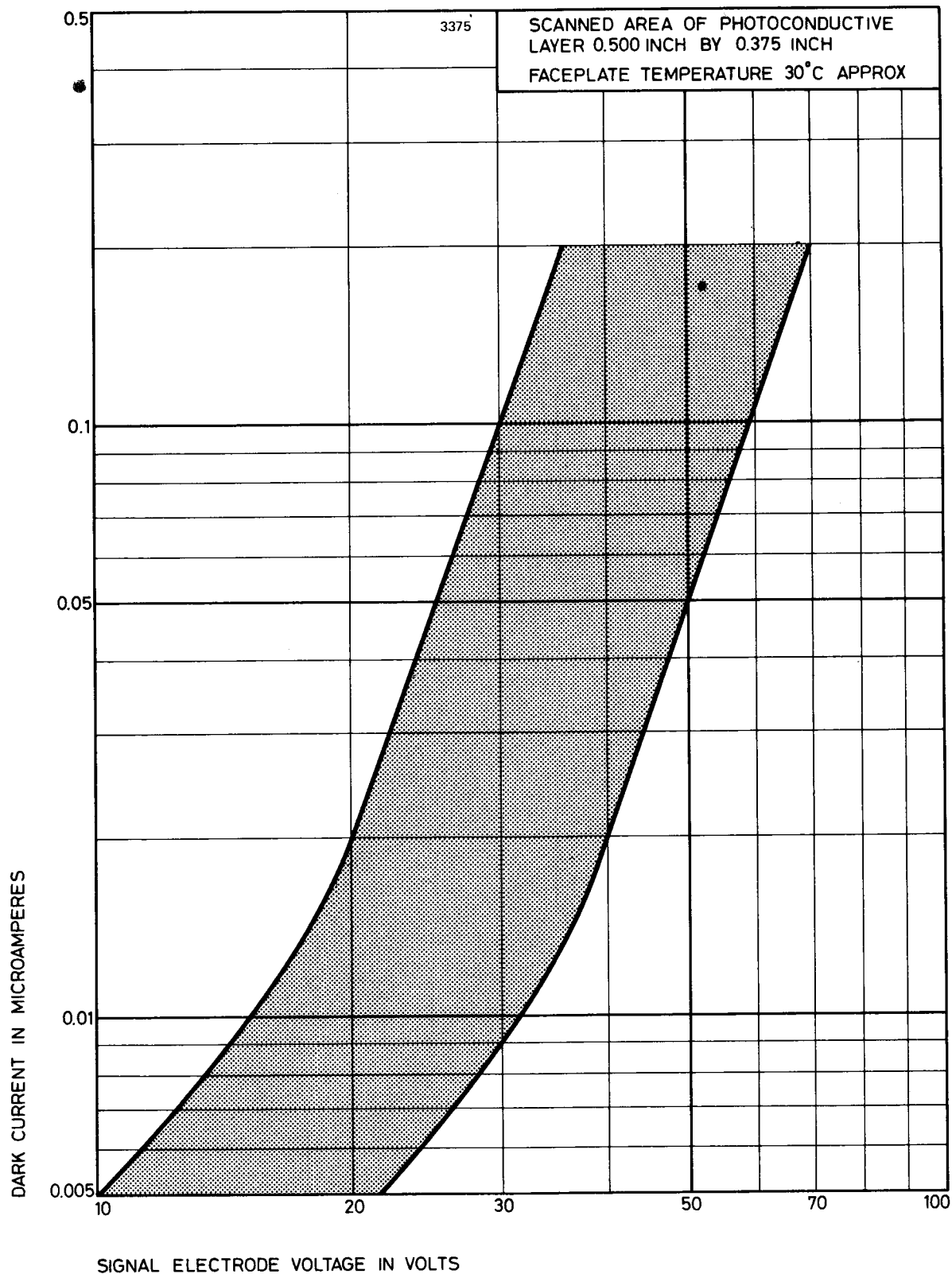

# TYPICAL LAG CHARACTERISTIC

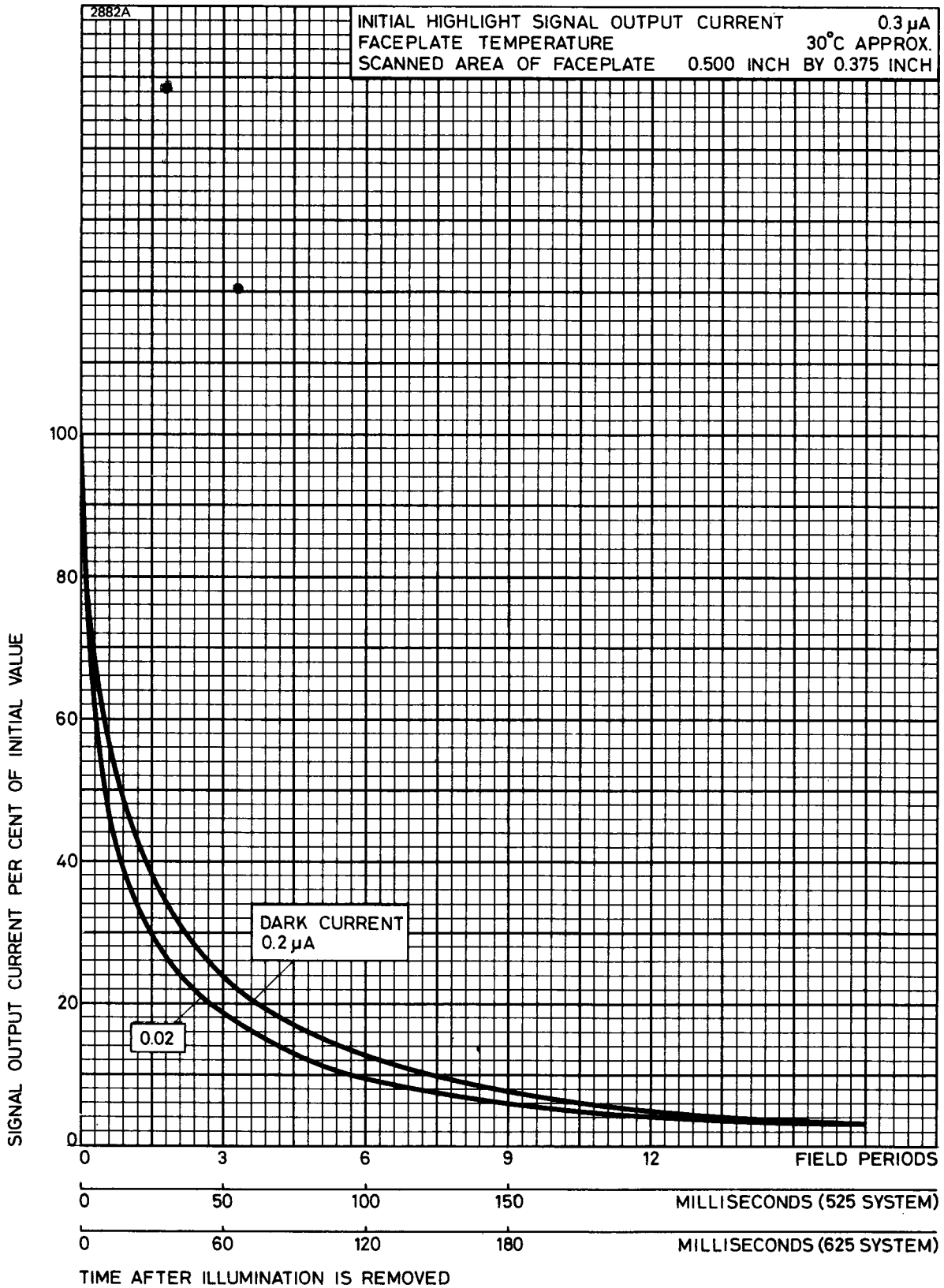



# OUTLINE

2879

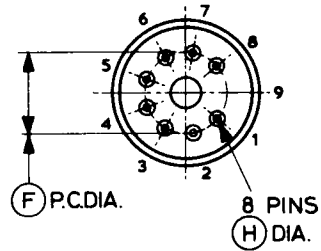
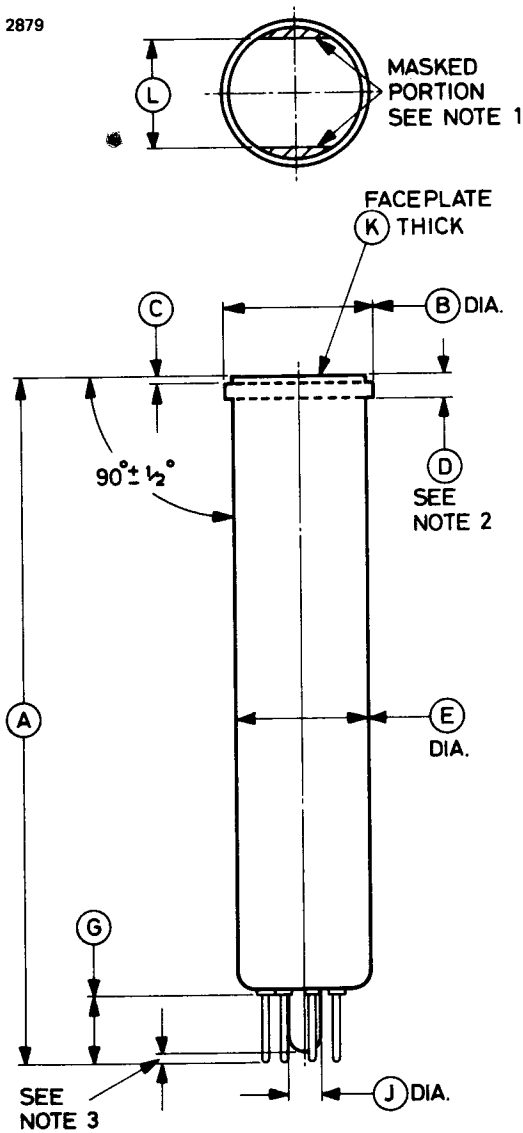

Pin	Element
1	Heater
2	Grid 1
3	Internal connection
4	Internal connection
5	Grid 2
6	Grid 3
7	Cathode
8	Heater
9	Key pin position, blank
Flange	Signal electrode

## NOTES

1. The straight sides are parallel to the plane passing through the tube axis and pin position 9.
2. Signal electrode contact flange may be located along the tube axis in any part of or all of the space between the dashed lines.
3. The seal-off will not project beyond the pins.

Ref	Inches	Millimetres	Ref	Inches	Millimetres
A	5.120 ± 0.060	130.0 ± 1.5	G	0.503 max	12.78 max
B	1.125 ± 0.010	28.58 ± 0.25	H	0.050 + 0.002 - 0.004	1.270 + 0.051 - 0.102
C	0.050 max	1.27 max	J	0.265 max	6.73 max
D	0.175	4.45	K	0.093 ± 0.005	2.36 ± 0.13
E	1.020 + 0.030 - 0.035	25.91 + 0.76 - 0.89	L	0.835 ± 0.035	21.21 ± 0.89
F	0.600	15.24			

Millimetre dimensions have been derived from inches.

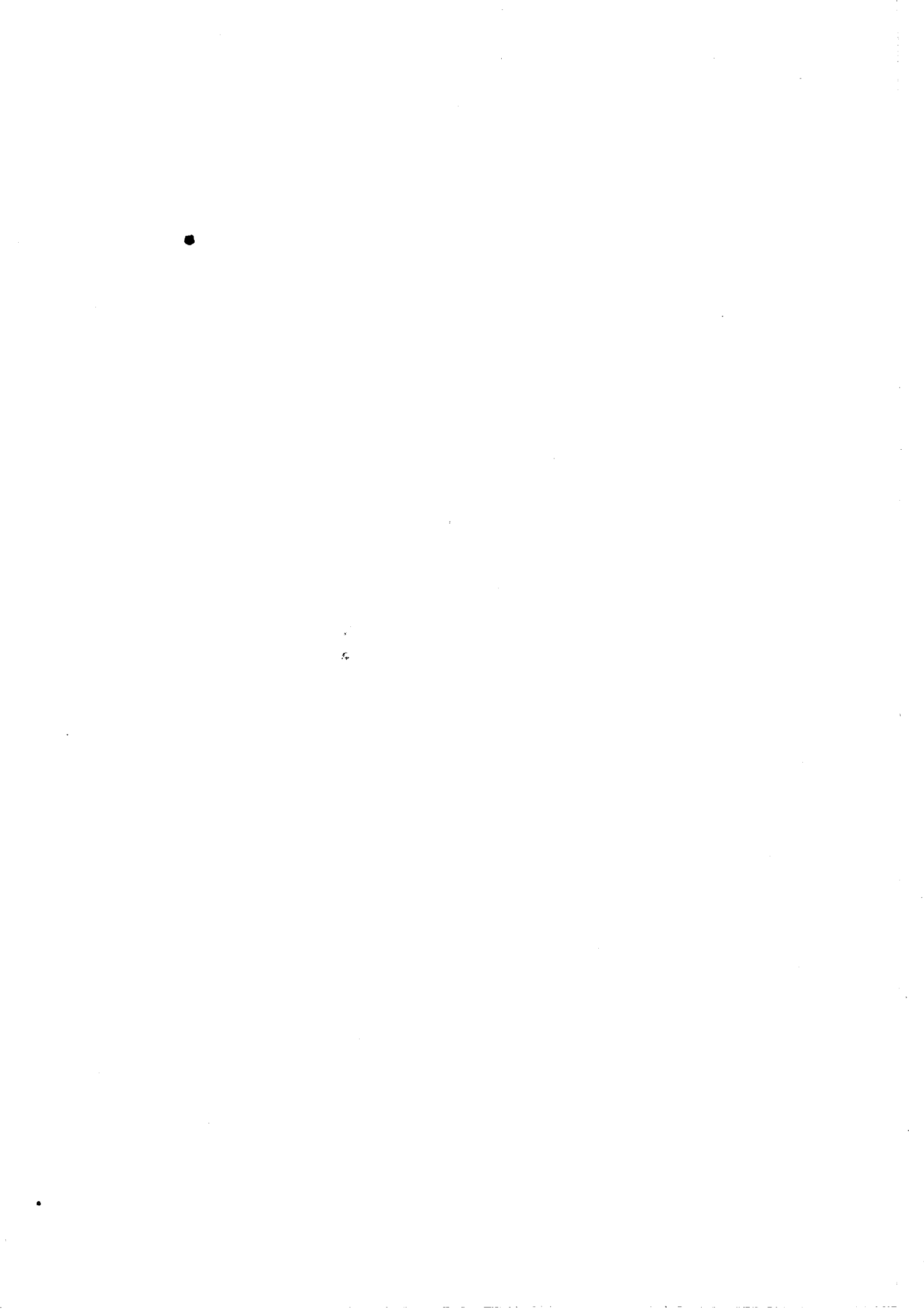



# 7735 7735A

## VIDICONS

**This information should be read in conjunction with the 7735B data sheet.**

The 7735 and 7735A are of identical construction to type 7735B but are tested to the following specification.

### Typical Performance

Illumination on faceplate (2870° K tungsten light)	. . . . .	1.0	ft-candle
Dark current	. . . . .	0.02	μA
Signal output current	. . . . .	0.15	μA min
Grid 1 voltage for picture cut-off	. . . . .	-45 to -100	V
Limiting resolution at centre of picture	. . . . .	700	TV lines
		<b>7735</b>	<b>7735A</b>
Signal electrode voltage range	. . . . .	15 to 55	20 to 40 V
Lag at 1/20s	. . . . .	30	28 % max

### Picture Defects (measured under the above operating conditions)

The limitations on the size and number of spots will be according to the following table.

Spot size as equivalent number of raster lines in a 625 line system	Zone 1*	Zone 2†
over 4	0	0
4 to but not including 3	0	1
3 to but not including 1	2	3

Spots below 1 line are not counted unless their concentration causes a smudged appearance. Spots having a contrast ratio less than 1.5:1 for white spots and 2:1 for black spots are not counted.

The minimum separation between spots greater than 1 line is 16 lines.

\* Zone 1 is a circle centred on the raster and with a diameter equal to the raster height.

† Zone 2 is the area outside Zone 1.

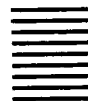

# OUTLINE (All dimensions without limits are nominal)

2157A

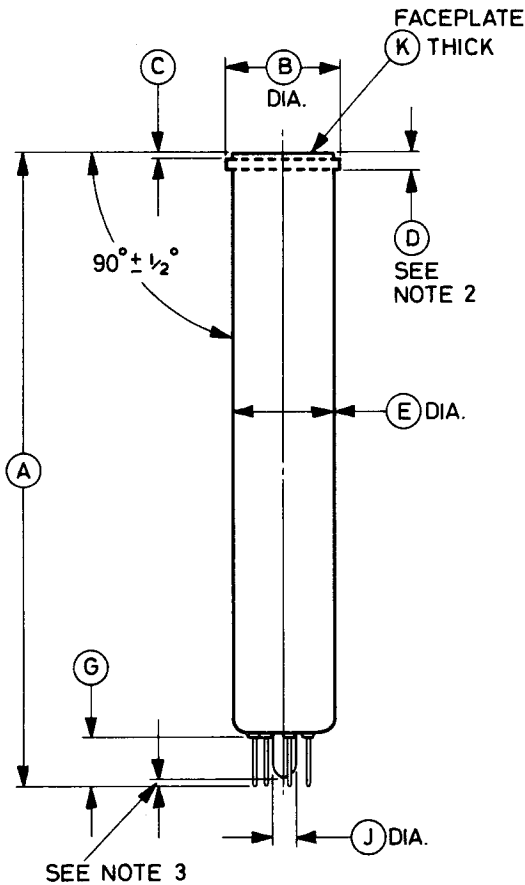
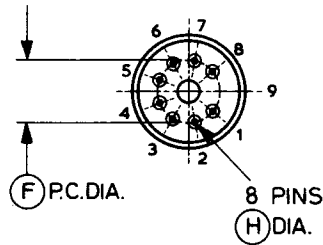
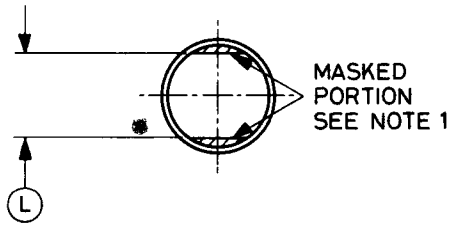

Pin	Element
1	Heater
2	Grid 1
3	Internal connection
4	Internal connection
5	Grid 2
6	Grid 3
7	Cathode
8	Heater
9	Key pin position, blank
Flange	Signal electrode

## NOTES

1. The straight sides are parallel to the plane passing through the tube axis and pin position 9.
2. Signal electrode contact flange may be located along the tube axis in any part of or all of the space between the dashed lines.
3. The seal-off will not project beyond the pins.

Ref	Inches	Millimetres
A	$6.250 \pm 0.125$	$158.8 \pm 3.2$
B	$1.125 \pm 0.010$	$28.58 \pm 0.25$
C	0.050 max	1.27 max
D	0.175	4.45
E	$1.020 \begin{matrix} + 0.030 \\ - 0.035 \end{matrix}$	$25.91 \begin{matrix} + 0.76 \\ - 0.89 \end{matrix}$
F	0.600	15.24

Ref	Inches	Millimetres
G	0.503 max	12.78 max
H	$0.050 \begin{matrix} + 0.002 \\ - 0.004 \end{matrix}$	$1.270 \begin{matrix} + 0.051 \\ - 0.102 \end{matrix}$
J	0.265 max	6.73 max
K	$0.093 \pm 0.005$	$2.36 \pm 0.13$
L	$0.835 \pm 0.035$	$21.21 \pm 0.89$

Millimetre dimensions have been derived from inches.



### INTRODUCTION

The 7735B is a 1-inch diameter vidicon camera tube suitable for a wide range of uses including broadcast, industrial and other closed circuit applications. The photoconductive layer has a spectral response approximating to that of the eye.

Low-cost versions of this tube, for use in applications where broadcast performance is not required, are available under the type numbers 7735A, 7735 and P826/4478.

### GENERAL DATA

#### Electrical

Cathode . . . . .	indirectly heated, oxide coated	
Heater voltage . . . . .	6.3	V
Heater current . . . . .	0.6	A
Inter-electrode capacitance, signal electrode to all other electrodes (average value) (see note 1) . . . . .	4.6	pF
Spectral response . . . . .	see spectral sensitivity curve	
Focusing method . . . . .	magnetic	
Deflection method . . . . .	magnetic	

#### Mechanical

Overall length . . . . .	6.375 inches (162mm) max
Overall diameter . . . . .	1.135 inches (28.9mm) max
Useful size of rectangular image; diagonal, centrally situated . . . . .	0.63 inches (15.9mm) max
Orientation of rectangular image . . . . .	see note 2
Net weight . . . . .	2 ounces (60g) approx
Mounting position (see note 3) . . . . .	any
Base . . . . .	small button ditetrar 8-pin (JEDEC no. E8-11)



## Associated Components

Focusing coil (see note 4)	Cleveland Electronics VF-115-5
Deflection yoke	Cleveland Electronics VY-111-3
Alignment coil (see note 5)	Cleveland Electronics VA-118
Base socket	Type R41-79502 by United Carr Fasteners Ltd. (or equivalent)

## Storage

Recommended store temperature . . . . . 15 to 35 °C  
 Tubes should be stored in darkness.

## WARNING

When operating a tube the following precautions should be observed:

1. Ensure that the temperature of the tube is within its recommended range.
2. Avoid over exposure of stationary pictures, e.g. test patterns, or after-image may result.

## MAXIMUM AND MINIMUM RATINGS (Absolute values)

No individual rating should be exceeded

	Min	Max	
Heater voltage	5.7	6.9	V
Signal electrode voltage	—	100	V
Grid 3 (beam focus) voltage (see note 6)	—	1000	V
Grid 2 (accelerator) voltage	—	1000	V
Grid 1 voltage:			
negative bias value	—	300	V
positive bias value	—	0	V
Blanking voltage, peak to peak (see note 7):			
when applied to grid 1 (negative pulses)	40	—	V
when applied to cathode (positive pulses)	10	—	V
Peak heater to cathode voltage:			
heater negative with respect to cathode	—	125	V
heater positive with respect to cathode	—	10	V
Dark current	—	0.25	μA
Peak signal electrode current (see note 8)	—	0.55	μA
Faceplate temperature	—	71	°C
Peak illumination of faceplate	—	1000	ft-candles
	—	10 760	lux

## TYPICAL OPERATION

### Operating Conditions (for scanned area of 0.5 x 0.375 inch)

The following values and notes are for general guidance and may vary from tube to tube.

	Low Voltage Operation	High Voltage Operation	
Grid 3 (beam focus) voltage (see note 6) . . . . .	250 to 300	750	V
Grid 2 (accelerator) voltage . . . . .	300	300	V
Grid 1 voltage for picture cut-off (with no blanking voltage on grid 1) . . . . .	-45 to -100	-45 to -100	V
Blanking voltage, peak to peak:			
when applied to grid 1 (negative pulses) . . . . .	75	75	V
when applied to cathode (positive pulses) . . . . .	20	20	V
Field strength at centre of focusing coil (see note 4) . . . . .	5.3 53	6.8 68	mT gauss
Peak deflection coil currents:			
horizontal . . . . .	185	375	mA
vertical . . . . .	25	43	mA
Alignment field, adjustable (see note 9) . . . . .	0 to 0.4 0 to 4	0 to 0.4 0 to 4	mT gauss
Faceplate temperature (see note 10) . . . . .	30 to 35	30 to 35	°C

### Typical Performance

Limiting resolution at centre of picture:			
typical . . . . .	750	900	TV lines
minimum . . . . .	700	-	TV lines
Amplitude response to a 400 TV line square wave test pattern at centre of picture . . . . .	35	50	%
Typical lag (see note 11) . . . . .		23	%
'Gamma' of transfer characteristic for signal output between 0.02 and 0.2 $\mu$ A . . . . .		0.65	
Visual equivalent signal to noise ratio (see note 12) . . . . .		300:1	approx
Picture defects . . . . .			see note 13

(Continued on page 4)

## Typical Performance (continued)

	Condition			
	1	2	3	
Faceplate illumination (highlights) (see note 14)	0.5	1.0	10	ft-candles
	5.4	10.8	108	lux
Signal output current (peak) (see note 15)	0.27	0.275	0.3	$\mu\text{A}$
Approximate range of signal electrode voltage (see note 16)	30–60	20–40	10–22	V
Dark current (see note 17)	0.1	0.025	0.005	$\mu\text{A}$

## SEQUENCE OF CAMERA ADJUSTMENTS

### For Typical Operating Conditions as shown on page 3

- (a) Set the grid 1 voltage for the maximum negative bias for picture cut-off and apply the other voltages given under Typical Operating Conditions.
- (b) Check that the deflection circuits are functioning properly and adjust the scanning amplitude controls so that a maximum area of the photoconductive layer will be scanned.
- (c) Set the signal electrode voltage to give the signal current specified for the particular condition of operation. The table above gives an indication of the ranges of signal electrode voltage required for three conditions of operation. For other conditions of operation, reference should be made to the light transfer characteristic and the graph showing range of signal electrode voltage to produce a given dark current and therefore a given sensitivity. It is preferable, if possible, to adjust the dark current to the specified value for the particular condition of operation; 7735B tubes will have substantially identical performances when operated with identical values of dark current.

The magnitude of dark current non-uniformities as well as lag increase with signal electrode voltage; therefore operation at low values of signal electrode voltage helps to minimize these effects.

- (d) Decrease grid 1 voltage from its maximum negative value until a signal is produced.
- (e) Adjust grid 3 (beam focus) voltage, the lens stop and the optical focus alternately to obtain the best focused picture with the peak signal output current specified under Typical Performance Data.



- (f) Adjust the lens aperture and signal electrode voltage to produce the desired output signal. Lag decreases with increase in illumination on the faceplate.
- (g) Adjust the alignment field so that the centre of the picture does not move as grid 3 (beam focus) voltage is rocked slightly. Adjust grid 1 (beam current) voltage to provide sufficient beam to just discharge the highlights. It is permissible to set the alignment fields slightly off the minimum movement position to maintain signal uniformity.
- (h) Adjust the deflection amplitude and position to scan an area 0.500 inch x 0.375 inch. This is facilitated by the use of a perspex mask inscribed with circles 0.500 inch and 0.375 inch diameter, placed in contact and concentric with the faceplate of the tube. Light is allowed to fall on the photoconductive layer and an image of the rings is obtained on the monitor. No lens is necessary. The scan amplitude and centring controls are adjusted until the diameter of the larger circle is equal to the width of the raster and that of the smaller equal to the height.
- (j) Centre the raster in the useful area of the photoconductive layer and check the alignment (step g).
- (k) If the picture is faint, even with adequate video gain, open the lens iris more and, if necessary, increase the signal electrode voltage.
- (l) Repeat steps (e) to (g) until optimum picture reproduction is obtained.

## NOTES

1. This capacitance, which effectively is the output impedance of the 7735B, is increased when the tube is mounted in a deflecting yoke and focusing coil assembly. The resistive component of the output impedance is of the order of 100 megohms.
2. The horizontal scan should be parallel to the plane passing through the tube axis and the blank key-pin position. The masking is for orientation only and does not define the proper scanned area.
3. When the tube is subjected to vibration the mounting position should not be vertical with the base uppermost.
4. The direction of the focusing current should be such that a north pole is attracted to the image end of the focusing coil. The distance from the faceplate to the beginning of the winding is 0.750 inch (19mm) approximately.
5. The alignment coil should be located so that its centre is 3.69 inches (93.7mm) from the faceplate of the tube. Its axis should be coincident with the axis of the tube, the deflecting yoke and the focusing coil.



6. Grid 3 voltage is adjusted for the best focus. The resolution, uniformity of focus and picture quality decrease with decreasing grid 3 voltage and in general grid 3 should not be operated below 250V.
7. The blanking voltage required when applied to the cathode is less than that required when applied to grid 1 as the former reduces the potential difference between the cathode and the scanned side of the target.
8. The video amplifier must be designed to handle signal currents of this magnitude.
9. Adjust the current through the alignment coils until the centre of the test pattern does not move as grid 3 voltage is varied through focus.
10. Unless the temperature of the faceplate is maintained at a constant value within this range, the dark current and performance will drift from the optimum performance established on initial setting up.
11. Percentage of initial value of signal output current remaining 3 field periods after light is cut off (i.e. 50ms in American standard systems and 60ms in European systems), with an initial highlight signal current of  $0.3\mu\text{A}$  and dark current of  $0.025\mu\text{A}$  approx.
12. Measured with a high gain, low noise, cascode type pre-amplifier having a bandwidth of 5.1MHz and a peak signal output current of  $0.35\mu\text{A}$ . The visual equivalent signal to noise ratio is taken as the ratio of the highlight signal output current to the r.m.s. noise current, multiplied by a factor of 3. (Ref. Otto H. Schade, 'Electro-optical Characteristics of Television Systems; Introduction and Part 1 - Characteristics of Vision and Visual Systems', RCA Review, March 1948.)
13. This test is carried out with a faceplate illumination of 2.0 foot-candle (21.5 lux) [e.g. a scene brightness of 400ft-lamberts ( $1370\text{cd}/\text{m}^2$ ) with lens aperture f/6.3 and transmission 75%], scanned area of 0.5 by 0.375 inch and signal current  $0.3\mu\text{A}$ . The test pattern shown is used to define the picture zones.

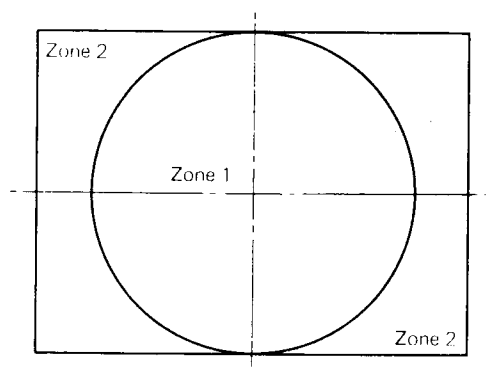

2074

The limitations on size and number of spots will be according to the following table. Spots having a contrast ratio less than 1.5:1 for white spots and 2:1 for black spots are not counted. Smudges, streaks, or mottled or grainy background must have a contrast ratio of 1.5:1 to be cause for rejection.

Spot size as equivalent number of raster lines in a 625 line system	Zone 1	Zone 2
over 3	0	0
3 to but not including 1	1	2
1 and under	*	*

Minimum separation between any two spots greater than 1 line is 16 lines.

\* Spots of this size may be present in unlimited numbers unless their concentration causes a smudged appearance.

14. For example, a scene brightness of approximately 86ft-lamberts ( $295\text{cd/m}^2$ ) with lens aperture f/4 and a transmission of 75% produces 1 foot-candle (10.76 lux) illumination on the faceplate.
15. The signal output current is the highlight signal electrode current during one frame after the dark current component has been subtracted. Signal currents higher than  $0.3\mu\text{A}$  may be used depending on requirements.
16. The signal electrode voltage for each 7735B must be adjusted to that value which gives the desired operating current. The indicated range of target voltage for each operational condition is given to illustrate the operating voltage range normally encountered. See also step (c) in Sequence of Camera Adjustments.
17. The deflecting circuits must provide extremely linear scanning for good black level reproduction under these conditions. Dark current is proportional to the scanning velocity. Any change in scanning velocity produces a black level error in direct proportion to the change in velocity of scanning.



# TYPICAL SPECTRAL SENSITIVITY CHARACTERISTIC

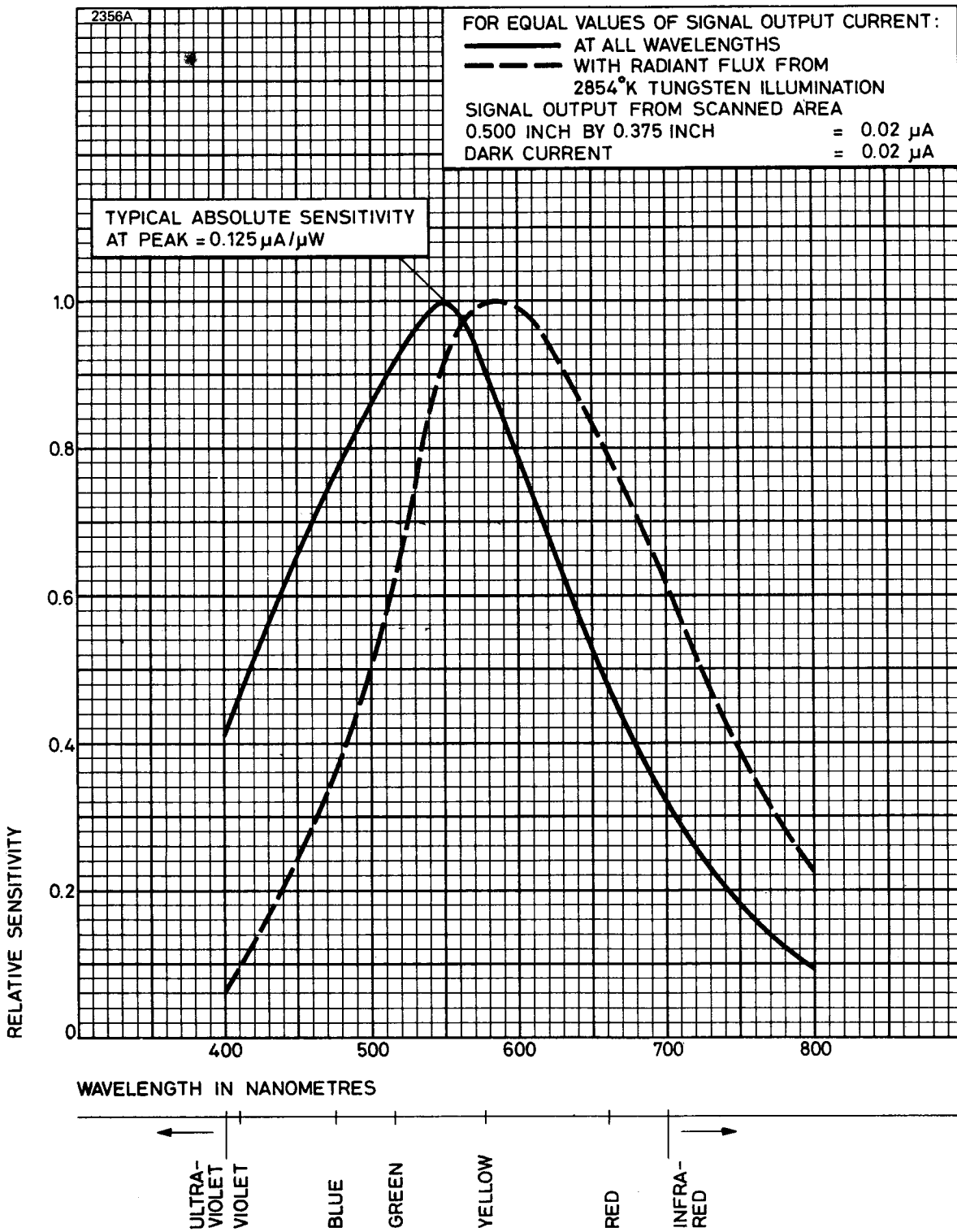

# TYPICAL RESOLUTION

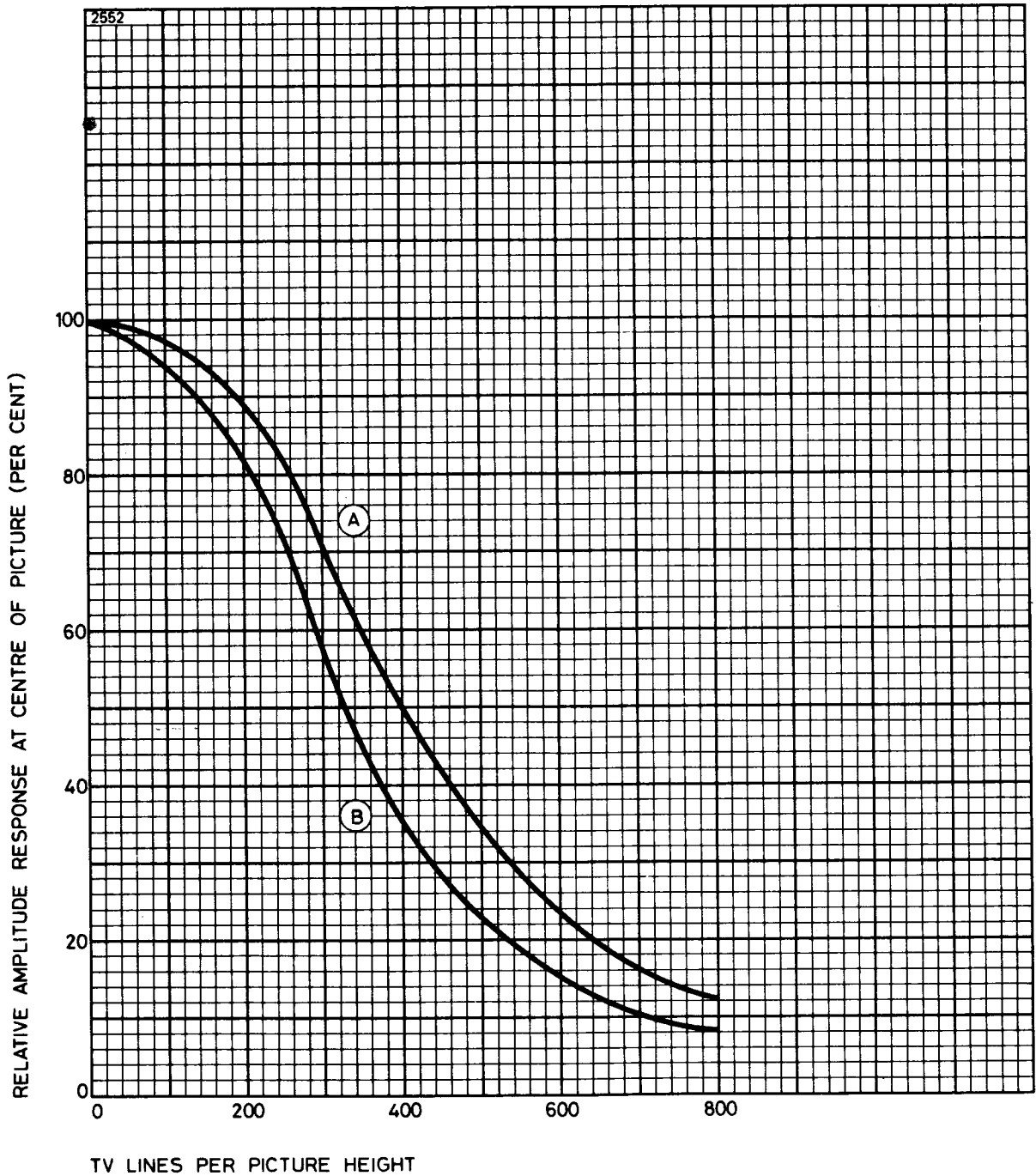

Highlight signal electrode current	. . . . .	0.35	$\mu$ A
Dark current	. . . . .	0.02	$\mu$ A
Test pattern	. . . . .	square wave resolution wedge transparency	
Video amplifier response	. . . . .		flat
Curve A	. . . . .		grid 3 at 750V
Curve B	. . . . .		grid 3 at 300V



# TYPICAL LIGHT TRANSFER CHARACTERISTICS

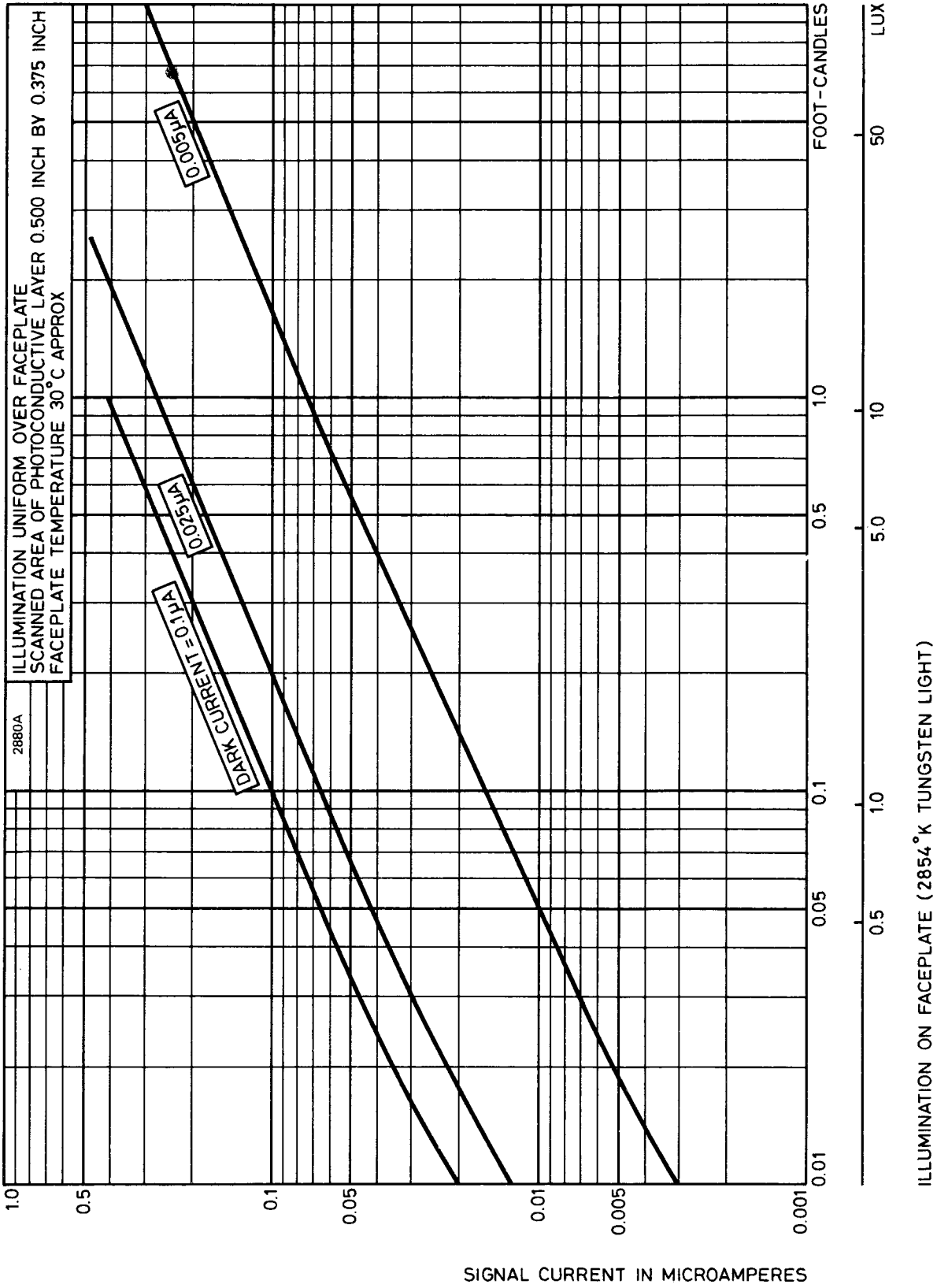

# TYPICAL RANGE OF DARK CURRENT

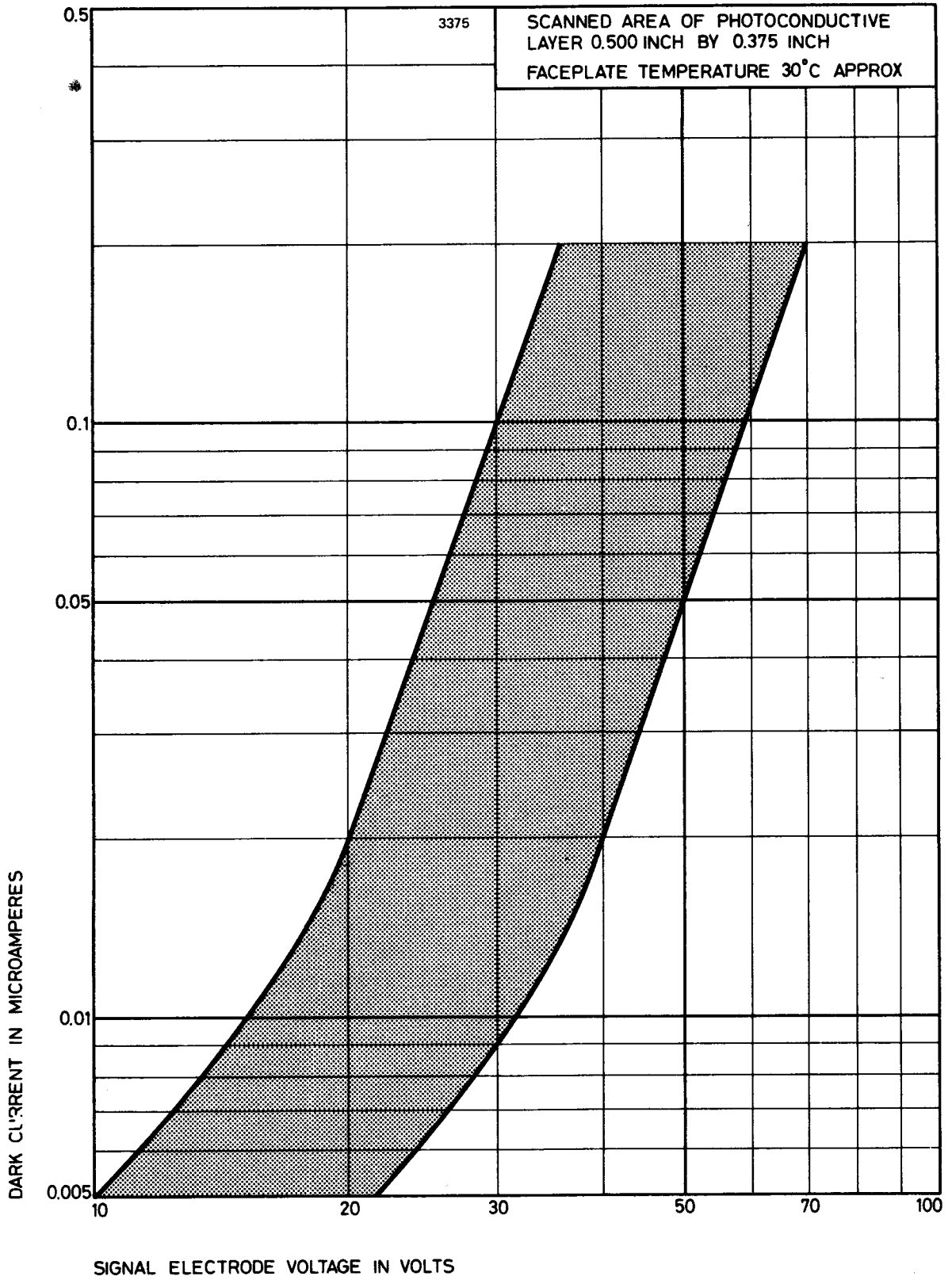

# OUTLINE (All dimensions without limits are nominal)

2157A

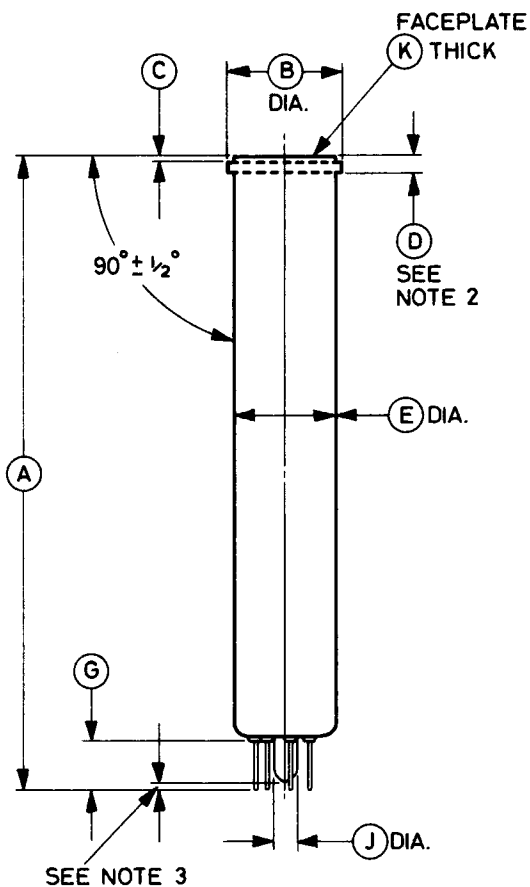
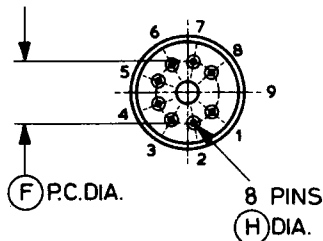
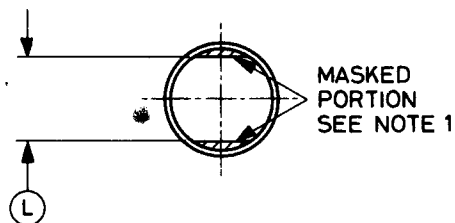

Pin	Element
1	Heater
2	Grid 1
3	Internal connection
4	Internal connection
5	Grid 2
6	Grid 3
7	Cathode
8	Heater
9	Key pin position, blank
Flange	Signal electrode

## NOTES

1. The straight sides are parallel to the plane passing through the tube axis and pin position 9.
2. Signal electrode contact flange may be located along the tube axis in any part of or all of the space between the dashed lines.
3. The seal-off will not project beyond the pins.

Ref	Inches	Millimetres
A	6.250 ± 0.125	158.8 ± 3.2
B	1.125 ± 0.010	28.58 ± 0.25
C	0.050 max	1.27 max
D	0.175	4.45
E	1.020 + 0.030 - 0.035	25.91 + 0.76 - 0.89
F	0.600	15.24

Ref	Inches	Millimetres
G	0.503 max	12.78 max
H	0.050 + 0.002 - 0.004	1.270 + 0.051 - 0.102
J	0.265 max	6.73 max
K	0.093 ± 0.005	2.36 ± 0.13
L	0.835 ± 0.035	21.21 ± 0.89

Millimetre dimensions have been derived from inches.



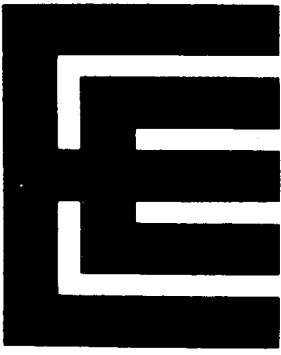

# 8051

## VIDICON

### INTRODUCTION

The 8051 is a 1½-inch diameter vidicon of high resolution capability, with magnetic deflection and focusing, designed especially for use in broadcast film pick-up or data-transmission applications.



This vidicon features a separate mesh electrode and a very uniform target layer. Limiting resolutions in the region of 2000 TV lines may be obtained in the centre of the picture, optimum resolution being achieved when the grid 3 voltage is 0.6 to 0.7 of the mesh voltage.

A 4 watt (6.3V, 0.6A) heater is used in this tube making it suitable for use in equipment designed for series heater operation or having poor heater voltage regulation.

December 1972

407

## GENERAL DATA

### Electrical

Cathode . . . . .	indirectly heated, oxide coated		
Heater voltage . . . . .	6.3	V	
Heater current . . . . .	0.6	A	
Inter-electrode capacitance, signal electrode to all other electrodes (average value) (see note 1) . . . . .	8.0	pF	
Spectral response . . . . .	see spectral sensitivity curve		
Focusing method . . . . .	magnetic		
Deflection method . . . . .	magnetic		

### Mechanical

Overall length . . . . .	8.000 inches (203.2mm) max		
Overall diameter . . . . .	1.600 inches (40.64mm) max		
Useful size of rectangular image; diagonal, centrally situated . . . . .	1.000 inch (25.4mm) max		
Orientation . . . . .	see note 2		
Net weight . . . . .	5.3 ounces (150g) approx		
Mounting position (see note 3) . . . . .	any		
Base . . . . .	small button super-ditetrar 8-pin (JEDEC no. E8-78)		

### Associated Components

Focusing-alignment assembly (see note 4) . . . . .	Cleveland Electronics 15-VFA-259		
Deflection yoke . . . . .	Cleveland Electronics 15-VY-258		
Mating socket . . . . .	Alden no. 208-SBSDC (or equivalent)		

### Storage

Recommended store temperature . . . . .	15 to 35	°C	
---	----------	----	--

Tubes should be stored in darkness.

### WARNING

When operating a tube the following precautions must be observed:

1. Ensure that the temperature of the tube is within its recommended range.
2. Avoid excessive exposure to high levels of illumination otherwise permanent damage to the photoconductive surface may result.

## MAXIMUM AND MINIMUM RATINGS (Absolute values)

No individual rating to be exceeded.

	Min	Max	
Heater voltage . . . . .	5.7	6.9	V
Signal electrode voltage . . . . .	—	125	V
Grid 4 (mesh) voltage (see note 5) . . . . .	—	1500	V
Grid 3 (beam focus) voltage (see note 5) . . . . .	—	1500	V
Grid 2 (accelerator) voltage . . . . .	—	550	V
Grid 1 voltage:			
negative bias value . . . . .	—	300	V
positive bias value . . . . .	—	0	V
Peak heater to cathode voltage:			
heater negative with respect to cathode . . . . .	—	125	V
heater positive with respect to cathode . . . . .	—	10	V
Dark current . . . . .	—	0.25	μA
Peak signal electrode current (see note 6) . . . . .	—	0.6	μA
Faceplate temperature . . . . .	—	71	°C
Faceplate illumination . . . . .	—	1000	ft-candles
	—	10 760	lux

## TYPICAL OPERATION

### Operating Conditions (for scanned area of 0.6 x 0.8 inch)

The following values and notes are for general guidance and may vary from tube to tube.

Grid 4 (mesh) voltage (see note 5) . . . . .	1400	V
Grid 3 (beam focus) voltage (see notes 5 and 7) . . . . .	800 to 1000	V
Grid 2 (accelerator) voltage . . . . .	300	V
Grid 1 voltage for picture cut-off (with no blanking voltage on grid 1) . . . . .	—45 to —100	V
Blanking voltage, peak to peak:		
when applied to grid 1 (negative pulses) . . . . .	75	V
when applied to cathode (positive pulses) . . . . .	20	V
Field strength at centre of focusing coil (see notes 4 and 7) (approx) . . . . .	4.6	mT
	46	gauss
Peak deflection coil currents (approx):		
horizontal . . . . .	240	mA
vertical . . . . .	50	mA
Alignment field, adjustable (see note 8) . . . . .	0 to 0.4	mT
	0 to 4	gauss
Faceplate temperature (see note 9) . . . . .	30 to 35	°C

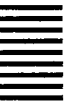

## Typical Performance

Limiting resolution at centre of picture (approx) . . . . .	2000	TV lines
Amplitude response to a 400 TV line square wave test pattern at centre of picture (approx) . . . . .	90	%
Lag (see note 10) . . . . .	25	%
'Gamma' of transfer characteristic for signal output between 0.02 and 0.6 $\mu$ A . . . . .	0.65	
Picture defects . . . . .		see note 11

	Condition		
	1†	2‡	
Faceplate illumination (highlights) (see note 14) . . . . .	10 108	50 540	ft-candles lux
Signal output current (peak) (see note 15) . . . . .	0.5	0.5	$\mu$ A
Approximate range of signal electrode voltage (see note 16) . . . . .	20–50	10–30	V
Dark current (see note 17) . . . . .	0.02	0.005	$\mu$ A

† See note 12

‡ See note 13

## SEQUENCE OF CAMERA ADJUSTMENTS

(For general operational conditions as shown on page 3)

- Set the grid 1 voltage for the maximum negative bias for picture cut-off and apply the other voltages given under Typical Operating Conditions.
- Check that the deflection circuits are functioning properly and adjust the scanning amplitude controls so that a maximum area of the photoconductive layer will be scanned.
- Set the signal electrode voltage to give the signal current specified for the particular condition of operation. The table above gives an indication of the ranges of signal electrode voltage required for two conditions of operation. For other conditions of operation, reference should be made to the light transfer characteristic and the graph showing the range of signal electrode voltage to produce a given dark current and therefore a given sensitivity. It is preferable, if possible, to adjust

the dark current to the specified value for the particular condition of operation; 8051 tubes will have substantially identical performances when operated with identical values of dark current.

The magnitude of non-uniformities of dark current, as well as lag, tend to increase with signal electrode voltage; therefore operation at low values of signal electrode voltage helps to minimize these effects.

- (d) Decrease grid 1 voltage from its maximum negative value until a signal is produced.
- (e) Adjust grid 3 (beam focus) or grid 3 and grid 4 (mesh) voltages, the lens stop and the optical focus alternately to obtain the best focused picture with the peak signal output current specified under Typical Performance.
- (f) Adjust the lens aperture and signal electrode voltage to produce the desired output signal. Lag decreases with increase in illumination on the faceplate.
- (g) Adjust the alignment field so that the centre of the picture does not move as grid 3 (beam focus) and grid 4 (mesh) voltages are rocked slightly. Adjust grid 1 (beam current) voltage to provide just sufficient beam to discharge the highlights. It is permissible to set the alignment fields slightly off the minimum movement position to maintain signal uniformity.
- (h) Adjust the deflection amplitude and position to scan an area 0.800 inch x 0.600 inch. This is facilitated by the use of a perspex mask inscribed with circles 0.800 inch and 0.600 inch diameter, placed in contact and concentric with the faceplate of the tube. Light is allowed to fall on the photoconductive layer and an image of the rings is obtained on the monitor. No lens is necessary. The scan amplitude and centring controls are adjusted until the diameter of the larger circle is equal to the width of the raster and that of the smaller equal to the height.
- (j) Centre the raster in the useful area of the photoconductive layer and check the alignment (step g).
- (k) If the picture is faint, even with adequate video gain, open the lens iris more and, if necessary, increase the signal electrode voltage.
- (l) Repeat steps (e) to (g) until optimum picture reproduction is obtained.



## NOTES

1. This capacitance, which in effect forms the output impedance of the tube, is increased when the tube is mounted in a deflecting yoke and focusing-alignment assembly. The resistive component of the output impedance is of the order of 100 megohms.
2. The horizontal scan should be parallel to the plane passing through the tube axis and the blank key-pin position. The masking is for orientation only and does not define the proper scanned area.
3. When the tube is subjected to vibration the mounting position must not be vertical with the base uppermost.
4. The direction of the focusing current should be such that a north pole is attracted to the image end of the focusing coil. The distance from the faceplate to the beginning of the winding is 0.75 inch approximately.
5. Grid 3 and grid 4 voltages are adjusted for the best focus. The resolution, uniformity of focus and picture quality decrease with decreasing grid 3 and grid 4 voltage. In general grid 3 should be at approximately 0.6 of grid 4 voltage.
6. The video amplifier must be designed to handle signal currents of this magnitude, to avoid picture distortion due to overloading of the amplifier.
7. It may be preferred to adjust beam focus by varying the focus coil current to obtain the field strengths indicated in the Typical Operating Conditions. If the focus coil field strength is fixed, beam focus may be obtained within a  $\pm 10\%$  range (approximately) of the grid 3 and grid 4 voltages. The ratio of 0.6 between grid 3 and grid 4 must be maintained as these voltages are varied.
8. Adjust the current through the alignment coils until the centre of the test pattern does not move as grid 3 and grid 4 voltages or the focus coil current are varied in and out of focus.
9. Unless the temperature of the faceplate is maintained at a constant value within this range, the dark current and performance will drift from the optimum performance established on initial setting up.

10. Percentage of initial value of signal output current remaining 3 field periods after light is cut off (i.e. 50ms in American standard systems and 60ms in European systems) with an initial highlight signal current of  $0.3\mu\text{A}$  and a faceplate illumination of 2 foot-candles.
11. This test is carried out with a faceplate illumination of 5.0 foot-candles (e.g. a scene brightness of 430 foot-lamberts with lens aperture  $f/4$  and transmission 75%), scanned area of 0.8 by 0.6 inch and signal current  $0.3\mu\text{A}$ . The test pattern shown is used to define the picture zones.

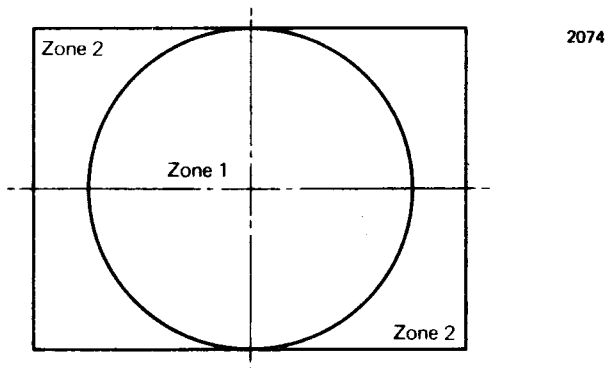

The limitations on size and number of spots will be according to the following table. Spots having a contrast ratio less than 1.5:1 for white spots and 2:1 for black spots are not counted. Smudges, streaks, or mottled or grainy background must have a contrast ratio of 1.5:1 to be cause for rejection.

Equivalent number of raster lines in a 625 line system	Number allowed	
	Zone 1	Zone 2
over 5	0	0
5 to but not including 4	0	1
4 to but not including 1	6	4
1 and under	*	*

\* Spots of this size may be present in unlimited numbers unless their concentration causes a smudged appearance.

12. Average sensitivity operation.
13. Minimum lag operation.
14. For example, a scene brightness of approximately 860 foot-lamberts ( $2950\text{cd/m}^2$ ) with lens aperture  $f/4$  and a transmission of 75% produces 10 foot-candles (108 lux) illumination on the faceplate.
15. The signal output current is the highlight signal electrode current during one frame after the dark current component has been subtracted. Signal currents higher than  $0.5\mu\text{A}$  may be used depending on requirements.
16. The signal electrode voltage for each tube is adjusted to that value which gives the desired operating signal current; the indicated range of signal electrode voltage for each operational condition is given to illustrate the variation normally encountered.
17. The deflecting circuits must provide linear scanning for good black level reproduction under these conditions. Dark current is proportional to the scanning velocity. Any change in scanning velocity produces a black level error in direct proportion to the change in velocity of scanning.



# TYPICAL SPECTRAL SENSITIVITY CHARACTERISTIC

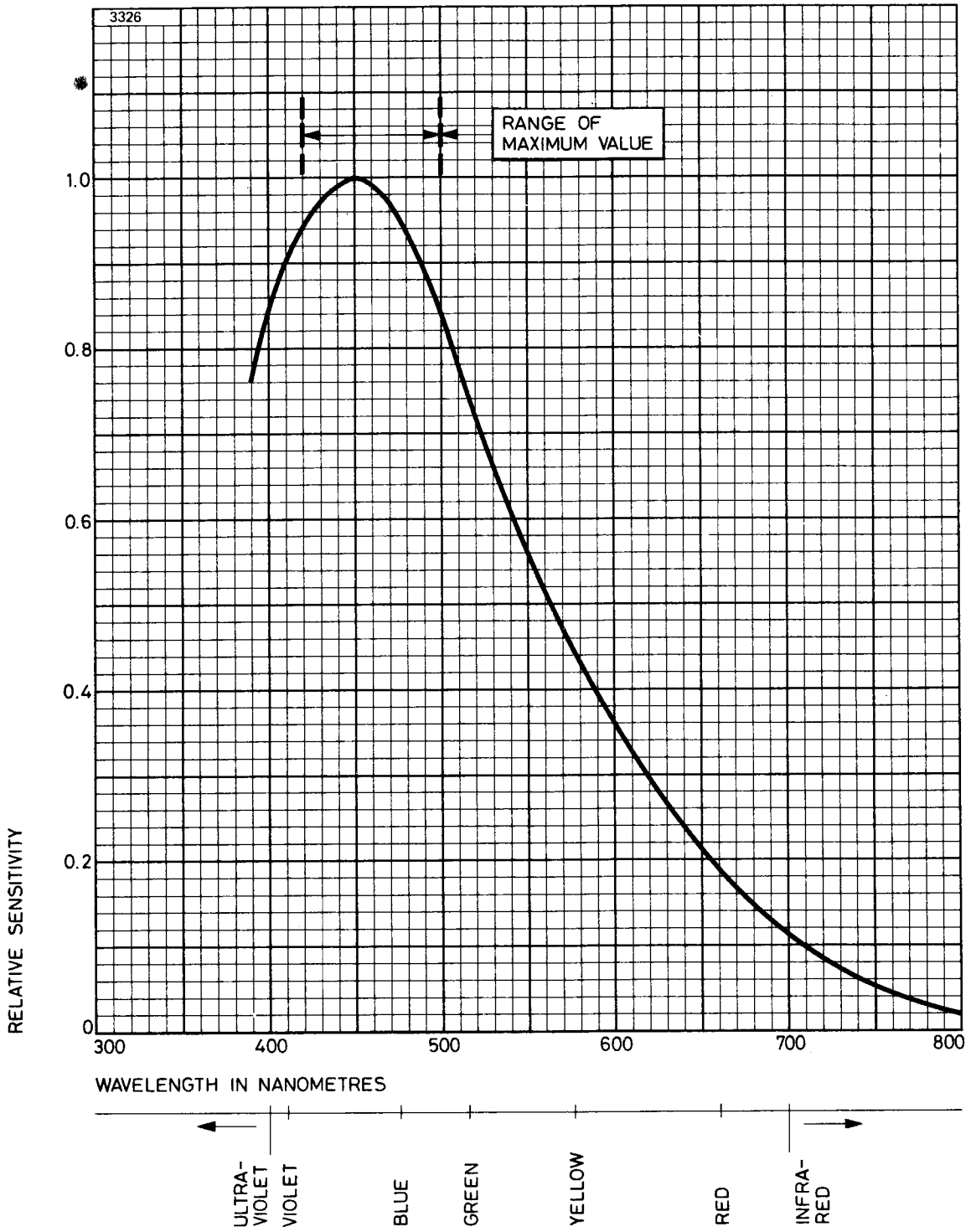

# TYPICAL RESOLUTION

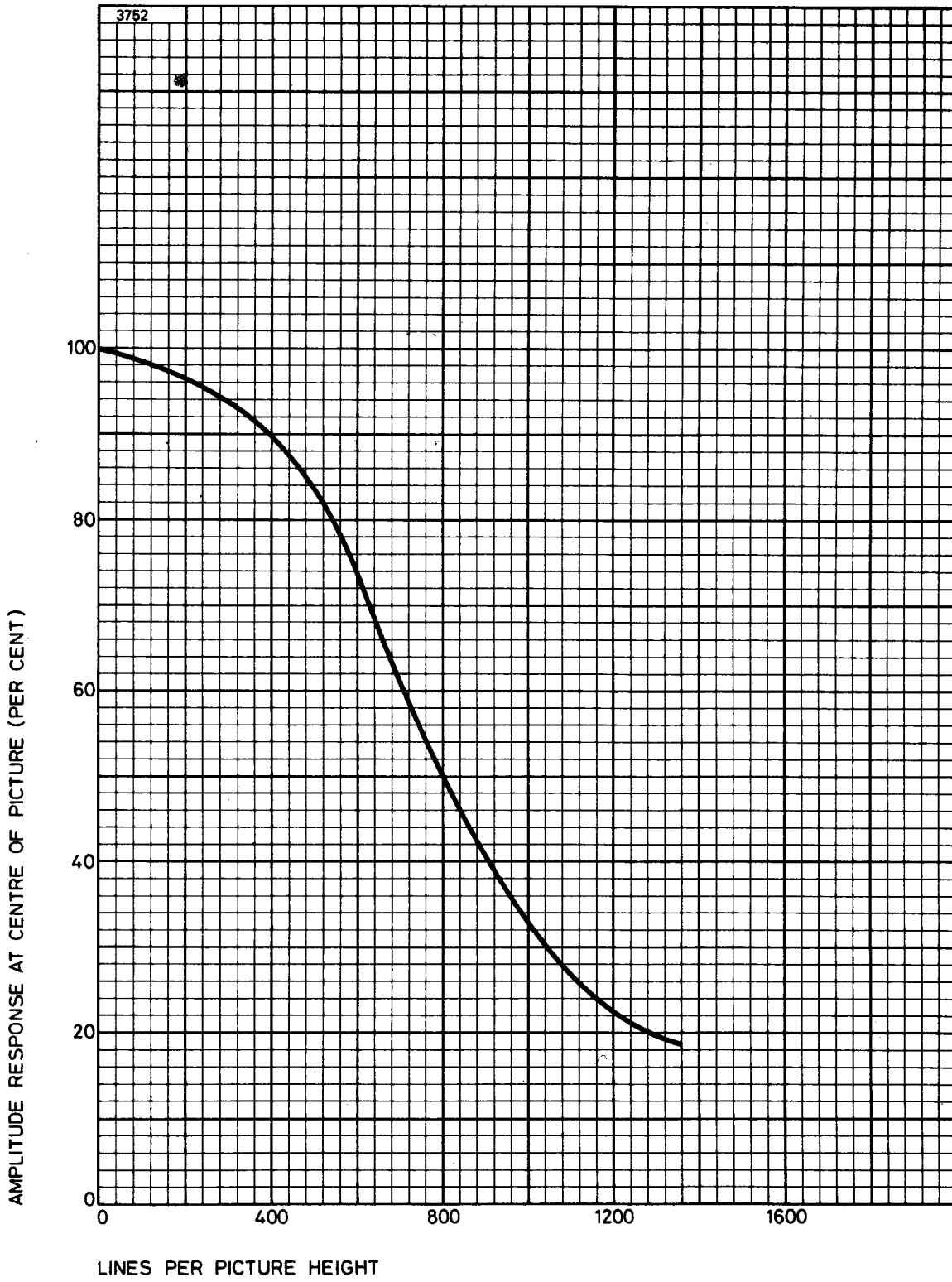

# TYPICAL LIGHT TRANSFER CHARACTERISTIC

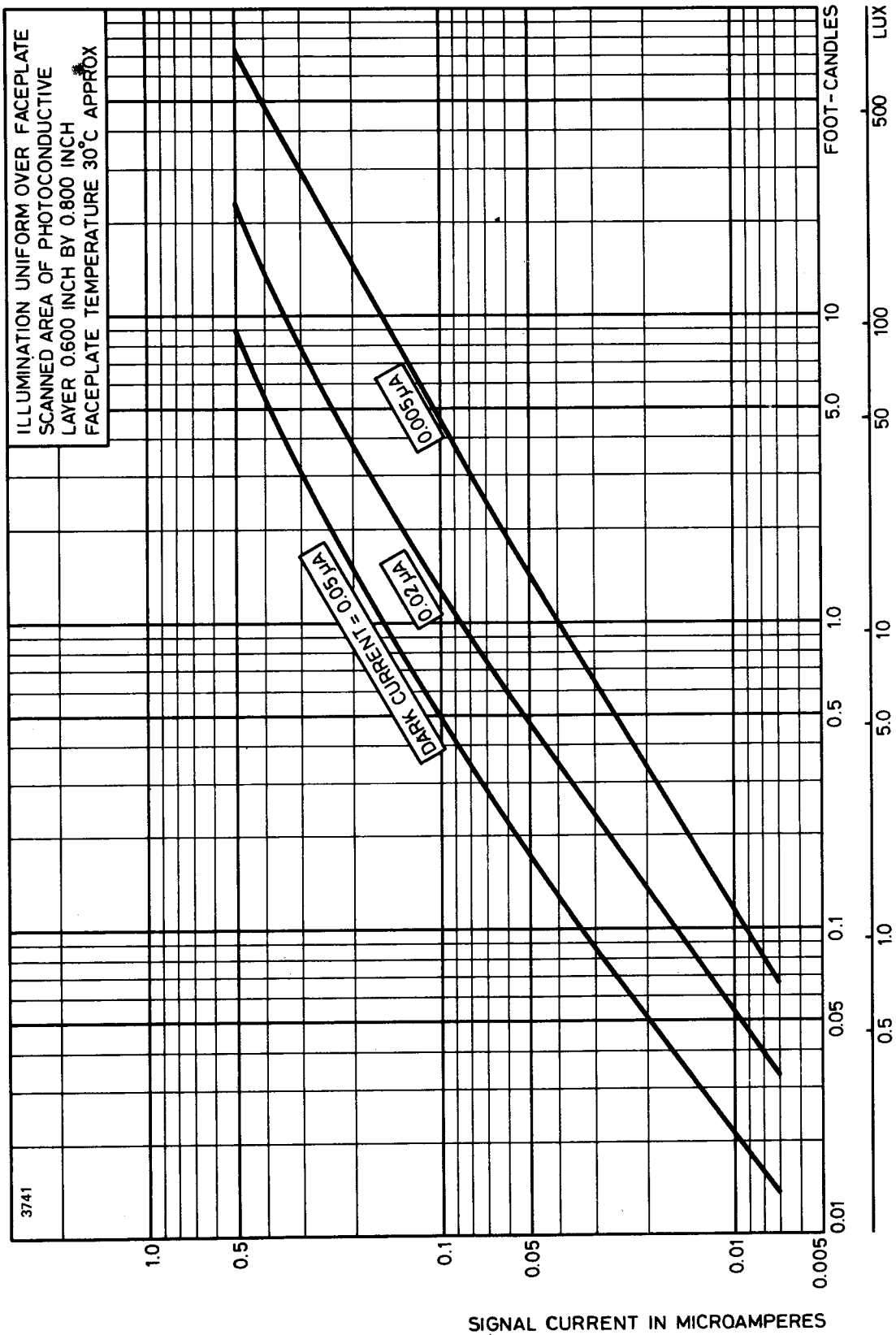

# TYPICAL RANGE OF DARK CURRENT

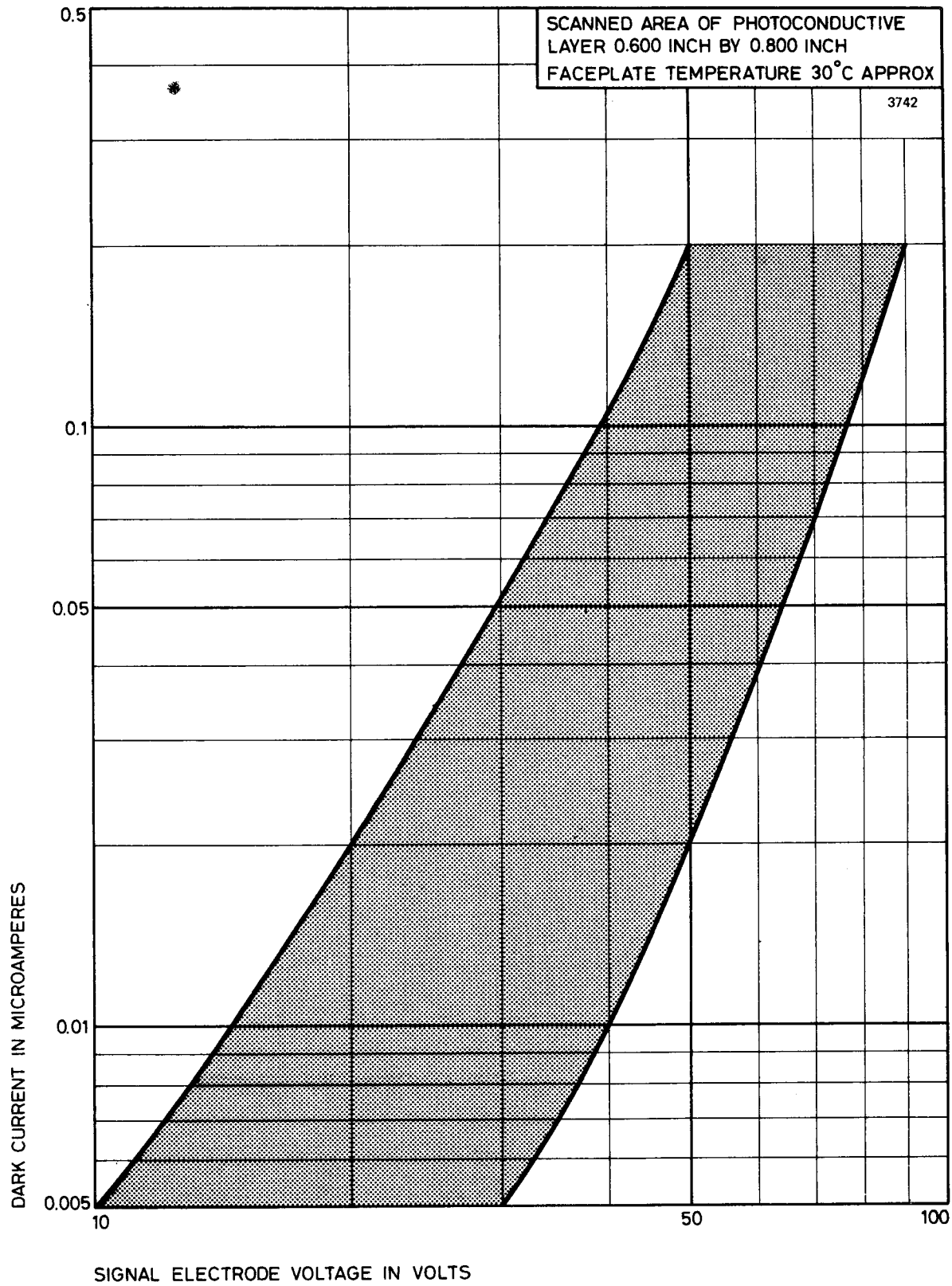

# TYPICAL LAG CHARACTERISTICS

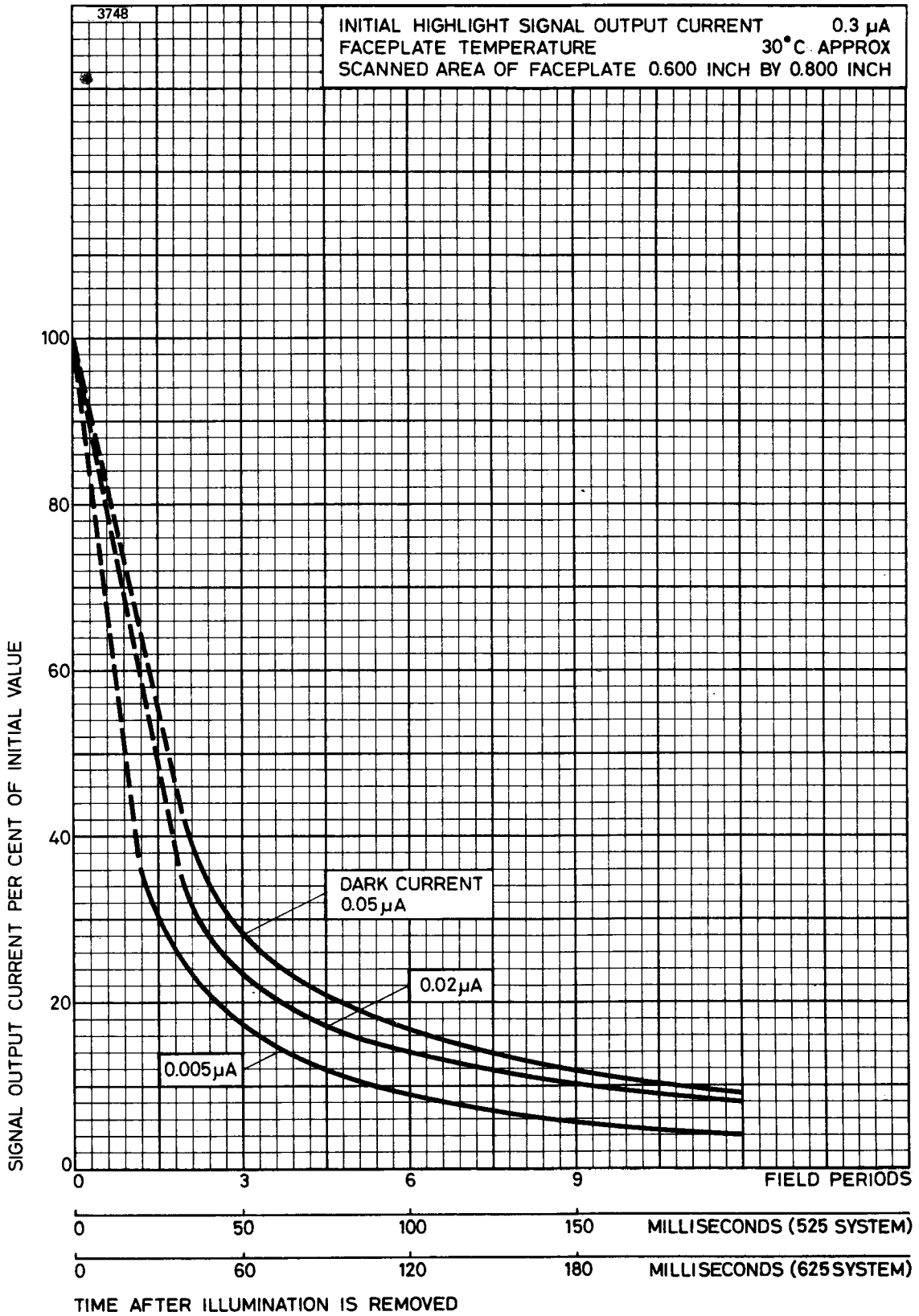

**OUTLINE (All dimensions without limits are nominal)**

3739

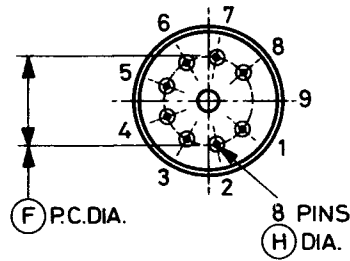
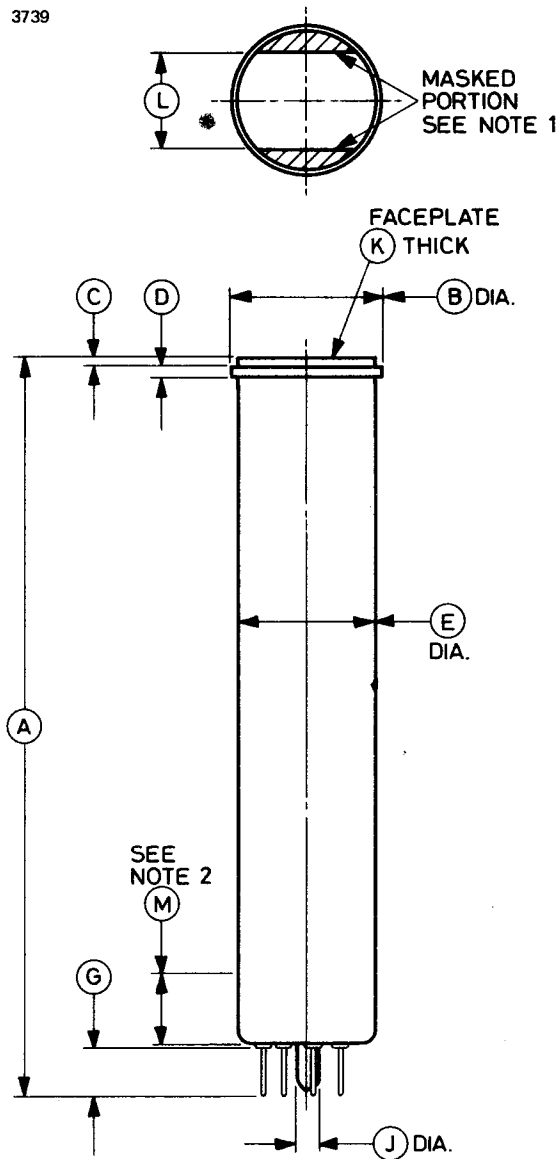

Pin	Element
1	Heater
2	Grid 1
3	Internal connection
4	Grid 4 (mesh)
5	Grid 2
6	Grid 3 (beam focus)
7	Cathode
8	Heater
9	Key pin position, blank
Flange	Signal electrode

**NOTES**

1. The straight sides are parallel to the plane passing through the tube axis and pin position 9.
2. The minimum diameter does not apply over this length.

Ref	Inches	Millimetres
A	7.750 ± 0.250	196.85 ± 6.35
B	1.590 ± 0.010	40.39 ± 0.25
C	0.085 ± 0.010	2.16 ± 0.25
D	0.125	3.18
E	1.500 ± 0.010	38.10 ± 0.25
F	0.900	22.86
G	0.503 max	12.78 max

Ref	Inches	Millimetres
H	0.050 + 0.002 - 0.004	1.270 + 0.051 - 0.102
J	0.265 max	6.73 max
K	0.135 ± 0.005	3.43 ± 0.13
L	1.000 ± 0.050	25.40 ± 1.27
M	0.750	19.05

Millimetre dimensions have been derived from inches.



### INTRODUCTION

The 8134 is a 1-inch diameter vidicon with magnetic deflection and electrostatic focusing, designed for live pick-up in black and white TV cameras. It is also satisfactory for film pick-up either in black and white or colour. The use of electrostatic focusing makes possible a considerable reduction in the size, weight and power requirements of the camera, compared with magnetically focused types; a further feature of the 8134 is its low power heater which operates at 0.6W (95mA heater current).

The high sensitivity and low lag properties of the 8134 photoconductive surface allow it to be used under normal lighting conditions encountered in industrial and studio applications. The uniformity of the layer enables uniform dark current and improved uniformity of sensitivity over the scanned area to be obtained, provided that suitable associated deflecting components are used which do not introduce scanning beam landing errors.

### GENERAL DATA

#### Electrical

Cathode . . . . .	indirectly heated, oxide coated	
Heater voltage . . . . .	6.3	V
Heater current . . . . .	95	mA
Inter-electrode capacitance, signal electrode to all other electrodes (average value) (see note 1) . . . . .	5.0	pF
Spectral response . . . . .	see spectral sensitivity curve	
Focusing method . . . . .	electrostatic	
Deflection method . . . . .	magnetic	



## Mechanical

Overall length . . . . .	6.380 inches (162.1 mm) max
Overall diameter . . . . .	1.135 inches (28.9mm) max
Useful size of rectangular image; diagonal, centrally situated . . . . .	0.63 inches (15.9mm) max
Orientation of rectangular image . . . . .	see note 2
Net weight . . . . .	2.4 ounces (70g) approx
Mounting position (see note 3) . . . . .	any
Base . . . . .	small button ditetrar 8-pin (JEDEC no. E8-11)

## Associated Components

Deflection yoke and alignment coil (see note 4) . . . . .	Cleveland Electronics VYA-300
Base socket . . . . .	Type R41-79502 by United Carr Fasteners Ltd. (or equivalent)

## Storage

Recommended store temperature . . . . . 15 to 35 °C  
Tubes should be stored in darkness.



## WARNING

When operating a tube the following precautions should be observed:

1. Ensure that the temperature of the tube is within its recommended range.
2. Avoid over exposure of stationary pictures, e.g. test patterns, or after-image may result.
3. A surge limiting device must be incorporated if necessary to ensure that the heater current does not exceed 150mA when switching on or at any other time.



**MAXIMUM AND MINIMUM RATINGS (Absolute values)**

No individual rating should be exceeded.

	<b>Min</b>	<b>Max</b>	
Heater voltage . . . . .	5.7	6.9	V
Signal electrode voltage . . . . .	—	100	V
Grid 6 and grid 3 voltage (see note 5) . . . . .	—	1350	V
Grid 5 voltage (see note 6) . . . . .	—	1000	V
Grid 4 voltage . . . . .	—	400	V
Grid 2 voltage . . . . .	—	850	V
Grid 1 voltage:			
negative bias value . . . . .	—	300	V
positive bias value . . . . .	—	0	V
Blanking voltage, peak to peak (see note 7):			
when applied to grid 1 (negative pulses) . . . . .	40	—	V
when applied to cathode (positive pulses) . . . . .	10	—	V
Peak heater to cathode voltage:			
heater negative with respect to cathode . . . . .	—	125	V
heater positive with respect to cathode . . . . .	—	10	V
Dark current . . . . .	—	0.25	$\mu$ A
Peak signal electrode current (see note 8) . . . . .	—	0.6	$\mu$ A
Faceplate temperature . . . . .	—	71	$^{\circ}$ C
Peak illumination of faceplate (see note 9) . . . . .	—	5000	ft-candle
	—	54 000	lux



## TYPICAL OPERATION

### Typical Operating Conditions (for scanned area 0.5 x 0.375 inch)

The following values and notes are for general guidance and may vary from tube to tube.

	Low voltage	Inter- mediate voltage	High voltage	
Grid 6 (decelerator) and grid 3 voltage . . . . .	300	500	750	V
Grid 5 voltage . . . . .	180	300	450	V
Grid 4 (beam focus) voltage	20 to 60	50 to 100	90 to 150	V
Grid 2 (accelerator) voltage . . . . .		300		V
Grid 1 voltage for picture cut-off (with no blanking voltage on grid 1) . . . . .		-45 to -100		V
Blanking voltage, peak to peak:				
when applied to grid 1 (negative pulses) . . . . .		75		V
when applied to cathode (positive pulses) . . . . .		20		V
Peak deflection coil currents (see note 4):				
horizontal . . . . .	95	110	125	mA
vertical . . . . .	10	12	14	mA
Alignment field, adjustable (see note 4) . . . . .		0 to 0.1		mT
		0 to 1		gauss
Faceplate temperature (see note 10) . . . . .		30 to 35		°C

### Typical Performance

Limiting resolution at centre of picture (approx) . . . . .	600	700	800	TV lines
Amplitude response (see note 11) . . . . .	17	25	33	%
Grid 6 and grid 3 current . . . . .	1.7	2.5	3.0	μA
Grid 5 current . . . . .	0.05	0.2	0.3	μA
Grid 4 current . . . . .	0.0015	0.006	0.008	μA
Grid 2 current . . . . .	375	450	500	μA

Continued on page 5

**Typical Performance (continued)**

Lag (see note 12)	20	%
Visual equivalent signal to noise ratio (see note 13)	300:1	approx
'Gamma' of transfer characteristic for signal output between 0.02 and 0.2 $\mu$ A	0.65	

	<b>Average sensitivity</b>	<b>High sensitivity</b>	
Faceplate illumination (highlights) (see note 14)	1.0	0.1	ft-candle
	10.8	1.08	lux
Signal output current (peak) (see note 15):			
typical	0.265	0.1	$\mu$ A
minimum	0.250	—	$\mu$ A
Approximate range of signal electrode voltage (see note 16)	25 to 48	30 to 60	V
Dark current (see note 17)	0.035	0.1	$\mu$ A

**SEQUENCE OF CAMERA ADJUSTMENTS**

**(For general operational conditions as shown on page 4)**

- (a) Set the grid 1 voltage for the maximum negative bias for picture cut-off and apply the other voltages given under Typical Operating Conditions.
- (b) Check that the deflection circuits are functioning properly and adjust the scanning amplitude controls so that a maximum area of the photoconductive layer will be scanned.
- (c) Set the signal electrode voltage to give the signal current specified for the particular condition of operation. The range of signal electrode voltage above gives an indication of the voltage required.

The magnitude of non-uniformities of dark current, as well as lag, tend to increase with signal electrode voltage; therefore operation at low values of signal electrode voltage helps to minimize these effects. The

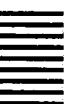
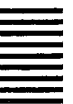

table on page 5 indicates the ranges of signal electrode voltage required for two conditions of operation. For other conditions of operation, reference should be made to the light transfer characteristic and the graph showing the range of signal electrode voltage to produce a given dark current and therefore a given sensitivity. It is preferable, if possible, to adjust the dark current to the specified value for the particular condition of operation; 8134 tubes will have substantially identical performances when operated with identical values of dark current.

- (d) Decrease grid 1 voltage from its maximum negative value until a signal is produced.
- (e) Adjust grid 4 (beam focus) voltage, the lens stop and the optical focus alternately to obtain the best focused picture with the peak signal output current specified under Typical Performance Data.
- (f) Adjust the lens aperture and signal electrode voltage to produce the desired output signal. Lag decreases with increase in illumination on the faceplate.
- (g) Adjust the alignment field so that the centre of the picture does not move as grid 4 (beam focus) voltage is rocked slightly. Adjust grid 1 (beam current) voltage to provide sufficient beam to just discharge the highlights. It is permissible to set the alignment fields slightly off the minimum movement position to maintain signal uniformity.
- (h) Adjust the deflection amplitude and position to scan an area 0.500 inch x 0.375 inch. This is facilitated by the use of a perspex mask inscribed with circles 0.500 inch and 0.375 inch diameter, placed in contact and concentric with the faceplate of the tube. Light is allowed to fall on the photoconductive layer and an image of the rings is obtained on the monitor. No lens is necessary. The scan amplitude and centring controls are adjusted until the diameter of the larger circle is equal to the width of the raster and that of the smaller equal to the height.
- (j) Centre the raster in the useful area of the photoconductive layer and check the alignment (step g).
- (k) If the picture is faint, even with adequate video gain, open the lens iris more and, if necessary, increase the signal electrode voltage.
- (l) Repeat steps (e) to (g) until optimum picture reproduction is obtained.

## NOTES

1. This capacitance, which in effect forms the output impedance of the 8134, is increased when the tube is mounted in a deflecting yoke assembly. The resistive component of the output impedance is of the order of 100 megohms.
2. The horizontal scan should be parallel to the plane through the tube axis and the blank index pin position. The masking is for orientation only and does not define the proper scanned area.
3. When the tube is subjected to vibration the mounting position should not be vertical with the base uppermost.
4. Use an approved deflection yoke and alignment coil such as Cleveland Electronics VYA-300. For the deflection yoke, the distance from the faceplate to the beginning of the winding is 0.750 inch (19mm) approx. The alignment coil should be located so that its centre is 4.940 inches (125.5mm) from the faceplate of the tube. Its axis should be coincident with the axis of the tube and the deflecting yoke.
5. The ratio of grid 6 and grid 3 voltage to grid 5 voltage should be fixed at a value between 1.67, which gives the best picture geometry, and 2.0, which gives the most uniform signal output. The resolution, uniformity of focus and picture quality decrease with decreasing grid 6 and grid 3 voltage and grid 5 voltage. In general grid 6 and grid 3 should be operated at or above 300V and grid 5 at or above 180V.
6. The voltage between grid 5 and grids 6 and 3 should not exceed 750V.
7. The blanking voltage required when applied to the cathode is less than that required when applied to grid 1 as the former reduces the potential difference between the cathode and the scanned side of the target.
8. The video amplifier must be designed to handle signal currents of this magnitude.
9. For 'white light' uniformly diffused over faceplate.
10. Unless the temperature of the faceplate is maintained at a constant value within this range, the dark current and performance will drift from the optimum performance established on initial setting up.
11. Amplitude at 400 lines per picture height at the centre of the picture, relative to the large area black-white signal.



12. Percentage of initial value of signal output current remaining 3 field periods after light is cut off (i.e. 50ms in American standard systems and 60ms in European systems), with an initial highlight signal current of  $0.3\mu\text{A}$  and dark current of  $0.02\mu\text{A}$ .
13. Measured with a high gain, low noise, cascode type pre-amplifier having a bandwidth of 5.1MHz and a peak signal output current of  $0.35\mu\text{A}$ . The visual equivalent signal to noise ratio is taken as the ratio of the highlight signal output current to the r.m.s. noise current, multiplied by a factor of 3. (Ref. Otto H. Schade, 'Electro-optical Characteristics of Television Systems; Introduction and Part 1 - Characteristics of Vision and Visual Systems', RCA Review, March 1948).
14. For example, a scene brightness of approximately 170ft-lamberts ( $580\text{cd}/\text{m}^2$ ) with lens aperture f/5.6 and a transmission of 75% produces 1.0 foot-candle (10.8 lux) illumination on the faceplate.
15. The signal output current is the highlight signal electrode current during one frame after the dark current component has been subtracted. Signal currents higher than  $0.3\mu\text{A}$  may be used depending on requirements.
16. The signal electrode voltage for each 8134 must be adjusted to that value which gives the desired operating current. The indicated range of target voltage for each operational condition is given to illustrate the operating voltage range normally encountered. See also step (c) in Sequence of Camera Adjustments.
17. The deflecting circuits must provide extremely linear scanning for good black level reproduction under these conditions. Dark current is proportional to the scanning velocity. Any change in scanning velocity produces a black level error in direct proportion to the change in velocity of scanning.

# TYPICAL SPECTRAL SENSITIVITY CHARACTERISTIC

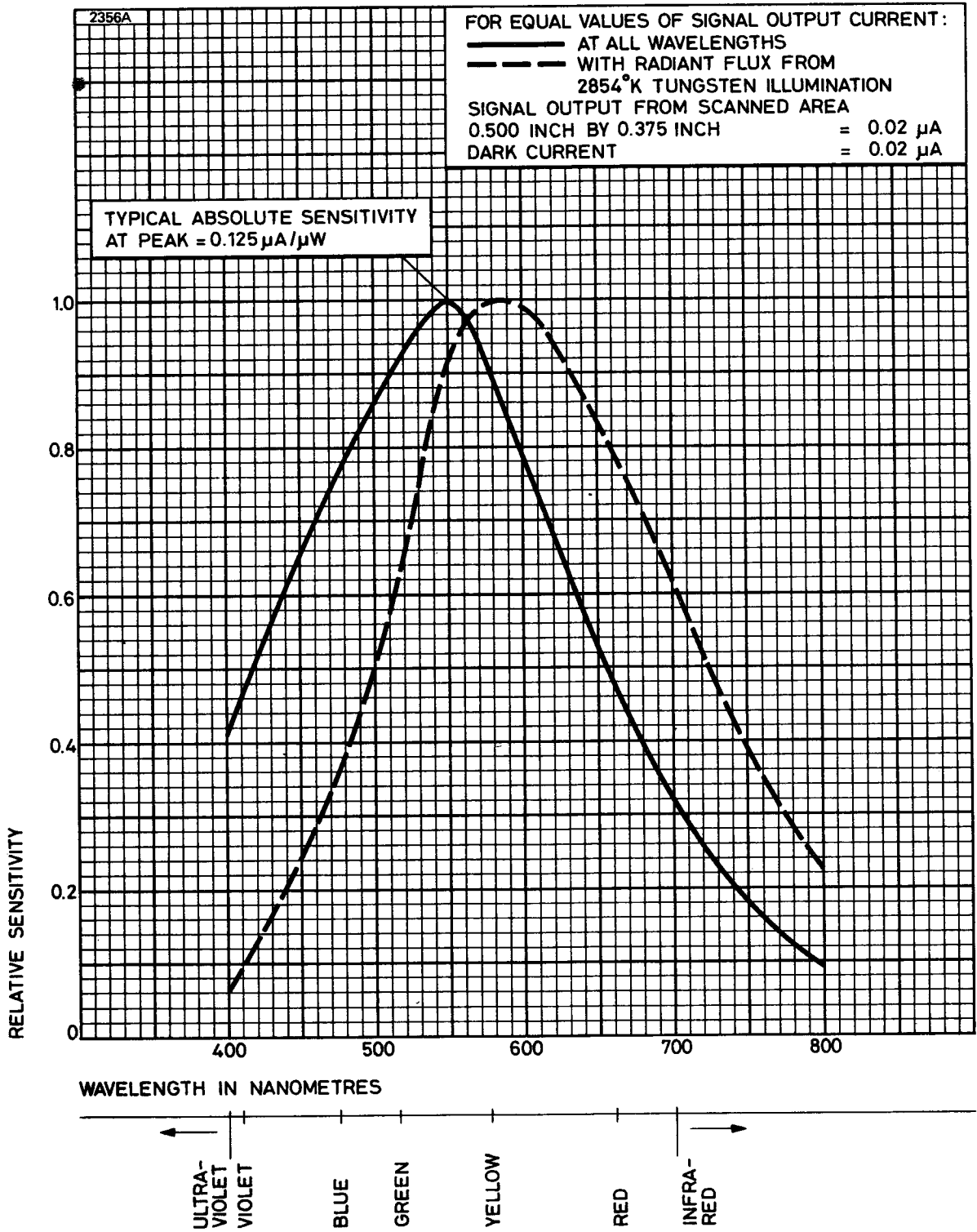

# TYPICAL RESOLUTION

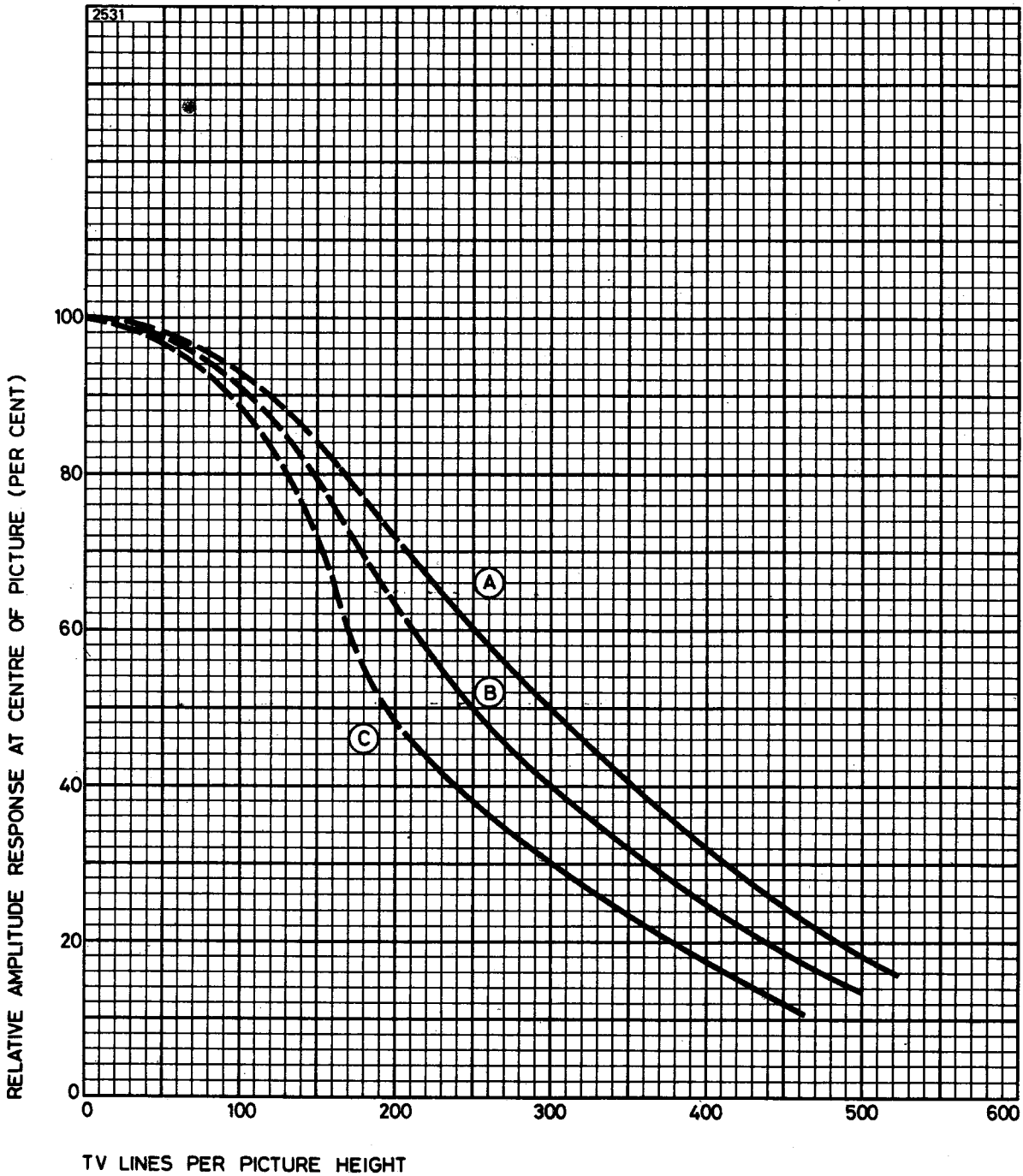

	Curve A	Curve B	Curve C	
Grid 6 and grid 3 voltage . . . . .	750	500	300	V
Grid 5 voltage . . . . .	450	300	180	V
Highlight signal output current . . . . .		0.3		$\mu$ A
Dark current . . . . .		0.02		$\mu$ A
Test pattern . . . . .	square wave resolution wedge transparency			



# TYPICAL LIGHT TRANSFER CHARACTERISTICS

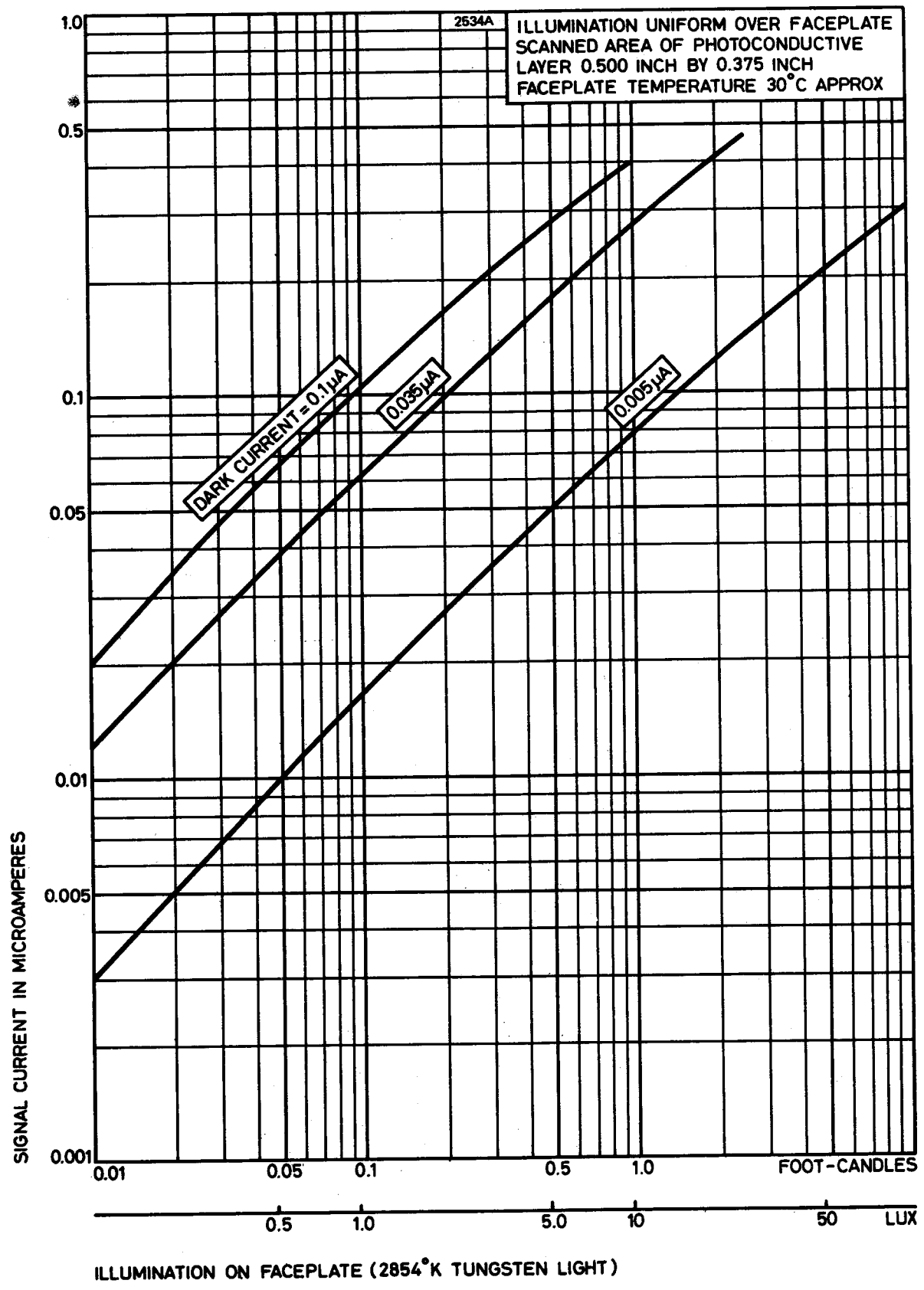

# TYPICAL RANGE OF DARK CURRENT

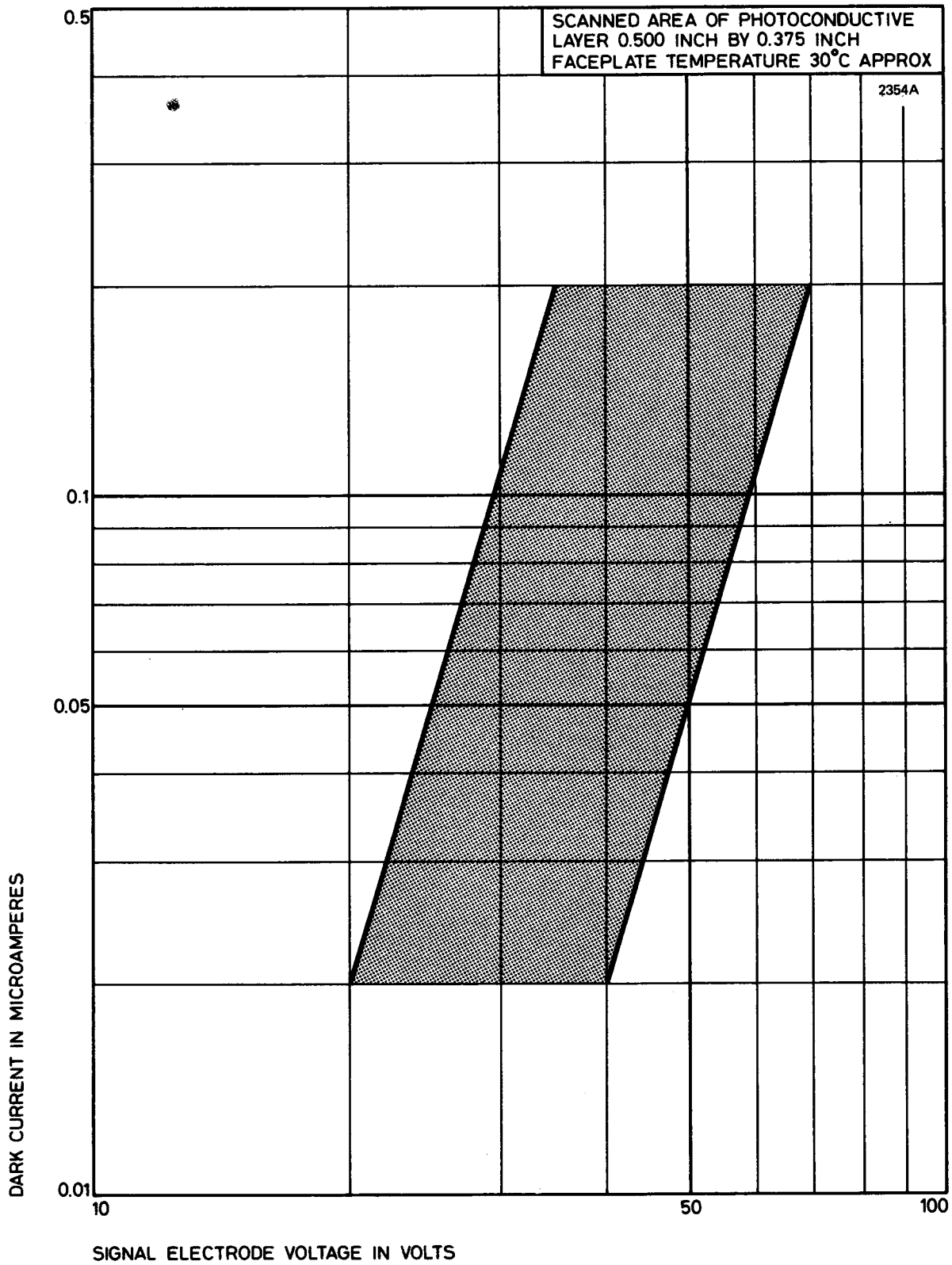

# OUTLINE (All dimensions without limits are nominal)

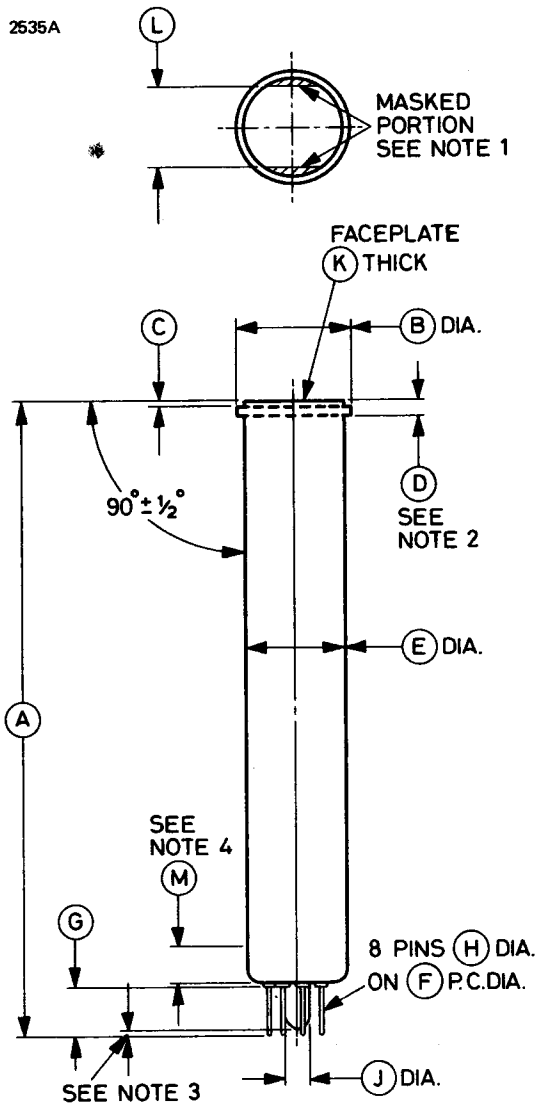

## NOTES

1. The straight sides are parallel to the plane passing through the tube axis and pin position 9.
2. Signal electrode contact flange may be located along the tube axis in any part of or all of the space between the dashed lines.
3. The seal-off will not project beyond the pins.
4. Over this length the diameter is N. A ring gauge P internal diameter and Q long will pass over the base and bulb to the signal electrode flange.

Ref	Inches	Millimetres	Ref	Inches	Millimetres
A	6.250 ± 0.125	158.8 ± 3.2	J	0.265 max	6.73 max
B	1.125 ± 0.010	28.58 ± 0.25	K	0.093 ± 0.005	2.36 ± 0.13
C	0.050 max	1.27 max	L	0.835 ± 0.035	21.21 ± 0.89
D	0.175	4.45	M	0.375	9.53
E	1.025 ± 0.003	26.035 ± 0.076	N	1.025 <sup>+0.003</sup> <sub>-0.030</sub>	26.035 <sup>+0.076</sup> <sub>-0.760</sub>
F	0.600	15.24	P	1.0280 <sup>+0.0011</sup> <sub>-0.0000</sub>	26.111 <sup>+0.028</sup> <sub>-0.000</sub>
G	0.503 max	12.78 max	Q	1.000	25.40
H	0.050 <sup>+0.002</sup> <sub>-0.004</sub>	1.270 <sup>+0.051</sup> <sub>-0.102</sub>			

Millimetre dimensions have been derived from inches.

## Base Connections

2536

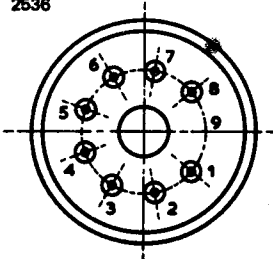

Pin	Element
1	Heater
2	Grid 1
3	Grid 4 (beam focus)
4	Grid 3 and grid 6
5	Grid 2
6	Grid 5
7	Cathode
8	Heater
9	Key pin position, blank
Flange	Signal electrode

## MAGNETIC SHIELDING

To obtain the most satisfactory performance from the 8134 it will generally be necessary to provide magnetic shielding over the full length of the electrode structure. A suitable arrangement is shown below.

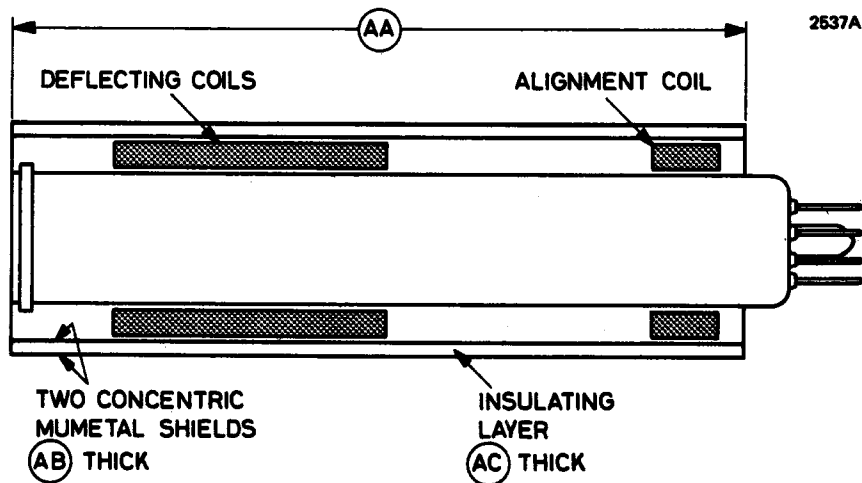

Ref	Inches	Millimetres
AA	5.375 nom	136.5 nom
AB	0.005	0.13
AC	0.062	1.57

Millimetre dimensions have been derived from inches.

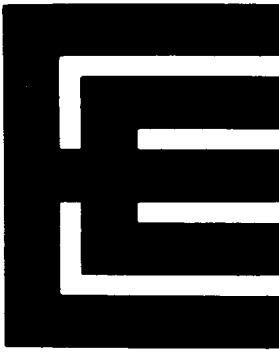

This information should be read in conjunction with the 8134 data sheet.

### INTRODUCTION

The 8134V1 is a 1-inch, electrostatic focus vidicon with low power heater, designed for use in colour TV cameras. It is electrically and mechanically identical with the 8134 but meets additional tests for shading, picture geometry, astigmatism and beat patterns.

### TYPICAL OPERATION

#### Operating Conditions (As found in TK27 camera)

Grid 6 and grid 3 voltage . . . . .	850	V
Grid 5 voltage . . . . .	365	V
Grid 2 voltage . . . . .	100 to 300	V
Grid 1 voltage . . . . .	-20	V
Picture area (masked) . . . . .	0.33 x 0.44 inch (8.38 x 11.18mm)	
Signal current (peak) . . . . .	0.3	μA
Signal electrode voltage . . . . .	10	V



#### Typical Performance

Resolution:		
horizontal . . . . .	400	TV lines min
vertical . . . . .	300	TV lines min
Beat patterns . . . . .	not discernible	
Shading . . . . .	15	% max

**Note** The difference between the highest and the lowest values of signal output current, measured at nine points defined by the intersections of three horizontal lines at 10%, 50% and 90% of picture height, and three vertical lines at 10%, 50% and 90% of picture width.

# TYPICAL SPECTRAL SENSITIVITY CHARACTERISTIC

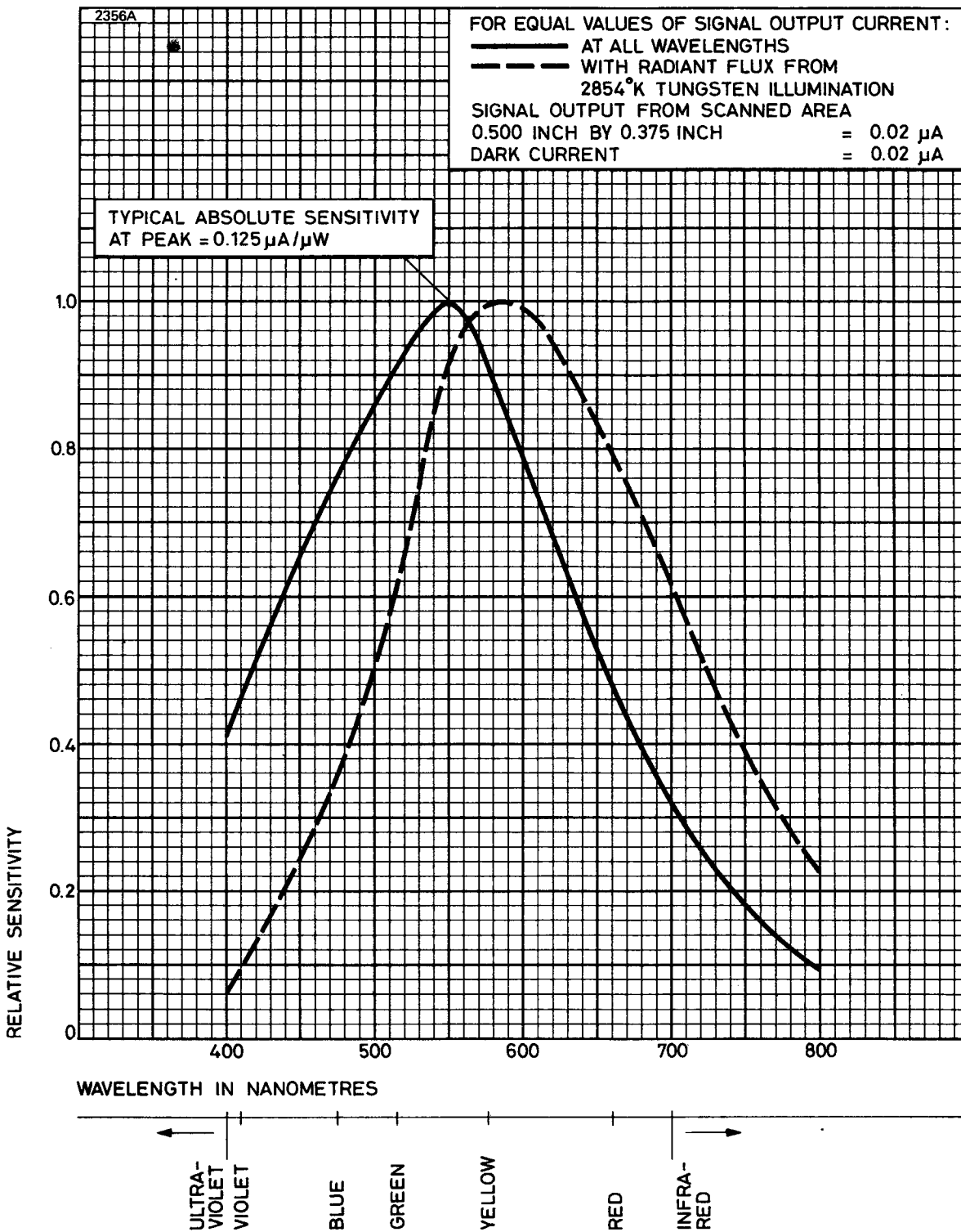

# OUTLINE (All dimensions without limits are nominal)

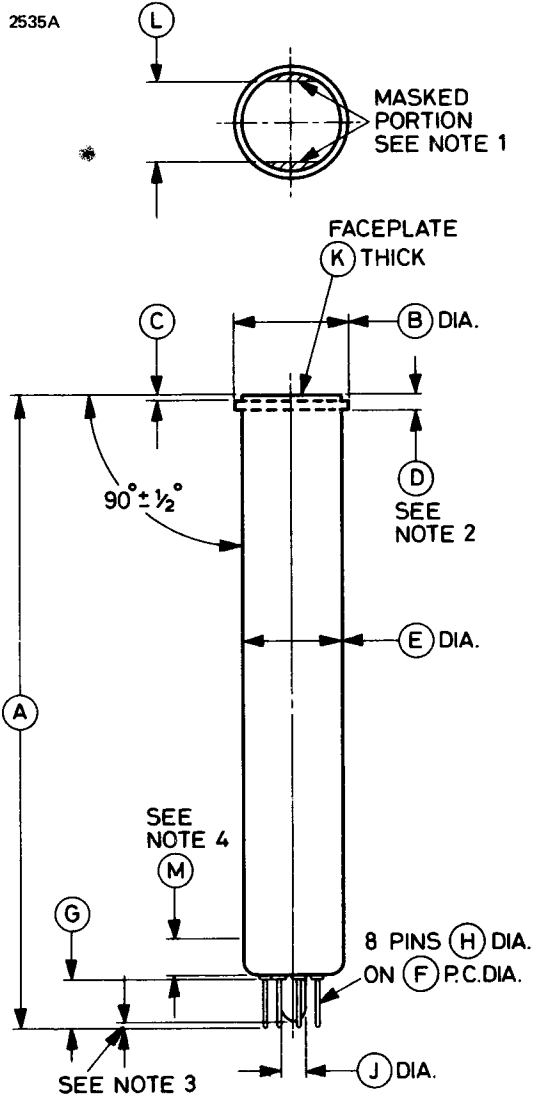

## NOTES

1. The straight sides are parallel to the plane passing through the tube axis and pin position 9.
2. Signal electrode contact flange may be located along the tube axis in any part of or all of the space between the dashed lines.
3. The seal-off will not project beyond the pins.
4. Over this length the diameter is N. A ring gauge P internal diameter and Q long will pass over the base and bulb to the signal electrode flange.

Ref	Inches	Millimetres	Ref	Inches	Millimetres
A	6.250 ± 0.125	158.8 ± 3.2	J	0.265 max	6.73 max
B	1.125 ± 0.010	28.58 ± 0.25	K	0.093 ± 0.005	2.36 ± 0.13
C	0.050 max	1.27 max	L	0.835 ± 0.035	21.21 ± 0.89
D	0.175	4.45	M	0.375	9.53
E	1.025 ± 0.003	26.035 ± 0.076	N	1.025 <sup>+0.003</sup> -0.030	26.035 <sup>+0.076</sup> -0.760
F	0.600	15.24	P	1.0280 <sup>+0.0011</sup> -0.0000	26.111 <sup>+0.028</sup> -0.000
G	0.503 max	12.78 max	Q	1.00	25.40
H	0.050 <sup>+0.002</sup> -0.004	1.270 <sup>+0.051</sup> -0.102			

Millimetre dimensions have been derived from inches.

## Base Connections

2536

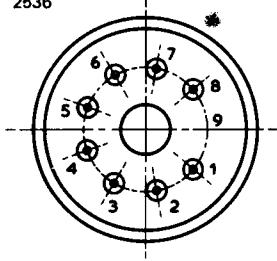

Pin	Element
1	Heater
2	Grid 1
3	Grid 4 (beam focus)
4	Grid 3 and grid 6
5	Grid 2
6	Grid 5
7	Cathode
8	Heater
9	Key pin position, blank
Flange	Signal electrode





**INTRODUCTION**

The 8480 is a 1½-inch diameter vidicon with magnetic deflection and electrostatic focusing, for use in film pick-up, data transmission and similar high resolution TV applications. The low deflection power requirements, together with the use of electrostatic focusing and a low power (0.6W) heater, make possible a camera of very low power consumption. The limiting resolution exceeds 1200 TV lines and the construction of the tube facilitates accurate registration in multi-tube colour cameras.

**GENERAL DATA**

**Electrical**

Cathode . . . . .	indirectly heated, oxide coated
Heater voltage . . . . .	6.3 ± 5% V
Heater current . . . . .	95 mA
Inter-electrode capacitance, signal electrode to all other electrodes (average value) (see note 1) . . . . .	11 pF
Spectral response . . . . .	see spectral sensitivity curve
Focusing method . . . . .	electrostatic
Deflection method . . . . .	magnetic
Alignment field, adjustable . . . . .	0 to 0.2mT (0 to 2 gauss)

**Mechanical**

Overall length . . . . .	10.375 inches (263.5mm) max
Overall diameter . . . . .	1.600 inches (40.64mm) max
Useful size of rectangular image; diagonal, centrally situated . . . . .	1.000 inch (25.4mm) max
Orientation . . . . .	The horizontal scan should be parallel to the plane through the tube axis and the blank index pin position. The masking is for orientation only and does not define the proper scanned area.



Alignment coil location . . . . .	see note 8
Net weight . . . . .	11 ounces (310g) approx
Mounting position (see note 2) . . . . .	any
Base . . . . .	small button super-ditetrar 8-pin (JEDEC no. E8-78)
Mating socket . . . . .	Alden no. 208-SPEC (or equivalent)

**Storage**

Recommended store temperature . . . . . 15 to 35 °C  
 Tubes should be stored in darkness.

**WARNING**

When operating a tube the following precautions should be observed:

1. Ensure that the temperature of the tube is within its recommended range.
2. Avoid over exposure of stationary pictures, e.g. test patterns, or after-image may result.
3. A surge limiting device must be incorporated if necessary to ensure that the heater current does not exceed 150mA when switching on or at any other time.

**MAXIMUM AND MINIMUM RATINGS (Absolute values)**

No individual rating should be exceeded.

	Min	Max	
Heater voltage . . . . .	6.0	6.6	V
Signal electrode voltage . . . . .	—	125	V
Grid 6 and grid 3 voltage (see note 3) . . . . .	—	1500	V
Grid 5 voltage (see note 4) . . . . .	—	1500	V
Grid 4 voltage . . . . .	—	500	V
Grid 2 voltage . . . . .	—	750	V
Grid 1 voltage:			
negative bias value . . . . .	—	300	V
positive bias value . . . . .	—	0	V
Blanking voltage, peak to peak (see note 5):			
when applied to grid 1 (negative pulses) . . . . .	40	—	V
when applied to cathode (positive pulses) . . . . .	10	—	V
Peak heater to cathode voltage:			
heater negative with respect to cathode . . . . .	—	125	V
heater positive with respect to cathode . . . . .	—	10	V
Dark current . . . . .	—	0.25	μA
Peak signal electrode current (see note 6) . . . . .	—	0.6	μA
Faceplate temperature . . . . .	—	71	°C
Peak illumination of faceplate (see note 7) . . . . .	—	1000	ft-candle

## TYPICAL OPERATION

### Typical Operating Conditions (for scanned area of 0.6 x 0.8 inch)

The following values and notes are for general guidance and may vary from tube to tube.

Grid 6* (decelerator) and grid 3 voltage . . . . .	1400	V
Grid 5 voltage . . . . .	700 to 840	V
Grid 4 (beam focus) voltage . . . . .	230 to 260	V
Grid 2 (accelerator) voltage . . . . .	300	V
Grid 1 voltage for picture cut-off (with no blanking voltage on grid 1) . . . . .	-45 to -100	V
Blanking voltage, peak to peak:		
when applied to grid 1 (negative pulses) . . . . .	75	V
when applied to cathode (positive pulses) . . . . .	20	V
Alignment field, adjustable (see note 8) . . . . .	0 to 2	gauss
Faceplate temperature (see note 9) . . . . .	28 to 34	°C

### Typical Performance

Limiting resolution at centre of picture:

typical . . . . .	1400	TV lines
minimum . . . . .	1200	TV lines

Amplitude response (see note 10):

typical . . . . .	60	%
minimum . . . . .	55	%

Peak deflection coil currents (see note 8):

horizontal . . . . .	100	mA
vertical . . . . .	20	mA



Lag (see note 11):

maximum . . . . .	35	%
typical . . . . .	25	%

'Gamma' of transfer characteristic for  
signal output between 0.02 and 0.6 $\mu$ A . . . . .

0.65

**Average  
sensitivity**

**Minimum  
lag**

Faceplate illumination (highlights)

(see note 12) . . . . . 10 50 ft-candle

Signal output current (peak) (see note 13) . . . . . 0.5 0.5  $\mu$ A

Approximate range of signal

electrode voltage (see note 14) . . . . . 20 to 60 10 to 30 V

Dark current (see note 15) . . . . . 0.02 0.005  $\mu$ A

## SEQUENCE OF CAMERA ADJUSTMENTS

(For general operational conditions as shown on page 3)

- (a) Set the grid 1 voltage for the maximum negative bias for picture cut-off and apply the other voltages given under Typical Operating Conditions.
- (b) Check that the deflection circuits are functioning properly and adjust the scanning amplitude controls so that a maximum area of the photoconductive layer will be scanned.
- (c) Set the signal electrode voltage to give the signal current specified for the particular condition of operation. The range of signal electrode voltage above gives an indication of the voltage required.

The magnitude of non-uniformities of dark current, as well as lag, tend to increase with signal electrode voltage; therefore operation at low values of signal electrode voltage helps to minimize these effects. The table above gives an indication of the ranges of signal electrode voltage required for two conditions of operation. For other conditions of operation, reference should be made to the light transfer characteristic and the graph showing the range of signal electrode voltage to produce a given dark current and therefore a given sensitivity. It is preferable, if possible, to adjust the dark current to the specified value for the particular condition of operation; 8480 tubes will have substantially identical performances when operated with identical values of dark current.

- (d) Decrease grid 1 voltage from its negative value until a signal is produced.
- (e) Adjust grid 4 (beam focus) voltage, the lens stop and the optical focus alternately to obtain the best focused picture with the peak signal output current specified under Typical Performance Data.
- (f) Adjust the lens aperture and signal electrode voltage to produce the desired output signal. Lag decreases with increase in illumination on the faceplate.
- (g) Adjust the alignment field so that the centre of the picture does not move as grid 4 (beam focus) voltage is rocked slightly. Adjust grid 1 (beam current) voltage to provide sufficient beam to just discharge the highlights. It is permissible to set the alignment fields slightly off the minimum movement position to maintain signal uniformity.
- (h) Adjust the deflection amplitude and position to scan an area 0.600 inch x 0.800 inch. This is facilitated by the use of a perspex mask inscribed with circles 0.600 inch and 0.800 inch diameter, placed in contact and concentric with the faceplate of the tube. Light is allowed to fall on the photoconductive layer and an image of the rings is obtained on the monitor. No lens is necessary. The scan amplitude and centring controls are adjusted until the diameter of the larger circle is equal to the width of the raster and that of the smaller equal to the height.

- (j) Centre the raster in the useful area of the photoconductive layer and check the alignment (step g).
- (k) If the picture is faint, even with adequate video gain, open the lens iris more and, if necessary, increase the signal electrode voltage.
- (l) Repeat steps (e) to (g) until optimum picture reproduction is obtained.

## NOTES

1. This capacitance, which in effect forms the output impedance of the 8480, is increased when the tube is mounted in a deflecting yoke assembly. The resistive component of the output impedance is of the order of 100 megohms.
2. When the tube is subjected to vibration the mounting position should not be vertical with the base uppermost.
3. The ratio of grid 6 and grid 3 voltage to grid 5 voltage should be fixed at a value between 1.67, which gives the best picture geometry, and 2.0, which gives the most uniform signal output. The resolution, uniformity of focus and picture quality decrease with decreasing grid 6 and grid 3 voltage and grid 5 voltage.
4. The voltage between grid 5 and grids 6 and 3 must not exceed 800V.
5. The blanking voltage required when applied to the cathode is less than that required when applied to grid 1 as the former reduces the potential difference between the cathode and the scanned side of the target.
6. The video amplifier must be designed to handle signal currents of this magnitude.
7. For 'white light' uniformly diffused over faceplate.
8. Use an approved deflection yoke and alignment coil such as Cleveland Electronics 15VYA-333. For the deflection yoke, the distance from the faceplate to the beginning of the winding is 0.75 inch approx. The alignment coil should be located so that its centre is 8.250 inches from the faceplate of the tube. Its axis should be coincident with the axis of the tube and the deflecting yoke.
9. Unless the temperature of the faceplate is maintained at a constant value within this range, the dark current and performance will drift from the optimum performance established on initial setting up.
10. Amplitude at 400 lines per picture height at the centre of the picture, relative to the large area black-white signal.
11. Percentage of initial value of signal output current remaining 3 field periods after light is cut off (i.e. 50ms in American standard systems and 60ms in European systems), with a faceplate illumination of 5 foot-candles and an initial highlight signal current of  $0.3\mu\text{A}$ .

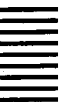

12. For example, a scene brightness of approximately 1700ft-lamberts with lens aperture f/5.6 and a transmission of 75% produces 10 foot-candles illumination on the faceplate.
13. The signal output current is the highlight signal electrode current during one frame after the dark current component has been subtracted. Signal currents higher than  $0.5\mu\text{A}$  may be used depending on requirements.
14. The signal electrode voltage for each 8480 must be adjusted to that value which gives the desired operating current. The indicated range of target voltage for each operational condition is given to illustrate the operating voltage range normally encountered. See also step (c) in Sequence of Camera Adjustments.
15. The deflecting circuits must provide extremely linear scanning for good black level reproduction under these conditions. Dark current is proportional to the scanning velocity. Any change in scanning velocity produces a black level error in direct proportion to the change in velocity of scanning.

## MAGNETIC SHIELDING

A suitable magnetic shield for the 8480 comprises 15 turns of Permalloy or similar shielding material, covering the full length of the electrode structure. A suitable arrangement is shown below.

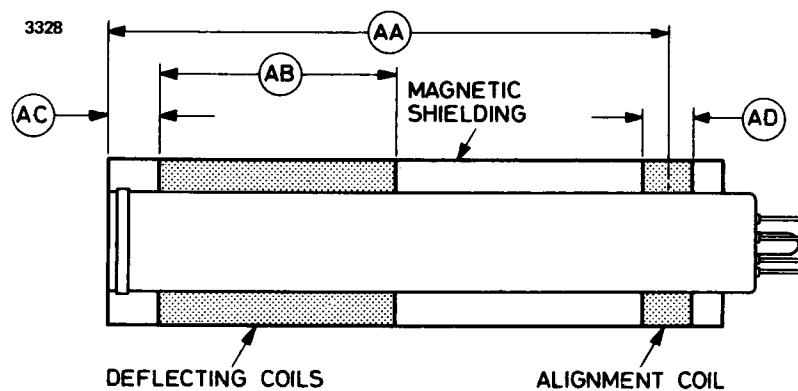

Ref	Inches	Millimetres
AA	8.250	209.6
AB	3.500	88.90
AC	0.750	19.05
AD	0.750	19.05

Millimetre dimensions have been derived from inches.

# TYPICAL SPECTRAL SENSITIVITY CHARACTERISTIC

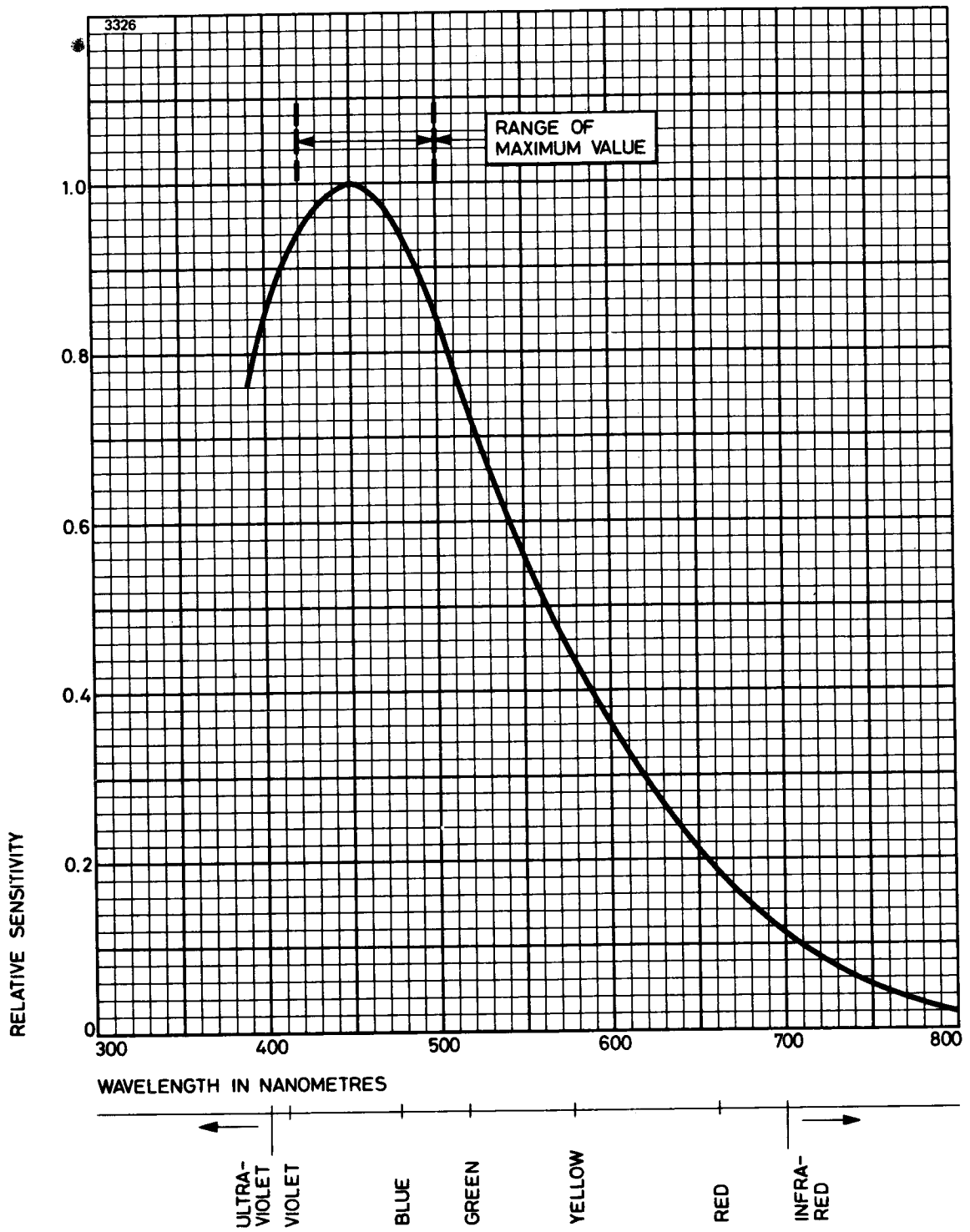

# TYPICAL RESOLUTION

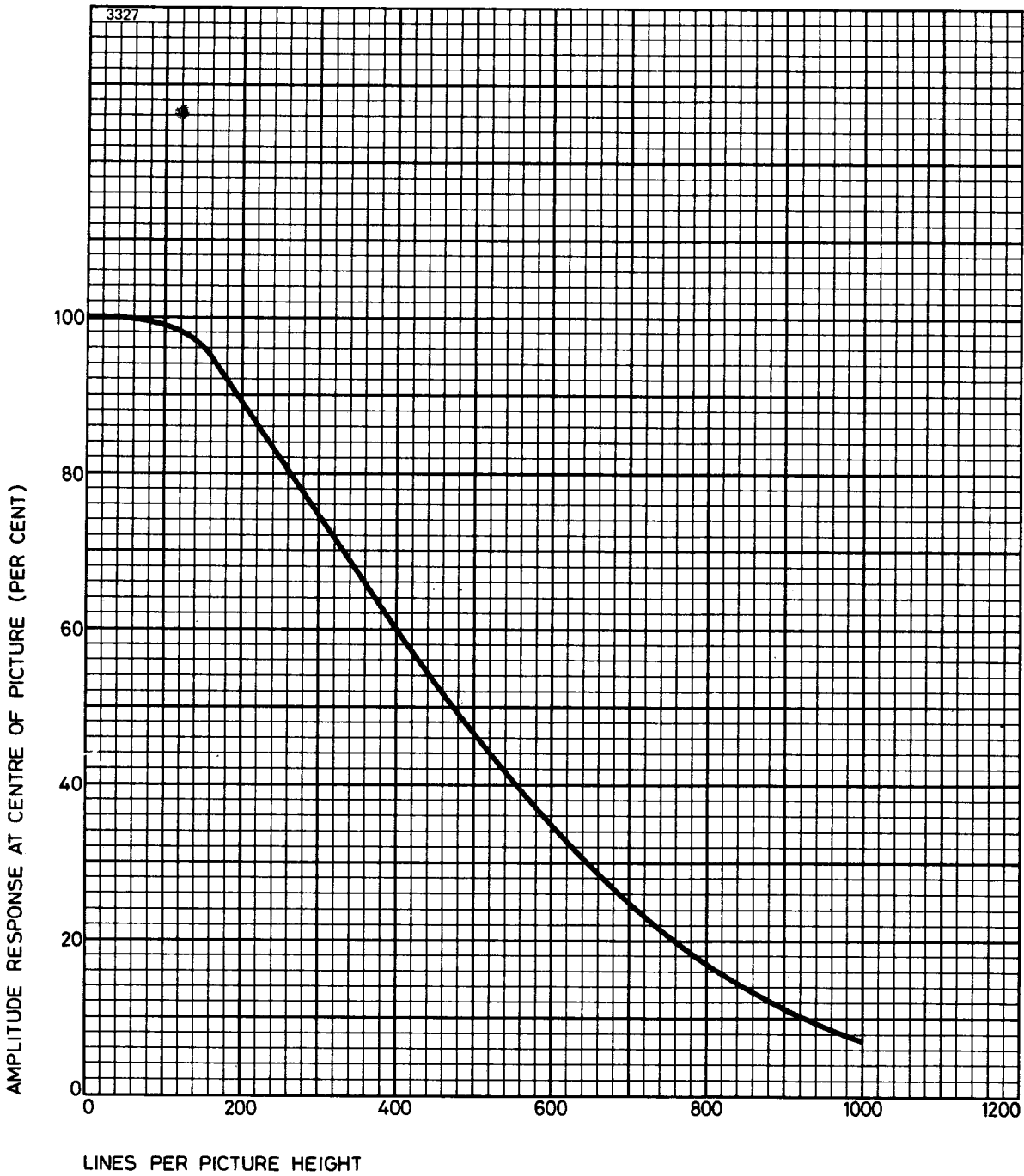

Grid 6 and grid 3 voltage . . . . .	1400	V
Grid 5 voltage . . . . .	800	V
Highlight signal output current . . . . .	0.3	$\mu$ A
Dark current . . . . .	0.02	$\mu$ A
Test pattern . . . . .	square wave resolution wedge transparency	



# TYPICAL LIGHT TRANSFER CHARACTERISTICS

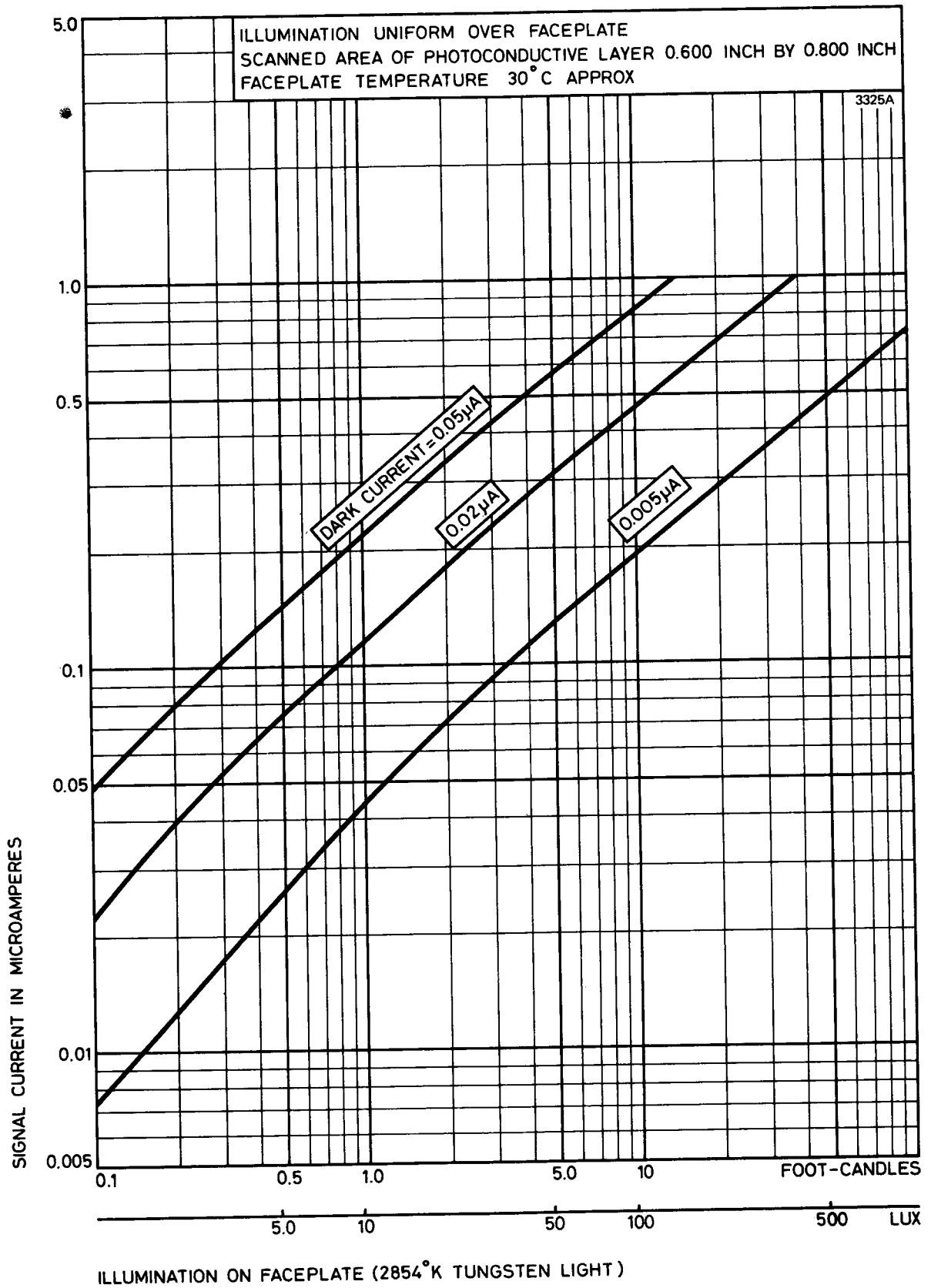

# TYPICAL RANGE OF DARK CURRENT

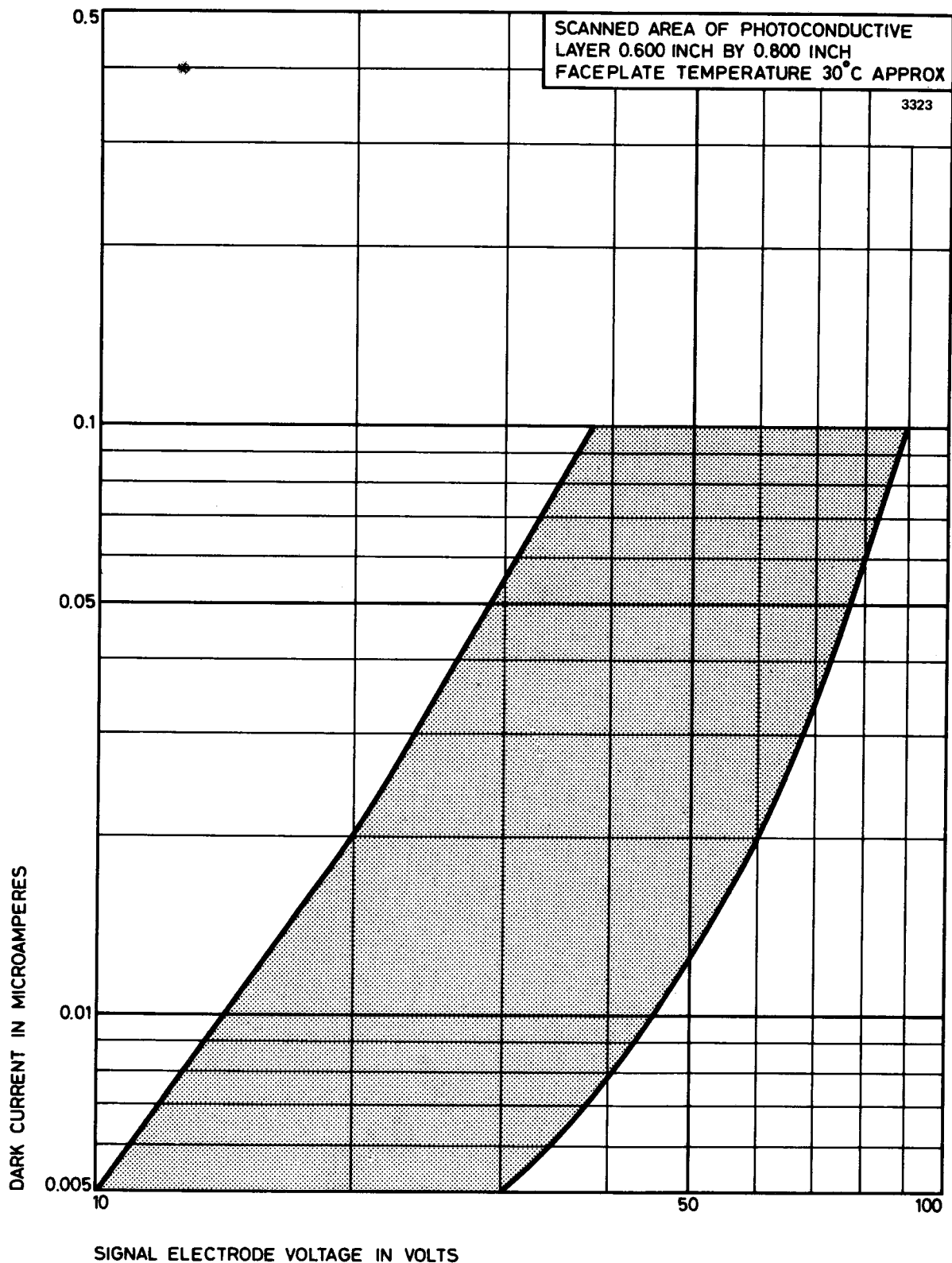

# TYPICAL LAG CHARACTERISTIC

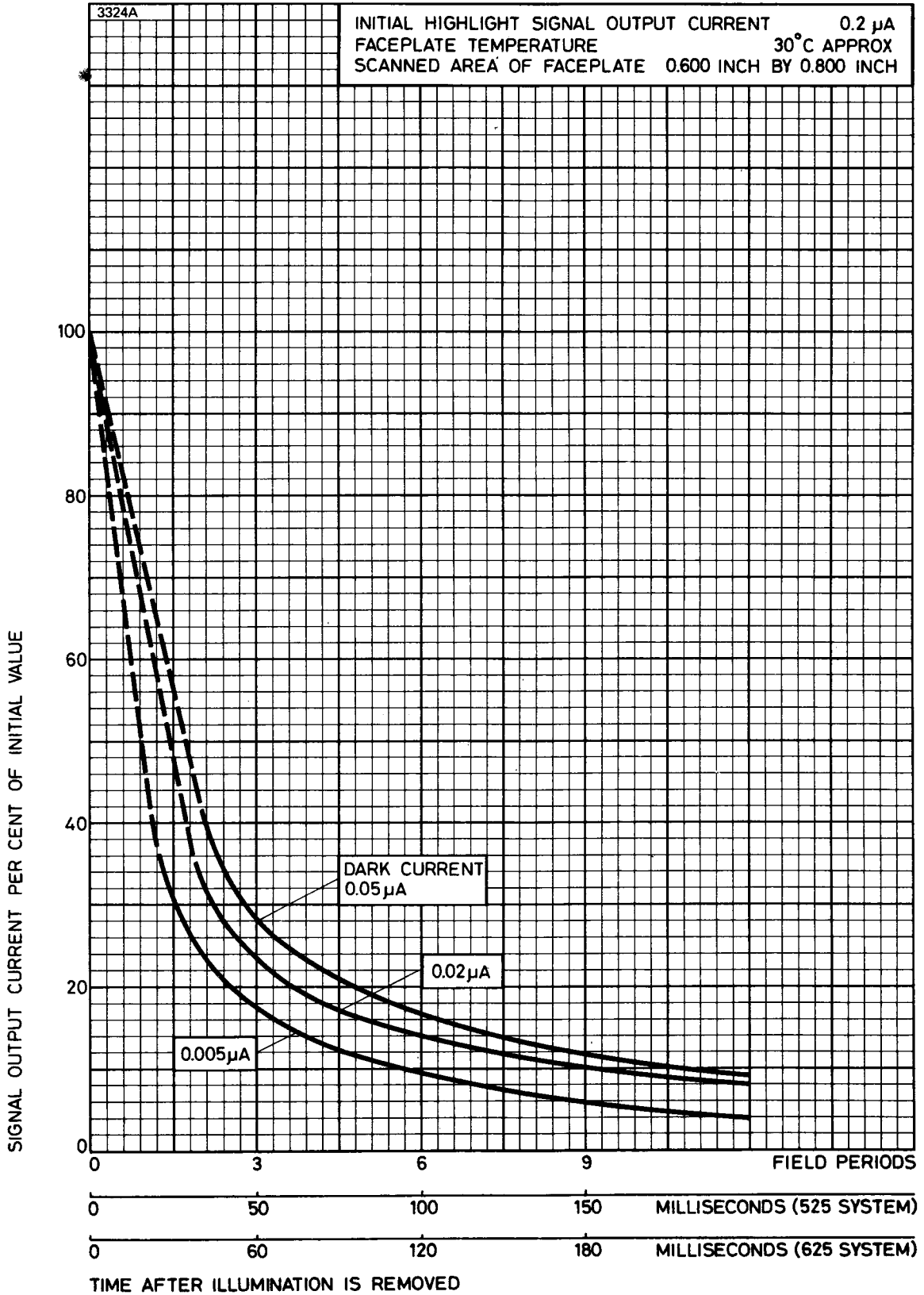

**OUTLINE (All dimensions without limits are nominal)**

3322

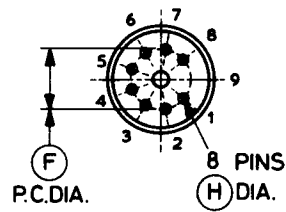
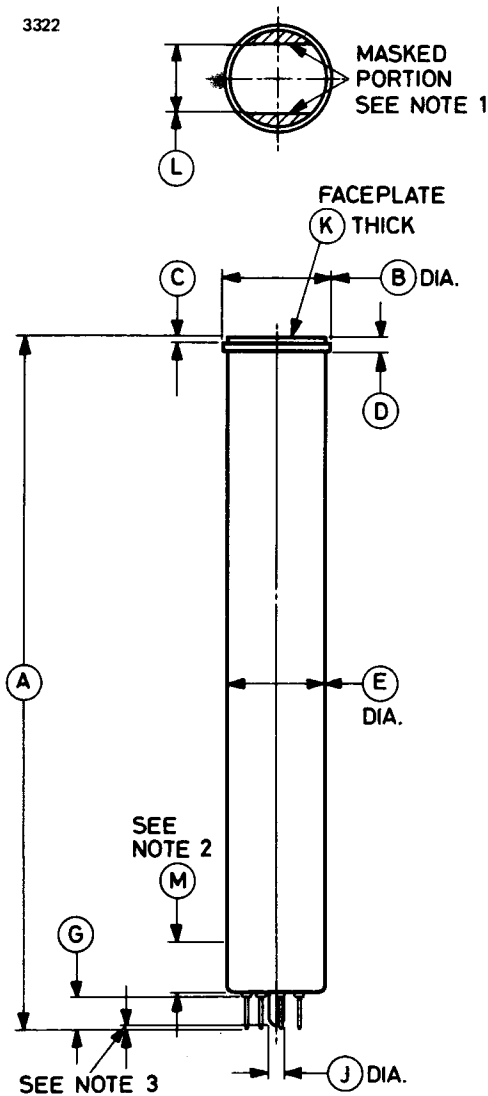

Pin	Element
1	Heater
2	Grid 1
3	Grid 4
4	Grid 3 and grid 6
5	Grid 5
6	Grid 2
7	Cathode
8	Heater
9	Key pin position, blank
Flange	Signal electrode

**Notes**

1. The straight sides are parallel to the plane passing through the tube axis and pin position 9.
2. Within this length the minimum tube diameter does not apply.
3. The seal-off will not project beyond the pins.

Ref	Inches	Millimetres	Ref	Inches	Millimetres
A	10.250 ± 0.125	260.4 ± 3.2	H	0.050 + 0.002 - 0.004	1.270 + 0.051 - 0.102
B	1.590 ± 0.010	40.39 ± 0.25	J	0.265 max	6.73 max
C	0.085 ± 0.010	2.16 ± 0.25	K	0.135 ± 0.005	3.43 ± 0.13
D	0.210	5.33	L	1.000 ± 0.050	25.40 ± 1.27
E	1.500 ± 0.005	38.10 ± 0.13	M	0.750	19.05
F	0.900	22.86			
G	0.503 max	12.78 max			

Millimetre dimensions have been derived from inches.

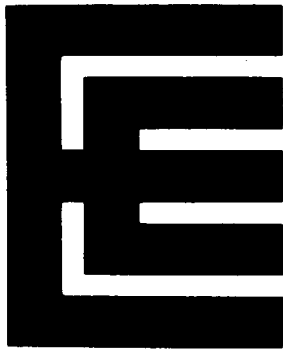

This information should be read in conjunction with the 8480 data sheet.

### INTRODUCTION

The 8480V1 is a 1½-inch diameter electrostatic focus vidicon with a low power (0.6W) heater, for use in film pick-up, data transmission and similar high resolution TV applications. It is electrically and mechanically identical with the 8480 but meets additional tests for shading, picture geometry, astigmatism and beat patterns.

### TYPICAL OPERATION

#### Operating Conditions (As found in TK22 and TK27 cameras)

Scanned area . . . . .	0.6 x 0.8	inch
Grid 6 and grid 3 voltage . . . . .	1300	V
Grid 5 voltage . . . . .	650	V
Grid 2 voltage . . . . .	100 to 300	V
Grid 1 voltage . . . . .	-20	V



#### Typical Performance

Resolution:		
horizontal . . . . .	600	TV lines min
vertical . . . . .	400	TV lines min
Beat patterns . . . . .	not discernible	
Shading (see note) . . . . .	20	% max
Signal output current (peak) . . . . .	0.6	µA
Signal electrode voltage . . . . .	10	V

**Note** The difference between the highest and the lowest values of signal output current, measured at nine points defined by the intersections of three horizontal lines at 10%, 50% and 90% of picture height, and three vertical lines at 10%, 50% and 90% of picture width.

**OUTLINE (All dimensions without limits are nominal)**

3322

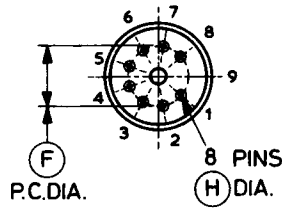
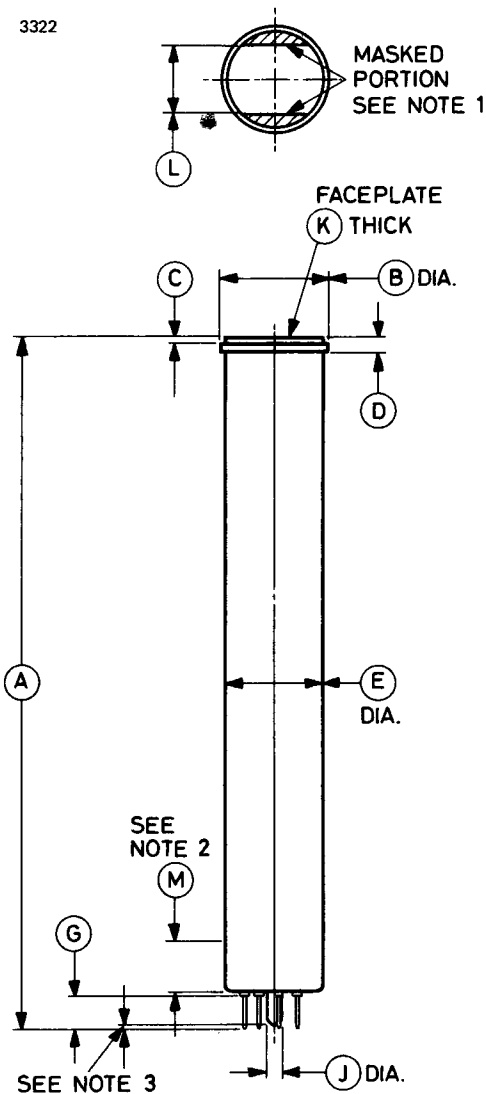

Pin	Element
1	Heater
2	Grid 1
3	Grid 4
4	Grid 3 and grid 6
5	Grid 5
6	Grid 2
7	Cathode
8	Heater
9	Key pin position, blank
Flange	Signal electrode

**Notes**

1. The straight sides are parallel to the plane passing through the tube axis and pin position 9.
2. Within this length the minimum tube diameter does not apply.
3. The seal-off will not project beyond the pins.

Ref	Inches	Millimetres	Ref	Inches	Millimetres
A	10.250 ± 0.125	260.4 ± 3.2	H	0.050 <sup>+0.002</sup> <sub>-0.004</sub>	1.270 <sup>+0.051</sup> <sub>-0.102</sub>
B	1.590 ± 0.010	40.39 ± 0.25	J	0.265 max	6.73 max
C	0.085 ± 0.010	2.16 ± 0.25	K	0.135 ± 0.005	3.43 ± 0.13
D	0.210	5.33	L	1.000 ± 0.050	25.40 ± 1.27
E	1.500 ± 0.005	38.10 ± 0.13	M	0.750	19.05
F	0.900	22.86			
G	0.503 max	12.78 max			

Millimetre dimensions have been derived from inches.



# 8507A

(P841)

VIDICON

---

Unilateral replacement for 8507

## INTRODUCTION

The 8507A is a 1-inch diameter vidicon of high resolution capability, with magnetic deflection and focusing, designed for live pick-up in black and white TV cameras. It is also satisfactory for film pick-up and three-vidicon colour cameras.

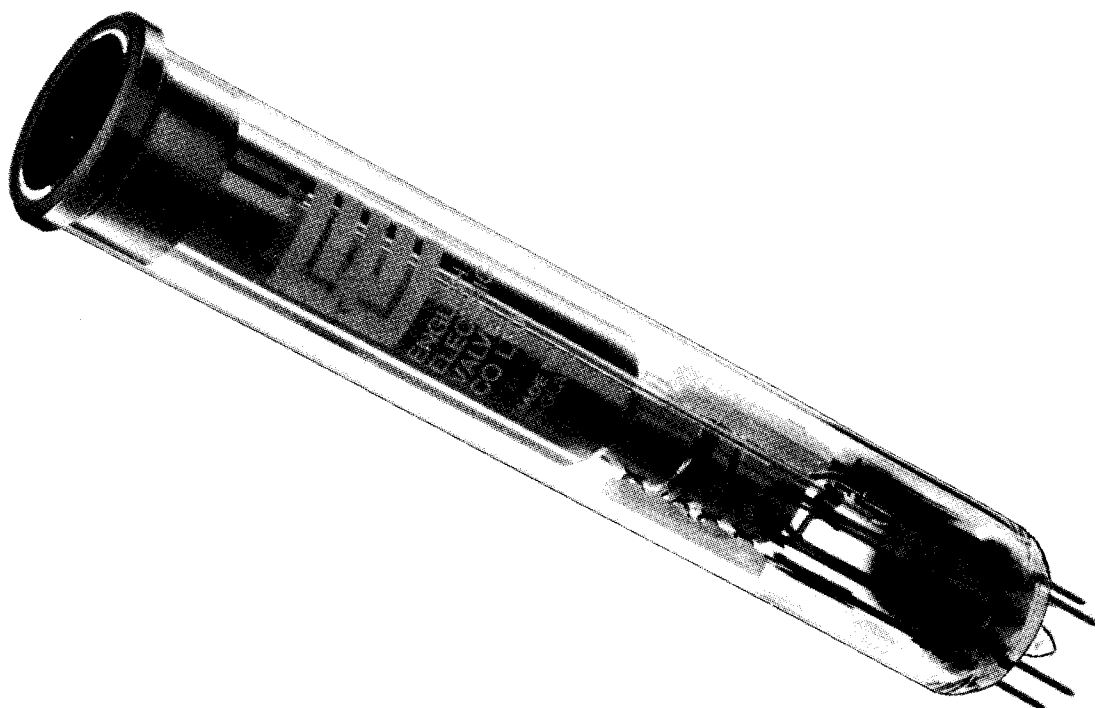

This vidicon features a separate mesh electrode and a very uniform target layer. Limiting resolutions in the region of 1100 TV lines may be obtained in the centre of the picture, optimum resolution being achieved when the grid 3 voltage is 0.6 to 0.7 of the mesh voltage.

A 4 watt (6.3V, 0.6A) heater is used in this tube making it suitable for use in equipment designed for series heater operation or having poor heater voltage regulation; for low power heater type see 8541A.

---

December 1972

453

## GENERAL DATA

### Electrical

Cathode . . . . .	indirectly heated, oxide coated
Heater voltage . . . . .	6.3 V
Heater current . . . . .	0.6 A
Inter-electrode capacitance, signal electrode to all other electrodes (average value) (see note 1) . . . . .	4.6 pF
Spectral response . . . . .	see spectral sensitivity curve
Focusing method . . . . .	magnetic
Deflection method . . . . .	magnetic

### Mechanical

Overall length . . . . .	6.375 inches (162mm) max
Overall diameter . . . . .	1.135 inches (28.9mm) max
Useful size of rectangular image; diagonal, centrally situated . . . . .	0.63 inches (15.9mm) max
Orientation . . . . .	see note 2
Net weight . . . . .	2 ounces (60g) approx
Mounting position (see note 3) . . . . .	any
Base . . . . .	small button ditetrar 8-pin (JEDEC no. E8-11)

### Associated Components

Focusing coil (see note 4) . . . . .	Cleveland Electronics VF-115-12
Deflection yoke . . . . .	Cleveland Electronics VY-111-3
Alignment coil (see note 5) . . . . .	Cleveland Electronics VA-118
Mating socket . . . . .	Type R41-79502 by United Carr Fasteners Ltd. (or equivalent)

### Storage

Recommended store temperature . . . . .	15 to 35 °C
---	-------------

Tubes should be stored in darkness.



## WARNING

When operating a tube the following precautions must be observed:

1. Ensure that the temperature of the tube is within its recommended range.
2. Avoid excessive exposure to high levels of illumination otherwise permanent damage to the photoconductive surface may result.

## MAXIMUM AND MINIMUM RATINGS (Absolute values)

No individual rating to be exceeded.

	Min	Max	
Heater voltage . . . . .	5.7	6.9	V
Signal electrode voltage . . . . .	—	100	V
Grid 4 (mesh) voltage (see note 6) . . . . .	—	1000	V
Grid 3 (beam focus) voltage (see note 6) . . . . .	—	1000	V
Grid 2 (accelerator) voltage . . . . .	—	750	V
Grid 1 voltage:			
negative bias value . . . . .	—	300	V
positive bias value . . . . .	—	0	V
Blanking voltage, peak to peak (see note 7):			
when applied to grid 1 (negative pulses) . . . . .	40	—	V
when applied to cathode (positive pulses) . . . . .	20	—	V
Peak heater to cathode voltage:			
heater negative with respect to cathode . . . . .	—	125	V
heater positive with respect to cathode . . . . .	—	10	V
Dark current . . . . .	—	0.25	$\mu$ A
Peak signal electrode current (see note 8) . . . . .	—	0.75	$\mu$ A
Faceplate temperature . . . . .	—	71	$^{\circ}$ C
Peak illumination of faceplate . . . . .	—	5000	ft-candles
	—	54 000	lux

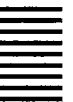

## TYPICAL OPERATION

### Operating Conditions (for scanned area of 0.5 x 0.375 inch)

The following values and notes are for general guidance and may vary from tube to tube.

	Low Voltage Operation	High Voltage Operation	
Grid 4 (mesh) voltage (see note 6) . . . . .	500	900	V
Grid 3 (beam focus) voltage (approx) (see notes 6 and 9) . . . . .	300	540	V
Grid 2 (accelerator) voltage . . . . .	300	300	V
Grid 1 voltage for picture cut-off (with no blanking voltage on grid 1) . . . . .	-65 to -100	-65 to -100	V
Blanking voltage, peak to peak:			
when applied to grid 1 (negative pulses) . . . . .	75	75	V
when applied to cathode (positive pulses) . . . . .	20	20	V
Field strength at centre of focusing coil (see notes 4 and 9) . . . . .	$4.0 \pm 0.4$ $41 \pm 4$	$5.2 \pm 0.4$ $52 \pm 4$	mT gauss
Peak deflection coil currents (approx):			
horizontal . . . . .	200	240	mA
vertical . . . . .	25	30	mA
Alignment field, adjustable (see note 10)	0 to 0.4 0 to 4	0 to 0.4 0 to 4	mT gauss
Faceplate temperature (see note 11) . . . . .	30 to 35	30 to 35	°C

## Typical Performance

	Low Voltage	High Voltage	
Limiting resolution at centre of picture (approx) . . . . .	1000	1100	TV lines
Amplitude response to a 400 TV line square wave test pattern at centre of picture (approx) . . . . .	60	70	%
Lag (see note 12) . . . . .		20	%
'Gamma' of transfer characteristic for signal output between 0.02 and 0.2 $\mu$ A . . . . .		0.65	
Visual equivalent signal to noise ratio (see note 13) . . . . .		300:1	approx
Picture defects . . . . .			see note 14

	Condition			
	1*	2†	3‡	
Faceplate illumination (highlights) (see note 18) . . . . .	0.1	1.0	10	ft-candles
	1.08	10.8	108	lux
Signal output current (peak) (see note 19) . . . . .	0.1	0.2	0.3	$\mu$ A
Approximate range of signal electrode voltage (see note 20) . . . . .	30–60	20–40	10–22	V
Dark current (see note 21) . . . . .	0.1	0.02	0.005	$\mu$ A

\* See note 15

† See note 16

‡ See note 17



## SEQUENCE OF CAMERA ADJUSTMENTS

(For general operational conditions as shown on page 4)

- (a) Set the grid 1 voltage for the maximum negative bias for picture cut-off and apply the other voltages given under Typical Operating Conditions.
- (b) Check that the deflection circuits are functioning properly and adjust the scanning amplitude controls so that a maximum area of the photoconductive layer will be scanned.
- (c) Set the signal electrode voltage to give the signal current specified for the particular condition of operation. The table above gives an indication of the ranges of signal electrode voltage required for three conditions of operation. For other conditions of operation, reference

should be made to the light transfer characteristic and the graph showing the range of signal electrode voltage to produce a given dark current and therefore a given sensitivity. It is preferable, if possible, to adjust the dark current to the specified value for the particular condition of operation; 8507A tubes will have substantially identical performances when operated with identical values of dark current.

The magnitude of non-uniformities of dark current, as well as lag, tend to increase with signal electrode voltage; therefore operation at low values of signal electrode voltage helps to minimize these effects.

- (d) Decrease grid 1 voltage from its maximum negative value until a signal is produced.
- (e) Adjust grid 3 (beam focus) or grid 3 and grid 4 (mesh) voltages, the lens stop and the optical focus alternately to obtain the best focused picture with the peak signal output current specified under Typical Performance.
- (f) Adjust the lens aperture and signal electrode voltage to produce the desired output signal. Lag decreases with increase in illumination on the faceplate.
- (g) Adjust the alignment field so that the centre of the picture does not move as grid 3 (beam focus) and grid 4 (mesh) voltages are rocked slightly. Adjust grid 1 (beam current) voltage to provide just sufficient beam to discharge the highlights. It is permissible to set the alignment fields slightly off the minimum movement position to maintain signal uniformity.
- (h) Adjust the deflection amplitude and position to scan an area 0.500 inch x 0.375 inch. This is facilitated by the use of a perspex mask inscribed with circles 0.500 inch and 0.375 inch diameter, placed in contact and concentric with the faceplate of the tube. Light is allowed to fall on the photoconductive layer and an image of the rings is obtained on the monitor. No lens is necessary. The scan amplitude and centring controls are adjusted until the diameter of the larger circle is equal to the width of the raster and that of the smaller equal to the height.
- (j) Centre the raster in the useful area of the photoconductive layer and check the alignment (step g).
- (k) If the picture is faint, even with adequate video gain, open the lens iris more and, if necessary, increase the signal electrode voltage.
- (l) Repeat steps (e) to (g) until optimum picture reproduction is obtained.

## NOTES

1. This capacitance, which in effect forms the output impedance of the tube, is increased when the tube is mounted in a deflecting yoke and focusing coil assembly. The resistive component of the output impedance is of the order of 100 megohms.
2. The horizontal scan should be parallel to the plane passing through the tube axis and the blank key-pin position. The masking is for orientation only and does not define the proper scanned area.
3. When the tube is subjected to vibration the mounting position must not be vertical with the base uppermost.
4. The direction of the focusing current should be such that a north pole is attracted to the image end of the focusing coil. The distance from the faceplate to the beginning of the winding is 0.75 inch approximately.
5. The alignment coil is located to the rear of the focusing coil directly over the electron gun. It should be located so that its centre is 3.69 inches from the faceplate of the tube and its axis should be coincident with the axis of the tube, the deflecting yoke and the focusing coil.
6. Grid 3 and grid 4 voltages are adjusted for the best focus. The resolution, uniformity of focus and picture quality decrease with decreasing grid 3 and grid 4 voltage. In general grid 3 should be operated above 250 volts and be approximately 0.6 of grid 4 voltage.
7. The blanking voltage required when applied to the cathode is less than that required when applied to grid 1 as the former reduces the potential difference between the cathode and the scanned side of the target.
8. The video amplifier must be designed to handle signal currents of this magnitude, to avoid picture distortion due to overloading of the amplifier.
9. It may be preferred to adjust beam focus by varying the focus coil current to obtain the field strengths indicated in the Typical Operating Conditions. If the focus coil field strength is fixed, beam focus may be obtained within a  $\pm 10\%$  range (approximately) of the grid 3 and grid 4 voltages. The ratio of 0.6 between grid 3 and grid 4 must be maintained as these voltages are varied.
10. Adjust the current through the alignment coils until the centre of the test pattern does not move as grid 3 and grid 4 voltages or the focus coil current are varied in and out of focus.

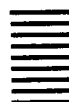

11. Unless the temperature of the faceplate is maintained at a constant value within this range, the dark current and performance will drift from the optimum performance established on initial setting up.
12. Percentage of initial value of signal output current remaining 3 field periods after light is cut off (i.e. 50ms in American standard systems and 60ms in European systems), with a total signal current of  $0.3\mu\text{A}$  and a dark current of  $0.02\mu\text{A}$ .
13. Measured with a high gain, low noise, cascode type pre-amplifier having a bandwidth of 5.1MHz and a peak signal output current of  $0.35\mu\text{A}$ . The visual equivalent signal to noise ratio is taken as the ratio of the highlight signal output current to the r.m.s. noise current, multiplied by a factor of 3 (ref. Otto H. Schade, 'Electro-optical Characteristics of Television Systems; Introduction and Part 1 – Characteristics of Vision and Visual Systems', RCA Review, March 1948).
14. This test is carried out with a faceplate illumination of 0.5 foot-candle (e.g. a scene brightness of 100 foot-lamberts with lens aperture f/6.3 and transmission 75%), scanned area of 0.5 by 0.375 inch and signal current  $0.3\mu\text{A}$ . The test pattern shown is used to define the picture zones.

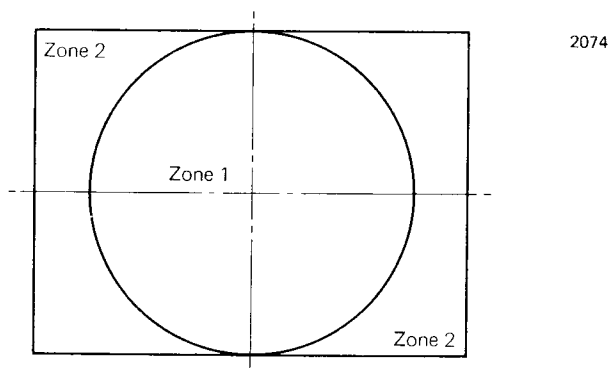

The limitations on size and number of spots will be according to the following table. Spots having a contrast ratio less than 1.5:1 for white spots and 2:1 for black spots are not counted. Smudges, streaks, or mottled or grainy background must have a contrast ratio of 1.5:1 to be cause for rejection.

Equivalent number of raster lines in a 625 line system	Number allowed	
	Zone 1	Zone 2
* over 4	0	0
4 to but not including 3	0	1
3 to but not including 1	2	3
1 and under	*	*

Minimum separation between any two spots greater than 0.015 inch (1 line) is 0.25 inch (16 lines).

\* Spots of this size may be present in unlimited numbers unless their concentration causes a smudged appearance.

15. Maximum sensitivity operation.
16. Average sensitivity operation.
17. Highlight level operation.
18. For example, a scene brightness of approximately 860 foot-lamberts ( $2950\text{cd/m}^2$ ) with lens aperture f/4 and a transmission of 75% produces 10 foot candles (108 lux) illumination on the faceplate.
19. The signal output current is the highlight signal electrode current during one frame after the dark current component has been subtracted. Signal currents higher than  $0.25\mu\text{A}$  may be used depending on requirements.
20. The signal electrode voltage for each tube is adjusted to that value which gives the desired operating signal current; the indicated range of signal electrode voltage for each operational condition is given to illustrate the variation normally encountered.
21. The deflecting circuits must provide linear scanning for good black level reproduction under these conditions. Dark current is proportional to the scanning velocity. Any change in scanning velocity produces a black level error in direct proportion to the change in velocity of scanning.

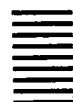

# TYPICAL SPECTRAL SENSITIVITY CHARACTERISTIC

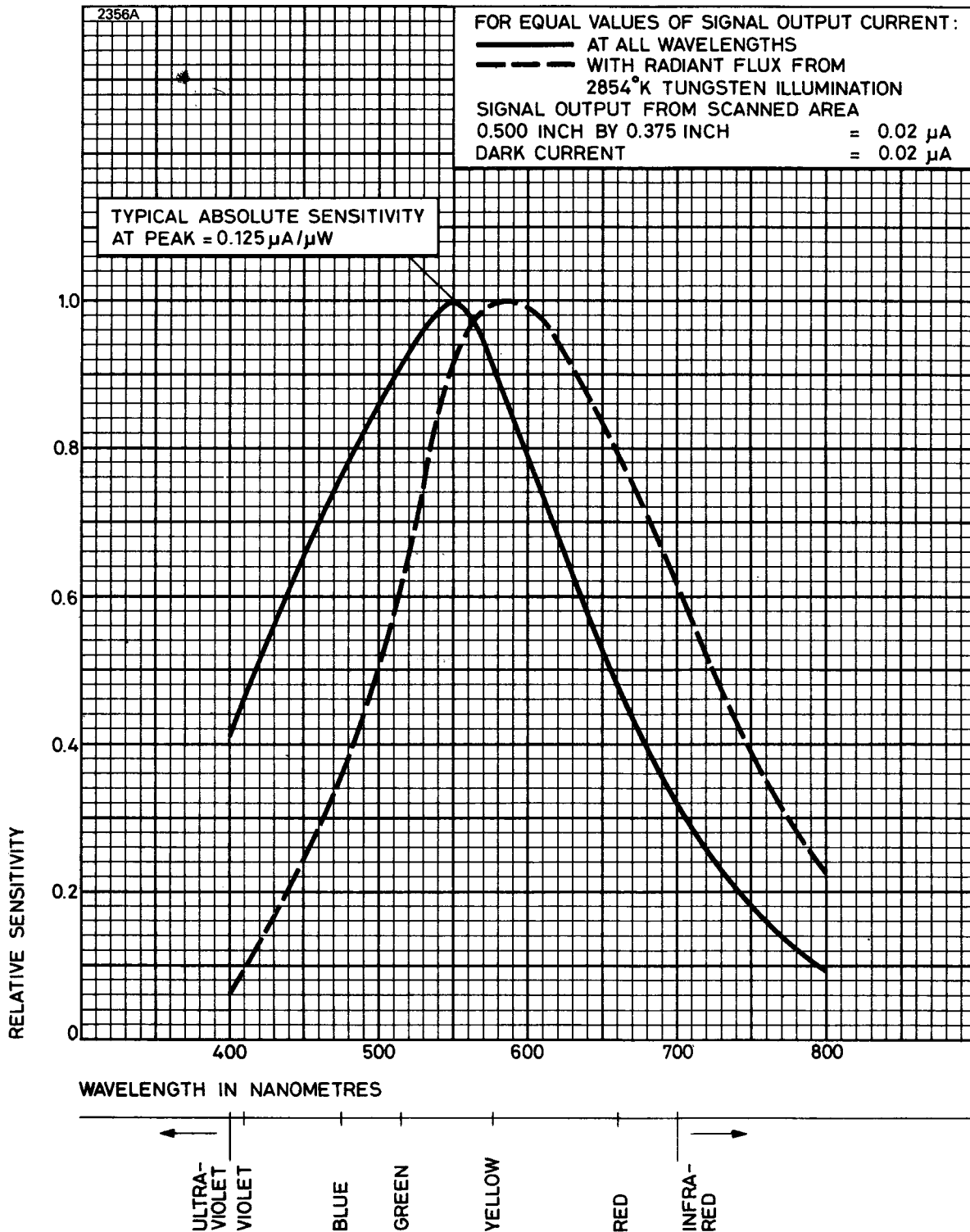



# TYPICAL RESOLUTION

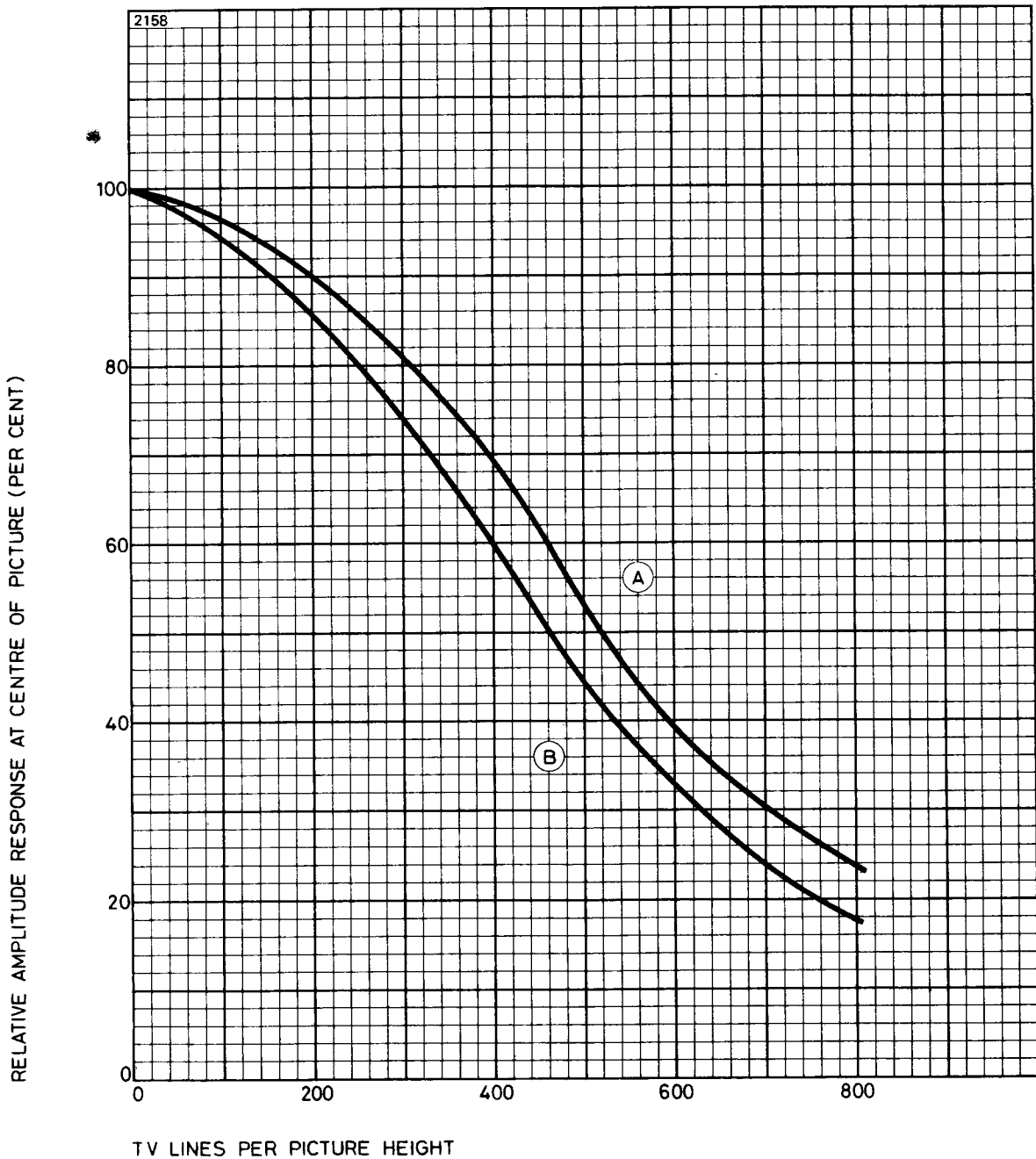

	<b>Curve A</b>	<b>Curve B</b>	
Grid 4 voltage . . . . .	750	500	V
Grid 3 voltage . . . . .	450	300	V
Focus field . . . . .	5.2	4.1	mT
	52	41	gauss
Highlight signal output current . . . . .	0.35	0.35	$\mu$ A
Dark current . . . . .	0.02	0.02	$\mu$ A
Test pattern . . . . .	square wave resolution wedge transparency		

Measured on a camera incorporating Cleveland Electronics deflection yoke VY-111-3, focusing coil VF-115-12 and alignment coil VA-118, the channel having a flat response and adequate bandwidth.

# TYPICAL LIGHT TRANSFER CHARACTERISTICS

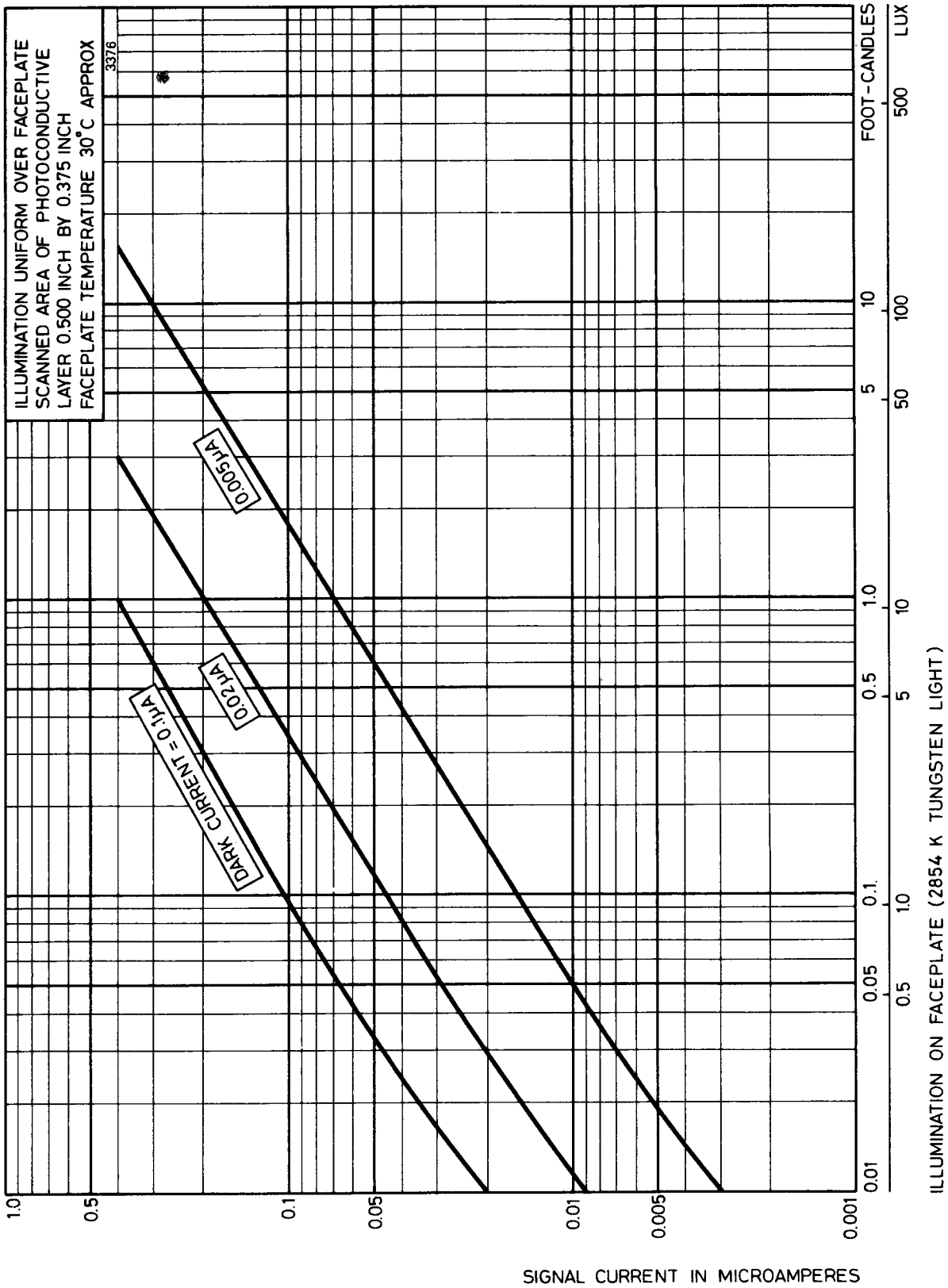

# TYPICAL RANGE OF DARK CURRENT

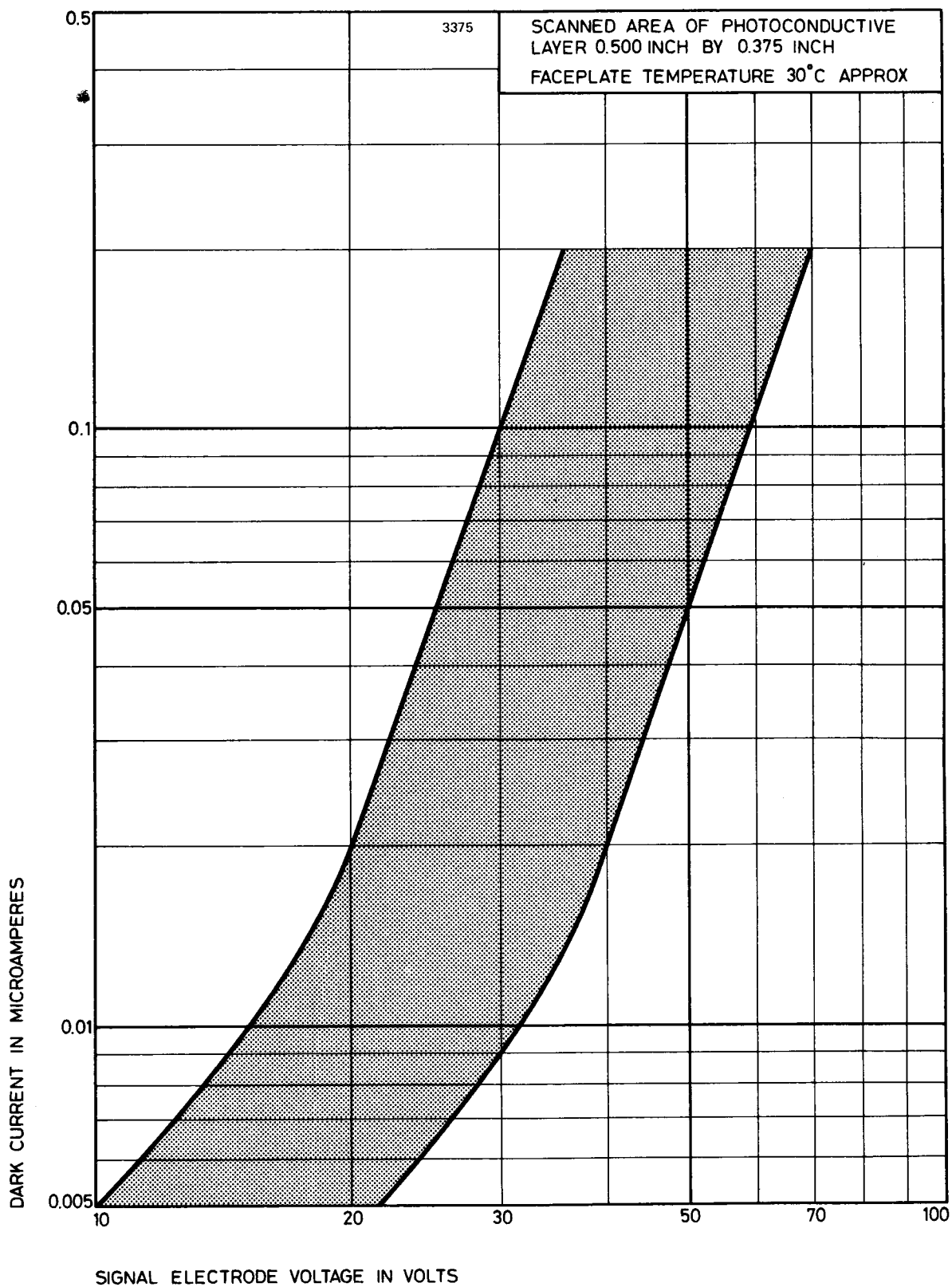

# TYPICAL LAG CHARACTERISTICS

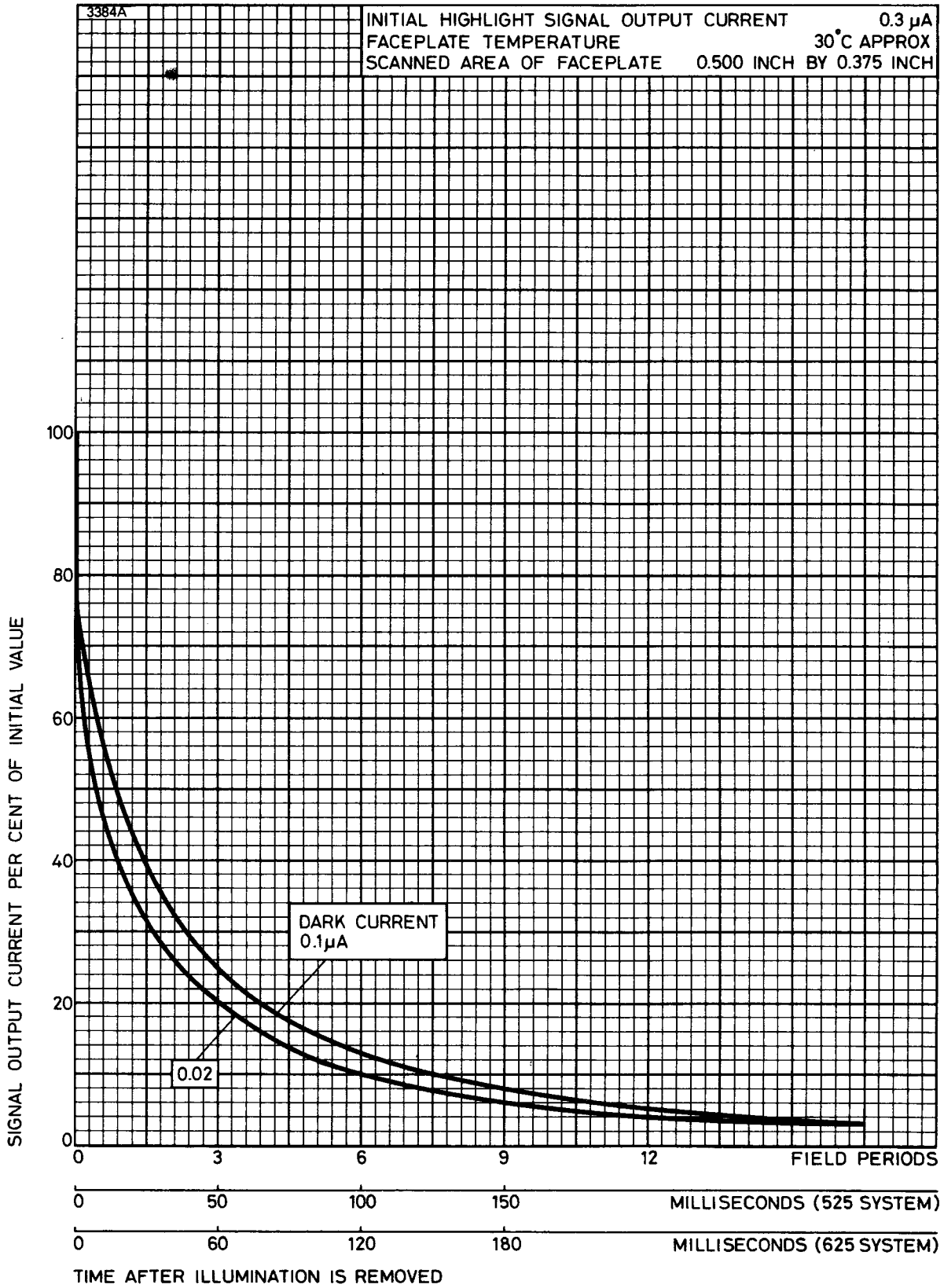

# OUTLINE (All dimensions without limits are nominal)

2157A

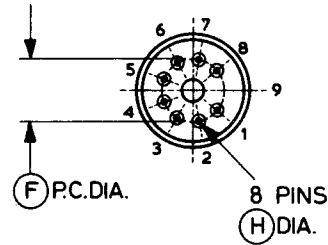
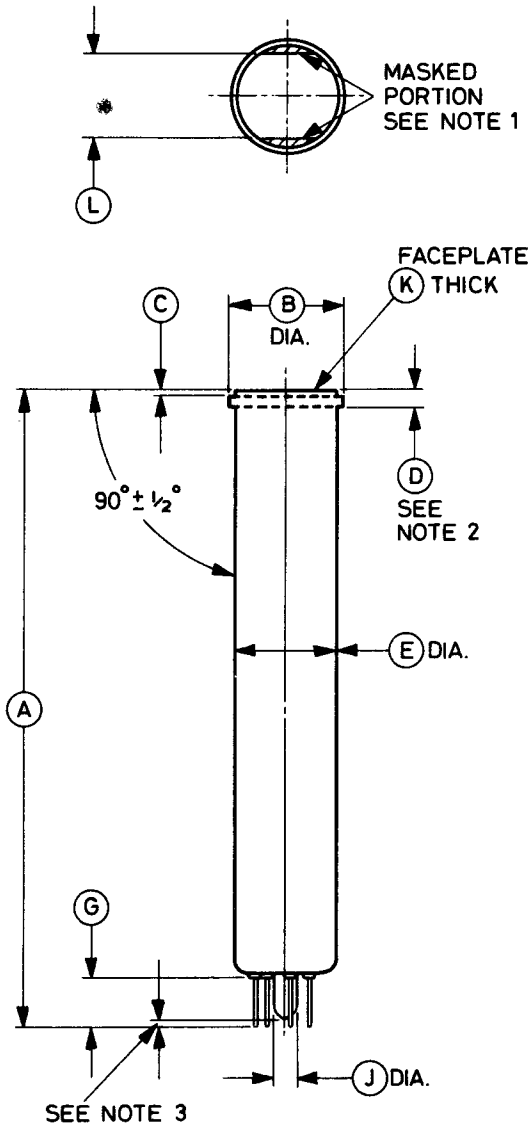

Pin	Element
1	Heater
2	Grid 1
3	Grid 4 (mesh)
4	Internal connection
5	Grid 2
6	Grid 3 (beam focus)
7	Cathode
8	Heater
9	Key pin position, blank
Flange	Signal electrode

## NOTES

1. The straight sides are parallel to the plane passing through the tube axis and pin position 9.
2. Signal electrode contact flange may be located along the tube axis in any part of or all of the space between the dashed lines.
3. The seal-off will not project beyond the pins.

Ref	Inches	Millimetres
A	6.250 ± 0.125	158.8 ± 3.2
B	1.125 ± 0.010	28.58 ± 0.25
C	0.050 max	1.27 max
D	0.175	4.45
E	1.020 + 0.030 - 0.035	25.91 + 0.76 - 0.89
F	0.600	15.24

Ref	Inches	Millimetres
G	0.503 max	12.78 max
H	0.050 + 0.002 - 0.004	1.270 + 0.051 - 0.102
J	0.265 max	6.73 max
K	0.093 ± 0.005	2.36 ± 0.13
L	0.835 ± 0.035	21.21 ± 0.89

Millimetre dimensions have been derived from inches.





# 8521

## VIDICON

---

### INTRODUCTION

The 8521 is a 1½-inch diameter vidicon with high sensitivity and high resolution capability. It is designed especially for black and white television pick-up in industrial closed-circuit TV systems where a limiting resolution of more than 1200 TV lines is required. The sensitivity of the photoconductive surface employed in this tube is sufficient to produce high-quality pictures under the lighting conditions normally encountered in industrial areas.



This vidicon features a separate mesh electrode and a very uniform target layer. Limiting resolutions in the region of 2000 TV lines may be obtained in the centre of the picture, optimum resolution being achieved when the grid 3 voltage is 0.6 to 0.7 of the mesh voltage.

A 4 watt (6.3V, 0.6A) heater is used in this tube making it suitable for use in equipment designed for series heater operation or having poor heater voltage regulation.

---

December 1972

## GENERAL DATA

### Electrical

Cathode . . . . .	indirectly heated, oxide coated	
Heater voltage . . . . .	6.3	V
Heater current . . . . .	0.6	A
Inter-electrode capacitance, signal electrode to all other electrodes (average value) (see note 1) . . . . .	8.0	pF
Spectral response . . . . .	see spectral sensitivity curve	
Focusing method . . . . .		magnetic
Deflection method . . . . .		magnetic

### Mechanical

Overall length . . . . .	8.000 inches (203.2mm) max
Overall diameter . . . . .	1.600 inches (40.64mm) max
Useful size of rectangular image; diagonal, centrally situated . . . . .	1.000 inch (25.4mm) max
Orientation . . . . .	see note 2
Net weight . . . . .	5.3 ounces (150g) approx
Mounting position (see note 3) . . . . .	any
Base . . . . .	small button super-ditetra 8-pin (JEDEC no. E8-78)

### Associated Components

Focusing-alignment assembly (see note 4) . . . . .	Cleveland Electronics 15-VFA-259
Deflection yoke . . . . .	Cleveland Electronics 15-VY-258
Mating socket . . . . .	Alden no. 208-SBSDC (or equivalent)

### Storage

Recommended store temperature . . . . .	15 to 35	°C
Tubes should be stored in darkness.		

### WARNING

When operating a tube the following precautions must be observed:

1. Ensure that the temperature of the tube is within its recommended range.
2. Avoid excessive exposure to high levels of illumination otherwise permanent damage to the photoconductive surface may result.



## MAXIMUM AND MINIMUM RATINGS (Absolute values)

No individual rating to be exceeded.

	Min	Max	
Heater voltage . . . . .	5.7	6.9	V
Signal electrode voltage . . . . .	—	100	V
Grid 4 (mesh) voltage (see note 5) . . . . .	—	1500	V
Grid 3 (beam focus) voltage (see note 5) . . . . .	—	1500	V
Grid 2 (accelerator) voltage . . . . .	—	550	V
Grid 1 voltage:			
negative bias value . . . . .	—	300	V
positive bias value . . . . .	—	0	V
Peak heater to cathode voltage:			
heater negative with respect to cathode . . . . .	—	125	V
heater positive with respect to cathode . . . . .	—	10	V
Dark current . . . . .	—	0.25	μA
Peak signal electrode current (see note 6) . . . . .	—	0.6	μA
Faceplate temperature . . . . .	—	71	°C
Faceplate illumination . . . . .	—	1000	ft-candles
	—	10 760	lux

## TYPICAL OPERATION

### Operating Conditions (for scanned area of 0.6 x 0.8 inch)

The following values and notes are for general guidance and may vary from tube to tube.

Grid 4 (mesh) voltage (see note 5) . . . . .	1400	V	
Grid 3 (beam focus) voltage (see notes 5 and 7) . . . . .	800 to 1000	V	
Grid 2 (accelerator) voltage . . . . .	300	V	
Grid 1 voltage for picture cut-off (with no blanking voltage on grid 1) . . . . .	—45 to —100	V	
Blanking voltage, peak to peak:			
when applied to grid 1 (negative pulses) . . . . .	75	V	
when applied to cathode (positive pulses) . . . . .	20	V	
Field strength at centre of focusing coil (see notes 4 and 7) (approx) . . . . .	4.6 46	mT gauss	
Peak deflection coil currents (approx):			
horizontal . . . . .	240	mA	
vertical . . . . .	50	mA	
Alignment field, adjustable (see note 8) . . . . .	0 to 0.4 0 to 4	mT gauss	
Faceplate temperature (see note 9) . . . . .	28 to 34	°C	

## Typical Performance

	Min	Typical	
Limiting resolution at centre of picture (approx) . . . . .	1200	2000	TV lines
Amplitude response to a 400 TV line square wave test pattern at centre of picture (approx) . . . . .	80	90	%
Lag (see note 10) . . . . .	—	30	%
'Gamma' of transfer characteristic for signal output between 0.02 and 0.6 $\mu$ A . . . . .	—	0.65	
Picture defects . . . . .			see note 11

	Condition			
	1*	2†	3‡	
Faceplate illumination (highlights) (see note 15) . . . . .	0.1 1.08	1.0 10.8	10 108	ft-candles lux
Signal output current (peak) (see note 16):				
typical . . . . .	0.2	0.2	0.3	$\mu$ A
minimum . . . . .	—	0.15	—	$\mu$ A
Approximate range of signal electrode voltage (see note 17) . . . . .	30–60	17–35	10–20	V
Dark current (see note 18) . . . . .	0.1	0.02	0.005	$\mu$ A

\* See note 12

† See note 13

‡ See note 14

## SEQUENCE OF CAMERA ADJUSTMENTS

(For general operational conditions as shown on page 3)

- (a) Set the grid 1 voltage for the maximum negative bias for picture cut-off and apply the other voltages given under Typical Operating Conditions.
- (b) Check that the deflection circuits are functioning properly and adjust the scanning amplitude controls so that a maximum area of the photoconductive layer will be scanned.
- (c) Set the signal electrode voltage to give the signal current specified for the particular condition of operation. The table above gives an indication of the ranges of signal electrode voltage required for three conditions of operation. For other conditions of operation, reference

should be made to the light transfer characteristic and the graph showing the range of signal electrode voltage to produce a given dark current and therefore a given sensitivity. It is preferable, if possible, to adjust the dark current to the specified value for the particular condition of operation; 8521 tubes will have substantially identical performances when operated with identical values of dark current.

The magnitude of non-uniformities of dark current, as well as lag, tend to increase with signal electrode voltage; therefore operation at low values of signal electrode voltage helps to minimize these effects.

- (d) Decrease grid 1 voltage from its maximum negative value until a signal is produced.
- (e) Adjust grid 3 (beam focus) or grid 3 and grid 4 (mesh) voltages, the lens stop and the optical focus alternately to obtain the best focused picture with the peak signal output current specified under Typical Performance.
- (f) Adjust the lens aperture and signal electrode voltage to produce the desired output signal. Lag decreases with increase in illumination on the faceplate.
- (g) Adjust the alignment field so that the centre of the picture does not move as grid 3 (beam focus) and grid 4 (mesh) voltages are rocked slightly. Adjust grid 1 (beam current) voltage to provide just sufficient beam to discharge the highlights. It is permissible to set the alignment fields slightly off the minimum movement position to maintain signal uniformity.
- (h) Adjust the deflection amplitude and position to scan an area 0.800 inch x 0.600 inch. This is facilitated by the use of a perspex mask inscribed with circles 0.800 inch and 0.600 inch diameter, placed in contact and concentric with the faceplate of the tube. Light is allowed to fall on the photoconductive layer and an image of the rings is obtained on the monitor. No lens is necessary. The scan amplitude and centring controls are adjusted until the diameter of the larger circle is equal to the width of the raster and that of the smaller equal to the height.
- (j) Centre the raster in the useful area of the photoconductive layer and check the alignment (step g).
- (k) If the picture is faint, even with adequate video gain, open the lens iris more and, if necessary, increase the signal electrode voltage.
- (l) Repeat steps (e) to (g) until optimum picture reproduction is obtained.

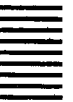

## NOTES

1. This capacitance, which in effect forms the output impedance of the tube, is increased when the tube is mounted in a deflecting yoke and focusing-alignment assembly. The resistive component of the output impedance is of the order of 100 megohms.
2. The horizontal scan should be parallel to the plane passing through the tube axis and the blank key-pin position. The masking is for orientation only and does not define the proper scanned area.
3. When the tube is subjected to vibration the mounting position must not be vertical with the base uppermost.
4. The direction of the focusing current should be such that a north pole is attracted to the image end of the focusing coil. The distance from the faceplate to the beginning of the winding is 0.75 inch approximately.
5. Grid 3 and grid 4 voltages are adjusted for the best focus. The resolution, uniformity of focus and picture quality decrease with decreasing grid 3 and grid 4 voltage. In general grid 3 should be at approximately 0.6 of grid 4 voltage.
6. The video amplifier must be designed to handle signal currents of this magnitude, to avoid picture distortion due to overloading of the amplifier.
7. It may be preferred to adjust beam focus by varying the focus coil current to obtain the field strengths indicated in the Typical Operating Conditions. If the focus coil field strength is fixed, beam focus may be obtained within a  $\pm 10\%$  range (approximately) of the grid 3 and grid 4 voltages. The ratio of 0.6 between grid 3 and grid 4 must be maintained as these voltages are varied.
8. Adjust the current through the alignment coils until the centre of the test pattern does not move as grid 3 and grid 4 voltages or the focus coil current are varied in and out of focus.
9. Unless the temperature of the faceplate is maintained at a constant value within this range, the dark current and performance will drift from the optimum performance established on initial setting up.

10. Percentage of initial value of signal output current remaining 3 field periods after light is cut off (i.e. 50ms in American standard systems and 60ms in European systems) with an initial highlight signal current of  $0.3\mu\text{A}$  and a faceplate illumination of 2 foot-candles.
11. This test is carried out with a faceplate illumination of 5.0 foot-candles (e.g. a scene brightness of 430 foot-lamberts with lens aperture f/4 and transmission 75%), scanned area of 0.8 by 0.6 inch and signal current  $0.3\mu\text{A}$ . The test pattern shown is used to define the picture zones.

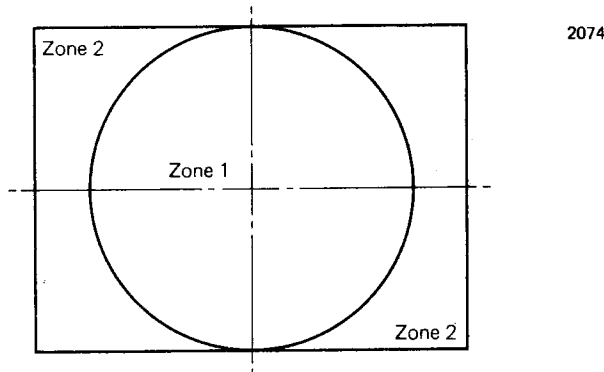

The limitations on size and number of spots will be according to the following table. Spots having a contrast ratio less than 1.5:1 for white spots and 2:1 for black spots are not counted. Smudges, streaks, or mottled or grainy background must have a contrast ratio of 1.5:1 to be cause for rejection.

Equivalent number of raster lines in a 625 line system	Number allowed	
	Zone 1	Zone 2
over 4	0	0
4 to but not including 3	0	1
3 to but not including 1	2	3
1 and under	*	*

\* Spots of this size may be present in unlimited numbers unless their concentration causes a smudged appearance.

12. Maximum sensitivity operation.
13. Average sensitivity operation.
14. High light level operation.
15. For example, a scene brightness of approximately 860 foot-lamberts ( $2950\text{cd/m}^2$ ) with lens aperture  $f/4$  and a transmission of 75% produces 10 foot candles (108 lux) illumination on the faceplate.
16. The signal output current is the highlight signal electrode current during one frame after the dark current component has been subtracted. Signal currents higher than  $0.5\mu\text{A}$  may be used depending on requirements.
17. The signal electrode voltage for each tube is adjusted to that value which gives the desired operating signal current; the indicated range of signal electrode voltage for each operational condition is given to illustrate the variation normally encountered.
18. The deflecting circuits must provide linear scanning for good black level reproduction under these conditions. Dark current is proportional to the scanning velocity. Any change in scanning velocity produces a black level error in direct proportion to the change in velocity of scanning.

# TYPICAL SPECTRAL SENSITIVITY CHARACTERISTIC

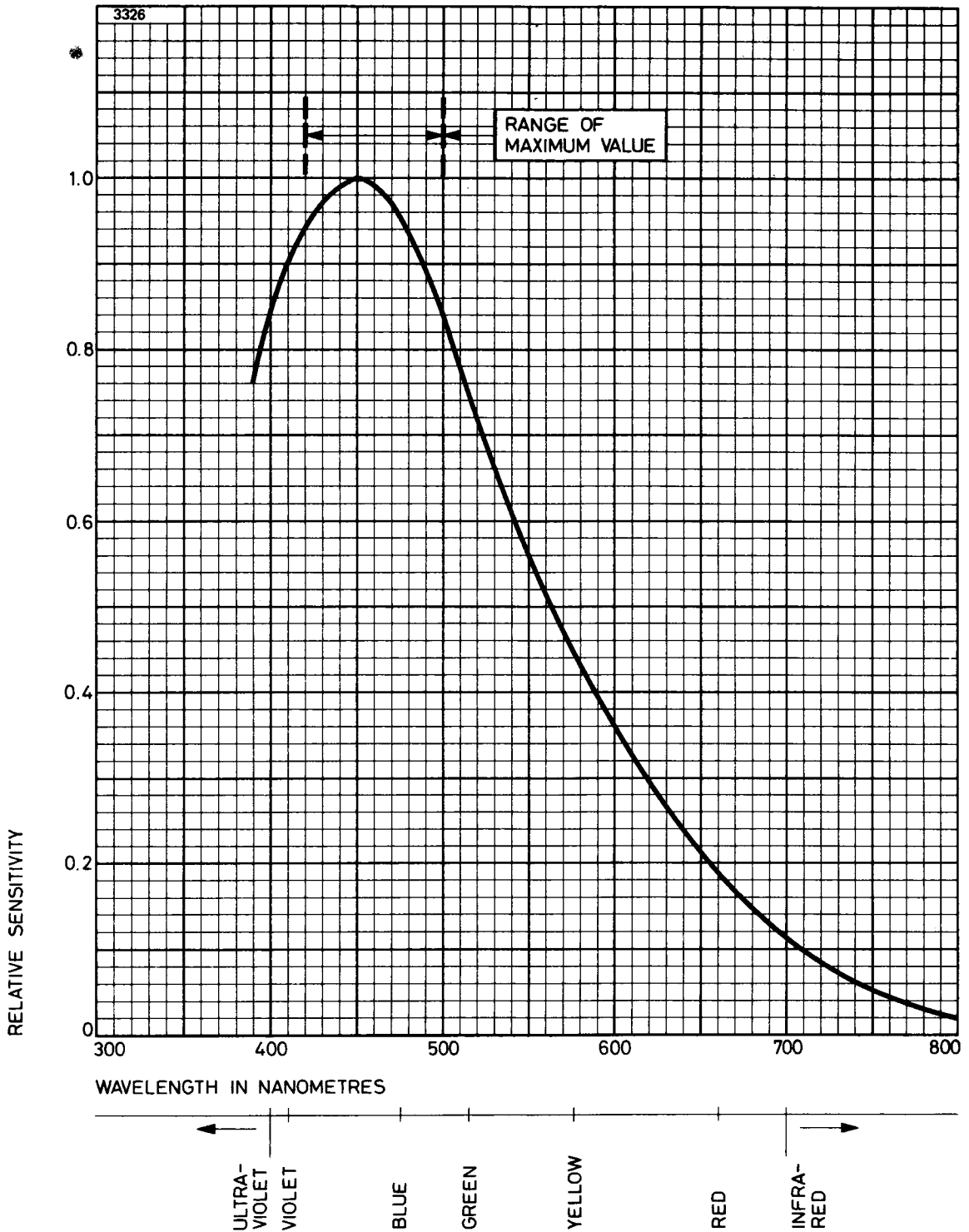

# TYPICAL RESOLUTION

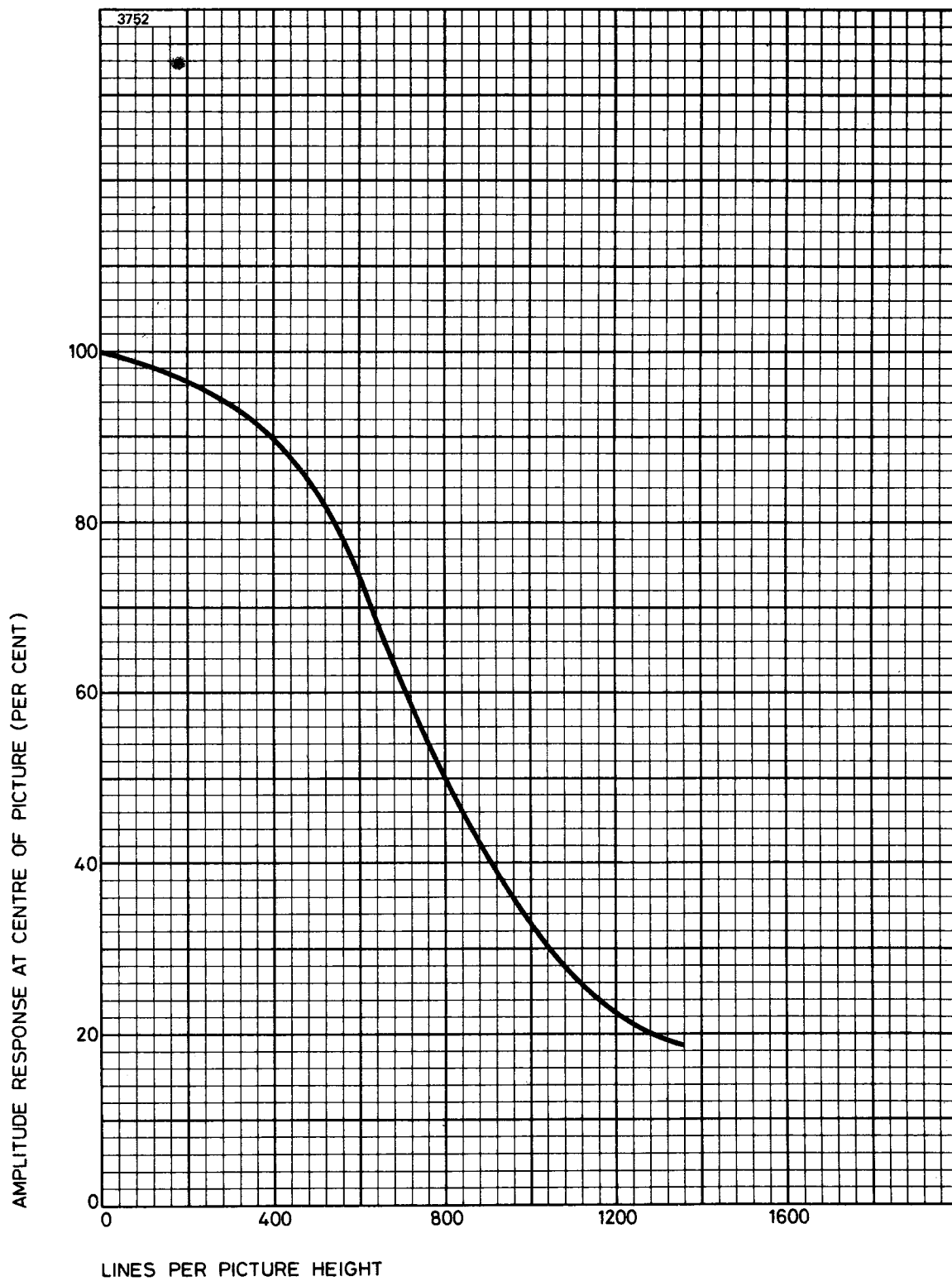



# TYPICAL LIGHT TRANSFER CHARACTERISTIC

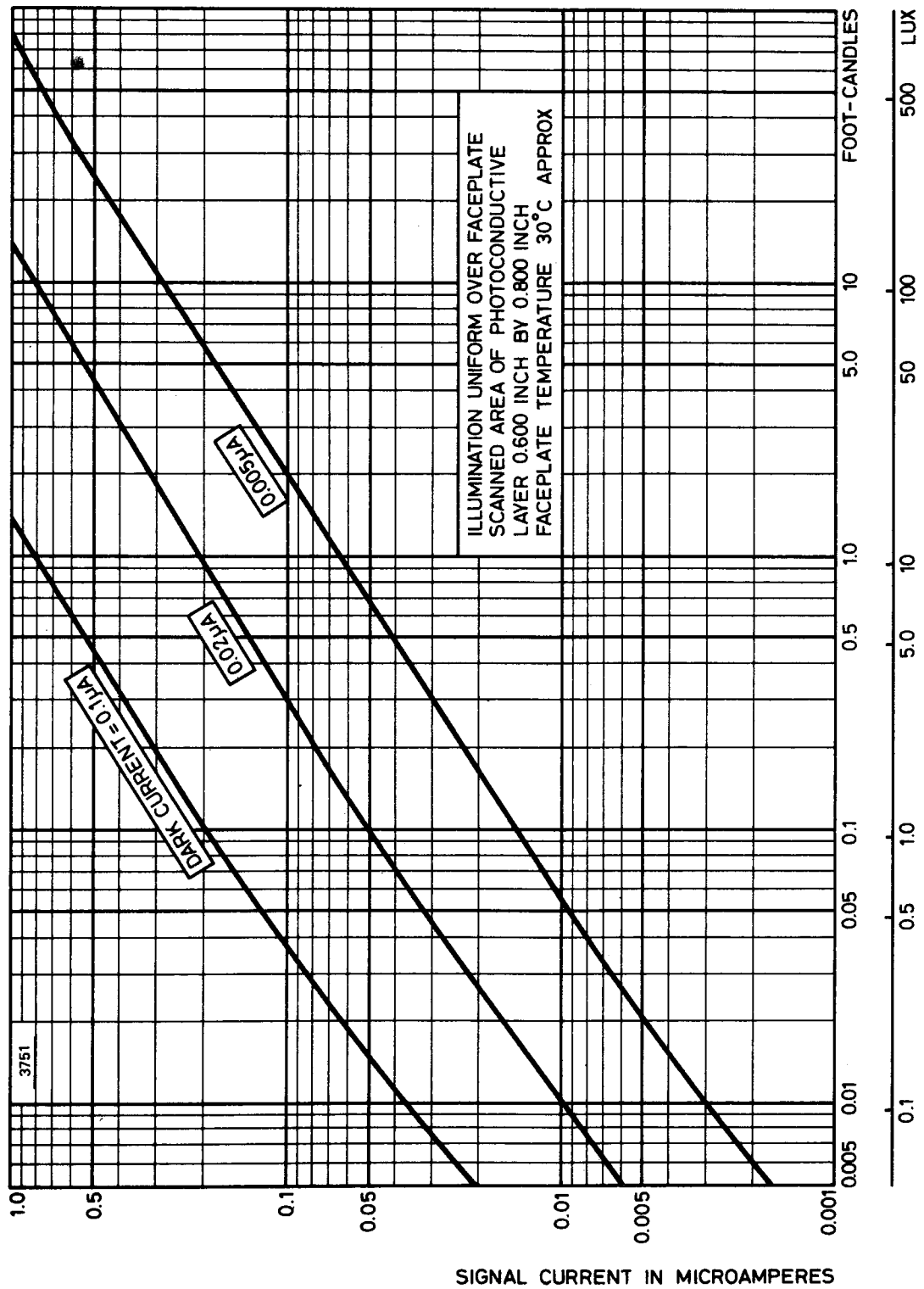

# TYPICAL RANGE OF DARK CURRENT

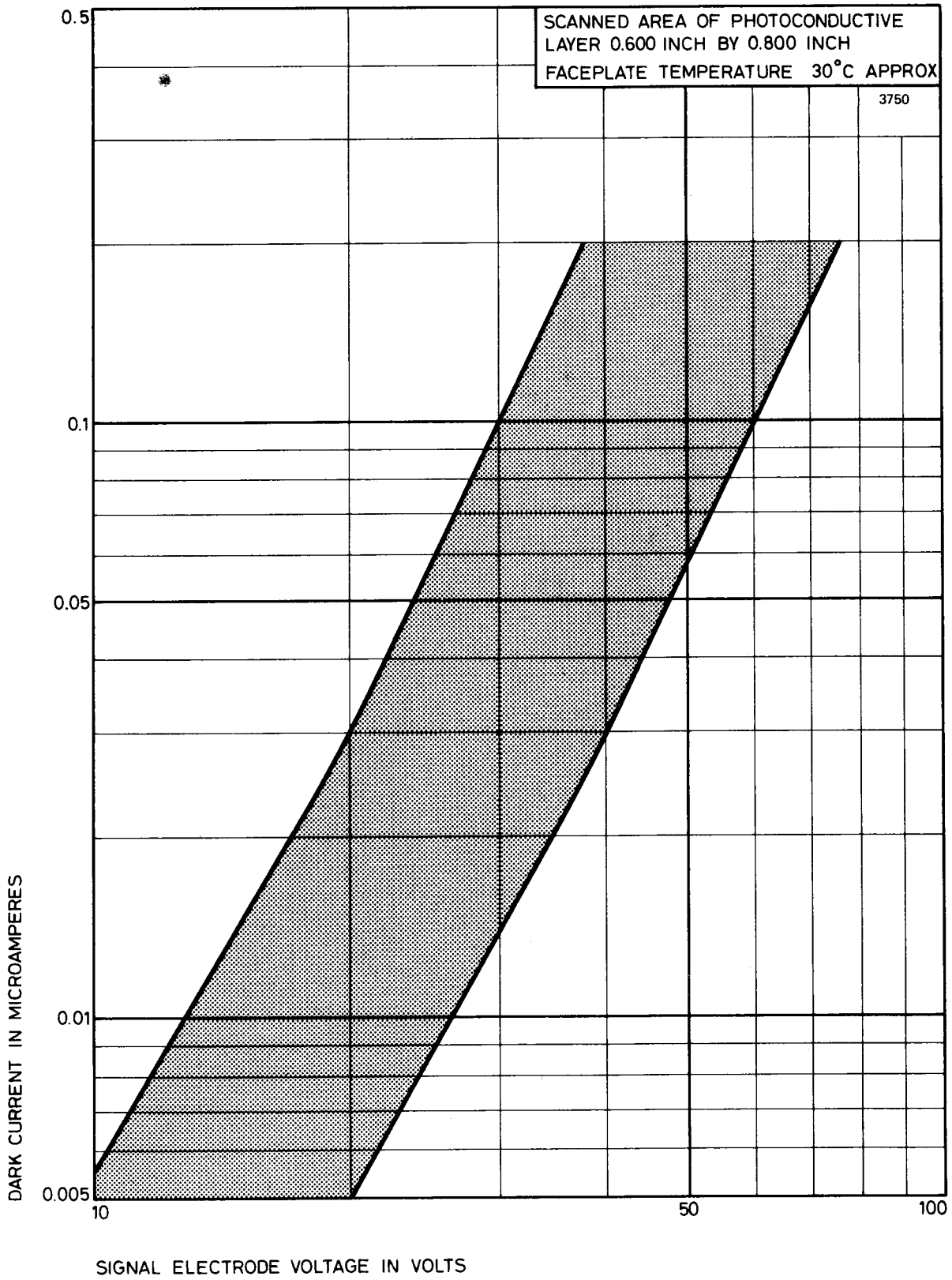

# TYPICAL LAG CHARACTERISTICS

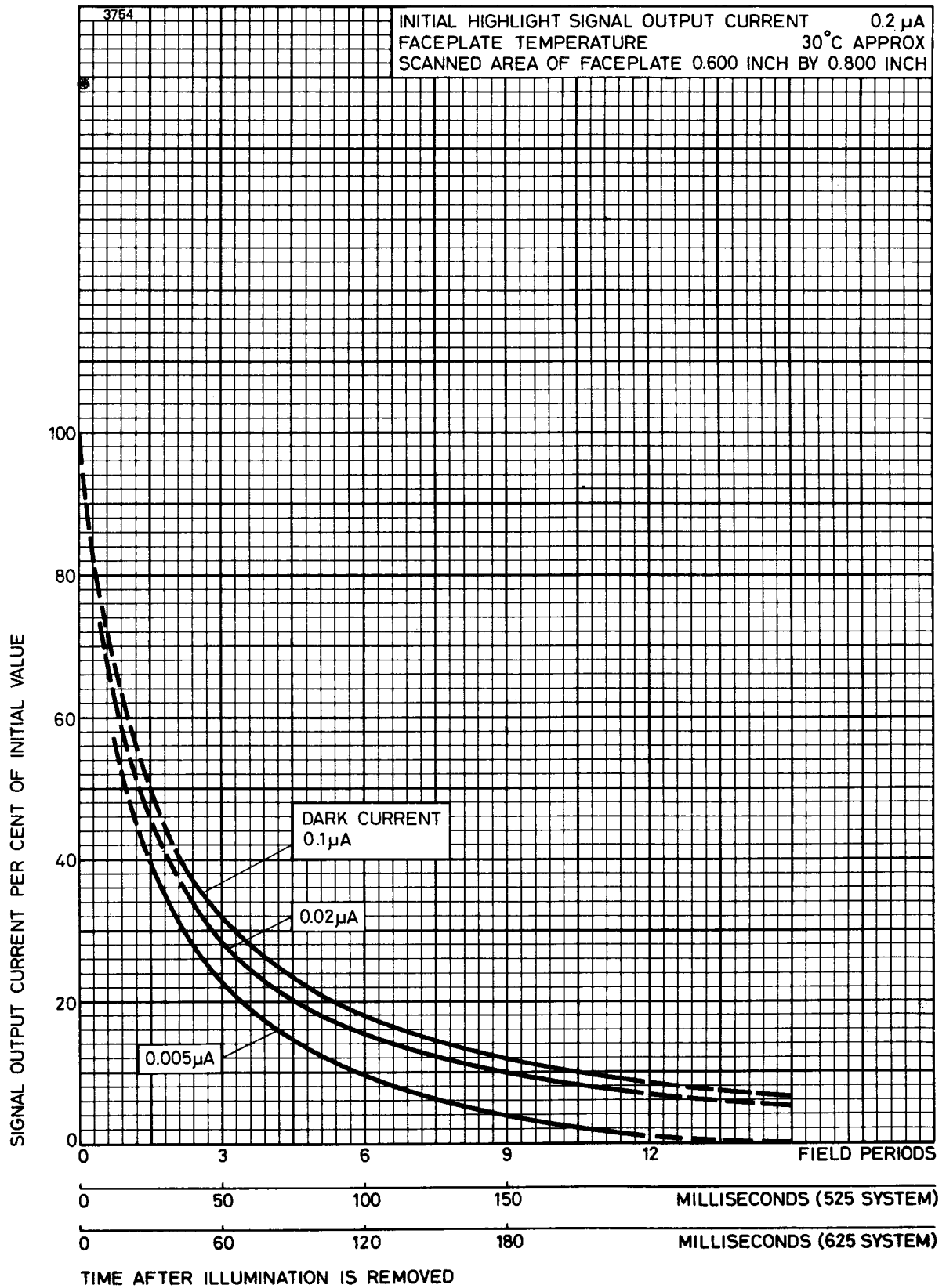

# OUTLINE (All dimensions without limits are nominal)

3739

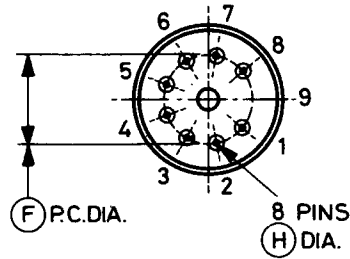
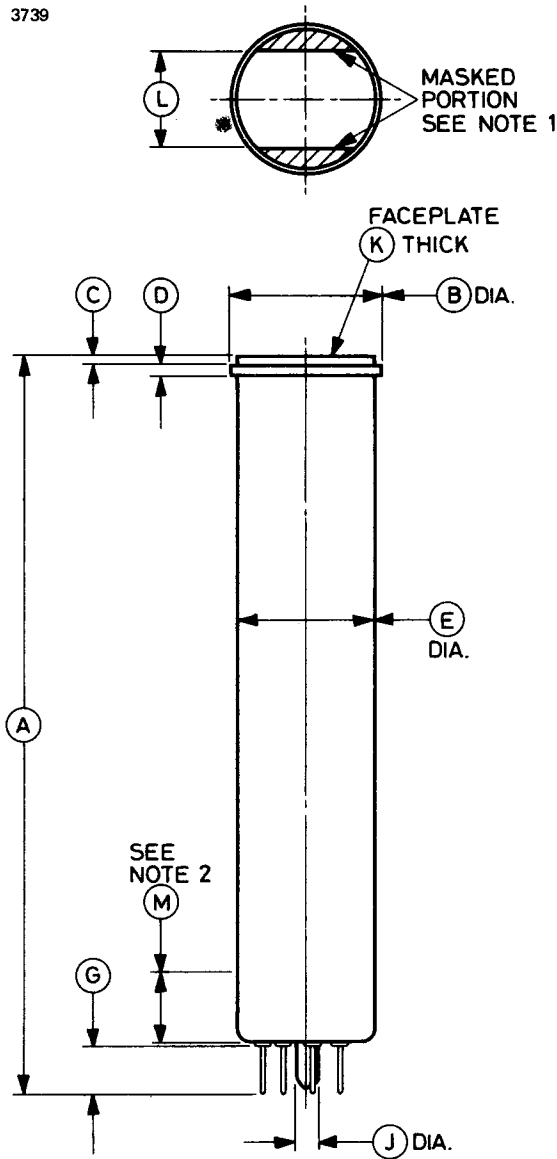

Pin	Element
1	Heater
2	Grid 1
3	Internal connection
4	Grid 4 (mesh)
5	Grid 2
6	Grid 3 (beam focus)
7	Cathode
8	Heater
9	Key pin position, blank
Flange	Signal electrode

## NOTES

1. The straight sides are parallel to the plane passing through the tube axis and pin position 9.
2. The minimum diameter does not apply over this length.

Ref	Inches	Millimetres
A	7.750 ± 0.250	196.85 ± 6.35
B	1.590 ± 0.010	40.39 ± 0.25
C	0.085 ± 0.010	2.16 ± 0.25
D	0.125	3.18
E	1.500 ± 0.010	38.10 ± 0.25
F	0.900	22.86
G	0.503 max	12.78 max

Ref	Inches	Millimetres
H	0.050 <sup>+0.002</sup> <sub>-0.004</sub>	1.270 <sup>+0.051</sup> <sub>-0.102</sub>
J	0.265 max	6.73 max
K	0.135 ± 0.005	3.43 ± 0.13
L	1.000 ± 0.050	25.40 ± 1.27
M	0.750	19.05

Millimetre dimensions have been derived from inches.

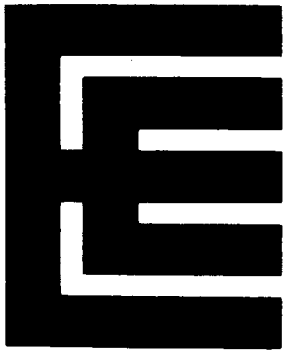

**8541A**  
(P842)

**VIDICON**

---

**Unilateral replacement for 8541**

### **INTRODUCTION**

The 8541A is a 1-inch diameter vidicon of high resolution capability, with magnetic deflection and focusing, designed for live pick-up in black and white TV cameras. It is also satisfactory for film pick-up and three-vidicon colour cameras.

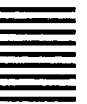
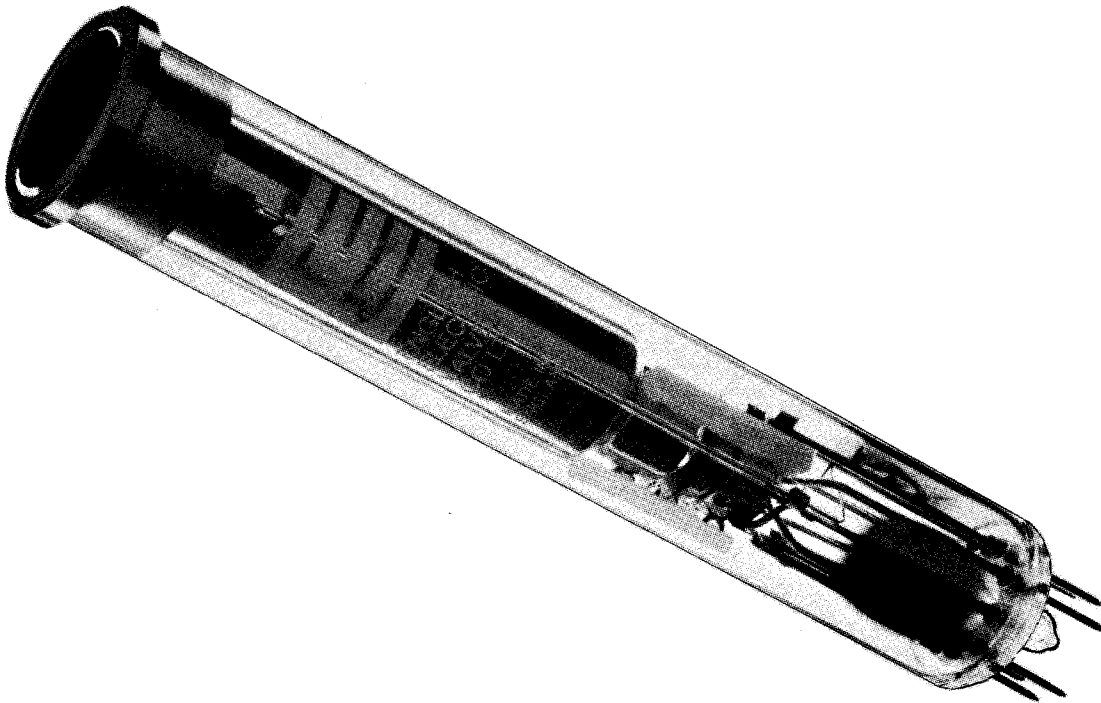

This vidicon features a separate mesh electrode and a very uniform target layer. Limiting resolutions in the region of 1100 TV lines may be obtained in the centre of the picture, optimum resolution being achieved when the grid 3 voltage is 0.6 to 0.7 of the mesh voltage.

A further feature of the 8541A is its low power heater which operates at 0.6 watt (95mA heater current). This allows the tube to be used in small compact transistorized TV cameras.

---

December 1972

**483**

## GENERAL DATA

### Electrical

Cathode . . . . .	indirectly heated, oxide coated
Heater voltage . . . . .	6.3 V
Heater current . . . . .	95 mA
Inter-electrode capacitance, signal electrode to all other electrodes (average value) (see note 1) . . . . .	4.6 pF
Spectral response . . . . .	see spectral sensitivity curve
Focusing method . . . . .	magnetic
Deflection method . . . . .	magnetic

### Mechanical

Overall length . . . . .	6.375 inches (162mm) max
Overall diameter . . . . .	1.135 inches (28.9mm) max
Useful size of rectangular image; diagonal, centrally situated . . . . .	0.63 inches (15.9mm) max
Orientation . . . . .	see note 2
Net weight . . . . .	2 ounces (60g) approx
Mounting position (see note 3) . . . . .	any
Base . . . . .	small button ditetar 8-pin (JEDEC no. E8-11)

### Associated Components

Focusing coil (see note 4) . . . . .	Cleveland Electronics VF-115-12
Deflection yoke . . . . .	Cleveland Electronics VY-111-3
Alignment coil (see note 5) . . . . .	Cleveland Electronics VA-118
Mating socket . . . . .	Type R41-79502 by United Carr Fasteners Ltd. (or equivalent)

### Storage

Recommended store temperature . . . . .	15 to 35 °C
---	-------------

Tubes should be stored in darkness.

## WARNING

When operating a tube the following precautions must be observed:

1. Ensure that the temperature of the tube is within its recommended range.
2. Avoid excessive exposure to high levels of illumination otherwise permanent damage to the photoconductive surface may result.
3. A surge limiting device must be incorporated if necessary to ensure that the heater current does not exceed 150mA when switching on or at any other time.

## MAXIMUM AND MINIMUM RATINGS (Absolute values)

No individual rating to be exceeded.

	Min	Max	
Heater voltage . . . . .	5.7	6.9	V
Signal electrode voltage . . . . .	—	100	V
Grid 4 (mesh) voltage (see note 6) . . . . .	—	1000	V
Grid 3 (beam focus) voltage (see note 6) . . . . .	—	1000	V
Grid 2 (accelerator) voltage . . . . .	—	750	V
Grid 1 voltage:			
negative bias value . . . . .	—	300	V
positive bias value . . . . .	—	0	V
Blanking voltage, peak to peak (see note 7):			
when applied to grid 1 (negative pulses) . . . . .	40	—	V
when applied to cathode (positive pulses) . . . . .	20	—	V
Peak heater to cathode voltage:			
heater negative with respect to cathode . . . . .	—	125	V
heater positive with respect to cathode . . . . .	—	10	V
Dark current . . . . .	—	0.25	$\mu$ A
Peak signal electrode current (see note 8) . . . . .	—	0.75	$\mu$ A
Faceplate temperature . . . . .	—	71	$^{\circ}$ C
Peak illumination of faceplate . . . . .	—	5000	ft-candles
	—	54 000	lux



## TYPICAL OPERATION

### Operating Conditions (for scanned area of 0.5 x 0.375 inch)

The following values and notes are for general guidance and may vary from tube to tube.

	Low Voltage Operation	High Voltage Operation	
Grid 4 (mesh) voltage (see note 6) . . . . .	500	900	V
Grid 3 (beam focus) voltage (approx) (see notes 6 and 9) . . . . .	300	540	V
Grid 2 (accelerator) voltage . . . . .	300	300	V
Grid 1 voltage for picture cut-off (with no blanking voltage on grid 1) . . . . .	-65 to -100	-65 to -100	V
Blanking voltage, peak to peak:			
when applied to grid 1 (negative pulses) . . . . .	75	75	V
when applied to cathode (positive pulses) . . . . .	20	20	V
Field strength at centre of focusing coil (see notes 4 and 9) . . . . .	$4.1 \pm 0.4$ $41 \pm 4$	$5.2 \pm 0.4$ $52 \pm 4$	mT gauss
Peak deflection coil currents (approx):			
horizontal . . . . .	200	240	mA
vertical . . . . .	25	30	mA
Alignment field, adjustable (see note 10)	0 to 0.4 0 to 4	0 to 0.4 0 to 4	mT gauss
Faceplate temperature (see note 11) . . . . .	30 to 35	30 to 35	°C



## Typical Performance

	Low Voltage	High Voltage	
Limiting resolution at centre of picture (approx) . . . . .	1000	1100	TV lines
Amplitude response to a 400 TV line square wave test pattern at centre of picture (approx) . . . . .	60	70	%
Lag (see note 12) . . . . .		20	%
'Gamma' of transfer characteristic for signal output between 0.02 and 0.2 $\mu$ A . . . . .		0.65	
Visual equivalent signal to noise ratio (see note 13) . . . . .		300:1	approx
Picture defects . . . . .			see note 14

	Condition			
	1*	2†	3‡	
Faceplate illumination (highlights) (see note 18) . . . . .	0.1 1.08	1.0 10.8	10 108	ft-candles lux
Signal output current (peak) (see note 19) . . . . .	0.1	0.2	0.3	$\mu$ A
Approximate range of signal electrode voltage (see note 20) . . . . .	30–60	20–40	10–22	V
Dark current (see note 21) . . . . .	0.1	0.02	0.005	$\mu$ A

\* See note 15

† See note 16

‡ See note 17

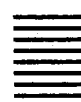

## SEQUENCE OF CAMERA ADJUSTMENTS

(For general operational conditions as shown on page 4)

- Set the grid 1 voltage for the maximum negative bias for picture cut-off and apply the other voltages given under Typical Operating Conditions.
- Check that the deflection circuits are functioning properly and adjust the scanning amplitude controls so that a maximum area of the photoconductive layer will be scanned.
- Set the signal electrode voltage to give the signal current specified for the particular condition of operation. The table above gives an indication of the ranges of signal electrode voltage required for three conditions of operation. For other conditions of operation, reference

should be made to the light transfer characteristic and the graph showing the range of signal electrode voltage to produce a given dark current and therefore a given sensitivity. It is preferable, if possible, to adjust the dark current to the specified value for the particular condition of operation; 8541A tubes will have substantially identical performances when operated with identical values of dark current.

The magnitude of non-uniformities of dark current, as well as lag, tend to increase with signal electrode voltage; therefore operation at low values of signal electrode voltage helps to minimize these effects.

- (d) Decrease grid 1 voltage from its maximum negative value until a signal is produced.
- (e) Adjust grid 3 (beam focus) or grid 3 and grid 4 (mesh) voltages, the lens stop and the optical focus alternately to obtain the best focused picture with the peak signal output current specified under Typical Performance.
- (f) Adjust the lens aperture and signal electrode voltage to produce the desired output signal. Lag decreases with increase in illumination on the faceplate.
- (g) Adjust the alignment field so that the centre of the picture does not move as grid 3 (beam focus) and grid 4 (mesh) voltages are rocked slightly. Adjust grid 1 (beam current) voltage to provide just sufficient beam to discharge the highlights. It is permissible to set the alignment fields slightly off the minimum movement position to maintain signal uniformity.
- (h) Adjust the deflection amplitude and position to scan an area 0.500 inch x 0.375 inch. This is facilitated by the use of a perspex mask inscribed with circles 0.500 inch and 0.375 inch diameter, placed in contact and concentric with the faceplate of the tube. Light is allowed to fall on the photoconductive layer and an image of the rings is obtained on the monitor. No lens is necessary. The scan amplitude and centring controls are adjusted until the diameter of the larger circle is equal to the width of the raster and that of the smaller equal to the height.
- (j) Centre the raster in the useful area of the photoconductive layer and check the alignment (step g).
- (k) If the picture is faint, even with adequate video gain, open the lens iris more and, if necessary, increase the signal electrode voltage.
- (l) Repeat steps (e) to (g) until optimum picture reproduction is obtained.

## NOTES

1. This capacitance, which in effect forms the output impedance of the tube, is increased when the tube is mounted in a deflecting yoke and focusing coil assembly. The resistive component of the output impedance is of the order of 100 megohms.
2. The horizontal scan should be parallel to the plane passing through the tube axis and the blank key-pin position. The masking is for orientation only and does not define the proper scanned area.
3. When the tube is subjected to vibration the mounting position must not be vertical with the base uppermost.
4. The direction of the focusing current should be such that a north pole is attracted to the image end of the focusing coil. The distance from the faceplate to the beginning of the winding is 0.75 inch approximately.
5. The alignment coil is located to the rear of the focusing coil directly over the electron gun. It should be located so that its centre is 3.69 inches from the faceplate of the tube and its axis should be coincident with the axis of the tube, the deflecting yoke and the focusing coil.
6. Grid 3 and grid 4 voltages are adjusted for the best focus. The resolution, uniformity of focus and picture quality decrease with decreasing grid 3 and grid 4 voltage. In general grid 3 should be operated above 250 volts and be approximately 0.6 of grid 4 voltage.
7. The blanking voltage required when applied to the cathode is less than that required when applied to grid 1 as the former reduces the potential difference between the cathode and the scanned side of the target.
8. The video amplifier must be designed to handle signal currents of this magnitude, to avoid picture distortion due to overloading of the amplifier.
9. It may be preferred to adjust beam focus by varying the focus coil current to obtain the field strengths indicated in the Typical Operating Conditions. If the focus coil field strength is fixed, beam focus may be obtained within a  $\pm 10\%$  range (approximately) of the grid 3 and grid 4 voltages. The ratio of 0.6 between grid 3 and grid 4 must be maintained as these voltages are varied.
10. Adjust the current through the alignment coils until the centre of the test pattern does not move as grid 3 and grid 4 voltages or the focus coil current are varied in and out of focus.



11. Unless the temperature of the faceplate is maintained at a constant value within this range, the dark current and performance will drift from the optimum performance established on initial setting up.
12. Percentage of initial value of signal output current remaining 3 field periods\* after light is cut off (i.e. 50ms in American standard systems and 60ms in European systems), with a total signal current of  $0.3\mu\text{A}$  and a dark current of  $0.02\mu\text{A}$ .
13. Measured with a high gain, low noise, cascode type pre-amplifier having a bandwidth of 5.1MHz and a peak signal output current of  $0.35\mu\text{A}$ . The visual equivalent signal to noise ratio is taken as the ratio of the highlight signal output current to the r.m.s. noise current, multiplied by a factor of 3 (ref. Otto H. Schade, *Electro-optical Characteristics of Television Systems; Introduction and Part 1 – Characteristics of Vision and Visual Systems*, RCA Review, March 1948).
14. This test is carried out with a faceplate illumination of 0.5 foot-candle (e.g. a scene brightness of 100 foot-lamberts with lens aperture f/6.3 and transmission 75%), scanned area of 0.5 by 0.375 inch and signal current  $0.3\mu\text{A}$ . The test pattern shown is used to define the picture zones.

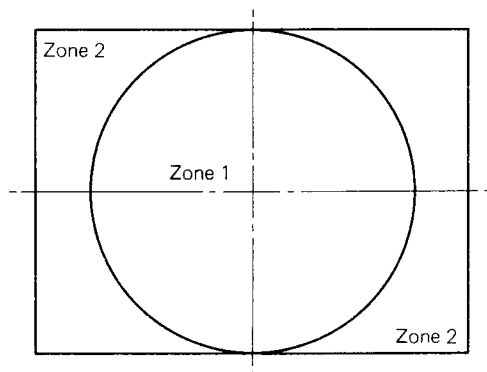

2074

The limitations on size and number of spots will be according to the following table. Spots having a contrast ratio less than 1.5:1 for white spots and 2:1 for black spots are not counted. Smudges, streaks, or mottled or grainy background must have a contrast ratio of 1.5:1 to be cause for rejection.

Equivalent number of raster lines in a 625 line system	Number allowed	
	Zone 1	Zone 2
* over 4	0	0
4 to but not including 3	0	1
3 to but not including 1	2	3
1 and under	*	*

Minimum separation between any two spots greater than 0.015 inch (1 line) is 0.25 inch (16 lines).

\* Spots of this size may be present in unlimited numbers unless their concentration causes a smudged appearance.

15. Maximum sensitivity operation.
16. Average sensitivity operation.
17. Highlight level operation.
18. For example, a scene brightness of approximately 860 foot-lamberts (2950cd/m<sup>2</sup>) with lens aperture f/4 and a transmission of 75% produces 10 foot candles (108 lux) illumination on the faceplate.
19. The signal output current is the highlight signal electrode current during one frame after the dark current component has been subtracted. Signal currents higher than 0.25μA may be used depending on requirements.
20. The signal electrode voltage for each tube is adjusted to that value which gives the desired operating signal current; the indicated range of signal electrode voltage for each operational condition is given to illustrate the variation normally encountered.
21. The deflecting circuits must provide linear scanning for good black level reproduction under these conditions. Dark current is proportional to the scanning velocity. Any change in scanning velocity produces a black level error in direct proportion to the change in velocity of scanning.



# TYPICAL SPECTRAL SENSITIVITY CHARACTERISTIC

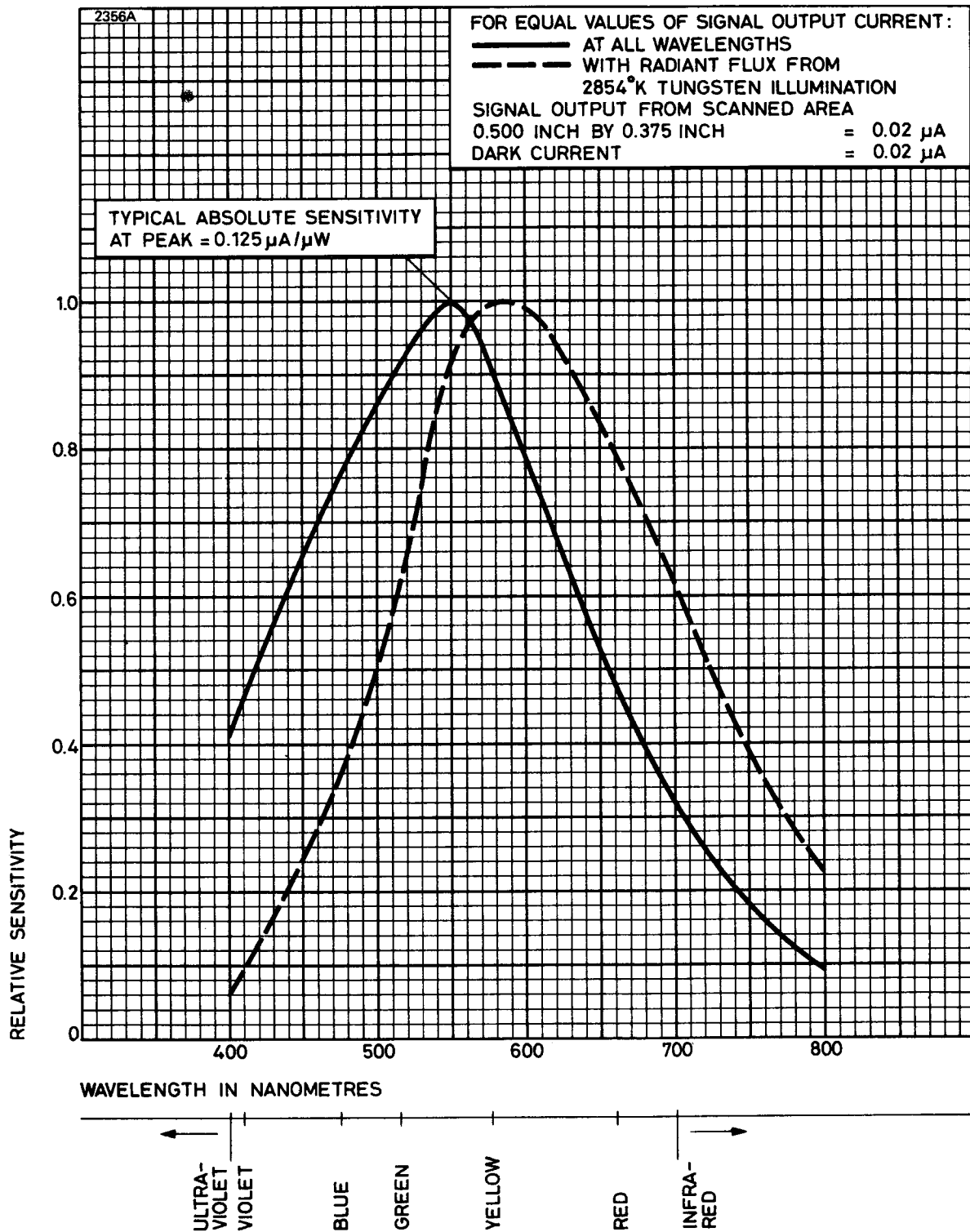

# TYPICAL RESOLUTION

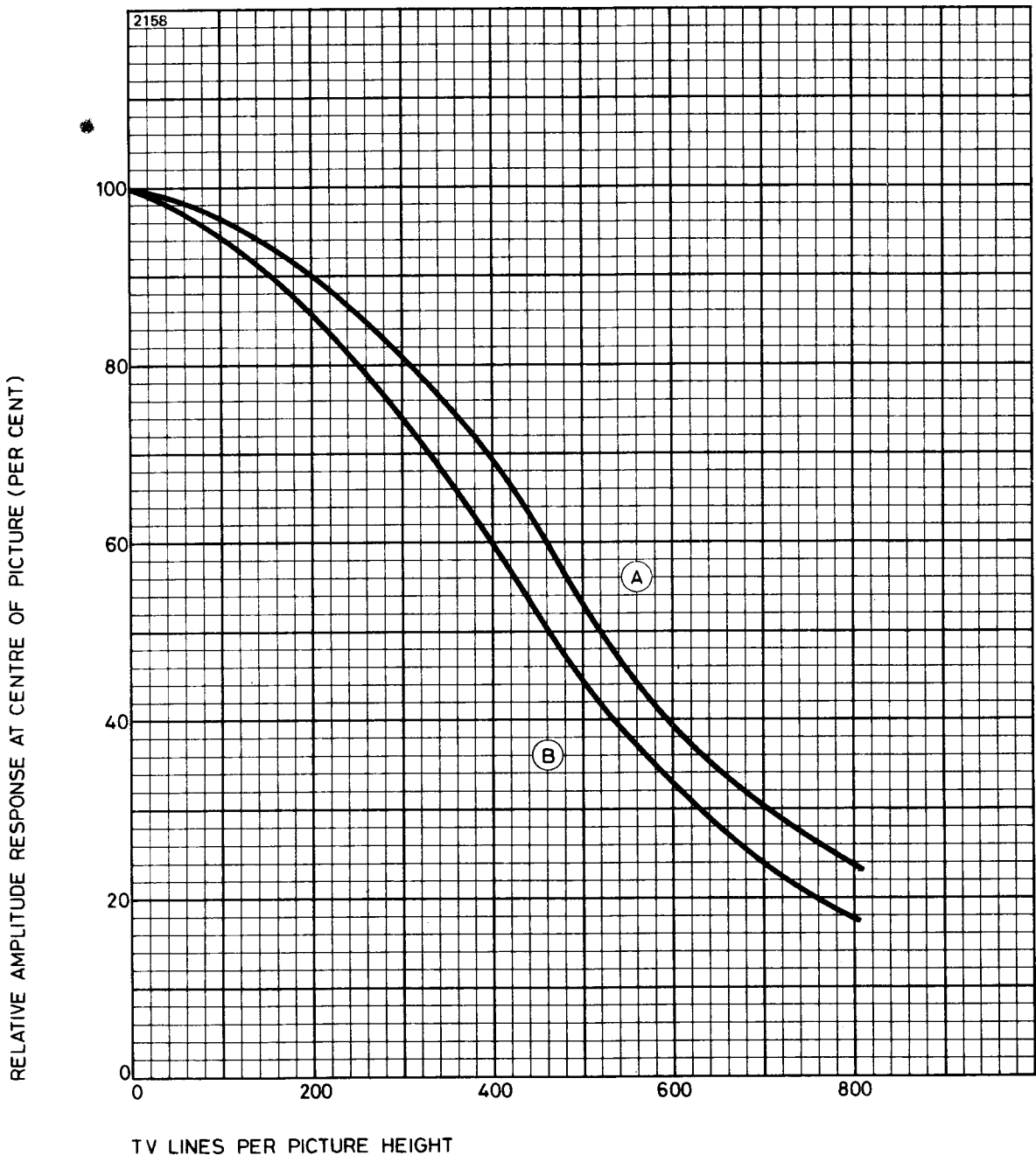

	<b>Curve A</b>	<b>Curve B</b>	
Grid 4 voltage . . . . .	750	500	V
Grid 3 voltage . . . . .	450	300	V
Focus field . . . . .	5.2	4.1	mT
	52	41	gauss
Highlight signal output current . . . . .	0.35	0.35	$\mu$ A
Dark current . . . . .	0.02	0.02	$\mu$ A
Test pattern . . . . .	square wave resolution wedge transparency		

Measured on a camera incorporating Cleveland Electronics deflection yoke VY-111-3, focusing coil VF-115-12 and alignment coil VA-118, the channel having a flat response and adequate bandwidth.

# TYPICAL LIGHT TRANSFER CHARACTERISTICS

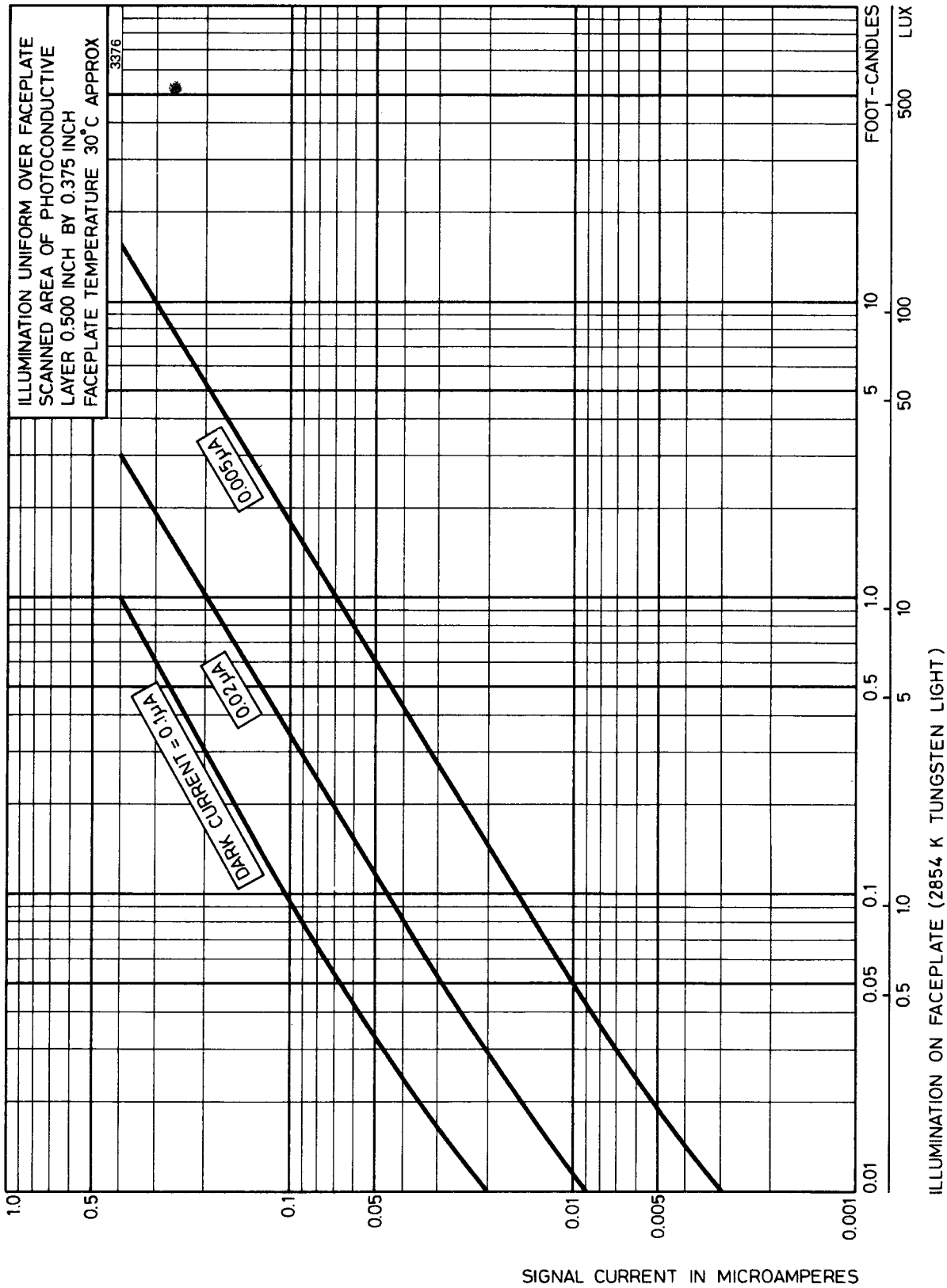



# TYPICAL RANGE OF DARK CURRENT

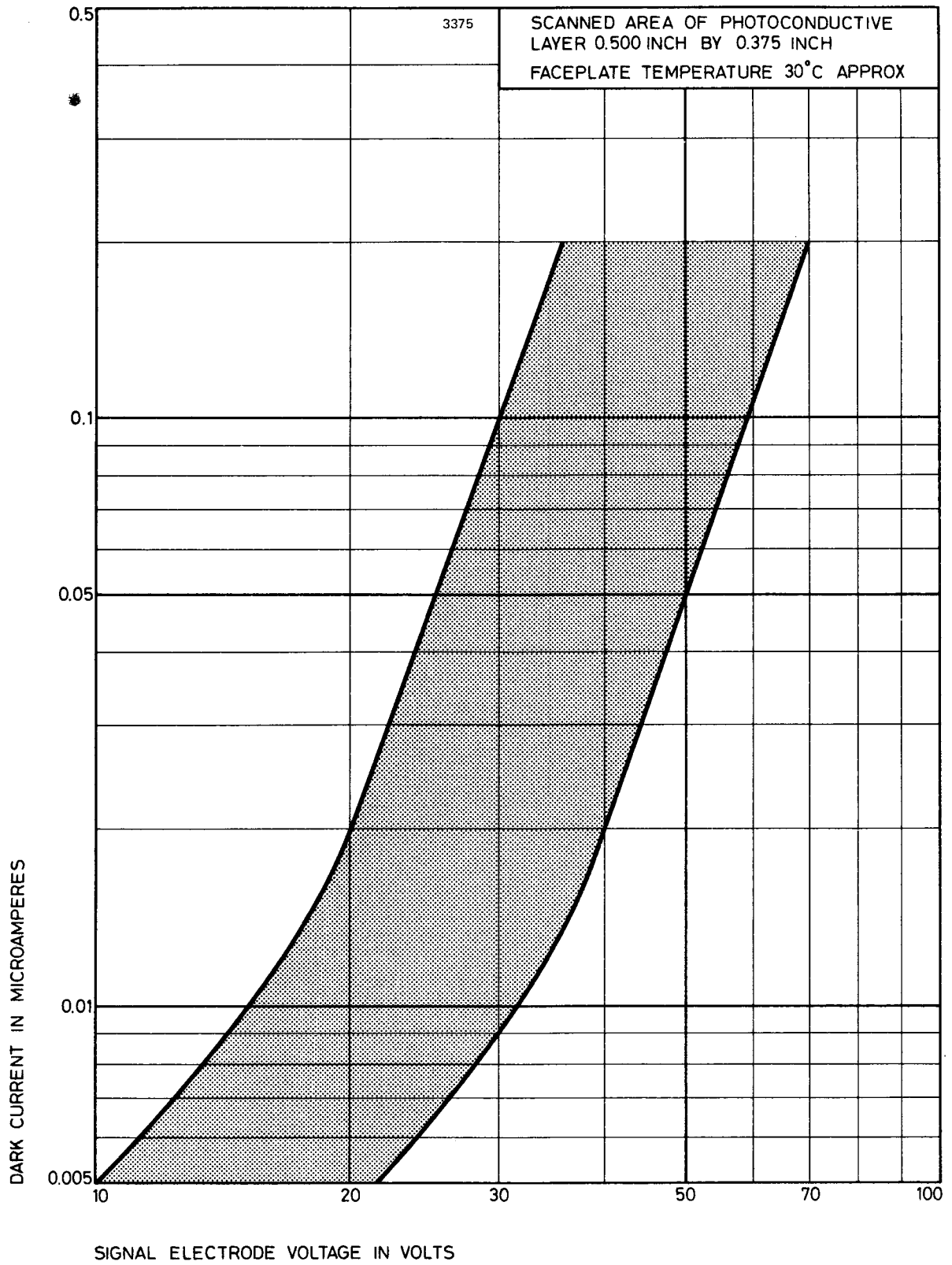

# TYPICAL LAG CHARACTERISTICS

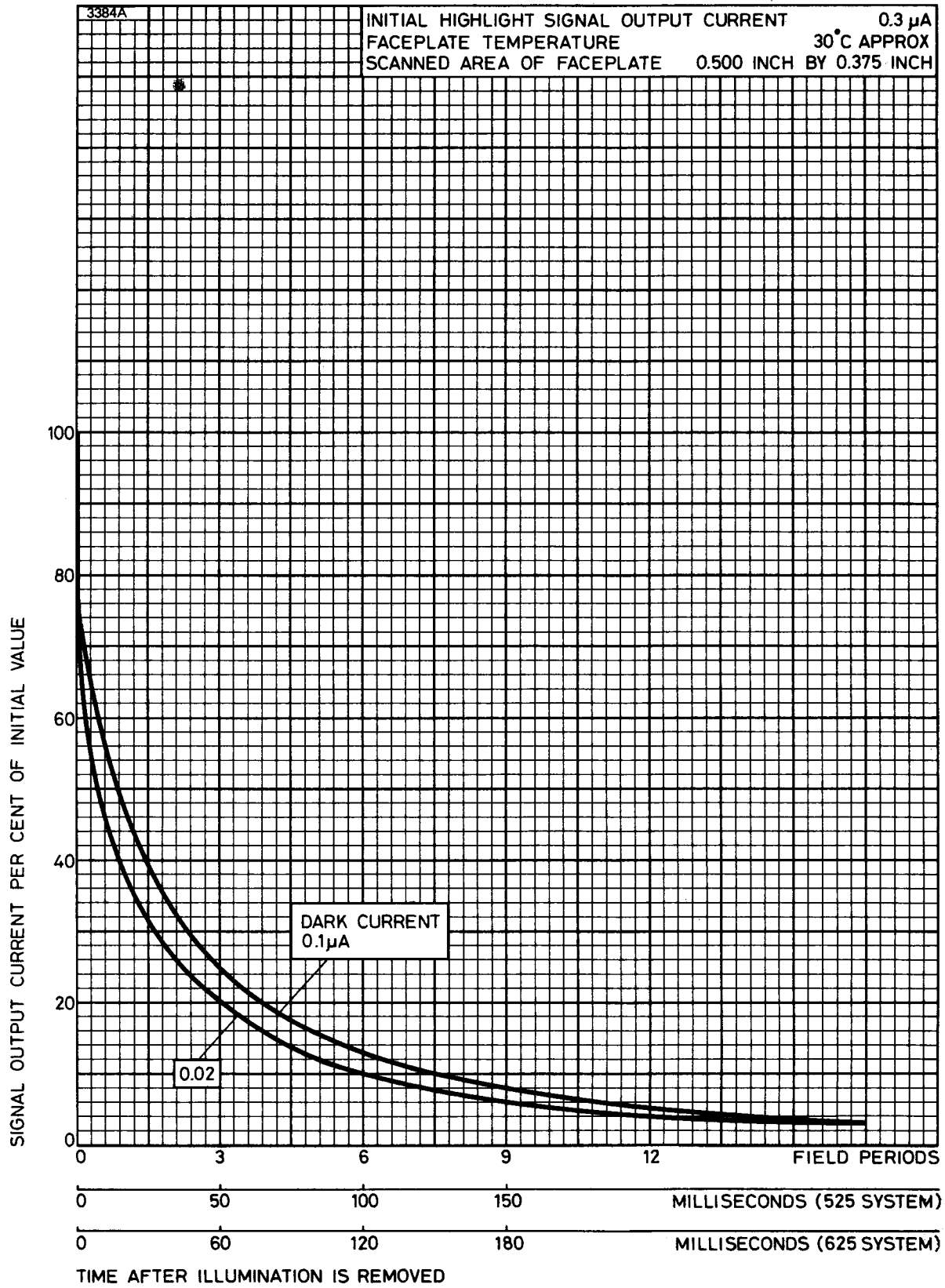

# OUTLINE (All dimensions without limits are nominal)

2157A

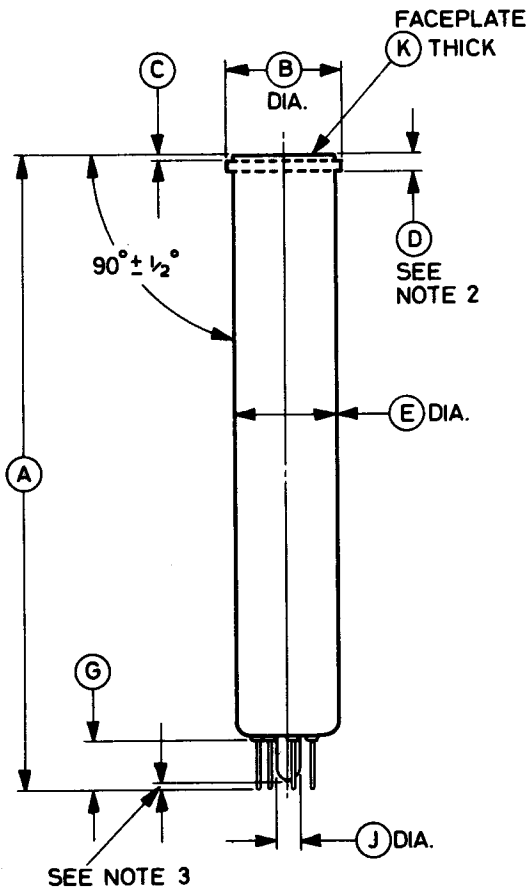
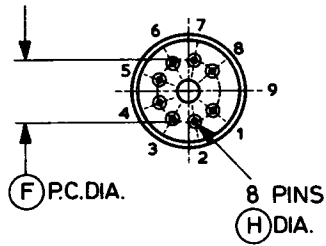
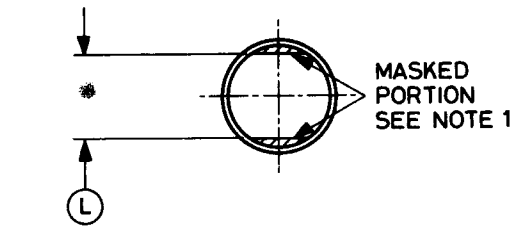

Pin	Element
1	Heater
2	Grid 1
3	Grid 4 (mesh)
4	Internal connection
5	Grid 2
6	Grid 3 (beam focus)
7	Cathode
8	Heater
9	Key pin position, blank
Flange	Signal electrode

### NOTES

1. The straight sides are parallel to the plane passing through the tube axis and pin position 9.
2. Signal electrode contact flange may be located along the tube axis in any part of or all of the space between the dashed lines.
3. The seal-off will not project beyond the pins.

Ref	Inches	Millimetres
A	6.250 ± 0.125	158.8 ± 3.2
B	1.125 ± 0.010	28.58 ± 0.25
C	0.050 max	1.27 max
D	0.175	4.45
E	1.020 + 0.030 - 0.035	25.91 + 0.76 - 0.89
F	0.600	15.24

Ref	Inches	Millimetres
G	0.503 max	12.78 max
H	0.050 + 0.002 - 0.004	1.270 + 0.051 - 0.102
J	0.265 max	6.73 max
K	0.093 ± 0.005	2.36 ± 0.13
L	0.835 ± 0.035	21.21 ± 0.89

Millimetre dimensions have been derived from inches.

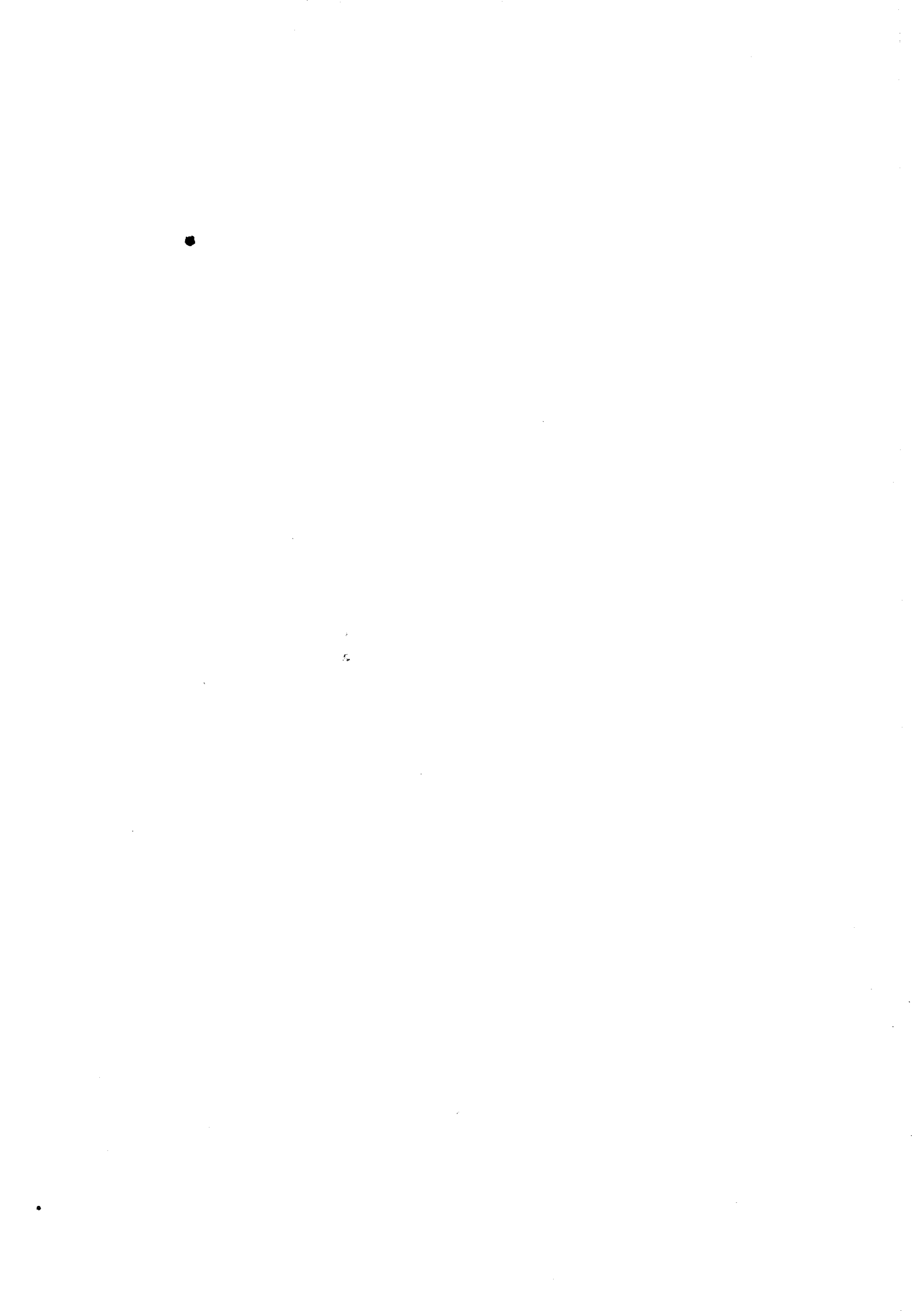

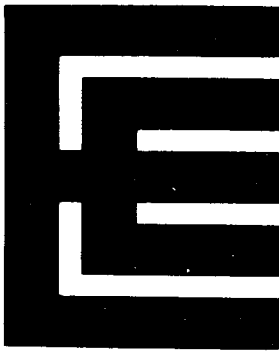

**8572A**  
(P843)

**VIDICON**

---

**Unilateral replacement for 8572**

**INTRODUCTION**

The 8572A is a 1-inch diameter vidicon of separate mesh construction, with magnetic deflection and focusing, employing the same photoconductive layer as type 7038. It is an improved version of 8572, which it replaces in all cameras. The photosurface may be exposed to bright stationary scenes for long periods without risk of burn-in or long term after-image. At high light levels the image retention time is very short, making it particularly suitable for use in telecine equipments. The spectral response is substantially panchromatic when used with tungsten illumination. The tube can be supplied fitted with an anti-halation stud (see page 15).

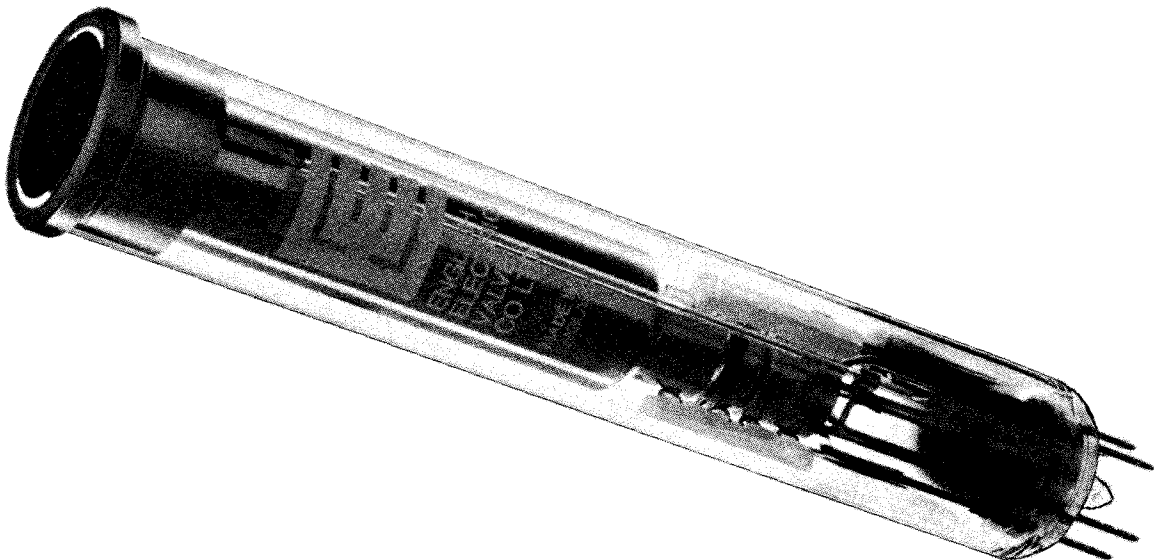

When operated with high voltages on grid 3 and the mesh, higher and more uniform resolution and improved signal uniformity are obtained than with integral mesh vidicons. Limiting resolutions in the region of 1100 TV lines may be obtained in the centre of the picture when the tube is operated under these conditions, optimum resolution being achieved when the grid 3 voltage is 0.6 to 0.7 of the mesh voltage.

A 4 watt (6.3V, 0.6A) heater is used in the 8572A.

---

December 1972

## GENERAL DATA

### Electrical

Cathode . . . . .	indirectly heated, oxide coated
Heater voltage . . . . .	6.3 V
Heater current . . . . .	0.6 A
Inter-electrode capacitance, signal electrode to all other electrodes (average value) (see note 1) . . . . .	4.6 pF
Spectral response . . . . .	see spectral sensitivity curve
Focusing method . . . . .	magnetic
Deflection method . . . . .	magnetic

### Mechanical

Overall length . . . . .	6.375 inches (162mm) max
Overall diameter . . . . .	1.135 inches (28.9mm) max
Useful size of rectangular image; diagonal, centrally situated . . . . .	0.63 inches (15.9mm) max
Orientation . . . . .	see note 2
Net weight . . . . .	2 ounces (60g) approx
Mounting position (see note 3) . . . . .	any
Base . . . . .	small button ditetrar 8-pin (JEDEC no. E8-11)

### Associated Components

Focusing coil (see note 4) . . . . .	Cleveland Electronics VF-115-12
Deflection yoke . . . . .	Cleveland Electronics VY-111-3
Alignment coil (see note 5) . . . . .	Cleveland Electronics VA-118
Mating socket . . . . .	Type R41-79502 by United Carr Fasteners Ltd. (or equivalent)

### Storage

Recommended store temperature . . . . .	15 to 35 °C
---	-------------

Tubes should be stored in darkness.

**WARNING**

Ensure that the temperature of the tube is within its recommended range.

**MAXIMUM AND MINIMUM RATINGS (Absolute values)**

No individual rating to be exceeded.

	<b>Min</b>	<b>Max</b>	
Heater voltage . . . . .	5.7	6.9	V
Signal electrode voltage . . . . .	—	125	V
Grid 4 (mesh) voltage (see note 6) . . . . .	—	1000	V
Grid 3 (beam focus) voltage (see note 6) . . . . .	—	1000	V
Grid 2 (accelerator) voltage . . . . .	—	750	V
Grid 1 voltage:			
negative bias value . . . . .	—	300	V
positive bias value . . . . .	—	0	V
Blanking voltage, peak to peak (see note 7):			
when applied to grid 1 (negative pulses) . . . . .	40	—	V
when applied to cathode (positive pulses) . . . . .	20	—	V
Peak heater to cathode voltage:			
heater negative with respect to cathode . . . . .	—	125	V
heater positive with respect to cathode . . . . .	—	10	V
Dark current . . . . .	—	0.25	$\mu$ A
Peak signal electrode current (see note 8) . . . . .	—	0.75	$\mu$ A
Faceplate temperature . . . . .	—	71	$^{\circ}$ C
Peak illumination of faceplate . . . . .	—	5000	ft-candles
	—	54 000	lux



## TYPICAL OPERATION

### Operating Conditions (for scanned area of 0.5 x 0.375 inch)

The following values and notes are for general guidance and may vary from tube to tube.

	Low Voltage Operation	High Voltage Operation	
Grid 4 (mesh) voltage (see note 6) . . . . .	500	900	V
Grid 3 (beam focus) voltage (approx) (see notes 6 and 9) . . . . .	300	540	V
Grid 2 (accelerator) voltage . . . . .	300	300	V
Grid 1 voltage for picture cut-off (with no blanking voltage on grid 1) . . . . .	-65 to -100	-65 to -100	V
Blanking voltage, peak to peak:			
when applied to grid 1 (negative pulses) . . . . .	75	75	V
when applied to cathode (positive pulses) . . . . .	20	20	V
Field strength at centre of focusing coil (see notes 4 and 9) . . . . .	4.1 ± 0.4 41 ± 4	5.2 ± 0.4 52 ± 4	mT gauss
Peak deflection coil currents (approx):			
horizontal . . . . .	200	240	mA
vertical . . . . .	25	30	mA
Alignment field, adjustable (see note 10)	0 to 0.4 0 to 4	0 to 0.4 0 to 4	mT gauss
Faceplate temperature (see note 11) . . . . .	30 to 35	30 to 35	°C



## Typical Performance

	Low Voltage	High Voltage	
Limiting resolution at centre of picture (approx) . . . . .	1000	1100	TV lines
Amplitude response to a 400 TV line square wave test pattern at centre of picture (approx) . . . . .	60	70	%
Lag (see note 12) . . . . .		7.5	%
'Gamma' of transfer characteristic for signal output between 0.02 and 0.2 $\mu$ A . . . . .		0.65	
Visual equivalent signal to noise ratio (see note 13) . . . . .		300:1	approx

	Condition		
	1*	2†	
Faceplate illumination (highlights) (see note 16) . . . . .	10	100	ft-candles
	108	1076	lux
Signal output current (highlights) (see note 17) . . . . .	0.3	0.3	$\mu$ A
Approximate range of signal electrode voltage (see note 18) . . . . .	25–60	12–30	V
Dark current (see note 19) . . . . .	0.02	0.004	$\mu$ A

\* See note 14

† See note 15



## SEQUENCE OF CAMERA ADJUSTMENTS

(For general operational conditions as shown on page 4)

- (a) Set the grid 1 voltage for the maximum negative bias for picture cut-off and apply the other voltages given under Typical Operating Conditions.
- (b) Check that the deflection circuits are functioning properly and adjust the scanning amplitude controls so that a maximum area of the photoconductive layer will be scanned.
- (c) Set the signal electrode voltage to give the signal current specified for the particular condition of operation. The table above gives an indication of the ranges of signal electrode voltage required for two conditions of operation. For other conditions of operation, reference

should be made to the light transfer characteristic and the graph showing the range of signal electrode voltage to produce a given dark current and therefore a given sensitivity. It is preferable, if possible, to adjust the dark current to the specified value for the particular condition of operation; 8572A tubes will have substantially identical performances when operated with identical values of dark current.

The magnitude of non-uniformities of dark current, as well as lag, tend to increase with signal electrode voltage; therefore operation at low values of signal electrode voltage helps to minimize these effects.

- (d) Decrease grid 1 voltage from its maximum negative value until a signal is produced.
- (e) Adjust grid 3 (beam focus) or grid 3 and grid 4 (mesh) voltages, the lens stop and the optical focus alternately to obtain the best focused picture with the peak signal output current specified under Typical Performance.
- (f) Adjust the lens aperture and signal electrode voltage to produce the desired output signal. Lag decreases with increase in illumination on the faceplate.
- (g) Adjust the alignment field so that the centre of the picture does not move as grid 3 (beam focus) and grid 4 (mesh) voltages are rocked slightly. Adjust grid 1 (beam current) voltage to provide just sufficient beam to discharge the highlights. It is permissible to set the alignment fields slightly off the minimum movement position to maintain signal uniformity.
- (h) Adjust the deflection amplitude and position to scan an area 0.500 inch x 0.375 inch. This is facilitated by the use of a perspex mask inscribed with circles 0.500 inch and 0.375 inch diameter, placed in contact and concentric with the faceplate of the tube. Light is allowed to fall on the photoconductive layer and an image of the rings is obtained on the monitor. No lens is necessary. The scan amplitude and centring controls are adjusted until the diameter of the larger circle is equal to the width of the raster and that of the smaller equal to the height.
- (j) Centre the raster in the useful area of the photoconductive layer and check the alignment (step g).
- (k) If the picture is faint, even with adequate video gain, open the lens iris more and, if necessary, increase the signal electrode voltage.
- (l) Repeat steps (e) to (g) until optimum picture reproduction is obtained.

## NOTES

1. This capacitance, which in effect forms the output impedance of the tube, is increased when the tube is mounted in a deflecting yoke and focusing coil assembly. The resistive component of the output impedance is of the order of 100 megohms.
2. The horizontal scan should be parallel to the plane passing through the tube axis and the blank key-pin position. The masking is for orientation only and does not define the proper scanned area.
3. When the tube is subjected to vibration the mounting position must not be vertical with the base uppermost.
4. The direction of the focusing current should be such that a north pole is attracted to the image end of the focusing coil. The distance from the faceplate to the beginning of the winding is 0.75 inch approximately.
5. The alignment coil is located to the rear of the focusing coil directly over the electron gun. It should be located so that its centre is 3.69 inches from the faceplate of the tube and its axis should be coincident with the axis of the tube, the deflecting yoke and the focusing coil.
6. Grid 3 and grid 4 voltages are adjusted for the best focus. The resolution, uniformity of focus and picture quality decrease with decreasing grid 3 and grid 4 voltage. In general grid 3 should be operated above 250 volts and be approximately 0.6 of grid 4 voltage.
7. The blanking voltage required when applied to the cathode is less than that required when applied to grid 1 as the former reduces the potential difference between the cathode and the scanned side of the target.
8. The video amplifier must be designed to handle signal currents of this magnitude, to avoid picture distortion due to overloading of the amplifier.
9. It may be preferred to adjust beam focus by varying the focus coil current to obtain the field strengths indicated in the Typical Operating Conditions. If the focus coil field strength is fixed, beam focus may be obtained within a  $\pm 10\%$  range (approximately) of the grid 3 and grid 4 voltages. The ratio of 0.6 between grid 3 and grid 4 must be maintained as these voltages are varied.
10. Adjust the current through the alignment coils until the centre of the test pattern does not move as grid 3 and grid 4 voltages or the focus coil current are varied in and out of focus.

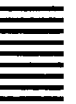

11. Unless the temperature of the faceplate is maintained at a constant value within this range, the dark current and performance will drift from the optimum performance established on initial setting up.
12. Percentage of initial value of signal output current remaining 3 field periods after light is cut off (i.e. 50ms in American standard systems and 60ms in European systems), with a faceplate illumination of 100 foot-candles and a total signal current of  $0.3\mu\text{A}$ .
13. Measured with a high gain, low noise, cascode type pre-amplifier having a bandwidth of 5.1MHz and a peak signal output current of  $0.35\mu\text{A}$ . The visual equivalent signal to noise ratio is taken as the ratio of the highlight signal output current to the r.m.s. noise current, multiplied by a factor of 3 (ref. Otto H. Schade, *Electro-optical Characteristics of Television Systems; Introduction and Part 1 – Characteristics of Vision and Visual Systems*, RCA Review, March 1948).
14. Intermediate sensitivity operation.
15. Highlight level operation.
16. For example, a scene brightness of approximately 860 foot-lamberts ( $2950\text{cd/m}^2$ ) with lens aperture f/4 and a transmission of 75% produces 10 foot-candles (108 lux) illumination on the faceplate.
17. The signal output current is the highlight signal electrode current during one frame after the dark current component has been subtracted. Signal currents higher than  $0.3\mu\text{A}$  may be used depending on requirements.
18. The signal electrode voltage for each tube is adjusted to that value which gives the desired operating signal current; the indicated range of signal electrode voltage for each operational condition is given to illustrate the variation normally encountered.
19. The deflecting circuits must provide linear scanning for good black level reproduction under these conditions. Dark current is proportional to the scanning velocity. Any change in scanning velocity produces a black level error in direct proportion to the change in velocity of scanning.

# TYPICAL SPECTRAL SENSITIVITY CHARACTERISTIC

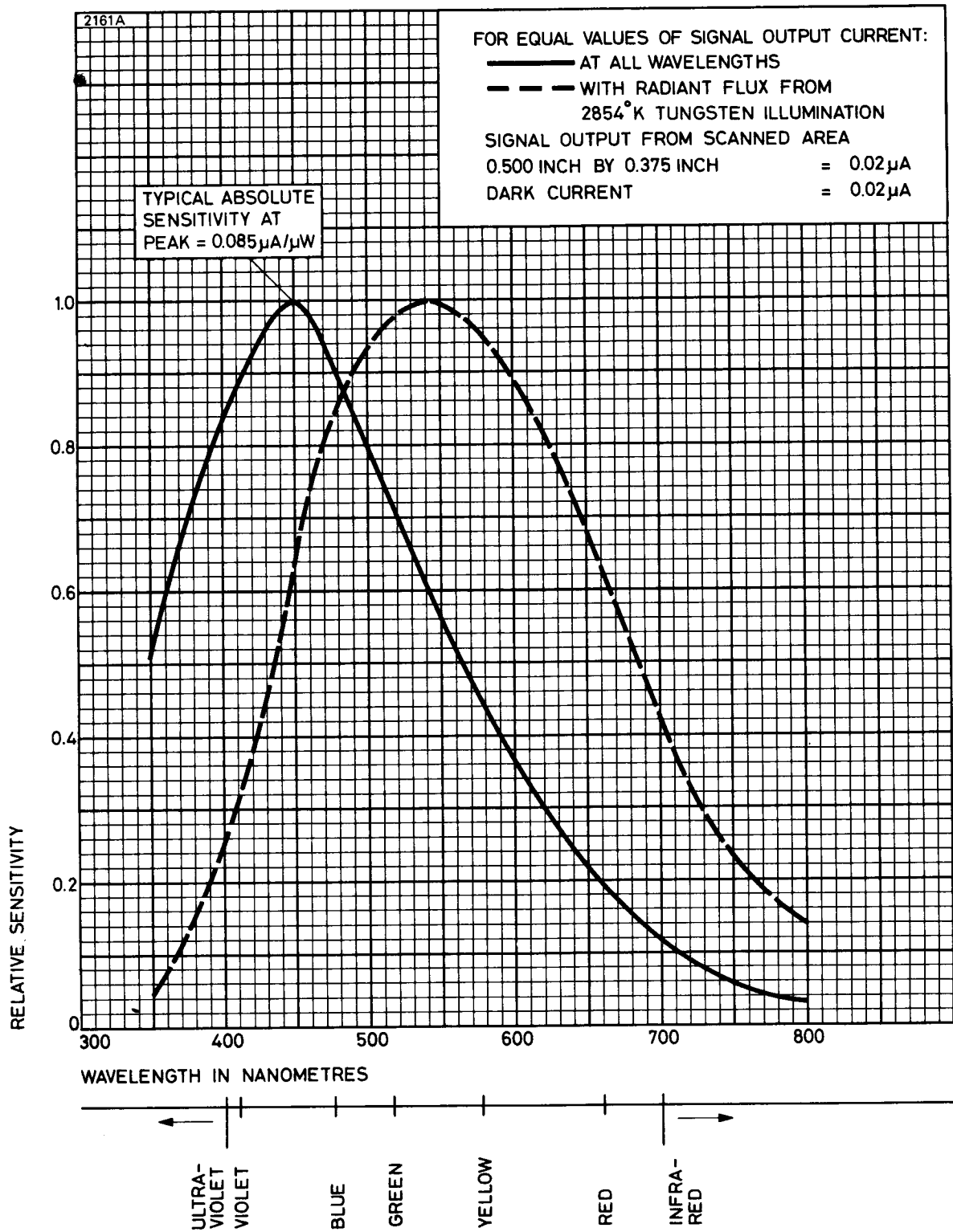

# TYPICAL RESOLUTION

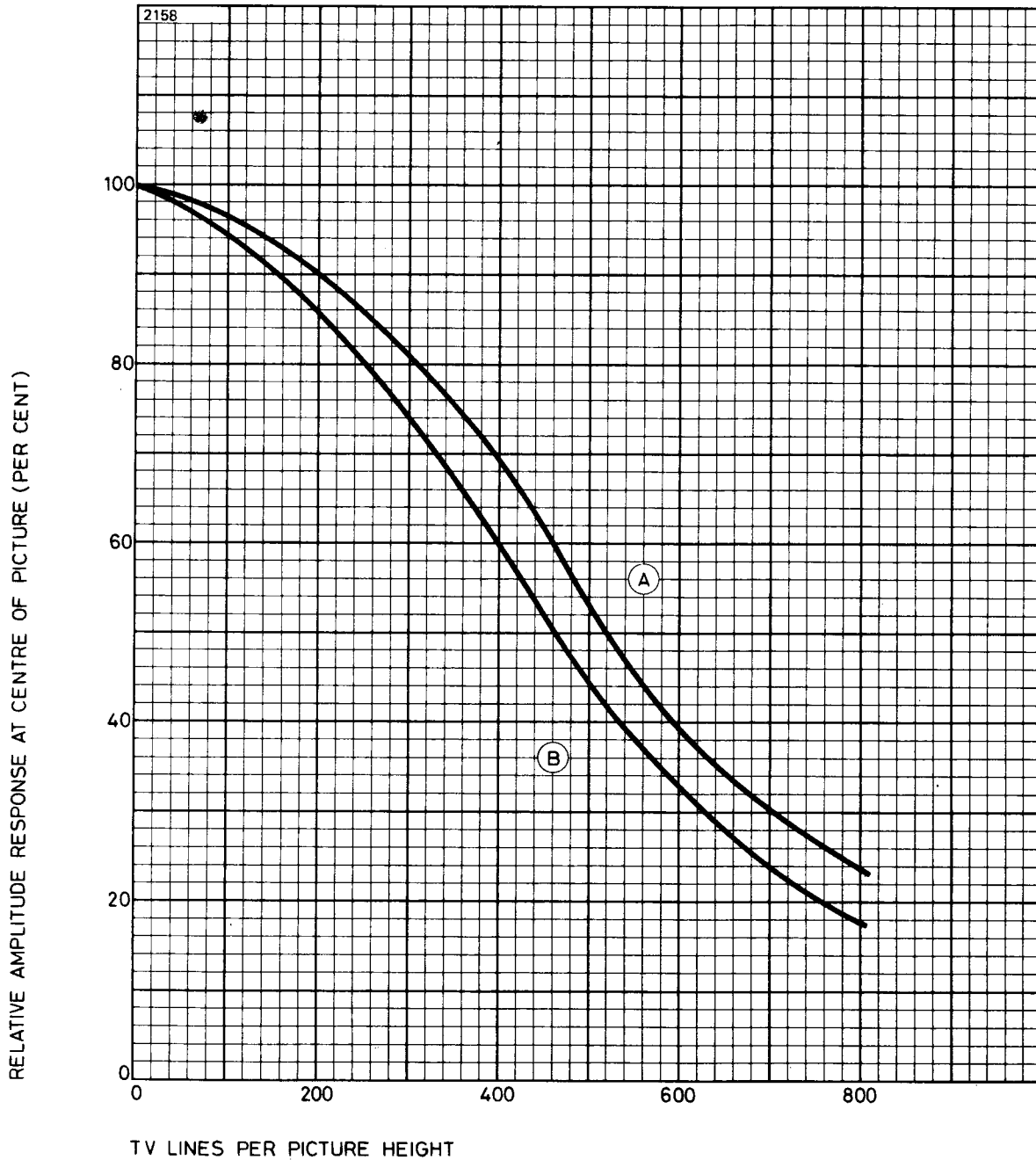

	<b>Curve A</b>	<b>Curve B</b>	
Grid 4 voltage . . . . .	750	500	V
Grid 3 voltage . . . . .	450	300	V
Focus field . . . . .	5.2	4.1	mT
	52	41	gauss
Highlight signal output current . . . . .	0.35	0.35	$\mu$ A
Dark current . . . . .	0.02	0.02	$\mu$ A
Test pattern . . . . .	square wave resolution wedge transparency		

Measured on a camera incorporating Cleveland Electronics deflection yoke VY-111-3, focusing coil VF-115-12 and alignment coil VA-118, the channel having a flat response and adequate bandwidth.

# TYPICAL LIGHT TRANSFER CHARACTERISTICS

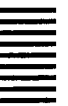
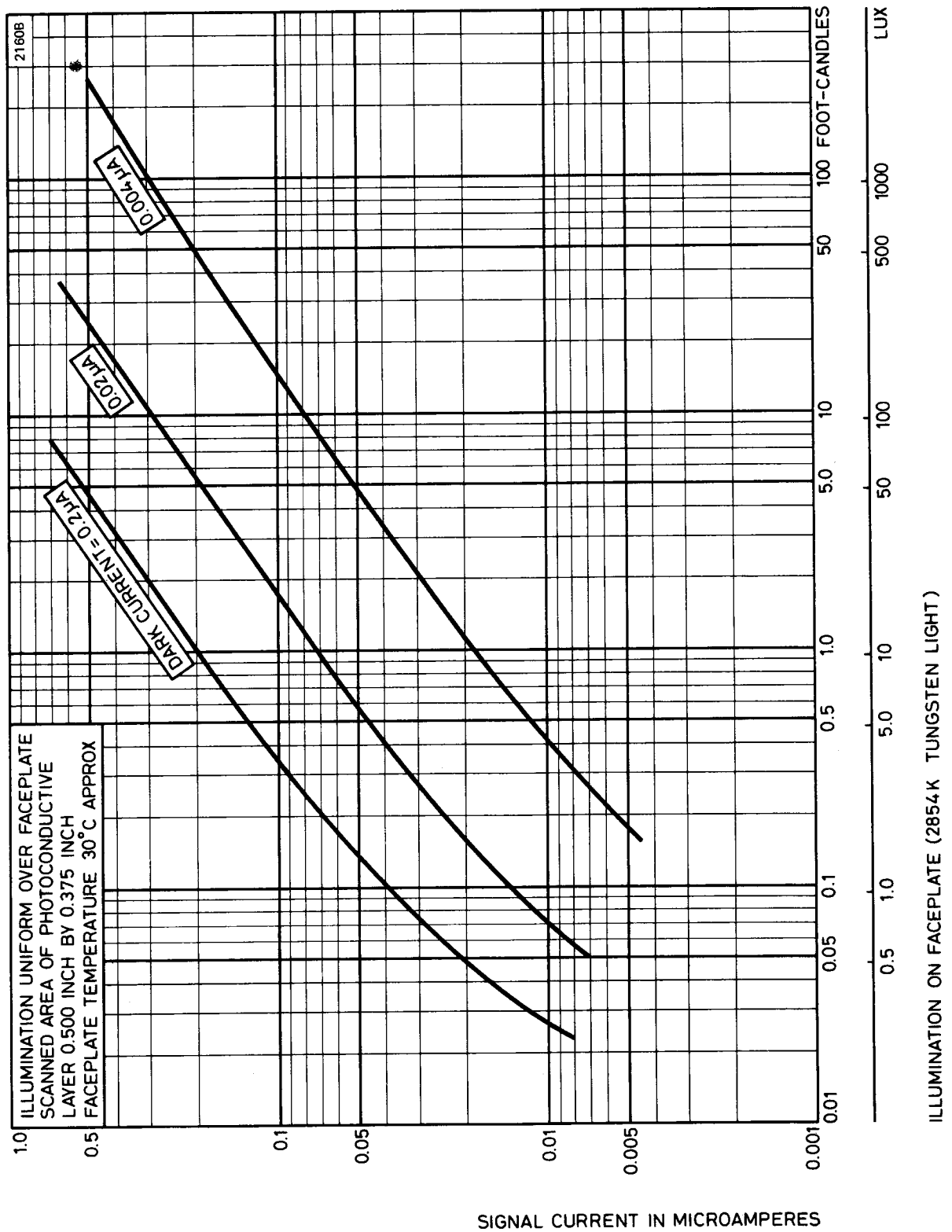

# TYPICAL RANGE OF DARK CURRENT

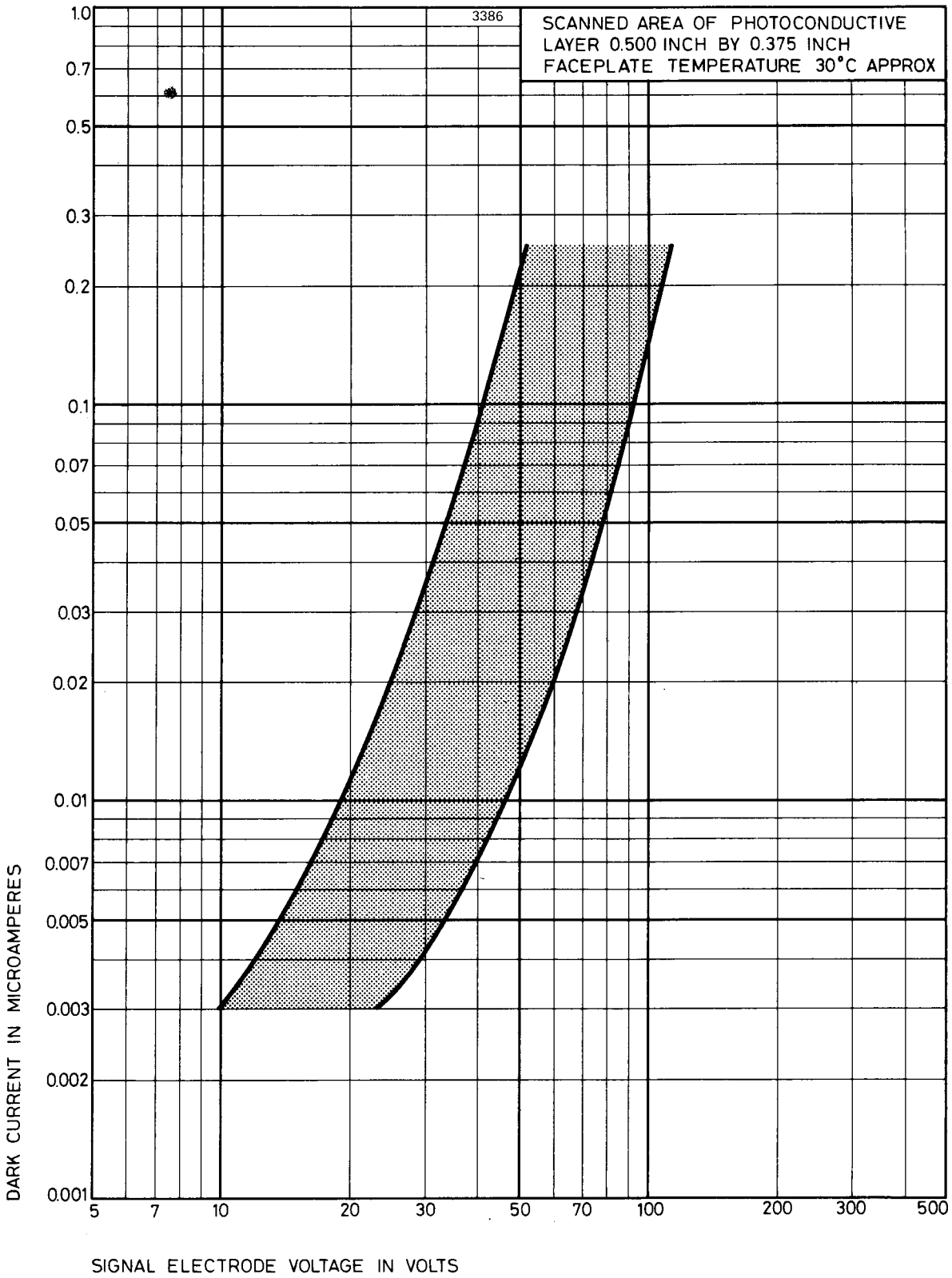



# TYPICAL LAG CHARACTERISTIC

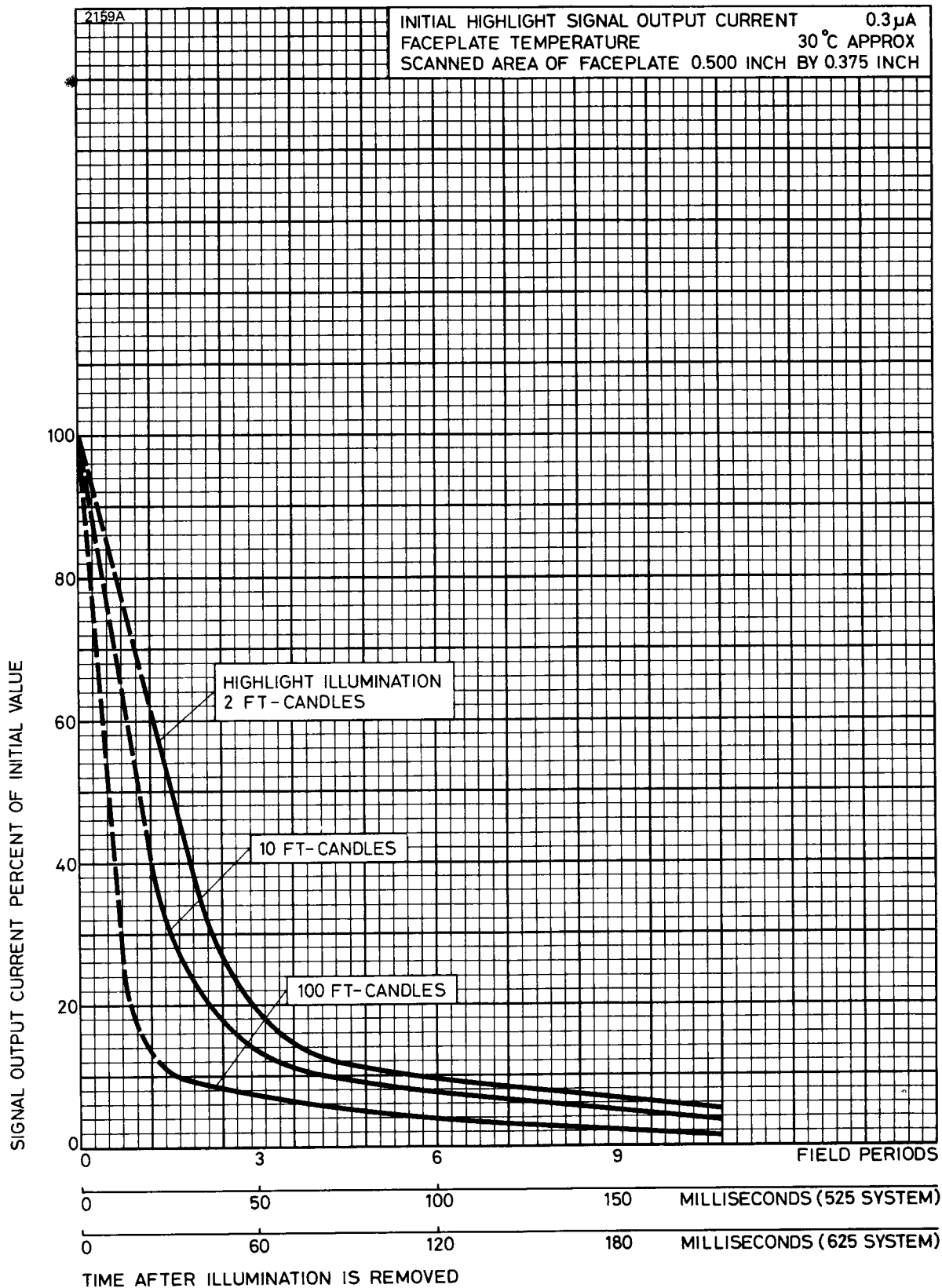

**OUTLINE (All dimensions without limits are nominal)**

2157A

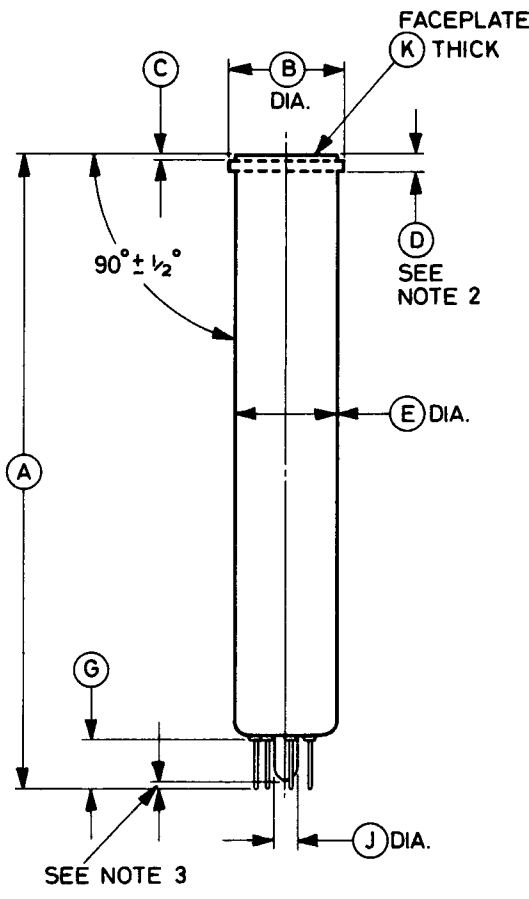
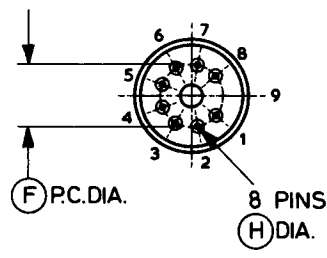
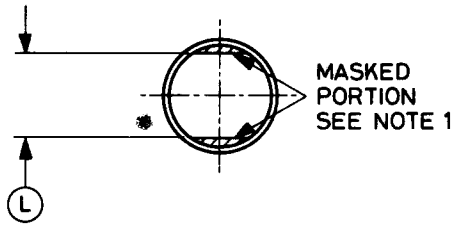

Pin	Element
1	Heater
2	Grid 1
3	Grid 4 (mesh)
4	Internal connection
5	Grid 2
6	Grid 3 (beam focus)
7	Cathode
8	Heater
9	Key pin position, blank
Flange	Signal electrode

**NOTES**

1. The straight sides are parallel to the plane passing through the tube axis and pin position 9.
2. Signal electrode contact flange may be located along the tube axis in any part of or all of the space between the dashed lines.
3. The seal-off will not project beyond the pins.

Ref	Inches	Millimetres
A	6.250 ± 0.125	158.8 ± 3.2
B	1.125 ± 0.010	28.58 ± 0.25
C	0.050 max	1.27 max
D	0.175	4.45
E	1.020 + 0.030 - 0.035	25.91 + 0.76 - 0.89
F	0.600	15.24

Ref	Inches	Millimetres
G	0.503 max	12.78 max
H	0.050 + 0.002 - 0.004	1.270 + 0.051 - 0.102
J	0.265 max	6.73 max
K	0.093 ± 0.005	2.36 ± 0.13
L	0.835 ± 0.035	21.21 ± 0.89

Millimetre dimensions have been derived from inches.

## Outline of tube with optional faceplate stud

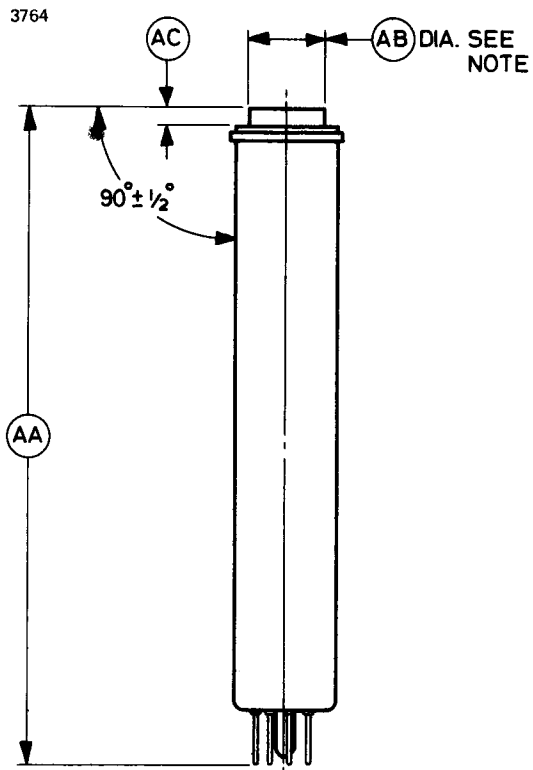

Ref	Inches	Millimetres
AA	6.443 ± 0.125	163.7 ± 3.2
AB	0.757 max	19.23 max
AC	0.195 max	4.95 max

Millimetre dimensions have been derived from inches.

**Note** Concentric tolerance 0.010 inch (0.25mm) diameter, datum signal electrode diameter B.





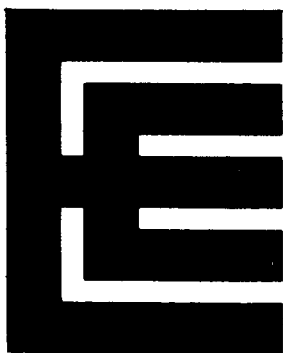

**8625**  
(P846)

**8626**  
(P847)

**VIDICONS**

**INTRODUCTION**

The 8625 and 8626 are 1-inch diameter vidicons employing magnetic focus and deflection. They are intended particularly for broadcast studio and high quality closed circuit television applications.

The spectral sensitivity characteristic of the 8625 and 8626 is such that a substantially correct panchromatic response with tungsten illumination may be obtained. This, together with the high sensitivity and even response of the photo-conductive layer, makes the tubes very suitable for colour cameras, particularly in the blue channel where significant improvements in shading and signal to noise ratio can be achieved. Other operational advantages for colour or monochrome studio applications are the reductions in lag and long term sticking compared with other types of vidicon. The 8625 and 8626 are also very useful for daylight applications.

The tubes feature a separate mesh electrode which, when operated in conjunction with grid 3 at high voltages, enables limiting resolutions in excess of 1000 TV lines to be obtained in the centre of the picture. Optimum resolution may be achieved when grid 3 voltage is 0.6 to 0.7 of the mesh voltage, and under these conditions a depth of modulation in the region of 70% may be obtained at 400 TV lines.

A 4 watt (6.3V, 0.6A) heater is used in the 8625 making it suitable for use in equipment designed for series heater operation or having poor heater voltage regulation.

The 8626 is identical with 8625 apart from its heater ratings of 6.3V, 95mA, which make it suitable for use in small compact transistorized cameras.



**GENERAL DATA**

**Electrical**

Cathode . . . . .	indirectly heated, oxide coated	
Heater voltage . . . . .	6.3	V
Heater current:		
8625 . . . . .	600	mA
8626 . . . . .	95	mA

**Continued on page 2**

**Electrical (continued)**

Inter-electrode capacitance, signal electrode to all other electrodes (average value) (see note 1)	. . . . .	4.6	pF
Spectral response	. . . . .	see spectral sensitivity curve	
Focusing method	. . . . .	magnetic	
Deflection method	. . . . .	magnetic	
Magnetic fields:			
focusing field, at centre of focusing device (see note 2)	. . . . .	37 to 56	gauss
alignment field, adjustable	. . . . .	0 to 4	gauss

**Mechanical**

Overall length	. . . . .	6.375 inches (162mm) max	
Overall diameter	. . . . .	1.135 inches (28.9mm) max	
Useful size of rectangular image;			
diagonal, centrally situated	. . . . .	0.63 inches (15.9mm) max	
Orientation	. . . . .	The horizontal scan should be parallel to the plane passing through the tube axis and the blank key-pin position. The masking is for orientation only and does not define the proper scanned area.	
Net weight	. . . . .	2 ounces (60g) approx	
Mounting position (see note 3)	. . . . .	any	
Base	. . . . .	small button ditetrar 8-pin (JEDEC no. E8-11)	
Mating socket	. . . . .	Type R41-79502 by United Carr Fasteners Ltd. (or equivalent)	

**Storage**

Recommended store temperature	. . . . .	15 to 35	°C
Tubes should be stored in darkness.			

**WARNING**

When operating a tube the following precautions should be observed:

1. Ensure that the temperature of the tube is within its recommended range.
2. Avoid excessive exposure to high levels of illumination otherwise permanent damage to the photoconductive surface may result.
3. With the 8626, a surge limiting device must be incorporated if necessary to ensure that the heater current does not exceed 150mA when switching on or at any other time.

**MAXIMUM AND MINIMUM RATINGS (Absolute values)**

No individual rating to be exceeded.

	<b>Min</b>	<b>Max</b>	
Heater voltage . . . . .	5.7	6.9	V
Signal electrode voltage . . . . .	—	100	V
Grid 4 (mesh) voltage (see note 4) . . . . .	—	1000	V
Grid 3 (beam focus) voltage (see note 4) . . . . .	—	1000	V
Grid 2 (accelerator) voltage . . . . .	—	750	V
Grid 1 voltage:			
negative bias value . . . . .	—	300	V
positive bias value . . . . .	—	0	V
Blanking voltage, peak to peak (see note 5):			
when applied to grid 1 (negative pulses) . . . . .	40	—	V
when applied to cathode (positive pulses) . . . . .	20	—	V
Peak heater to cathode voltage:			
heater negative with respect to cathode . . . . .	—	125	V
heater positive with respect to cathode . . . . .	—	10	V
Dark current . . . . .	—	0.25	$\mu$ A
Peak signal electrode current (see note 6) . . . . .	—	0.55	$\mu$ A
Faceplate temperature . . . . .	—	71	$^{\circ}$ C
Peak illumination of faceplate . . . . .	—	1000	ft-candles
	—	10 760	lux

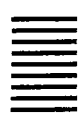

## TYPICAL OPERATION

### Operating Conditions (for scanned area of 0.5 x 0.375 inch)

The following values and notes are for general guidance and may vary from tube to tube.

	Low Voltage Operation	High Voltage Operation	
Grid 4 (mesh) voltage (see note 4) . . . . .	500	750	V
Grid 3 (beam focus) voltage (approx) (see notes 4 and 7) . . . . .	300	450	V
Grid 2 (accelerator) voltage . . . . .	300	300	V
Grid 1 voltage for picture cut-off (with no blanking voltage on grid 1) . . . . .	-45 to -100	-45 to -100	V
Blanking voltage, peak to peak:			
when applied to grid 1 (negative pulses) . . . . .	75	75	V
when applied to cathode (positive pulses) . . . . .	20	20	V
Field strength at centre of focusing coil (see notes 2, 7 and 8) . . . . .	41 ± 4	52 ± 4	gauss
Peak deflection coil currents (approx) (see note 8):			
horizontal . . . . .	200	240	mA
vertical . . . . .	25	30	mA
Alignment field, adjustable (see notes 9 and 10) . . . . .	0 to 4	0 to 4	gauss
Faceplate temperature (see note 11) . . . . .	30 to 35	30 to 35	°C

### Typical Performance

Limiting resolution at centre of picture (approx) . . . . .	900	1000 TV lines	
Amplitude response to a 400 TV line square wave test pattern at centre of picture (approx) . . . . .	60	70	%
Lag (see note 12) . . . . .	18		% max
'Gamma' of transfer characteristic for signal output between 0.02 and 0.2µA . . . . .	0.6		
Visual equivalent signal to noise ratio (see note 13) . . . . .	300:1		approx

Continued on page 5



## Typical Performance (continued)

	Condition			
	1*	2†	3‡	
Faceplate illumination (highlights) (see note 17)	0.5	1.0	6.0	ft-candles
Signal output current (peak) (see note 18):				
typical	0.29	0.25	0.30	$\mu\text{A}$
minimum	—	0.18	—	$\mu\text{A}$
Approximate range of signal electrode voltage (see note 19)	34–72	22–50	10–40	V
Dark current (see note 20)	0.1	0.02	$\leq 0.01$	$\mu\text{A}$

\* See note 14

† See note 15

‡ See note 16

## SEQUENCE OF CAMERA ADJUSTMENTS

### (For Typical Operating Conditions as shown on page 4)

- (a) Set the grid 1 voltage for the maximum negative bias for picture cut-off and apply the other voltages given under Typical Operating Conditions.
- (b) Check that the deflection circuits are functioning properly and adjust the scanning amplitude controls so that a maximum area of the photoconductive layer will be scanned.
- (c) Set the signal electrode voltage to give the signal current specified for the particular condition of operation. The table above gives an indication of the ranges of signal electrode voltage required for three conditions of operation. For other conditions of operation, reference should be made to the light transfer characteristic and the graph showing the range of signal electrode voltage to produce a given dark current and therefore a given sensitivity. It is preferable, if possible, to adjust the dark current to the specified value for the particular condition of operation; 8625 and 8626 tubes will have substantially identical performances when operated with identical values of dark current.

The magnitude of non-uniformities of dark current, as well as lag, tend to increase with signal electrode voltage; therefore operation at low values of signal electrode voltage helps to minimise these effects.

- (d) Decrease grid 1 voltage from its maximum negative value until a signal is produced.
- (e) Adjust grid 3 (beam focus) or grid 3 and grid 4 (mesh) voltages, the lens

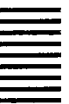

stop and the optical focus alternately to obtain the best focused picture with the peak signal output current specified under Typical Performance.

- (f) Adjust the lens aperture and signal electrode voltage to produce the desired output signal. Lag decreases with increase in illumination on the faceplate.
- (g) Adjust the alignment field so that the centre of the picture does not move as grid 3 (beam focus) and grid 4 (mesh) voltages are rocked slightly. Adjust grid 1 (beam current) voltage to provide sufficient beam to just discharge the highlights. It is permissible to set the alignment fields slightly off the minimum movement position to maintain signal uniformity.
- (h) Adjust the deflection amplitude and position to scan an area 0.500 inch x 0.375 inch. This is facilitated by the use of a perspex mask inscribed with circles 0.500 inch and 0.375 inch diameter, placed in contact and concentric with the faceplate of the tube. Light is allowed to fall on the photoconductive layer and an image of the rings is obtained on the monitor. No lens is necessary. The scan amplitude and centring controls are adjusted until the diameter of the larger circle is equal to the width of the raster and that of the smaller equal to the height.
- (j) Centre the raster in the useful area of the photoconductive layer and check the alignment (step g).
- (k) If the picture is faint, even with adequate video gain, open the lens iris more and, if necessary, increase the signal electrode voltage.
- (l) Repeat steps (e) to (g) until optimum picture reproduction is obtained.

## NOTES

1. This capacitance, which in effect forms the output impedance of the tube, is increased when the tube is mounted in a deflecting yoke and focusing coil assembly. The resistive component of the output impedance is of the order of 100 megohms.
2. The direction of the focusing current should be such that a north pole is attracted to the image end of the focusing coil.
3. When the tube is subjected to vibration the mounting position should not be vertical with the base uppermost.
4. Grid 3 and grid 4 voltages are adjusted for the best focus. The resolution, uniformity of focus and picture quality decrease with decreasing

- grid 3 and grid 4 voltage. In general grid 3 should be operated above 250 volts and be approximately 0.6 of grid 4 voltage.
5. The blanking voltage required when applied to the cathode is less than that required when applied to grid 1 as the former reduces the potential difference between the cathode and the scanned side of the target.
  6. The video amplifier must be designed to handle signal currents of this magnitude, to avoid picture distortion due to overloading of the amplifier.
  7. It may be preferred to adjust beam focus by varying the focus coil current to obtain the field strengths indicated in the Typical Operating Conditions. If the focus coil field strength is fixed, beam focus may be obtained within a  $\pm 10\%$  range (approximately) of the grid 3 and grid 4 voltages. The ratio of 0.6 between grid 3 and grid 4 should be maintained as these voltages are varied.
  8. Use an approved deflection yoke, focusing coil and alignment coil such as Cleveland Electronics VY-111-3 deflection yoke, VF-115-12 focusing coil, and VA-118 alignment coil. For the focusing coil, the distance from the faceplate to the beginning of the winding is 0.75 inch approximately. The alignment coil is located to the rear of the focusing coil directly over the electron gun.
  9. Adjust the current through the alignment coils until the centre of the test pattern does not move as grid 3 and grid 4 voltages or the focus coil current are varied in and out of focus.
  10. The alignment coil should be located so that its centre is 3.69 inches from the faceplate of the tube. Its axis should be coincident with the axis of the tube, the deflecting yoke and the focusing coil.
  11. Unless the temperature of the faceplate is maintained at a constant value within this range, the dark current and performance will drift from the optimum performance established on initial setting up.
  12. Percentage of initial value of signal output current remaining 3 field periods after light is cut off (i.e. 50ms in American standard systems and 60ms in European systems), with a faceplate illumination of 6 foot-candles and an initial highlight signal current of  $0.3\mu\text{A}$ .
  13. Measured with a high gain, low noise, cascode type pre-amplifier having a bandwidth of 5.1MHz and a peak signal output current of  $0.35\mu\text{A}$ . The visual equivalent signal to noise ratio is taken as the ratio of the highlight signal output current to the r.m.s. noise current, multiplied by a factor of 3 (ref. Otto H. Schade, 'Electro-optical Characteristics of



Television Systems; Introduction and Part 1 – Characteristics of Vision and Visual Systems', RCA Review, March 1948).

14. Intermediate sensitivity operation.
15. Average sensitivity operation.
16. Highlight level operation.
17. For example, a scene brightness of approximately 510 ft-lamberts with lens aperture f/4 and a transmission of 75% produces 6 foot-candles illumination on the faceplate.
18. The signal output current is the highlight signal electrode current during one frame after the dark current component has been subtracted. Signal currents higher than  $0.3\mu\text{A}$  may be used depending on requirements.
19. The signal electrode voltage for each tube is adjusted to that value which gives the desired operating signal current; the indicated range of signal electrode voltage for each operational condition is given to illustrate the variation normally encountered.
20. The deflecting circuits must provide extremely linear scanning for good black level reproduction under these conditions. Dark current is proportional to the scanning velocity. Any change in scanning velocity produces a black level error in direct proportion to the change in velocity of scanning.

# TYPICAL SPECTRAL SENSITIVITY CHARACTERISTIC

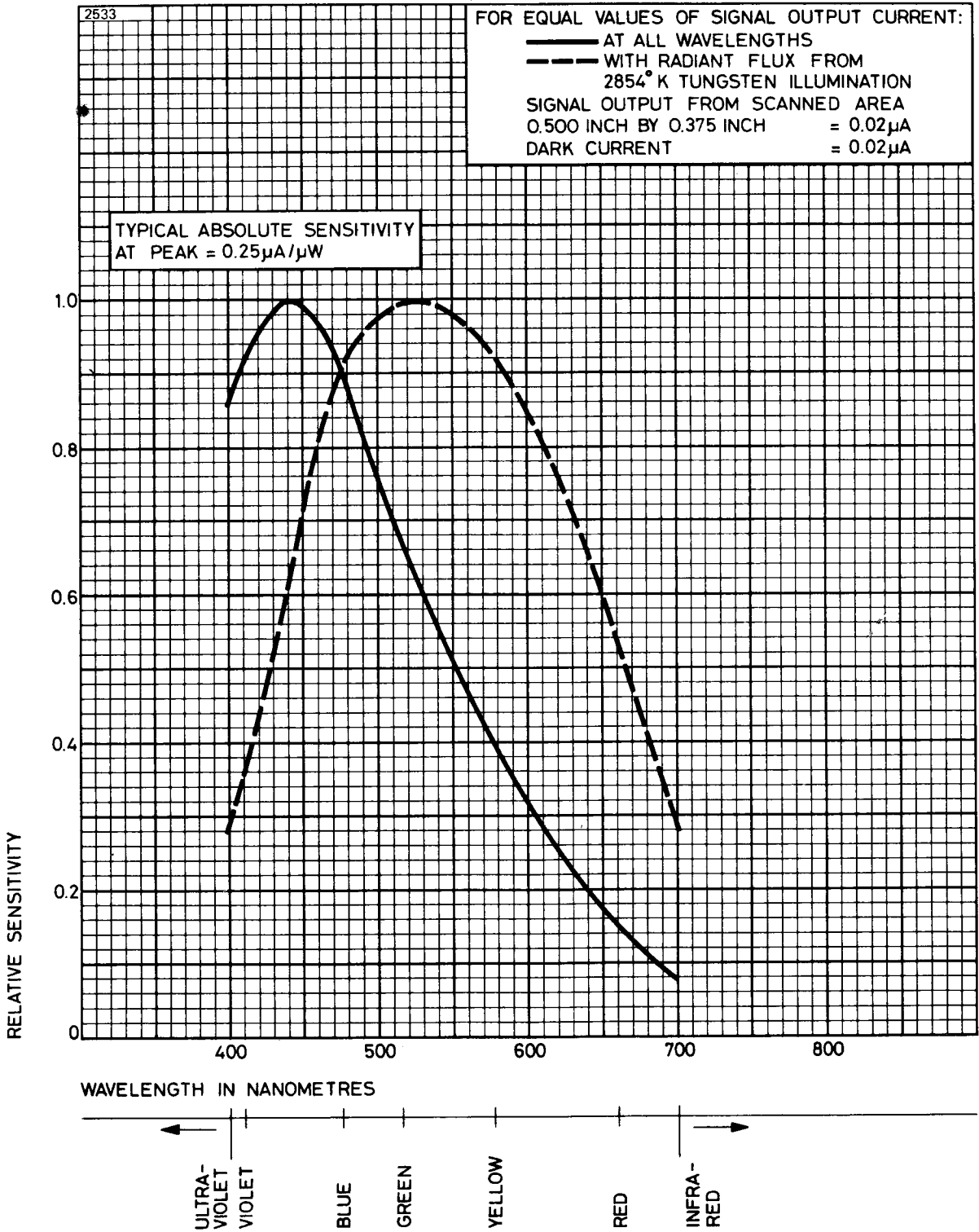

# TYPICAL RESOLUTION

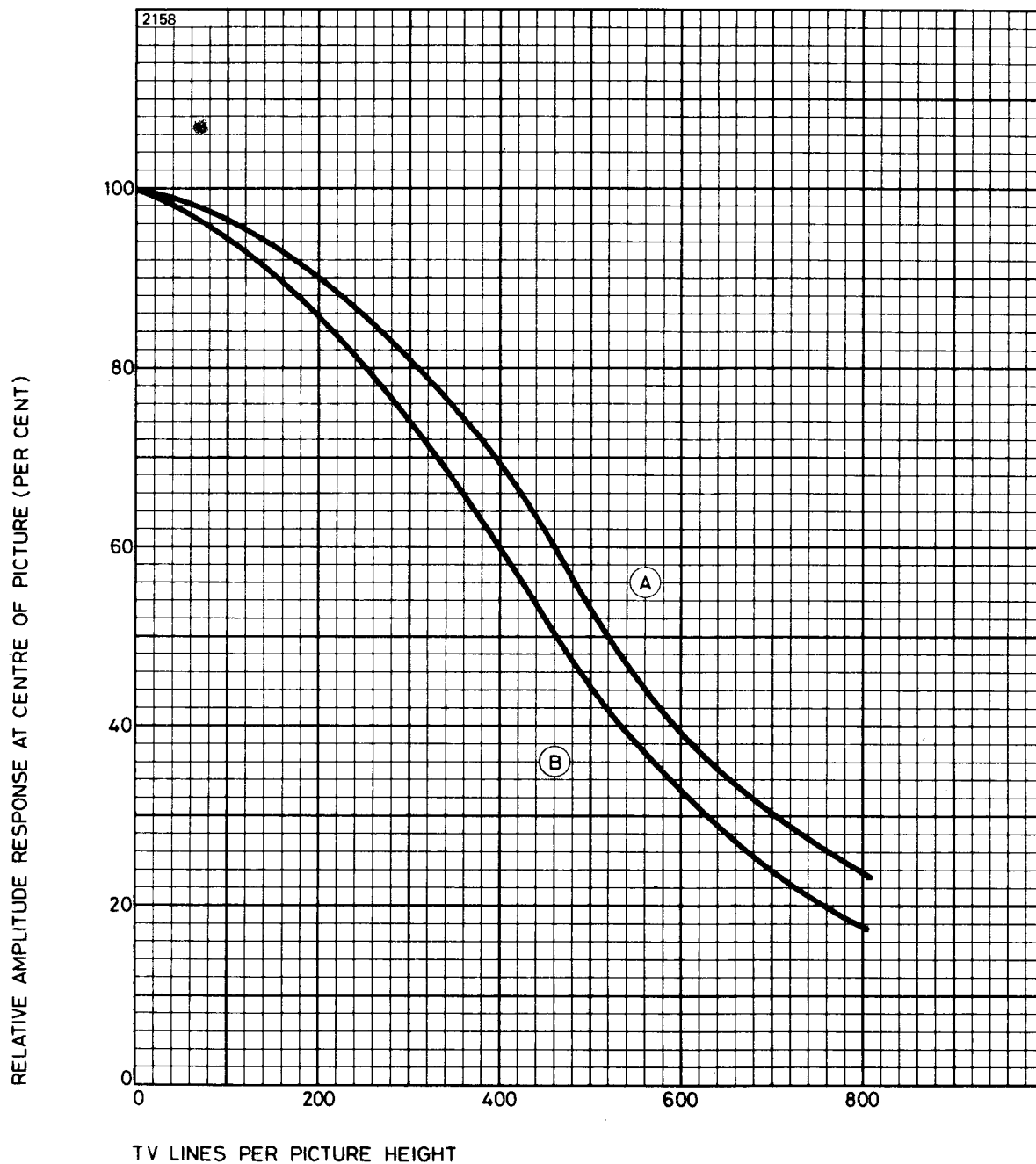

	<b>Curve A</b>	<b>Curve B</b>	
Grid 4 voltage . . . . .	750	500	V
Grid 3 voltage . . . . .	450	300	V
Focus field . . . . .	52	41	gauss
Test pattern . . . . .	square wave resolution wedge transparency		

Measured on a camera incorporating Cleveland Electronics deflection yoke VY-111-3, focusing coil VF-115-12 and alignment coil VA-118, the channel having a flat response and adequate bandwidth.

# TYPICAL LIGHT TRANSFER CHARACTERISTICS

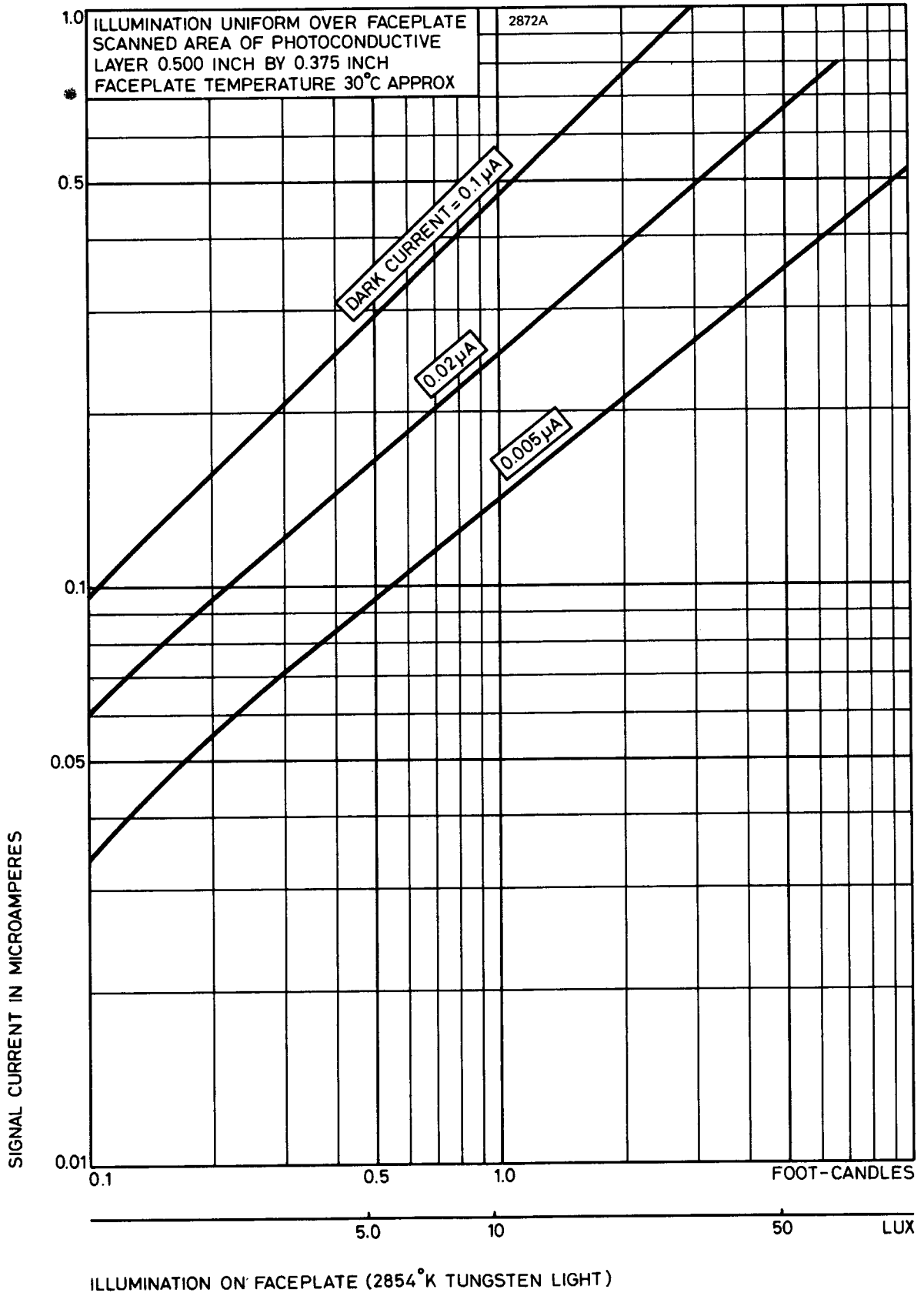

# TYPICAL RANGE OF SIGNAL CURRENT

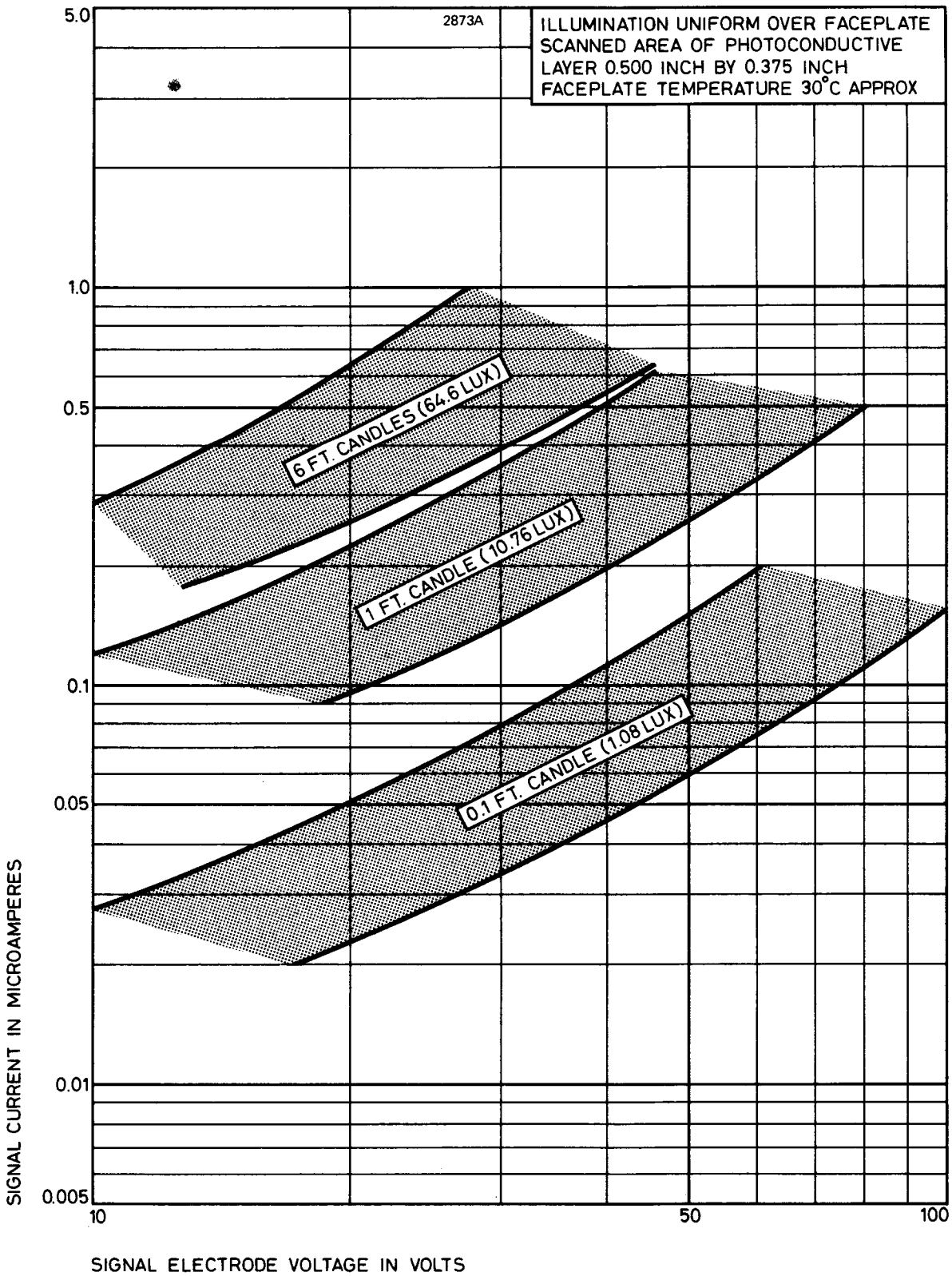



# TYPICAL RANGE OF DARK CURRENT

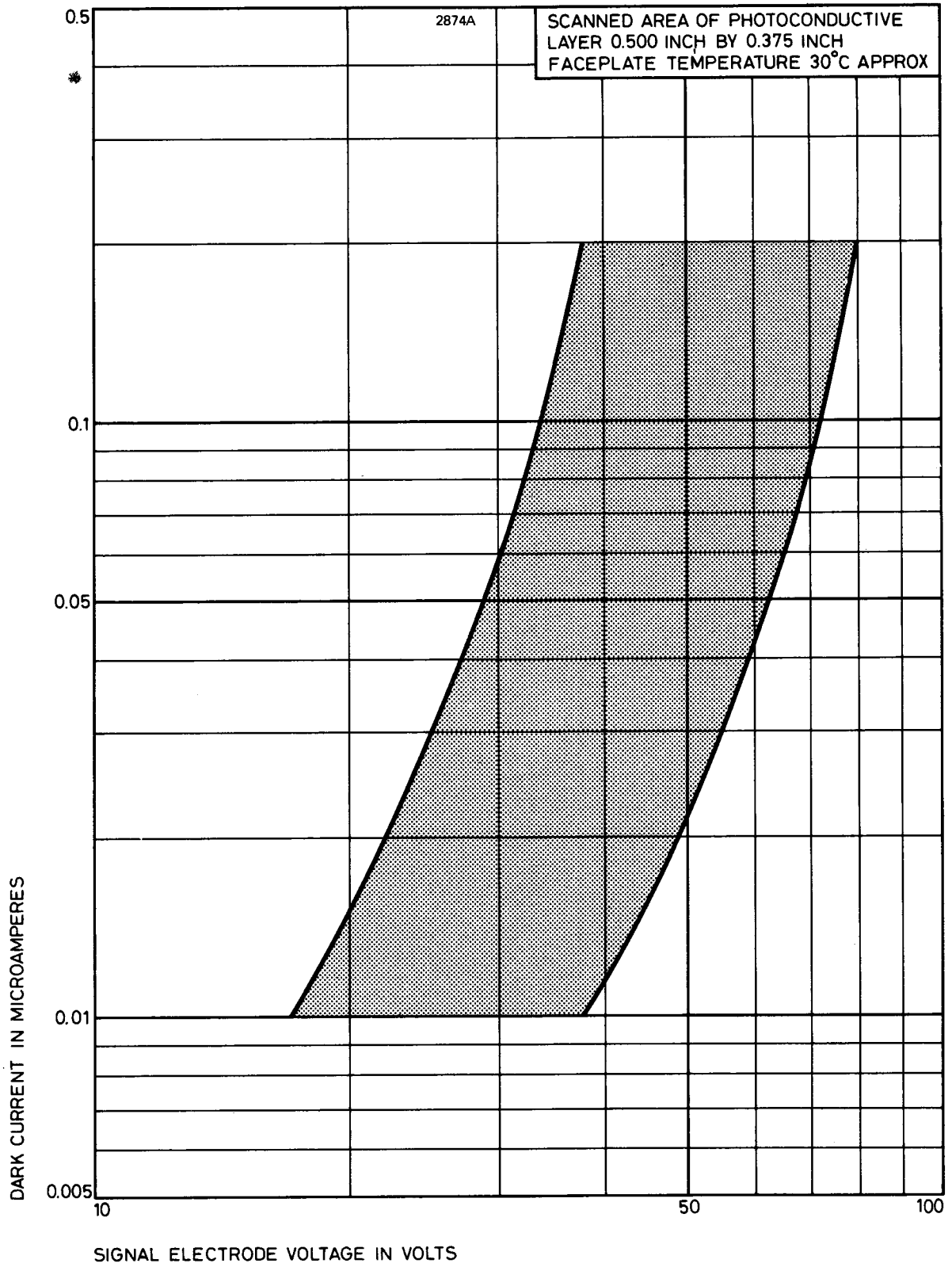

# TYPICAL LAG CHARACTERISTIC

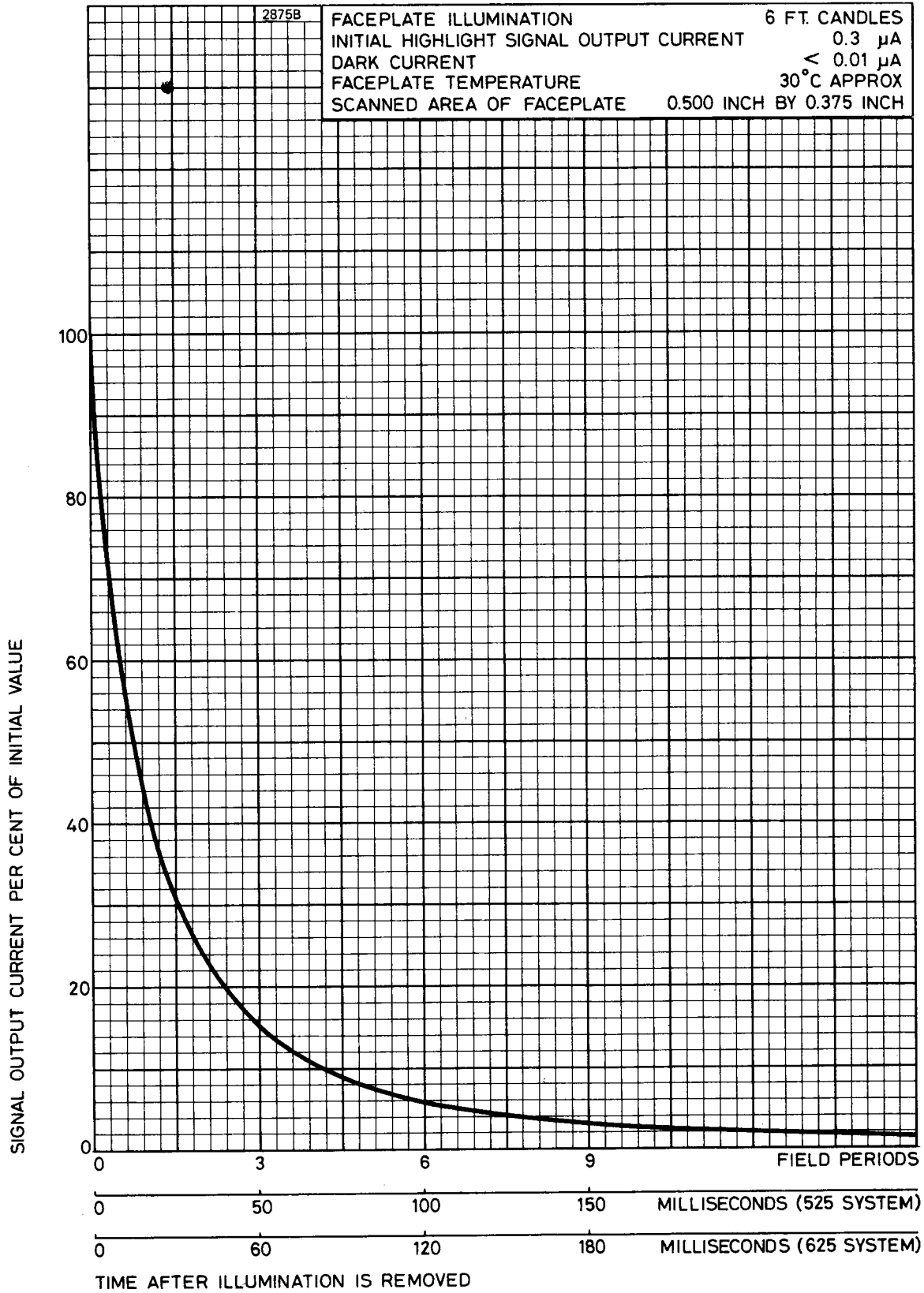

# OUTLINE

2157A

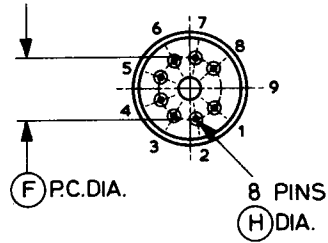
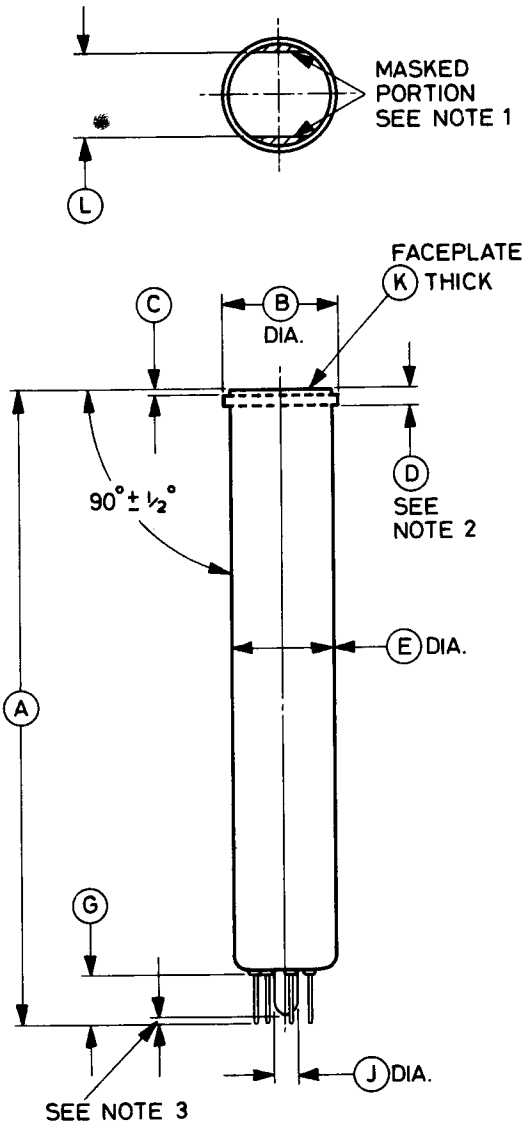

Pin	Element
1	Heater
2	Grid 1
3	Grid 4
4	Internal connection
5	Grid 2
6	Grid 3
7	Cathode
8	Heater
9	Key pin position, blank
Flange	Signal electrode

## NOTES

1. The straight sides are parallel to the plane passing through the tube axis and pin position 9.
2. Signal electrode contact flange may be located along the tube axis in any part of or all of the space between the dashed lines.
3. The seal-off will not project beyond the pins.

Ref	Inches	Millimetres	Ref	Inches	Millimetres
A	6.250 ± 0.125	158.8 ± 3.2	G	0.503 max	12.78 max
B	1.125 ± 0.010	28.58 ± 0.25	H	0.050 <sup>+0.002</sup> <sub>-0.004</sub>	1.270 <sup>+0.051</sup> <sub>-0.102</sub>
C	0.050 max	1.27 max	J	0.265 max	6.73 max
D	0.175	4.45	K	0.093 ± 0.005	2.36 ± 0.13
E	1.020 <sup>+0.030</sup> <sub>-0.035</sub>	25.91 <sup>+0.76</sup> <sub>-0.89</sub>	L	0.835 ± 0.035	21.21 ± 0.89
F	0.600	15.24			

Millimetre dimensions have been derived from inches.





**This information should be read in conjunction with the 7735B data sheet.**

The P826/4478 is of identical construction to type 7735B but is tested to the following specification.

### Typical Performance

Illumination on faceplate (2854K tungsten light)	. . . . .	1.0	ft-candle
Dark current	. . . . .	0.02	$\mu$ A
Signal output current	. . . . .	0.12	$\mu$ A min
Grid 1 voltage for picture cut-off	. . . . .	-45 to -110	V
Signal electrode voltage range	. . . . .	10 to 70	V
Limiting resolution at centre of picture	. . . . .	650	TV lines
Lag at $1/20$ s	. . . . .	30	% max

### Picture Defects (measured under the above operating conditions)

The limitations on the size and number of spots will be according to the following table.

Spot size as equivalent number of raster lines in a 625 line system	Zone 1*	Zone 2†
over 6	0	0
6 to but not including 4	0	2
4 to but not including 1	3	4



Spots below 1 line are not counted unless their concentration causes a smudged appearance. Spots having a contrast ratio less than 1.5:1 for white spots and 2:1 for black spots are not counted.

The minimum separation between spots greater than 1 line is 16 lines.

\* Zone 1 is a circle centred on the raster and with a diameter equal to the raster height.

† Zone 2 is the area outside Zone 1.

**OUTLINE (All dimensions without limits are nominal)**

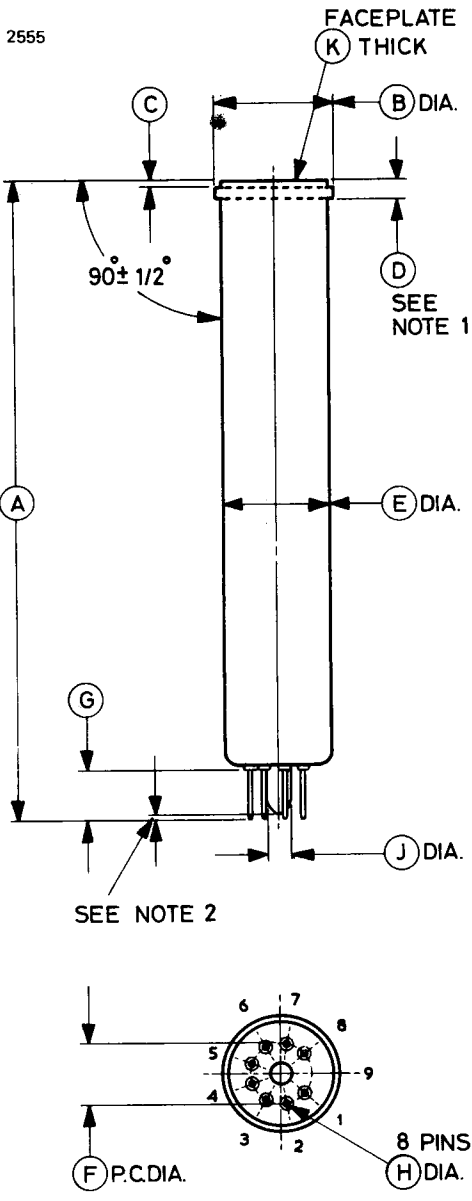

**Connections**

Pin	Element
1	Heater
2	Grid 1
3	Internal connection
4	Internal connection
5	Grid 2
6	Grid 3
7	Cathode
8	Heater
9	Key pin position, blank
Flange	Signal electrode

**Notes**

1. Signal electrode contact flange may be located along the tube axis in any part of or all of the space between the dashed lines.
2. The seal-off will not project beyond the pins.

Ref	Inches	Millimetres	Ref	Inches	Millimetres
A	6.250 ± 0.125	158.8 ± 3.2	F	0.600	15.24
B	1.125 ± 0.010	28.58 ± 0.25	G	0.503 max	12.78 max
C	0.050 max	1.27 max	H	0.050 <sup>+0.002</sup> <sub>-0.004</sub>	1.270 <sup>+0.051</sup> <sub>-0.102</sub>
D	0.175	4.45	J	0.265 max	6.73 max
E	1.020 <sup>+0.030</sup> <sub>-0.035</sub>	25.91 <sup>+0.76</sup> <sub>-0.89</sub>	K	0.093 ± 0.005	2.36 ± 0.13

Millimetre dimensions have been derived from inches.



### INTRODUCTION

The P831 is a short, rugged 1-inch vidicon of separate mesh construction with magnetic deflection and focusing, designed for special applications involving severe shock and vibration. This very sensitive vidicon features a separate mesh electrode and a very uniform target layer, resulting in good signal uniformity over a wide range of signal electrode voltages.

Because of its short length and low power (0.6 watt) heater, the P831 may be used in small compact transistorized television cameras.

When operated with high voltages on grid 3 and the mesh, higher and more uniform resolution and improved signal uniformity are obtained over a wide range of signal electrode voltage than may be obtained using standard vidicons. Limiting resolutions in the region of 1000 TV lines may be obtained in the centre of the picture when the tube is operated under these conditions, optimum resolution being achieved when the grid 3 voltage is 0.6 to 0.7 of the mesh voltage.

The high sensitivity and low lag properties of the P831 photoconductive surface allow it to be used under lighting conditions encountered in special industrial and military applications. The uniformity of the layer enables uniform dark current and improved uniformity of sensitivity over the scanned area to be obtained provided that suitable associated deflecting and focusing components are used.

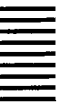

### GENERAL DATA

#### Electrical

Cathode . . . . .	indirectly heated, oxide coated
Heater voltage . . . . .	6.3 V
Heater current . . . . .	95 mA
Inter-electrode capacitance, signal electrode to all other electrodes (average value) (see note 1)	4.6 pF
Spectral response . . . . .	see spectral sensitivity curve
Focusing method . . . . .	magnetic
Deflection method . . . . .	magnetic
Magnetic fields:	
focusing field, at centre of focusing device (see note 2)	3.7 to 5.6mT (37 to 56 gauss)
alignment field, adjustable	0 to 0.4mT (0 to 4 gauss)

**Mechanical**

Overall length . . . . .	5.180 inches (131.6mm) max
Overall diameter . . . . .	1.135 inches (28.9mm) max
Useful size of rectangular image; diagonal, centrally situated . . . . .	0.63 inches (15.9mm) max
Orientation . . . . .	The horizontal scan should be parallel to the plane passing through the tube axis and the blank key-pin position. The masking is for orientation only and does not define the proper scanned area.
Net weight . . . . .	2 ounces (60g) approx
Mounting position (see note 3) . . . . .	any
Base . . . . .	small button ditetrar 8-pin (JEDEC no. E8-11)
Mating socket . . . . .	Type R41-79502 by United Carr Fasteners Ltd. (or equivalent)

**Storage**

Recommended store temperature . . . . . 15 to 35 °C  
 Tubes should be stored in darkness.

**WARNING**

When operating a tube the following precautions should be observed:

1. Ensure that the temperature of the tube is within its recommended range.
2. Avoid over exposure of stationary pictures, e.g. test patterns, or after-image may result.
3. A surge limiting device must be incorporated if necessary to ensure that the heater current does not exceed 150mA when switching on or at any other time.

**MAXIMUM AND MINIMUM RATINGS (Absolute values)**

No individual rating to be exceeded.

	<b>Min</b>	<b>Max</b>	
Heater voltage . . . . .	5.7	6.9	V
Signal electrode voltage . . . . .	—	100	V
Grid 4 (mesh) voltage (see note 4) . . . . .	—	1000	V
Grid 3 (beam focus) voltage (see note 4) . . . . .	—	1000	V
Grid 2 (accelerator) voltage . . . . .	—	750	V

**Continued on page 3**



**MAXIMUM AND MINIMUM RATINGS (Absolute values) — continued**

	Min	Max	
Grid 1 voltage:			
negative bias value . . . . .	—	300	V
positive bias value . . . . .	—	0	V
Blanking voltage, peak to peak (see note 5):			
when applied to grid 1 (negative pulses) .	40	—	V
when applied to cathode (positive pulses) .	20	—	V
Peak heater to cathode voltage:			
heater negative with respect to cathode .	—	125	V
heater positive with respect to cathode .	—	10	V
Dark current . . . . .	—	0.25	$\mu$ A
Peak signal electrode current (see note 6) .	—	0.55	$\mu$ A
Faceplate temperature . . . . .	—	71	$^{\circ}$ C
Peak illumination of faceplate . . . . .	—	1000	ft-candles
	—	10 760	lux

**TYPICAL OPERATION**

**Operating Conditions** (for scanned area of 0.5 x 0.375 inch)

The following values and notes are for general guidance and may vary from tube to tube.

	Low Voltage Operation	High Voltage Operation	
Grid 4 (mesh) voltage (see note 4) . . . . .	500	750	V
Grid 3 (beam focus) voltage (approx) (see notes 4 and 7) . . . . .	300	450	V
Grid 2 (accelerator) voltage . . . . .	300	300	V
Grid 1 voltage for picture cut-off (with no blanking voltage on grid 1) —45 to —100	—45 to —100	—45 to —100	V
Blanking voltage, peak to peak:			
when applied to grid 1 (negative pulses) . . . . .	75	75	V
when applied to cathode (positive pulses) . . . . .	20	20	V
Field strength at centre of focusing coil (see notes 2, 7 and 8) . . . . .	$41 \pm 4$	$52 \pm 4$	gauss
Alignment field, adjustable (see notes 9 and 10) . . . . .	0 to 4	0 to 4	gauss
Faceplate temperature (see note 11) . . . . .	30 to 35	30 to 35	$^{\circ}$ C



## Typical Performance

	Low Voltage	High Voltage
Limiting resolution at centre of picture (approx) . . . . .	900	1000 TV lines
Amplitude response to a 400 TV line square wave test pattern at centre of picture (approx) . . . . .	60	70 %
Lag (see note 12) . . . . .	18	% max
'Gamma' of transfer characteristic for signal output between 0.02 and 0.2 $\mu$ A . . . . .	0.5 to 0.6	
Visual equivalent signal to noise ratio (see note 13) . . . . .	300:1	approx

### Condition

	1*	2†	3‡	4⊕	
Faceplate illumination (highlights) (see note 18) . . . . .	0.1	0.5	1.0	5.0	ft-candles
Signal output current (peak) (see note 19):					
typical . . . . .	0.14	0.27	0.20	0.25	$\mu$ A
minimum . . . . .	—	—	0.15	—	$\mu$ A
Approximate range of signal electrode voltage (see note 20)	35–70	30–60	20–40	10–40	V
Dark current (see note 21) . . . . .	0.2	0.1	0.02	<0.02	$\mu$ A

\* See note 14

† See note 15

‡ See note 16

⊕ See note 17

## SPECIAL PERFORMANCE

Tubes of this type have been successfully submitted to a type approval programme including the following environmental tests.

1. Thermal shock
2. Rapid depressurization
3. Tropical exposure
4. Long term storage at elevated temperature (70°C)
5. Mechanical shock
6. Random noise vibration

It may be possible, from the results of these tests to predict the probable performance of the tube under various environmental conditions.

If it is proposed to use the tubes under conditions of severe vibration etc., the manufacturer will advise as to the performance to be expected.

## SEQUENCE OF CAMERA ADJUSTMENTS

(For Typical Operating Conditions as shown on page 3)

- (a) Set the grid 1 voltage for the maximum negative bias for picture cut-off and apply the other voltages given under Typical Operating Conditions.
- (b) Check that the deflection circuits are functioning properly and adjust the scanning amplitude controls so that a maximum area of the photoconductive layer will be scanned.
- (c) Set the signal electrode voltage to give the signal current specified for the particular condition of operation. The table on page 4 gives an indication of the ranges of signal electrode voltage required for four conditions of operation. For other conditions of operation, reference should be made to the light transfer characteristic and the graph showing the range of signal electrode voltage to produce a given dark current and therefore a given sensitivity. It is preferable, if possible, to adjust the dark current to the specified value for the particular condition of operation; P831 tubes will have substantially identical performances when operated with identical values of dark current.

The magnitude of non-uniformities of dark current, as well as lag, tend to increase with signal electrode voltage; therefore operation at low values of signal electrode voltage helps to minimize these effects.

- (d) Decrease grid 1 voltage from its maximum negative value until a signal is produced.
- (e) Adjust grid 3 (beam focus) or grid 3 and grid 4 (mesh) voltages, the lens stop and the optical focus alternately to obtain the best focused picture with the peak signal output current specified under Typical Performance.
- (f) Adjust the lens aperture and signal electrode voltage to produce the desired output signal. Lag decreases with increase in illumination on the faceplate.
- (g) Adjust the alignment field so that the centre of the picture does not move as grid 3 (beam focus) and grid 4 (mesh) voltages are rocked slightly. Adjust grid 1 (beam current) voltage to provide sufficient beam to just discharge the highlights. It is permissible to set the alignment fields slightly off the minimum movement position to maintain signal uniformity.
- (h) Adjust the deflection amplitude and position to scan an area 0.500 inch x 0.375 inch. This is facilitated by the use of a perspex mask inscribed with circles 0.500 inch and 0.375 inch diameter, placed in contact and

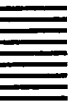

concentric with the faceplate of the tube. Light is allowed to fall on the photoconductive layer and an image of the rings is obtained on the monitor. No lens is necessary. The scan amplitude and centring controls are adjusted until the diameter of the larger circle is equal to the width of the raster and that of the smaller equal to the height.

- (j) Centre the raster in the useful area of the photoconductive layer and check the alignment (step g).
- (k) If the picture is faint, even with adequate video gain, open the lens iris more and, if necessary, increase the signal electrode voltage.
- (l) Repeat steps (e) to (g) until optimum picture reproduction is obtained.

## NOTES

1. This capacitance, which in effect forms the output impedance of the tube, is increased when the tube is mounted in a deflecting yoke and focusing coil assembly. The resistive component of the output impedance is of the order of 100 megohms.
2. The direction of the focusing current should be such that a north pole is attracted to the image end of the focusing coil.
3. When subjected to vibration the tube should not be displaced with respect to the focus, deflection and alignment fields.
4. Grid 3 and grid 4 voltages are adjusted for the best focus. The resolution, uniformity of focus and picture quality decrease with decreasing grid 3 and grid 4 voltage. In general grid 3 should be operated above 250 volts and be approximately 0.6 of grid 4 voltage.
5. The blanking voltage required when applied to the cathode is less than that required when applied to grid 1 as the former reduces the potential difference between the cathode and the scanned side of the target.
6. The video amplifier must be designed to handle signal currents of this magnitude, to avoid picture distortion due to overloading of the amplifier.
7. It may be preferred to adjust beam focus by varying the focus coil current to obtain the field strengths indicated in the Typical Operating Conditions. If the focus coil field strength is fixed, beam focus may be obtained within a  $\pm 10\%$  range (approximately) of the grid 3 and grid 4 voltages. The ratio of 0.6 between grid 3 and grid 4 should be maintained as these voltages are varied.
8. Use a deflection yoke, focusing coil and alignment coil which have been approved for operation under specified conditions of shock and vibration.

9. Adjust the current through the alignment coils until the centre of the test pattern does not move as grid 3 and grid 4 voltages or the focus coil current are varied in and out of focus.
10. The alignment coil should be located so that its centre is 3.69 inches from the faceplate of the tube. Its axis should be coincident with the axis of the tube, the deflecting yoke and the focusing coil.
11. Unless the temperature of the faceplate is maintained at a constant value within this range, the dark current and performance will drift from the optimum performance established on initial setting up.
12. Percentage of initial value of signal output current remaining 3 field periods after light is cut off (i.e. 50ms in American standard systems and 60ms in European systems), with a faceplate illumination of 2 foot-candles and a total signal current of  $0.3\mu\text{A}$ .
13. Measured with a high gain, low noise, cascode type pre-amplifier having a bandwidth of 5.1MHz and a peak signal output current of  $0.35\mu\text{A}$ . The visual equivalent signal to noise ratio is taken as the ratio of the highlight signal output current to the r.m.s. noise current, multiplied by a factor of 3 (ref. Otto H. Schade, 'Electro-optical Characteristics of Television Systems; Introduction and Part 1 – Characteristics of Vision and Visual Systems', RCA Review, March 1948).
14. Maximum sensitivity operation.
15. Intermediate sensitivity operation.
16. Average sensitivity operation.
17. Highlight level operation.
18. For example, a scene brightness of approximately 430 ft-lamberts with lens aperture f/4 and a transmission of 75% produces 5 foot candles illumination on the faceplate.
19. The signal output current is the highlight signal electrode current during one frame after the dark current component has been subtracted. Signal currents higher than  $0.25\mu\text{A}$  may be used depending on requirements.
20. The signal electrode voltage for each tube is adjusted to that value which gives the desired operating signal current; the indicated range of signal electrode voltage for each operational condition is given to illustrate the variation normally encountered.
21. The deflecting circuits must provide extremely linear scanning for good black level reproduction under these conditions. Dark current is proportional to the scanning velocity. Any change in scanning velocity produces a black level error in direct proportion to the change in velocity of scanning.

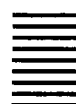

# TYPICAL SPECTRAL SENSITIVITY CHARACTERISTIC

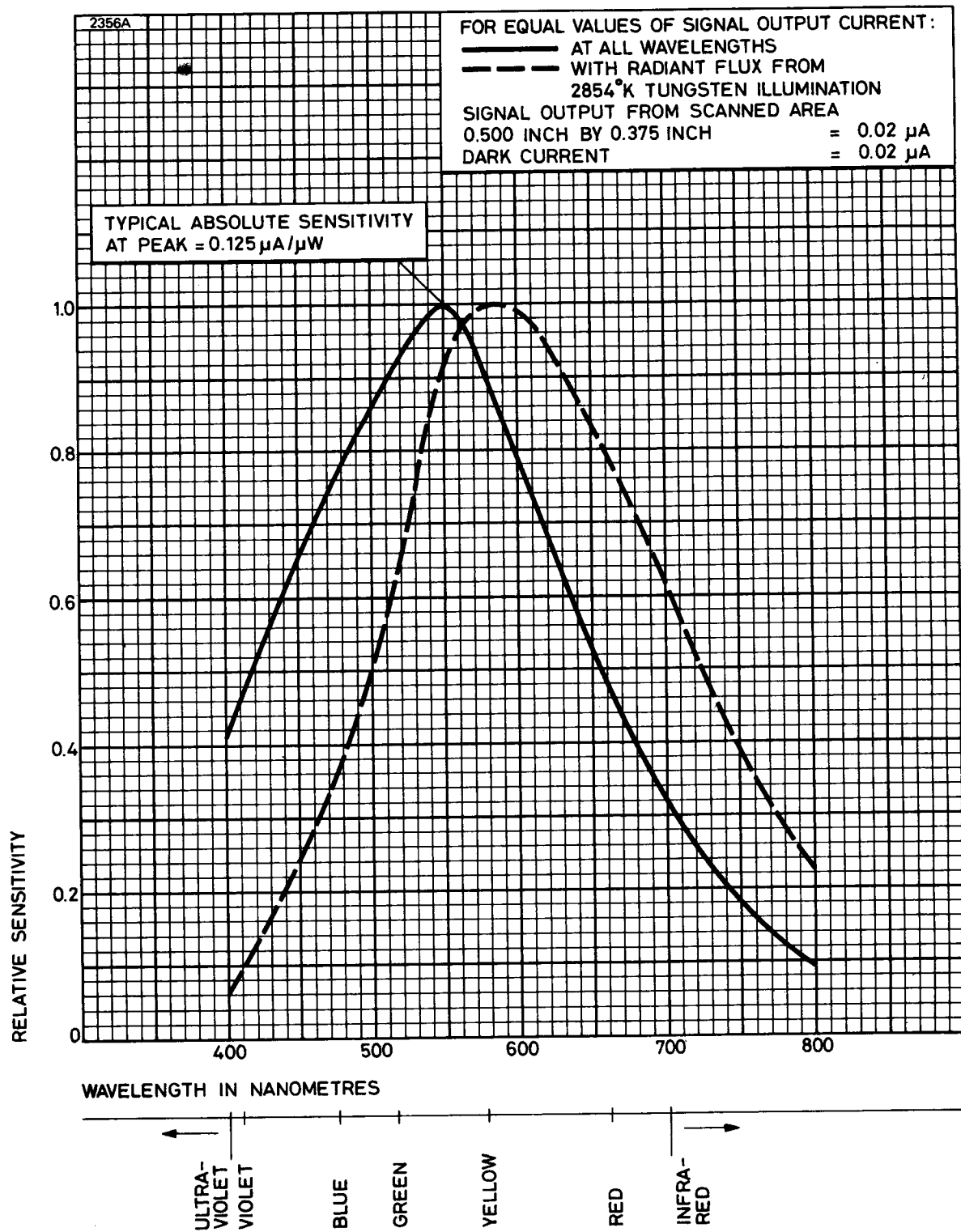

# TYPICAL RESOLUTION

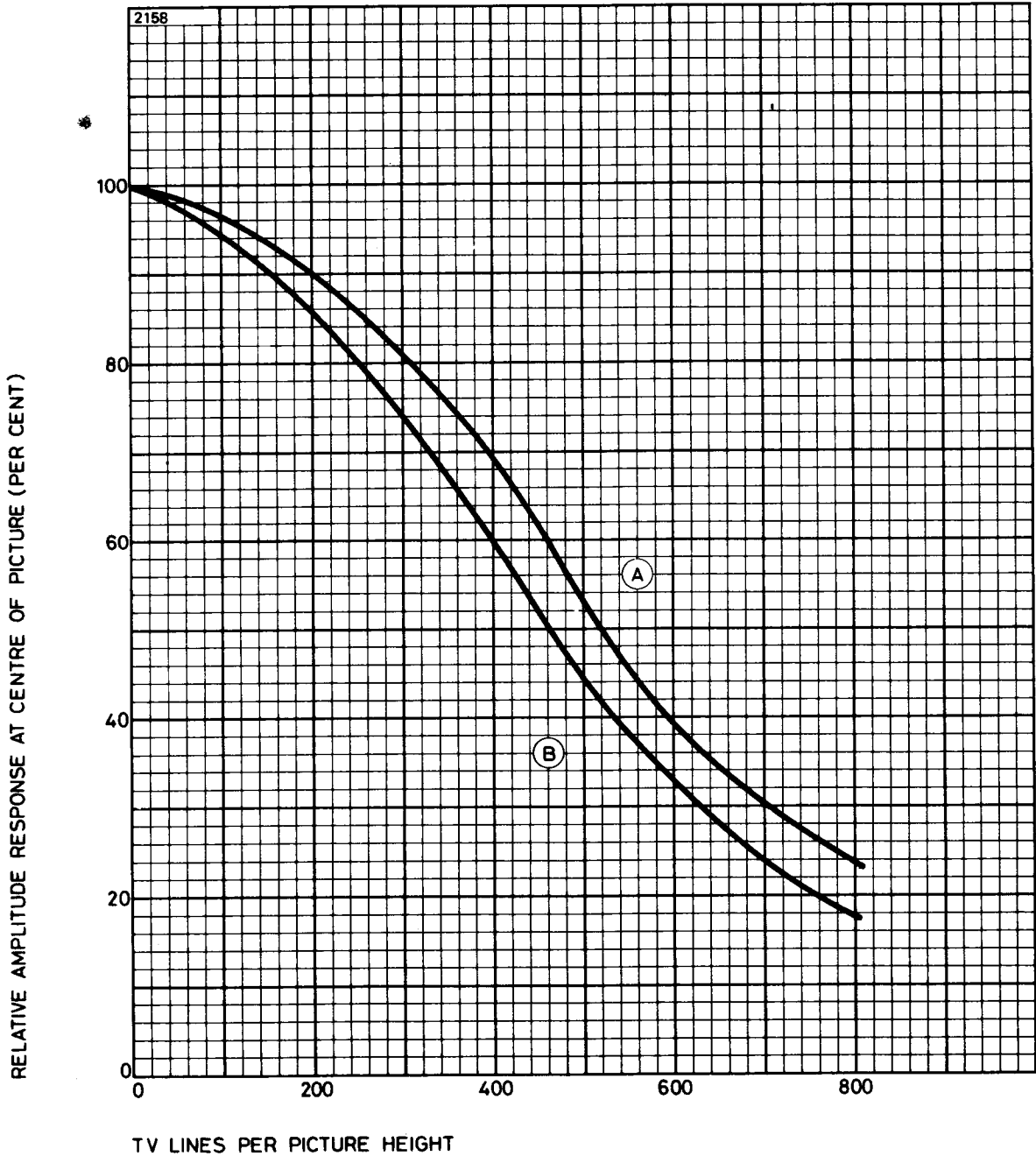

	<b>Curve A</b>	<b>Curve B</b>	
Grid 4 voltage . . . . .	750	500	V
Grid 3 voltage . . . . .	450	300	V
Focus field . . . . .	52	41	gauss
Highlight signal output current . . . . .	0.35	0.35	$\mu$ A
Dark current . . . . .	0.02	0.02	$\mu$ A
Test pattern . . . . .	square wave resolution wedge transparency		

Measured on a camera incorporating Cleveland Electronics deflection yoke VY-111-3, focusing coil VF-115-12 and alignment coil VA-118, the channel having a flat response and adequate bandwidth.

# TYPICAL LIGHT TRANSFER CHARACTERISTICS

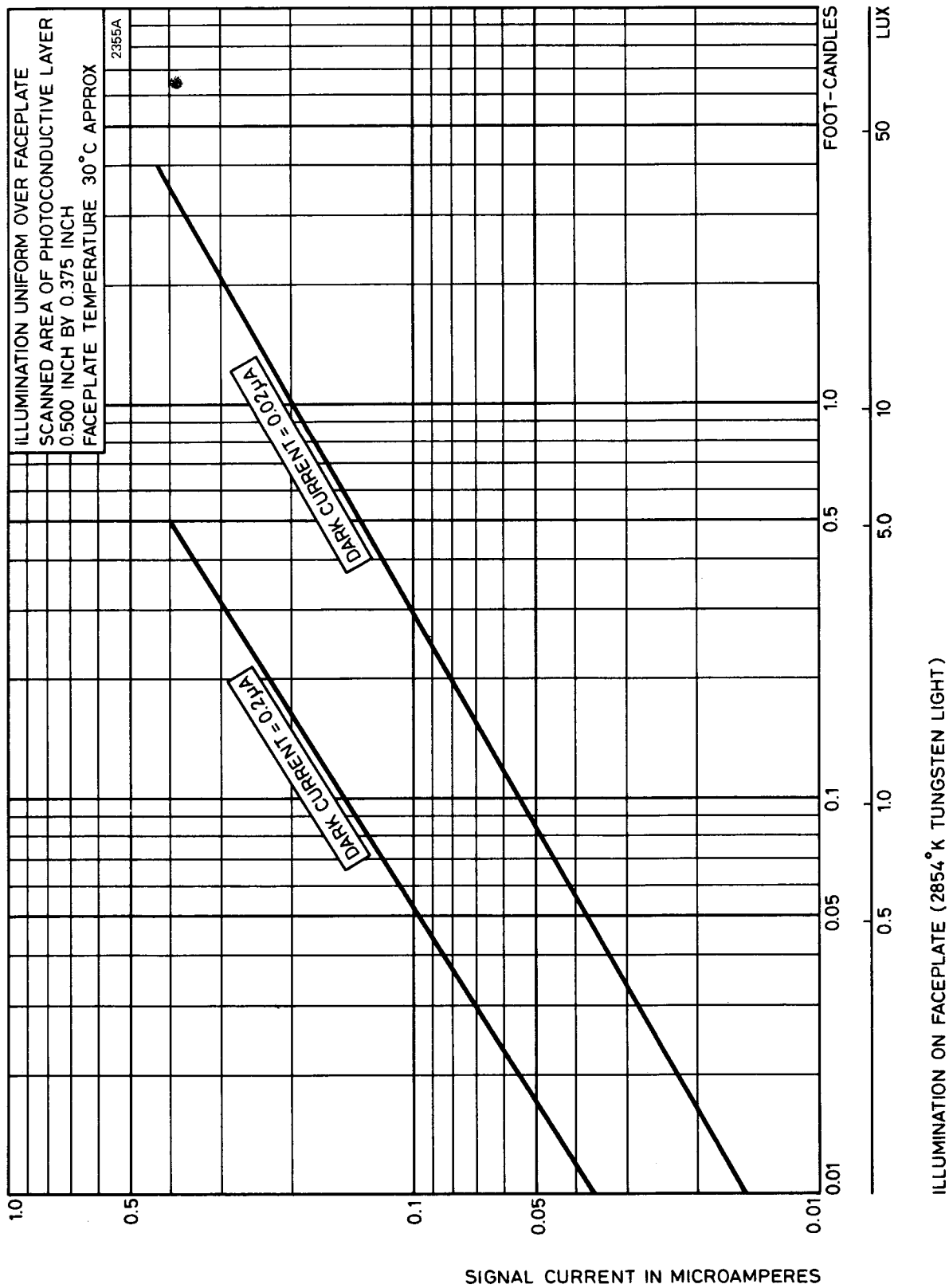



# TYPICAL RANGE OF DARK CURRENT

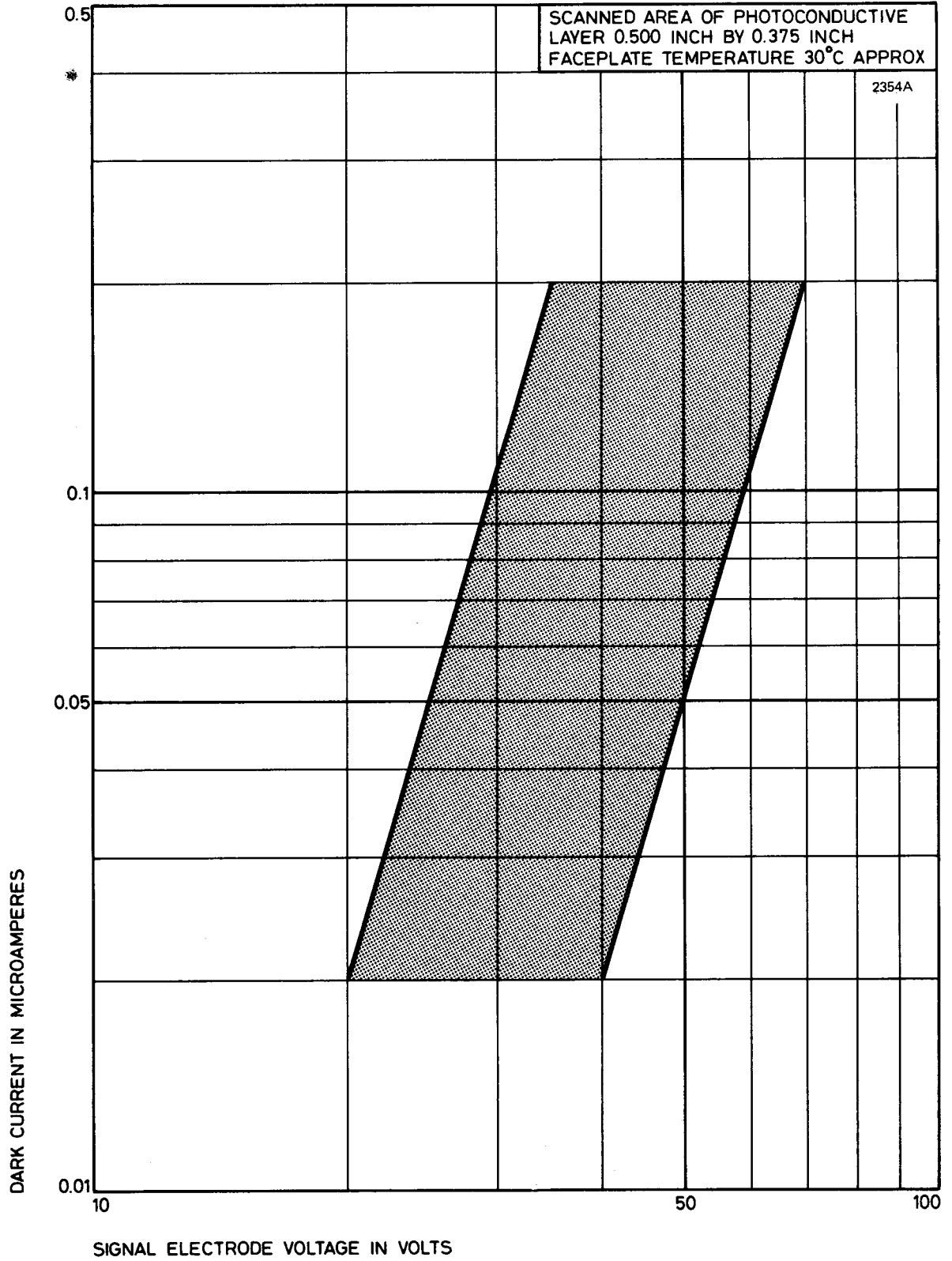

**OUTLINE (All dimensions without limits are nominal)**

2157A

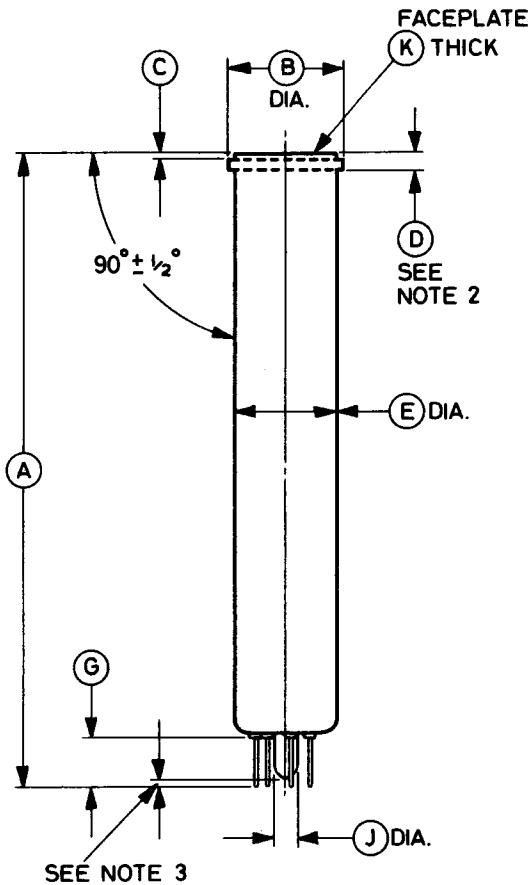
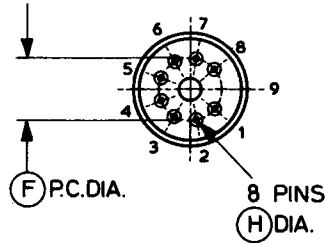
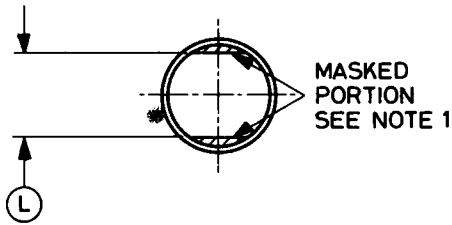

Pin	Element
1	Heater
2	Grid 1
3	Grid 4 (mesh)
4	Internal connection Do not use
5	Grid 2
6	Grid 3 (beam focus)
7	Cathode
8	Heater
9	Key pin position, blank
Flange	Signal electrode

**NOTES**

1. The straight sides are parallel to the plane passing through the tube axis and pin position 9.
2. Signal electrode contact flange may be located along the tube axis in any part of or all of the space between the dashed lines.
3. The seal-off will not project beyond the pins.

Ref	Inches	Millimetres
A	5.120 ± 0.060	130.1 ± 1.5
B	1.125 ± 0.010	28.58 ± 0.25
C	0.050 max	1.27 max
D	0.175	4.45
E	1.020 + 0.030 - 0.035	25.91 + 0.76 - 0.89
F	0.600	15.24

Ref	Inches	Millimetres
G	0.503 max	12.78 max
H	0.050 + 0.002 - 0.004	1.270 + 0.051 - 0.102
J	0.265 max	6.73 max
K	0.093 ± 0.005	2.36 ± 0.13
L	0.835 ± 0.035	21.21 ± 0.89

Millimetre dimensions have been derived from inches.

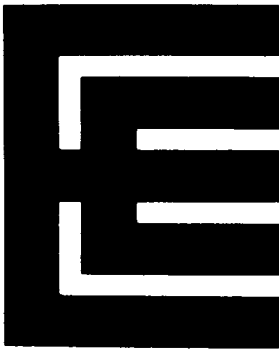

### INTRODUCTION

The P844 is a 1-inch diameter vidicon of separate mesh construction, with magnetic deflection and focusing, employing the same photoconductive layer as type 7038. This photosurface differs in sensitivity from those used in the 8541A and 8625 and may be exposed to bright stationary scenes for long periods without risk of burn-in or long term after-image. At high light levels the image retention time is very short, making it particularly suitable for use in telecine equipments. The spectral response is substantially panchromatic when used with tungsten illumination.

When operated with high voltages on grid 3 and the mesh, higher and more uniform resolution and improved signal uniformity are obtained over a wide range of signal electrode voltage than may be obtained using standard vidicons. Limiting resolutions in the region of 1000 TV lines may be obtained in the centre of the picture when the tube is operated under these conditions, optimum resolution being achieved when the grid 3 voltage is 0.6 to 0.7 of the mesh voltage.

The P844 has a 0.6 watt heater (95mA heater current) and this allows the tube to be used in small cameras employing solid state circuits; for 4 watt heater type see 8572A.



### GENERAL DATA

#### Electrical

Cathode . . . . .	indirectly heated, oxide coated	
Heater voltage . . . . .	6.3	V
Heater current . . . . .	95	mA
Inter-electrode capacitance, signal electrode to all other electrodes (average value) (see note 1) . . . . .	4.6	pF
Spectral response . . . . .	see spectral sensitivity curve	
Focusing method . . . . .	magnetic	
Deflection method . . . . .	magnetic	

## Mechanical

Overall length . . . . .	6.375 inches (162mm) max
Overall diameter . . . . .	1.135 inches (28.9mm) max
Useful size of rectangular image; diagonal, centrally situated . . . . .	0.63 inches (15.9mm) max
Orientation of rectangular image . . . . .	see note 2
Net weight . . . . .	2 ounces (60g) approx
Mounting position (see note 3) . . . . .	any
Base . . . . .	small button ditetar 8-pin (JEDEC no. E8-11)

## Associated Components

Focusing coil (see note 4) . . . . .	Cleveland Electronics VF-115-12
Deflection yoke . . . . .	Cleveland Electronics VY-111-3
Alignment coil (see note 5) . . . . .	Cleveland Electronics VA-118
Base socket . . . . .	Type R41-79502 by United Carr Fasteners Ltd. (or equivalent)

## Storage

Recommended store temperature . . . . .	15 to 35	°C
---	----------	----

Tubes should be stored in darkness

## WARNING

When operating a tube the following precautions should be observed:

1. Ensure that the temperature of the tube is within its recommended range.
2. A surge limiting device must be incorporated if necessary to ensure that the heater current does not exceed 150mA when switching on or at any other time.

## MAXIMUM AND MINIMUM RATINGS (Absolute values)

No individual rating should be exceeded

	Min	Max	
Heater voltage . . . . .	5.7	6.9	V
Signal electrode voltage . . . . .	—	100	V
Grid 4 (mesh) voltage (see note 6) . . . . .	—	1000	V
Grid 3 (beam focus) voltage (see note 6) . . . . .	—	1000	V
Grid 2 (accelerator) voltage . . . . .	—	750	V
Grid 1 voltage:			
negative bias value . . . . .	—	300	V
positive bias value . . . . .	—	0	V
Blanking voltage, peak to peak (see note 7):			
when applied to grid 1 (negative pulses) . . . . .	40	—	V
when applied to cathode (positive pulses) . . . . .	20	—	V
Peak heater to cathode voltage:			
heater negative with respect to cathode . . . . .	—	125	V
heater positive with respect to cathode . . . . .	—	10	V
Dark current . . . . .	—	0.25	$\mu$ A
Peak signal electrode current (see note 8) . . . . .	—	0.55	$\mu$ A
Faceplate temperature . . . . .	—	71	$^{\circ}$ C
Peak illumination of faceplate . . . . .	—	1000	ft-candles
	—	10 760	lux



## TYPICAL OPERATION

### Operating Conditions (for scanned area 0.5 x 0.375 inch)

The following values and notes are for general guidance and may vary from tube to tube. \*

	Low Voltage Operation	High Voltage Operation	
Grid 4 (mesh) voltage (see note 6) . . . .	500	750	V
Grid 3 (beam focus) voltage (approx) (see notes 6 and 9) . . . .	300	450	V
Grid 2 (accelerator) voltage . . . . .	300	300	V
Grid 1 voltage for picture cut-off (with no blanking voltage on grid 1) . . . . .	-45 to -100	-45 to -100	V
Blanking voltage, peak to peak:			
when applied to grid 1 (negative pulses) . . . . .	75	75	V
when applied to cathode (positive pulses) . . . . .	20	20	V
Field strength at centre of focusing coil (see notes 4 and 9) . . . . .	4.1 ± 0.4 41 ± 4	5.2 ± 0.4 52 ± 4	mT gauss
Peak deflection coil currents (approx):			
horizontal . . . . .	200	240	mA
vertical . . . . .	25	30	mA
Alignment field (adjustable) (see note 10) . . . . .	0 to 0.4 0 to 4	0 to 0.4 0 to 4	mT gauss
Faceplate temperature (see note 11) . . . . .	30 to 35	30 to 35	°C

## Typical Performance

	Low Voltage Operation	High Voltage Operation	
Limiting resolution at centre of picture (approx) . . . . .	900	1000	TV lines
Amplitude response to a 400 TV line square wave test pattern at centre of picture (approx) . . . . .	60	70	%
Lag (see note 12) . . . . .	7.5	7.5	%
'Gamma' of transfer characteristic for signal output between 0.02 and 0.2 $\mu$ A . . . . .	0.65	0.65	
Visual equivalent signal to noise ratio (see note 13) . . . . .	300:1	300:1	approx
	<b>Condition 1 (see note 14)</b>	<b>Condition 2 (see note 15)</b>	
Faceplate illumination (highlights) (see note 16) . . . . .	10	100	ft-candles
	108	1080	lux
Signal output current (peak) (see note 17) . . . . .	0.27 to 0.35	0.3 to 0.4	$\mu$ A
Approximate range of signal electrode voltage (see note 18) . . . . .	25 to 60	12 to 30	V
Dark current (see note 19) . . . . .	0.02	0.004	$\mu$ A



## SEQUENCE OF CAMERA ADJUSTMENTS

### For Typical Operating Conditions as shown above

- (a) Set the grid 1 voltage for the maximum negative bias for picture cut-off and apply the other voltages given under Typical Operating Conditions.
- (b) Check that the deflection circuits are functioning properly and adjust the scanning amplitude controls so that a maximum area of the photoconductive layer will be scanned.
- (c) Set the signal electrode voltage to give the signal current specified for the particular condition of operation. The table above gives an indica-

tion of the ranges of signal electrode voltage required for two conditions of operation. For other conditions of operation, reference should be made to the light transfer characteristic and dark current graphs. When assessing tube performance, it is essential to adjust the signal electrode voltage to produce the correct dark current; tubes must be set up to give equal values of dark current when their performances are being compared. P844 vidicons will have substantially identical performances when operated with equal values of dark current.

The magnitude of non-uniformities of dark current as well as lag increase with signal electrode voltage; therefore operation at low values of signal electrode voltage helps to minimize these effects.

- (d) Decrease grid 1 voltage from its maximum negative value until a signal is produced.
- (e) Adjust grid 3 (beam focus) or grid 3 and grid 4 (mesh) voltages (see note 6), the lens stop, and optical focus alternately to obtain the best focused picture, with the peak signal output current specified under Typical Operating Conditions.
- (f) Adjust the lens aperture and signal electrode voltage to produce the desired output signal. Lag decreases with increase in illumination on the faceplate.
- (g) Adjust the alignment field so that the centre of the picture does not move as grid 3 (beam focus) and grid 4 (mesh) voltages are rocked slightly. Adjust grid 1 (beam current) to provide sufficient beam to just discharge the highlights. It is permissible to set the alignment fields slightly off the minimum movement position to maintain signal uniformity.
- (h) Adjust the deflection amplitude and position to scan an area 0.500 inch x 0.375 inch. This is facilitated by the use of a perspex mask inscribed with circles 0.500 inch and 0.375 inch diameter, placed in contact and concentric with the faceplate of the tube. Light is allowed to fall on the photoconductive layer and an image of the rings is obtained on the monitor. No lens is necessary. The scan amplitude and centring controls are adjusted until the diameter of the larger circle is equal to the width of the raster and that of the smaller equal to the height.



- (j) Centre the raster in the useful area of the photoconductive layer and check the alignment (step g).
- (k) If the picture is faint, even with adequate video gain, open the lens iris more and, if necessary, increase the signal electrode voltage.
- (l) Repeat steps (e) to (g) until optimum picture reproduction is obtained.

## NOTES

1. This capacitance, which in effect forms the output impedance of the tube, is increased when the tube is mounted in a deflecting yoke and focusing coil assembly. The resistive component of the output impedance is of the order of 100 megohms.
2. The horizontal scan should be parallel to the plane through the tube axis and the blank index pin position. The masking is for orientation only and does not define the proper scanned area.
3. When the tube is subjected to vibration the mounting position should not be vertical with the base uppermost.
4. The direction of the focusing current should be such that a north pole is attracted to the image end of the focusing coil. The distance from the faceplate to the beginning of the winding is 0.750 inch (19mm) approximately.
5. The alignment coil is located to the rear of the focusing coil directly over the electron gun. It should be located so that its centre is 3.69 inches from the faceplate of the tube and its axis should be coincident with the axis of the tube, the deflecting yoke and the focusing coil.
6. Grid 3 and grid 4 voltages are adjusted for the best focus. The resolution, uniformity of focus and picture quality decrease with decreasing grid 3 and grid 4 voltage. In general grid 3 should be operated above 250 volts and be approximately 0.6 of grid 4 voltage.
7. The blanking voltage required when applied to the cathode is less than that required when applied to grid 1 as the former reduces the potential difference between the cathode and the scanned side of the target.



8. The video amplifier must be designed to handle signal currents of this magnitude, to avoid picture distortion due to overloading of the amplifier.
9. It may be preferred to adjust beam focus by varying the focus coil current to obtain the field strengths indicated in the Typical Operating Conditions. If the focus coil field strength is fixed, beam focus may be obtained within a  $\pm 10\%$  range (approximately) of the grid 3 and grid 4 voltages. The ratio of 0.6 between grid 3 and grid 4 should be maintained as these voltages are varied.
10. Adjust the current through the alignment coils until the centre of the test pattern does not move as grid 3 and grid 4 voltages or the focus coil current are varied in and out of focus.
11. Unless the temperature of the faceplate is maintained at a constant value within this range, the dark current and performance will drift from the optimum performance established on initial setting up.
12. Percentage of initial value of signal output current remaining 3 field periods after light is cut off (i.e. 50ms in American standard systems and 60ms in European systems), with an initial highlight signal current of  $0.3\mu\text{A}$  and a faceplate illumination of 100ft-candles (1076 lux).
13. Measured with a high gain, low noise, cascode type pre-amplifier having a bandwidth of 5.1MHz and a peak signal output current of  $0.35\mu\text{A}$ . The visual equivalent signal to noise ratio is taken as the ratio of the highlight signal output current to the r.m.s. noise current, multiplied by a factor of 3 (ref. Otto H. Schade, 'Electro-optical Characteristics of Television Systems; Introduction and Part 1 – Characteristics of Vision and Visual Systems', RCA Review, March 1948).
14. Average sensitivity operation.
15. Highlight level operation.
16. For example, a scene brightness of approximately 8600ft-lamberts ( $29\,500\text{cd/m}^2$ ) with lens aperture f/4 and a transmission of 75% produces 100 foot-candles (1076 lux) illumination on the faceplate.
17. The signal output current is the highlight signal electrode current during one frame after the dark current component has been subtracted. Signal currents higher than  $0.3\mu\text{A}$  may be used depending on requirements.

18. The signal electrode voltage for each tube is adjusted to that value which gives the desired operating signal current; the indicated range of signal electrode voltage for each operational condition is given to illustrate the variation normally encountered.
19. The deflecting circuits must provide extremely linear scanning for good black level reproduction under these conditions. Dark current is proportional to the scanning velocity. Any change in scanning velocity produces a black level error in direct proportion to the change in velocity of scanning.

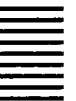

# TYPICAL SPECTRAL SENSITIVITY CHARACTERISTIC

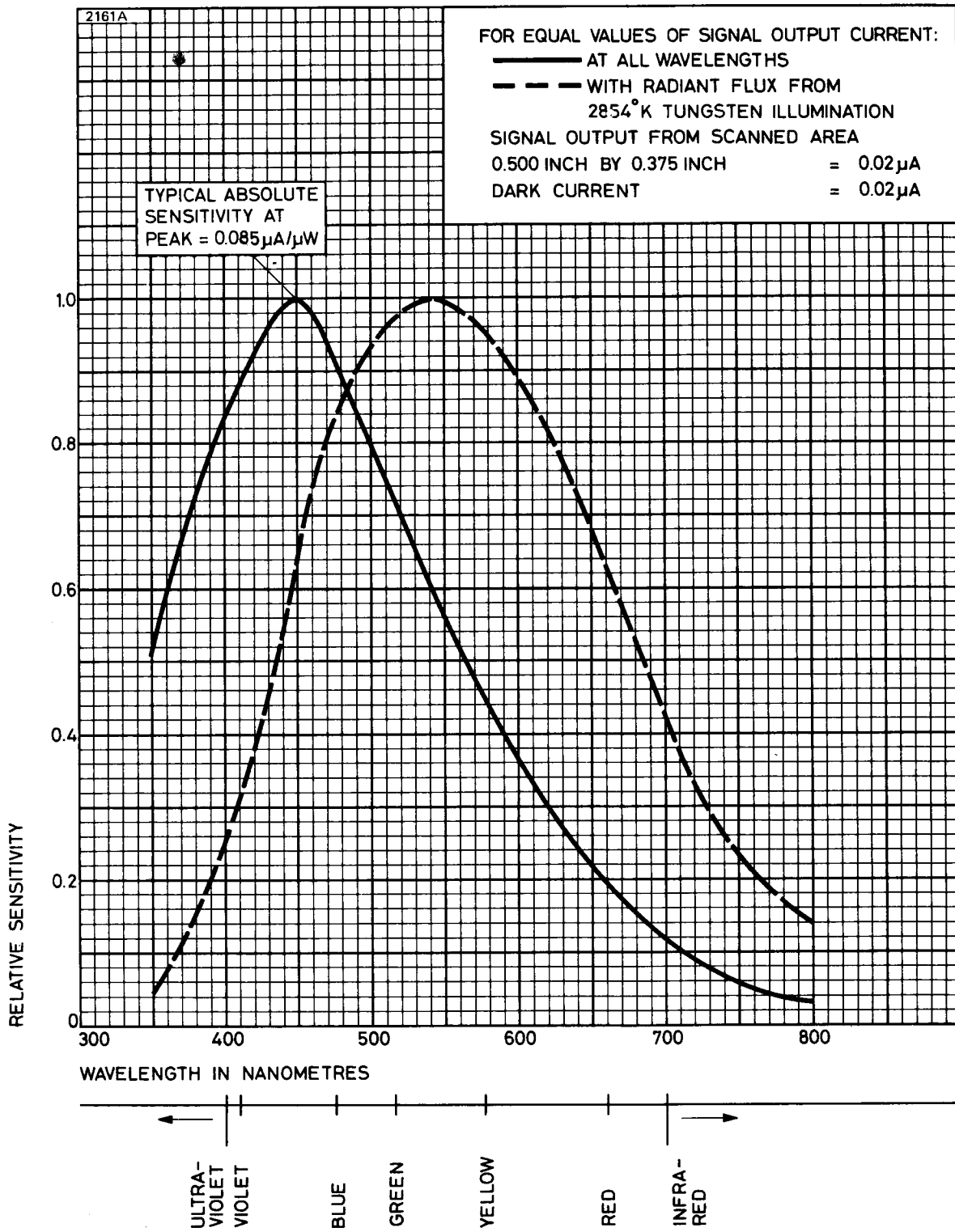

# TYPICAL RESOLUTION

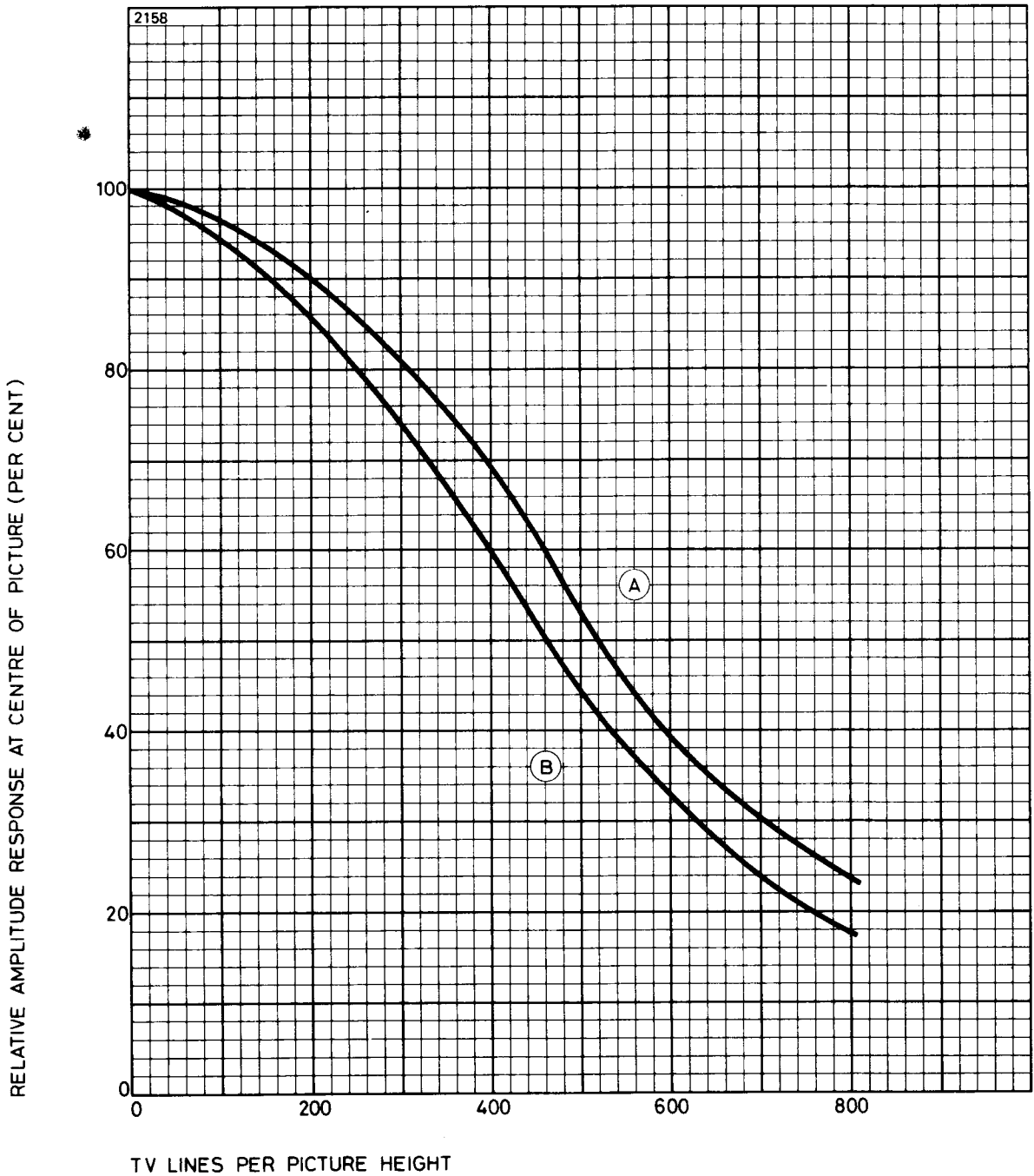

	Curve A	Curve B	
Grid 4 voltage . . . . .	750	500	V
Grid 3 voltage . . . . .	450	300	V
Focus field . . . . .	5.2	4.1	mT
	52	41	gauss
Highlight signal output current . . . . .	0.35	0.35	$\mu$ A
Test pattern . . . . .	square wave resolution wedge transparency		
Measured on a camera incorporating Cleveland Electronics deflection yoke VY-111-3, focusing coil VF-115-12 and alignment coil VA-118, channel response flat to 8MHz.			

# TYPICAL LIGHT TRANSFER CHARACTERISTICS

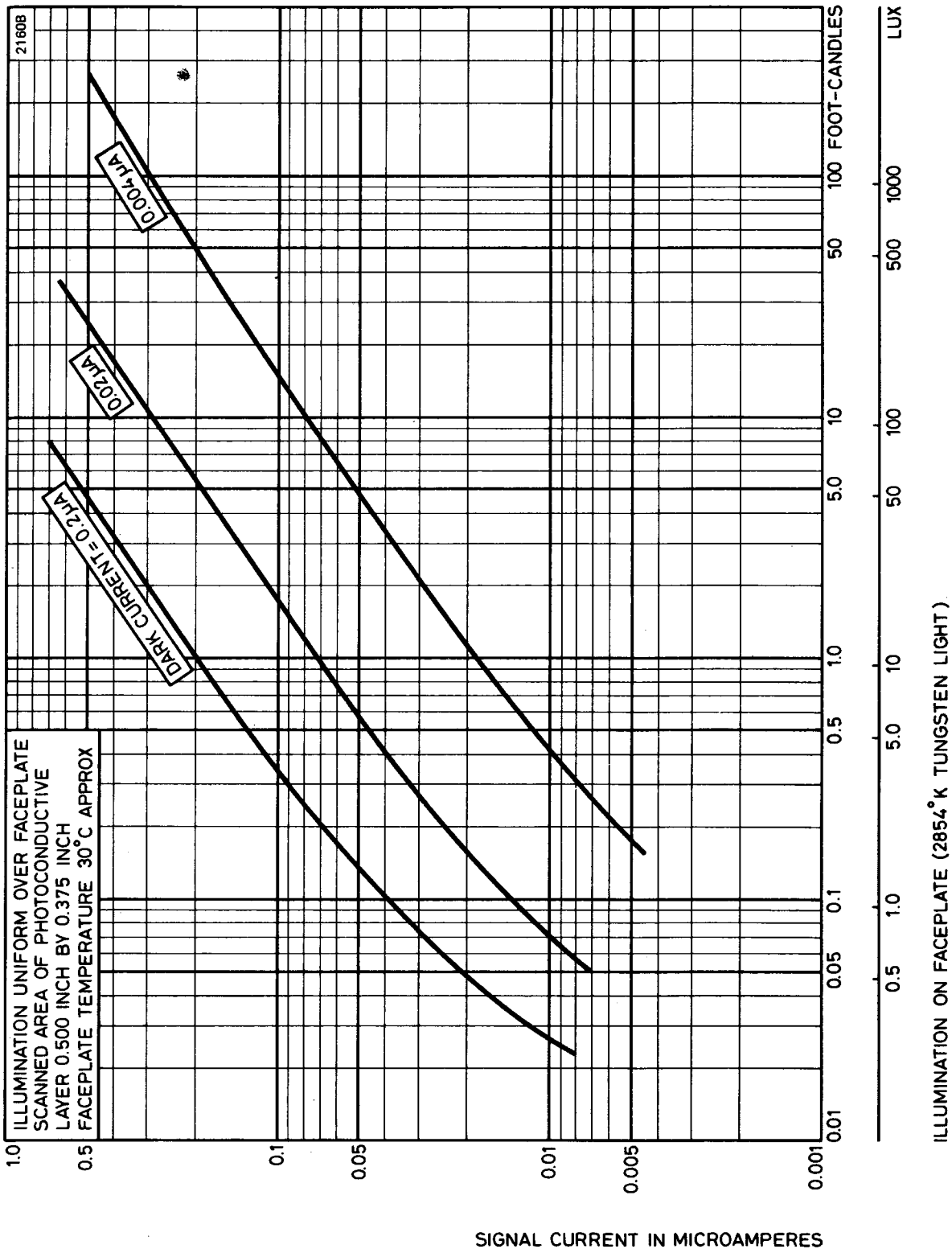

# TYPICAL LAG CHARACTERISTICS

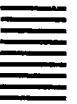
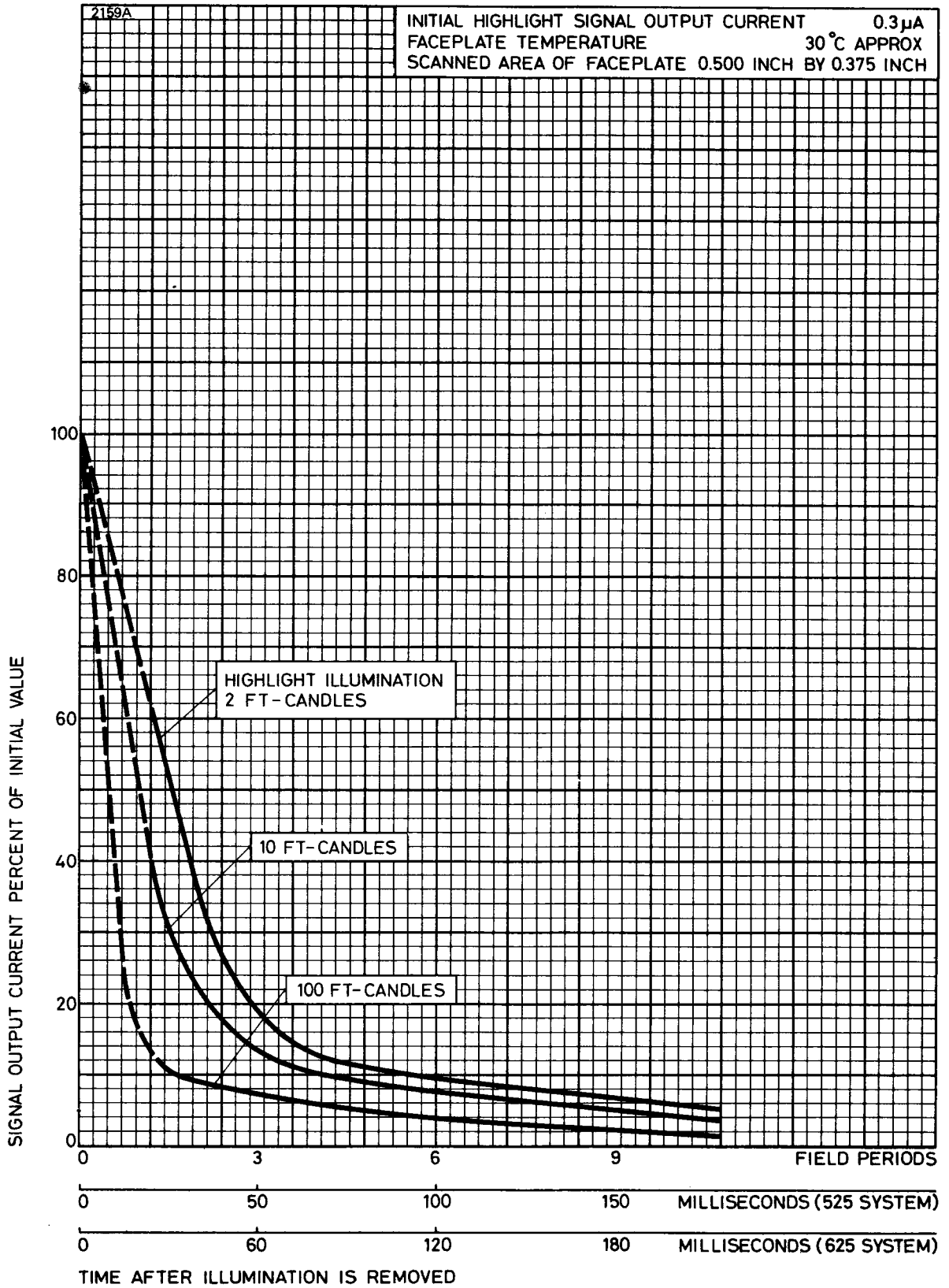

**OUTLINE (All dimensions without limits are nominal)**

2157A

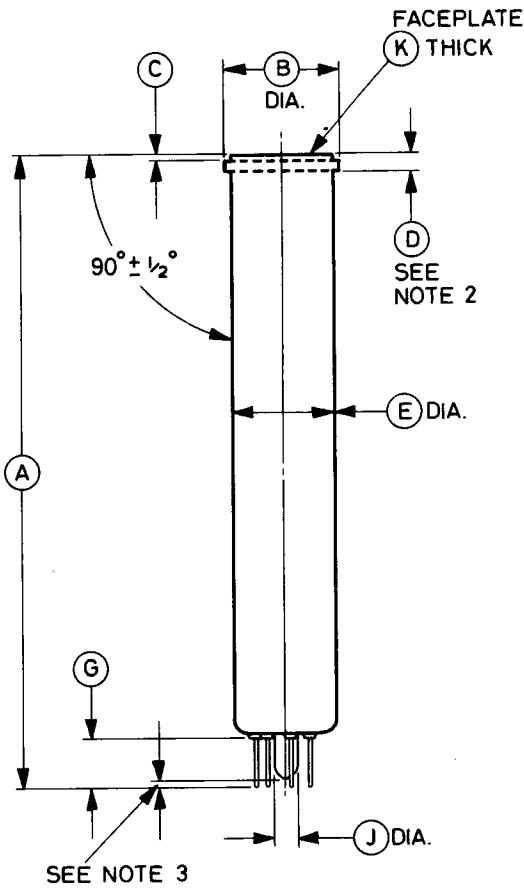
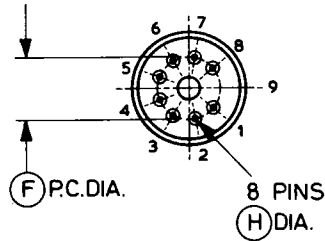
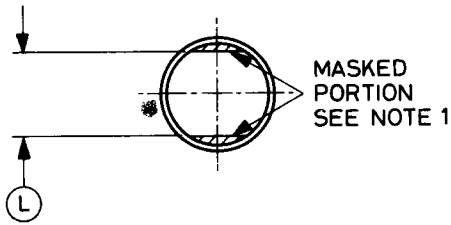

Pin	Element
1	Heater
2	Grid 1
3	Grid 4 (mesh)
4	Internal connection
5	Grid 2
6	Grid 3 (beam focus)
7	Cathode
8	Heater
9	Key pin position, blank
Flange	Signal electrode

**NOTES**

1. The straight sides are parallel to the plane passing through the tube axis and pin position 9.
2. Signal electrode contact flange may be located along the tube axis in any part of or all of the space between the dashed lines.
3. The seal-off will not project beyond the pins.

Ref	Inches	Millimetres	Ref	Inches	Millimetres
A	6.250 ± 0.125	158.8 ± 3.2	G	0.503 max	12.78 max
B	1.125 ± 0.010	28.58 ± 0.25	H	0.050 + 0.002 - 0.004	1.270 + 0.051 - 0.102
C	0.050 max	1.27 max	J	0.265 max	6.73 max
D	0.175	4.45	K	0.093 ± 0.005	2.36 ± 0.13
E	1.020 + 0.030 - 0.035	25.91 + 0.76 - 0.89	L	0.835 ± 0.035	21.21 ± 0.89
F	0.600	15.24			

Millimetre dimensions have been derived from inches.



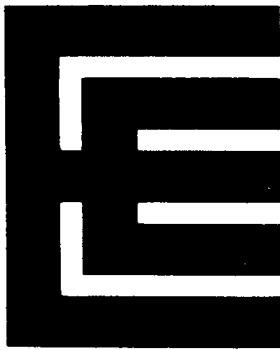

**INTRODUCTION**

The P848 and P849 are 1-inch diameter vidicons employing magnetic focus and deflection. They have high resolution capability and are designed for live pick-up in black and white TV cameras, film pick-up and three-vidicon colour cameras. They are similar to types 8507A and 8541A respectively, except for the picture defects specification, and are particularly suitable for industrial applications.

These very sensitive tubes feature a separate mesh electrode and a very uniform target layer. When operated with high voltages on grid 3 and the mesh, higher and more uniform resolution and improved signal uniformity are obtained over a wide range of signal electrode voltage than may be obtained using standard vidicons. Limiting resolutions in the region of 1000 TV lines may be obtained in the centre of the picture when the tubes are operated under these conditions, optimum resolution being achieved when the grid 3 voltage is 0.6 to 0.7 of the mesh voltage.

The high sensitivity and low lag properties of the photoconductive surface allow it to be used under normal lighting conditions encountered in industrial and studio applications. The uniformity of the layer enables uniform dark current and improved uniformity of sensitivity over the scanned area to be obtained provided that suitable associated deflecting and focusing components are used.

A 4 watt (6.3V, 600mA) heater is used in the P848 making it suitable for use in equipment designed for series heater operation or having poor heater voltage regulation. The P849 is identical with the P848 apart from its heater ratings of 6.3V, 95mA, which make it suitable for use in small compact transistorized cameras.

**GENERAL DATA**

**Electrical**

Cathode . . . . .	indirectly heated, oxide coated	
Heater voltage . . . . .	6.3	V
Heater current:		
P848 . . . . .	600	mA
P849 . . . . .	95	mA

**Continued on page 2**

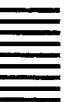

## Electrical (continued)

Inter-electrode capacitance:

signal electrode to all other electrodes (average value) (see note 1)	4.6	pF
Focusing method		magnetic
Deflection method		magnetic
Magnetic fields:		
focusing field, at centre of focusing device (see note 2)	37 to 56	gauss
alignment field, adjustable	0 to 4	gauss

## Mechanical

Overall length	6.375 inches (162mm) max
Overall diameter	1.135 inches (28.9mm) max
Useful size of rectangular image; diagonal, centrally situated	0.63 inches (15.9mm) max
Orientation	The horizontal scan should be parallel to the plane passing through the tube axis and the blank key-pin position. The masking is for orientation only and does not define the proper scanned area.
Alignment coil location	The centre of the alignment coil should be 3.69 inches (94mm) from the faceplate of the tube.
Net weight	2 ounces (60gm) approx
Mounting position (see note 3)	any
Base	Small Button Ditetrar 8-pin (JEDEC No. E8-11)
Mating socket	Type R41-79502 by United Carr Fasteners Ltd. (or equivalent)

## Storage

Recommended store temperature	15 to 35	°C
-------------------------------	----------	----

Tubes should be stored in darkness.

## WARNING

When operating a tube the following precautions should be observed:

1. Ensure that the temperature of the tube is within its recommended range.
2. Avoid excessive exposure to high levels of illumination otherwise permanent damage to the photoconductive surface may result.
3. With the P849, a surge limiting device must be incorporated if necessary to ensure that the heater current does not exceed 150mA when switching on or at any other time.

## MAXIMUM AND MINIMUM RATINGS (Absolute values)

No individual rating to be exceeded.

	Min	Max	
Heater voltage . . . . .	5.7	6.9	V
Signal electrode voltage . . . . .	—	100	V
Grid 4 (mesh) voltage (see note 4) . . . . .	—	1000	V
Grid 3 (beam focus) voltage (see note 4) . . . . .	—	1000	V
Grid 2 (accelerator) voltage . . . . .	—	750	V
Grid 1 voltage:			
negative bias value . . . . .	—	300	V
positive bias value . . . . .	—	0	V
Blanking voltage, peak to peak (see note 5):			
when applied to grid 1 (negative pulses) . . . . .	40	—	V
when applied to cathode (positive pulses) . . . . .	20	—	V
Peak heater to cathode voltage:			
heater negative with respect to cathode . . . . .	—	125	V
heater positive with respect to cathode . . . . .	—	10	V
Dark current . . . . .	—	0.25	$\mu$ A
Peak signal electrode current (see note 6) . . . . .	—	0.55	$\mu$ A
Faceplate temperature . . . . .	—	71	$^{\circ}$ C
Peak illumination of faceplate . . . . .	—	1000	ft-candles
	—	10 760	lux



## TYPICAL OPERATION

### Operating Conditions (for scanned area of 0.5 x 0.375 inch)

The following values and notes are for general guidance and may vary from tube to tube.

	Low Voltage Operation	High Voltage Operation	
Grid 4 (mesh) voltage (see note 4) . . . . .	500	750	V
Grid 3 (beam focus) voltage (approx) (see notes 4 and 7) . . . . .	300	450	V
Grid 2 (accelerator) voltage . . . . .	300	300	V
Grid 1 voltage for picture cut-off (with no blanking voltage on grid 1) -45 to -100	-45 to -100	-45 to -100	V
Blanking voltage, peak to peak:			
when applied to grid 1			
(negative pulses) . . . . .	75	75	V
when applied to cathode			
(positive pulses) . . . . .	20	20	V
Field strength at centre of focusing coil (see notes 2, 7, 8 and 9) . . . . .	41 ± 4	52 ± 4	gauss
Peak deflection coil currents (approx) (see note 8):			
horizontal . . . . .	200	240	mA
vertical . . . . .	25	30	mA
Alignment field, adjustable (see note 10) . . . . .	0 to 4	0 to 4	gauss
Faceplate temperature (see note 11) . . . . .	30 to 35	30 to 35	°C

### Typical Performance

Limiting resolution at centre of picture (approx) . . . . .	900	1000 TV lines	
Amplitude response to a 400 TV line square wave test pattern at centre of picture (approx) . . . . .	60	70	%
Lag (see note 12) . . . . .		21	% max
'Gamma' of transfer characteristic for signal output between 0.02 and 0.2μA . . . . .	0.5 to 0.6		
Visual equivalent signal to noise ratio (see note 13) . . . . .	300:1		approx
Picture defects . . . . .			see note 14

(Continued on page 5)

## Typical Performance (continued)

	Condition				
	1*	2†	3‡	4⊕	
Faceplate illumination (highlights) (see note 19)	0.1	0.5	1.0	5.0	ft-candles
Signal output current (peak) (see note 20):					
typical	0.14	0.27	0.20	0.25	μA
minimum	—	—	0.15	—	μA
Approximate range of signal electrode voltage (see note 21)	25–80	20–70	15–45	10–40	V
Dark current (see note 22)	0.2	0.1	0.02	<0.02	μA

\* See note 15

† See note 16

‡ See note 17

⊕ See note 18

## SEQUENCE OF CAMERA ADJUSTMENTS

(For general operational conditions as shown on page 4)

- (a) Set the grid 1 voltage for the maximum negative bias for picture cut-off and apply the other voltages given under Typical Operating Conditions.
- (b) Check that the deflection circuits are functioning properly and adjust the scanning amplitude controls so that a maximum area of the photoconductive layer will be scanned.
- (c) Set the signal electrode voltage to give the signal current specified for the particular condition of operation. The table above gives an indication of the ranges of signal electrode voltage required for four conditions of operation. For other conditions of operation, reference should be made to the light transfer characteristic and the graph showing the range of signal electrode voltage to produce a given dark current and therefore a given sensitivity. It is preferable, if possible, to adjust the dark current to the specified value for the particular condition of operation; P848 and P849 tubes will have substantially identical performances when operated with identical values of dark current.

The magnitude of non-uniformities of dark current, as well as lag, tend to increase with signal electrode voltage; therefore operation at low values of signal electrode voltage helps to minimize these effects.

- (d) Decrease grid 1 voltage from its maximum negative value until a signal is produced.
- (e) Adjust grid 3 (beam focus) or grid 3 and grid 4 (mesh) voltages, the lens

stop and the optical focus alternately to obtain the best focused picture with the peak signal output current specified under Typical Performance.

- (f) Adjust the lens aperture and signal electrode voltage to produce the desired output signal. Lag decreases with increase in illumination on the faceplate.
- (g) Adjust the alignment field so that the centre of the picture does not move as grid 3 (beam focus) and grid 4 (mesh) voltages are rocked slightly. Adjust grid 1 (beam current) voltage to provide sufficient beam to just discharge the highlights. It is permissible to set the alignment fields slightly off the minimum movement position to maintain signal uniformity.
- (h) Adjust the deflection amplitude and position to scan an area 0.500 inch x 0.375 inch. This is facilitated by the use of a perspex mask inscribed with circles 0.500 inch and 0.375 inch diameter, placed in contact and concentric with the faceplate of the tube. Light is allowed to fall on the photoconductive layer and an image of the rings is obtained on the monitor. No lens is necessary. The scan amplitude and centring controls are adjusted until the diameter of the larger circle is equal to the width of the raster and that of the smaller equal to the height.
- (j) Centre the raster in the useful area of the photoconductive layer and check the alignment (step g).
- (k) If the picture is faint, even with adequate video gain, open the lens iris more and, if necessary, increase the signal electrode voltage.
- (l) Repeat steps (e) to (g) until optimum picture reproduction is obtained.

## NOTES

1. This capacitance, which in effect forms the output impedance of the tube, is increased when the tube is mounted in a deflecting yoke and focusing coil assembly. The resistive component of the output impedance is of the order of 100 megohms.
2. The direction of the focusing current should be such that a north pole is attracted to the image end of the focusing coil.
3. When the tube is subjected to vibration the mounting position should not be vertical with the base uppermost.
4. Grid 3 and grid 4 voltages are adjusted for the best focus. The resolution, uniformity of focus and picture quality decrease with decreasing

grid 3 and grid 4 voltage. In general grid 3 should be operated above 250 volts and be approximately 0.6 of grid 4 voltage.

5. The blanking voltage required when applied to the cathode is less than that required when applied to grid 1 as the former reduces the potential difference between the cathode and the scanned side of the target.
6. The video amplifier must be designed to handle signal currents of this magnitude, to avoid picture distortion due to overloading of the amplifier.
7. It may be preferred to adjust beam focus by varying the focus coil current to obtain the field strengths indicated in the Typical Operating Conditions. If the focus coil field strength is fixed, beam focus may be obtained within a  $\pm 10\%$  range (approximately) of the grid 3 and grid 4 voltages. The ratio of 0.6 between grid 3 and grid 4 should be maintained as these voltages are varied.
8. Use an approved deflection yoke, focusing coil and alignment coil such as Cleveland Electronics VY-111-3 deflection yoke, VF-115-12 focusing coil, and VA-118 alignment coil. For the focusing coil, the distance from the faceplate to the beginning of the winding is 0.75 inch approximately. The alignment coil is located to the rear of the focusing coil directly over the electron gun.
9. Adjust the current through the alignment coils until the centre of the test pattern does not move as grid 3 and grid 4 voltages or the focus coil current are varied in and out of focus.
10. The alignment coil should be located so that its centre is 3.69 inches from the faceplate of the tube. Its axis should be coincident with the axis of the tube, the deflecting yoke and the focusing coil.
11. Unless the temperature of the faceplate is maintained at a constant value within this range, the dark current and performance will drift from the optimum performance established on initial setting up.
12. Percentage of initial value of signal output current remaining 3 field periods after light is cut off (i.e. 50ms in American standard systems and 60ms in European systems) with a faceplate illumination of 2ft-candles and a total signal current of  $0.3\mu\text{A}$ .
13. Measured with a high gain, low noise, cascode type pre-amplifier having a bandwidth of 5.1MHz and a peak signal output current of  $0.35\mu\text{A}$ . The visual equivalent signal to noise ratio is taken as the ratio of the highlight signal output current to the r.m.s. noise current, multiplied by



a factor of 3 (ref. Otto H. Schade, 'Electro-optical Characteristics of Television Systems; Introduction and Part 1 – Characteristics of Vision and Visual Systems', RCA Review, March 1948).

14. This test is carried out with a faceplate illumination of 2.0 foot-candles (e.g. a scene brightness of 400ft-lamberts with lens aperture of f/6.3 and transmission 75%) and signal current  $0.3\mu A$ . The test pattern shown below is used to define the picture zones.

2074

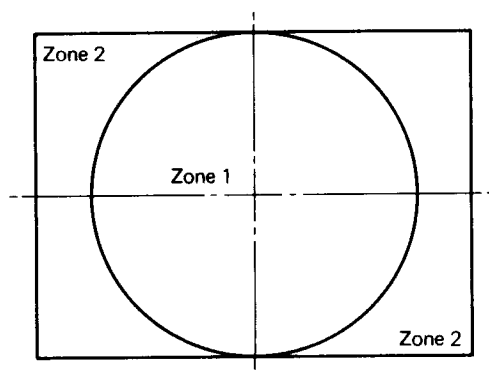

The limitations on size and number of spots will be according to the following table:

<b>Method (a)</b> Measurement in inches using a monitor with $10\frac{3}{4} \times 8\frac{1}{8}$ inch raster	<b>Method (b)</b> Percent of raster height	<b>Method (c)</b> Equivalent number of raster lines in a 525 line system	<u>Number allowed</u>	
			Zone 1	Zone 2
Over 0.065	Over 0.8	Over 4	0	0
0.065 to but not including 0.050	0.8 to but not including 0.62	4 but not including 3	0	2
0.050 to but not including 0.015	0.62 to but not including 0.19	3 but not including 1	3	4
0.015 and under	0.19 and under	1 and under	*	*

\* Spots of this size may be present in unlimited numbers unless their concentration causes a smudged appearance.

15. Maximum sensitivity operation.  
16. Intermediate sensitivity operation.



17. Average sensitivity operation.
18. Highlight level operation.
19. For example, a scene brightness of approximately 430 ft-lamberts with lens aperture f/4 and a transmission of 75% produces 5 foot candles illumination on the faceplate.
20. The signal output current is the highlight signal electrode current during one frame after the dark current component has been subtracted. Signal currents higher than  $0.3\mu\text{A}$  may be used depending on requirements.
21. The signal electrode voltage for each tube is adjusted to that value which gives the desired operating signal current; the indicated range of signal electrode voltage for each operational condition is given to illustrate the variation normally encountered.
22. The deflecting circuits must provide extremely linear scanning for good black level reproduction under these conditions. Dark current is proportional to the scanning velocity. Any change in scanning velocity produces a black level error in direct proportion to the change in velocity of scanning.

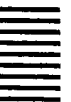

# TYPICAL RESOLUTION

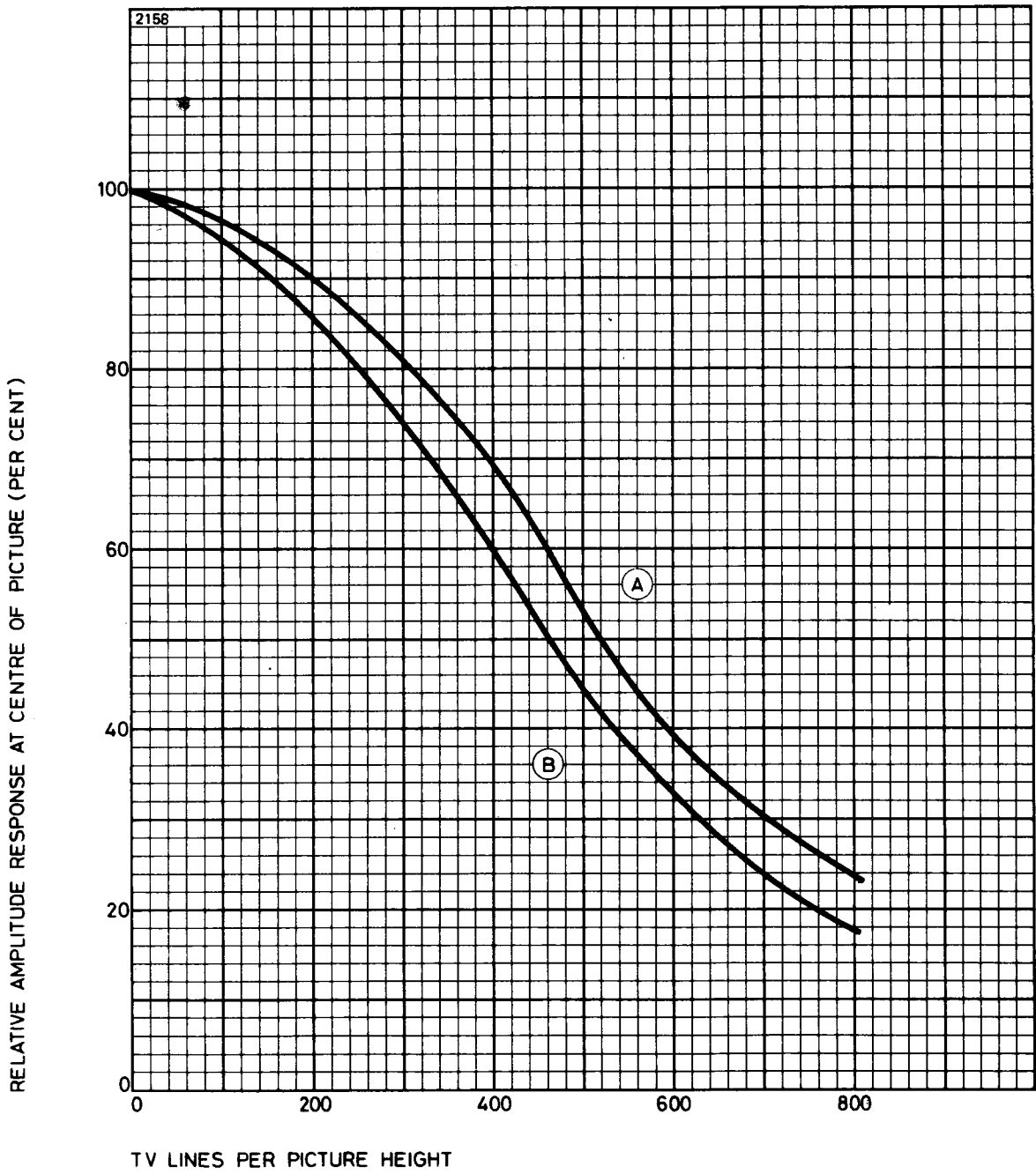

	Curve A	Curve B	
Grid 4 voltage	750	500	V
Grid 3 voltage	450	300	V
Focus field	52	41	gauss
Highlight signal output current	0.35	0.35	$\mu$ A
Dark current	0.02	0.02	$\mu$ A
Test pattern	square wave resolution wedge transparency		

Measured on a camera incorporating Cleveland Electronics deflection yoke VY-111-3, focusing coil VF-115-12 and alignment coil VA-118, the channel having a flat response and adequate bandwidth.

# TYPICAL LIGHT TRANSFER CHARACTERISTICS

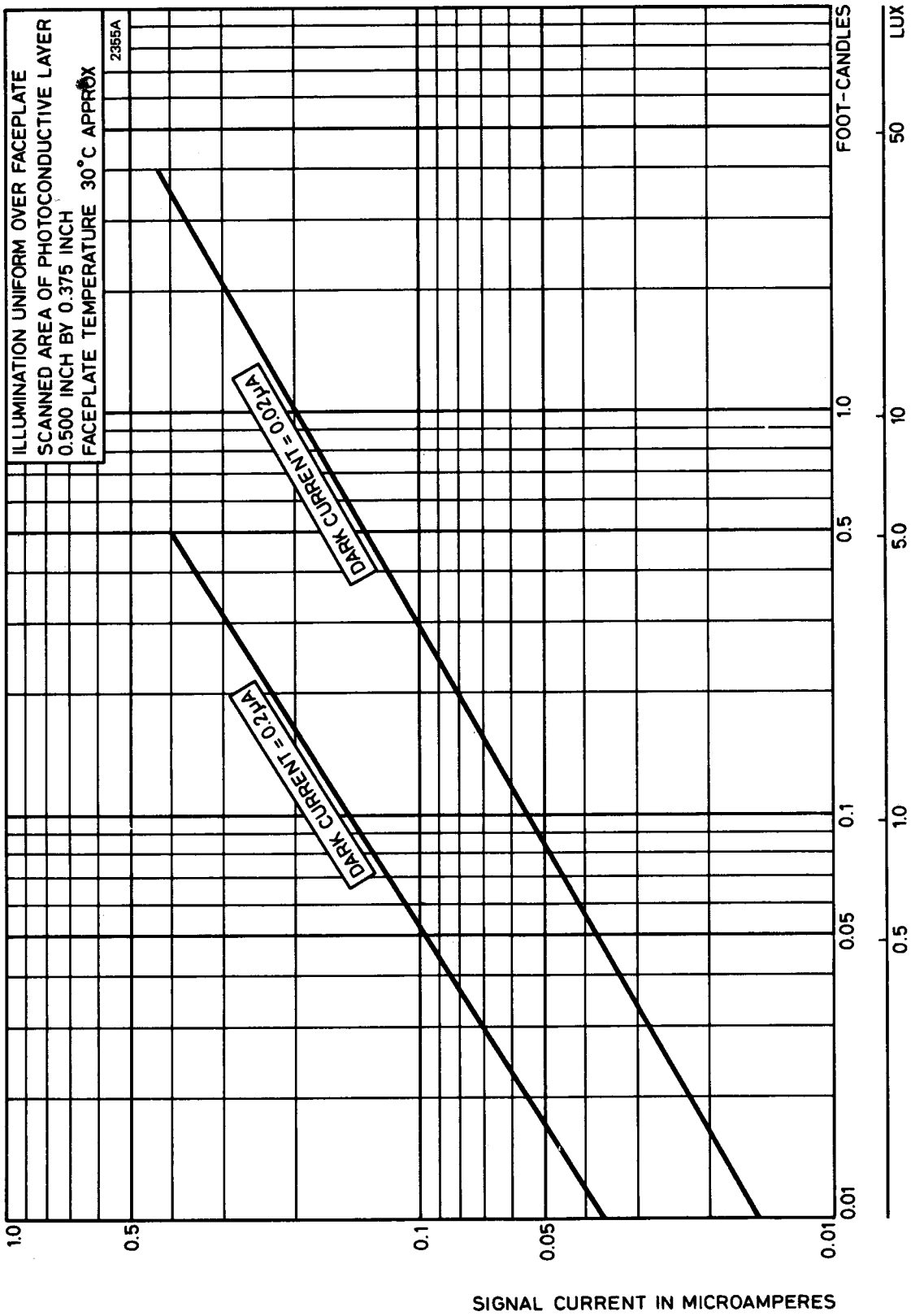

# TYPICAL RANGE OF DARK CURRENT

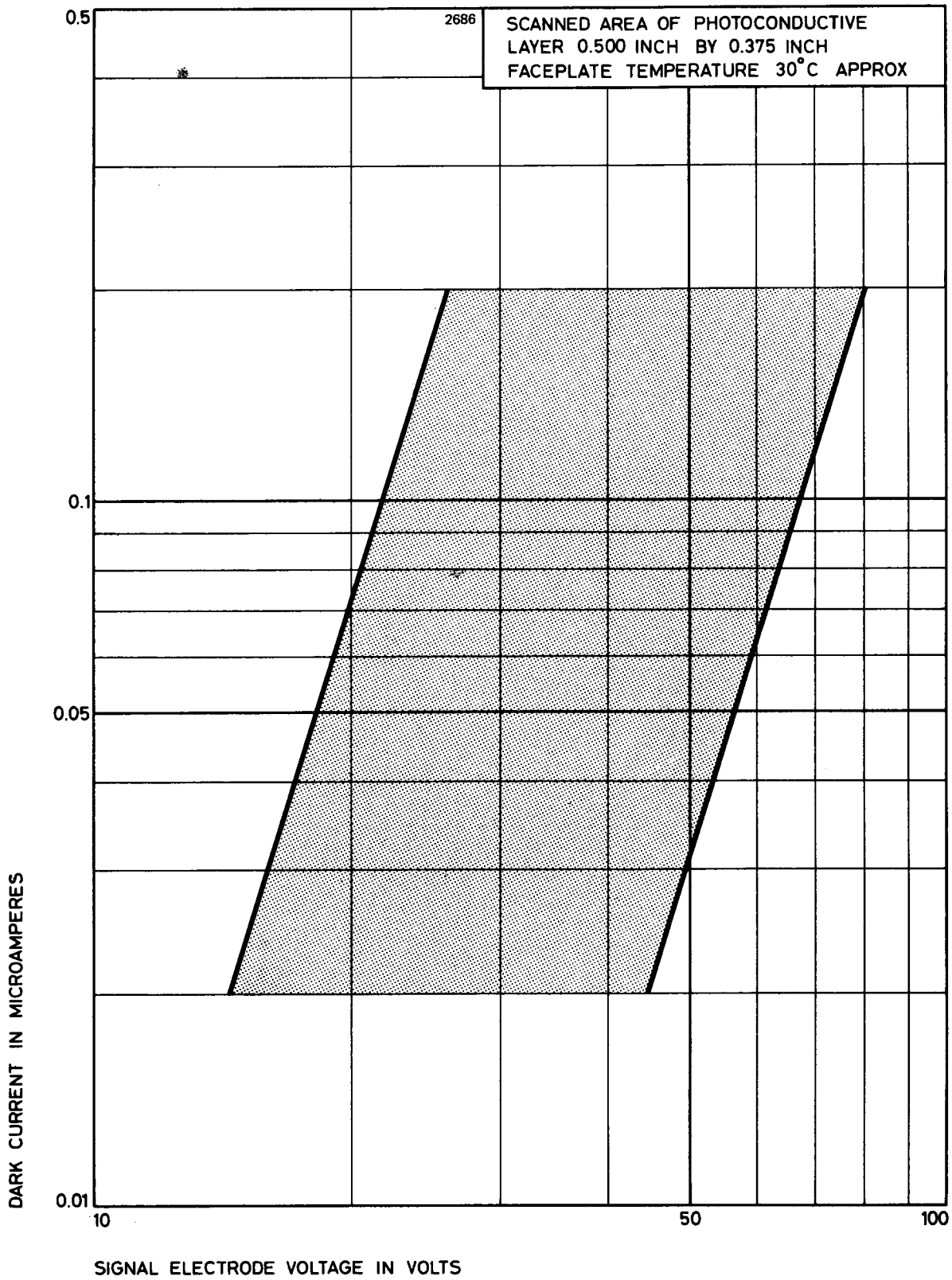

# OUTLINE

2157A

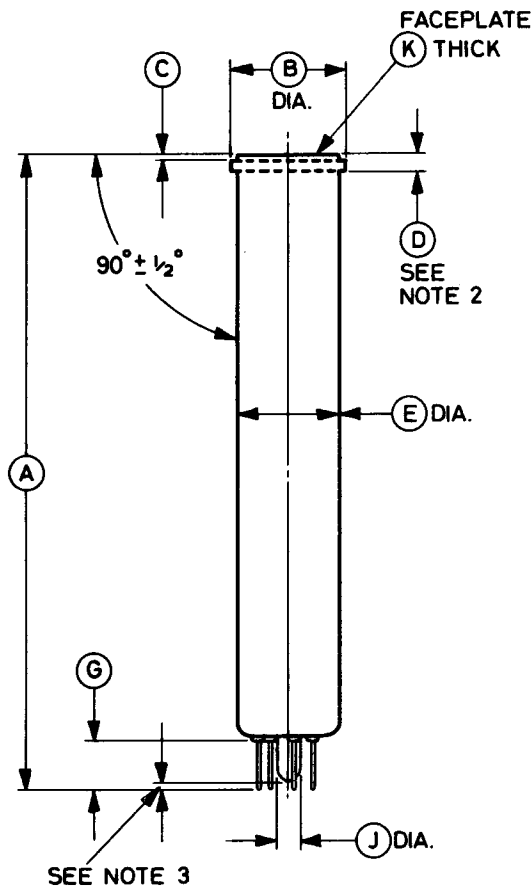
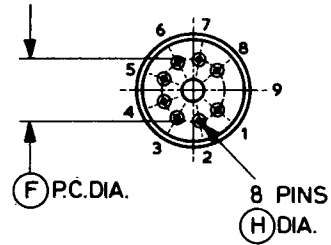
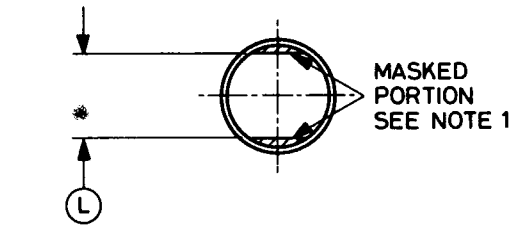

Pin	Element
1	Heater
2	Grid 1
3	Grid 4 (mesh)
4	Internal connection
5	Grid 2
6	Grid 3 (beam focus)
7	Cathode
8	Heater
9	Key pin position, blank
Flange	Signal electrode

## NOTES

1. The straight sides are parallel to the plane passing through the tube axis and pin position 9.
2. Signal electrode contact flange may be located along the tube axis in any part of or all of the space between the dashed lines.
3. The seal-off will not project beyond the pins.

Ref	Inches	Millimetres
A	6.250 ± 0.125	158.8 ± 3.2
B	1.125 ± 0.010	28.58 ± 0.25
C	0.050 max	1.27 max
D	0.175	4.45
E	1.020 + 0.030 - 0.035	25.91 + 0.76 - 0.89
F	0.600	15.24

Ref	Inches	Millimetres
G	0.503 max	12.78 max
H	0.050 + 0.002 - 0.004	1.270 + 0.051 - 0.102
J	0.265 max	6.73 max
K	0.093 ± 0.005	2.36 ± 0.13
L	0.835 ± 0.035	21.21 ± 0.89

Millimetre dimensions have been derived from inches.

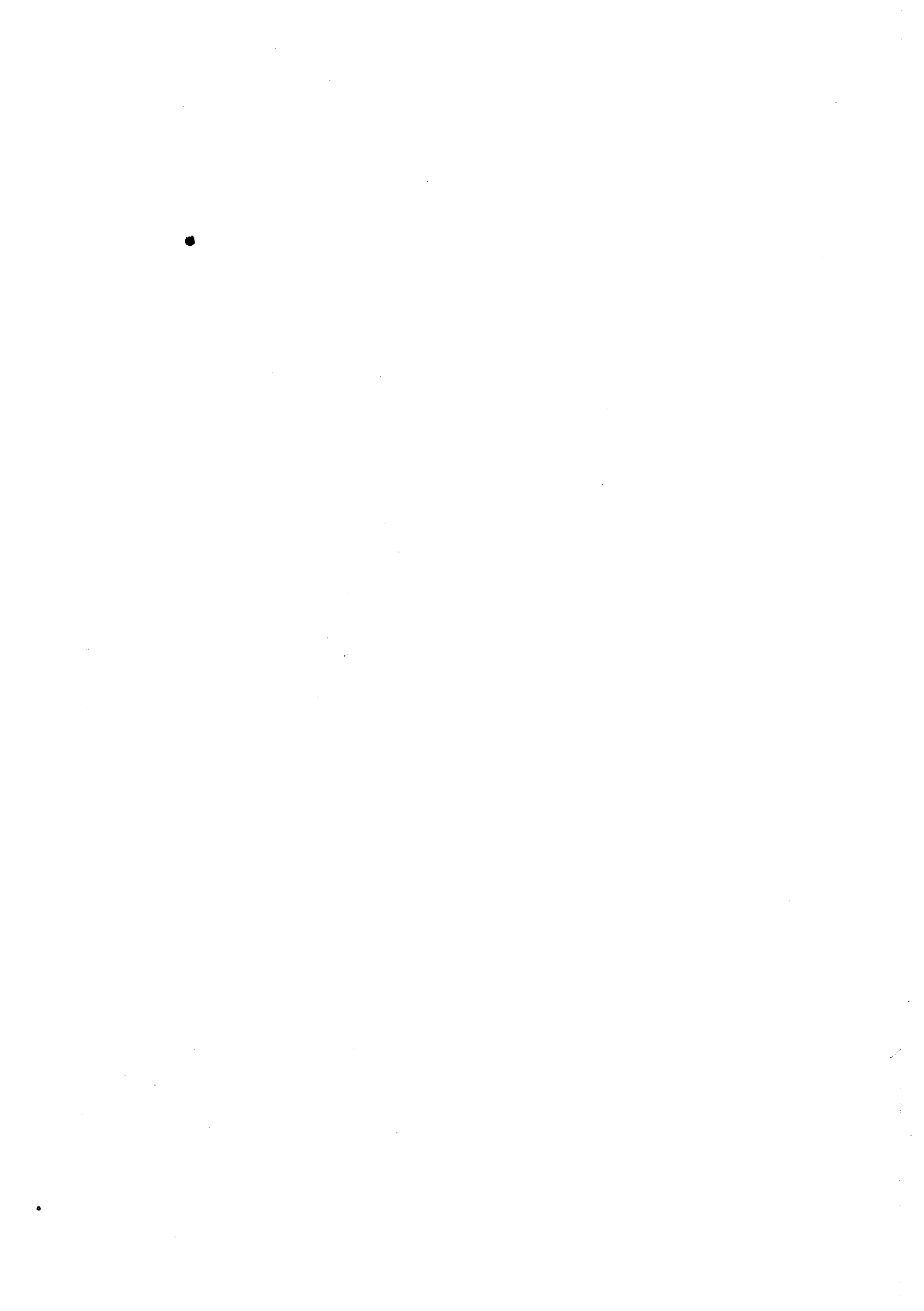

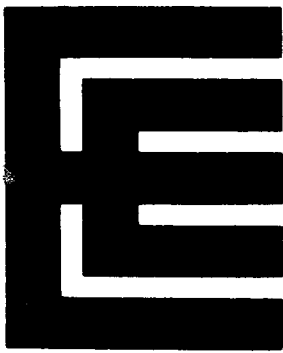

**This information should be read in conjunction with the P848, P849 data.**

The P848D and P849D are identical with EEV types P848 and P849 apart from the following performance details.

### Typical Performance

Signal output current:

typical . . . . .	0.25	$\mu$ A
minimum . . . . .	0.20	$\mu$ A
Illumination on faceplate (2854K tungsten light) . . . . .	1.8	ft-candle
	19.4	lux
Dark current . . . . .	0.02	$\mu$ A
Signal electrode voltage range ‡ . . . . .	10 to 70	V
Resolution ( $V_{g3} = 300V, V_{g4} = 500V$ ) . . . . .	>700	TV lines

### Picture Defects (measured under the above conditions)

The limitations on the size and number of spots will be according to the following table.

Spot size as equivalent number of raster lines in a 625 line system	Zone 1*	Zone 2†
over 5	none	] not specified
5 to but not including 1	4	

Spots below 1 line diameter are not considered.

‡ For 0.02 $\mu$ A dark current.

\* Zone 1 is a circle centred on the raster and with a diameter equal to the raster height.

† Zone 2 is the area outside Zone 1.

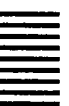







## RUGGEDISED VIDICON

Service Type CV6243

### INTRODUCTION

The P863 is a short, rugged 1-inch vidicon of separate mesh construction with magnetic deflection and focusing, designed for special applications involving severe shock and vibration. This very sensitive vidicon features a separate mesh electrode and a very uniform target layer, resulting in good signal uniformity over a wide range of signal electrode voltages. It has a low power (0.6 watt) heater and differs from the P831 mainly in the mesh connection, which is brought out to a ring contact near the faceplate instead of to the 8-pin base (see outline drawing).

When operated with high voltages on grid 3 and the mesh, higher and more uniform resolution and improved signal uniformity are obtained over a wide range of signal electrode voltage than may be obtained using standard vidicons. Limiting resolutions in the region of 1000 TV lines may be obtained in the centre of the picture when the tube is operated under these conditions, optimum resolution being achieved when the grid 3 voltage is 0.6 to 0.7 of the mesh voltage.

The high sensitivity and low lag properties of the P863 photoconductive surface allow it to be used under lighting conditions encountered in special industrial and military applications. The uniformity of the layer enables uniform dark current and improved uniformity of sensitivity over the scanned area to be obtained provided that suitable associated deflecting and focusing components are used.



### GENERAL DATA

#### Electrical

Cathode . . . . .	indirectly heated, oxide coated		
Heater voltage . . . . .	6.3	V	
Heater current . . . . .	95	mA	
Inter-electrode capacitance, signal electrode to all other electrodes (average value) (see note 1)	5.0	pF	
Spectral response . . . . .	see spectral sensitivity curve		
Focusing method . . . . .	magnetic		
Deflection method . . . . .	magnetic		
Magnetic fields:			
focusing field, at centre of focusing device (see note 2)	37 to 56	gauss	
alignment field, adjustable	0 to 4	gauss	

**Mechanical**

Overall length . . . . .	5.180 inches (131.6mm) max
Overall diameter . . . . .	1.135 inches (28.9mm) max
Useful size of rectangular image; diagonal, centrally situated . . . . .	0.63 inches (15.9mm) max
Orientation . . . . .	The horizontal scan should be parallel to the plane passing through the tube axis and the blank key-pin position. The masking is for orientation only and does not define the proper scanned area.
Net weight . . . . .	2 ounces (60g) approx
Mounting position (see note 3) . . . . .	any
Base . . . . .	small button ditettr 8-pin (JEDEC no. E8-11)
Mating socket . . . . .	Type R41-79502 by United Carr Fasteners Ltd. (or equivalent)

**Storage**

Recommended store temperature . . . . . 15 to 35 °C  
 Tubes should be stored in darkness.

**WARNING**

When operating a tube the following precautions should be observed:

1. Ensure that the temperature of the tube is within its recommended range.
2. Avoid over exposure of stationary pictures, e.g. test patterns, or after-image may result.
3. A surge limiting device must be incorporated if necessary to ensure that the heater current does not exceed 150mA when switching on or at any other time.
4. Ensure that the envelope between the signal electrode and mesh contacts is clean.

**MAXIMUM AND MINIMUM RATINGS (Absolute values)**

No individual rating to be exceeded.

	<b>Min</b>	<b>Max</b>	
Heater voltage . . . . .	5.7	6.9	V
Signal electrode voltage . . . . .	—	100	V
Grid 4 (mesh) voltage (see note 4) . . . . .	—	1000	V
Grid 3 (beam focus) voltage (see note 4) . . . . .	—	1000	V
Grid 2 (accelerator) voltage . . . . .	—	750	V

**Continued on page 3**

**MAXIMUM AND MINIMUM RATINGS (Absolute values) — continued**

	Min	Max	
Grid 1 voltage:			
negative bias value . . . . .	—	300	V
positive bias value . . . . .	—	0	V
Blanking voltage, peak to peak (see note 5):			
when applied to grid 1 (negative pulses) .	40	—	V
when applied to cathode (positive pulses) .	20	—	V
Peak heater to cathode voltage:			
heater negative with respect to cathode .	—	125	V
heater positive with respect to cathode . .	—	10	V
Dark current . . . . .	—	0.25	$\mu$ A
Peak signal electrode current (see note 6) .	—	0.55	$\mu$ A
Faceplate temperature . . . . .	—	71	$^{\circ}$ C
Peak illumination of faceplate . . . . .	—	1000	ft-candles
	—	10 760	lux

**TYPICAL OPERATION**

**Operating Conditions** (for scanned area of 0.5 x 0.375 inch)

The following values and notes are for general guidance and may vary from tube to tube.

	Low Voltage Operation	High Voltage Operation	
Grid 4 (mesh) voltage (see note 4) . . . . .	500	750	V
Grid 3 (beam focus) voltage (approx) (see notes 4 and 7) . . . . .	300	450	V
Grid 2 (accelerator) voltage . . . . .	300	300	V
Grid 1 voltage for picture cut-off (with no blanking voltage on grid 1) —45 to —100	—45 to —100	—45 to —100	V
Blanking voltage, peak to peak:			
when applied to grid 1 (negative pulses) . . . . .	75	75	V
when applied to cathode (positive pulses) . . . . .	20	20	V
Field strength at centre of focusing coil (see notes 2, 7 and 8) . . . . .	41 $\pm$ 4	52 $\pm$ 4	gauss
Alignment field, adjustable (see notes 9 and 10) . . . . .	0 to 4	0 to 4	gauss
Faceplate temperature (see note 11) .	30 to 35	30 to 35	$^{\circ}$ C

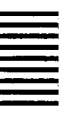

## Typical Performance

	Low Voltage	High Voltage	
Limiting resolution at centre of picture (approx) . . . . .	900	1000	TV lines
Amplitude response to a 400 TV line square wave test pattern at centre of picture (approx) . . . . .	60	70	%
Lag (see note 12) . . . . .		20	% max
'Gamma' of transfer characteristic for signal output between 0.02 and 0.2 $\mu$ A . . . . .	0.5 to 0.6		
Visual equivalent signal to noise ratio (see note 13) . . . . .		300:1	approx

### Condition

	1*	2†	3‡	4⊕	
Faceplate illumination (highlights) (see note 18) . . . . .	0.1	0.5	1.0	5.0	ft-candles
Signal output current (peak) (see note 19):					
typical . . . . .	0.14	0.27	0.20	0.25	$\mu$ A
minimum . . . . .	—	—	0.15	—	$\mu$ A
Approximate range of signal electrode voltage (see note 20)	35–70	30–60	20–40	10–40	V
Dark current (see note 21) . . . . .	0.2	0.1	0.02	<0.02	$\mu$ A

\* See note 14

† See note 15

‡ See note 16

⊕ See note 17

## SPECIAL PERFORMANCE

Tubes of this type have been successfully submitted to a type approval programme including the following environmental tests.

1. Thermal shock
2. Rapid depressurisation
3. Tropical exposure
4. Long term storage at elevated temperature (70°C)
5. Mechanical shock
6. Combined temperature, pressure and vibration
7. Random noise vibration

It may be possible, from the results of these tests to predict the probable performance of the tube under various environmental conditions.

If it is proposed to use the tubes under conditions of severe vibration etc., the manufacturer may be able to advise as to the performance to be expected.

## SEQUENCE OF CAMERA ADJUSTMENTS

(For Typical Operating Conditions as shown on page 3)

- (a) Set the grid 1 voltage for the maximum negative bias for picture cut-off and apply the other voltages given under Typical Operating Conditions.
- (b) Check that the deflection circuits are functioning properly and adjust the scanning amplitude controls so that a maximum area of the photo-conductive layer will be scanned.
- (c) Set the signal electrode voltage to give the signal current specified for the particular condition of operation. The table on page 4 gives an indication of the ranges of signal electrode voltage required for four conditions of operation. For other conditions of operation, reference should be made to the light transfer characteristic and the graph showing the range of signal electrode voltage to produce a given dark current and therefore a given sensitivity. It is preferable, if possible, to adjust the dark current to the specified value for the particular condition of operation; P863 tubes will have substantially identical performances when operated with identical values of dark current.

The magnitude of non-uniformities of dark current, as well as lag, tend to increase with signal electrode voltage; therefore operation at low values of signal electrode voltage helps to minimise these effects.

- (d) Decrease grid 1 voltage from its maximum negative value until a signal is produced.
- (e) Adjust grid 3 (beam focus) or grid 3 and grid 4 (mesh) voltages, the lens stop and the optical focus alternately to obtain the best focused picture with the peak signal output current specified under Typical Performance.
- (f) Adjust the lens aperture and signal electrode voltage to produce the desired output signal. Lag decreases with increase in illumination on the faceplate.
- (g) Adjust the alignment field so that the centre of the picture does not move as grid 3 (beam focus) and grid 4 (mesh) voltages are rocked slightly. Adjust grid 1 (beam current) voltage to provide sufficient beam to just discharge the highlights. It is permissible to set the alignment fields slightly off the minimum movement position to maintain signal uniformity.
- (h) Adjust the deflection amplitude and position to scan an area 0.500 inch x 0.375 inch. This is facilitated by the use of a perspex mask inscribed with circles 0.500 inch and 0.375 inch diameter, placed in contact and

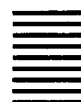

concentric with the faceplate of the tube. Light is allowed to fall on the photoconductive layer and an image of the rings is obtained on the monitor. No lens is necessary. The scan amplitude and centring controls are adjusted until the diameter of the larger circle is equal to the width of the raster and that of the smaller equal to the height.

- (j) Centre the raster in the useful area of the photoconductive layer and check the alignment (step g).
- (k) If the picture is faint, even with adequate video gain, open the lens iris more and, if necessary, increase the signal electrode voltage.
- (l) Repeat steps (e) to (g) until optimum picture reproduction is obtained.

## NOTES

1. This capacitance, which in effect forms the output impedance of the tube, is increased when the tube is mounted in a deflecting yoke and focusing coil assembly. The resistive component of the output impedance is of the order of 100 megohms.
2. The direction of the focusing current should be such that a north pole is attracted to the image end of the focusing coil.
3. When subjected to vibration the tube should not be displaced with respect to the focus, deflection and alignment fields.
4. Grid 3 and grid 4 voltages are adjusted for the best focus. The resolution, uniformity of focus and picture quality decrease with decreasing grid 3 and grid 4 voltage. In general grid 3 should be operated above 250 volts and be approximately 0.6 of grid 4 voltage.
5. The blanking voltage required when applied to the cathode is less than that required when applied to grid 1 as the former reduces the potential difference between the cathode and the scanned side of the target.
6. The video amplifier must be designed to handle signal currents of this magnitude, to avoid picture distortion due to overloading of the amplifier.
7. It may be preferred to adjust beam focus by varying the focus coil current to obtain the field strengths indicated in the Typical Operating Conditions. If the focus coil field strength is fixed, beam focus may be obtained within a  $\pm 10\%$  range (approximately) of the grid 3 and grid 4 voltages. The ratio of 0.6 between grid 3 and grid 4 should be maintained as these voltages are varied.
8. Use a deflection yoke, focusing coil and alignment coil which have been approved for operation under specified conditions of shock and vibration.

9. Adjust the current through the alignment coils until the centre of the test pattern does not move as grid 3 and grid 4 voltages or the focus coil current are varied in and out of focus.
10. The alignment coil should be located so that its centre is 3.69 inches from the faceplate of the tube. Its axis should be coincident with the axis of the tube, the deflecting yoke and the focusing coil.
11. Unless the temperature of the faceplate is maintained at a constant value within this range, the dark current and performance will drift from the optimum performance established on initial setting up.
12. Percentage of initial value of signal output current remaining 3 field periods after light is cut off (i.e. 50ms in American standard systems and 60ms in European systems) with a faceplate illumination of 2ft-candles and a total signal current of  $0.3\mu\text{A}$ .
13. Measured with a high gain, low noise, cascode type pre-amplifier having a bandwidth of 5.1MHz and a peak signal output current of  $0.35\mu\text{A}$ . The visual equivalent signal to noise ratio is taken as the ratio of the highlight signal output current to the r.m.s. noise current, multiplied by a factor of 3 (ref. Otto H. Schade, 'Electro-optical Characteristics of Television Systems; Introduction and Part 1 – Characteristics of Vision and Visual Systems', RCA Review, March 1948).
14. Maximum sensitivity operation.
15. Intermediate sensitivity operation.
16. Average sensitivity operation.
17. High light level operation.
18. For example, a scene brightness of approximately 430 ft-lamberts with lens aperture f/4 and a transmission of 75% produces 5 foot candles illumination on the faceplate.
19. The signal output current is the highlight signal electrode current during one frame after the dark current component has been subtracted. Signal currents higher than  $0.25\mu\text{A}$  may be used depending on requirements.
20. The signal electrode voltage for each tube is adjusted to that value which gives the desired operating signal current; the indicated range of signal electrode voltage for each operational condition is given to illustrate the variation normally encountered.
21. The deflecting circuits must provide extremely linear scanning for good black level reproduction under these conditions. Dark current is proportional to the scanning velocity. Any change in scanning velocity produces a black level error in direct proportion to the change in velocity of scanning.

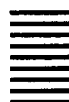

# TYPICAL SPECTRAL SENSITIVITY CHARACTERISTIC

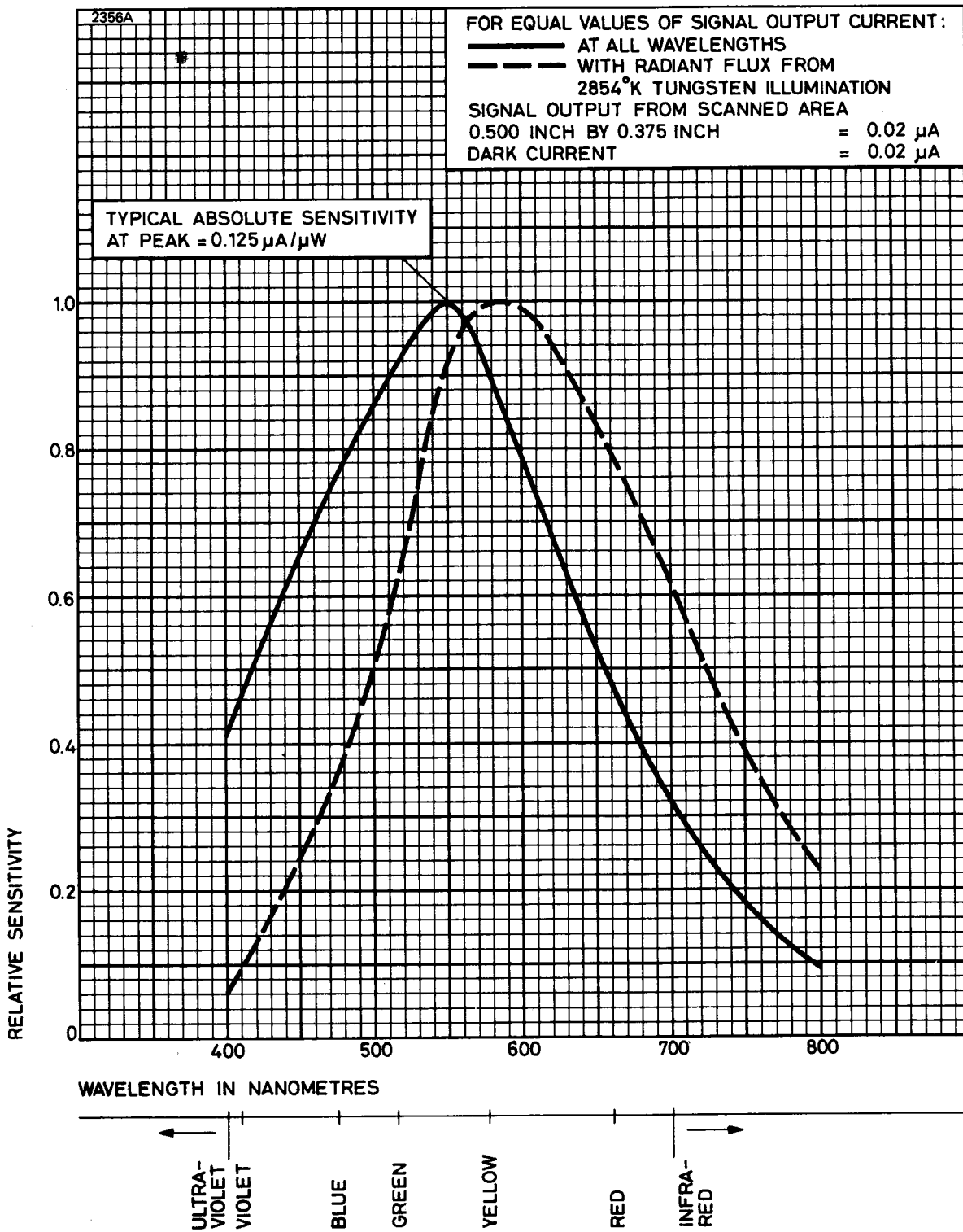



# TYPICAL RESOLUTION

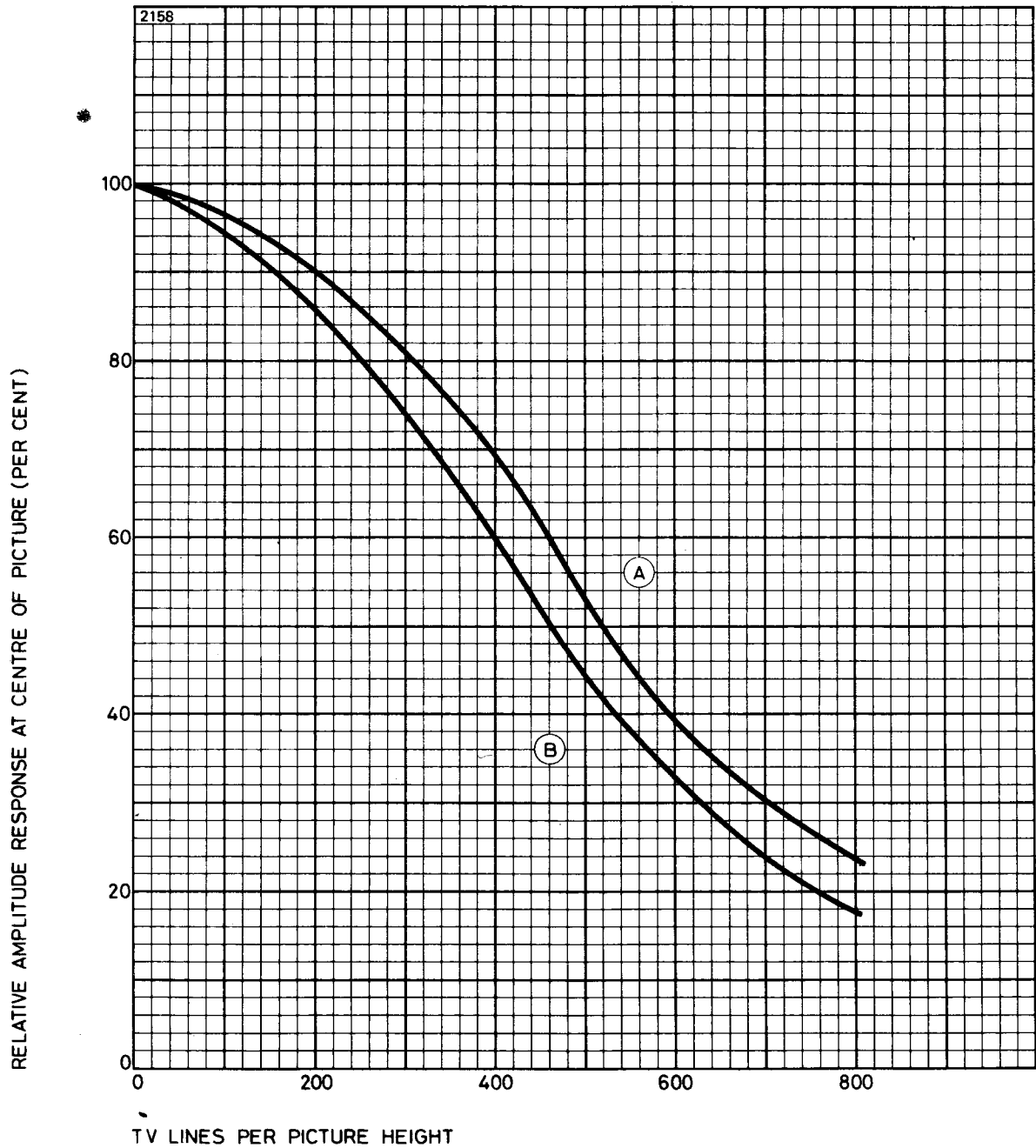

	<b>Curve A</b>	<b>Curve B</b>	
Grid 4 voltage . . . . .	750	500	V
Grid 3 voltage . . . . .	450	300	V
Focus field . . . . .	52	41	gauss
Highlight signal output current . . . . .	0.35	0.35	$\mu$ A
Dark current . . . . .	0.02	0.02	$\mu$ A
Test pattern . . . . .	square wave resolution wedge transparency		

Measured on a camera incorporating Cleveland Electronics deflection yoke VY-111-3, focusing coil VF-115-12 and alignment coil VA-118, the channel having a flat response and adequate bandwidth.

# TYPICAL LIGHT TRANSFER CHARACTERISTICS

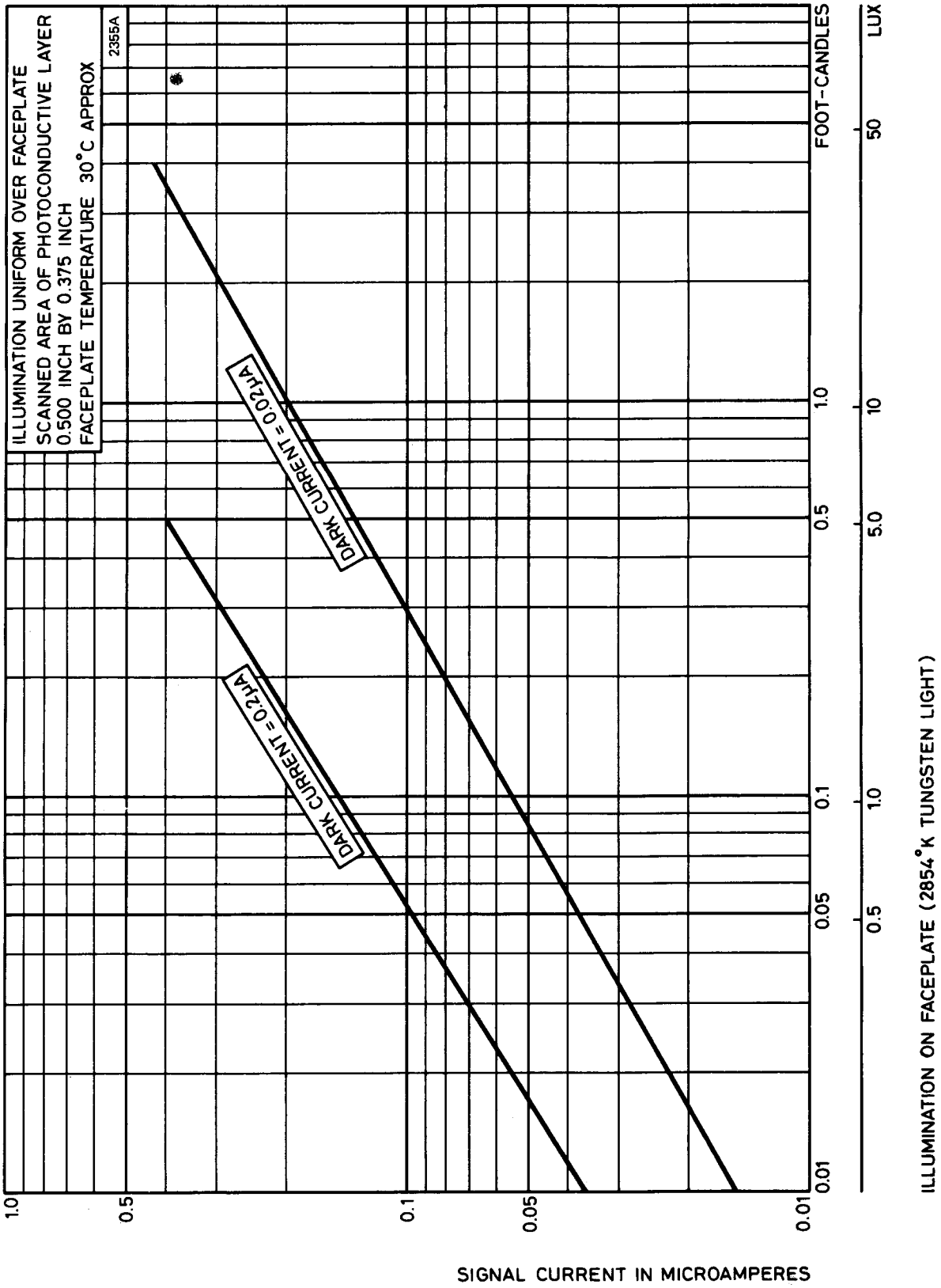

# TYPICAL RANGE OF DARK CURRENT

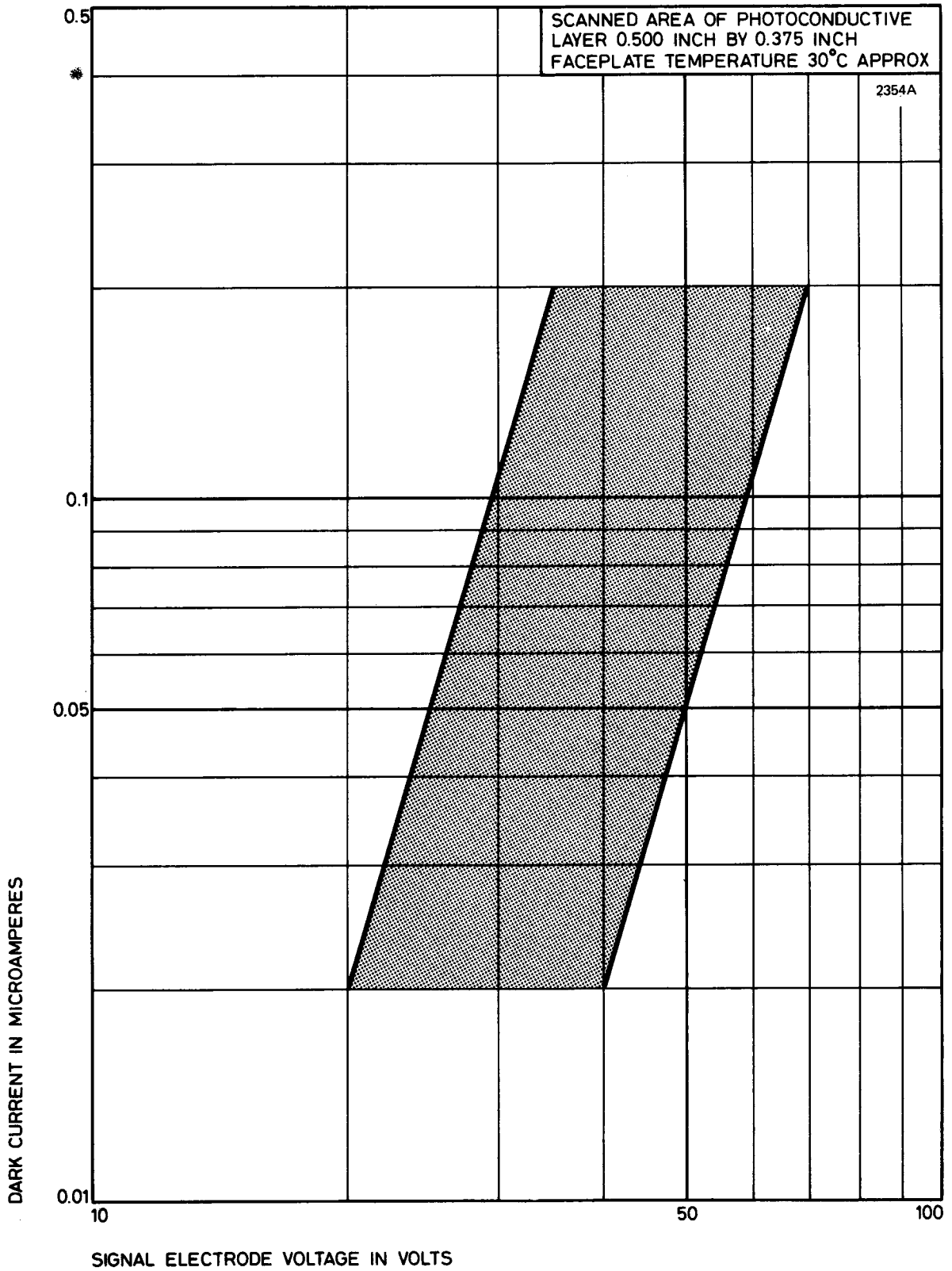

# OUTLINE (All dimensions without limits are nominal)

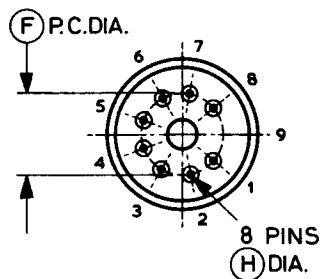
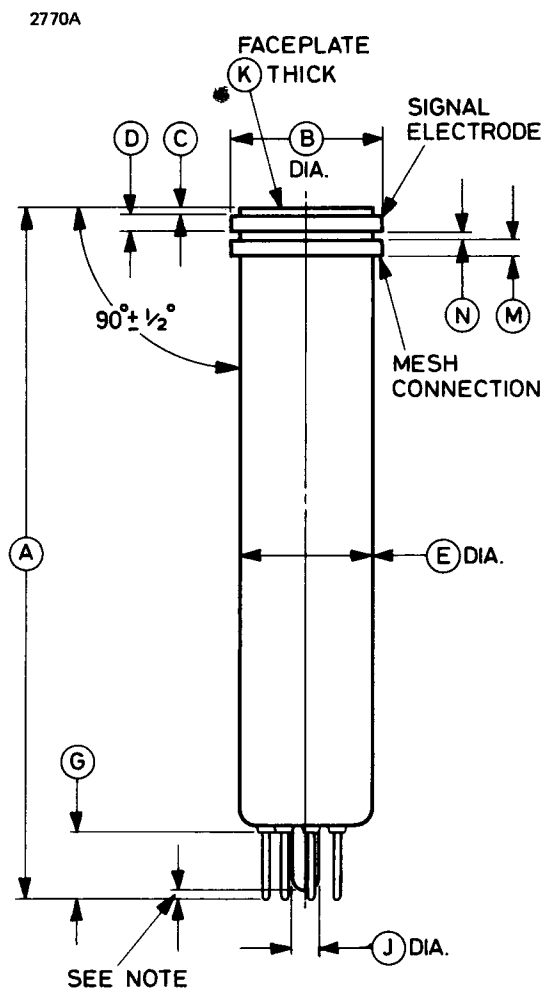

Pin	Element
1	Heater
2	Grid 1
3	No connection
4	Internal connection. Do not use
5	Grid 2
6	Grid 3 (beam focus)
7	Cathode
8	Heater
9	Key pin position, blank

**Note** The seal-off will not project beyond the pins.

Ref	Inches	Millimetres	Ref	Inches	Millimetres
A	5.120 ± 0.060	130.0 ± 1.5	G	0.503 max	12.78 max
B	1.125 ± 0.010	28.58 ± 0.25	H	0.050 + 0.002 - 0.004	1.270 + 0.051 - 0.102
C	0.050 max	1.27 max	J	0.265 max	6.73 max
D	0.125 ± 0.002	3.175 ± 0.051	K	0.093 ± 0.005	2.36 ± 0.13
E	1.020 + 0.030 - 0.035	25.91 + 0.76 - 0.89	M	0.125 ± 0.002	3.175 ± 0.051
F	0.600	15.24	N	0.050	1.27

Millimetre dimensions have been derived from inches.



---

This sheet should be read in conjunction with 8541A (P842) data.

### GENERAL

The P866 is a short 1-inch vidicon with separate mesh and low power heater. It is electrically and mechanically identical with the 8541A (P842) except for the following:—

#### Mechanical

Overall length . . . . . 5.180 inches (131.6mm) max

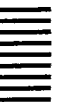



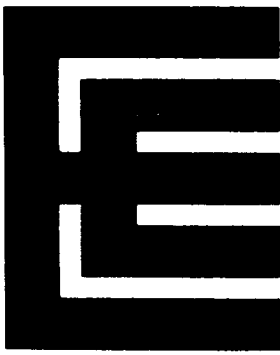

**INTRODUCTION**

A set of 1-inch diameter vidicons with electrostatic focus, intended for use in the chrominance channels of 4-tube colour cameras. They have low power heaters which operate at 0.6W (95mA).

**GENERAL DATA**

**Electrical**

Cathode . . . . .	indirectly heated, oxide coated
Heater voltage . . . . .	6.3 V
Heater current . . . . .	95 mA
Inter-electrode capacitance, signal electrode to all other electrodes (average value) (see note 1) . . . . .	5.0 pF
Spectral response . . . . .	see spectral sensitivity curve
Focusing method . . . . .	electrostatic
Deflection method . . . . .	magnetic
Alignment field, adjustable . . . . .	0 to 0.1mT (0 to 1 gauss)

**Mechanical**

Overall length . . . . .	6.380 inches (162.1mm) max
Overall diameter . . . . .	1.135 inches (28.9mm) max
Useful size of rectangular image . . . . .	0.192 x 0.256 inches max 4.88 x 6.50mm max
Orientation . . . . .	The horizontal scan should be parallel to the plane through the tube axis and the blank index pin position. The masking is for orientation only and does not define the proper scanned area.
Alignment coil location . . . . .	The centre of the alignment coil should be 4.94 inches (125mm) from the faceplate of the tube.



**(Continued on page 2)**

Net weight . . . . .	2.4 ounces (70g) approx
Mounting position (see note 2) . . . . .	any
Base . . . . .	small button ditetrar 8-pin (JEDEC no. E8-11)
Mating socket . . . . .	Type R41-79502 by United Carr Fasteners Ltd. (or equivalent)

**Storage**

Recommended store temperature . . . . . 15 to 35 °C  
 Tubes should be stored in darkness.

**WARNING**

When operating a tube the following precautions should be observed:

1. Ensure that the temperature of the tube is within its recommended range.
2. Avoid prolonged over exposure of stationary pictures, e.g. test patterns, or after-image may result.
3. It is advisable to incorporate a surge limiting device to ensure that the heater current does not exceed 150mA when switching on or at any other time.

**MAXIMUM AND MINIMUM RATINGS (Absolute values)**

No individual rating should be exceeded.

	Min	Max	
Heater voltage . . . . .	5.7	6.9	V
Signal electrode voltage . . . . .	—	100	V
Grid 6 and grid 3 voltage . . . . .	—	1200	V
Grid 5 voltage (see note 3) . . . . .	—	750	V
Grid 4 voltage . . . . .	—	400	V
Grid 2 voltage . . . . .	—	850	V
Grid 1 voltage:			
negative bias value . . . . .	—	300	V
positive bias value . . . . .	—	0	V
Blanking voltage, peak to peak (see note 4):			
when applied to grid 1 (negative pulses) . . . . .	40	—	V
when applied to cathode (positive pulses) . . . . .	10	—	V
Peak heater to cathode voltage:			
heater negative with respect to cathode . . . . .	—	125	V
heater positive with respect to cathode . . . . .	—	10	V
Dark current . . . . .	—	0.05	µA
Peak signal electrode current (see note 5) . . . . .	—	0.4	µA
Faceplate temperature . . . . .	—	71	°C
Peak illumination of faceplate (see note 6) . . . . .	—	1000	ft-candle



## TYPICAL OPERATION

### Typical Operating Conditions (for scanned area of 0.192 x 0.256 inch)

The following values and notes are for general guidance and may vary from tube to tube.

Grid 6 (decelerator) and grid 3 voltage (see note 7)	750	V
Grid 5 voltage (see note 3)	250 to 315	V
Grid 4 (beam focus) voltage	100 to 125	V
Grid 2 (accelerator) voltage	100 to 300	V
Grid 1 voltage	-20	V
Grid 1 voltage for picture cut-off (with no blanking voltage on grid 1)	-75 to -100	V
Blanking voltage, peak to peak:		
when applied to grid 1 (negative pulses)	75	V
when applied to cathode (positive pulses)	20	V
Alignment field, adjustable (see note 8)	0 to 0.1	mT
	0 to 1	gauss
Faceplate temperature (see note 9)	25 to 30	°C

### Typical Performance (see note 10)

	P893/4493 (Red)	P894/4494 (Green)	P895/4495 (Blue)	
Illumination, (highlights) (see note 11)	4.5	4.5	4.0	ft-candle
Signal output current (peak) (see note 12)	0.060	0.060	0.020	μA
Signal to dark current ratio	6:1	6:1	4:1	
Typical resolution:				
centre of picture	500	500	500	TV lines
corner	400	400	400	TV lines
Amplitude response (see note 13)	60	60	60	%
'Gamma' of transfer characteristic	0.65	0.65	0.65	
Lag (see note 14)	12	12	10	%



## NOTES

1. This capacitance, which in effect forms the output impedance of the tube, is increased when the tube is mounted in a deflecting yoke assembly. The resistive component of the output impedance is of the order of 100 megohms.
2. When the tube is subjected to vibration the mounting position should not be vertical with the base uppermost.
3. The voltage between grid 5 and grids 6 and 3 should not exceed 750V.
4. The blanking voltage required when applied to the cathode is less than that required when applied to grid 1 as the former reduces the potential difference between the cathode and the scanned side of the target.
5. The video amplifier must be designed to handle signal currents of this magnitude.
6. For 'white light' uniformly diffused over faceplate.
7. The resolution, uniformity of focus and picture quality decrease with decreasing grid 6 and grid 3 voltage and grid 5 voltage.
8. Use an approved deflection yoke and alignment coil such as Cleveland Electronics VYA-300. For the deflection yoke, the distance from the faceplate to the beginning of the winding is 0.75 inch approx. The alignment coil should be located so that its centre is 4.94 inches from the faceplate of the tube. Its axis should be coincident with the axis of the tube and the deflecting yoke.
9. Unless the temperature of the faceplate is maintained at a constant value within this range, the dark current and performance will drift from the optimum performance established on initial setting up.
10. Measured using the following filters:
  - for P893/4493 (red) — Wratten no. 25 (A) with two Fish-Shurman no. IR650
  - for P894/4494 (green) — Wratten no. 58 with 1 Fish-Shurman no. IR650
  - for P895/4495 (blue) — Wratten no. 47 with 1 Fish-Shurman no. IR650.
11. From a tungsten filament lamp with a lime-glass envelope, operated at a colour temperature of 3100°K. The illumination is measured on the lamp side of the filters given in note 10.

12. The signal output current is the highlight signal electrode current during one frame after the dark current component has been subtracted. Signal currents higher than  $0.060\mu\text{A}$  may be used depending on requirements.
13. Amplitude at 125 lines per picture height at the centre of the picture, relative to a large area black-white signal.
14. Percentage of initial value of signal output current remaining 3 field periods after light is cut off (i.e. 50ms in American standard systems and 60ms in European systems).

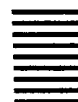

# OUTLINE

2535A

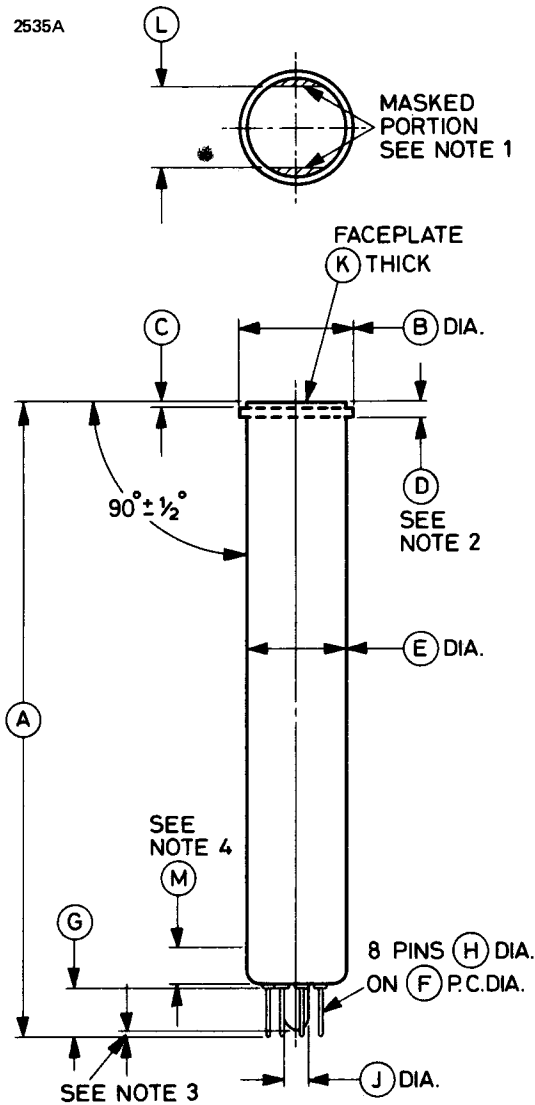

## NOTES

1. The straight sides are parallel to the plane passing through the tube axis and pin position 9.
2. Signal electrode contact flange may be located along the tube axis in any part of or all of the space between the dashed lines.
3. The seal-off will not project beyond the pins.
4. Over this length the diameter is N. A ring gauge P internal diameter and Q long will pass over the base and bulb to the signal electrode flange.

Ref	Inches	Millimetres	Ref	Inches	Millimetres
A	6.250 ± 0.125	158.8 ± 3.2	J	0.265 max	6.73 max
B	1.125 ± 0.010	28.58 ± 0.25	K	0.093 ± 0.005	2.36 ± 0.13
C	0.050 max	1.27 max	L	0.835 ± 0.035	21.21 ± 0.89
D	0.175	4.45	M	0.375	9.53
E	1.025 ± 0.003	26.035 ± 0.076	N	1.025 <sup>+0.003</sup> -0.030	26.035 <sup>+0.076</sup> -0.760
F	0.600	15.24	P	1.0280 <sup>+0.0011</sup> -0.0000	26.111 <sup>+0.028</sup> -0.000
G	0.503 max	12.78 max	Q	1.00	25.4
H	0.050 <sup>+0.002</sup> -0.004	1.270 <sup>+0.051</sup> -0.102			

Millimetre dimensions have been derived from inches.

## Base Connections

2536

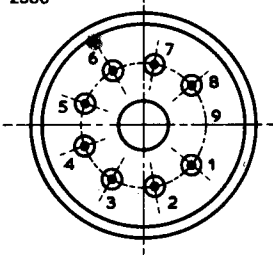

Pin	Element
1	Heater
2	Grid 1
3	Grid 4 (beam focus)
4	Grid 3 and grid 6
5	Grid 2
6	Grid 5
7	Cathode
8	Heater
9	Key pin position, blank
Flange	Signal electrode

## MAGNETIC SHIELDING

To obtain the most satisfactory performance, it will generally be necessary to provide magnetic shielding over the full length of the electrode structure. A suitable arrangement is shown below.

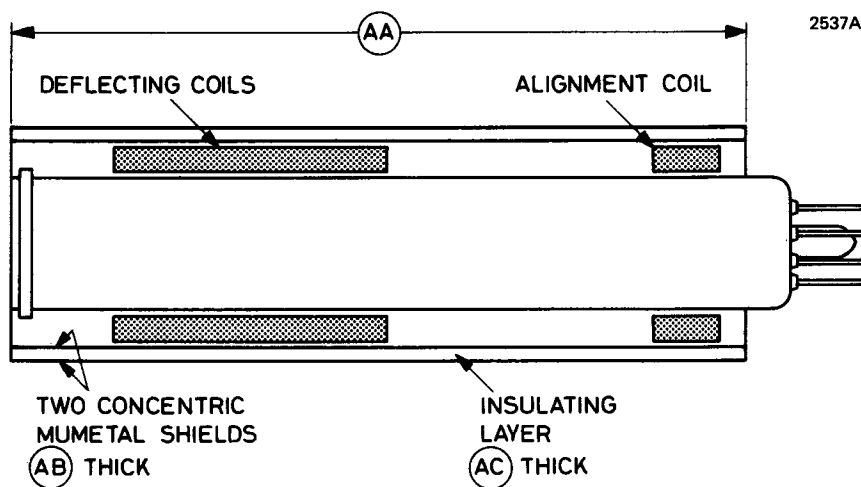

Ref	Inches	Millimetres
AA	5.375 nom	136.5 nom
AB	0.005	0.13
AC	0.062	1.57

Millimetre dimensions have been derived from inches.



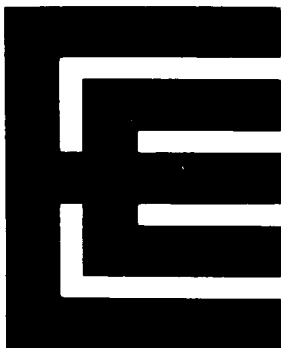

# P8018A P8018B

## VIDICON ASSEMBLY

---

### INTRODUCTION

The P8018A and P8018B are short, rugged, 1-inch separate mesh vidicons with permanently fitted focus and deflection coils. This results in very small overall dimensions and allows the vidicon and coils to be matched for optimum performance. The P8018A has the signal lead at the front of the coils; on the P8018B it is with the other leads at the rear of the coils.

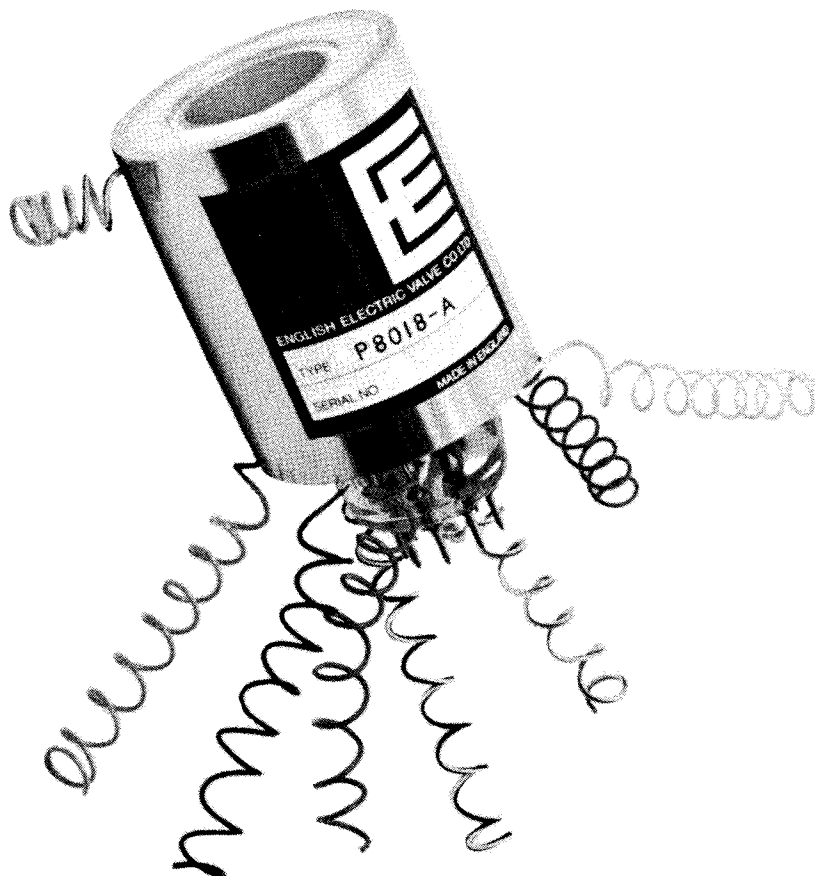

The small size and weight of this assembly, its robust construction and high performance, make it particularly suitable for guidance control and other airborne or space applications. The excellent resolution will be further enhanced by the use of a focus modulation waveform on grid 3. The resolution performance will match that of standard length vidicons.

Fibre-optic faceplate versions are available.

## GENERAL DATA

### Electrical

Cathode . . . . .	indirectly heated, oxide coated	
Heater voltage . . . . .	6.3	V
Heater current . . . . .	95	mA
Inter-electrode capacitance, signal electrode to all other electrodes (average value) (see note 1) . . . . .	5	pF
Spectral response . . . . .	see spectral sensitivity curve	
Focusing method . . . . .		magnetic
Deflection method . . . . .		magnetic
Alignment . . . . .		not required

### Mechanical

Overall length . . . . .	3.000 inches (76.20mm) nom
Overall diameter . . . . .	1.677 inches (42.60mm) max
Useful size of image, diagonal, centrally situated . . . . .	0.620 inch (15.75mm) max
Image orientation . . . . .	see page 14
Mounting position . . . . .	any
Base . . . . .	small button ditetrar 8-pin

### Yoke Characteristics

Focus coil resistance . . . . .	96	$\Omega$
Field coil inductance . . . . .	10	mH
Field coil resistance . . . . .	75	$\Omega$
Line coil inductance . . . . .	1	mH
Line coil resistance . . . . .	10	$\Omega$

### Storage

Tubes will withstand extended periods at up to 70°C.

Tubes should be stored in darkness.



## WARNING

When operating a tube the following precautions must be observed:

1. The temperature of the tube must be within its recommended range.
2. Excessive exposure to high levels of illumination must be avoided, otherwise permanent damage to the photoconductive surface may result.
3. The heater current must not exceed 150mA at any time.

## MAXIMUM AND MINIMUM RATINGS (Absolute values)

No individual rating to be exceeded.

	Min	Max	
Heater voltage . . . . .	5.7	6.9	V
Signal electrode voltage . . . . .	—	100	V
Grid 4 (mesh) voltage (see note 2) . . . . .	—	1000	V
Grid 3 (beam focus) voltage (see note 2) . . . . .	—	1000	V
Grid 2 (accelerator) voltage . . . . .	—	750	V
Grid 1 voltage:			
negative bias value . . . . .	—	300	V
positive bias value . . . . .	—	0	V
Blanking voltage, peak to peak (see note 3):			
when applied to grid 1 (negative pulses) . . . . .	40	—	V
when applied to cathode (positive pulses) . . . . .	20	—	V
Peak heater to cathode voltage:			
heater negative with respect to cathode . . . . .	—	125	V
heater positive with respect to cathode . . . . .	—	10	V
Dark current . . . . .	—	0.25	$\mu$ A
Peak signal electrode current (see note 4) . . . . .	—	0.55	$\mu$ A
Faceplate temperature . . . . .	—55	71	$^{\circ}$ C
Peak illumination of faceplate (see note 5) . . . . .	—	5000	ft-candle
	—	53 800	lux



## TYPICAL OPERATION

### Operating Conditions (for scanned area 0.5 x 0.375 inch)

The following values and notes are for general guidance and may vary from tube to tube.

Grid 4 (mesh) voltage (see note 2)	500	V
Grid 3 (beam focus) voltage (approx) (see notes 2 and 6)	300	V
Grid 2 (accelerator) voltage	300	V
Grid 1 voltage for picture cut-off (with no blanking voltage on grid 1)	-45 to -100	V
Blanking voltage, peak to peak:		
when applied to grid 1 (negative pulses)	75	V
when applied to cathode (positive pulses)	20	V
Faceplate temperature (see note 7)	30 to 35	°C
Focus coil current (see note 17)	150	mA
Focus coil dissipation	2.6	W
Field scan current (peak to peak)	85	mA
Line scan current (peak to peak)	450	mA

### Typical Performance

Limiting resolution (approx):		
at centre of picture	1200	TV lines
at corners of picture	600	TV lines
Amplitude response to a 400 TV line square wave test pattern at centre of picture (approx)	65	%
Lag (see note 8)	20	% max
'Gamma' of transfer characteristic for signal output between 0.02 and 0.2 $\mu$ A	0.5 to 0.6	
Visual equivalent signal to noise ratio (see note 9)	300:1	approx

#### Condition

1\*      2†      3‡

Faceplate illumination (highlights) (see note 13)	0.1	1.0	10	ft-candle
Typical signal output current (peak) (see note 14)	0.1	0.2	0.3	$\mu$ A
Approximate range of signal electrode voltage (see note 15)	30-60	20-40	10-22	V
Dark current (see note 16)	0.1	0.02	<0.02	$\mu$ A

\* See note 10

† See note 11

‡ See note 12

## SEQUENCE OF CAMERA ADJUSTMENTS

(For general operational conditions as shown on page 3)

- (a) Set the grid 1 voltage for the maximum negative bias for picture cut-off and apply the other voltages given under Typical Operating Conditions.
- (b) Check that the deflection circuits are functioning properly and adjust the scanning amplitude controls so that a maximum area of the photoconductive layer will be scanned.
- (c) Set the signal electrode voltage to give the signal current specified for the particular condition of operation. The table above gives an indication of the ranges of signal electrode voltage required for four conditions of operation. For other conditions of operation, reference should be made to the light transfer characteristic and the graph showing the range of signal electrode voltage to produce a given dark current and therefore a given sensitivity. It is preferable to adjust the dark current to the specified value for the particular condition of operation; P8018 tubes will have substantially identical performances when operated with identical values of dark current.

The magnitude of non-uniformities of dark current, as well as lag, tend to increase with signal electrode voltage; therefore operation at low values of signal electrode voltage helps to minimize these effects.

- (d) Decrease grid 1 voltage from its maximum negative value until a signal is produced.
- (e) Adjust grid 3 (beam focus) or grid 3 and grid 4 (mesh) voltages, the lens stop and the optical focus alternately to obtain the best focused picture with the peak signal output current specified under Typical Performance.
- (f) Adjust the lens aperture and signal electrode voltage to produce the desired output signal. Lag decreases with increase in illumination on the faceplate.
- (g) Adjust grid 1 (beam current) voltage to provide sufficient beam to just discharge the highlights.
- (h) Adjust the deflection amplitude and position to scan an area 0.500 inch x 0.375 inch.
- (j) Centre the raster in the useful area of the photoconductive layer.
- (k) If the picture is faint, even with adequate video gain, open the lens iris more and, if necessary, increase the signal electrode voltage.
- (l) Repeat steps (e) to (g) until optimum picture reproduction is obtained.



## NOTES

1. This capacitance, which in effect forms the output impedance of the tube, includes the capacitance of the deflecting yoke and focusing coil. The resistive component of the output impedance is of the order of 100 megohms.
2. Grid 3 and grid 4 voltages are adjusted for the best focus. The resolution, uniformity of focus and picture quality decrease with decreasing grid 3 and grid 4 voltage. In general grid 3 should be operated above 250 volts and be approximately 0.6 of grid 4 voltage.
3. The blanking voltage required when applied to the cathode is less than that required when applied to grid 1 as the former reduces the potential difference between the cathode and the scanned side of the target.
4. The video amplifier must be designed to handle signal currents of this magnitude, to avoid picture distortion due to overloading of the amplifier.
5. White light, uniformly diffused over faceplate.
6. It may be preferred to adjust beam focus by varying the focus coil current. If the focus coil field strength is fixed, beam focus may be obtained within a  $\pm 10\%$  range (approximately) of the grid 3 and grid 4 voltages. The ratio of 0.6 between grid 3 and grid 4 must be maintained as these voltages are varied.
7. Unless the temperature of the faceplate is maintained at a constant value within this range, the dark current and performance will drift from the optimum performance established on initial setting up.
8. Percentage of initial value of signal output current remaining 3 field periods after light is cut off (i.e. 50ms in American standard systems and 60ms in European systems), with a faceplate illumination of 2 foot-candles and a total signal current of  $0.3\mu\text{A}$ .
9. Measured with a high gain, low noise, cascode type pre-amplifier having a bandwidth of 5.1MHz and a peak signal output current of  $0.35\mu\text{A}$ . The visual equivalent signal to noise ratio is taken as the ratio of the highlight signal output current to the r.m.s. noise current, multiplied by a factor of 3 (ref. Otto H. Schade, *Electro-optical Characteristics of Television Systems; Introduction and Part 1 – Characteristics of Vision and Visual Systems'*, RCA Review, March 1948).
10. Maximum sensitivity operation.

11. Average sensitivity operation.
12. High light level operation.
13. For example, a scene brightness of approximately 170 ft-lamberts with lens aperture f/5.6 and a transmission of 75% produces 1.0 foot-candle illumination on the faceplate.
14. The signal output current is the highlight signal electrode current during one frame after the dark current component has been subtracted. Signal currents higher than  $0.3\mu\text{A}$  may be used depending on requirements.
15. The signal electrode voltage for each tube is adjusted to that value which gives the desired operating signal current; the indicated range of signal electrode voltage for each operational condition is given to illustrate the variation normally encountered.
16. The deflecting circuits must provide extremely linear scanning for good black level reproduction under these conditions. Dark current is proportional to the scanning velocity. Any change in scanning velocity produces a black level error in direct proportion to the change in velocity of scanning.
17. The focus and deflection currents are reduced when operating with lower voltages on grid 3 and grid 4. For example:

grid 4 voltage . . . . .	330	V
grid 3 voltage . . . . .	200	V
focus coil current . . . . .	125	mA
focus coil dissipation . . . . .	1.8	W
field scan current (peak to peak) . . . . .	70	mA
line scan current (peak to peak) . . . . .	375	mA



# TYPICAL SPECTRAL SENSITIVITY CHARACTERISTIC

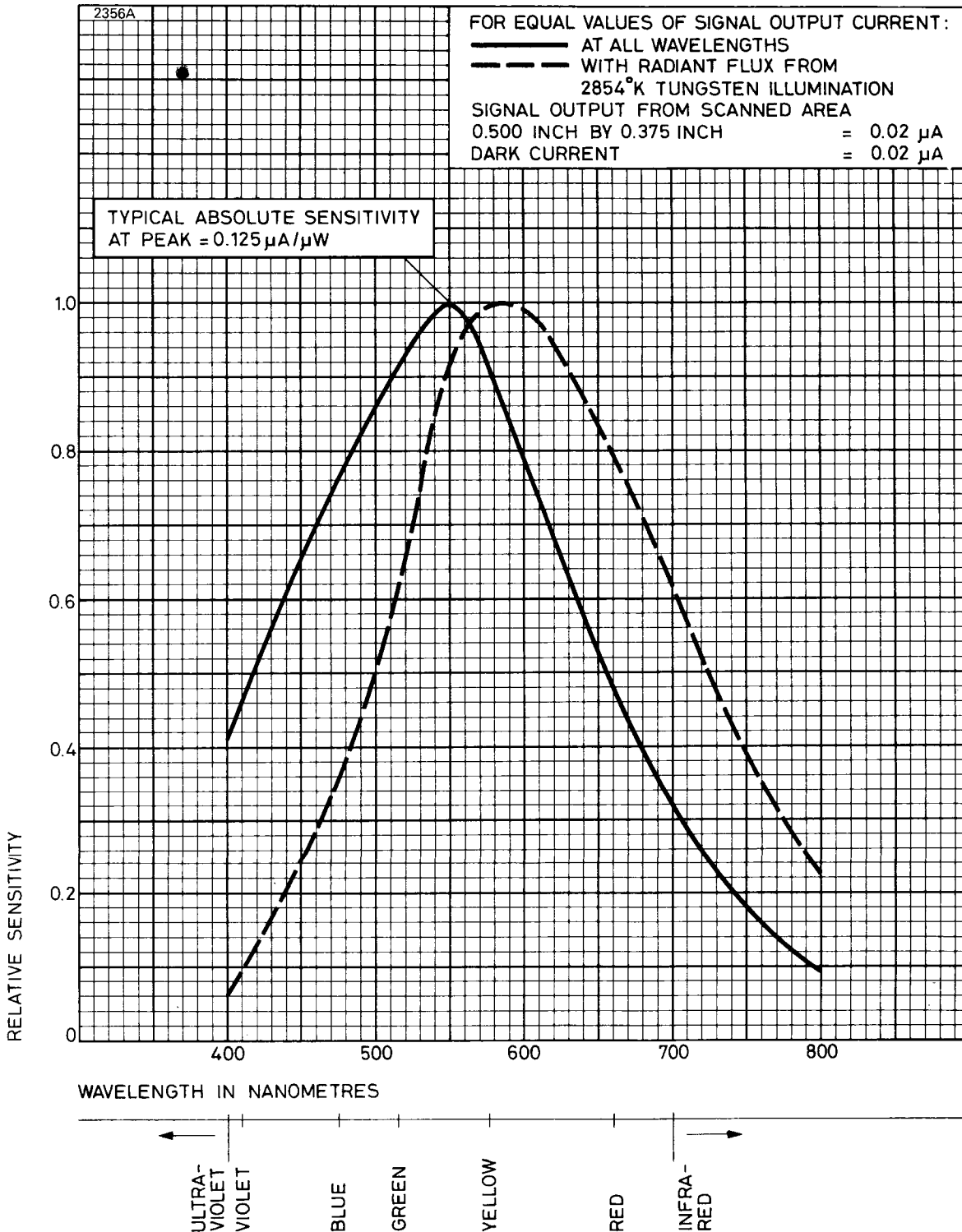

# TYPICAL RESOLUTION

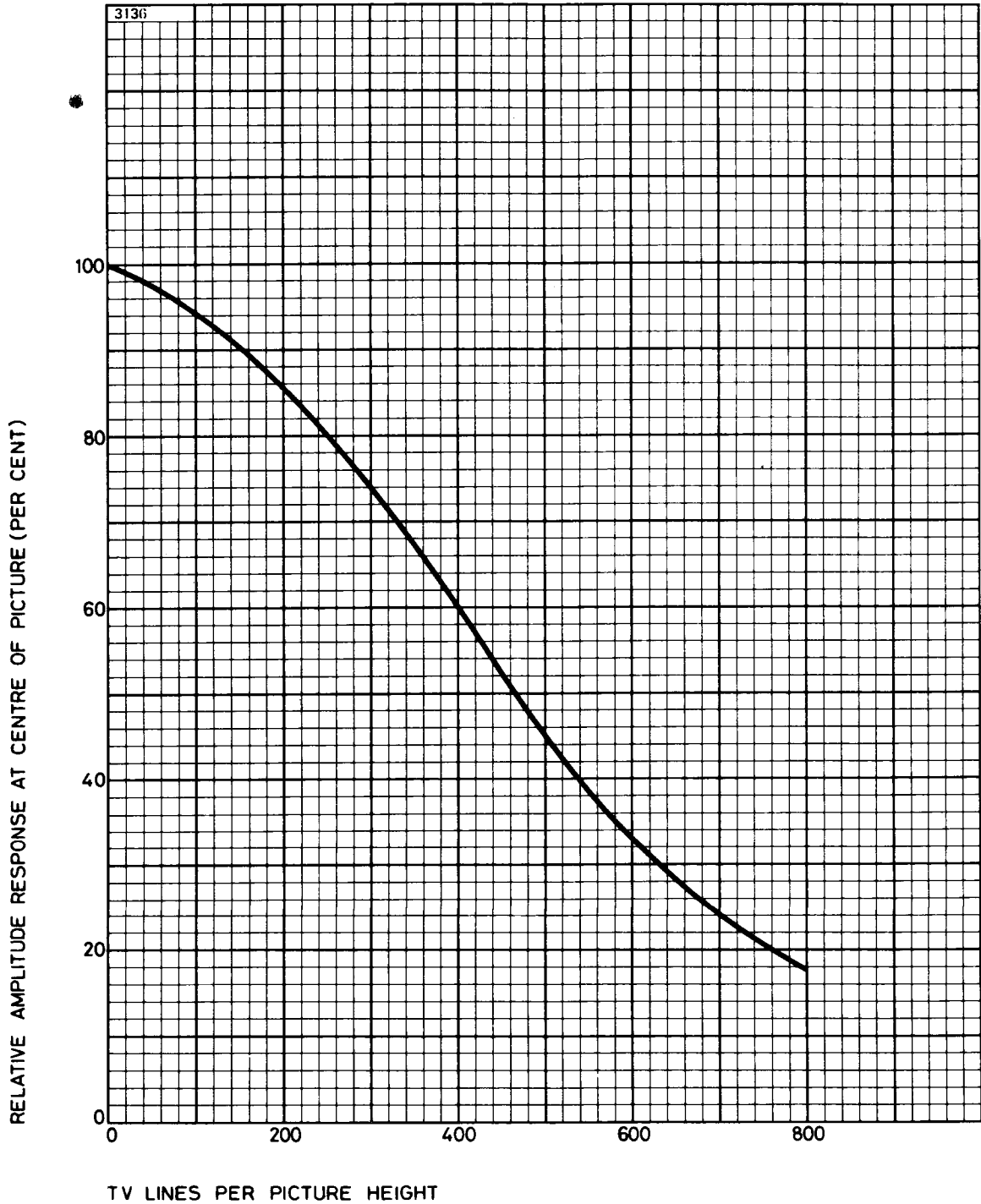

Grid 4 voltage	500	V
Grid 3 voltage	300	V
Highlight signal output current	0.35	$\mu$ A
Dark current	0.02	$\mu$ A
Test pattern	square wave resolution wedge transparency	

This information relates to a developmental device and is subject to change without notice. Please consult the Company regarding state of development and future manufacture before proceeding with equipment design.

# TYPICAL LIGHT TRANSFER CHARACTERISTICS

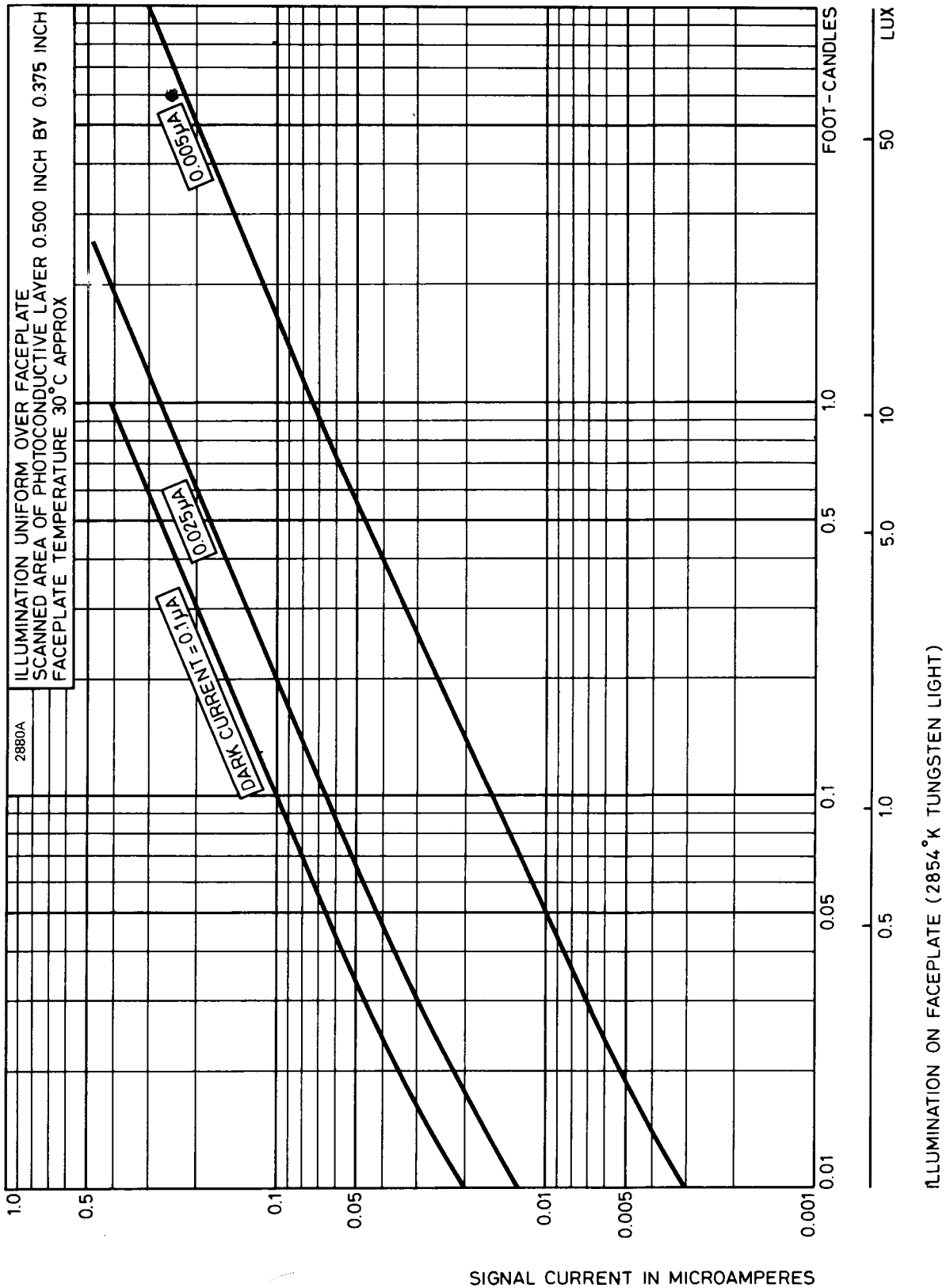



# TYPICAL RANGE OF DARK CURRENT

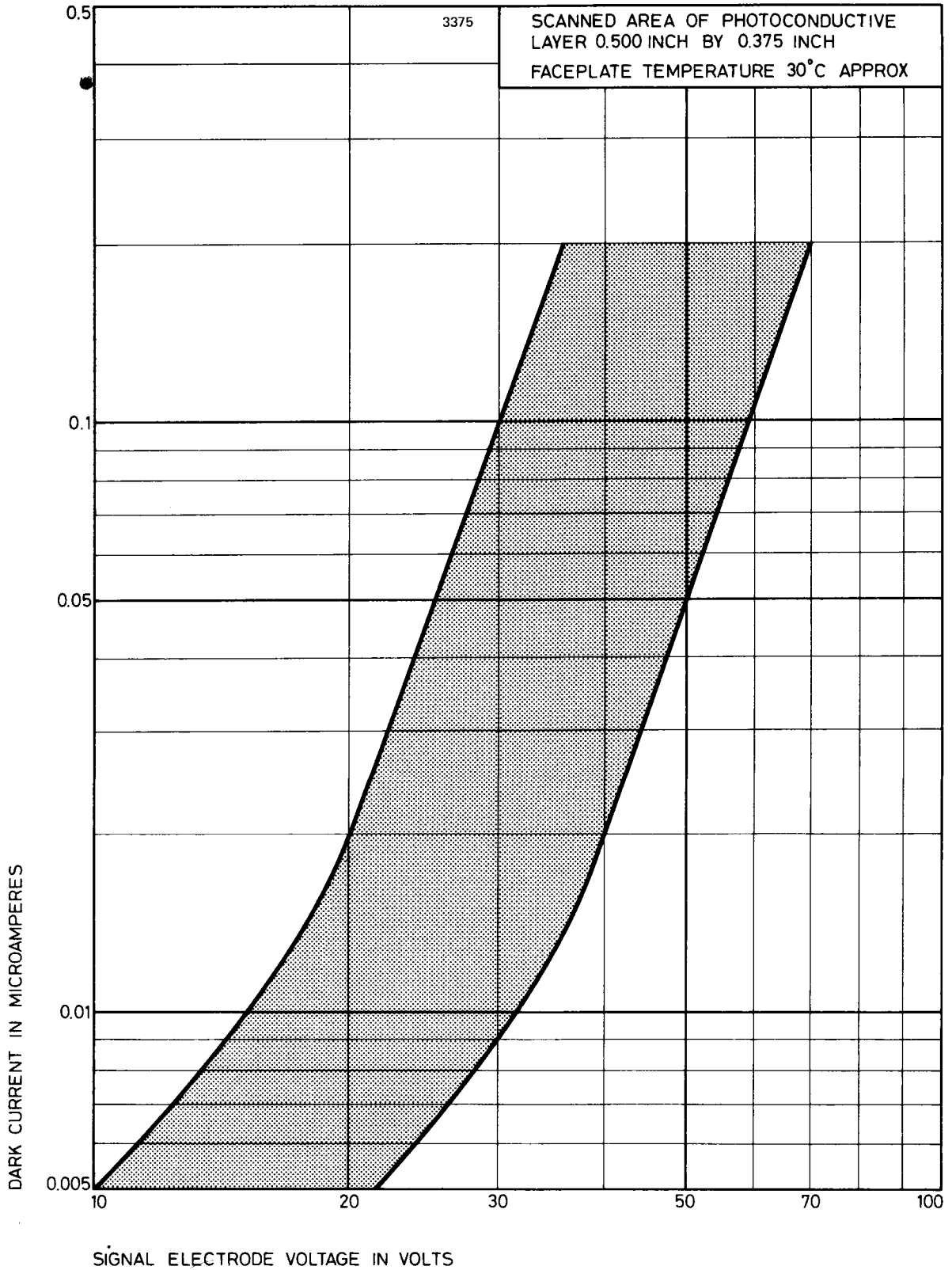

This information relates to a developmental device and is subject to change without notice. Please consult the Company regarding state of development and future manufacture before proceeding with equipment design.

P8018A,B, page 11

# TYPICAL LAG CHARACTERISTIC

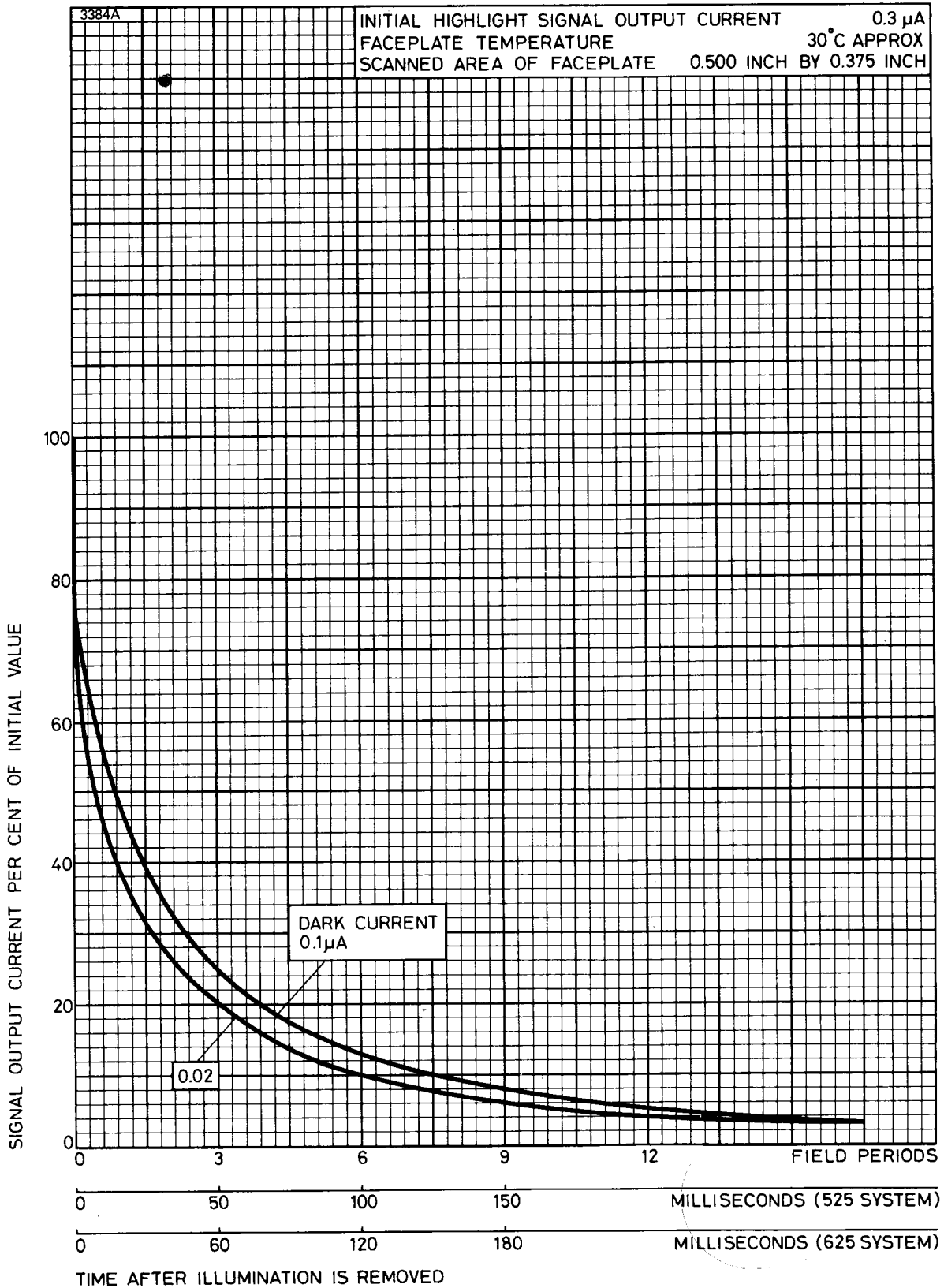

# OUTLINE (All dimensions without limits are nominal)

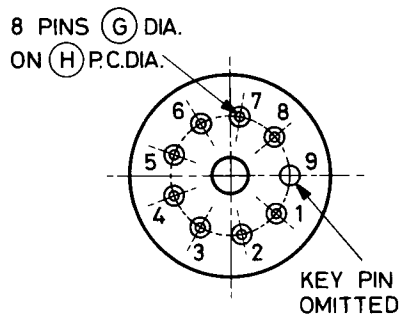
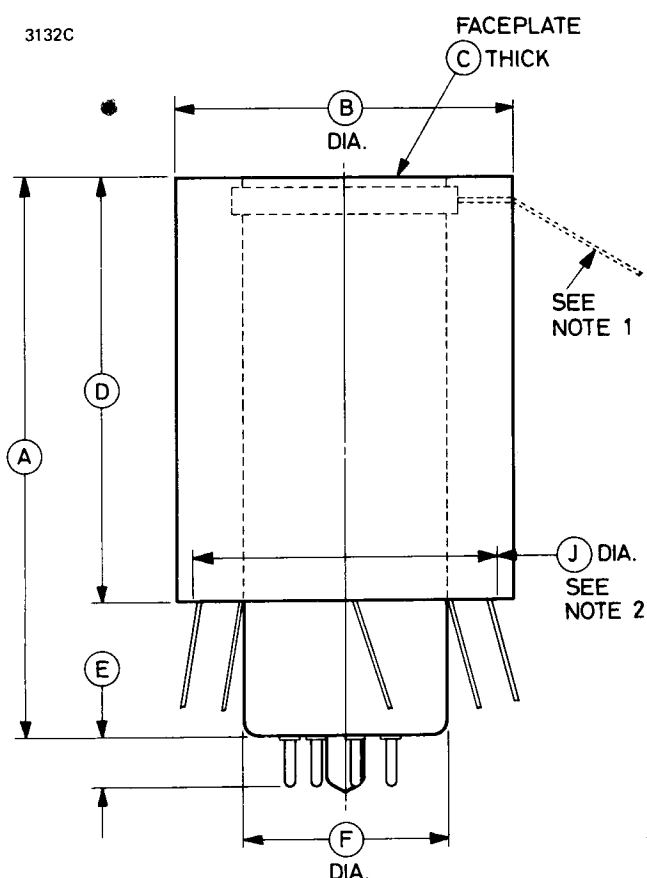

Detail of tube base (see page 14 for connections)

## Notes

1. Position of signal lead on P8018A.
2. The leads will lie within this diameter.

Ref	Inches	Millimetres
A	2.750 ± 0.050	69.85 ± 1.27
B*	1.673 ± 0.004	42.50 ± 0.10
C	0.093 ± 0.005	2.36 ± 0.13
D*	2.087 ± 0.005	53.00 ± 0.13
E	0.250 + 0.000 - 0.030	6.35 + 0.00 - 0.76
F	1.025 ± 0.003	26.035 ± 0.076
G	0.050 + 0.002 - 0.004	1.270 + 0.051 - 0.102
H	0.600	15.24
J*	1.260 min	32.0 min

Millimetre dimensions have been derived from inches except where indicated thus \*.

This information relates to a developmental device and is subject to change without notice. Please consult the Company regarding state of development and future manufacture before proceeding with equipment design.

## OUTLINE (View on base end)

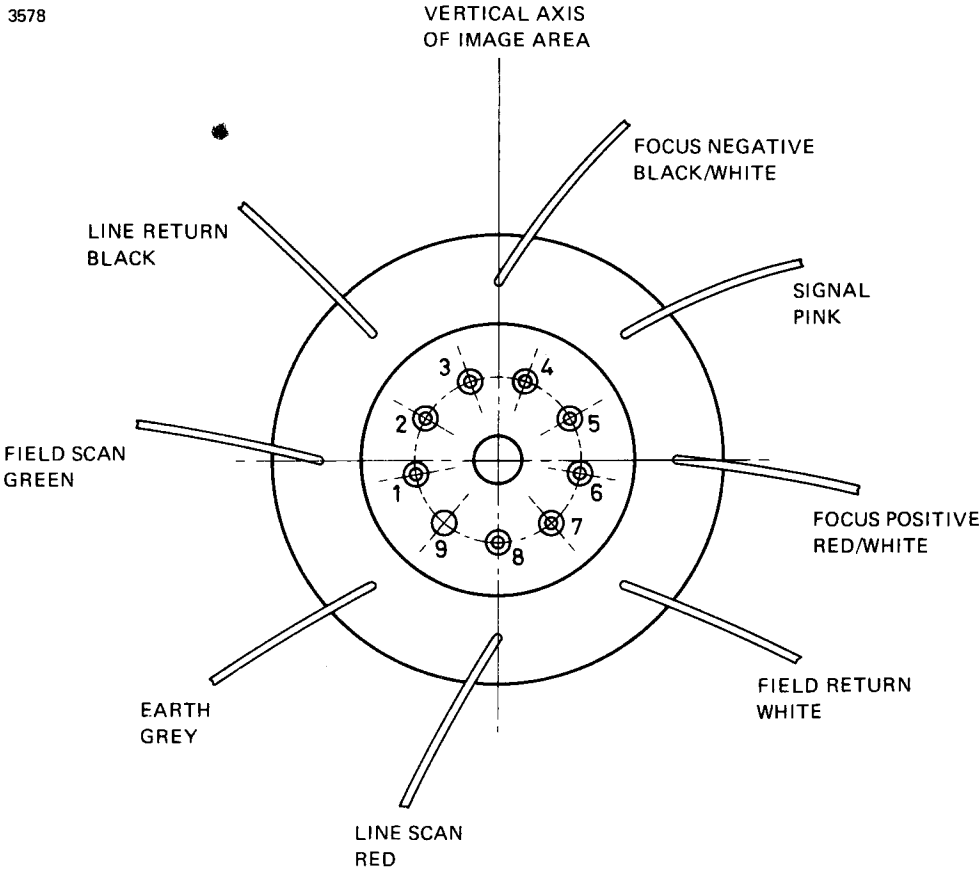

**Note** The P8018B is shown. On the P8018A the pink signal lead emerges from the front of the coils.

### Base Connections

Pin	Element
1	Heater
2	Grid 1
3	Grid 4 (mesh)
4	Internal connection
5	Grid 2
6	Grid 3 (beam focus)
7	Cathode
8	Heater
9	Key pin position, blank

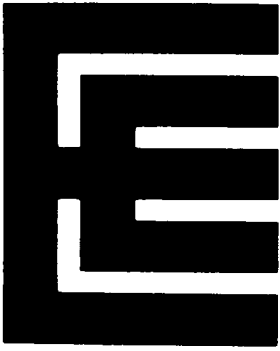

### INTRODUCTION

The P8034 is a 1-inch vidicon intended for slow scan operation. It has high sensitivity and operates satisfactorily at very low light levels in applications with limited motion in the scene. Magnetic deflection and focusing are used.

The tube is of integral mesh construction and incorporates a photoconductive surface with a long lag characteristic. This is a useful feature in applications where image retention for relatively long periods is required. The long lag gives between 40% and 60% of the initial signal output current after one scanning frame. For slow scan applications the lag can be controlled by applying a high-speed multi-frame erase cycle.

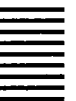
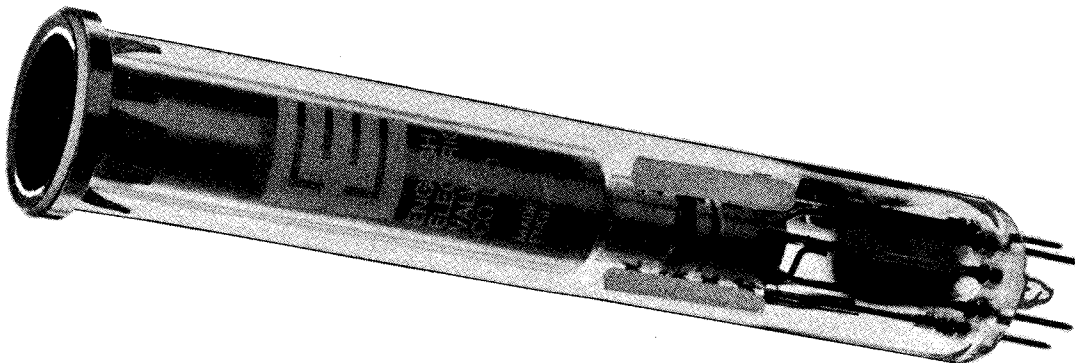

The signal storage capability of the P8034 is such that 90% of the initial signal current is available at the end of 10 seconds.

Limiting resolutions in the region of 600 TV lines may be obtained at the centre of the picture when operating at 300V and this may be increased to 700 TV lines at 750V.

Where P8034 is to be used in a standard vidicon camera, the target voltage range will require adjustment to accommodate the lower maximum target voltage of this tube. This is necessary to prevent picture polarity reversal and to optimize performance.

## GENERAL DATA

### Electrical

Cathode . . . . .	indirectly heated, oxide coated		
Heater voltage . . . . .	6.3	V	
Heater current . . . . .	0.6	A	
Inter-electrode capacitance, signal electrode to all other electrodes (average value) (see note 1) . . . . .	4.6	pF	
Spectral response . . . . .	see spectral sensitivity curve		
Focusing method . . . . .		magnetic	
Deflection method . . . . .		magnetic	

### Mechanical

Overall length . . . . .	6.375 inches (162mm) max		
Bulb diameter . . . . .	1.020 inches (25.91mm) nom		
Useful size of rectangular image; diagonal, centrally situated . . . . .	0.63 inches (15.9mm) max		
Orientation . . . . .		see note 2	
Net weight . . . . .	2 ounces (60g) approx		
Mounting position (see note 3) . . . . .		any	
Base . . . . .	small button ditetrar 8-pin (JEDEC no. E8-11)		

### Associated Components

Focusing coil (see note 4) . . . . .	Cleveland Electronics VF-115-5
Deflection yoke . . . . .	Cleveland Electronics VY-111-3
Alignment coil (see note 5) . . . . .	Cleveland Electronics VA-118
Mating socket . . . . .	Type R41-79502 by United Carr Fasteners Ltd. (or equivalent)

### Storage

Recommended store temperature . . . . .	15 to 35	°C
---	----------	----

Tubes are to be stored in darkness.

### WARNING

When operating a tube the following precautions are observed:

1. Ensure that the temperature of the tube is within its recommended range.
2. Avoid exposure to high levels of illumination otherwise permanent damage to the photoconductive surface may result.

## MAXIMUM AND MINIMUM RATINGS (Absolute values)

No individual rating to be exceeded.

	Min	Max	
Heater voltage . . . . .	5.7	6.9	V
Signal electrode voltage . . . . .	—	60	V
Grid 3 and grid 4 (beam focus) voltage (see note 6) . . . . .	—	750	V
Grid 2 (accelerator) voltage . . . . .	—	750	V
Grid 1 voltage:			
negative bias value . . . . .	—	300	V
positive bias value . . . . .	—	0	V
Blanking voltage, peak to peak (see note 7):			
when applied to grid 1 (negative pulses) .	40	—	V
when applied to cathode (positive pulses)	20	—	V
Peak heater to cathode voltage:			
heater negative with respect to cathode .	—	125	V
heater positive with respect to cathode .	—	10	V
Dark current . . . . .	—	0.10	$\mu$ A
Peak signal electrode current (see note 8) .	—	0.6	$\mu$ A
Peak illumination of faceplate . . . . .	—	1000	ft-candles
	—	10 760	lux
Temperature range:			
storage . . . . .	−20	+70	°C
operating . . . . .	−10	+55	°C



## TYPICAL OPERATION

### Operating Conditions (for scanned area of 0.5 x 0.375 inch)

The following values and notes are for general guidance and may vary from tube to tube.

	Low Voltage Operation	High Voltage Operation	
Grid 3 and grid 4 voltage (approx) (see notes 6 and 9) . . . . .	250 to 300	750	V
Grid 2 voltage . . . . .	300	300	V
Grid 1 voltage for picture cut-off (with no blanking voltage on grid 1) . . . . .	-45 to -100	-45 to -100	V
Blanking voltage, peak to peak:			
when applied to grid 1 (negative pulses) . . . . .	40	40	V
when applied to cathode (positive pulses) . . . . .	10	10	V
Field strength at centre of focusing coil (see notes 4 and 9) . . . . .	40 4.0	60 6.0	gauss mT
Peak deflection coil currents (approx):			
horizontal . . . . .	185	375	mA
vertical . . . . .	25	43	mA
Alignment field, adjustable (see note 10)	0 to 4 0 to 0.4	0 to 4 0 to 0.4	gauss mT
Faceplate temperature (see note 11) . . . . .	30 to 35	30 to 35	°C

### Typical Performance — Standard TV Scan Rates

	Low Voltage Operation	High Voltage Operation	
Limiting resolution at centre of picture (approx) . . . . .	600	700 TV lines	
Amplitude response to a 400 TV line square wave test pattern at centre of picture (approx) . . . . .	20	30	%
Lag (see note 12) . . . . .		55	%
'Gamma' of transfer characteristic for signal output between 0.02 and 0.2 $\mu$ A . . . . .		0.7	
Visual equivalent signal to noise ratio (see note 13) . . . . .		300:1	approx



**Typical Performance — Standard TV Scan Rates (continued)**

	Condition		
	1*	2†	
Faceplate illumination (highlights)	1.0	0.1	ft-candle
	10.8	1.1	lux
Signal output current (peak) (see note 16)	0.4	0.16	μA
Approximate range of signal electrode voltage (see note 17)	7 to 25	15 to 45	V
Dark current (see note 18)	0.005	0.02	μA

\* See note 14                      † See note 15

**Typical Performance — Slow Scan Rates**

Signal electrode voltage	30	V
Dark current	8.0	nA
Exposure	0.25	ft-candle-sec
	2.7	lux-sec
Signal output current:		
frame time 1s	160	nA
frame time 2s	70	nA
frame time 4s	30	nA
frame time 6s	19	nA
frame time 10s	10	nA
Lag (see note 19)	5 to 10	frames
Amplitude response to 400 TV lines	50	%
Signal storage time (see note 20)	80	s



**SEQUENCE OF CAMERA ADJUSTMENTS**

**(For general operational conditions as shown on page 4)**

- (a) Set the grid 1 voltage for the maximum negative bias for picture cut-off and apply the other voltages given under Typical Operating Conditions.
- (b) Check that the deflection circuits are functioning properly and adjust the scanning amplitude controls so that a maximum area of the photoconductive layer will be scanned.
- (c) Set the signal electrode voltage to give the signal current specified for the particular condition of operation. The table above gives an indica-

tion of the ranges of signal electrode voltage required for two conditions of operation. For other conditions of operation, reference should be made to the light transfer characteristic and the graph showing the range of signal electrode voltage to produce a given dark current and therefore a given sensitivity. It is preferable, if possible, to adjust the dark current to the specified value for the particular condition of operation; P8034 tubes will have substantially identical performances when operated with identical values of dark current.

The magnitude of non-uniformities of dark current, as well as lag, tend to increase with signal electrode voltage; therefore operation at low values of signal electrode voltage helps to minimize these effects.

- (d) Decrease grid 1 voltage from its maximum negative value until a signal is produced.
- (e) Adjust grid 3 and grid 4 voltage, the lens stop and the optical focus alternately to obtain the best focused picture with the peak signal output current specified under Typical Performance.
- (f) Adjust the lens aperture and signal electrode voltage to produce the desired output signal. Lag decreases with increase in illumination on the faceplate.
- (g) Adjust the alignment field so that the centre of the picture does not move as grid 3 and grid 4 voltage is rocked slightly. Adjust grid 1 (beam current) voltage to provide just sufficient beam to discharge the highlights. It is permissible to set the alignment fields slightly off the minimum movement position to maintain signal uniformity.
- (h) Adjust the deflection amplitude and position to scan an area 0.500 inch x 0.375 inch. This is facilitated by the use of a perspex mask inscribed with circles 0.500 inch and 0.375 inch diameter, placed in contact and concentric with the faceplate of the tube. Light is allowed to fall on the photoconductive layer and an image of the rings is obtained on the monitor. No lens is necessary. The scan amplitude and centring controls are adjusted until the diameter of the larger circle is equal to the width of the raster and that of the smaller equal to the height.
- (j) Centre the raster in the useful area of the photoconductive layer and check the alignment (step g).
- (k) If the picture is faint, even with adequate video gain, open the lens iris more and, if necessary, increase the signal electrode voltage.
- (l) Repeat steps (e) to (g) until optimum picture reproduction is obtained.

## NOTES

1. This capacitance, which in effect forms the output impedance of the tube, is increased when the tube is mounted in a deflecting yoke and focusing coil assembly. The resistive component of the output impedance is of the order of 100 megohms.
2. The horizontal scan must be parallel to the plane passing through the tube axis and the blank key-pin position. The masking is for orientation only and does not define the proper scanned area.
3. When the tube is subjected to vibration the mounting position must not be vertical with the base uppermost.
4. The direction of the focusing current is such that a north pole is attracted to the image end of the focusing coil. The distance from the faceplate to the beginning of the winding is 0.75 inch approximately.
5. The alignment coil is located to the rear of the focusing coil directly over the electron gun. It is positioned so that its centre is 3.69 inches from the faceplate of the tube and its axis is coincident with the axis of the tube, the deflecting yoke and the focusing coil.
6. Grid 3 and grid 4 voltage is adjusted for the best focus. The resolution, uniformity of focus and picture quality decrease with decreasing grid 3 and grid 4 voltage. In general grid 3 and grid 4 are operated above 250 volts.
7. The blanking voltage required when applied to the cathode is less than that required when applied to grid 1 as the former reduces the potential difference between the cathode and the scanned side of the target.
8. The video amplifier must be designed to handle signal currents of this magnitude, to avoid picture distortion due to overloading of the amplifier.
9. It may be preferred to adjust beam focus by varying the focus coil current to obtain the field strengths indicated in the Typical Operating Conditions. If the focus coil field strength is fixed, beam focus may be obtained within a  $\pm 10\%$  range (approximately) of the grid 3 and grid 4 voltage.



10. Adjust the current through the alignment coils until the centre of the test pattern does not move as grid 3 and grid 4 voltages or the focus coil current are varied in and out of focus.
11. Unless the temperature of the faceplate is maintained at a constant value within this range, the dark current and performance will drift from the optimum performance established on initial setting up.
12. Percentage of initial value of signal output current remaining 3 field periods after light is cut off (i.e. 50ms in American standard systems and 60ms in European systems), with an initial highlight signal current of  $0.3\mu\text{A}$  and a dark current of  $0.02\mu\text{A}$ .
13. Measured with a high gain, low noise, cascode type pre-amplifier having a bandwidth of 5.1MHz and a peak signal output current of  $0.35\mu\text{A}$ . The visual equivalent signal to noise ratio is taken as the ratio of the highlight signal output current to the r.m.s. noise current, multiplied by a factor of 3 (ref. Otto H. Schade, *Electro-optical Characteristics of Television Systems; Introduction and Part 1 – Characteristics of Vision and Visual Systems*, RCA Review, March 1948).
14. Average light level operation.
15. Low light level operation.
16. The signal output current is the highlight signal electrode current during one frame after the dark current component has been subtracted.
17. The signal electrode voltage for each tube is adjusted to that value which gives the desired operating signal current; the indicated range of signal electrode voltage for each operational condition is given to illustrate the variation normally encountered.
18. The deflecting circuits must provide extremely linear scanning for good black level reproduction under these conditions. Dark current is proportional to the scanning velocity. Any change in scanning velocity produces a black level error in direct proportion to the change in velocity of scanning.
19. The time for the residual signal to reach 5% of its original value.
20. The time for the signal to decay to 50% of its original value.

# TYPICAL SPECTRAL SENSITIVITY CHARACTERISTIC

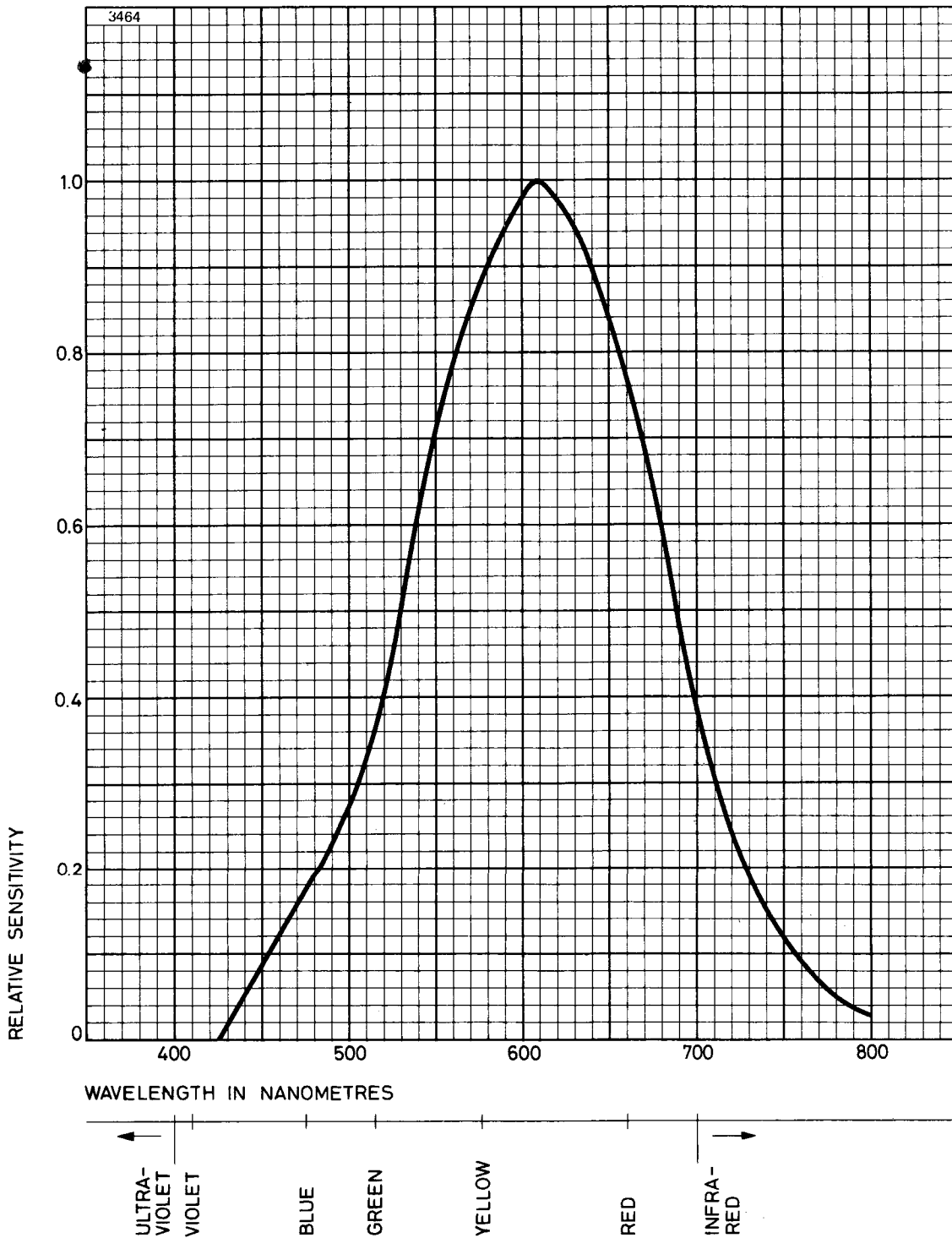

# TYPICAL RESOLUTION (STANDARD TV SCAN RATE)

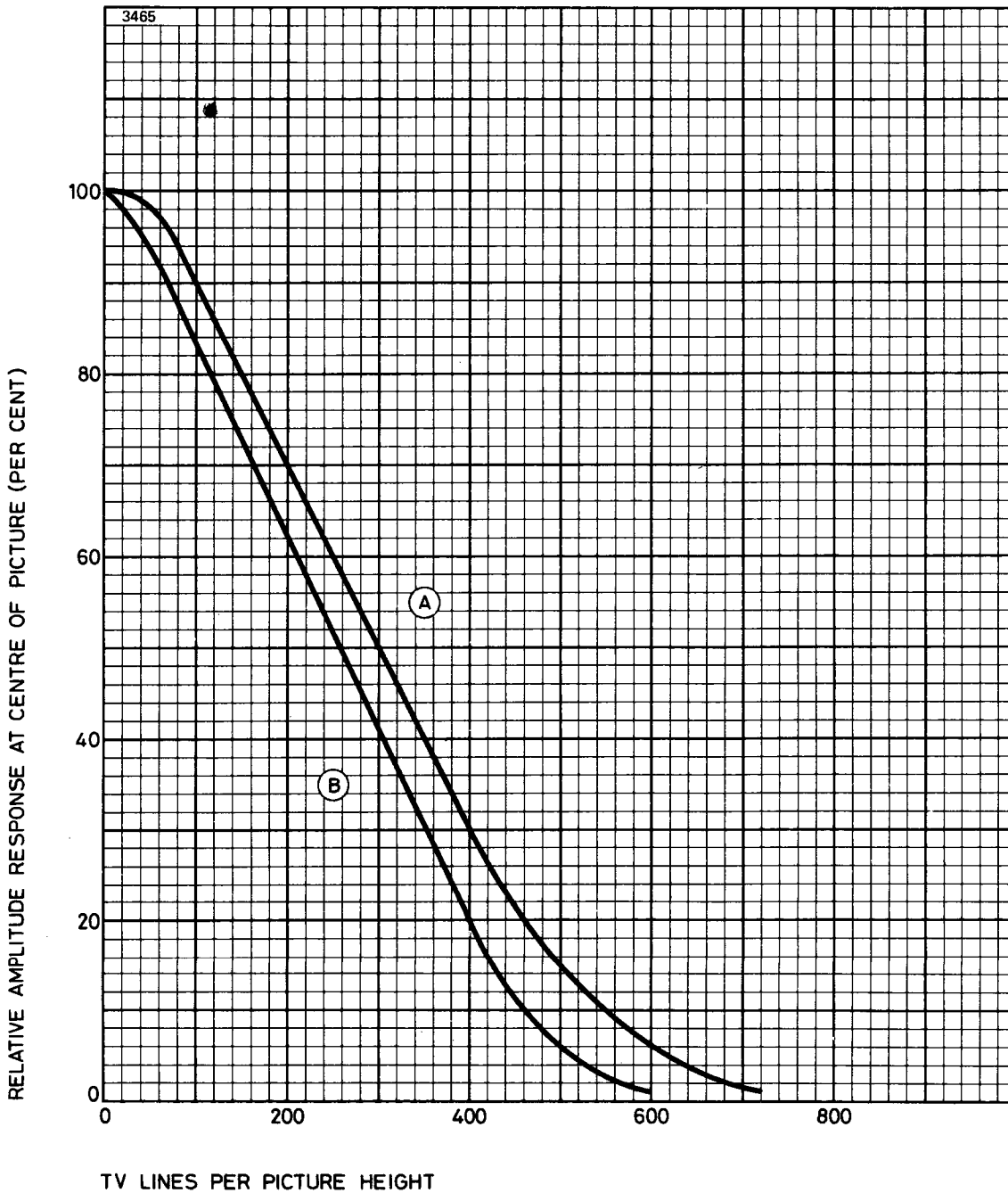

Highlight signal electrode current	. . . . .	0.30	$\mu$ A
Dark current	. . . . .	0.02	$\mu$ A
Test pattern	. . . . .	square wave resolution wedge transparency	
Video amplifier response	. . . . .		flat
Curve A	. . . . .	grid 3 and grid 4 at 750V	
Curve B	. . . . .	grid 3 and grid 4 at 300V	

# TYPICAL LIGHT TRANSFER CHARACTERISTICS STANDARD TV SCAN RATE

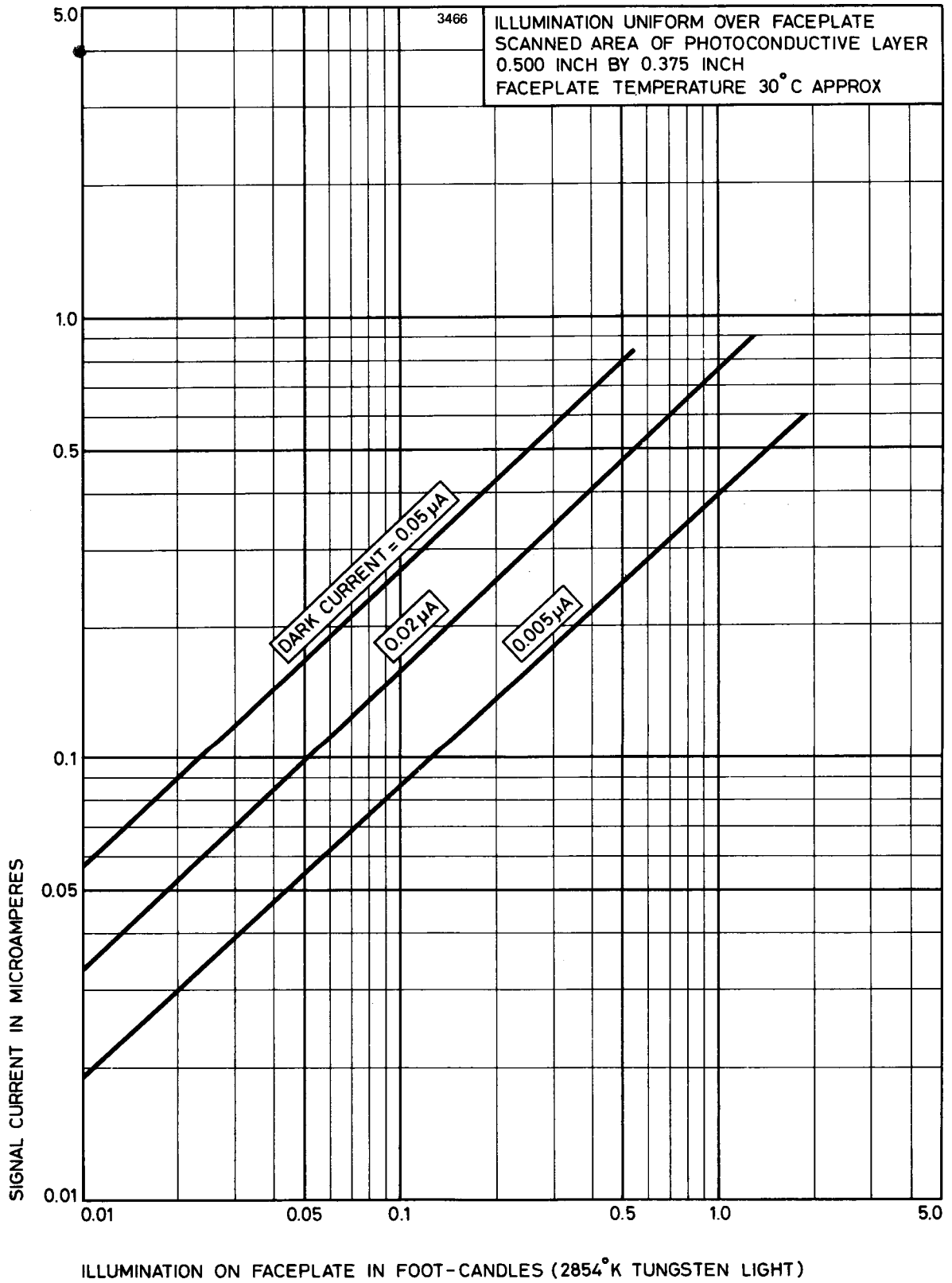

# TYPICAL RANGE OF DARK CURRENT STANDARD TV SCAN RATE

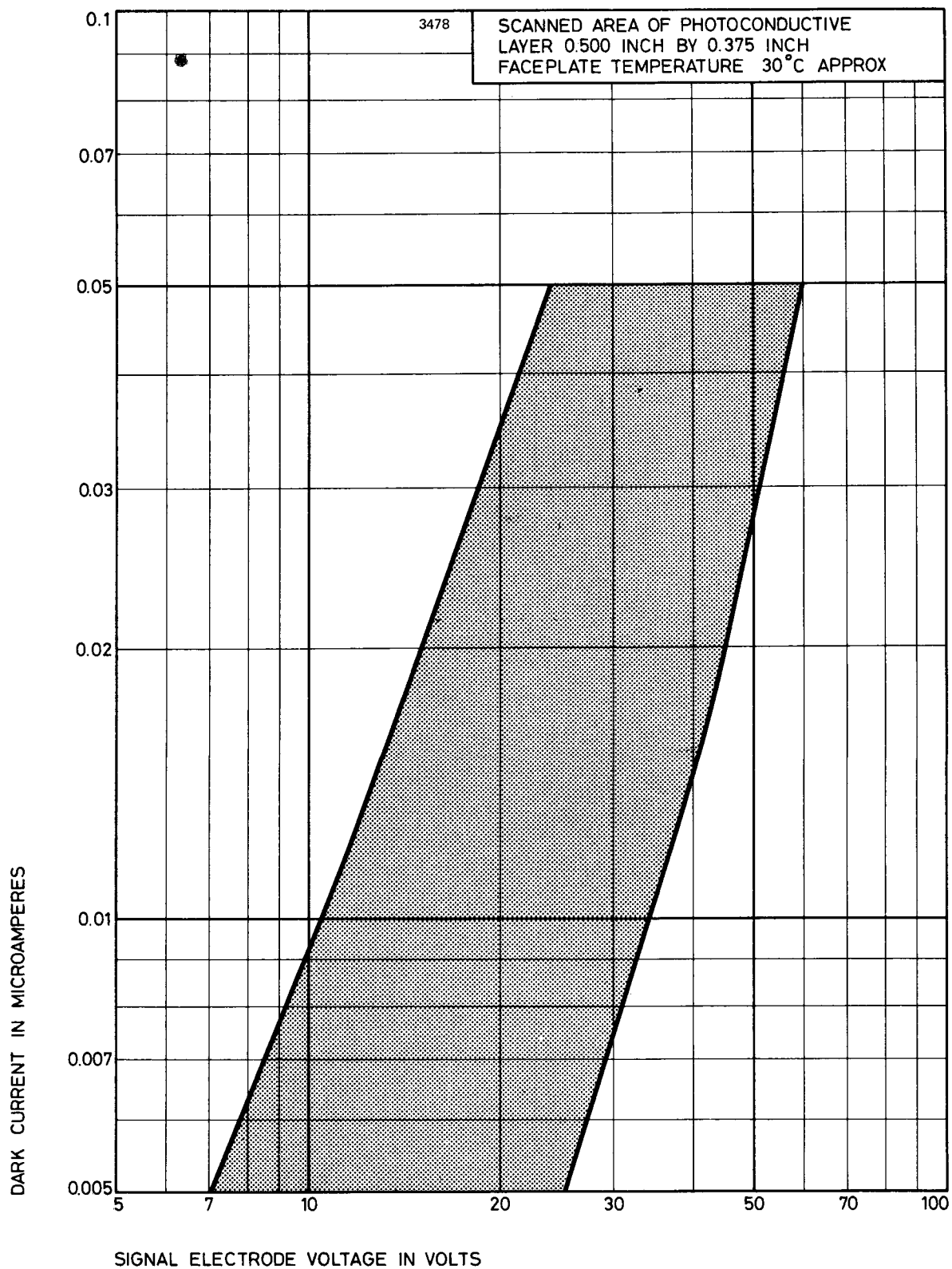



# TYPICAL LAG CHARACTERISTICS STANDARD TV SCAN RATE

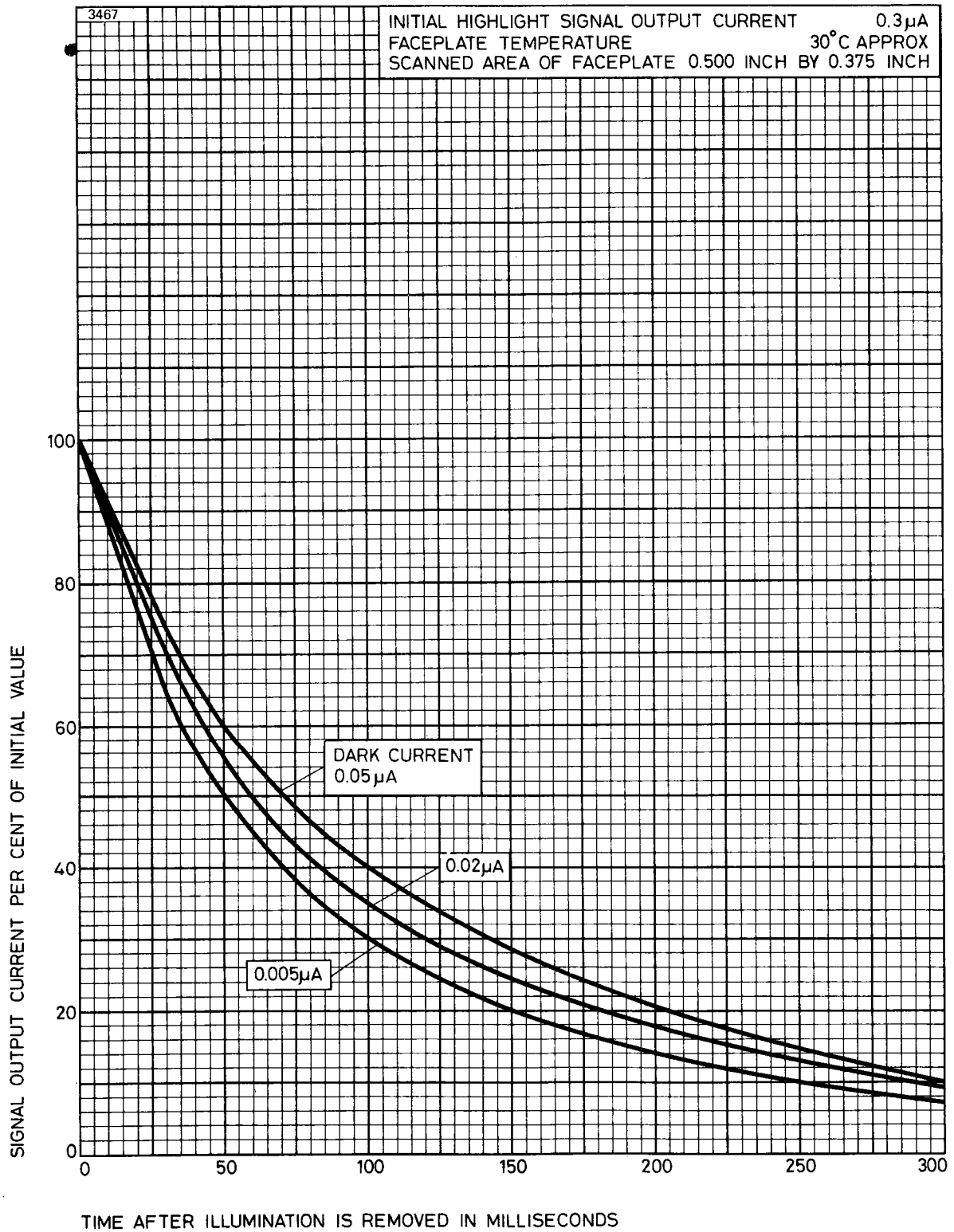

# TYPICAL STORAGE CHARACTERISTICS SLOW SCAN RATES

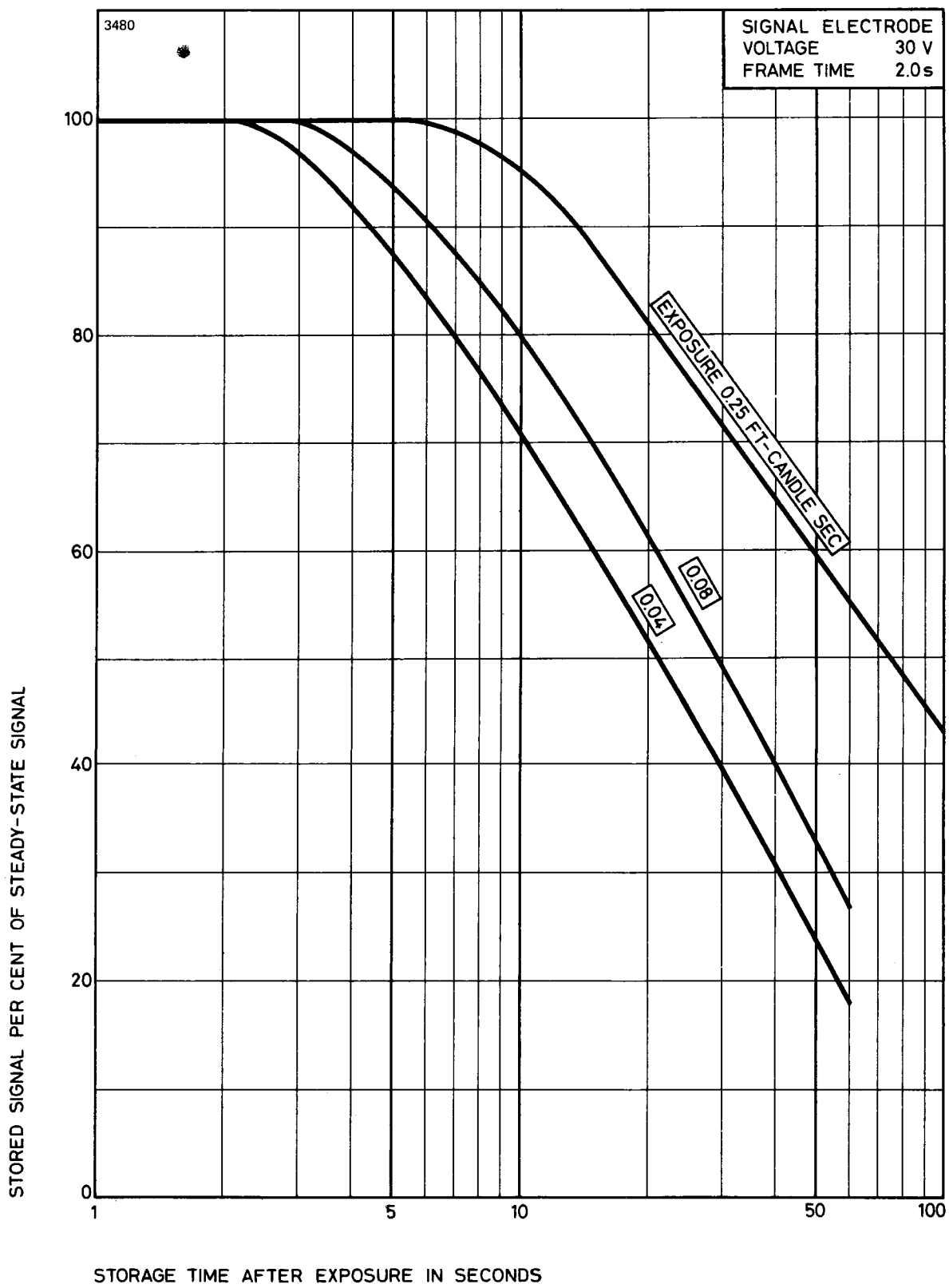

# TYPICAL LAG CHARACTERISTICS SLOW SCAN RATES

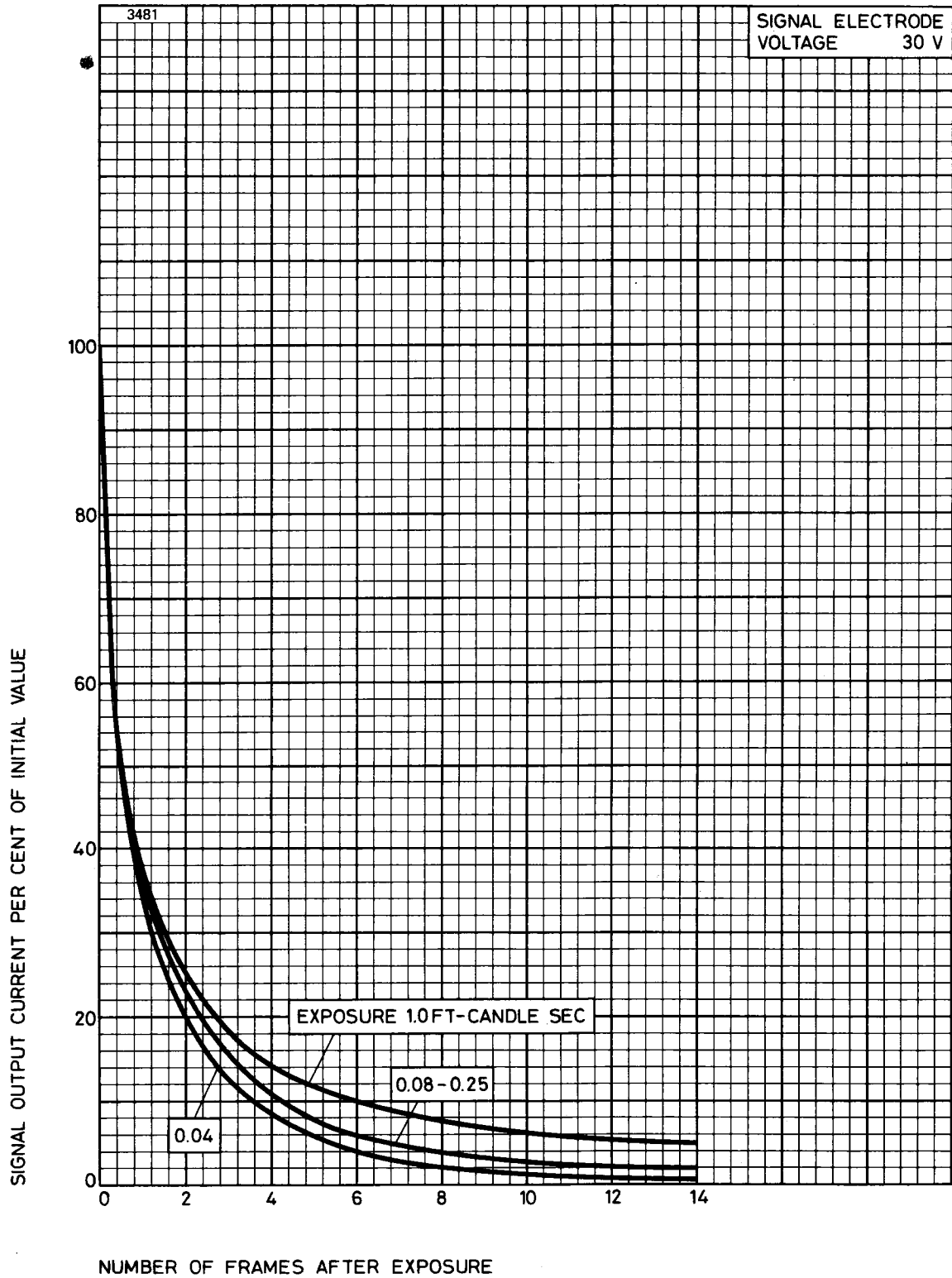

# TYPICAL RESOLUTION CHARACTERISTICS SLOW SCAN RATES

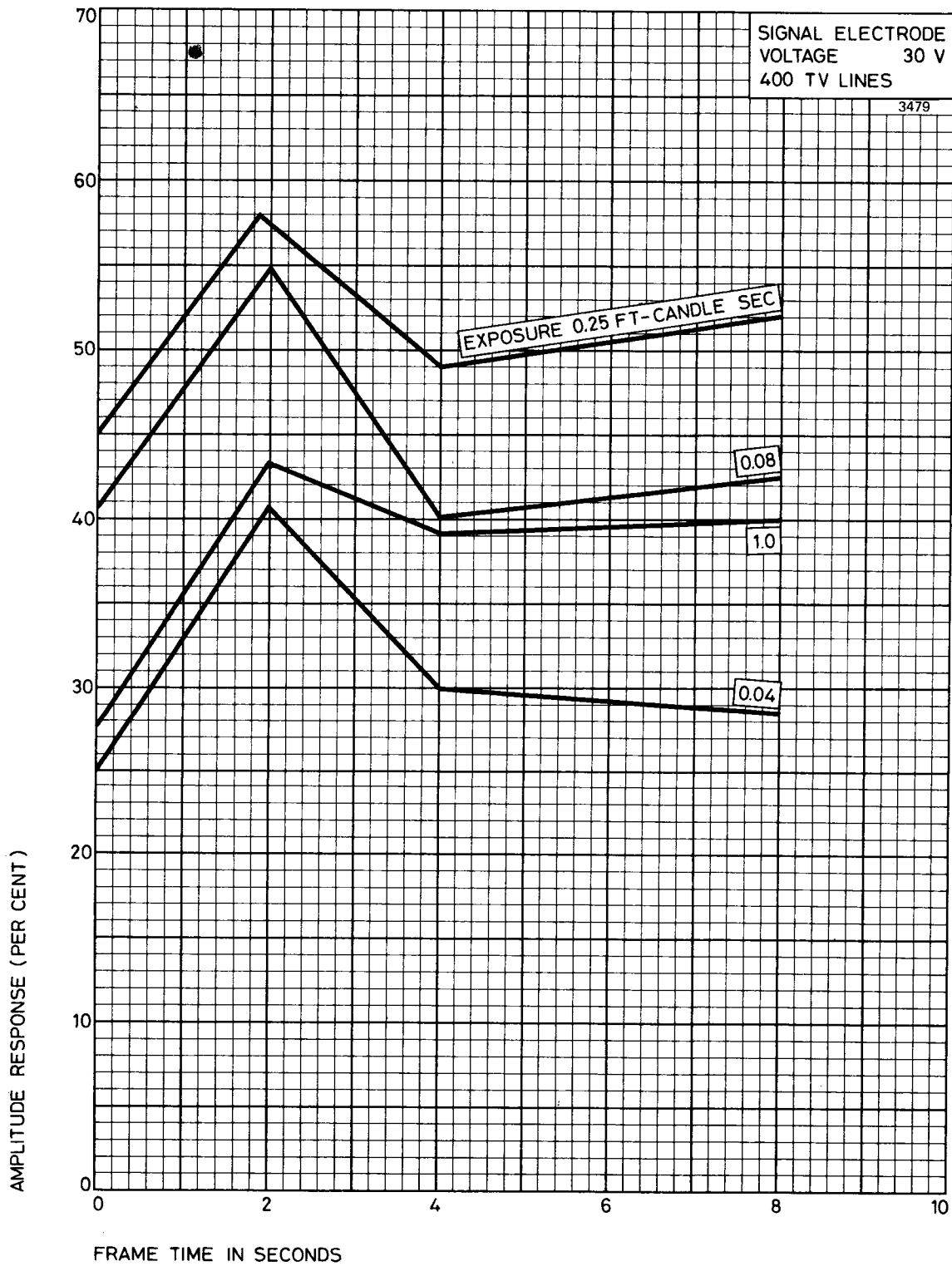

# TYPICAL OUTPUT CHARACTERISTICS SLOW SCAN RATES

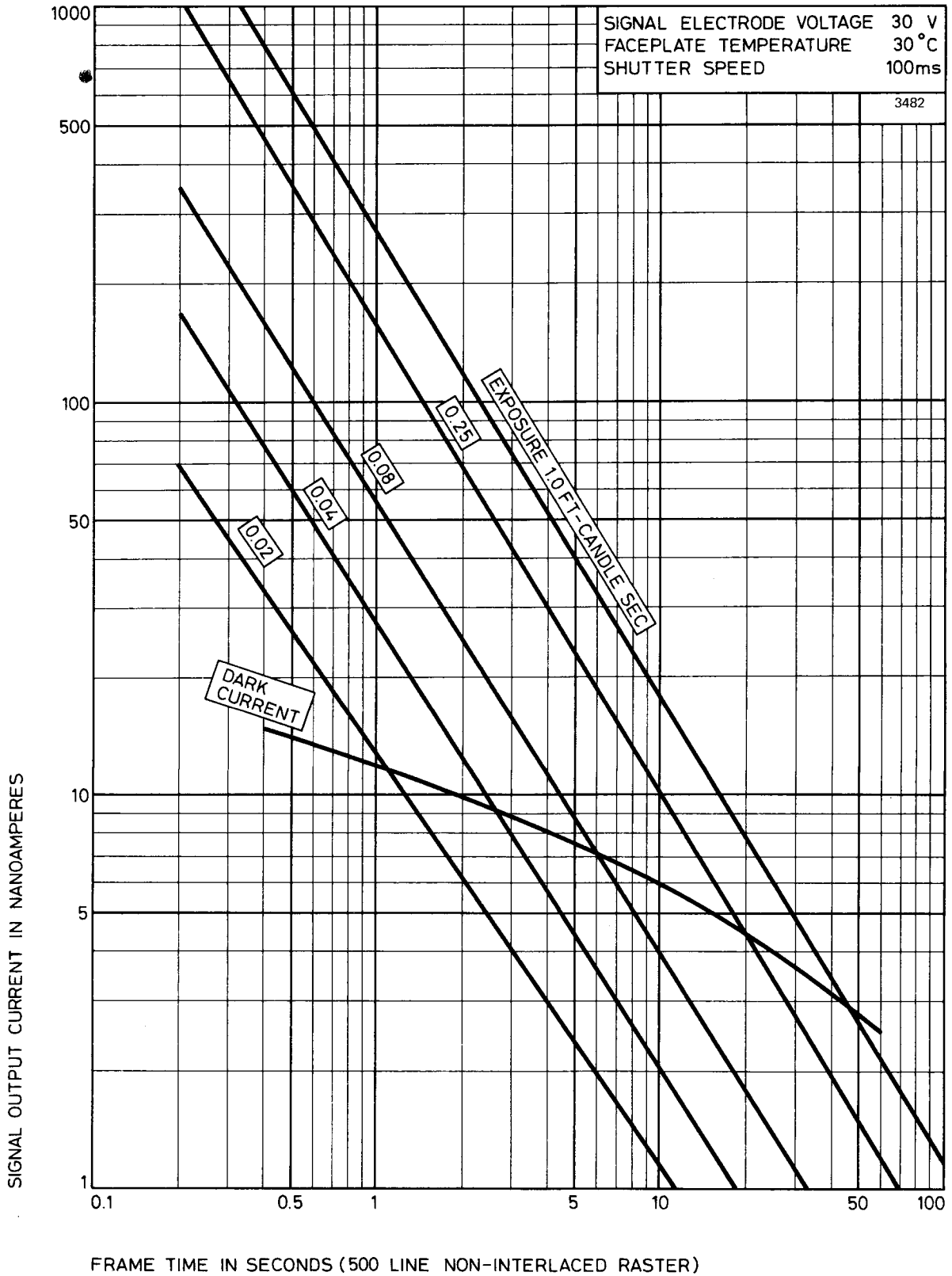

# OUTLINE (All dimensions without limits are nominal)

2157A

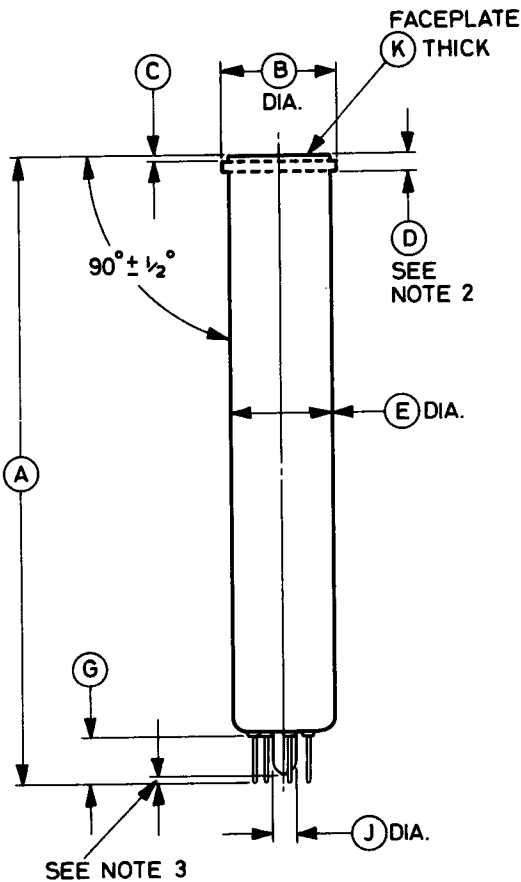
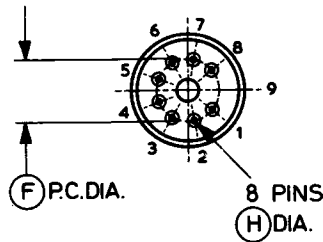
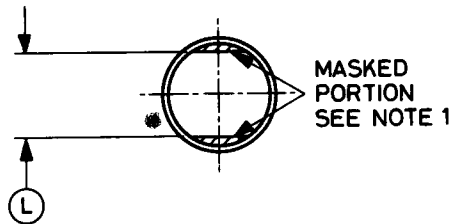

Pin	Element
1	Heater
2	Grid 1
3	Internal connection
4	Internal connection
5	Grid 2
6	Grid 3 and grid 4
7	Cathode
8	Heater
9	Key pin position, blank
Flange	Signal electrode

## NOTES

1. The straight sides are parallel to the plane passing through the tube axis and pin position 9.
2. Signal electrode contact flange may be located along the tube axis in any part of or all of the space between the dashed lines.
3. The seal-off will not project beyond the pins.

Ref	Inches	Millimetres	Ref	Inches	Millimetres
A	6.250 ± 0.125	158.8 ± 3.2	G	0.503 max	12.78 max
B	1.125 ± 0.010	28.58 ± 0.25	H	0.050 <sup>+0.002</sup> <sub>-0.004</sub>	1.270 <sup>+0.051</sup> <sub>-0.102</sub>
C	0.050 max	1.27 max	J	0.265 max	6.73 max
D	0.175	4.45	K	0.093 ± 0.005	2.36 ± 0.13
E	1.020 <sup>+0.030</sup> <sub>-0.035</sub>	25.91 <sup>+0.76</sup> <sub>-0.89</sub>	L	0.835 ± 0.035	21.21 ± 0.89
F	0.600	15.24			

Millimetre dimensions have been derived from inches.

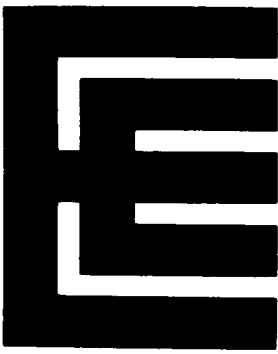

### INTRODUCTION

The P8034A is a 1-inch vidicon intended for slow scan operation. It has high sensitivity and operates satisfactorily at very low light levels in applications with limited motion in the scene. Magnetic deflection and focusing are used and the low power (0.6W) heater makes the tube suitable for use in small cameras employing solid state circuits.

The tube is of separate mesh construction and incorporates a photoconductive surface with a long lag characteristic. This is a useful feature in applications where image retention for relatively long periods is required. The long lag gives between 40% and 60% of the initial signal output current after one scanning frame. For slow scan applications the lag can be controlled by applying a high-speed multi-frame erase cycle.

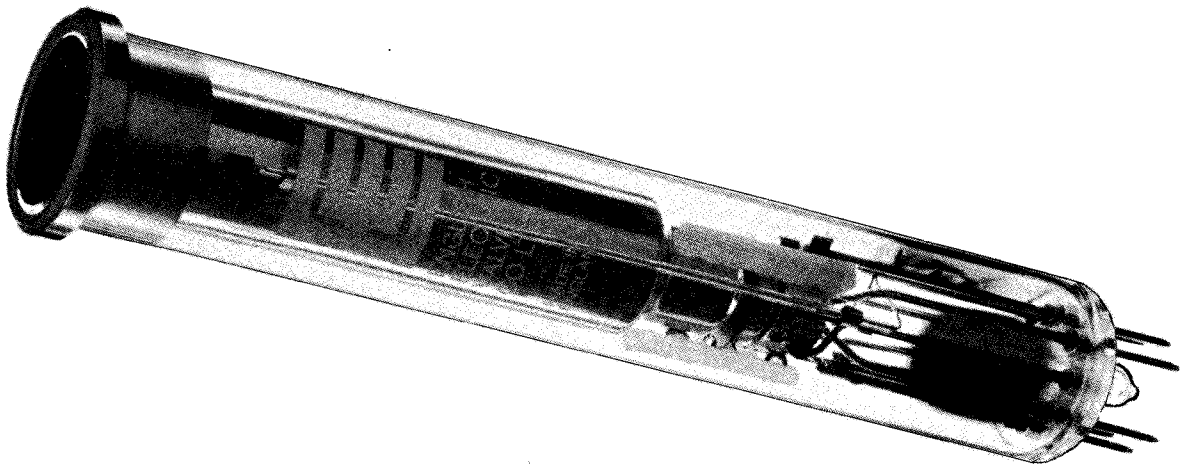

The signal storage capability of the P8034A is such that 90% of the initial signal current is available at the end of 10 seconds.

Limiting resolutions in the region of 600 TV lines may be obtained at the centre of the picture, optimum resolution being achieved when the grid 3 voltage is 0.6 to 0.7 of the mesh voltage.

Where P8034A is to be used in a standard vidicon camera, the target voltage range will require adjustment to accommodate the lower maximum target voltage of this tube. This is necessary to prevent picture polarity reversal and to optimize performance.

## GENERAL DATA

### Electrical

Cathode . . . . .	indirectly heated, oxide coated
Heater voltage . . . . .	6.3 V
Heater current . . . . .	95 mA
Inter-electrode capacitance, signal electrode to all other electrodes (average value) (see note 1) . . . . .	4.6 pF
Spectral response . . . . .	see spectral sensitivity curve
Focusing method . . . . .	magnetic
Deflection method . . . . .	magnetic

### Mechanical

Overall length . . . . .	6.375 inches (162mm) max
Bulb diameter . . . . .	1.020 inches (25.91mm) nom
Useful size of rectangular image; diagonal, centrally situated . . . . .	0.63 inches (15.9mm) max
Orientation . . . . .	see note 2
Net weight . . . . .	2 ounces (60g) approx
Mounting position (see note 3) . . . . .	any
Base . . . . .	small button ditetrar 8-pin (JEDEC no. E8-11)

### Associated Components

Focusing coil (see note 4) . . . . .	Cleveland Electronics VF-115-12
Deflection yoke . . . . .	Cleveland Electronics VY-111-3
Alignment coil (see note 5) . . . . .	Cleveland Electronics VA-118
Mating socket . . . . .	Type R41-79502 by United Carr Fasteners Ltd. (or equivalent)

### Storage

Recommended store temperature . . . . .	15 to 35 °C
---	-------------

Tubes are to be stored in darkness.

### WARNING

When operating a tube the following precautions are observed:

1. Ensure that the temperature of the tube is within its recommended range.
2. Avoid exposure to high levels of illumination otherwise permanent damage to the photoconductive surface may result.
3. A surge limiting device must be incorporated if necessary to ensure that the heater current does not exceed 150mA when switching on or at any other time.



## MAXIMUM AND MINIMUM RATINGS (Absolute values)

No individual rating to be exceeded.

	Min	Max	
Heater voltage . . . . .	5.7	6.9	V
Signal electrode voltage . . . . .	—	60	V
Grid 4 (mesh) voltage (see note 6) . . . . .	—	1000	V
Grid 3 (beam focus) voltage (see note 6) . . . . .	—	1000	V
Grid 2 (accelerator) voltage . . . . .	—	750	V
Grid 1 voltage:			
negative bias value . . . . .	—	300	V
positive bias value . . . . .	—	0	V
Blanking voltage, peak to peak (see note 7):			
when applied to grid 1 (negative pulses) .	40	—	V
when applied to cathode (positive pulses)	20	—	V
Peak heater to cathode voltage:			
heater negative with respect to cathode .	—	125	V
heater positive with respect to cathode .	—	10	V
Dark current . . . . .	—	0.10	$\mu$ A
Peak signal electrode current (see note 8) .	—	0.6	$\mu$ A
Peak illumination of faceplate . . . . .	—	1000	ft-candles
	—	10 760	lux
Temperature range:			
storage . . . . .	−20	+70	°C
operating . . . . .	−10	+55	°C



## TYPICAL OPERATION

### Operating Conditions (for scanned area of 0.5 x 0.375 inch)

The following values and notes are for general guidance and may vary from tube to tube.

	Low Voltage Operation	High Voltage Operation	
Grid 4 (mesh) voltage (see note 6)	500	750	V
Grid 3 voltage (approx) (see notes 6 and 9)	300	450	V
Grid 2 voltage	300	300	V
Grid 1 voltage for picture cut-off (with no blanking voltage on grid 1)	-45 to -100	-45 to -100	V
Blanking voltage, peak to peak: when applied to grid 1 (negative pulses)	40	40	V
when applied to cathode (positive pulses)	10	10	V
Field strength at centre of focusing coil (see notes 4 and 9)	41 ± 4 4.1 ± 0.4	52 ± 4 5.2 ± 0.4	gauss mT
Peak deflection coil currents (approx): horizontal	200	240	mA
vertical	25	30	mA
Alignment field, adjustable (see note 10)	0 to 4 0 to 0.4	0 to 4 0 to 0.4	gauss mT
Faceplate temperature (see note 11)	30 to 35	30 to 35	°C

### Typical Performance — Standard TV Scan Rates

	Low Voltage Operation	High Voltage Operation	
Limiting resolution at centre of picture (approx)	600	700	TV lines
Amplitude response to a 400 TV line square wave test pattern at centre of picture (approx)	20	30	%
Lag (see note 12)		55	%
'Gamma' of transfer characteristic for signal output between 0.02 and 0.2μA		0.7	
Visual equivalent signal to noise ratio (see note 13)		300:1	approx

**Typical Performance – Standard TV Scan Rates (continued)**

	Condition		
	1*	2†	
Faceplate illumination (highlights) . . . . .	1.0	0.1	ft-candle
	10.8	1.1	lux
Signal output current (peak) (see note 16) . . . . .	0.4	0.16	μA
Approximate range of signal electrode voltage (see note 17) . . . . .	7 to 25	15 to 45	V
Dark current (see note 18) . . . . .	0.005	0.02	μA

\* See note 14

† See note 15

**Typical Performance – Slow Scan Rates**

Signal electrode voltage . . . . .	30		V
Dark current . . . . .	8.0		nA
Exposure . . . . .	0.25	ft-candle-sec	
	2.7	lux-sec	
Signal output current:			
frame time 1s . . . . .	160		nA
frame time 2s . . . . .	70		nA
frame time 4s . . . . .	30		nA
frame time 6s . . . . .	19		nA
frame time 10s . . . . .	10		nA
Lag (see note 19) . . . . .	5 to 10		frames
Amplitude response to 400 TV lines . . . . .	50		%
Signal storage time (see note 20) . . . . .	80		s



**SEQUENCE OF CAMERA ADJUSTMENTS**

**(For general operational conditions as shown on page 4)**

- (a) Set the grid 1 voltage for the maximum negative bias for picture cut-off and apply the other voltages given under Typical Operating Conditions.
- (b) Check that the deflection circuits are functioning properly and adjust the scanning amplitude controls so that a maximum area of the photoconductive layer will be scanned.
- (c) Set the signal electrode voltage to give the signal current specified for the particular condition of operation. The table above gives an indica-

tion of the ranges of signal electrode voltage required for two conditions of operation. For other conditions of operation, reference should be made to the light transfer characteristic and the graph showing the range of signal electrode voltage to produce a given dark current and therefore a given sensitivity. It is preferable, if possible, to adjust the dark current to the specified value for the particular condition of operation; P8034A tubes will have substantially identical performances when operated with identical values of dark current.

The magnitude of non-uniformities of dark current, as well as lag, tend to increase with signal electrode voltage; therefore operation at low values of signal electrode voltage helps to minimize these effects.

- (d) Decrease grid 1 voltage from its maximum negative value until a signal is produced.
- (e) Adjust grid 3 (beam focus) or grid 3 and grid 4 voltages, the lens stop and the optical focus alternately to obtain the best focused picture with the peak signal output current specified under Typical Performance.
- (f) Adjust the lens aperture and signal electrode voltage to produce the desired output signal. Lag decreases with increase in illumination on the faceplate.
- (g) Adjust the alignment field so that the centre of the picture does not move as grid 3 (beam focus) and grid 4 (mesh) voltages are rocked slightly. Adjust grid 1 voltage to provide just sufficient beam to discharge the highlights. It is permissible to set the alignment field slightly off the minimum movement position to maintain signal uniformity.
- (h) Adjust the deflection amplitude and position to scan an area 0.500 inch x 0.375 inch. This is facilitated by the use of a perspex mask inscribed with circles 0.500 inch and 0.375 inch diameter, placed in contact and concentric with the faceplate of the tube. Light is allowed to fall on the photoconductive layer and an image of the rings is obtained on the monitor. No lens is necessary. The scan amplitude and centring controls are adjusted until the diameter of the larger circle is equal to the width of the raster and that of the smaller equal to the height.
- (j) Centre the raster in the useful area of the photoconductive layer and check the alignment (step g).
- (k) If the picture is faint, even with adequate video gain, open the lens iris more and, if necessary, increase the signal electrode voltage.
- (l) Repeat steps (e) to (g) until optimum picture reproduction is obtained.

## NOTES

1. This capacitance, which in effect forms the output impedance of the tube, is increased when the tube is mounted in a deflecting yoke and focusing coil assembly. The resistive component of the output impedance is of the order of 100 megohms.
2. The horizontal scan must be parallel to the plane passing through the tube axis and the blank key-pin position. The masking is for orientation only and does not define the proper scanned area.
3. When the tube is subjected to vibration the mounting position must not be vertical with the base uppermost.
4. The direction of the focusing current is such that a north pole is attracted to the image end of the focusing coil. The distance from the faceplate to the beginning of the winding is 0.75 inch approximately.
5. The alignment coil is located to the rear of the focusing coil directly over the electron gun. It is positioned so that its centre is 3.69 inches from the faceplate of the tube and its axis is coincident with the axis of the tube, the deflecting yoke and the focusing coil.
6. Grid 3 and grid 4 voltages are adjusted for the best focus. The resolution, uniformity of focus and picture quality decrease with decreasing grid 3 and grid 4 voltage. In general grid 3 should be operated above 250 volts and be approximately 0.6 of grid 4 voltage.
7. The blanking voltage required when applied to the cathode is less than that required when applied to grid 1 as the former reduces the potential difference between the cathode and the scanned side of the target.
8. The video amplifier must be designed to handle signal currents of this magnitude, to avoid picture distortion due to overloading of the amplifier.
9. It may be preferred to adjust beam focus by varying the focus coil current to obtain the field strengths indicated in the Typical Operating Conditions. If the focus coil field strength is fixed, beam focus may be obtained within a  $\pm 10\%$  range (approximately) of the grid 3 and grid 4 voltages. The ratio of 0.6 between grid 3 and grid 4 must be maintained as these voltages are varied.
10. Adjust the current through the alignment coils until the centre of the test pattern does not move as grid 3 and grid 4 voltages or the focus coil current are varied in and out of focus.



11. Unless the temperature of the faceplate is maintained at a constant value within this range, the dark current and performance will drift from the optimum performance established on initial setting up.
12. Percentage of initial value of signal output current remaining 3 field periods after light is cut off (i.e. 50ms in American standard systems and 60ms in European systems), with an initial highlight signal current of  $0.3\mu\text{A}$  and a dark current of  $0.02\mu\text{A}$ .
13. Measured with a high gain, low noise, cascode type pre-amplifier having a bandwidth of 5.1MHz and a peak signal output current of  $0.35\mu\text{A}$ . The visual equivalent signal to noise ratio is taken as the ratio of the highlight signal output current to the r.m.s. noise current, multiplied by a factor of 3 (ref. Otto H. Schade, *Electro-optical Characteristics of Television Systems; Introduction and Part 1 – Characteristics of Vision and Visual Systems*, RCA Review, March 1948).
14. Average light-level operation.
15. Low light-level operation.
16. The signal output current is the highlight signal electrode current during one frame after the dark current component has been subtracted.
17. The signal electrode voltage for each tube is adjusted to that value which gives the desired operating signal current; the indicated range of signal electrode voltage for each operational condition is given to illustrate the variation normally encountered.
18. The deflecting circuits must provide extremely linear scanning for good black level reproduction under these conditions. Dark current is proportional to the scanning velocity. Any change in scanning velocity produces a black level error in direct proportion to the change in velocity of scanning.
19. The time for the residual signal to reach 5% of its original value.
20. The time for the signal to decay to 50% of its original value.

# TYPICAL SPECTRAL SENSITIVITY CHARACTERISTIC

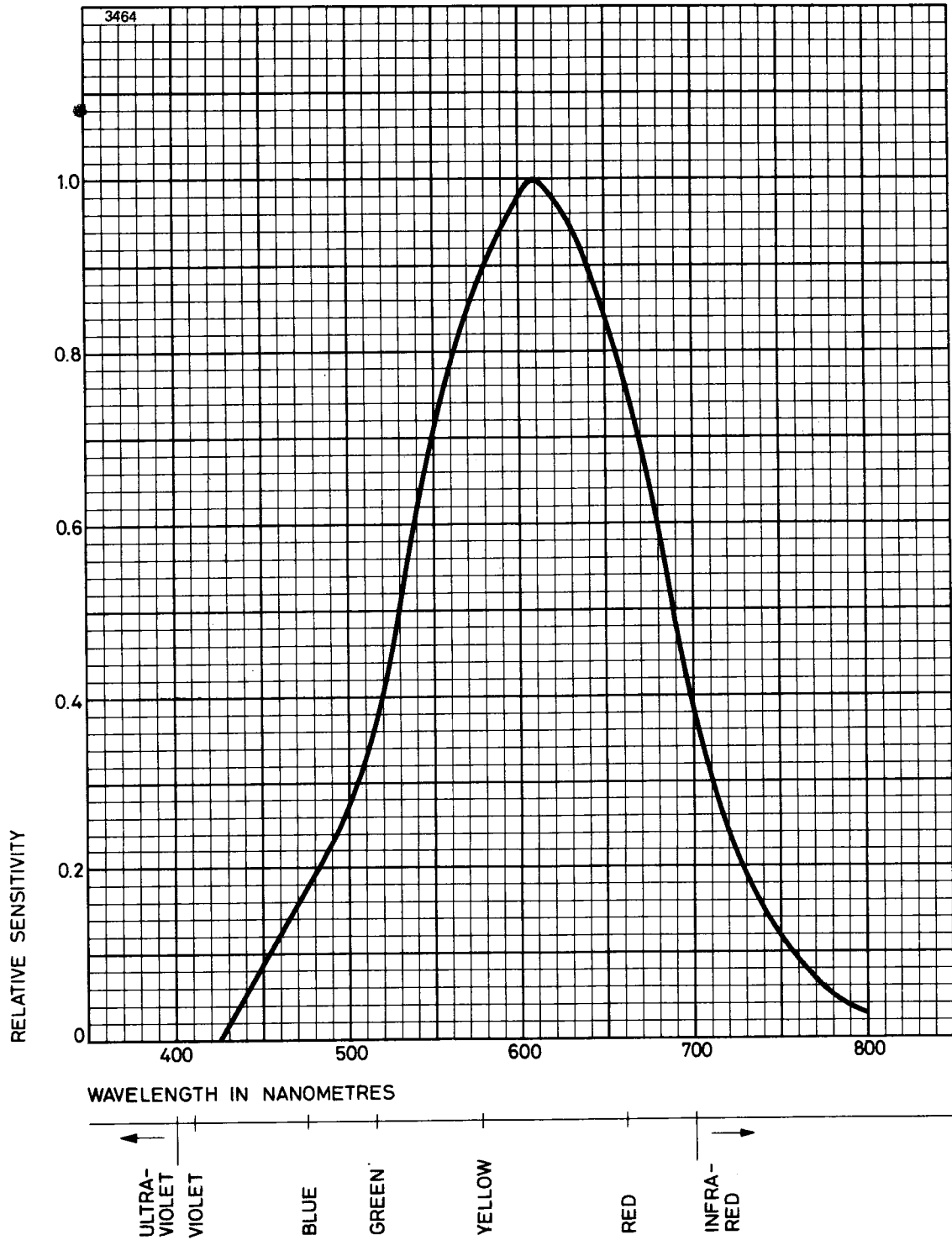

**TYPICAL RESOLUTION (STANDARD TV SCAN RATE)**

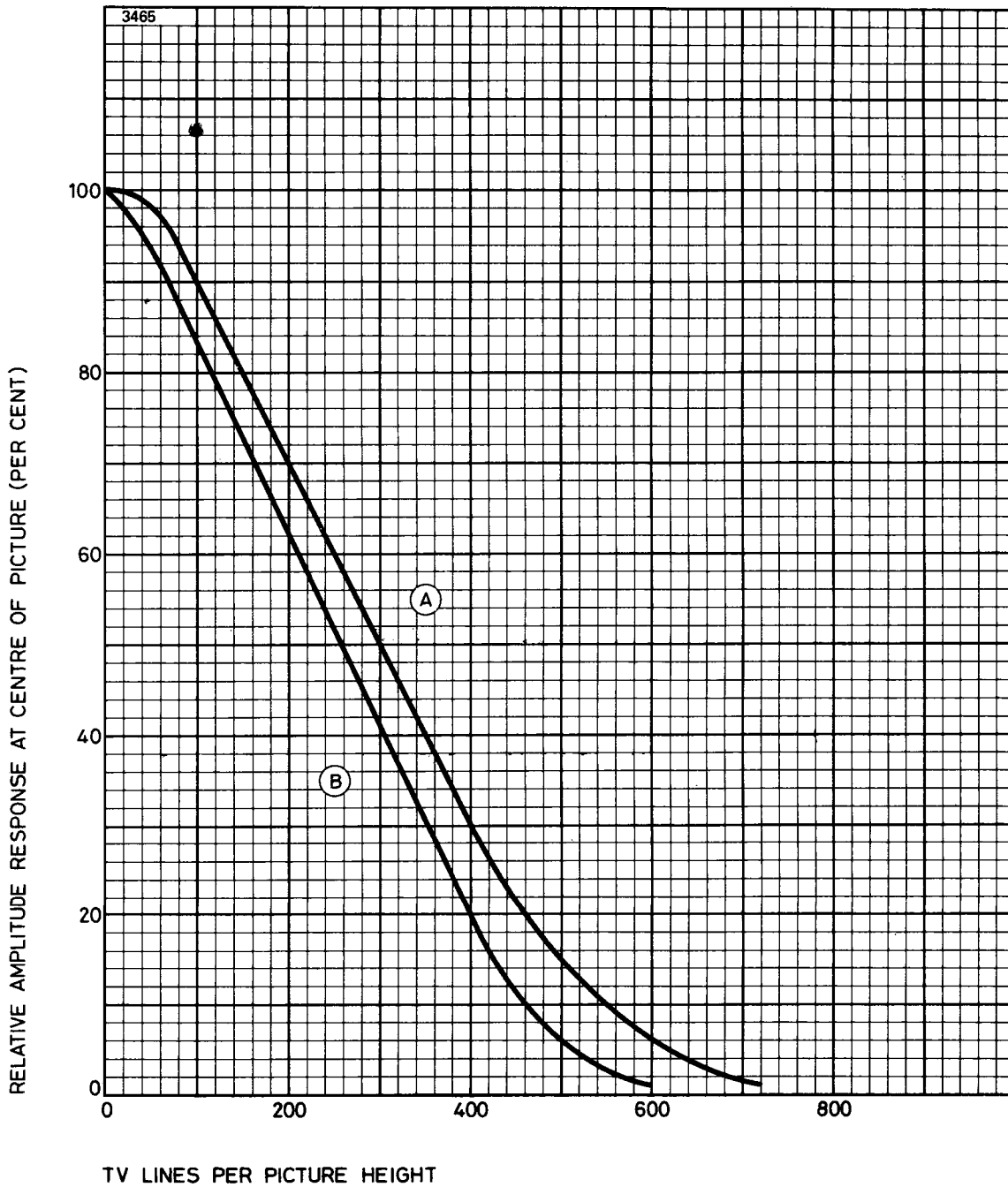

Highlight signal electrode current . . . . . 0.30  $\mu$ A  
 Dark current . . . . . 0.02  $\mu$ A  
 Test pattern . . . . . square wave resolution wedge transparency  
 Video amplifier response . . . . . flat  
 Curve A . . . . . grid 3 at 450V, grid 4 at 750V  
 Curve B . . . . . grid 3 at 300V, grid 4 at 500V



# TYPICAL LIGHT TRANSFER CHARACTERISTICS STANDARD TV SCAN RATE

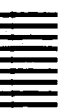
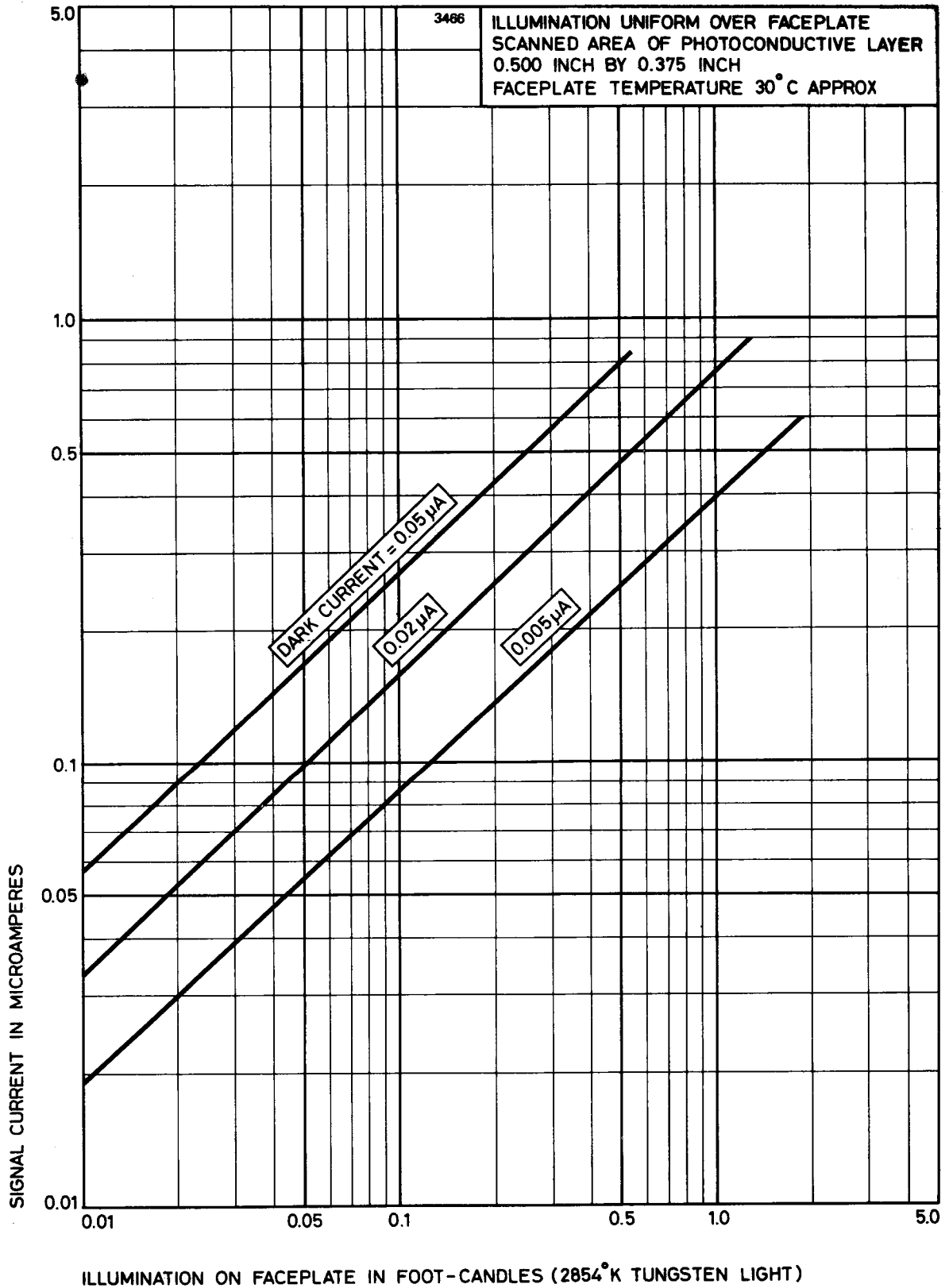

# TYPICAL RANGE OF DARK CURRENT STANDARD TV SCAN RATE

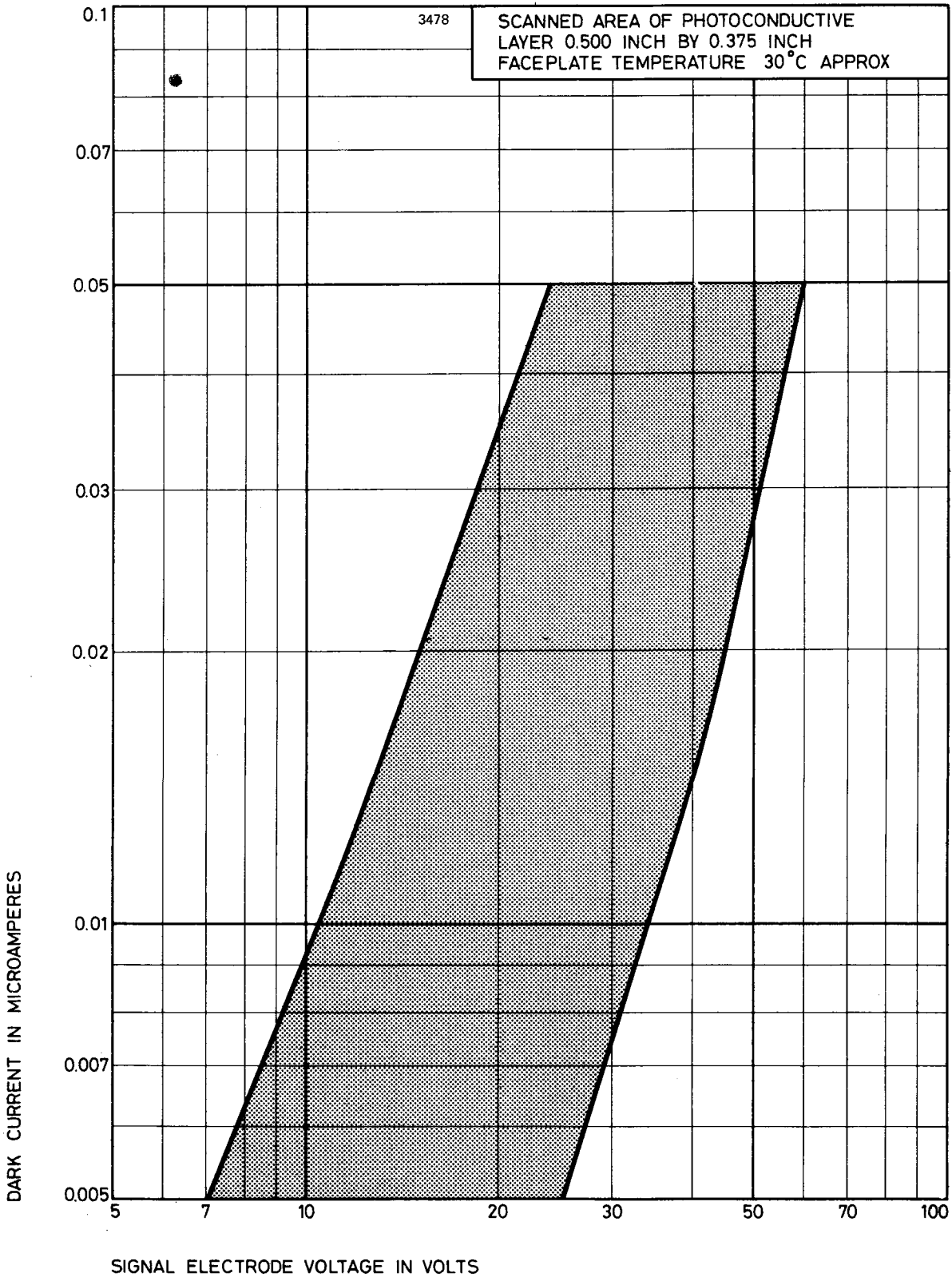

# TYPICAL LAG CHARACTERISTICS STANDARD TV SCAN RATE

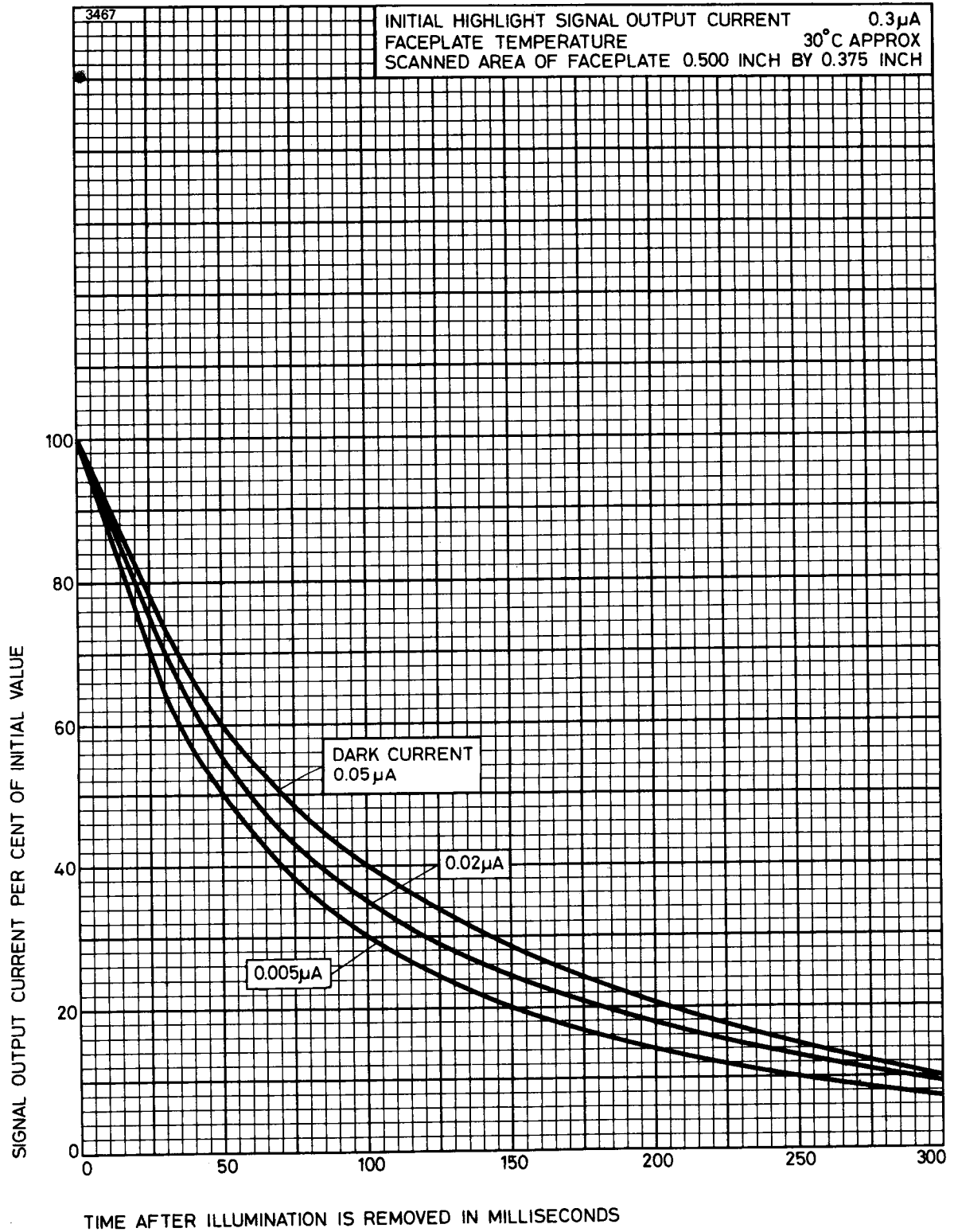

# TYPICAL STORAGE CHARACTERISTICS SLOW SCAN RATES

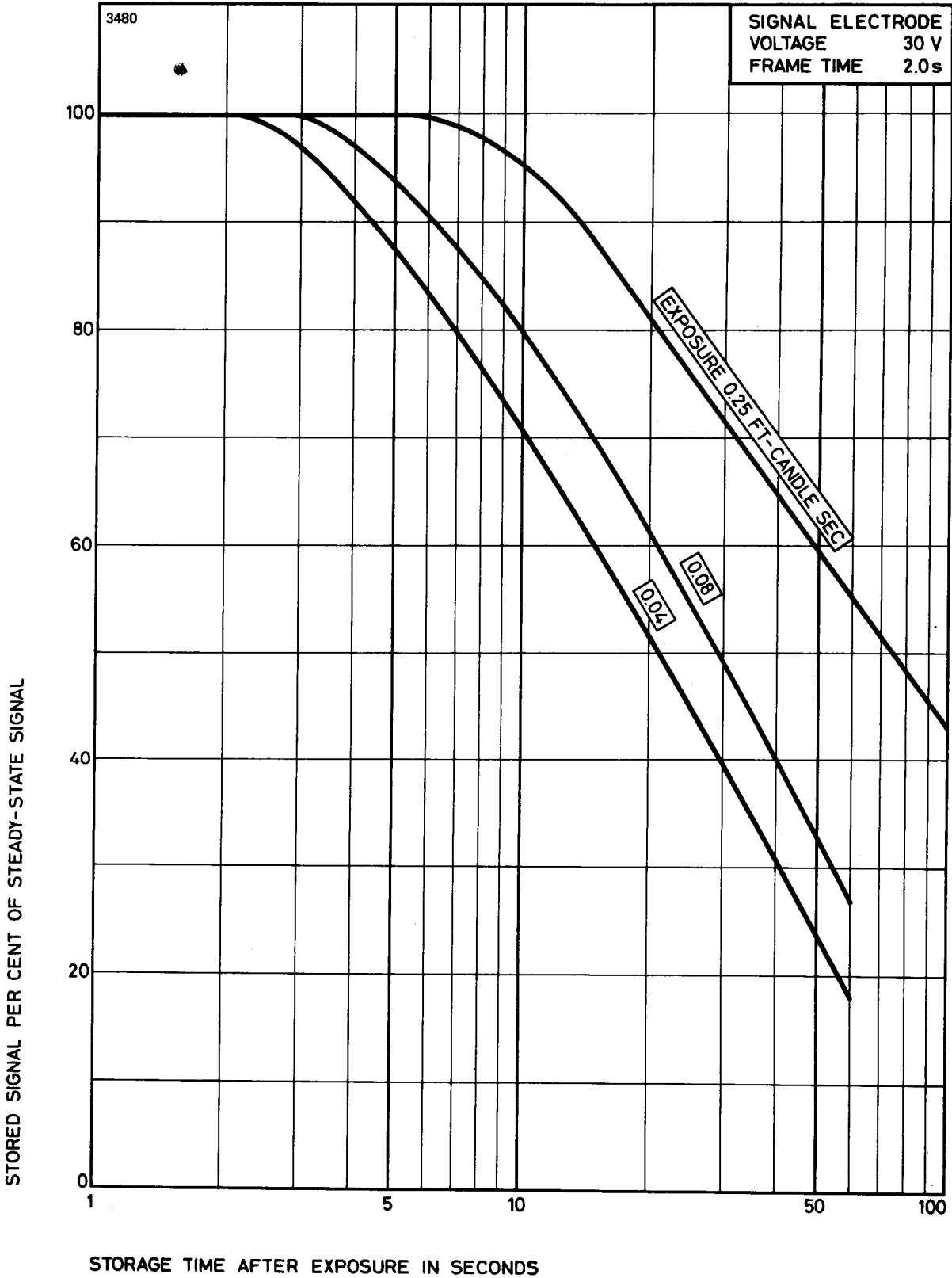

# TYPICAL LAG CHARACTERISTICS SLOW SCAN RATES

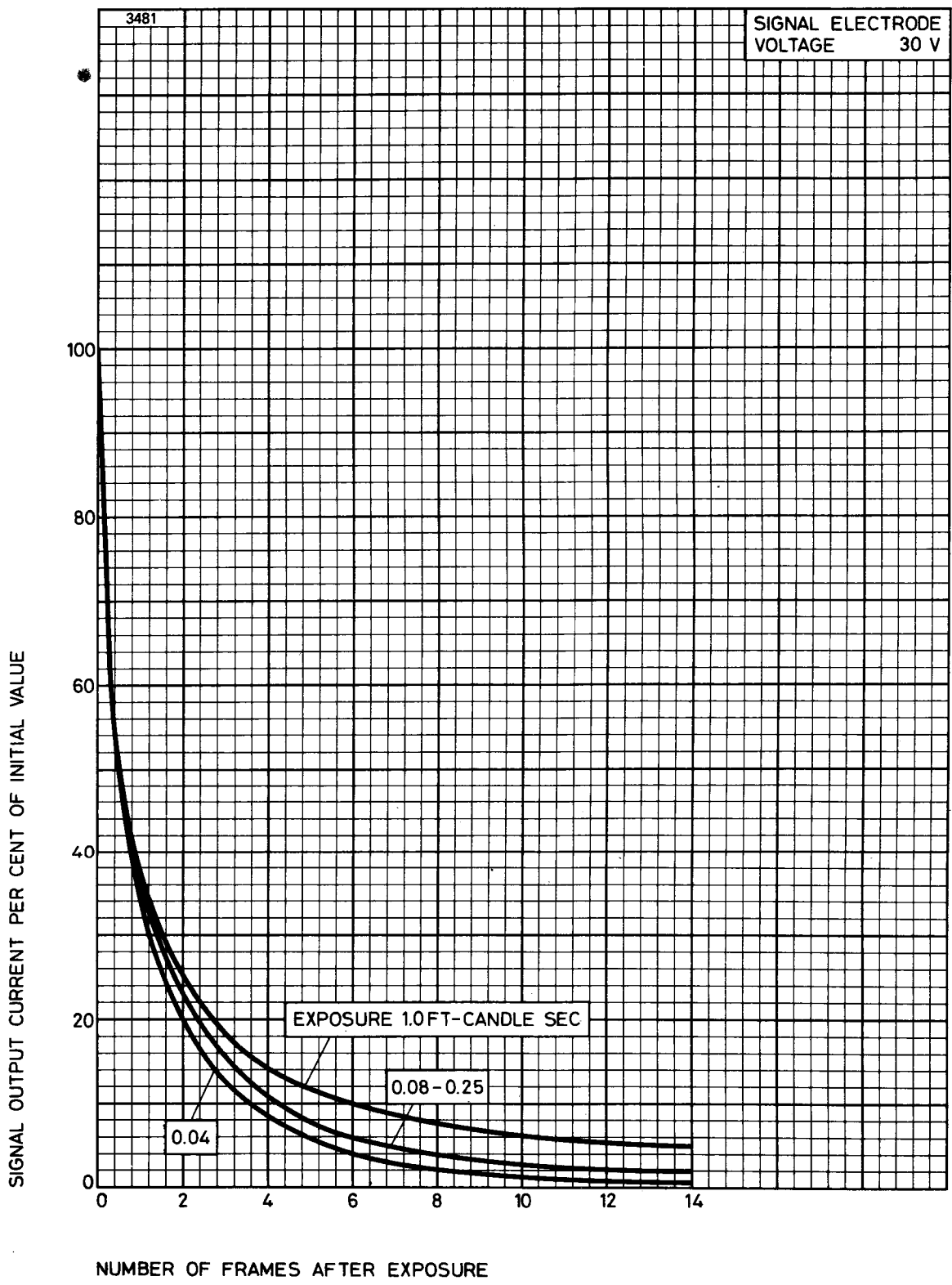

# TYPICAL RESOLUTION CHARACTERISTICS SLOW SCAN RATES

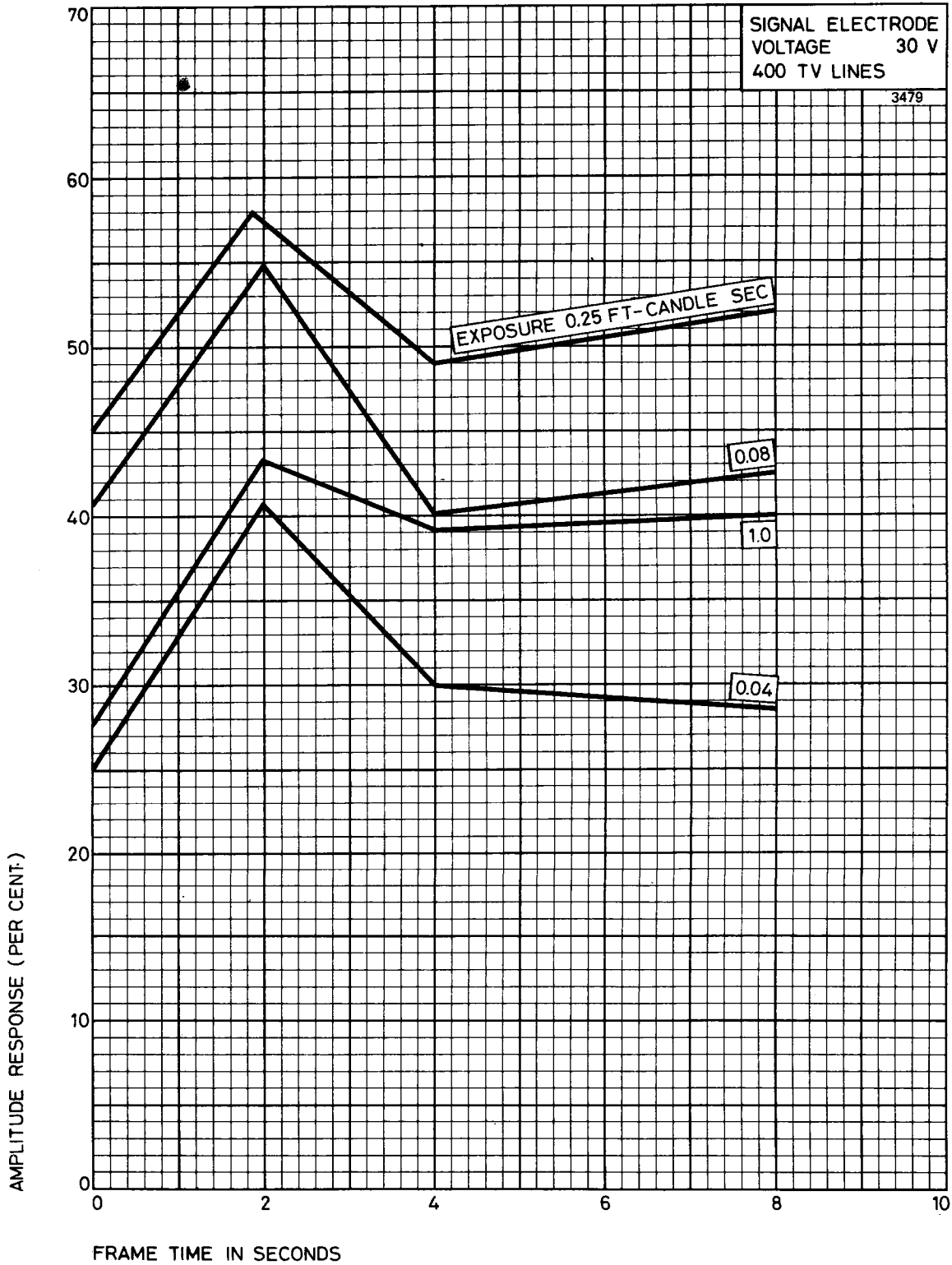

# TYPICAL OUTPUT CHARACTERISTICS SLOW SCAN RATES

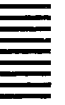
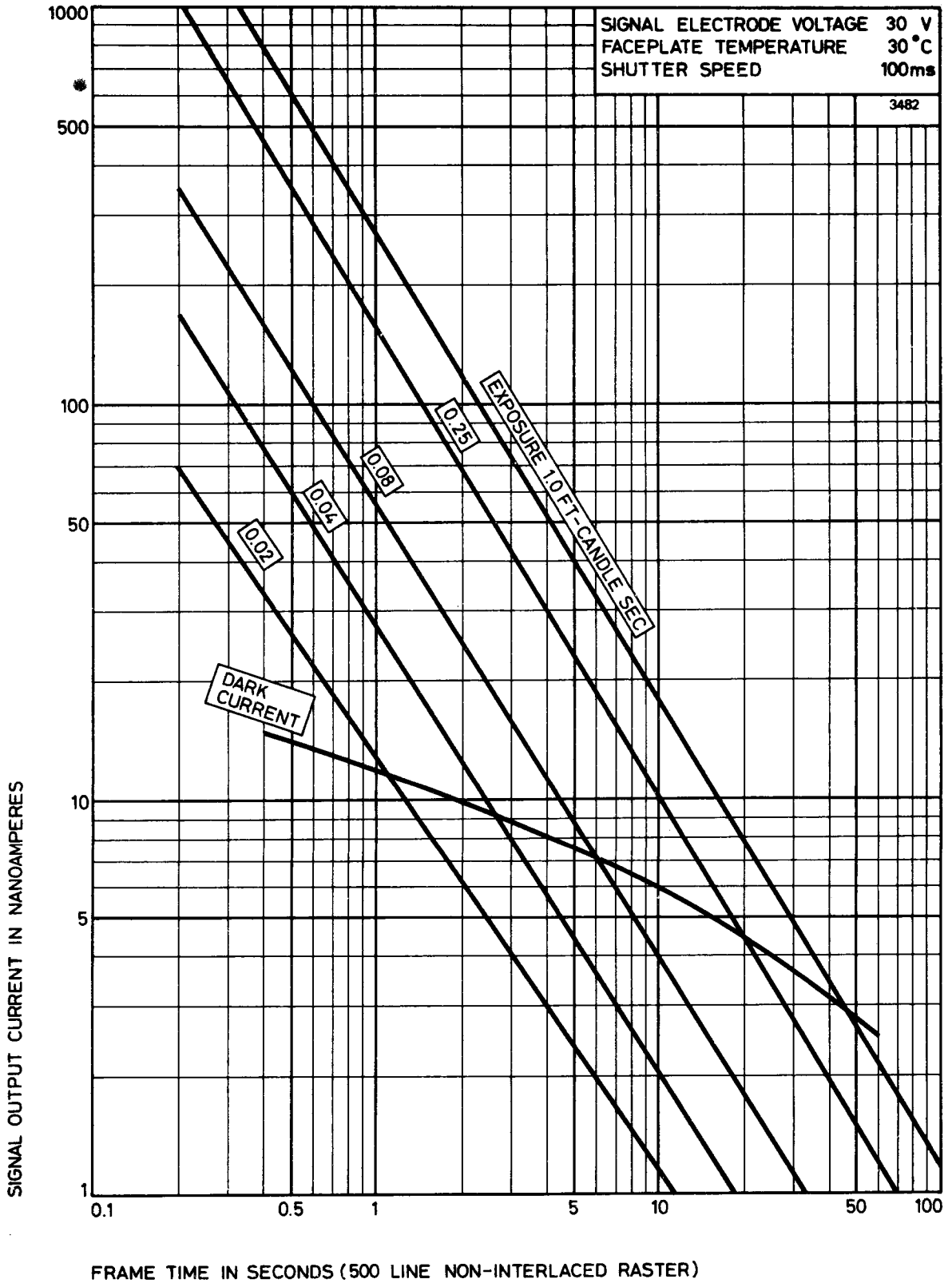

# OUTLINE (All dimensions without limits are nominal)

2157A

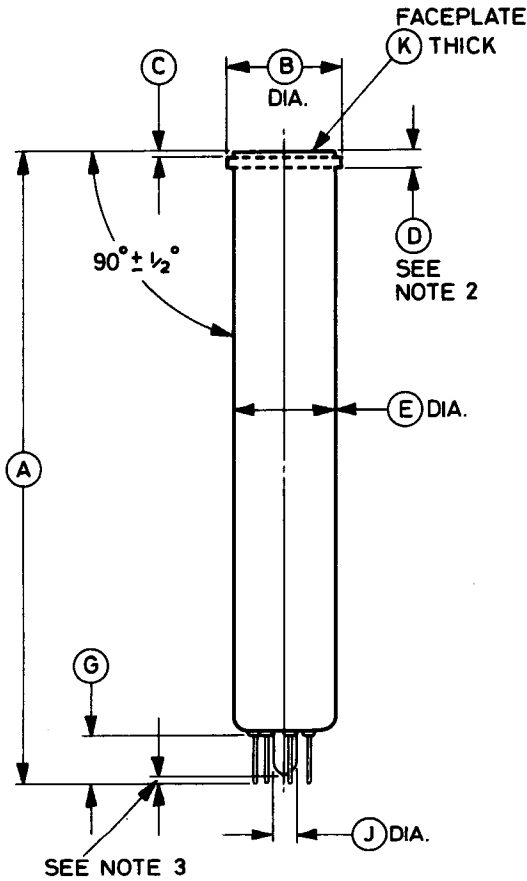
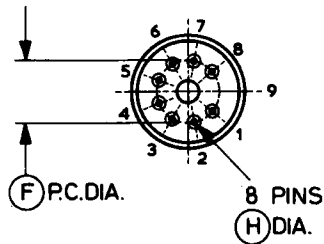
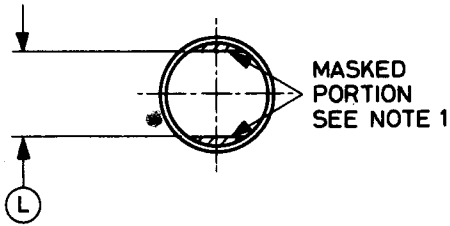

Pin	Element
1	Heater
2	Grid 1
3	Grid 4 (mesh)
4	Internal connection
5	Grid 2
6	Grid 3 (beam focus)
7	Cathode
8	Heater
9	Key pin position, blank
Flange	Signal electrode

## NOTES

1. The straight sides are parallel to the plane passing through the tube axis and pin position 9.
2. Signal electrode contact flange may be located along the tube axis in any part of or all of the space between the dashed lines.
3. The seal-off will not project beyond the pins.

Ref	Inches	Millimetres	Ref	Inches	Millimetres
A	6.250 ± 0.125	158.8 ± 3.2	G	0.503 max	12.78 max
B	1.125 ± 0.010	28.58 ± 0.25	H	0.050 + 0.002 - 0.004	1.270 + 0.051 - 0.102
C	0.050 max	1.27 max	J	0.265 max	6.73 max
D	0.175	4.45	K	0.093 ± 0.005	2.36 ± 0.13
E	1.020 + 0.030 - 0.035	25.91 + 0.76 - 0.89	L	0.835 ± 0.035	21.21 ± 0.89
F	0.600	15.24			

Millimetre dimensions have been derived from inches.



# **Image Intensifiers and Shutter Tubes**

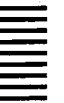





## SHUTTER TUBE

---

### INTRODUCTION

The P855 is an electrostatically focused tetrode image converter provided with electrostatic deflectors for ultra high speed framing and streak applications. Whereas in conventional image converter tubes the time resolution is limited by the low extraction field at the photocathode, the P855 incorporates a fine mesh accelerator grid which is used to reduce the time resolution limit to less than 5 picoseconds (see note 1). For operation in the picosecond mode the P855 should be used in conjunction with an intensifier (see note 2) and a fibre-optic output version exists for use in applications where fibre-optic coupled intensifiers are preferred. The P855 utilizes a flat, low resistance photocathode which limits the onset of image distortion when large peak photocurrents are drawn. The flat photocathode also allows selection of the input lens from a wide range of standard optical lenses.

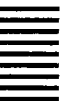
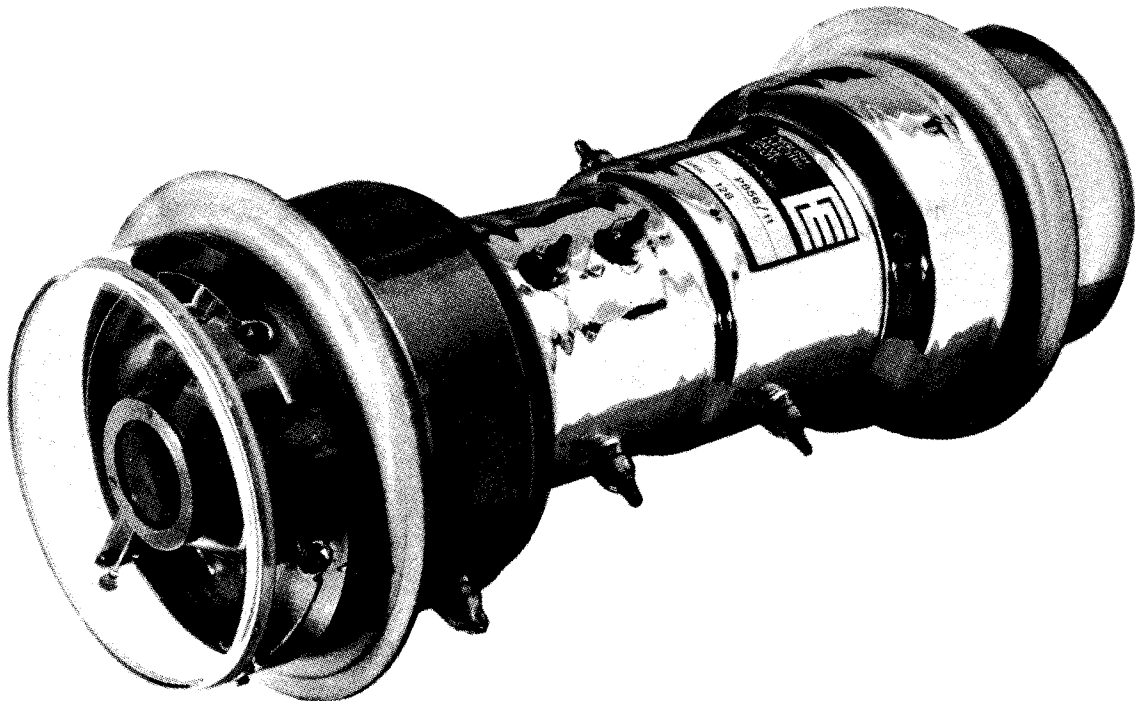

## RANGE OF TYPES

The range of variants currently available includes the types listed below.

Type	●Output faceplate	Fibre size ( $\mu\text{m}$ )	Useful screen dimensions (mm)	Photo-cathode type	Minimum sensitivity ( $\mu\text{A/lm}$ )
P855/9	Plain glass	—	75 x 40	S9	15
P855/9A	Fibre-optic 33mm	6	20 x 20	S9	15
P855/9B	Fibre-optic 45mm	6	30 x 24	S9	15
P855/9C	Fibre-optic 75mm	16	60 x 40	S9	15
P855/11	Plain glass	—	75 x 40	S11	30
P855/11A	Fibre-optic 33mm	6	20 x 20	S11	30
P855/11B	Fibre-optic 45mm	6	30 x 24	S11	30
P855/11C	Fibre-optic 75mm	16	60 x 40	S11	30
P855/20	Plain glass	—	75 x 40	S20	50
P855/20A	Fibre-optic 33mm	6	20 x 20	S20	50
P855/20B	Fibre-optic 45mm	6	30 x 24	S20	50
P855/20C	Fibre-optic 75mm	16	60 x 40	S20	50
P855/1	Plain glass	—	75 x 40	S1	10
P855/1A	Fibre-optic 33mm	6	20 x 20	S1	10
P855/1B	Fibre-optic 45mm	6	30 x 24	S1	10
P855/1C	Fibre-optic 75mm	16	60 x 40	S1	10

## GENERAL DATA

### Photocathode

Types available (see page 2 and application note ii) . . . . .	S1, S9, S11, S20
Useful area . . . . .	standard size 8mm x 9mm. Any regular photocathode shape within 8 x 9mm can be supplied to special order
Refractive index of faceplate and photocathode support . . . . .	1.48

### Fluorescent Screen

Faceplate . . . . .	flat, circular
Useful area (orientation set by sweep deflectors) . . . . .	see page 2
Phosphor . . . . .	aluminized P11, blue (peak response 460nm), persistence 80 $\mu$ s to 10%

### Plate Capacitance

Capacitance of any plate to all others connected . . . . .	8	pF max
---	---	--------

## MAXIMUM RATINGS

Photocathode voltage . . . . .	-18	kV max
Light input for setting-up . . . . .	5	lux max
	0.5	ft-candle max
Accelerator to photocathode voltage . . . . .	2	kV

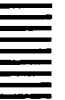

## TYPICAL OPERATION

### Operating Conditions

Photocathode voltage (see application note iv) . . . . .	-16	kV
Accelerator to photocathode voltage . . . . .	1.0	kV
Cone voltage range . . . . .	-15.5 to -16	kV

## Typical Performance

Time resolution in streak mode of operation (with 1kV on accelerator):		
S9 . . . . .	3.5	ps
S1 . . . . .	2.2	ps
Exposure time per frame in shutter operation (dependent on camera) . . . . . typically 1.5ns in Imacon camera (see note 3)		
Repetition rate (with P11 phosphor) . . . . . 1 ms per sequence		
Electron-optical linear magnification at correct focus condition . . . . . 2.0 (variation occurs with change of accelerator voltage) (see note 4)		
Static resolution in useful screen area . . . . . 13 line pairs/mm min		
Equivalent light input (at 16kV) . . . . . see application note v		
Output uniformity; maximum luminance variation in image of uniformly illuminated photocathode . . . . . 25 % of maximum		
Deflection sensitivity:		
sweep deflectors . . . . .	1/50	mm/V
shutter deflectors . . . . .	1/40	mm/V
compensating deflectors (see note 5) . . . . .	1/40	mm/V

## NOTES

1. The time resolution limit of an image converter is determined largely by the spread in photo-electron transit time between photocathode and phosphor screen due to the spread in photo-electron emission energies<sup>1</sup>. To a good approximation the time resolution limit  $\Delta t$  is given by

$$\Delta t = \frac{m\Delta u}{eE}$$

where  $\Delta u$  is the half width of the photo-electron emission velocities, E is the electric field strength at the photocathode and m and e are the electron mass and charge respectively. In the P855 the electric field E is increased by applying a suitable potential to the accelerator grid which is positioned a few millimetres from the photocathode. In this way  $\Delta t$  can be reduced to around 1 picosecond<sup>2,3</sup>.

2. It must be emphasized that although the P855 is provided with a special low resistance photocathode to enable high pulse currents to be drawn, space charge effects at very high current densities can cause image blurring. In order to avoid loss of resolution it is necessary to hold the pulse emission current density from the photocathode below a critical level (i.e., approximate total current not greater than 0.1mA per cm<sup>2</sup>).

It is found in practice that for some sub-nanosecond recordings the image displayed on the fluorescent screen is too weak to be recorded direct with a wide aperture lens and fast emulsion. It is therefore necessary to use an image intensifier between fluorescent screen and recording emulsion. Overall recording gains of 10<sup>2</sup> to 10<sup>4</sup> may be required depending on the application.

3. A camera designed to use the P855 can be supplied by J. Hadland, Ltd., Bovingdon, Herts., England<sup>4</sup>.
4. In cameras which have been adjusted to operate the P856 (shutter tube without mesh accelerator electrode) it will normally be found that the voltage applied to the cone electrodes has been adjusted to give correct focus. In these cases the electron optical magnification in the tube will normally be 2.0.

The use of a P855 with accelerator voltage up to 2kV positive with respect to cathode will increase the electron optical magnification above 2 and can result in image cut off due to the beam vignetting on the shutter plate apertures.

If it is required to use the P855 for streak records only it may be advantageous to omit both aperture plate and compensating plates. Tubes modified in this way can be made to order.

5. The deflection sensitivities of the shutter and compensating plates are matched to within 5% (normally 1%).



## APPLICATION NOTES

### i X-ray Warning

High voltage devices such as the P855 produce X-rays which can constitute a health hazard, and may require shielding.

### ii Choice of Photocathode

For operation in the 350nm to 600nm region S9 or S11 types are suitable. For operation in the 350nm to 800nm region (i.e., ruby laser, certain dye lasers and frequency doubled neodymium laser) the S20 type is required. For operation in the near infra-red (e.g., neodymium at 1060nm) the S1 is necessary.

### iii Setting Up Procedure for P855-Intensifier Combination

When the P855 is used with a magnetically-focused intensifier it is necessary to focus the P855 and the intensifier independently of each other. The simplest method is as follows:

- a) Focus the P855 with the intensifier switched off using sufficient intensity of illumination on the resolution test chart for viewing of the output by eye in a darkened room.
- b) Black out the input to the P855 and switch on the intensifier with the controls set initially to low gain. Afterglow in the P855 phosphor following its operation in stage (a) will mean that some time must be allowed for the afterglow to reduce to a low level before the intensifier is operated at maximum gain.

When using an electrostatic intensifier of the diode type, focusing only of the P855 is necessary as the intensifier will be in correct focus once its normal operating voltage is applied.

### iv E.H.T. Connections

In the normal mode of P855 operation the output phosphor and deflection electrode system is earthed while the photocathode, accelerating grid and focusing cone operate at high negative potential. This is the preferred method of operation when used with fibre optic coupled intensifiers as this limits the potential above earth at which the intensifier output is operated. With lens coupled intensifiers either end of the P855 tube can be operated at earth according to convenience.

When recording very weak luminous events requiring the use of an intensifier at high gain ( $>10^5$ ) great care must be taken to prevent the occurrence of corona discharges at or near the input which can give rise to a high noise signal. In these cases it may be necessary to earth the image intensifier cathode or use electrostatic screening procedures.

- v When recording intensely luminous events in either framing or sweeping modes the use of an intensifier is not normally necessary and the fluorescent image can be conveniently recorded by a fast emulsion using a wide aperture lens. In such cases an equivalent background input illumination (E.B.I.) of the order of  $10^{-4}$  lux ( $10^{-5}$  ft-candle), will not contribute a recordable noise signal.



If however very weak luminous transients have to be recorded it is often necessary to use a coupled intensifier operating with very high gain (possibly photon gain of  $10^6$ ). In this case an E.B.I. of  $10^{-7}$  lux ( $10^{-8}$  ft-candle), or lower may be necessary. For such applications the customer is recommended to ask for information.

## REFERENCES

- 1 V. V. Korobkin, A. A. Maljutin and M. Ya. Schelev, J. Phot. Sci. Vol. 17, p. 179 (1969).
- 2 B. R. C. Garfield, P. C. Bailey and R. Marshall. Proceedings of 5th Symposium on Photo-electronic Image Devices, Imperial College, London, September 1971.
- 3 D. J. Bradley et al., Proceedings of 5th Symposium on Photo-electronic Image Devices, Imperial College, London, September 1971.
- 4 'Developments in image tube high-speed framing cameras.' A. E. Huston and R. B. A. Harris. Proceedings of 5th Symposium on Photo-electronic Image Devices, Imperial College, September 1971.

## SCHEMATIC DIAGRAM

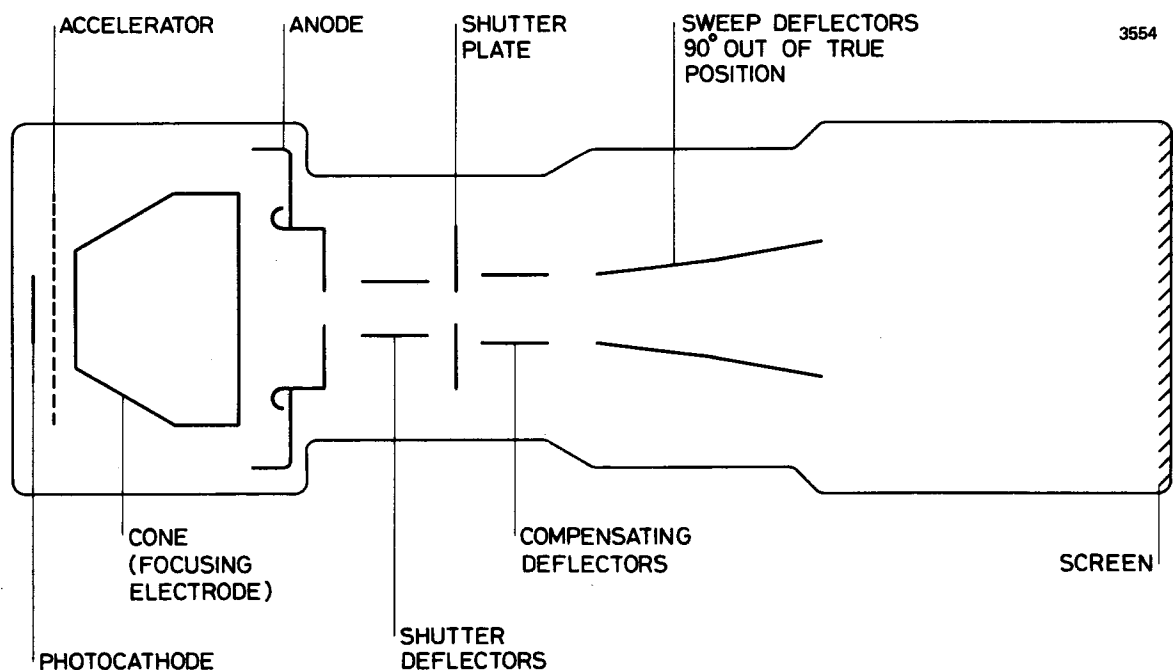

# OUTLINE

2178D

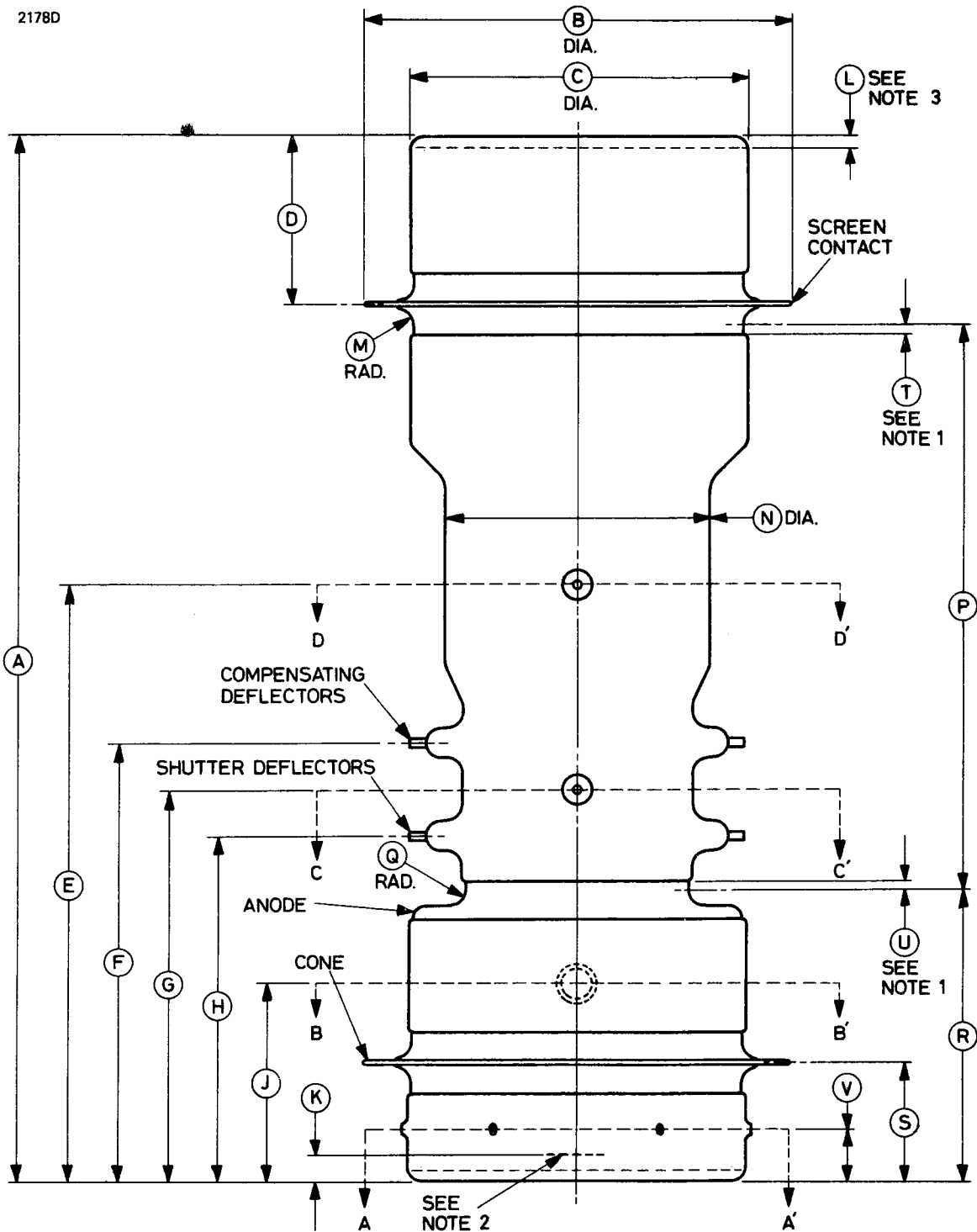

## Outline Notes

1. Recommended support position.
2. Plane of photocathode.
3. Thickness of faceplate glass at both photocathode and phosphor ends.

**Outline Dimensions (All dimensions without limits are nominal)**

Ref	Millimetres	Inches
A	312.0 <sup>+ 2.0</sup> <sub>- 0.0</sub>	12.283 <sup>+ 0.079</sup> <sub>- 0.000</sub>
B	128.0 max	5.039 max
C	102.0 ± 1.0	4.016 ± 0.039
D	50.0 ± 1.0	1.969 ± 0.039
E	178.0 ± 2.0	7.008 ± 0.079
F	131.0 ± 2.0	5.157 ± 0.079
G	117.0 ± 2.0	4.606 ± 0.079
H	105.0 ± 2.0	4.134 ± 0.079
J	59.0 ± 2.0	2.323 ± 0.079
K	9.0	0.354
L	4.0 ± 0.5	0.157 ± 0.020
M	4.0	0.157
N	80.0	3.150
P	170.0 ± 1.0	6.693 ± 0.039
Q	4.0	0.157
R	87.0 ± 1.0	3.425 ± 0.039
S	35.0 <sup>+ 1.0</sup> <sub>- 0.0</sub>	1.378 <sup>+ 0.039</sup> <sub>- 0.000</sub>
T	5.0	0.197
U	5.0	0.197
V	12.7 ± 1.0	0.500 ± 0.039

Inch dimensions have been derived from millimetres.

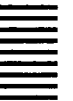

## Outline with Fibre-optic Output

2991

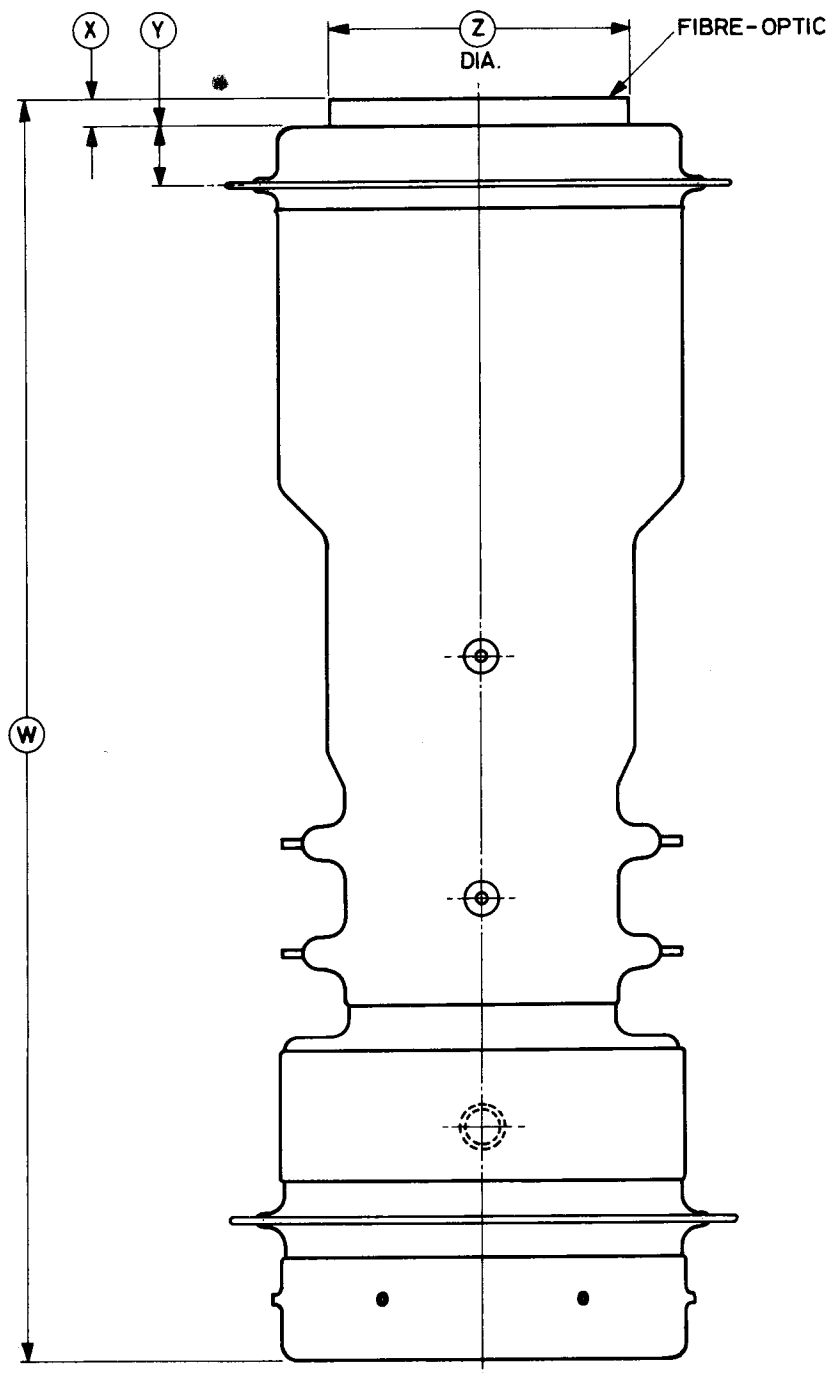

**Note** This drawing is not to scale for the 33mm and 45mm fibre-optics.

### Fibre-optic 33mm diameter

Ref	Millimetres	Inches
W	318.0 <sup>+ 2.0</sup> - 1.0	12.520 <sup>+ 0.079</sup> - 0.039
X	4.0 <sup>+ 0.0</sup> - 1.0	0.157 <sup>+ 0.000</sup> - 0.039
Y	14.6	0.575
Z	33.3	1.311

Inch dimensions have been derived from millimetres.

### Fibre-optic 45mm diameter

Ref	Millimetres	Inches
W	316.0 <sup>+ 2.0</sup> - 1.0	12.441 <sup>+ 0.079</sup> - 0.039
X	2.0 <sup>+ 0.0</sup> - 1.0	0.079 <sup>+ 0.000</sup> - 0.039
Y	14.6	0.575
Z	45.0	1.772

Inch dimensions have been derived from millimetres.

### Fibre-optic 75mm diameter

Ref	Millimetres	Inches
W	320.0 <sup>+ 2.0</sup> - 1.0	12.598 <sup>+ 0.079</sup> - 0.039
X	6.0 <sup>+ 0.0</sup> - 1.0	0.236 <sup>+ 0.000</sup> - 0.039
Y	14.6	0.575
Z	75.0	2.953

Inch dimensions have been derived from millimetres.

**All dimensions without limits are nominal**



# Outline Details

3789

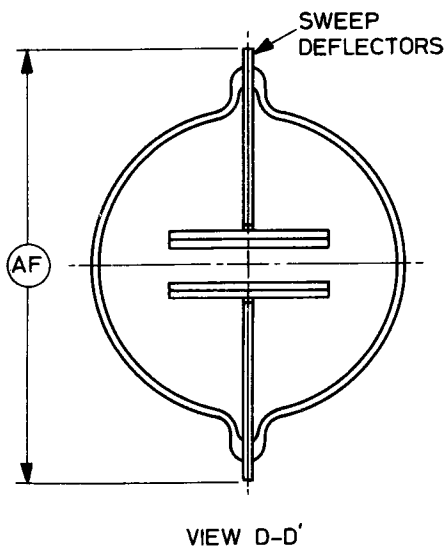
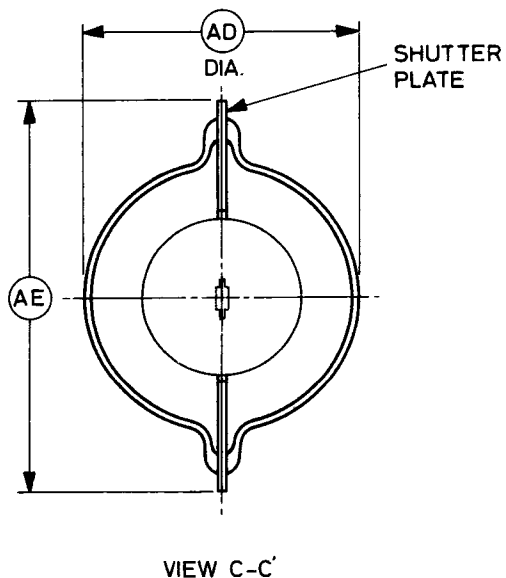
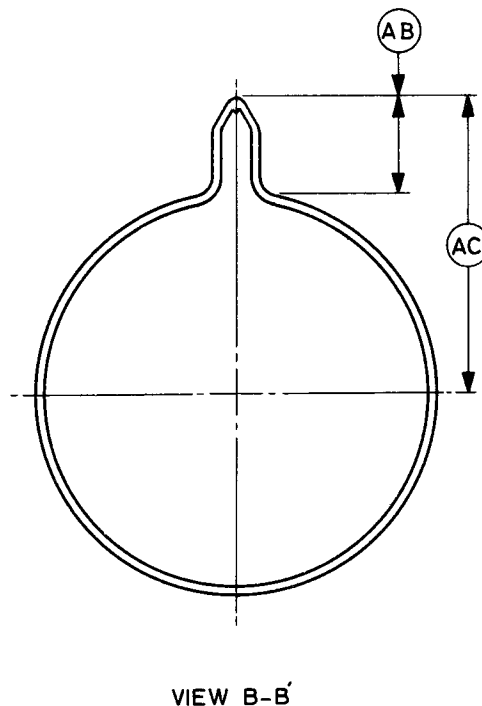
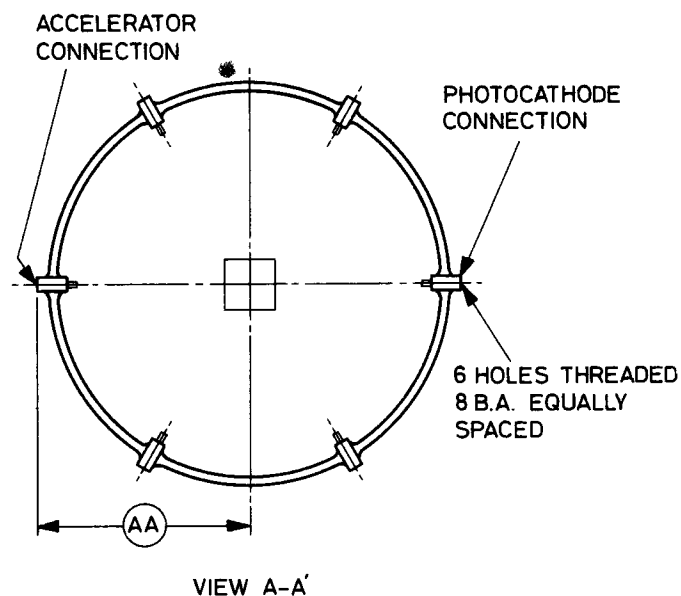

Ref	Millimetres	Inches	Ref	Millimetres	Inches
AA	53.0 ± 1.0	2.087 ± 0.039	AD	70.0	2.756
AB	24.0 max	0.945 max	AE	100.0 ± 1.0	3.937 ± 0.039
AC	75.0 ± 5.0	2.953 ± 0.197	AF	110.0 ± 1.0	4.331 ± 0.039

Inch dimensions have been derived from millimetres.

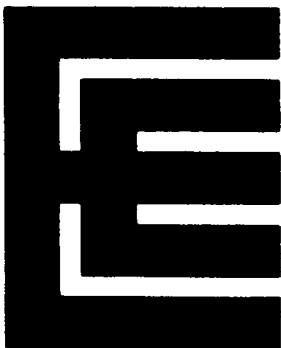

## SHUTTER TUBE

### INTRODUCTION

The P856 is an electrostatically focused triode image converter with electrostatic deflectors for both pulse and sweep operation. It is available with a choice of photocathode and can be supplied with a plain glass output faceplate or with fibre-optic outputs of various diameters (see note 1).

### GENERAL DATA

#### Photocathode

Standard type (see note 1)	S20
Useful area (see note 2)	11 x 9mm max
Refractive index of faceplate and photocathode support	1.48

#### Fluorescent Screen

Faceplate (see note 1)	flat, circular
Useful area (orientation set by sweep deflectors)	dependent on faceplate material (see note 1)
Phosphor	aluminised P11 (blue, medium short persistence)

#### Plate Capacitance

Capacitance of any plate to all others connected	8	pF max
--	---	--------

### MAXIMUM RATINGS

Photocathode voltage (see note 3)	-20	kV max
Cone (focusing electrode) voltage	-19.4	kV max
Light input for setting-up	0.5	ft-candle max

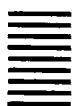

## TYPICAL OPERATION

### Operating Conditions

Photocathode voltage . . . . .	-18	kV
Cone voltage . . . . .	-17.5	kV

### Typical Performance

Exposure time per frame (see note 4) . . . . .	1.5	ns min
Repetition rate (with P11 phosphor) . . . . .	1	ms per sequence
S20 photocathode sensitivity (2854K tungsten light):		
typical . . . . .	75	$\mu\text{A}/\text{lm}$
minimum . . . . .	50	$\mu\text{A}/\text{lm}$
Electron-optical linear magnification at correct focus condition . . . . .	$2.0 \pm 0.13$	
Static resolution in useful screen area . . . . .	13 line pairs/mm	min
Equivalent light input (at 18kV) . . . . .	$10^{-5}$	ft-candles max
Output uniformity; maximum luminance variation in image of uniformly illuminated photocathode . . . . .	25	% of maximum
Deflection sensitivity:		
sweep deflectors . . . . .	$1/50$	mm/V
shutter deflectors . . . . .	$1/40$	mm/V
compensating deflectors (see note 5) . . . . .	$1/40$	mm/V

## NOTES

1. The P856 can be supplied with a choice of photocathode; the types available are listed in the following table. The photocathode is deposited on a flat substrate of high electrical conductivity and can provide high peak currents without defocusing.

The tube can also be supplied with a plain glass output faceplate or with fibre-optic outputs of various diameters as listed on page 3.

A substantial increase in overall sensitivity may be achieved by using a fibre-optic faceplate in direct contact with the film, instead of a lens system. The fibre-optics available for the P856 have a fibre size of  $16\mu\text{m}$ , numerical aperture nominally 1, and are flat to  $1\mu\text{m}$ .



Type	Output faceplate	Useful screen area	Photocathode type	Minimum sensitivity
P856/9	Plain glass	7.5 x 4cm	S9	15 $\mu$ A/lm
P856/9A	Fibre-optic 3.3cm	2 x 2cm	S9	15 $\mu$ A/lm
P856/9B	Fibre-optic 4.5cm	3 x 2.4cm	S9	15 $\mu$ A/lm
P856/9C	Fibre-optic 7.5cm	6 x 4cm	S9	15 $\mu$ A/lm
P856/11	Plain glass	7.5 x 4cm	S11	30 $\mu$ A/lm
P856/11A	Fibre-optic 3.3cm	2 x 2cm	S11	30 $\mu$ A/lm
P856/11B	Fibre-optic 4.5cm	3 x 2.4cm	S11	30 $\mu$ A/lm
P856/11C	Fibre-optic 7.5cm	6 x 4cm	S11	30 $\mu$ A/lm
P856/20	Plain glass	7.5 x 4cm	S20	50 $\mu$ A/lm
P856/20A	Fibre-optic 3.3cm	2 x 2cm	S20	50 $\mu$ A/lm
P856/20B	Fibre-optic 4.5cm	3 x 2.4cm	S20	50 $\mu$ A/lm
P856/20C	Fibre-optic 7.5cm	6 x 4cm	S20	50 $\mu$ A/lm

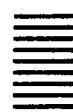

2. Any regular photocathode shape within a rectangle 11 x 7.5mm can be supplied to order. The number of frames per sequence depends on the size of the image and is typically 8 frames 15mm square at the screen (for a 7.5mm square cathode) or 16 frames 7.4 x 15mm at the screen for a 3.7 x 7.5mm cathode.

- The output end of the tube is operated at earth potential to simplify safety precautions in the equipment design.
- A camera designed to use the P856 can be supplied by J. Hadland Ltd., Bovington, Herts., England. The following models of this camera, the Imacon\*, are available:

Camera	Exposure Time	Operating Mode
Standard Imacon	10 ns	Brit. Pat. 1016930
Imacon to order	3 ns	Brit. Pat. 1143444
Imacon to order	1.5ns	Patent applied for

\* Ref. 'The Imacon and New Image Converter Cameras' by Mr. A. Huston and Dr. S. Majumdar, at the 8th International Congress of High Speed Photography at Stockholm in 1968.

- The deflection sensitivities of the shutter and compensating plates are matched to within 5% (normally 1%).

## X-RAY WARNING

High voltage devices such as the P856 produce X-rays which can constitute a health hazard, and may require shielding.

## SCHEMATIC DIAGRAM

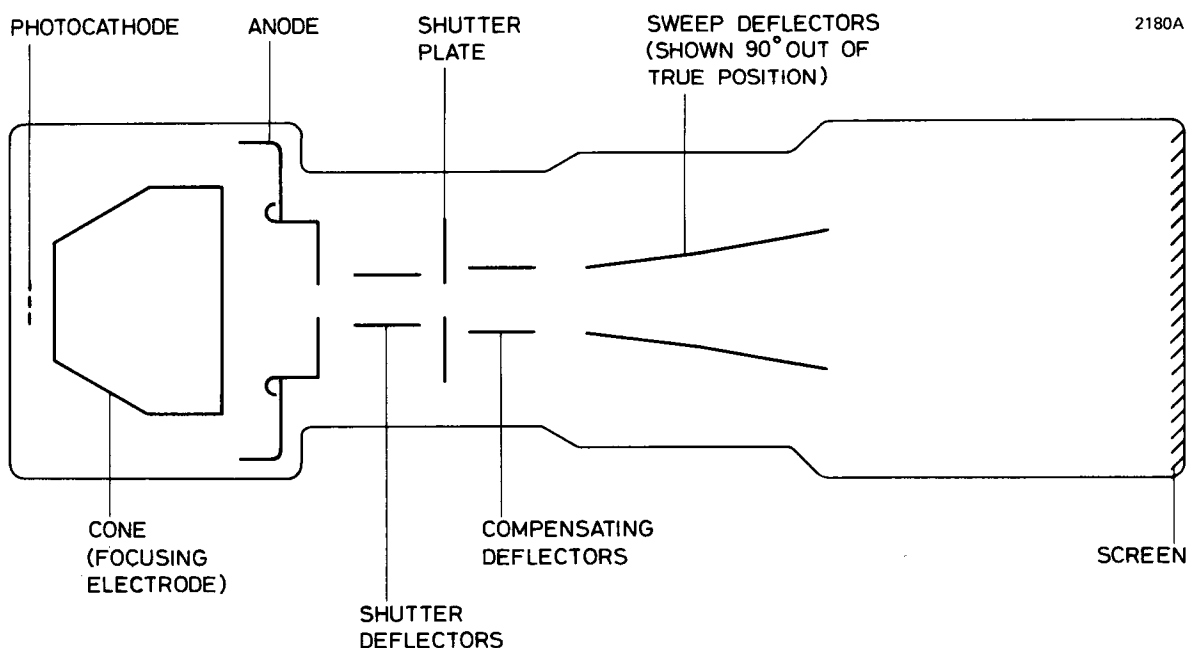

# OUTLINE (See page 7 for dimensions)

2178D

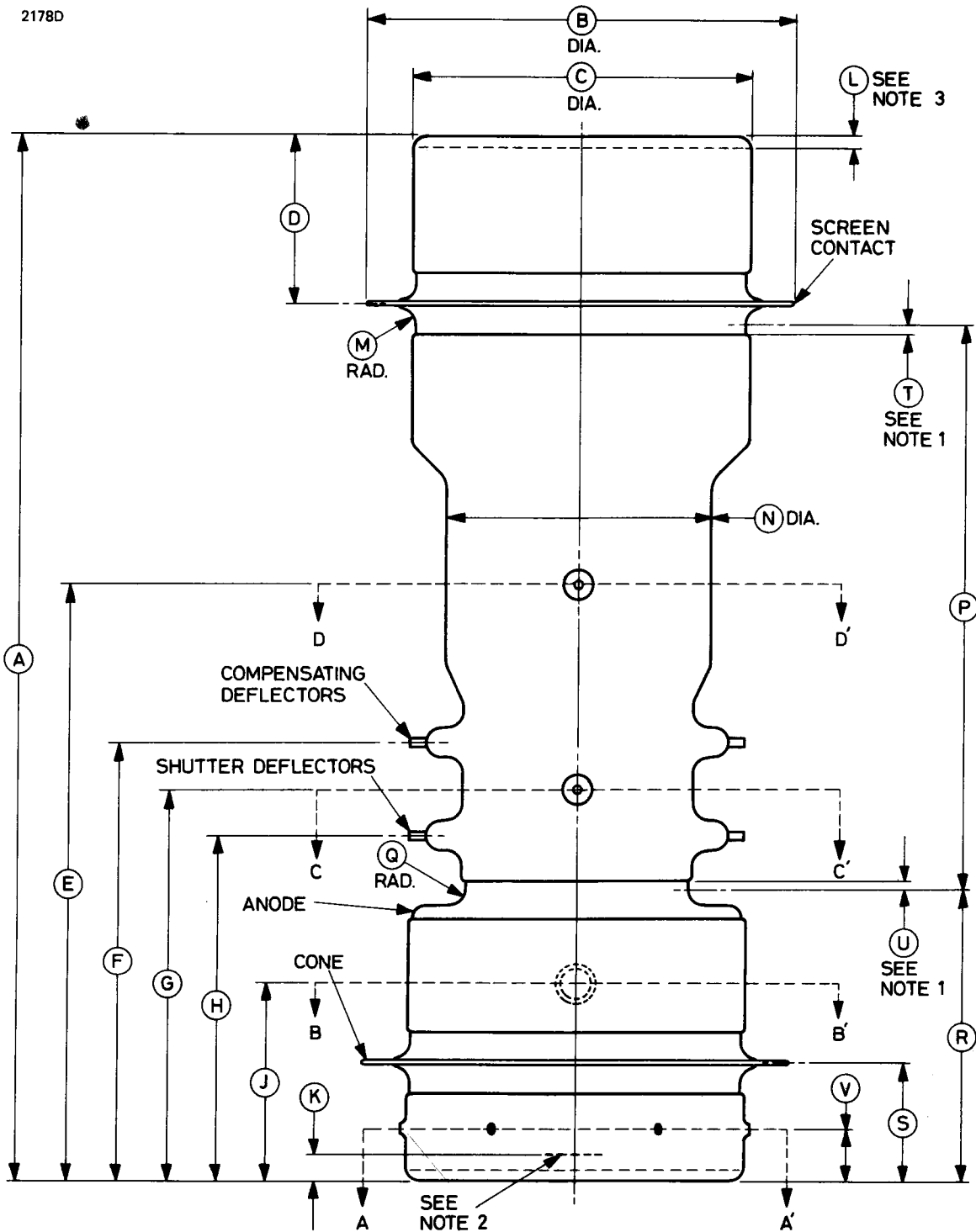

## Outline Notes

1. Recommended support position.
2. Plane of photocathode.
3. Thickness of faceplate glass at both photocathode and phosphor ends.

## Outline with Fibre-optic Output

2991

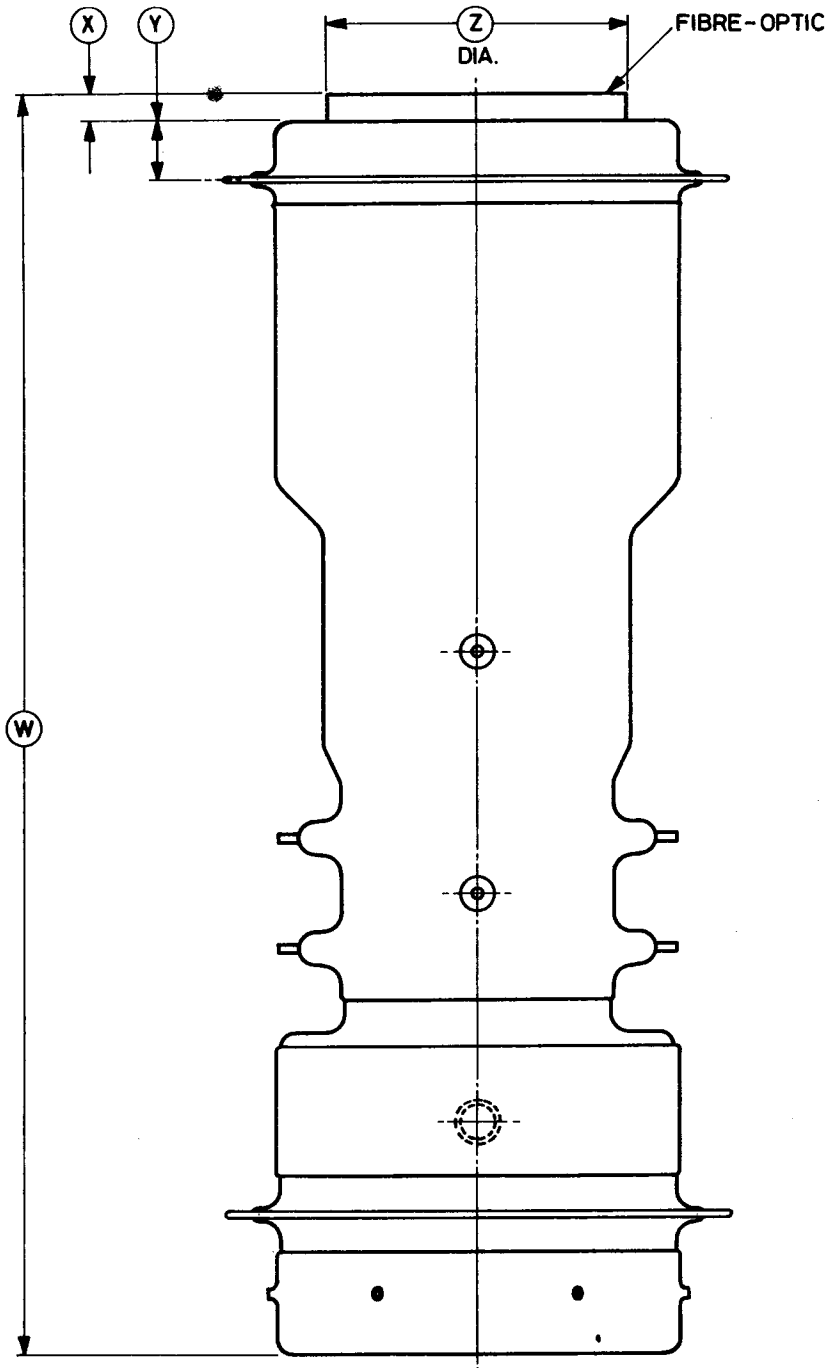

**Note** This drawing is not to scale for the 33mm and 45mm fibre-optics.

**Outline Dimensions (All dimensions without limits are nominal)**

Inch dimensions have been derived from millimetres.

Ref	Millimetres	Inches	Ref	Millimetres	Inches
A	312.0 <sup>+2.0</sup> -0.0	12.283 <sup>+0.079</sup> -0.000	L	4.0 ± 0.5	0.157 ± 0.020
B	128.0 max	5.039 max	M	4.0	0.157
C	102.0 ± 1.0	4.016 ± 0.039	N	80.0	3.150
D	50.0 ± 1.0	1.969 ± 0.039	P	170.0 ± 1.0	6.693 ± 0.039
E	178.0 ± 2.0	7.008 ± 0.079	Q	4.0	0.157
F	131.0 ± 2.0	5.157 ± 0.079	R	87.0 ± 1.0	3.425 ± 0.039
G	117.0 ± 2.0	4.606 ± 0.079	S	35.0 <sup>+1.0</sup> -0.0	1.378 <sup>+0.039</sup> -0.000
H	105.0 ± 2.0	4.134 ± 0.079	T	5.0	0.197
J	59.0 ± 2.0	2.323 ± 0.079	U	5.0	0.197
K	9.0	0.354	V	12.7 ± 1.0	0.500 ± 0.039

**Fibre-optic 33mm diameter**

Ref	Millimetres	Inches
W	318 <sup>+2.0</sup> -1.0	12.520 <sup>+0.079</sup> -0.039
X	4.0 <sup>+0.0</sup> -1.0	0.158 <sup>+0.000</sup> -0.039
Y	14.6	0.575
Z	33.3	1.311

**Fibre-optic 45mm diameter**

Ref	Millimetres	Inches
W	316 <sup>+2.0</sup> -1.0	12.441 <sup>+0.079</sup> -0.039
X	2.0 <sup>+0.0</sup> -1.0	0.079 <sup>+0.000</sup> -0.039
Y	14.6	0.575
Z	45.0	1.772

**Fibre-optic 75mm diameter**

Ref	Millimetres	Inches
W	320.0 <sup>+2.0</sup> -1.0	12.598 <sup>+0.079</sup> -0.039
X	6.0 <sup>+0.0</sup> -1.0	0.236 <sup>+0.000</sup> -0.039
Y	14.6	0.575
Z	75.0	2.953



# Outline Details

2179C

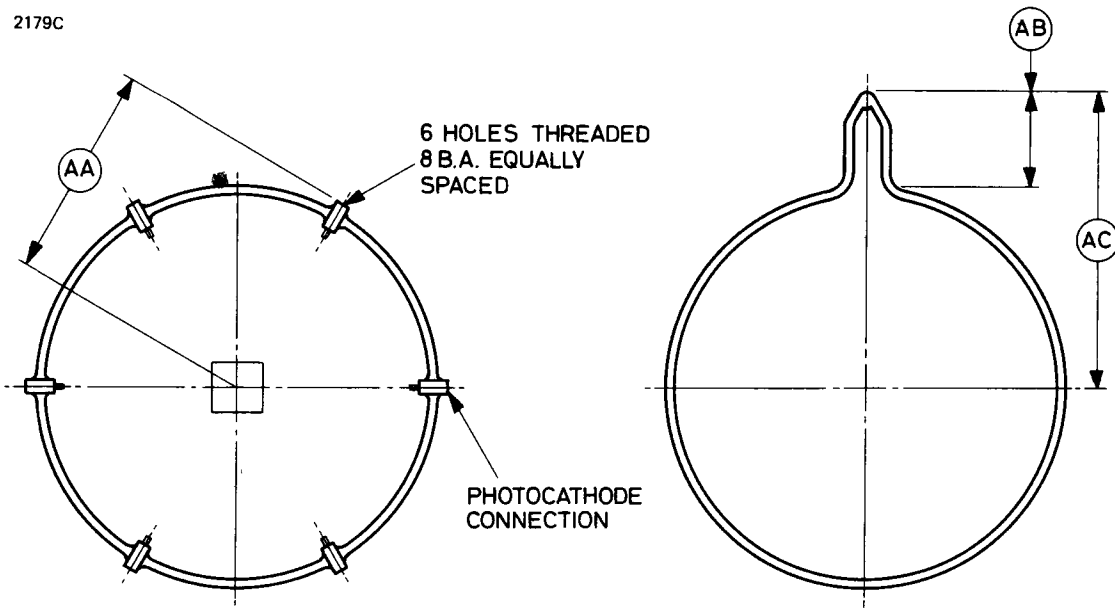

VIEW A-A'

VIEW B-B'

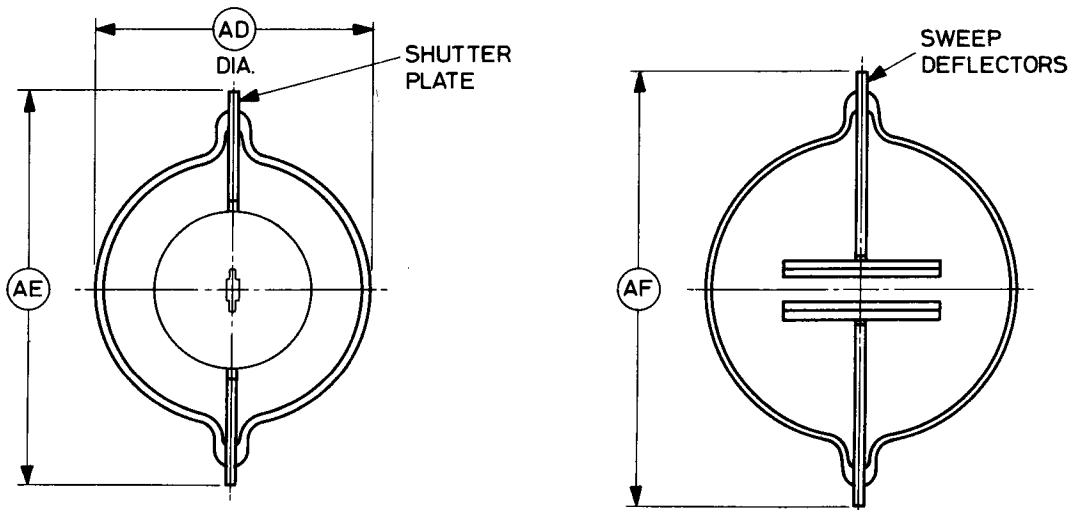

VIEW C-C'

VIEW D-D'

Ref	Millimetres	Inches
AA	53.0 ± 1.0	2.087 ± 0.039
AB	24.0 max	0.945 max
AC	75.0 ± 5.0	2.953 ± 0.197
AD	70.0	2.756
AE	100.0 ± 1.0	3.937 ± 0.039
AF	110.0 ± 1.0	4.331 ± 0.039

Inch dimensions have been derived from millimetres.

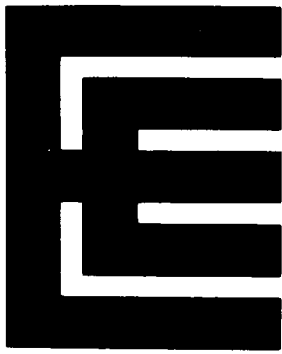

## IMAGE INTENSIFIER

### DESCRIPTION

The P896 is a three stage, fibre-optic coupled image intensifier assembly. The electrostatically focused modules are encapsulated in silicone rubber together with an e.h.t. multiplier circuit to form a rugged, compact, lightweight device. The input and output windows are fibre-optic plates.

The tube is designed for night vision applications but may be used for any low light level application. A special version can be made for coupling to a fibre-optic vidicon or other camera tube for remote viewing.



### GENERAL DATA

#### Photocathode

Surface . . . . .	S20 with enhanced red response	
Luminous sensitivity (see note 1) . . . . .	175	$\mu\text{A/l min}$
Radiant sensitivity:		
at 800nm . . . . .	10	$\text{mA/W min}$
at 850nm . . . . .	3.0	$\text{mA/W min}$
Useful photocathode diameter . . . . .	23	mm

#### Screen

Phosphor . . . . .	P20
Fluorescent colour . . . . .	yellow-green
Persistence . . . . .	medium-short

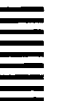

## Characteristics

Luminous gain (see note 2)	1.1 x 10 <sup>4</sup>	cd/lm min
Resolution at centre	25	line pairs/mm min
Equivalent (background) light input	2 x 10 <sup>-7</sup>	lux
Magnification at centre	0.82 to 1.00	
Distortion (see note 3)	25	% max

## Mechanical

Overall length	196	mm max
Overall diameter	70	mm max
Net weight	880	g max
Mounting position		any

## Operating Conditions

Input voltage (peak to peak) (see note 4)	2.7 ± 0.1	kV
Frequency of input voltage (see note 4)	1.2 to 2.0	kHz
Ambient temperature (operating)	-54 to +35	°C
Photocathode illumination (see note 5)	5 x 10 <sup>-3</sup>	lux max
Storage temperature:		
less than 2 hours	-54 to +68	°C
prolonged	-54 to +35	°C

## NOTES

1. Using C.I.E. Illuminant A, a tungsten filament lamp of colour temperature 2854K.

2. Luminous gain =  $\frac{\text{normal screen brightness}}{\text{photocathode illumination}}$

where the photocathode illumination is 1 x 10<sup>-4</sup> to 3 x 10<sup>-4</sup> lux.

3. The distortion is given by  $\frac{M_{20} - M_2}{M_2} \times 100\%$

where M<sub>2</sub> is the observed magnification of a 2mm diameter circle and M<sub>20</sub> is the observed magnification of a 20mm diameter circle, both concentric with the input fibre optic.

4. A very compact oscillator, with a suitable socket for the tube, can be supplied. This unit operates from a 6.75V d.c. supply; since the current required is only a few milliamperes a mercury cell is suitable.



5. These tubes are not provided with an internal protection circuit. Automatic brightness control can be applied by using a special oscillator with poor regulation to supply the input voltage.

## OUTLINE

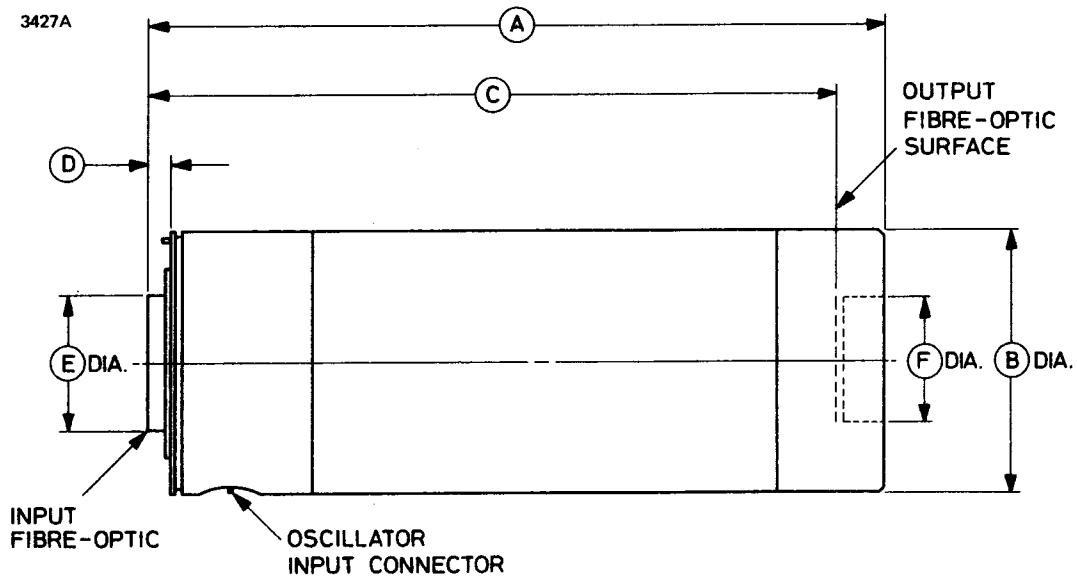

Ref	Millimetres	Inches
A	196.0 max	7.717 max
B	70.0 max	2.756 max
C	183.0 max	7.205 max
D	6.1 nom	0.240 nom
E	35.7 max	1.406 max
F	32.7 min	1.287 min

Inch dimensions have been derived from millimetres.

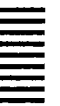

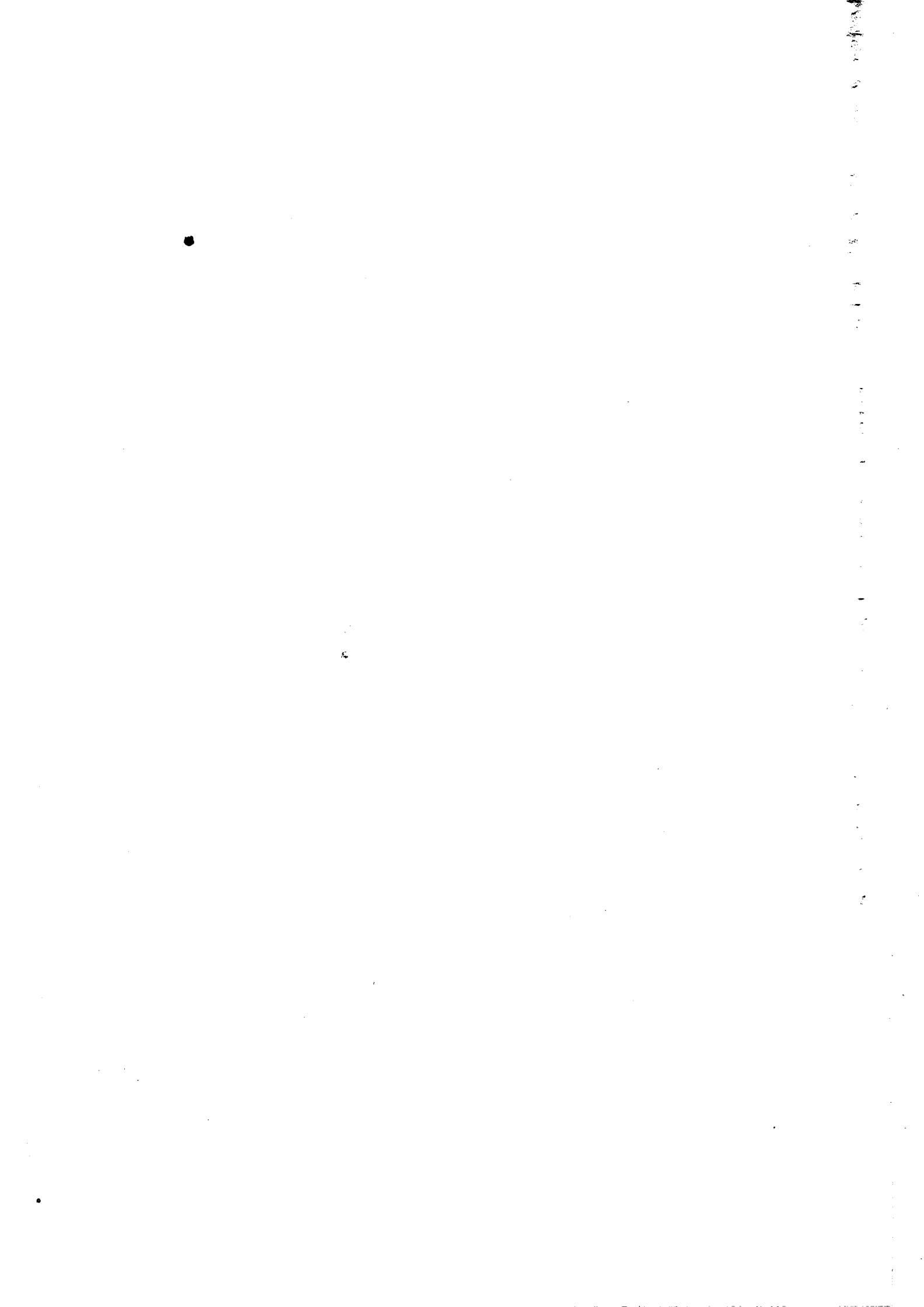

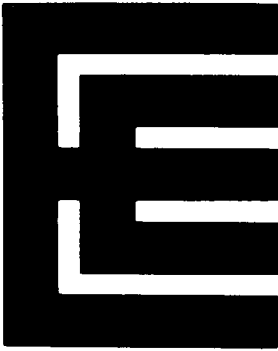

## IMAGE INTENSIFIER

### DESCRIPTION

The P896B is a three stage, fibre-optic coupled image intensifier assembly. The electrostatically focused modules are encapsulated in silicone rubber together with an e.h.t. multiplier circuit to form a rugged, compact, light-weight device. The input and output windows are fibre-optic plates.

The tube is designed for night vision but may be used for any low light level application. A special version can be made for coupling to a fibre-optic vidicon or other camera tube for remote viewing.

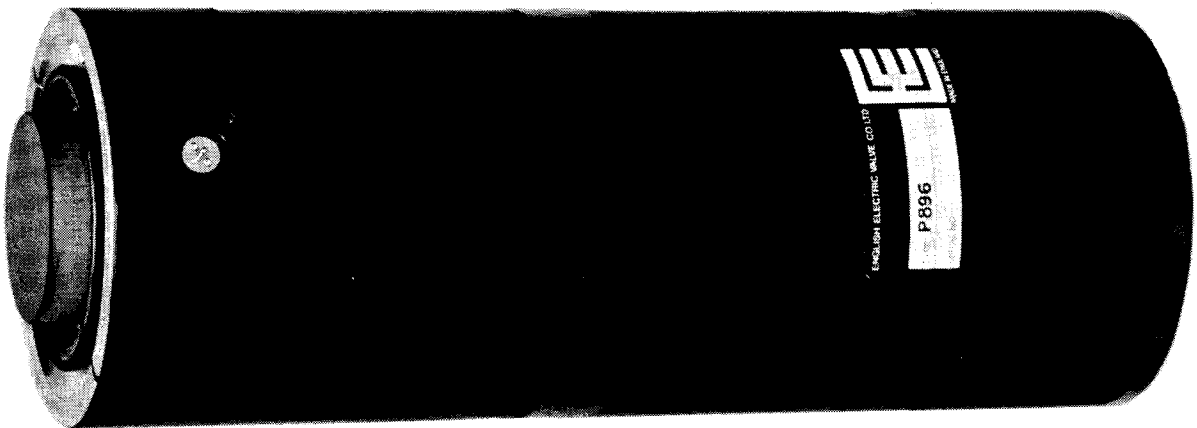

### GENERAL DATA

#### Photocathode

Surface . . . . .	S20 with enhanced red response	
Luminous sensitivity (see note 1) . . . . .	175	$\mu\text{A}/\text{lm min}$
Radiant sensitivity:		
at 800nm . . . . .	10	$\text{mA}/\text{W min}$
at 850nm . . . . .	3.0	$\text{mA}/\text{W min}$
Useful photocathode diameter . . . . .	23	mm

#### Screen

Phosphor . . . . .	P20
Fluorescent colour . . . . .	yellow-green
Persistence . . . . .	medium-short

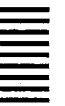

## Characteristics

Luminous gain (see note 2)	6.5 x 10 <sup>3</sup>	cd/lm min
Resolution at centre	23	line pairs/mm min
Equivalent (background) light input	2 x 10 <sup>-7</sup>	lux
Magnification at centre	0.82 to 1.00	
Distortion (see note 3)	25	% max

## Mechanical

Overall length	196	mm max
Overall diameter	70	mm max
Net weight	900	g max
Mounting position		any

## Operating Conditions

Input voltage (peak to peak) (see note 4)	2.7 ± 0.1	kV
Frequency of input voltage (see note 4)	1.2 to 2.0	kHz
Ambient temperature (operating)	-54 to +35	°C
Photocathode illumination (see note 5)	5 x 10 <sup>-3</sup>	lux max
Storage temperature:		
less than 2 hours	-54 to +68	°C
prolonged	-54 to +35	°C

## NOTES

1. Using C.I.E. Illuminant A, a tungsten filament lamp of colour temperature 2854K.

2. Luminous gain =  $\frac{\text{normal screen brightness}}{\text{photocathode illumination}}$

where the photocathode illumination is 1 x 10<sup>-4</sup> to 3 x 10<sup>-4</sup> lux.

3. The distortion is given by  $\frac{M_{20} - M_2}{M_2} \times 100\%$

where M<sub>2</sub> is the observed magnification of a 2mm diameter circle and M<sub>20</sub> is the observed magnification of a 20mm diameter circle, both concentric with the input fibre optic.

4. A very compact oscillator, with a suitable socket for the tube, can be supplied. This unit operates from a 6.75V d.c. supply; since the current required is only a few milliamperes a mercury cell is suitable.

5. These tubes are not provided with an internal protection circuit. Automatic brightness control can be applied by using a special oscillator with poor regulation to supply the input voltage.

## OUTLINE

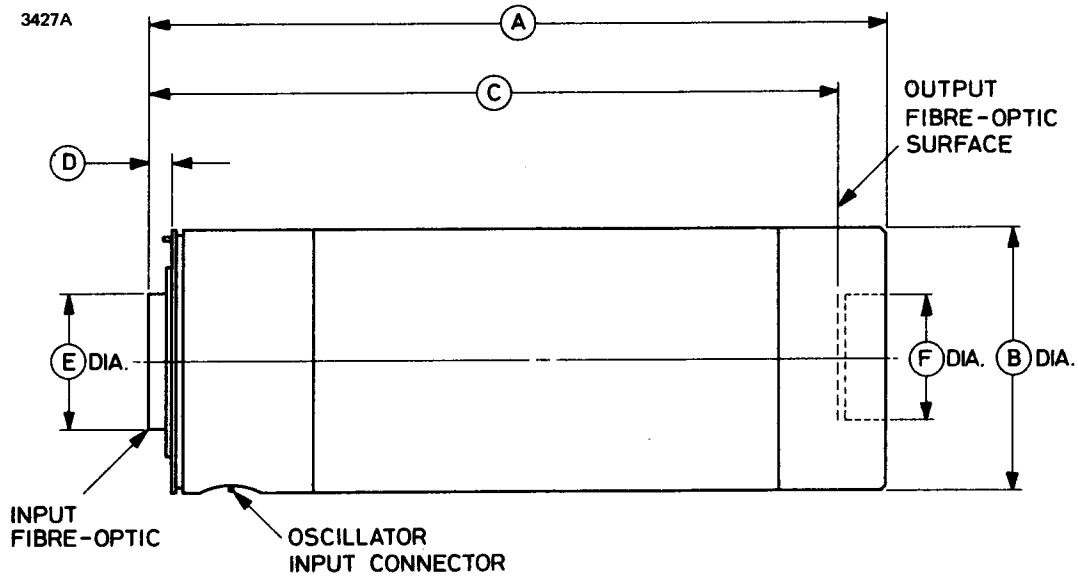

Ref	Millimetres	Inches
A	196.0 max	7.717 max
B	70.0 max	2.756 max
C	183.0 max	7.205 max
D	6.1 nom	0.240 nom
E	35.7 max	1.406 max
F	32.7 min	1.287 min

Inch dimensions have been derived from millimetres.

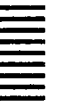

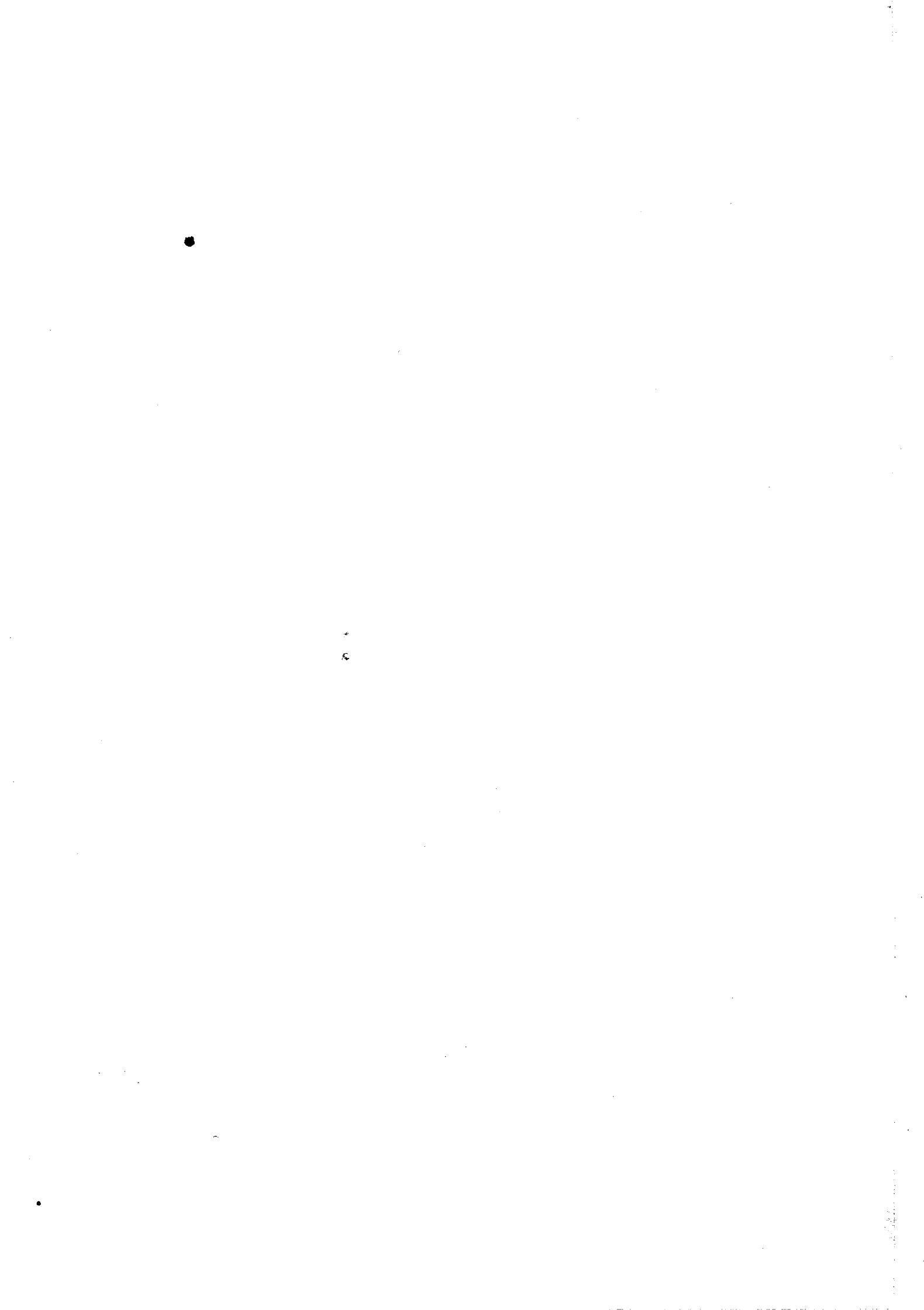

# Glow Modulators







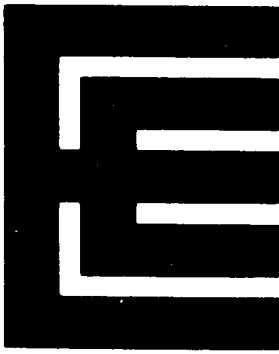

## GLOW MODULATOR

### INTRODUCTION

The 1B59 is a cold cathode glow modulator tube with an international octal base. The hollow cathode contained in the tube provides a high ionization density and forms a compact light source with an equivalent luminous intensity of 0.3 candela at 30mA cathode current.

A particular feature of its characteristics is the substantially linear relationship between the light output and the cathode current. This, together with the high frequency and directional characteristics of the tube, makes the 1B59 suitable for numerous industrial and communications applications, including facsimile equipments and photo-electric counters.

### GENERAL DATA

#### Characteristics

Maximum open circuit supply voltage . . . . .	300	V
Maximum breakdown voltage . . . . .	225	V
Maximum maintaining voltage (at 30mA d.c.) . . . . .	150	V
Typical maintaining voltage (at 30mA d.c.) . . . . .	130	V
Maximum average cathode current . . . . .	35	mA
Minimum cathode current . . . . .	5.0	mA
Maximum peak cathode current . . . . .	75	mA
Modulating frequency range . . . . .	up to 10 <sup>6</sup>	Hz
Equivalent luminous intensity, blue-violet (at 30mA d.c.)* . . . . .	0.3	cd
Equivalent luminance, blue-violet (at 30mA d.c.)* . . . . .	1.70 x 10 <sup>5</sup>	cd/m <sup>2</sup>
	110	cd/in <sup>2</sup>
Colour of discharge . . . . .	mainly blue-violet	
Average life (at 30mA d.c.) . . . . .	250	hours

#### Mechanical

Overall length . . . . .	3.060 inches (77.72mm) max
Overall diameter . . . . .	1.253 inches (31.83mm) max
Light source (end viewing):	
diameter . . . . .	0.056 inch (1.43mm) nom
distance from end of bulb . . . . .	0.312 inch (7.93mm) max
Mounting position . . . . .	any
Base . . . . .	2 pin international octal

\* The amount of blue-violet light emitted is equivalent to that of a black body with luminous intensity 0.3cd and colour temperature 2870°K.



# TYPICAL LIGHT OUTPUT CHARACTERISTIC

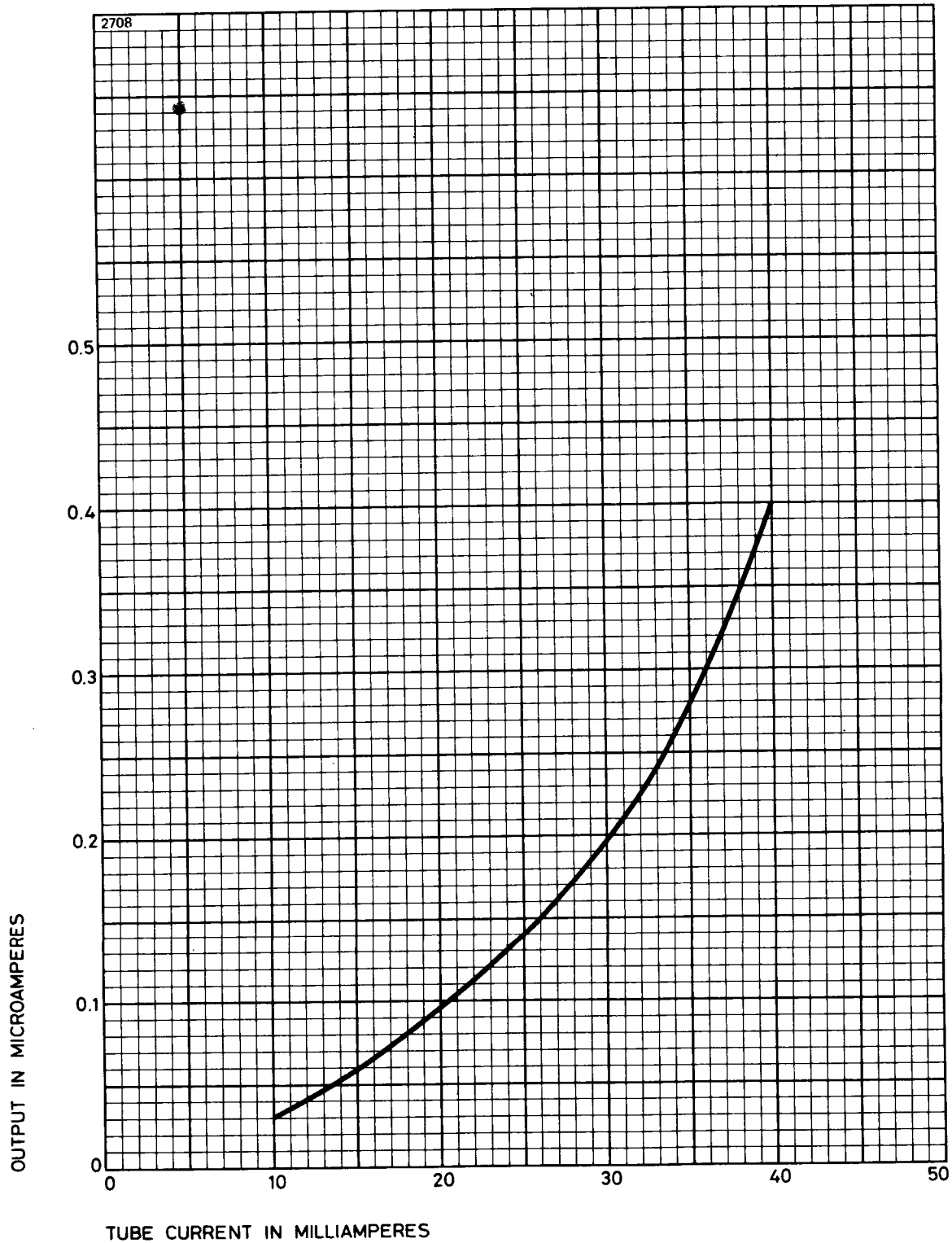

The light output of the glow modulator is expressed as the current through a type 929 photo tube with a Wratten C5 filter between the tubes, the glass envelopes of which are 0.562 inch (14.3mm) apart.

**OUTLINE (All dimensions without limits are nominal)**

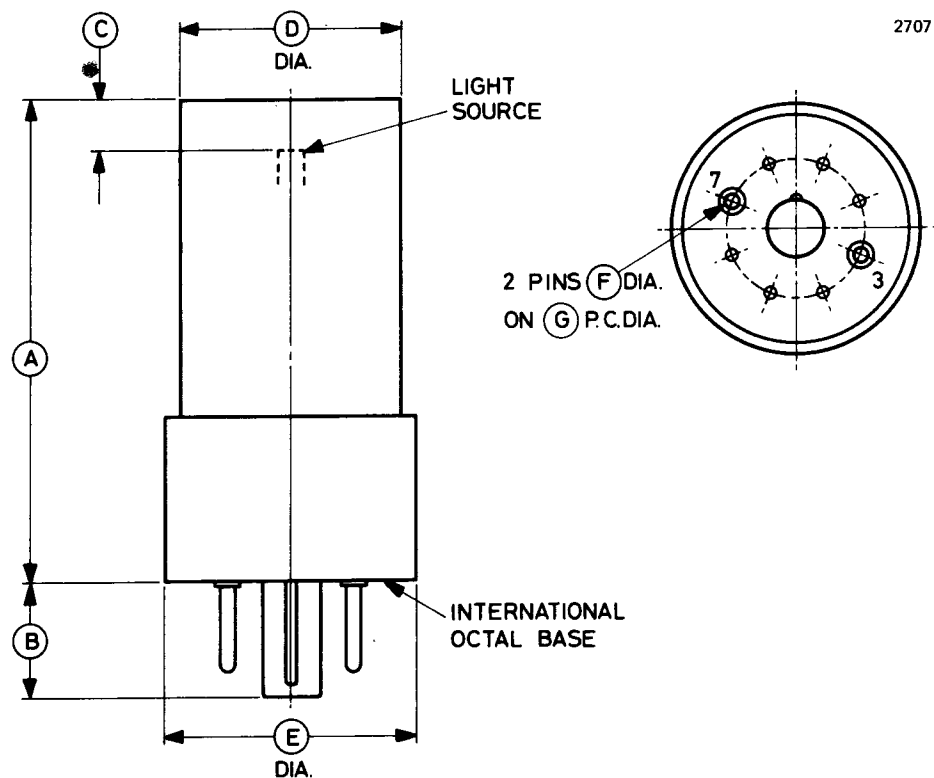

Ref	Inches	Millimetres
A	2.375 ± 0.125	60.33 ± 3.18
B	0.560	14.22
C	0.250 ± 0.063	6.35 ± 1.60
D	1.142 max	29.01 max
E	1.253 max	31.83 max
F	0.093	2.36
G	0.687	17.45

Millimetre dimensions have been derived from inches.

Pin	Element
1	Omitted
2	Omitted
3	Cathode
4	Omitted
5	Omitted
6	Omitted
7	Anode
8	Omitted

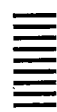





## GLOW MODULATOR

### INTRODUCTION

The XL601 is a cold cathode glow modulator tube with an international octal base. The hollow cathode contained in the tube provides a high ionization density and forms a compact light source with an equivalent luminous intensity of 0.27 candela at 30mA cathode current.

A particular feature of its characteristics is the substantially linear relationship between the light output and the cathode current. This, together with the high frequency and directional characteristics of the tube, makes the XL601 suitable for numerous industrial and communications applications, including facsimile equipments and photo-electric counters.

### GENERAL DATA

#### Characteristics

Maximum open circuit supply voltage . . . . .	300	V
Maximum breakdown voltage . . . . .	225	V
Maximum maintaining voltage (at 20mA d.c.) . . . . .	150	V
Typical maintaining voltage (at 20mA d.c.) . . . . .	120	V
Maximum average cathode current . . . . .	30	mA
Minimum cathode current . . . . .	0.25	mA
Maximum peak cathode current . . . . .	45	mA
Modulating frequency range . . . . .	up to 10 <sup>6</sup>	Hz
Equivalent luminous intensity, blue-violet (at 30mA d.c.)* . . . . .	0.27	cd
Equivalent luminance, blue-violet (at 30mA d.c.)* . . . . .	8.52 x 10 <sup>5</sup>	cd/m <sup>2</sup>
	550	cd/in <sup>2</sup>
Colour of discharge . . . . .	mainly blue-violet	
Average life (at 15mA d.c.) . . . . .	100	hours

#### Mechanical

Overall length . . . . .	3.060 inches (77.72mm) max
Overall diameter . . . . .	1.253 inches (31.83mm) max
Light source (end viewing):	
diameter . . . . .	0.025 inch (0.635mm) nom
distance from end of bulb . . . . .	0.312 inch (7.93mm) max
Mounting position . . . . .	any
Base . . . . .	2 pin international octal

\* The amount of blue-violet light emitted is equivalent to that of a black body with luminous intensity 0.27cd and colour temperature 2870° K.

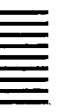

## TYPICAL LIGHT OUTPUT CHARACTERISTIC

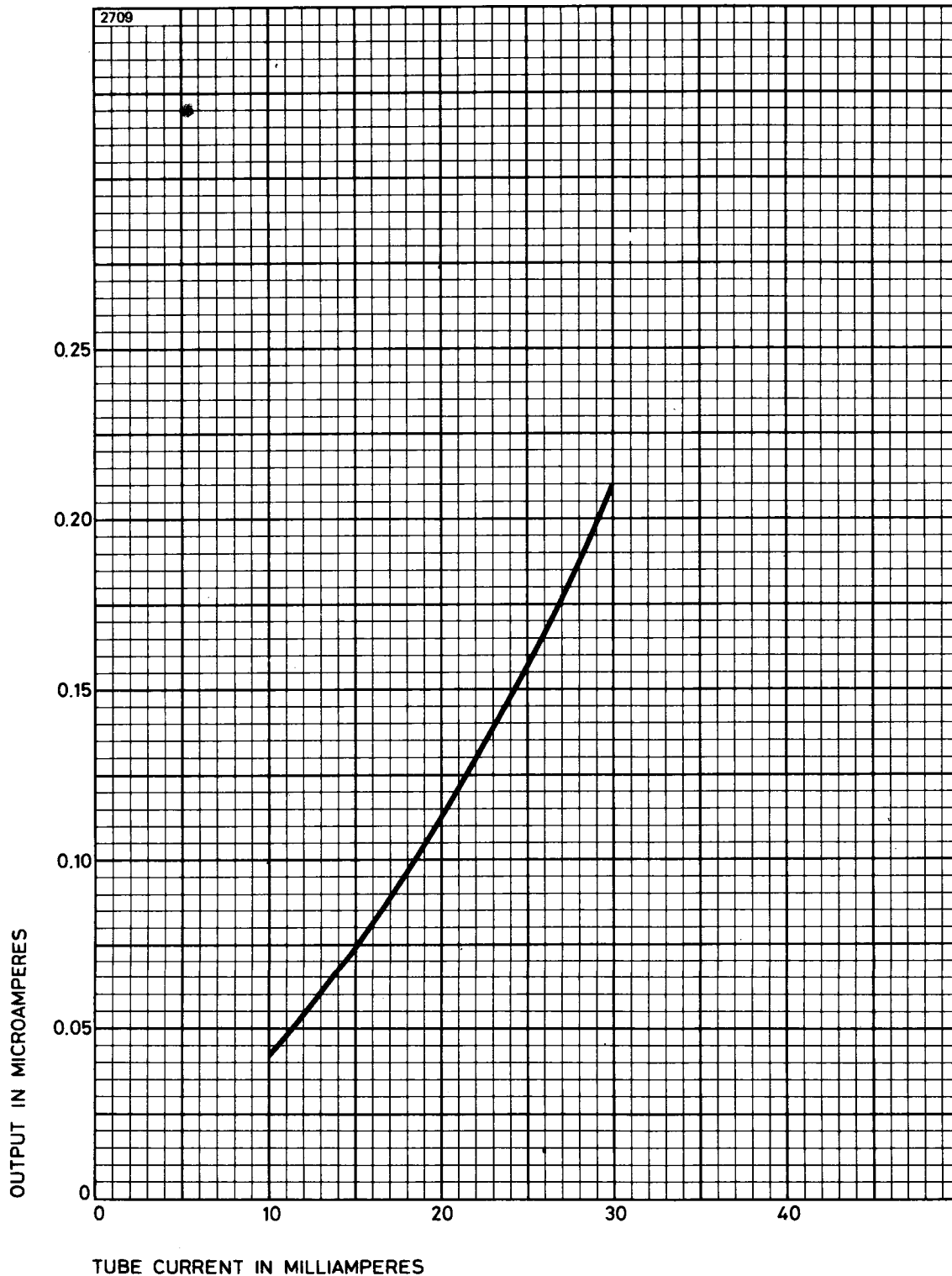

The light output of the glow modulator is expressed as the current through a type 929 photo tube with a Wratten C5 filter between the tubes, the glass envelopes of which are 0.562 inch (14.3mm) apart.

**OUTLINE (All dimensions without limits are nominal)**

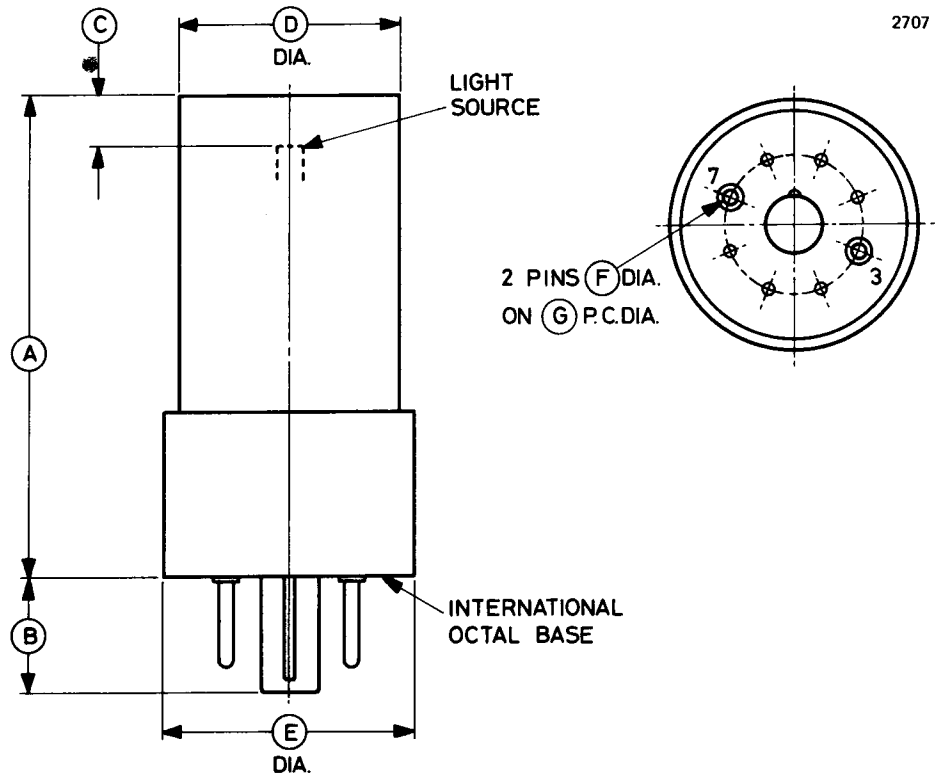

Ref	Inches	Millimetres
A	2.375 ± 0.125	60.33 ± 3.18
B	0.560	14.22
C	0.250 ± 0.063	6.35 ± 1.60
D	1.142 max	29.01 max
E	1.253 max	31.83 max
F	0.093	2.36
G	0.687	17.45

Millimetre dimensions have been derived from inches.

Pin	Element
1	Omitted
2	Omitted
3	Cathode
4	Omitted
5	Omitted
6	Omitted
7	Anode
8	Omitted

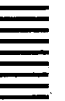

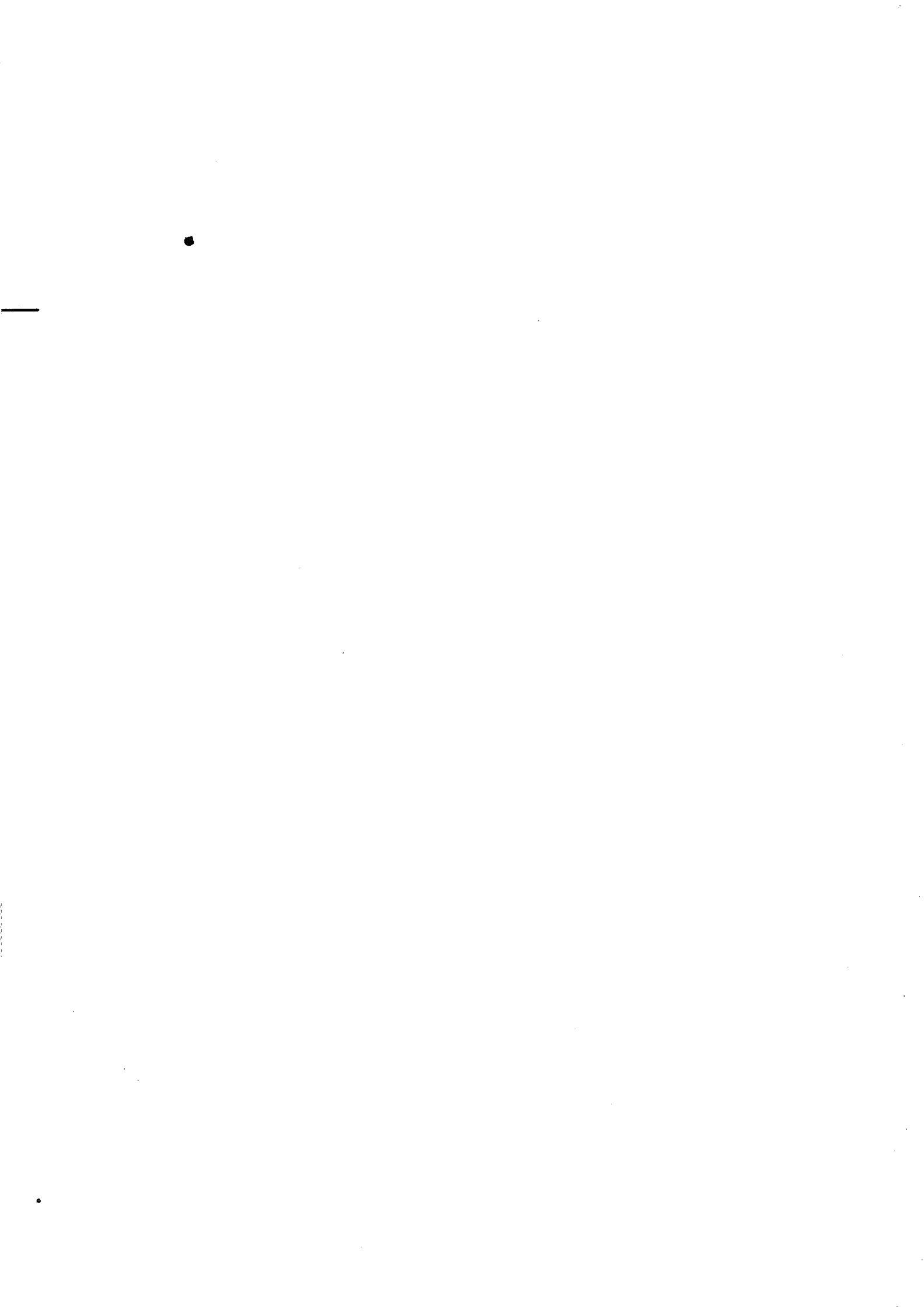



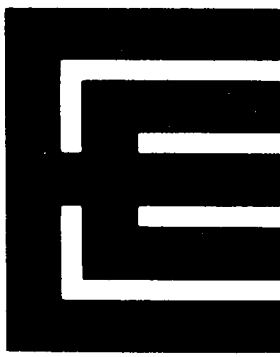

## GLOW MODULATOR

### INTRODUCTION

The XL602 is a cold cathode glow modulator tube with an international octal base. It is similar to type 1B59 but gives improved light output. The hollow cathode contained in the tube provides a high ionization density and forms a compact light source with an equivalent luminous intensity of 0.375 candela at 30mA cathode current.

A particular feature of its characteristics is the substantially linear relationship between the light output and the cathode current. This, together with the high frequency and directional characteristics of the tube, makes the XL602 suitable for numerous industrial and communications applications, including facsimile equipments and photo-electric counters.

### GENERAL DATA

#### Characteristics

Maximum open circuit supply voltage . . . . .	300	V
Maximum breakdown voltage . . . . .	225	V
Maximum maintaining voltage (at 30mA d.c.) . . . . .	150	V
Typical maintaining voltage (at 30mA d.c.) . . . . .	130	V
Maximum average cathode current . . . . .	30	mA
Minimum cathode current . . . . .	5.0	mA
Maximum peak cathode current . . . . .	75	mA
Modulating frequency range . . . . .	up to 10 <sup>6</sup>	Hz
Equivalent luminous intensity, blue-violet (at 30mA d.c.)* . . . . .	0.375	cd
Equivalent luminance, blue-violet (at 30mA d.c.)*	2.12 x 10 <sup>5</sup>	cd/m <sup>2</sup>
	137	cd/in <sup>2</sup>
Colour of discharge . . . . .	mainly blue-violet	

#### Mechanical

Overall length . . . . .	3.060 inches (77.72mm) max
Overall diameter . . . . .	1.253 inches (31.83mm) max
Light source (end viewing):	
diameter . . . . .	0.059 inch (1.5mm) nom
distance from end of bulb . . . . .	0.312 inch (7.93mm) max
Mounting position . . . . .	any
Base . . . . .	2 pin international octal

\* The amount of blue-violet light emitted is equivalent to that of a black body with luminous intensity 0.375cd and colour temperature 2870°K.



## TYPICAL LIGHT OUTPUT CHARACTERISTIC

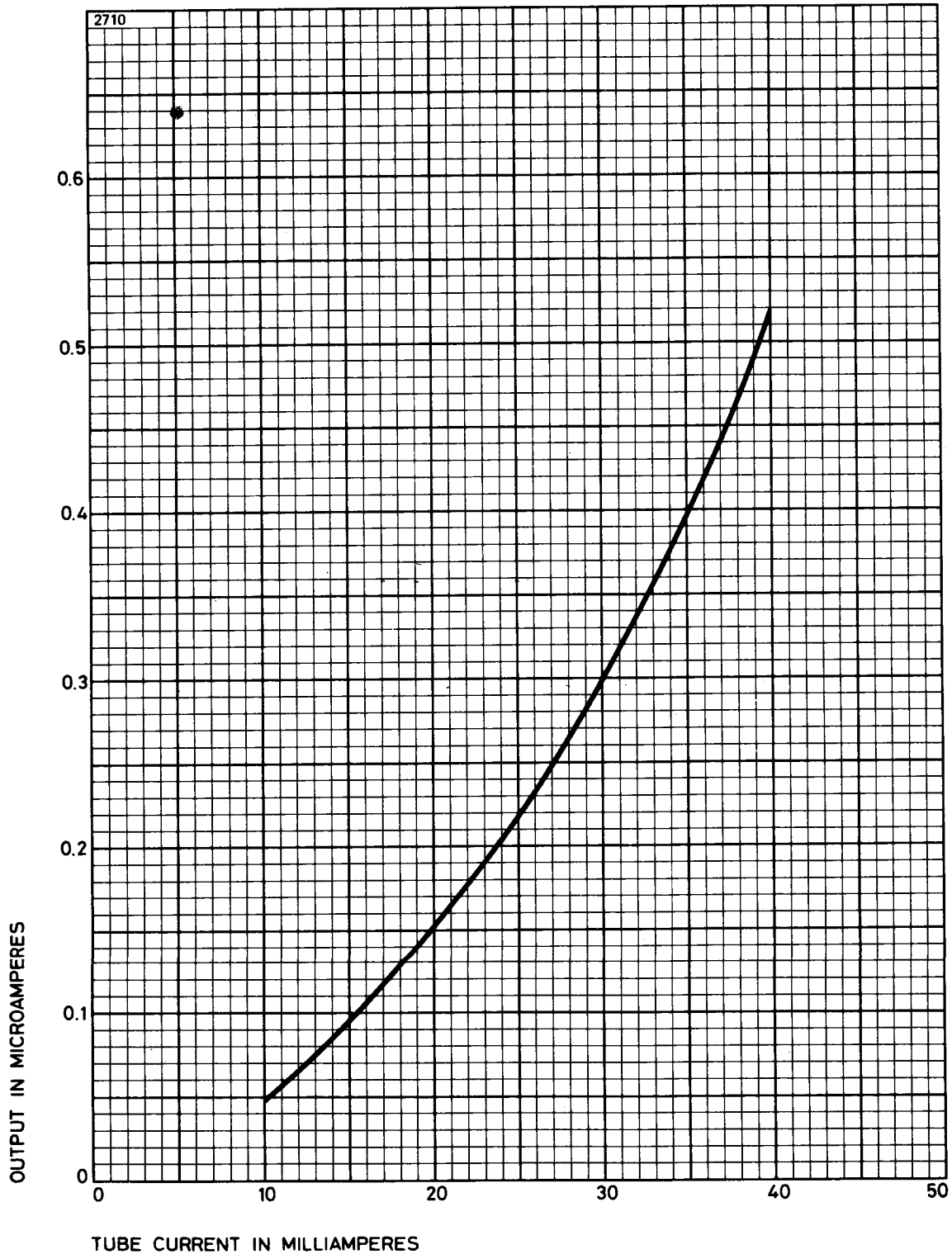

The light output of the glow modulator is expressed as the current through a type 929 photo tube with a Wratten C5 filter between the tubes, the glass envelopes of which are 0.562 inch (14.3mm) apart.

**OUTLINE (All dimensions without limits are nominal)**

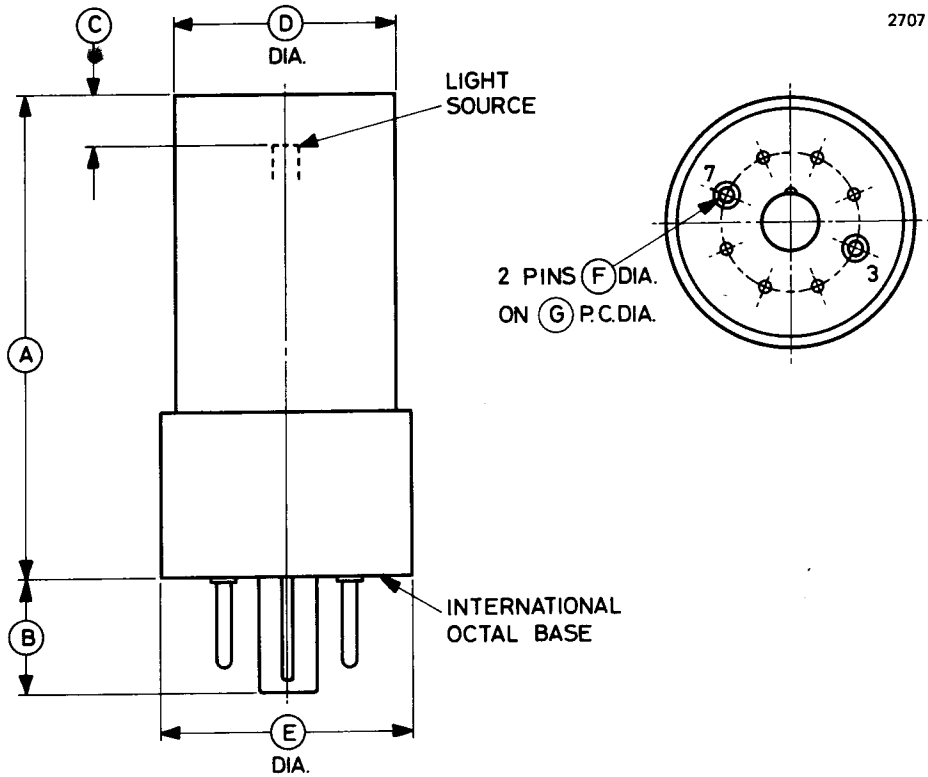

Ref	Inches	Millimetres
A	$2.375 \pm 0.125$	$60.33 \pm 3.18$
B	0.560	14.22
C	$0.250 \pm 0.063$	$6.35 \pm 1.60$
D	1.142 max	29.01 max
E	1.253 max	31.83 max
F	0.093	2.36
G	0.687	17.45

Millimetre dimensions have been derived from inches.

Pin	Element
1	Omitted
2	Omitted
3	Cathode
4	Omitted
5	Omitted
6	Omitted
7	Anode
8	Omitted

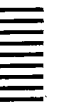

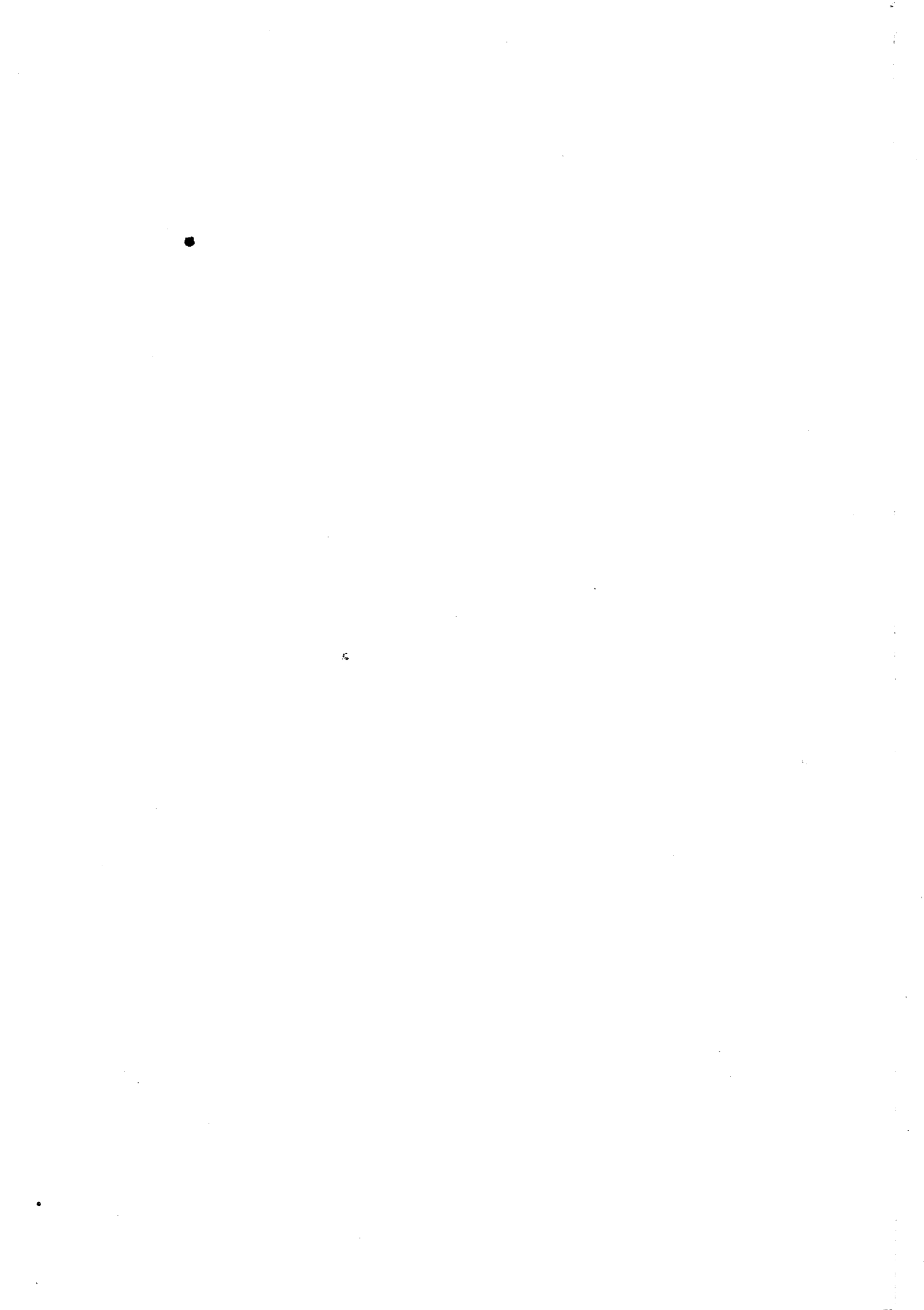



## GLOW MODULATOR

### INTRODUCTION

The XL603 is a cold cathode glow modulator tube suitable for numerous industrial and communications applications, including facsimile equipments and photo-electric counters. It is similar to type 1B59 but gives improved light output and extended life. The hollow cathode contained in the tube provides a high ionisation density and forms a compact and bright light source with an equivalent luminous intensity of 0.375 candela at 30mA cathode current.

Particular features of the XL603 are its substantially linear light output characteristic and its high frequency capability.

### GENERAL DATA

#### Characteristics

Maximum open circuit supply voltage . . . . .	300	V
Maximum breakdown voltage . . . . .	225	V
Maximum maintaining voltage (at 30mA d.c.) . . . . .	150	V
Typical maintaining voltage (at 30mA d.c.) . . . . .	130	V
Maximum average cathode current . . . . .	30	mA
Minimum cathode current . . . . .	5.0	mA
Maximum peak cathode current . . . . .	75	mA
Modulating frequency range . . . . .	up to 10 <sup>6</sup>	Hz
Equivalent luminous intensity, blue-violet (at 30mA d.c.)* . . . . .	0.375	cd
Equivalent luminance, blue-violet (at 30mA d.c.)* . . . . .	2.12 x 10 <sup>5</sup>	cd/m <sup>2</sup>
	137	cd/in <sup>2</sup>
Colour of discharge . . . . .	mainly blue-violet	

#### Mechanical

Overall length . . . . .	4.060 inches (103.0mm) max
Overall diameter . . . . .	1.253 inches (31.83mm) max
Light source (end viewing):	
diameter . . . . .	0.059 inch (1.5mm) nom
distance from end of bulb . . . . .	0.590 inch (15.0mm) max
Mounting position . . . . .	any
Base . . . . .	2 pin international octal

\* The amount of blue-violet light emitted is equivalent to that of a black body with luminous intensity 0.375cd and colour temperature 2870° K.



**OUTLINE (All dimensions without limits are nominal)**

2893

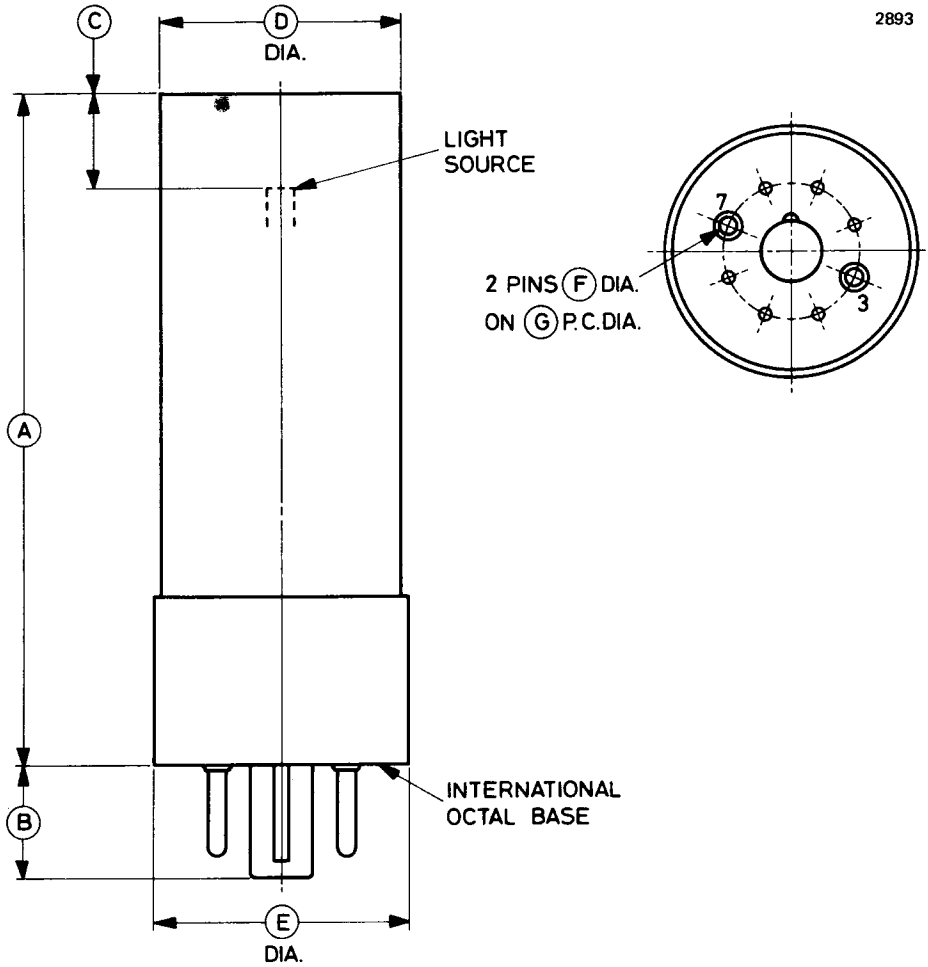

Ref	Inches	Millimetres
A	3.346 ± 0.125	85.00 ± 3.18
B	0.560	14.22
C*	0.551 ± 0.039	14.00 ± 1.00
D*	1.142 max	29.00 max
E	1.253 max	31.83 max
F	0.093	2.36
G	0.687	17.45

Pin	Element
1	Omitted
2	Omitted
3	Cathode
4	Omitted
5	Omitted
6	Omitted
7	Anode
8	Omitted

Millimetre dimensions have been derived from inches except where marked \*.

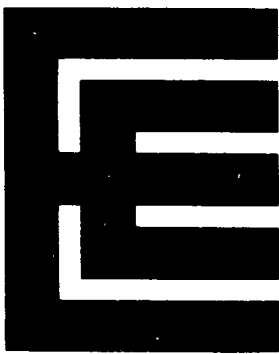

## GLOW MODULATOR

### INTRODUCTION

The XL627 is a rugged cold cathode glow modulator tube, with an envelope mainly of metal construction. The hollow cathode contained in the tube provides a compact and bright light source.

A particular feature of its characteristics is the substantially linear relationship between the light output and the cathode current. This, together with the high frequency and directional characteristics of the tube, makes the XL627 suitable for military, industrial and communications applications, where a rugged tube is required.

### GENERAL DATA

#### Characteristics

Maximum open circuit supply voltage . . . . .	300	V
Maximum breakdown voltage . . . . .	250	V
Maximum maintaining voltage (at 20mA d.c.) . . . . .	150	V
Typical maintaining voltage (at 20mA d.c.) . . . . .	130	V
Maximum average cathode current . . . . .	30	mA
Minimum cathode current . . . . .	0.25	mA
Maximum peak cathode current . . . . .	45	mA
Modulating frequency range . . . . .	up to 10 <sup>6</sup>	Hz
Equivalent luminous intensity, blue-violet (at 30mA d.c.)* . . . . .	0.27	cd
Equivalent luminance, blue-violet (at 30mA d.c.)* . . . . .	6.6 x 10 <sup>5</sup>	cd/m <sup>2</sup>
	430	cd/in <sup>2</sup>
Colour of discharge . . . . .	mainly blue-violet	
Average life (at 15mA d.c.) . . . . .	100	hours

#### Mechanical

Overall length . . . . .	2.750 inches (69.85mm) max
Overall diameter . . . . .	0.719 inches (18.26mm) max
Light source:	
diameter . . . . .	0.028 inch (0.71mm) nom
distance from end of envelope . . . . .	0.473 inch (12.01mm) max
Mounting position . . . . .	any
Connections . . . . .	see outline

\* The amount of blue-violet light emitted is equivalent to that of a black body with luminous intensity 0.27cd and colour temperature 2870° K.



## TYPICAL LIGHT OUTPUT CHARACTERISTIC

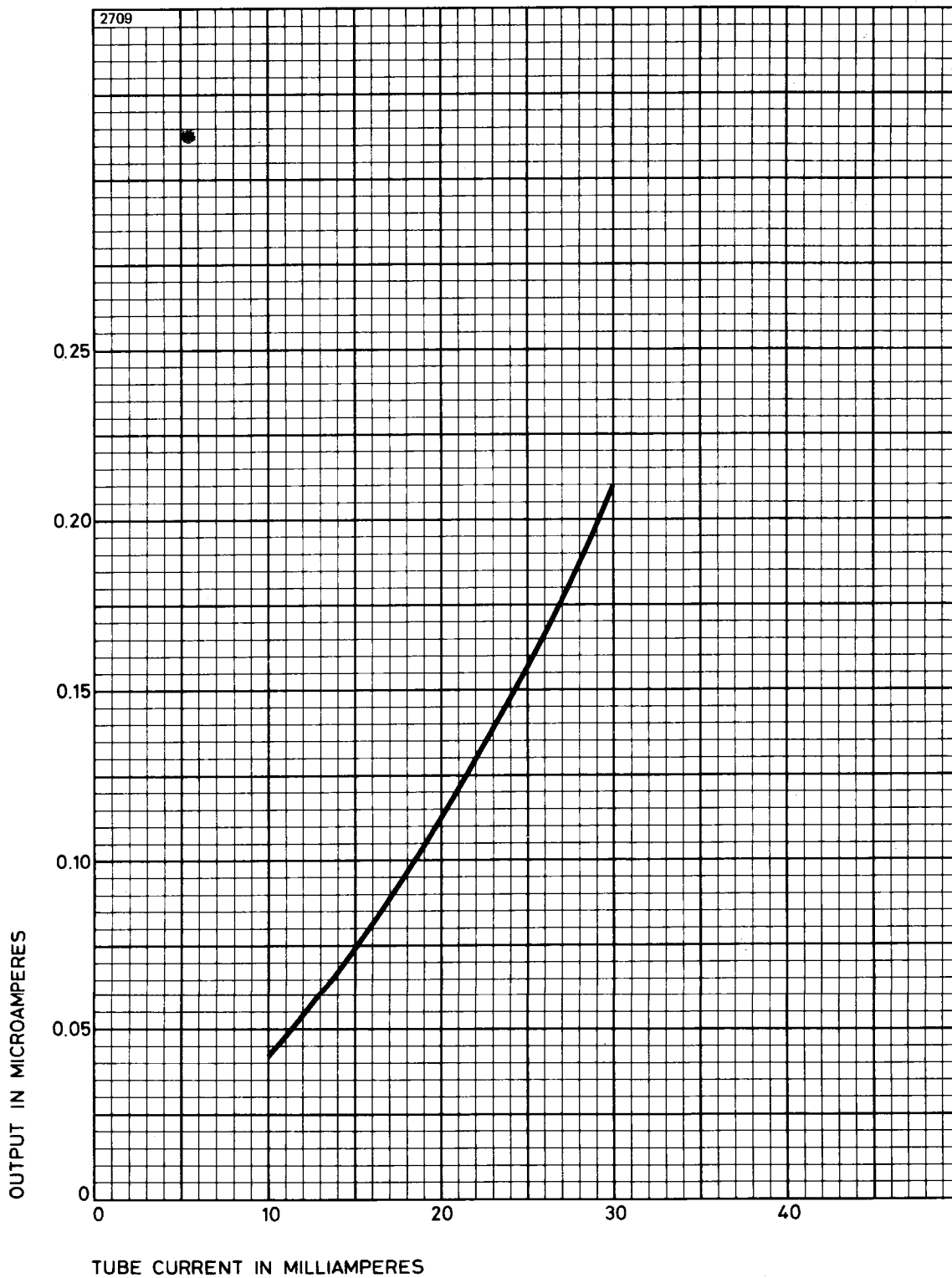

The light output of the glow modulator is expressed as the current through a type 929 photo tube with a Wratten C5 filter between the tubes, the glass envelopes of which are 0.562 inch (14.3mm) apart.



**OUTLINE (All dimensions without limits are nominal)**

2884

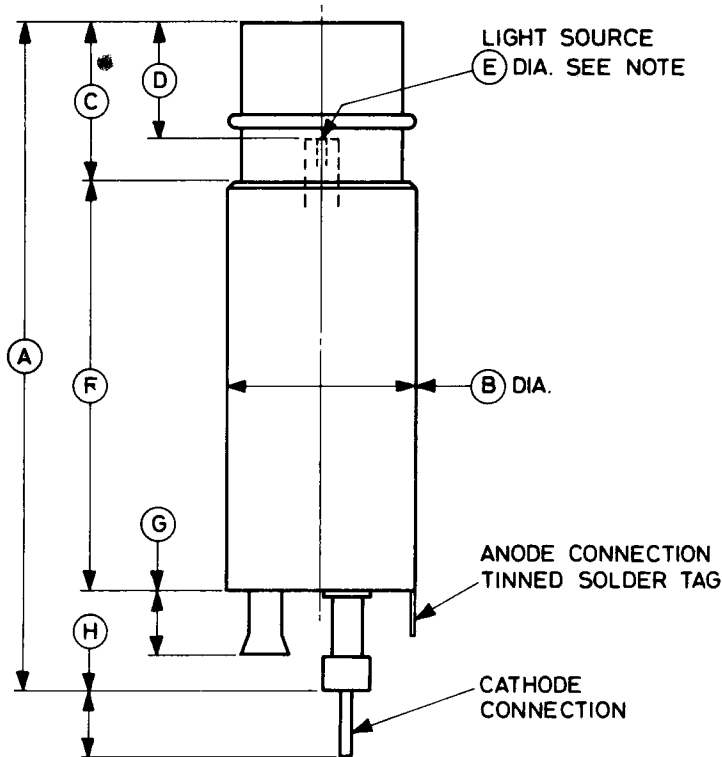

Ref	Inches	Millimetres
A	2.500 max	63.50 max
B	0.709 ± 0.010	18.01 ± 0.25
C	0.516 ± 0.020	13.11 ± 0.51
D	0.433 ± 0.040	11.00 ± 1.02
E	0.028	0.711
F	1.531 ± 0.020	38.89 ± 0.51
G	0.250 max	6.35 max
H	0.125	3.18

Millimetre dimensions have been derived from inches.

**Note** Concentric tolerance 0.040 inch (1.02mm) diameter, datum diameter B (BS308). The axis of the light beam will be within 3° of the tube axis.

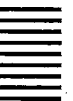

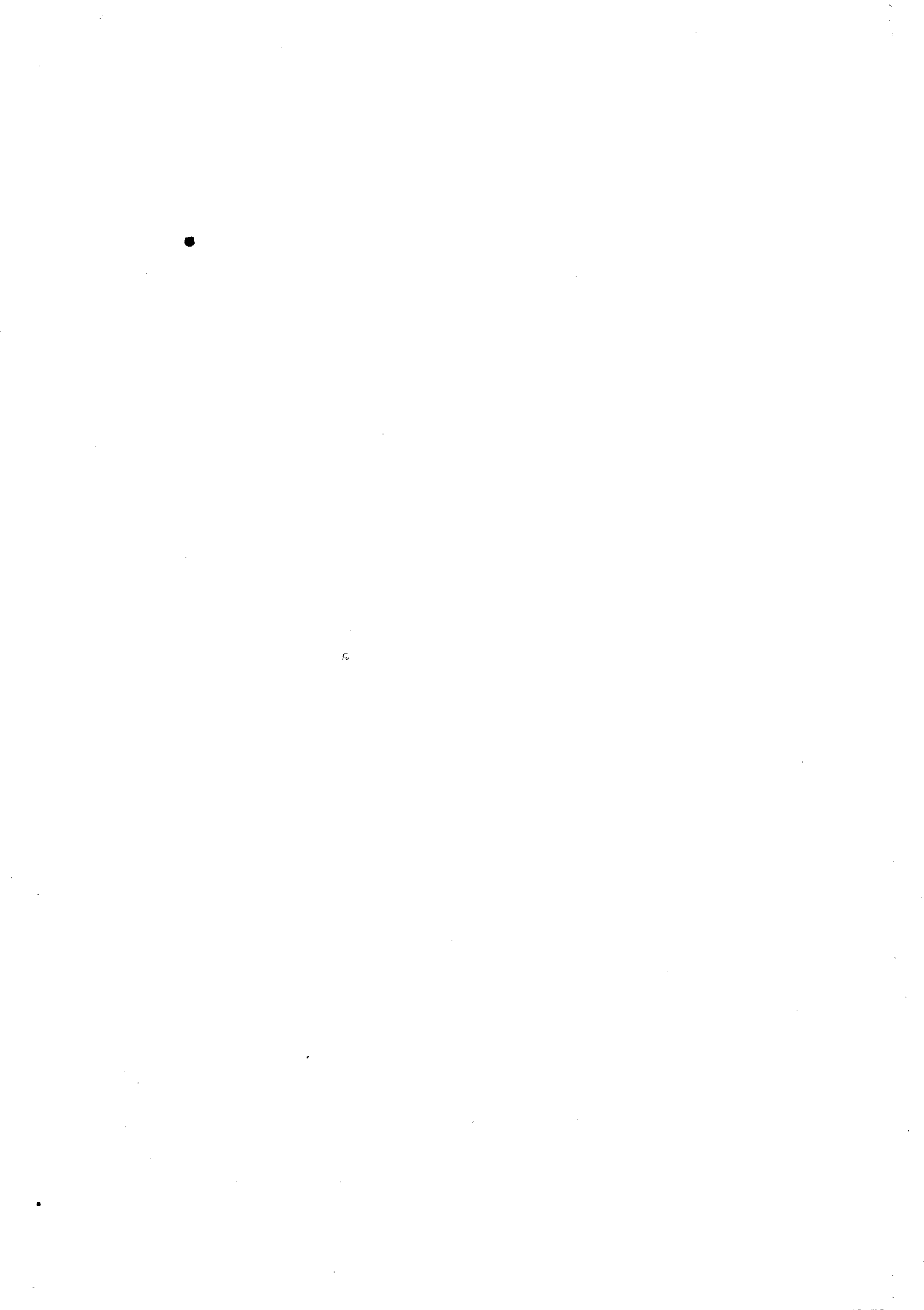

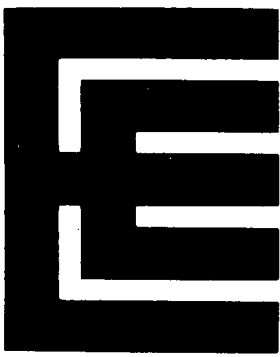

# XL628

## GLOW MODULATOR

### INTRODUCTION

The XL628 is a cold cathode glow modulator tube with an international octal base. The hollow cathode contained in the tube forms a compact light source with an equivalent luminous intensity of 0.40 candela at 30mA cathode current.

The XL628 has been designed specifically for use in the Muirhead Pagefax facsimile receiver.

### GENERAL DATA

#### Characteristics

Maximum open circuit supply voltage . . . . .	300	V
Maximum breakdown voltage . . . . .	225	V
Maximum maintaining voltage (at 30mA d.c.) . . . . .	150	V
Typical maintaining voltage (at 30mA d.c.) . . . . .	130	V
Maximum average cathode current . . . . .	70	mA
Minimum cathode current . . . . .	1.0	mA
Maximum peak cathode current . . . . .	100	mA
Modulating frequency range . . . . .	up to 10 <sup>6</sup>	Hz
Equivalent luminous intensity, blue-violet (at 30mA d.c.)* . . . . .	0.4	cd
Equivalent luminance, blue-violet (at 30mA d.c.)*	1.01 x 10 <sup>6</sup>	cd/m <sup>2</sup>
	650	cd/in <sup>2</sup>
Colour of discharge . . . . .	mainly blue-violet	

#### Mechanical

Overall length . . . . .	3.544 inches (90.0mm) max
Overall diameter . . . . .	1.253 inches (31.83mm) max
Light source (end viewing):	
diameter . . . . .	0.028 inch (0.71mm) nom
distance from end of bulb . . . . .	0.312 inch (7.93mm) max
Mounting position . . . . .	any
Base . . . . .	2 pin international octal

\* The amount of blue-violet light emitted is equivalent to that of a black body with luminous intensity 0.4cd and colour temperature 2870°K.



**OUTLINE (All dimensions without limits are nominal)**

3383

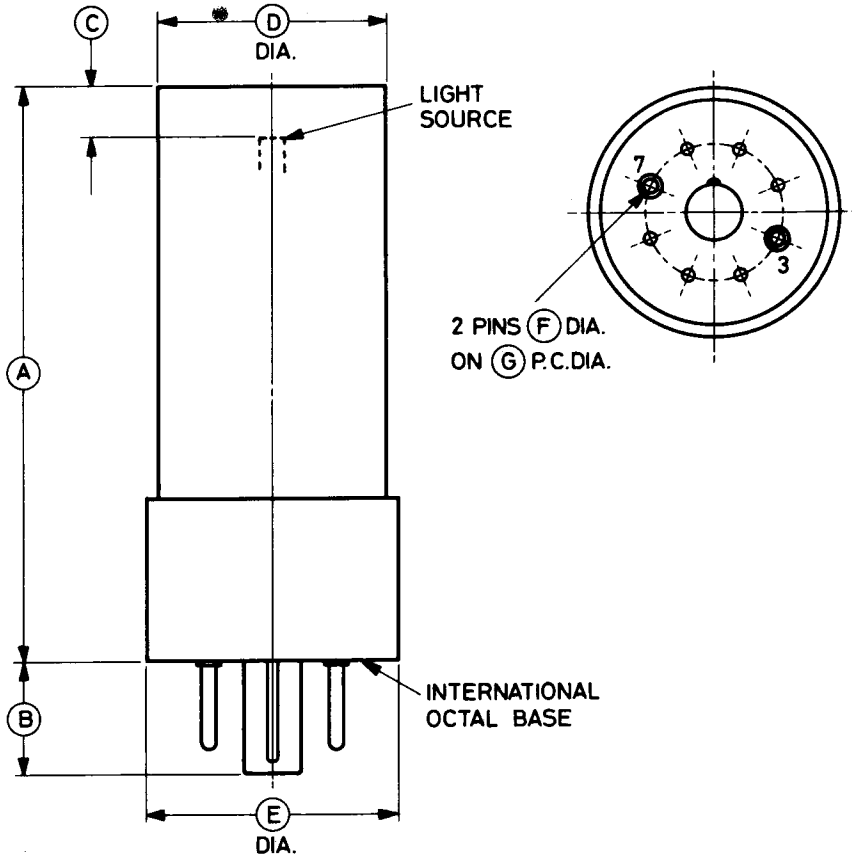

Ref	Inches	Millimetres
A	2.859 ± 0.125	72.62 ± 3.18
B	0.560	14.22
C	0.250 ± 0.063	6.35 ± 1.60
D	1.142 max	29.01 max
E	1.253 max	31.83 max
F	0.093	2.36
G	0.687	17.45

Millimetre dimensions have been derived from inches.

Pin	Element
1	Omitted
2	Omitted
3	Cathode
4	Omitted
5	Omitted
6	Omitted
7	Anode
8	Omitted

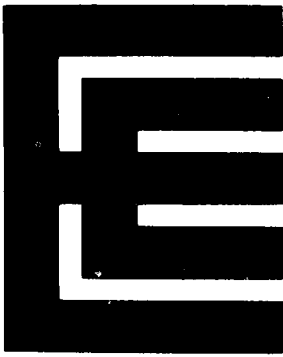

## GLOW MODULATOR

### INTRODUCTION

The XL631 is a cold cathode glow modulator tube with an international octal base. The hollow cathode contained in the tube provides a high ionization density and forms a compact light source with an equivalent luminous intensity of 0.27 candela at 30mA cathode current.

A particular feature of its characteristics is the substantially linear relationship between the light output and the cathode current. This, together with the high frequency and directional characteristics of the tube, makes the XL631 suitable for numerous industrial and communications applications, including facsimile equipments and photo-electric counters.

### GENERAL DATA

#### Characteristics

Maximum open circuit supply voltage . . . . .	300	V
Maximum breakdown voltage . . . . .	225	V
Maximum maintaining voltage (at 20mA d.c.) . . . . .	150	V
Typical maintaining voltage (at 20mA d.c.) . . . . .	120	V
Maximum average cathode current . . . . .	30	mA
Minimum cathode current . . . . .	0.25	mA
Maximum peak cathode current . . . . .	45	mA
Modulating frequency range . . . . .	up to 10 <sup>6</sup>	Hz
Equivalent luminous intensity, blue-violet (at 30mA d.c.)* . . . . .	0.27	cd
Equivalent luminance, blue-violet (at 30mA d.c.)* . . . . .	8.52 x 10 <sup>5</sup>	cd/m <sup>2</sup>
	550	cd/in <sup>2</sup>
Colour of discharge . . . . .	mainly blue-violet	

#### Mechanical

Overall length . . . . .	3.500 inches (88.90mm) max
Overall diameter . . . . .	1.253 inches (31.83mm) max
Light source (end viewing):	
diameter . . . . .	0.025 inch (0.635mm) nom
distance from end of bulb . . . . .	0.710 inch (18.0mm) max
Mounting position . . . . .	any
Base . . . . .	2 pin international octal

\* The amount of blue-violet light emitted is equivalent to that of a black body with luminous intensity 0.27cd and colour temperature 2870°K.



**OUTLINE (All dimensions without limits are nominal)**

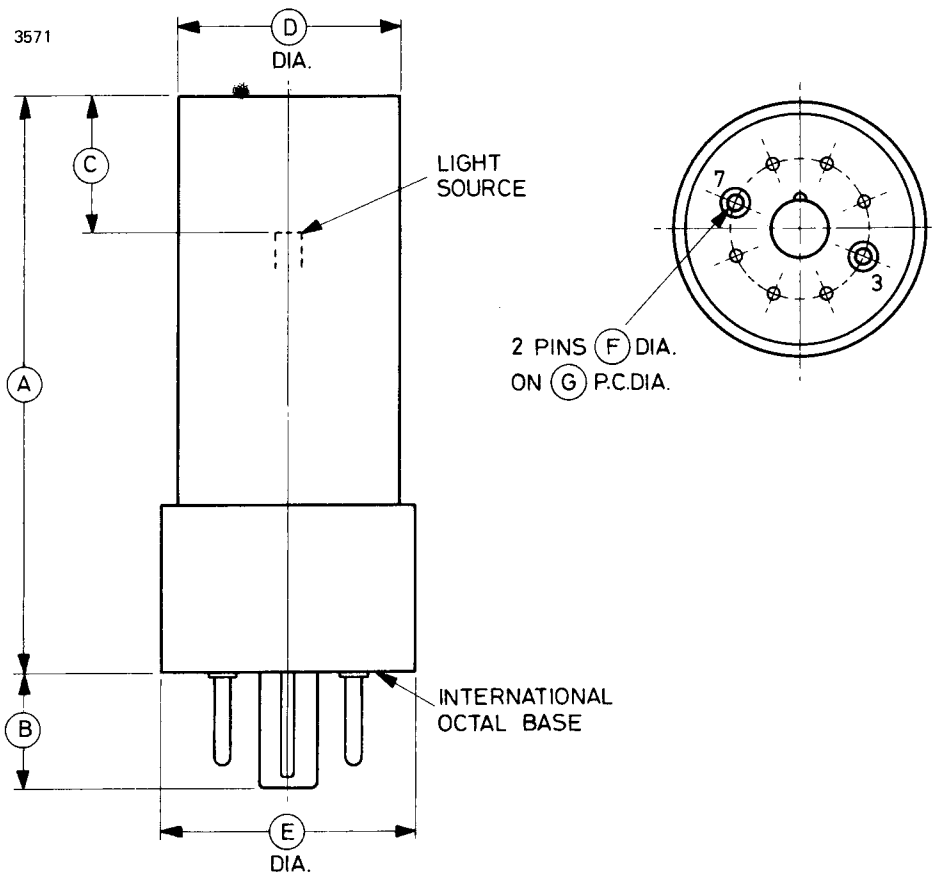

Ref	Inches	Millimetres
A	2.794 ± 0.125	70.97 ± 3.18
B	0.560	14.22
C*	0.669 ± 0.039	17.00 ± 1.00
D	1.142 max	29.01 max
E	1.253 max	31.83 max
F	0.093	2.36
G	0.687	17.45

Millimetre dimensions have been derived from inches except where marked \*.

Pin	Element
1	Omitted
2	Omitted
3	Cathode
4	Omitted
5	Omitted
6	Omitted
7	Anode
8	Omitted

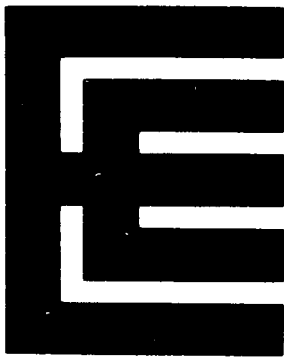

### INTRODUCTION

The XL632 is a cold cathode glow modulator tube with an international octal base. The hollow cathode contained in the tube provides a high ionization density and forms a compact light source with an equivalent luminous intensity of 0.11 candela at 30mA cathode current.

The XL632 has been designed for use in high definition facsimile systems.

### GENERAL DATA

#### Characteristics

Maximum open circuit supply voltage . . . . .	300	V
Maximum breakdown voltage . . . . .	225	V
Maximum maintaining voltage (at 20mA d.c.) . . . . .	150	V
Typical maintaining voltage (at 20mA d.c.) . . . . .	120	V
Maximum average cathode current . . . . .	25	mA
Minimum cathode current . . . . .	0.25	mA
Maximum peak cathode current . . . . .	35	mA
Modulating frequency range . . . . .	up to 10 <sup>6</sup>	Hz
Equivalent luminous intensity, blue-violet (at 30mA d.c.)* . . . . .	0.11	cd
Equivalent luminance, blue-violet (at 30mA d.c.)*	8.52 x 10 <sup>5</sup>	cd/m <sup>2</sup>
	550	cd/in <sup>2</sup>
Colour of discharge . . . . .	mainly blue-violet	

#### Mechanical

Overall length . . . . .	3.060 inches (77.72mm) max
Overall diameter . . . . .	1.253 inches (31.83mm) max
Light source (end viewing):	
diameter . . . . .	0.016 inch (0.406mm) nom
distance from end of bulb . . . . .	0.312 inch (7.93mm) max
Mounting position . . . . .	any
Base . . . . .	2 pin international octal

\* The amount of blue-violet light emitted is equivalent to that of a black body with luminous intensity 0.11cd and colour temperature 2870° K.



**OUTLINE (All dimensions without limits are nominal)**

2707

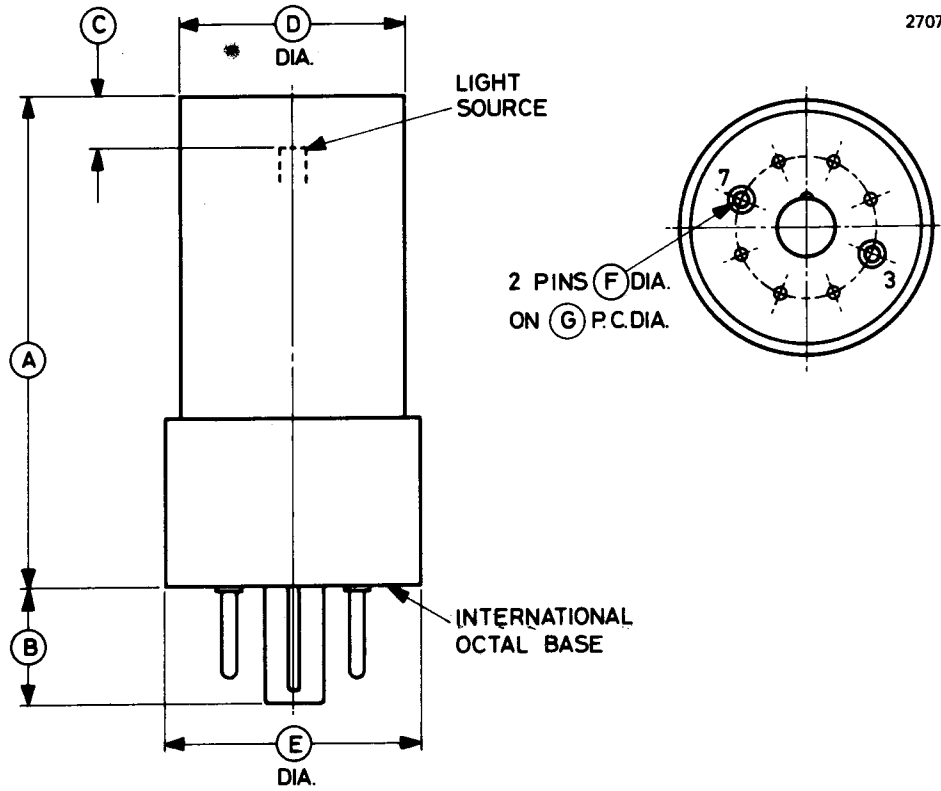

Ref	Inches	Millimetres
A	2.375 ± 0.125	60.33 ± 3.18
B	0.560	14.22
C	0.250 ± 0.063	6.35 ± 1.60
D	1.142 max	29.01 max
E	1.253 max	31.83 max
F	0.093	2.36
G	0.687	17.45

Millimetre dimensions have been derived from inches.

Pin	Element
1	Omitted
2	Omitted
3	Cathode
4	Omitted
5	Omitted
6	Omitted
7	Anode
8	Omitted



# Flash Tubes



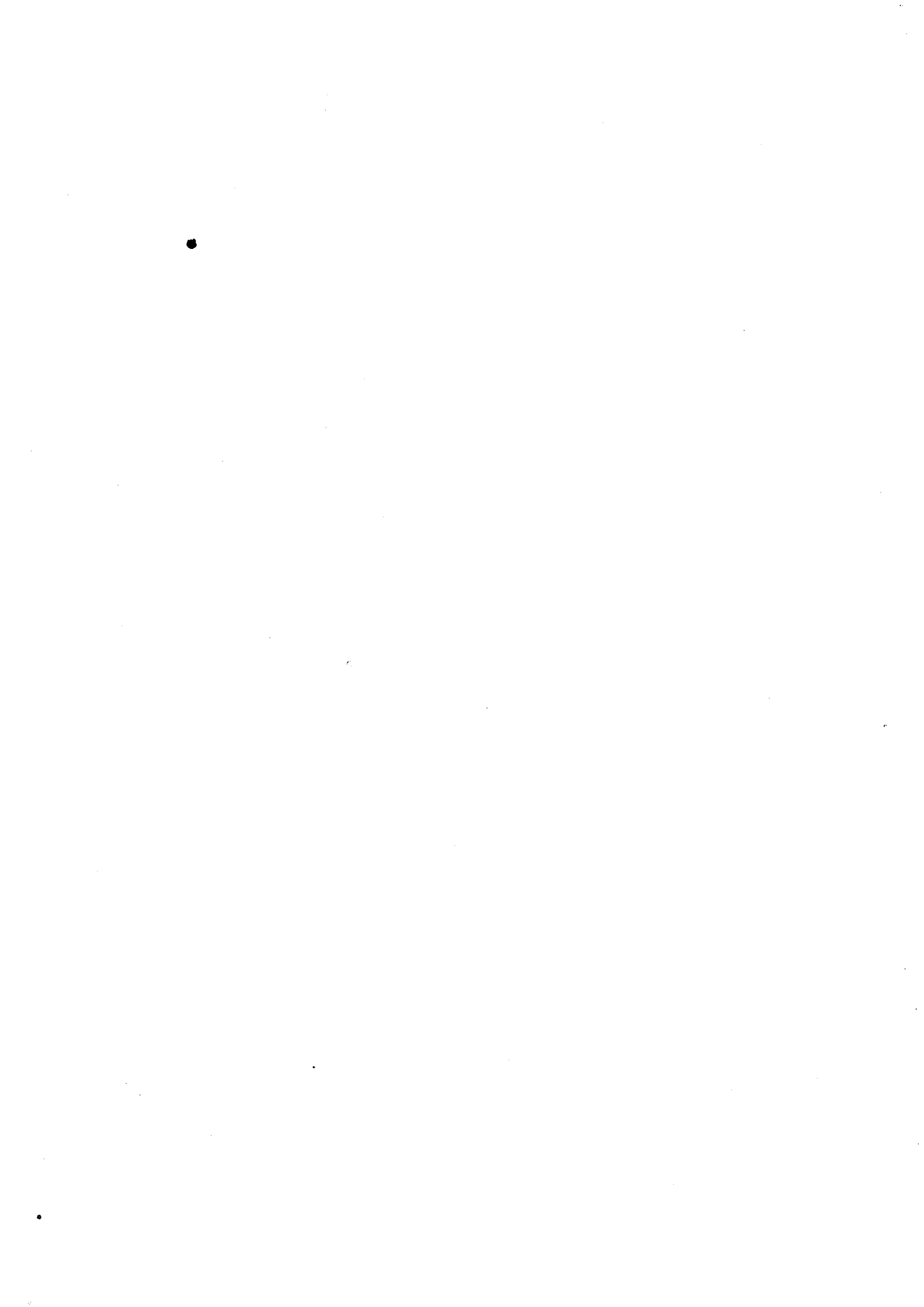

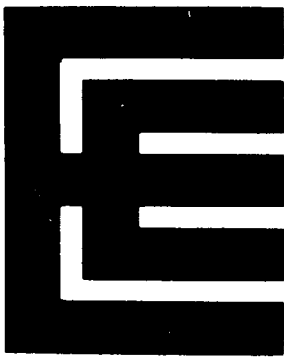

## FLASH TUBE

### INTRODUCTION

The XL615/4/2 is a flash tube of linear design, for operation at medium energy loadings.

### MAXIMUM AND MINIMUM RATINGS (Absolute values)

Maximum input energy per flash (see note) . . . . .	250	J
Operating voltage:		
maximum . . . . .	3.0	kV
minimum . . . . .	1.0	kV
Minimum trigger voltage . . . . .	12	kV
Minimum series inductance . . . . .	400	$\mu$ H

### TYPICAL OPERATION (at maximum input energy)

Operating voltage . . . . .	2.5	kV
Flash rate . . . . .	1 per 30	s
Series inductance . . . . .	400	$\mu$ H
Nominal arc resistance during discharge . . . . .	0.3	$\Omega$

### MECHANICAL

Overall length . . . . .	3.500 inches (88.90mm) nom
Envelope diameter . . . . .	0.236 inch (6.00mm) nom
Arc length . . . . .	2.000 inches (50.80mm) nom
Bore diameter . . . . .	0.158 inch (4.00mm) nom
Net weight . . . . .	½ ounce (14g) approx
Mounting position . . . . .	any

**Note** This rating applies to operation in free air. For cavity operation a reduction in input energy level is necessary, the extent of the reduction depending upon the design and reflectivity of the cavity.

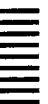

**OUTLINE (All dimensions without limits are nominal)**

2802A

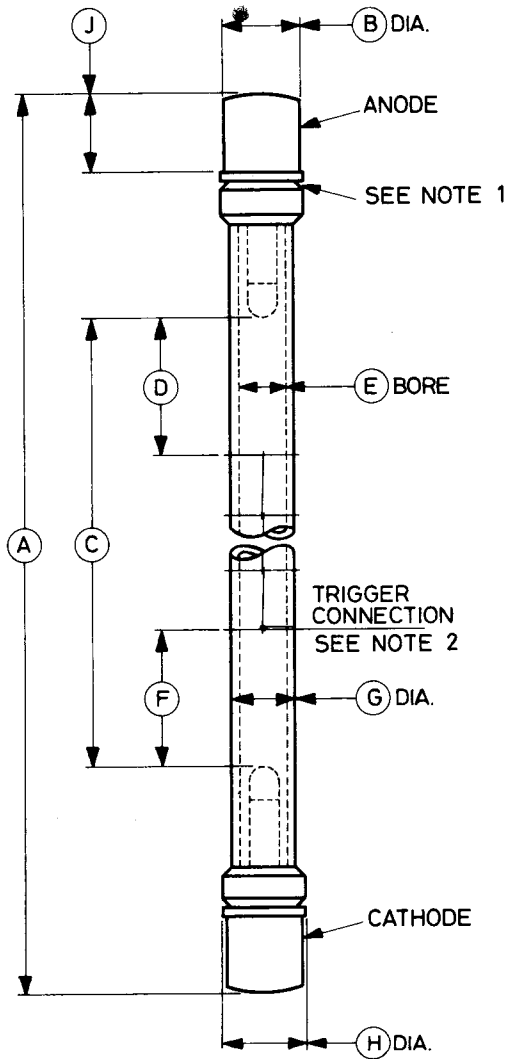

Ref	Inches	Millimetres
A	3.500 ± 0.062	88.90 ± 1.57
B	0.280 ± 0.005	7.11 ± 0.13
C	2.000 ± 0.062	50.80 ± 1.57
D	0.250	6.35
E*	0.158	4.00
F	0.250	6.35
G*	0.236	6.00
H	0.291	7.39
J	0.250	6.35

Millimetre dimensions have been derived from inches except where marked \*.

**Outline Notes**

1. The anode terminal is marked with a red band.
2. The fitting of the external trigger wire is optional, depending upon customers' requirements.

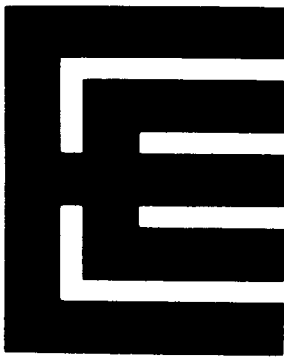

## FLASH TUBE

### INTRODUCTION

The XL615/4/3 is a flash tube of linear design, for operation at medium energy loadings.

### MAXIMUM AND MINIMUM RATINGS (Absolute values)

Maximum input energy per flash (see note) . . . . .	400	J
Operating voltage:		
maximum . . . . .	3.0	kV
minimum . . . . .	1.0	kV
Minimum trigger voltage . . . . .	12	kV
Minimum series inductance . . . . .	400	$\mu$ H

### TYPICAL OPERATION (at maximum input energy)

Operating voltage . . . . .	2.5	kV
Flash rate . . . . .	1 per 30s	
Series inductance . . . . .	400	$\mu$ H
Nominal arc resistance during discharge . . . . .	0.5	$\Omega$

### MECHANICAL

Overall length . . . . .	5.395 inches (137.0mm) nom
Envelope diameter . . . . .	0.236 inch (6.00mm) nom
Arc length . . . . .	3.000 inches (76.20mm) nom
Bore diameter . . . . .	0.158 inch (4.00mm) nom
Net weight . . . . .	½ ounce (14g) approx
Mounting position . . . . .	any

**Note** This rating applies to operation in free air. For cavity operation a reduction in input energy level is necessary, the extent of the reduction depending upon the design and reflectivity of the cavity.

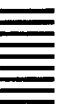

**OUTLINE (All dimensions without limits are nominal)**

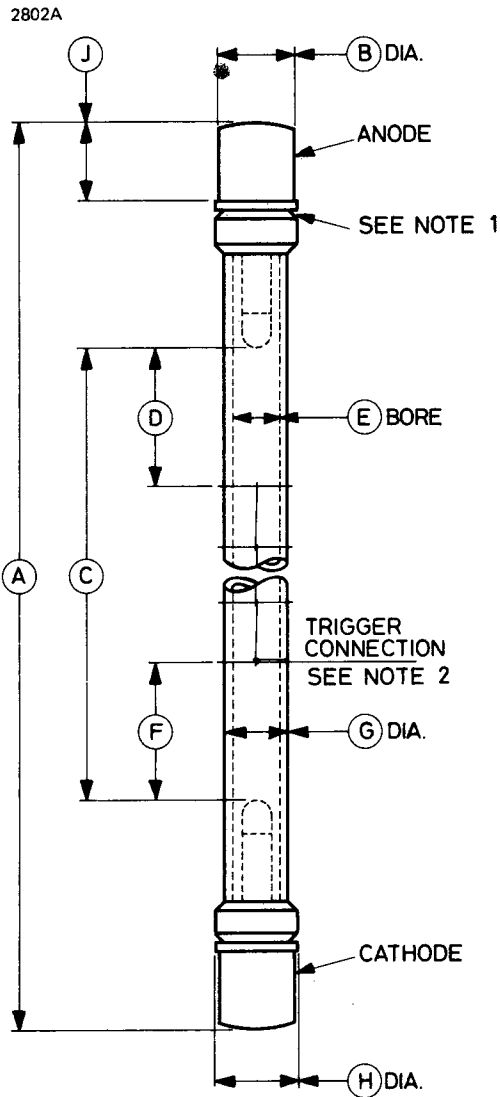

Ref	Inches	Millimetres
A	5.395 ± 0.062	137.0 ± 1.6
B	0.280 ± 0.005	7.11 ± 0.13
C	3.000 ± 0.062	76.20 ± 1.57
D	0.500	12.70
E*	0.158	4.00
F	0.500	12.70
G*	0.236	6.00
H	0.291	7.39
J	0.250	6.35

Millimetre dimensions have been derived from inches except where marked \*.

**Outline Notes**

1. The anode terminal is marked with a red band.
2. The fitting of the external trigger wire is optional, depending upon customers' requirements.



# XL615/7/1.75

## FLASH TUBE

### INTRODUCTION

The XL615/7/1.75 is a flash tube of linear design, for operation at medium energy loadings.

### MAXIMUM AND MINIMUM RATINGS (Absolute values)

Maximum input energy per flash (see note)	300	J
Operating voltage:		
maximum	3.0	kV
minimum	1.0	kV
Minimum trigger voltage	12	kV
Minimum series inductance	400	$\mu$ H

### TYPICAL OPERATION (at maximum input energy)

Operating voltage	2.5	kV
Flash rate	1 per 15s	
Series inductance	400	$\mu$ H
Nominal arc resistance during discharge	0.2	$\Omega$

### MECHANICAL

Overall length	4.562 inches (115.9mm) nom
Envelope diameter	0.354 inch (9.00mm) nom
Arc length	1.750 inches (44.45mm) nom
Bore diameter	0.276 inch (7.00mm) nom
Net weight	1 ounce (28g) approx
Mounting position	any

**Note** This rating applies to operation in free air. For cavity operation a reduction in input energy level is necessary, the extent of the reduction depending upon the design and reflectivity of the cavity.

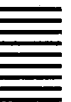

**OUTLINE (All dimensions without limits are nominal)**

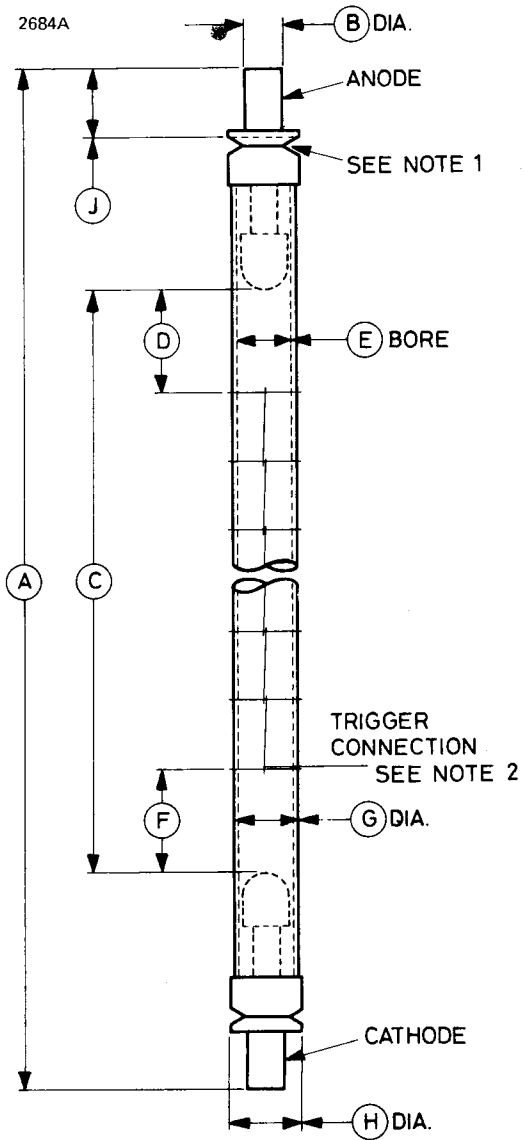

Ref	Inches	Millimetres
A	4.562 ± 0.062	115.9 ± 1.6
B	0.280 ± 0.005	7.11 ± 0.13
C	1.750 ± 0.062	44.45 ± 1.57
D	0.250	6.35
E*	0.276	7.00
F	0.250	6.35
G*	0.354	9.00
H	0.410	10.41
J	0.500	12.70

Millimetre dimensions have been derived from inches except where marked thus \*.

**Outline Notes**

1. The anode terminal is marked with a red band.
2. The fitting of the external trigger wire is optional, depending upon customers' requirements.



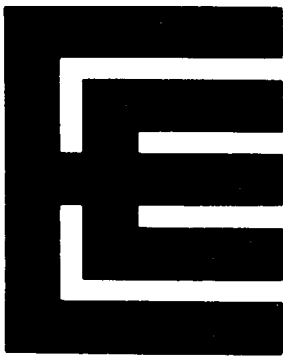

## FLASH TUBE

### INTRODUCTION

The XL615/7/2 is a flash tube of linear design, for operation at medium energy loadings.

### MAXIMUM AND MINIMUM RATINGS (Absolute values)

Maximum input energy per flash (see note)	400	J
Operating voltage:		
maximum	3.0	kV
minimum	1.0	kV
Minimum trigger voltage	12	kV
Minimum series inductance	400	$\mu$ H

### TYPICAL OPERATION (at maximum input energy)

Operating voltage	2.5	kV
Flash rate	1 per 15s	
Series inductance	400	$\mu$ H
Nominal arc resistance during discharge	0.2	$\Omega$

### MECHANICAL

Overall length	4.812 inches (122.2mm) nom
Envelopè diameter	0.354 inch (9.00mm) nom
Arc length	2.000 inches (50.80mm) nom
Bore diameter	0.276 inch (7.00mm) nom
Net weight	1 ounce (28g) approx
Mounting position	any

**Note** This rating applies to operation in free air. For cavity operation a reduction in input energy level is necessary, the extent of the reduction depending upon the design and reflectivity of the cavity.

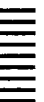

**OUTLINE (All dimensions without limits are nominal)**

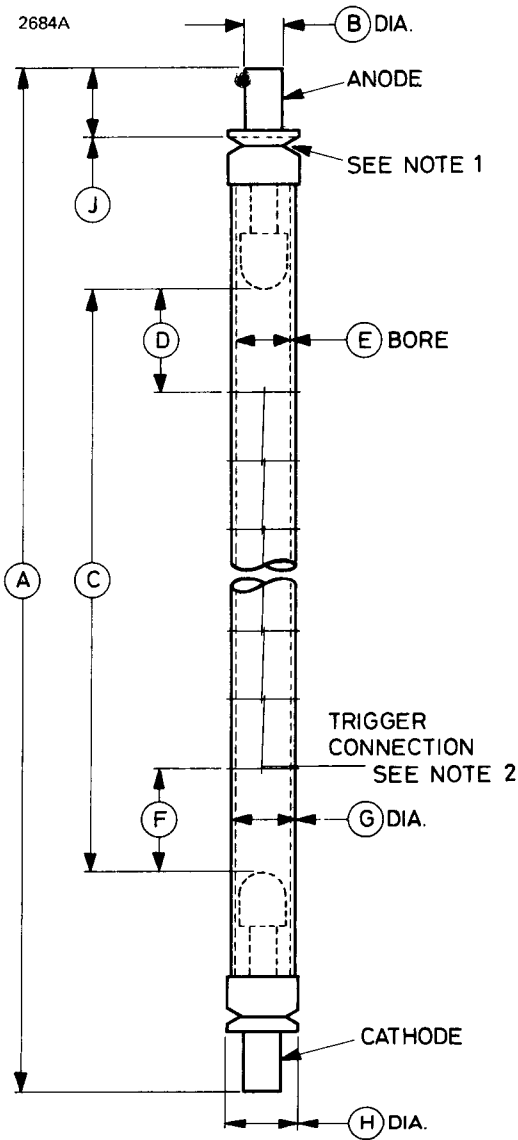

Ref	Inches	Millimetres
A	4.812 ± 0.062	122.2 ± 1.6
B	0.280 ± 0.005	7.11 ± 0.13
C	2.000 ± 0.062	50.80 ± 1.57
D	0.250	6.35
E*	0.276	7.00
F	0.250	6.35
G*	0.354	9.00
H	0.410	10.41
J	0.500	12.70

Millimetre dimensions have been derived from inches except where marked \*.

**Outline Notes**

1. The anode terminal is marked with a red band.
2. The fitting of the external trigger wire is optional, depending upon customers' requirements.

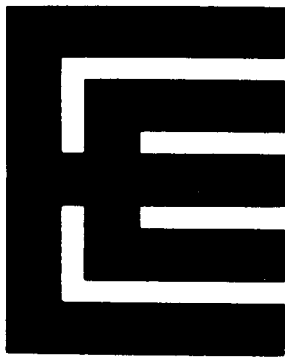

## FLASH TUBE

### INTRODUCTION

The XL615/7/3 is a flash tube of linear design, for operation at medium energy loadings.

### MAXIMUM AND MINIMUM RATINGS (Absolute values)

Maximum input energy per flash (see note)	600	J
Operating voltage:		
maximum	3.0	kV
minimum	1.0	kV
Minimum trigger voltage	12	kV
Minimum series inductance	400	$\mu$ H

### TYPICAL OPERATION (at maximum input energy)

Operating voltage	2.5	kV
Flash rate	1 per 15s	
Series inductance	400	$\mu$ H
Nominal arc resistance during discharge	0.3	$\Omega$

### MECHANICAL

Overall length	5.812 inches (147.6mm) nom
Envelope diameter	0.354 inch (9.00mm) nom
Arc length	3.000 inches (76.20mm) nom
Bore diameter	0.276 inch (7.00mm) nom
Net weight	1 ounce (28g) approx
Mounting position	any

**Note** This rating applies to operation in free air. For cavity operation a reduction in input energy level is necessary, the extent of the reduction depending upon the design and reflectivity of the cavity.



**OUTLINE (All dimensions without limits are nominal)**

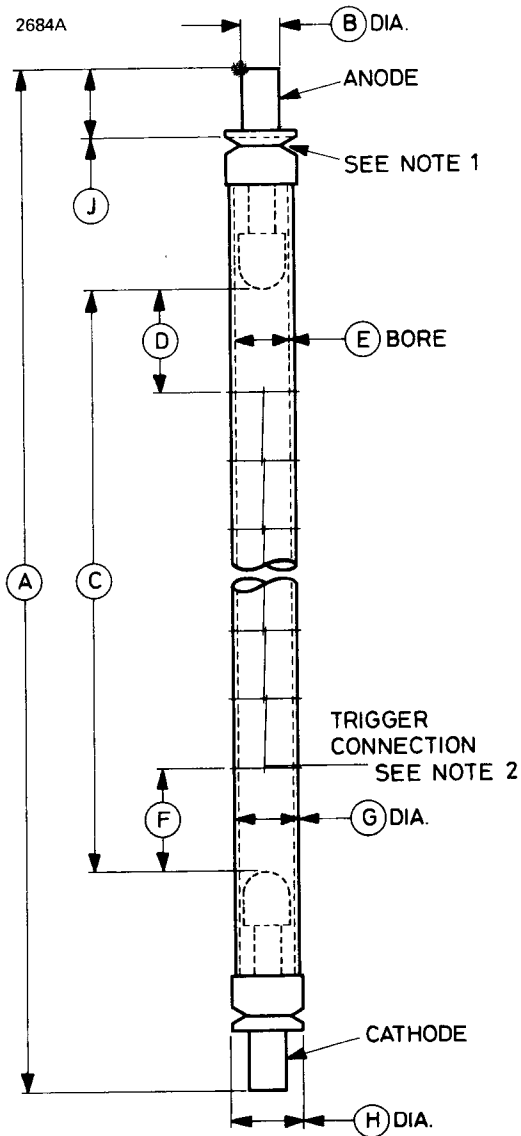

Ref	Inches	Millimetres
A	$5.812 \pm 0.062$	$147.6 \pm 1.6$
B	$0.280 \pm 0.005$	$7.11 \pm 0.13$
C	$3.000 \pm 0.062$	$76.20 \pm 1.57$
D	0.750	19.05
E*	0.276	7.00
F	0.750	19.05
G*	0.354	9.00
H	0.410	10.41
J	0.500	12.70

Millimetre dimensions have been derived from inches except where marked thus \*.

**Outline Notes**

1. The anode terminal is marked with a red band.
2. The fitting of the external trigger wire is optional, depending upon customers' requirements.

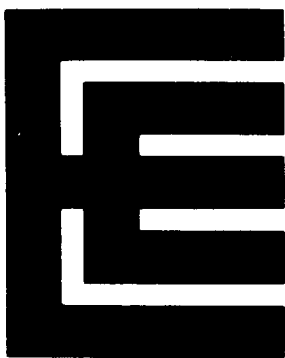

## FLASH TUBE

### INTRODUCTION

The XL615/7/6 is a flash tube of linear design, for operation at high energy loadings.

### MAXIMUM AND MINIMUM RATINGS (Absolute values)

Maximum input energy per flash (see note)	1200	J
Operating voltage:		
maximum	3.0	kV
minimum	1.0	kV
Minimum trigger voltage	16	kV
Minimum series inductance	400	$\mu$ H

### TYPICAL OPERATION (at maximum input energy)

Operating voltage	2.5	kV
Flash rate	1 per 15s	
Series inductance	400	$\mu$ H
Nominal arc resistance during discharge	0.6	$\Omega$

### MECHANICAL

Overall length	8.812 inches (223.8mm) nom
Envelope diameter	0.354 inch (9.00mm) nom
Arc length	6.000 inches (152.4mm) nom
Bore diameter	0.276 inch (7.00mm) nom
Net weight	1¼ ounces (35g) approx
Mounting position	any

**Note** This rating applies to operation in free air. For cavity operation a reduction in input energy level is necessary, the extent of the reduction depending upon the design and reflectivity of the cavity.

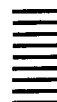

**OUTLINE (All dimensions without limits are nominal)**

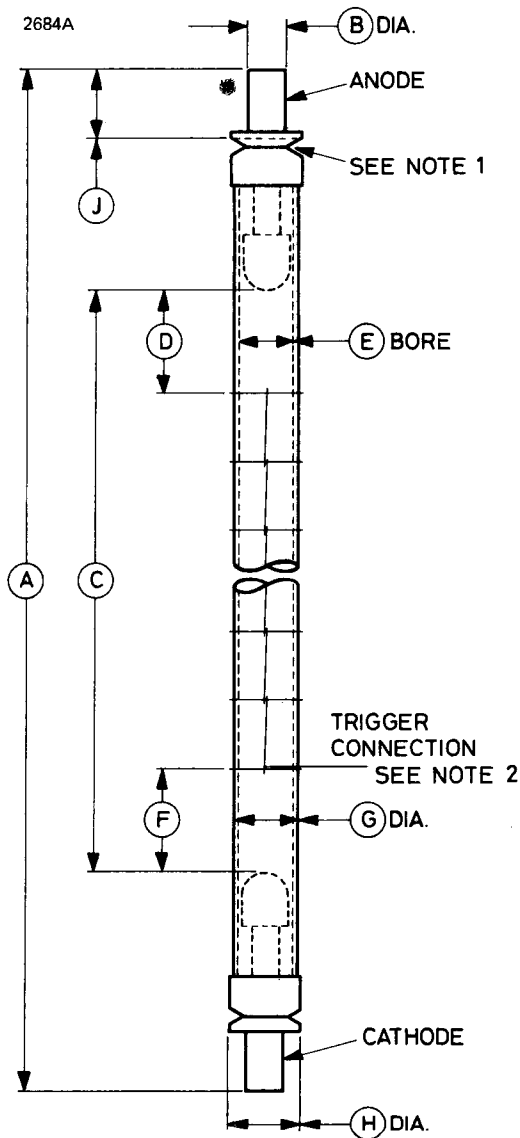

Ref	Inches	Millimetres
A	8.812 ± 0.062	223.8 ± 1.6
B	0.280 ± 0.005	7.11 ± 0.13
C	6.000 ± 0.062	152.4 ± 1.6
D	0.750	19.05
E*	0.276	7.00
F	0.750	19.05
G*	0.354	9.00
H	0.410	10.41
J	0.500	12.70

Millimetre dimensions have been derived from inches except where marked thus \*.

**Outline Notes**

1. The anode terminal is marked with a red band.
2. The fitting of the external trigger wire is optional, depending upon customers' requirements.

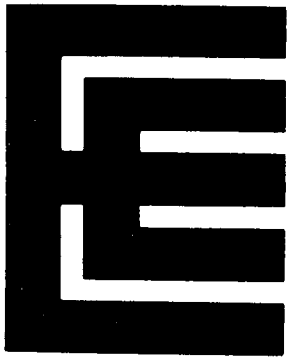

### INTRODUCTION

The XL615/7/6.5 is a flash tube of linear design, for operation at high energy loadings.

### MAXIMUM AND MINIMUM RATINGS (Absolute values)

Maximum input energy per flash (see note) . . . . .	1300	J
Operating voltage:		
maximum . . . . .	3.0	kV
minimum . . . . .	1.0	kV
Minimum trigger voltage . . . . .	16	kV
Minimum series inductance . . . . .	400	$\mu$ H

### TYPICAL OPERATION (at maximum input energy)

Operating voltage . . . . .	2.5	kV
Flash rate . . . . .	1 per 15s	
Series inductance . . . . .	400	$\mu$ H
Nominal arc resistance during discharge . . . . .	0.65	$\Omega$

### MECHANICAL

Overall length . . . . .	9.312 inches (236.5mm) nom
Envelope diameter . . . . .	0.354 inch (9.00mm) nom
Arc length . . . . .	6.500 inches (165.1mm) nom
Bore diameter . . . . .	0.276 inch (7.00mm) nom
Net weight . . . . .	1¼ ounces (35g) approx
Mounting position . . . . .	any

**Note** This rating applies to operation in free air. For cavity operation a reduction in input energy level is necessary, the extent of the reduction depending upon the design and reflectivity of the cavity.

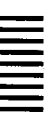

**OUTLINE (All dimensions without limits are nominal)**

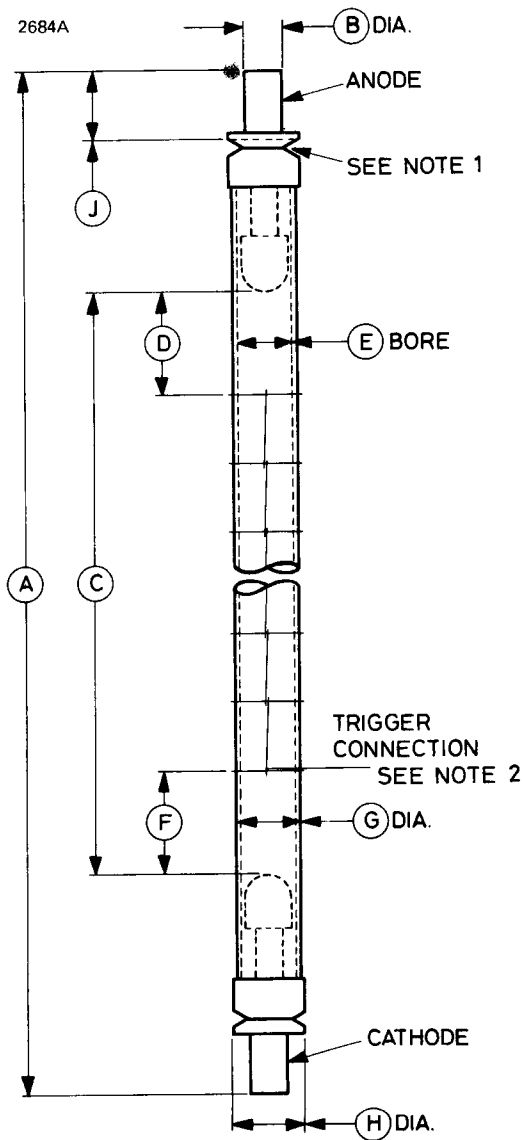

Ref	Inches	Millimetres
A	9.312 ± 0.062	236.5 ± 1.6
B	0.280 ± 0.005	7.11 ± 0.13
C	6.500 ± 0.062	165.1 ± 1.6
D	0.750	19.05
E*	0.276	7.00
F	0.750	19.05
G*	0.354	9.00
H	0.410	10.41
J	0.500	12.70

Millimetre dimensions have been derived from inches except where marked thus \*.

**Outline Notes**

1. The anode terminal is marked with a red band.
2. The fitting of the external trigger wire is optional, depending upon customers' requirements.





# XL615/7-2/1.75TW

## FLASH TUBE

### INTRODUCTION

The XL615/7-2/1.75TW is a flash tube of linear design, for operation at medium energy loadings.

### MAXIMUM AND MINIMUM RATINGS (Absolute values)

Maximum input energy per flash (see note)	100	J
Operating voltage:		
maximum	3.0	kV
minimum	1.0	kV
Minimum trigger voltage	16	kV
Minimum series inductance	400	$\mu$ H

### TYPICAL OPERATION (at maximum input energy)

Operating voltage	2.5	kV
Flash rate	1 per 15s	
Series inductance	400	$\mu$ H
Nominal arc resistance during discharge	2.0	$\Omega$

### MECHANICAL

Overall length	4.562 inches (115.9mm) nom
Envelope diameter	0.276–0.354 inch (7.00–9.00mm) nom
Arc length	1.750 inches (44.45mm) nom
Bore diameter	0.079–0.276 inch (2.00–7.00mm) nom
Net weight	1½ ounces (42g) approx
Mounting position	any

**Note** This rating applies to operation in free air. For cavity operation a reduction in input energy level is necessary, the extent of the reduction depending upon the design and reflectivity of the cavity.

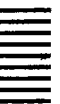

**OUTLINE (All dimensions without limits are nominal)**

3455

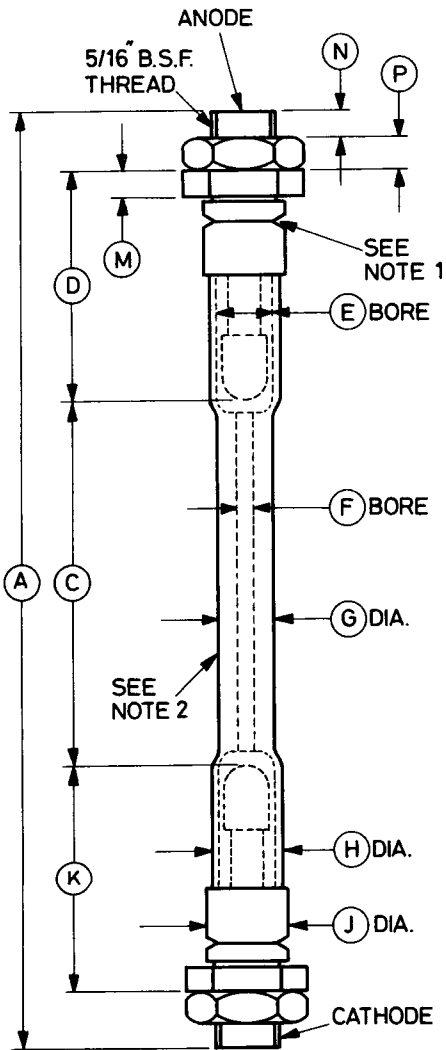
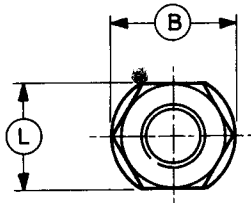

Ref	Inches	Millimetres
A	$4.562 \pm 0.062$	$115.9 \pm 1.6$
B	0.610	15.49
C	$1.750 \pm 0.062$	$44.45 \pm 1.57$
D	1.111	28.22
E*	0.276	7.0
F*	0.079	2.0
G*	0.276	7.0
H*	0.354	9.0
J	0.410	10.41
K	1.111	28.22
L	0.525 max	13.34 max
	0.518 min	13.16 min
M	0.125	3.18
N	0.125	3.18
P	0.156	3.96

Millimetre dimensions have been derived from inches except where marked \*.

**Outline Notes**

1. The anode terminal is marked with a red band.
2. The trigger comprises a metallic strip 0.125 inch (3.18mm) wide on this surface.

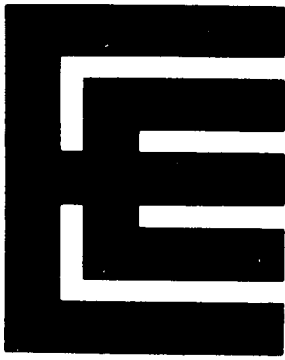

## FLASH TUBE

### INTRODUCTION

The XL615/9/4 is a flash tube of linear design, for operation at high energy loadings.

### MAXIMUM AND MINIMUM RATINGS (Absolute values)

Maximum input energy per flash (see note)	1500	J
Operating voltage:		
maximum	3.0	kV
minimum	1.0	kV
Minimum trigger voltage	16	kV
Minimum series inductance	400	$\mu$ H

### TYPICAL OPERATION (at maximum input energy)

Operating voltage	2.5	kV
Flash rate	1 per 30s	
Series inductance	400	$\mu$ H
Nominal arc resistance during discharge	0.26	$\Omega$

### MECHANICAL

Overall length	6.688 inches (169.9mm) nom
Envelope diameter	0.433 inch (11.00mm) nom
Arc length	4.000 inches (101.6mm) nom
Bore diameter	0.354 inch (9.00mm) nom
Net weight	1½ ounces (42g) approx
Mounting position	any

**Note** This rating applies to operation in free air. For cavity operation a reduction in input energy level is necessary, the extent of the reduction depending upon the design and reflectivity of the cavity.



**OUTLINE (All dimensions without limits are nominal)**

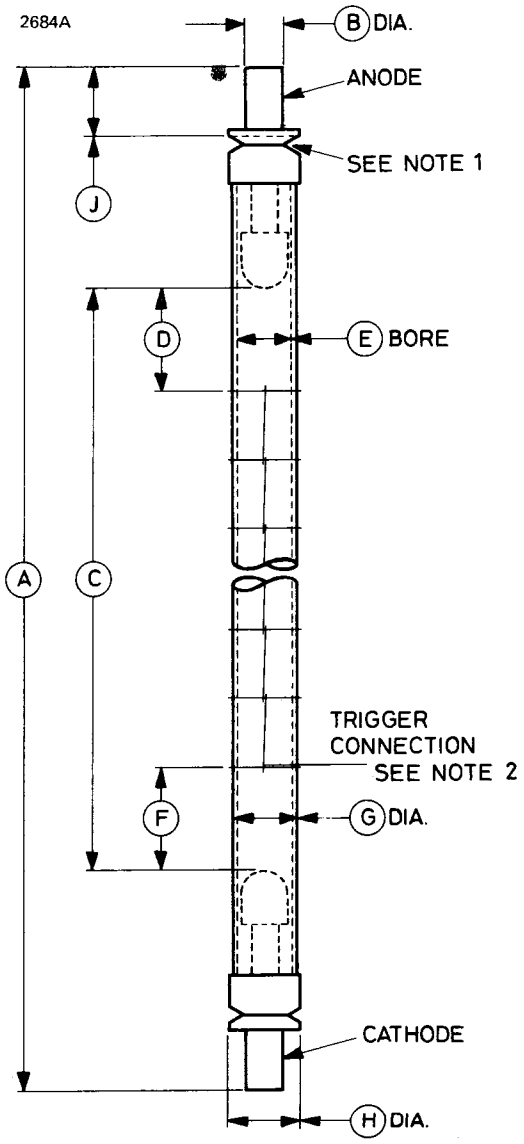

Ref	Inches	Millimetres
A	6.688 ± 0.062	169.9 ± 1.6
B	0.280 ± 0.005	7.11 ± 0.13
C	4.000 ± 0.062	101.6 ± 1.6
D	0.750	19.05
E*	0.354	9.00
F	0.750	19.05
G*	0.433	11.00
H	0.490	12.45
J	0.500	12.70

Millimetre dimensions have been derived from inches except where marked thus \*.

**Outline Notes**

1. The anode terminal is marked with a red band.
2. The fitting of the external trigger wire is optional, depending upon customers' requirements.



## FLASH TUBE

### INTRODUCTION

The XL615/9/10 is a flash tube of linear design, for operation at high energy loadings.

### MAXIMUM AND MINIMUM RATINGS (Absolute values)

Maximum input energy per flash (see note)	3500	J
Operating voltage:		
maximum	3.0	kV
minimum	1.0	kV
Minimum trigger voltage	16	kV
Minimum series inductance	400	$\mu$ H

### TYPICAL OPERATION (at maximum input energy)

Operating voltage	2.5	kV
Flash rate	1 per 30s	
Series inductance	400	$\mu$ H
Nominal arc resistance during discharge	0.65	$\Omega$

### MECHANICAL

Overall length	12.688 inches (322.3mm) nom
Envelope diameter	0.433 inch (11.00mm) nom
Arc length	10.000 inches (254.0mm) nom
Bore diameter	0.354 inch (9.00mm) nom
Net weight	2 ounces (57g) approx
Mounting position	any

**Note** This rating applies to operation in free air. For cavity operation a reduction in input energy level is necessary, the extent of the reduction depending upon the design and reflectivity of the cavity.

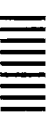

**OUTLINE (All dimensions without limits are nominal)**

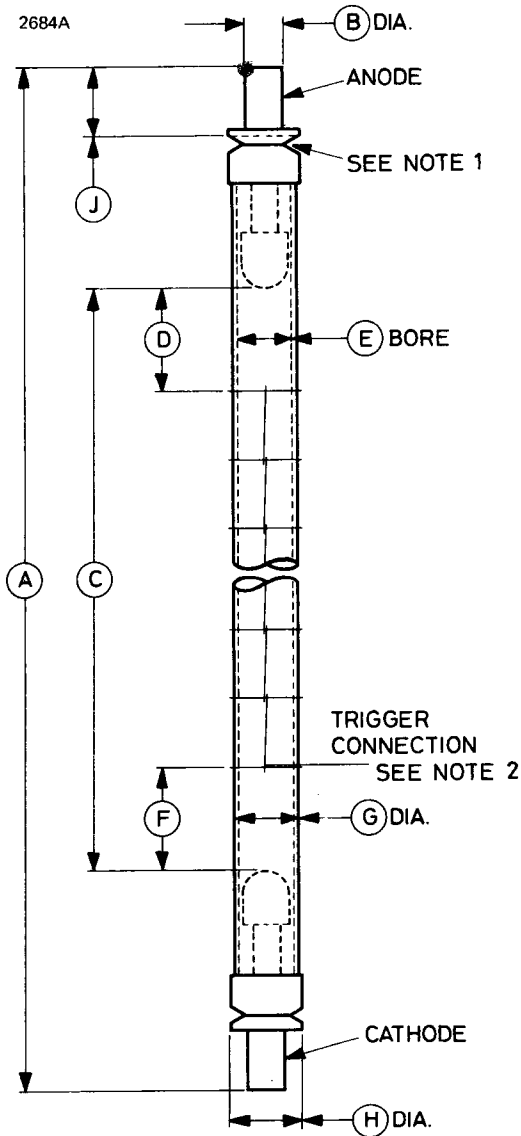

Ref	Inches	Millimetres
A	12.688 ± 0.062	322.3 ± 1.6
B	0.280 ± 0.005	7.11 ± 0.13
C	10.000 ± 0.062	254.0 ± 1.6
D	0.750	19.05
E*	0.354	9.00
F	0.750	19.05
G*	0.433	11.00
H	0.490	12.45
J	0.500	12.70

Millimetre dimensions have been derived from inches except where marked thus \*.

**Outline Notes**

1. The anode terminal is marked with a red band.
2. The fitting of the external trigger wire is optional, depending upon customers' requirements.



### INTRODUCTION

The XL615/10/5.5 is a flash tube of linear design, for operation at high energy loadings.

### MAXIMUM AND MINIMUM RATINGS (Absolute values)

Maximum input energy per flash (see note)	3500	J
Operating voltage:		
maximum	3.0	kV
minimum	1.0	kV
Minimum trigger voltage	16	kV
Minimum series inductance	400	$\mu$ H

### TYPICAL OPERATION (at maximum input energy)

Operating voltage	2.5	kV
Flash rate	1 per 60s	
Series inductance	400	$\mu$ H
Nominal arc resistance during discharge	0.29	$\Omega$

### MECHANICAL

Overall length	8.688 inches (220.7mm) nom
Envelope diameter	0.472 inch (12.00mm) nom
Arc length	5.500 inches (139.7mm) nom
Bore diameter	0.394 inch (10.00mm) nom
Net weight	1½ ounces (42g) approx
Mounting position	any

**Note** This rating applies to operation in free air. For cavity operation a reduction in input energy level is necessary, the extent of the reduction depending upon the design and reflectivity of the cavity.

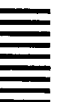

**OUTLINE (All dimensions without limits are nominal)**

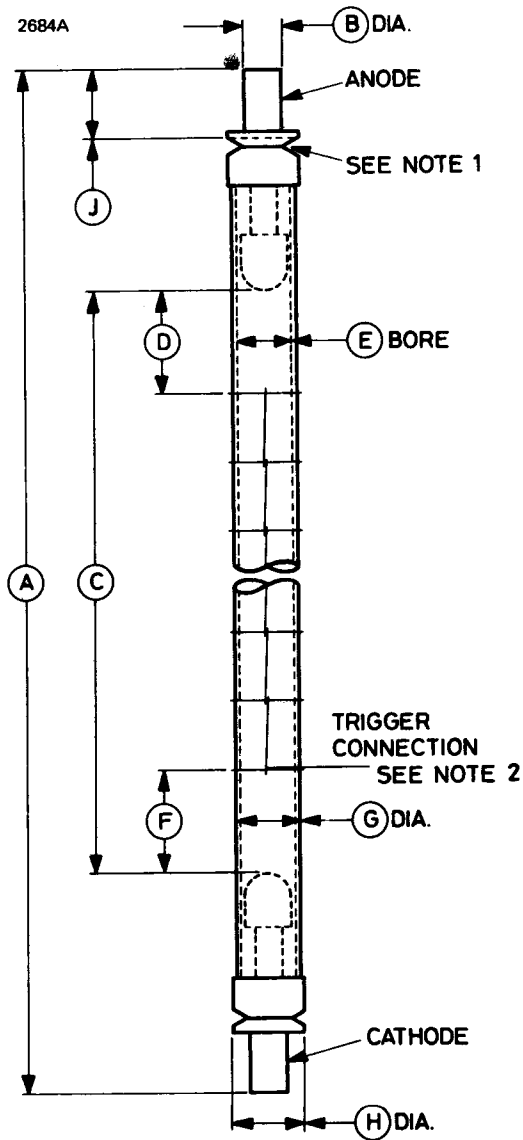

Ref	Inches	Millimetres
A	8.688 ± 0.062	220.7 ± 1.6
B	0.280 ± 0.005	7.11 ± 0.13
C	5.500 ± 0.062	139.7 ± 1.6
D	0.750	19.05
E*	0.394	10.00
F	0.750	19.05
G*	0.472	12.00
H	0.530	13.46
J	0.500	12.70

Millimetre dimensions have been derived from inches except where marked thus \*.

**Outline Notes**

1. The anode terminal is marked with a red band.
2. The fitting of the external trigger wire is optional, depending upon customers' requirements.



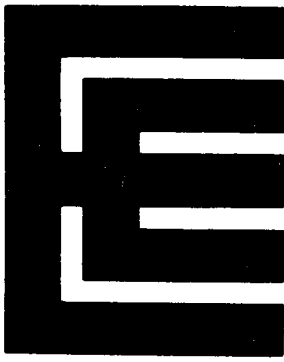

### INTRODUCTION

The XL615/10/6.5 is a flash tube of linear design, for operation at high energy loadings.

### MAXIMUM AND MINIMUM RATINGS (Absolute values)

Maximum input energy per flash (see note)	5000	J
Operating voltage:		
maximum	3.0	kV
minimum	1.0	kV
Minimum trigger voltage	20	kV
Minimum series inductance	800	$\mu$ H

### TYPICAL OPERATION (at maximum input energy)

Operating voltage	2.5	kV
Flash rate	1 per 2 min	
Series inductance	800	$\mu$ H
Nominal arc resistance during discharge	0.35	$\Omega$

### MECHANICAL

Overall length	9.688 inches (246.1mm) nom
Envelope diameter	0.472 inch (12.00mm) nom
Arc length	6.500 inches (165.1mm) nom
Bore diameter	0.394 inch (10.00mm) nom
Net weight	1 $\frac{3}{4}$ ounces (50g) approx
Mounting position	any

**Note** This rating applies to operation in free air. For cavity operation a reduction in input energy level is necessary, the extent of the reduction depending upon the design and reflectivity of the cavity.

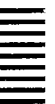

**OUTLINE (All dimensions without limits are nominal)**

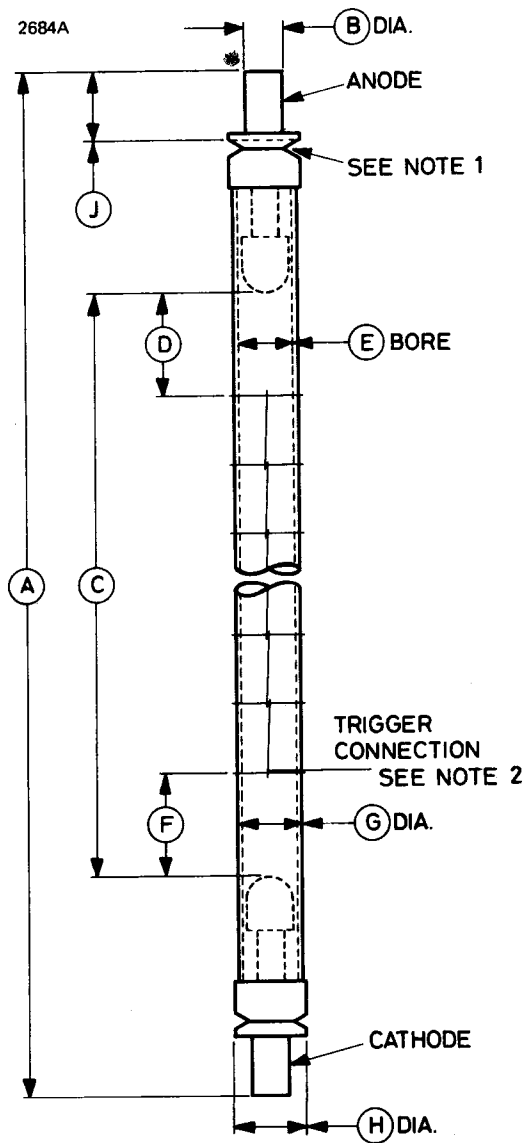

Ref	Inches	Millimetres
A	9.688 ± 0.062	246.1 ± 1.6
B	0.280 ± 0.005	7.11 ± 0.13
C	6.500 ± 0.062	165.1 ± 1.6
D	0.750	19.05
E*	0.394	10.00
F	0.750	19.05
G*	0.472	12.00
H	0.530	13.46
J	0.500	12.70

Millimetre dimensions have been derived from inches except where marked thus \*.

**Outline Notes**

1. The anode terminal is marked with a red band.
2. The fitting of the external trigger wire is optional, depending upon customers' requirements.



## FLASH TUBE

### INTRODUCTION

The XL615/10/12 is a flash tube of linear design, for operation at high energy loadings.

### MAXIMUM AND MINIMUM RATINGS (Absolute values)

Maximum input energy per flash (see note) . . . . .	9000	J
Operating voltage:		
maximum . . . . .	3.0	kV
minimum . . . . .	1.5	kV
Minimum trigger voltage . . . . .	25	kV
Minimum series inductance . . . . .	800	$\mu$ H

### TYPICAL OPERATING CONDITIONS (at maximum input energy)

Typical operating voltage . . . . .	2.5	kV
Typical flash rate . . . . .	1 per 2 min	
Series inductance . . . . .	800	$\mu$ H
Nominal arc resistance during discharge . . . . .	0.7	$\Omega$

### MECHANICAL

Overall length . . . . .	15.188 inches (385.8mm) nom
Envelope diameter . . . . .	0.472 inch (12.00mm) nom
Arc length . . . . .	12.000 inches (304.8mm) nom
Bore diameter . . . . .	0.394 inch (10.00mm) nom
Net weight . . . . .	2½ ounces (71g) approx
Mounting position . . . . .	any

**Note** This rating applies to operation in free air. For cavity operation a reduction in input energy level is necessary, the extent of the reduction depending upon the design and reflectivity of the cavity.



**OUTLINE (All dimensions without limits are nominal)**

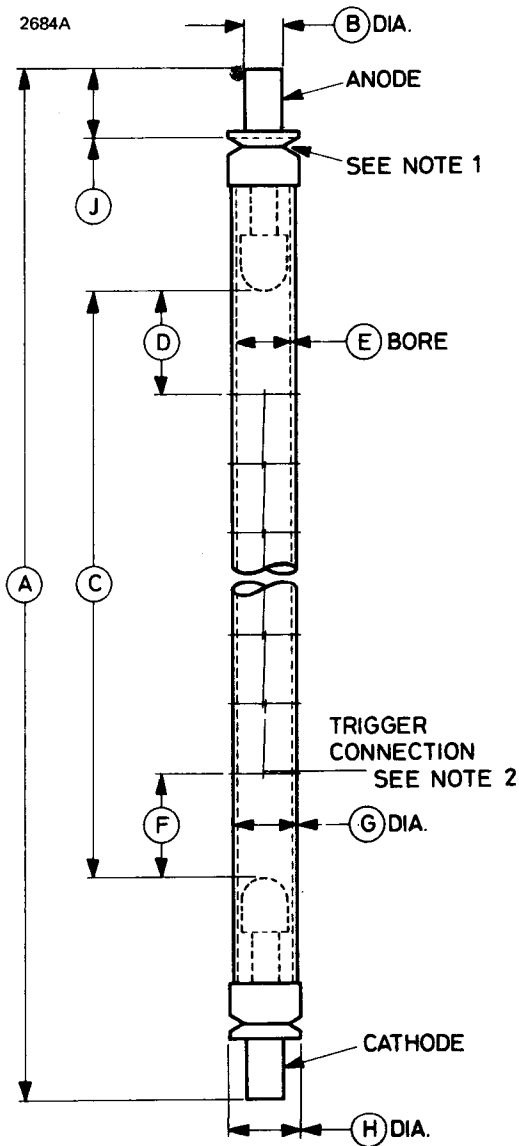

Ref	Inches	Millimetres
A	15.188 ± 0.062	385.8 ± 1.6
B	0.280 ± 0.005	7.11 ± 0.13
C	12.000 ± 0.062	304.8 ± 1.6
D	0.750	19.05
E*	0.394	10.00
F	0.750	19.05
G*	0.472	12.00
H	0.530	13.46
J	0.500	12.70

Millimetre dimensions have been derived from inches except where marked thus \*.

**Outline Notes**

1. The anode terminal is marked with a red band.
2. The fitting of the external trigger wire is optional, depending upon customers' requirements.

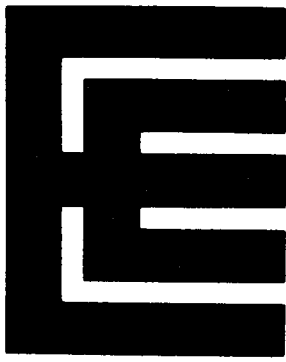

### INTRODUCTION

The XL615/10/40 is a flash tube of linear design, for operation at high energy loadings.

### MAXIMUM AND MINIMUM RATINGS (Absolute values)

Maximum input energy per flash (see note) . . . . .	20 000	J
Operating voltage:		
maximum . . . . .	5.0	kV
minimum . . . . .	3.0	kV
Minimum trigger voltage . . . . .	25	kV
Minimum series inductance . . . . .	800	$\mu$ H

### TYPICAL OPERATION (at maximum input energy)

Operating voltage . . . . .	3.0	kV
Flash rate . . . . .	1 per 2 min	
Series inductance . . . . .	800	$\mu$ H
Nominal arc resistance during discharge . . . . .	2.4	$\Omega$

### MECHANICAL

Overall length . . . . .	43.188 inches (1097mm) nom
Envelope diameter . . . . .	0.472 inch (12.00mm) nom
Arc length . . . . .	40.000 inches (1016mm) nom
Bore diameter . . . . .	0.394 inch (10.00mm) nom
Net weight . . . . .	4 ounces (113g) approx
Mounting position . . . . .	any

**Note** This rating applies to operation in free air. For cavity operation a reduction in input energy level is necessary, the extent of the reduction depending upon the design and reflectivity of the cavity.

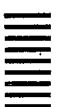

**OUTLINE (All dimensions without limits are nominal)**

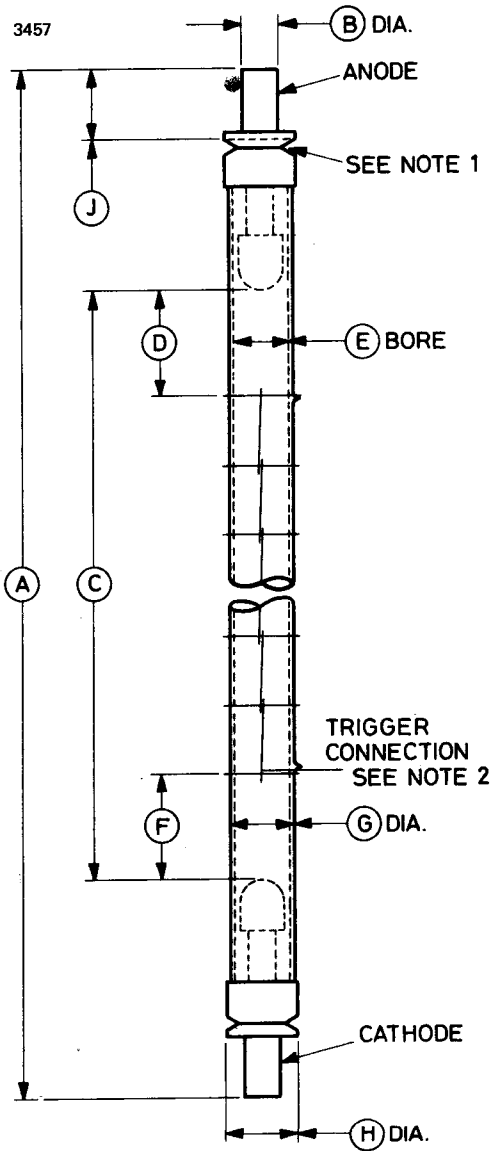

Ref	Inches	Millimetres
A	43.188 ± 0.062	1097.0 ± 1.6
B	0.280 ± 0.005	7.11 ± 0.13
C	40.000 ± 0.062	1016.0 ± 1.6
D	0.750	19.05
E*	0.394	10.00
F	0.750	19.05
G*	0.472	12.00
H	0.530	13.46
J	0.500	12.70

Millimetre dimensions have been derived from inches except where marked thus \*.

**Outline Notes**

1. The anode terminal is marked with a red band.
2. The fitting of the external trigger wire is optional, depending upon customers' requirements.



# XL615/13/6.5

## FLASH TUBE

### INTRODUCTION

The XL615/13/6.5 is a flash tube of linear design, for operation at high energy loadings.

### MAXIMUM AND MINIMUM RATINGS (Absolute values)

Maximum input energy per flash (see note)	10 000	J
Operating voltage:		
maximum	3.0	kV
minimum	1.0	kV
Minimum trigger voltage	25	kV
Minimum series inductance	800	$\mu$ H

### TYPICAL OPERATION (at maximum input energy)

Operating voltage	2.5	kV
Flash rate	1 per 2 min	
Series inductance	800	$\mu$ H
Nominal arc resistance during discharge	0.2	$\Omega$

### MECHANICAL

Overall length	9.750 inches (247.7mm) nom
Envelope diameter	0.591 inch (15.00mm) nom
Arc length	6.500 inches (165.1mm) nom
Bore diameter	0.512 inch (13.00mm) nom
Net weight	2 <sup>3</sup> / <sub>4</sub> ounces (78g) approx
Mounting position	any

**Note** This rating applies to operation in free air. For cavity operation a reduction in input energy level is necessary, the extent of the reduction depending upon the design and reflectivity of the cavity.

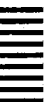

**OUTLINE (All dimensions without limits are nominal)**

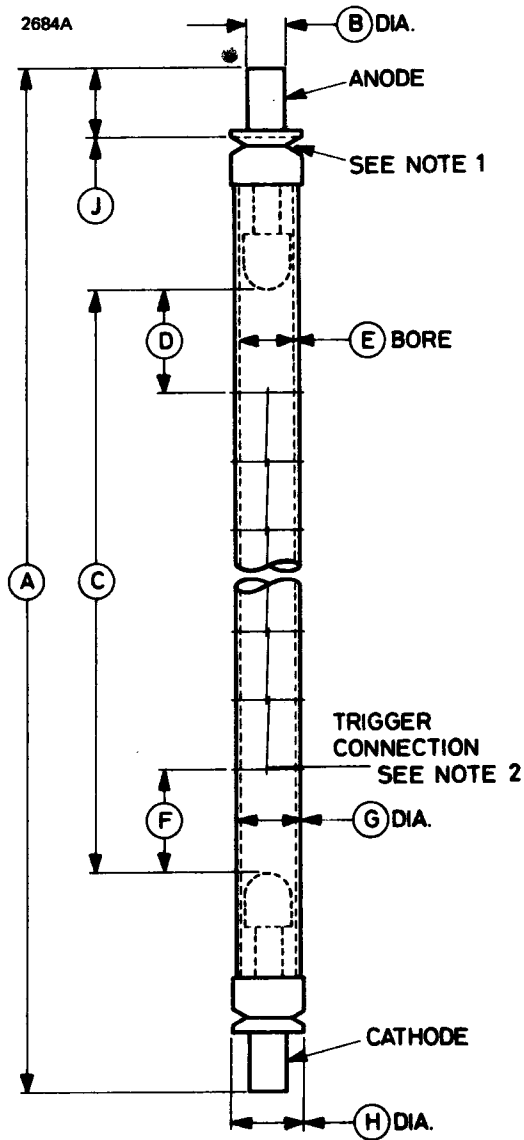

Ref	Inches	Millimetres
A	9.750 ± 0.062	247.7 ± 1.6
B	0.280 ± 0.005	7.11 ± 0.13
C	6.500 ± 0.062	165.1 ± 1.6
D	1.000	25.40
E*	0.512	13.00
F	1.000	25.40
G*	0.591	15.00
H	0.660	16.76
J	0.500	12.70

Millimetre dimensions have been derived from inches except where marked thus \*.

**Outline Notes**

1. The anode terminal is marked with a red band.
2. The fitting of the external trigger wire is optional, depending upon customers' requirements.



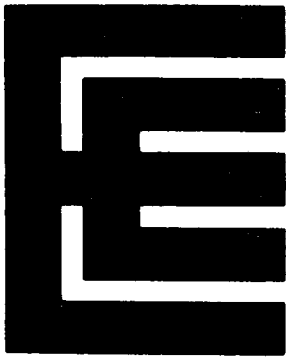

## FLASH TUBE

### INTRODUCTION

The XL615/13/9 is a flash tube of linear design, for operation at high energy loadings.

### MAXIMUM AND MINIMUM RATINGS (Absolute values)

Maximum input energy per flash (see note)	12 500	J
Operating voltage:		
maximum	3.0	kV
minimum	1.0	kV
Minimum trigger voltage	25	kV
Minimum series inductance	800	$\mu$ H

### TYPICAL OPERATION (at maximum input energy)

Operating voltage	2.5	kV
Flash rate	1 per 2 min	
Series inductance	800	$\mu$ H
Nominal arc resistance during discharge	0.3	$\Omega$

### MECHANICAL

Overall length	12.250 inches (311.2mm) nom
Envelope diameter	0.591 inch (15.00mm) nom
Arc length	9.000 inches (228.6mm) nom
Bore diameter	0.512 inch (13.00mm) nom
Net weight	2¾ ounces (78g) approx
Mounting position	any

**Note** This rating applies to operation in free air. For cavity operation a reduction in input energy level is necessary, the extent of the reduction depending upon the design and reflectivity of the cavity.

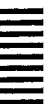

**OUTLINE (All dimensions without limits are nominal)**

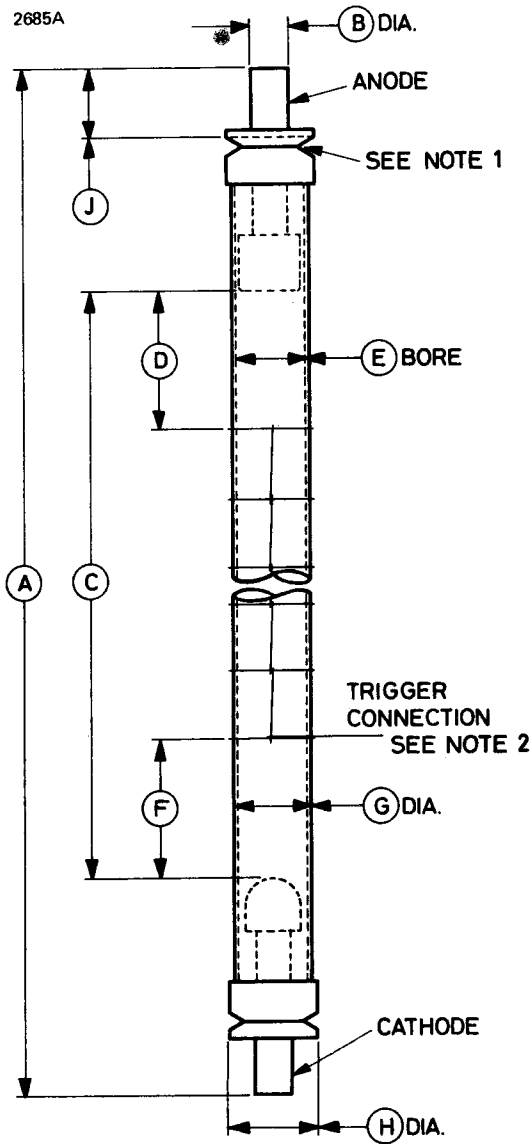

Ref	Inches	Millimetres
A	12.250 ± 0.062	311.2 ± 1.6
B	0.280 ± 0.005	7.11 ± 0.13
C	9.000 ± 0.062	228.6 ± 1.6
D	1.000	25.40
E*	0.512	13.00
F	1.000	25.40
G*	0.591	15.00
H	0.660	16.76
J	0.500	12.70

Millimetre dimensions have been derived from inches except where marked thus \*.

**Outline Notes**

1. The anode terminal is marked with a red band.
2. The fitting of the external trigger wire is optional, depending upon customers' requirements.

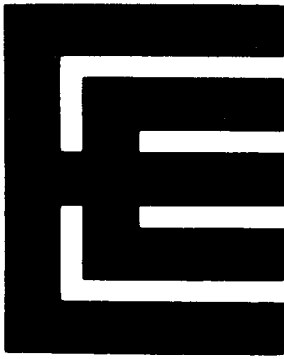

### INTRODUCTION

The XL615/13/12 is a flash tube of linear design, for operation at high energy loadings.

### MAXIMUM AND MINIMUM RATINGS (Absolute values)

Maximum input energy per flash (see note 1)	18 000	J
Operating voltage:		
maximum	3.0	kV
minimum	1.5	kV
Minimum trigger voltage	25	kV
Minimum series inductance	800	$\mu$ H

### TYPICAL OPERATING CONDITIONS (at maximum input energy)

Typical operating voltage	2.5	kV
Typical flash rate	1 per 2 min	
Series inductance	800	$\mu$ H
Nominal arc resistance during discharge (see note 2)	0.6	$\Omega$

### MECHANICAL

Overall length	15.250 inches (387.4mm) nom
Envelope diameter	0.591 inch (15.00mm) nom
Arc length	12.000 inches (304.8mm) nom
Bore diameter	0.512 inch (13.00mm) nom
Net weight	3 ounces (85g) approx
Mounting position	any

### NOTES

1. The energy levels are for operation in a cavity with a minimum value of series inductance of 800 $\mu$ H. For lower values of series inductance the input energy must be reduced in accordance with  $\tau \propto J^2$  where  $\tau$  is pulse width and J is input energy.
2. Nominal arc resistance at 2500A peak current.



**OUTLINE (All dimensions without limits are nominal)**

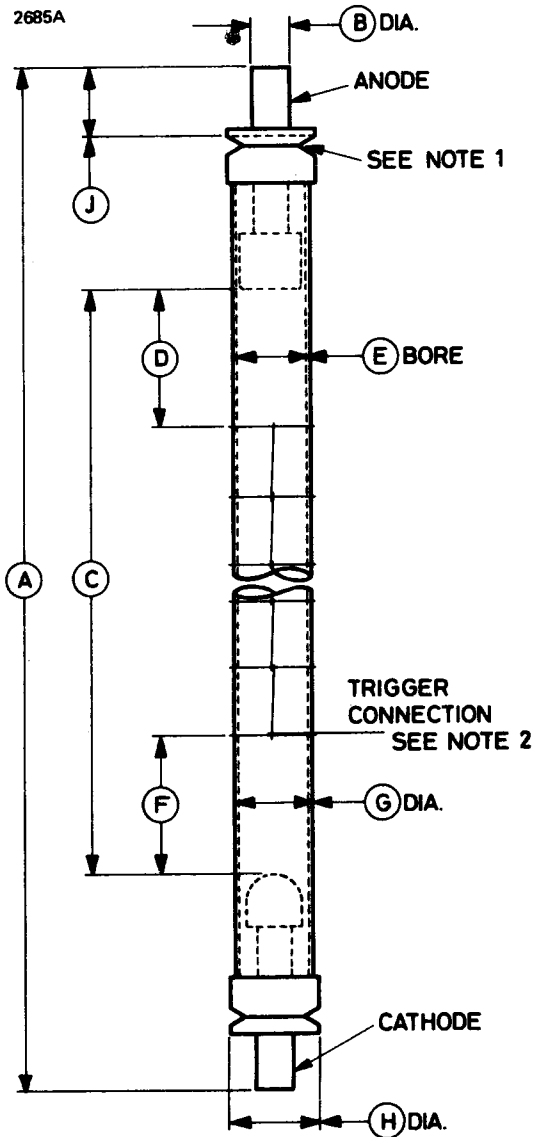

Ref	Inches	Millimetres
A	15.250 ± 0.062	387.4 ± 1.6
B	0.280 ± 0.005	7.11 ± 0.13
C	12.000 ± 0.062	304.8 ± 1.6
D	1.000	25.40
E*	0.512	13.00
F	1.000	25.40
G*	0.591	15.00
H	0.660	16.76
J	0.500	12.70

Millimetre dimensions have been derived from inches except where marked thus \*.

**Outline Notes**

1. The anode terminal is marked with a red band.
2. The fitting of the external trigger wire is optional, depending upon customers' requirements.

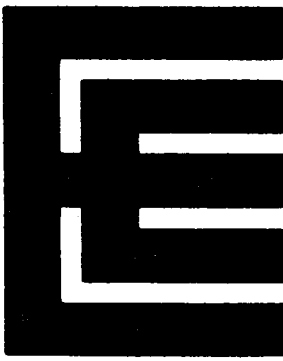

### DESCRIPTION

The XL630 is a xenon filled flash tube of spiral design, intended for use in stroboscopic applications.

### CHARACTERISTICS

Maximum average input power . . . . .	40	W
Maximum anode voltage . . . . .	1400	V
Minimum anode voltage . . . . .	800	V
Trigger input energy . . . . .	4.0	mWs
Minimum ignition voltage . . . . .	6.0	kV
Maximum operating frequency . . . . .	300	Hz
Operating hours . . . . .	50	hours

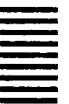

**OUTLINE (All dimensions without limits are nominal)**

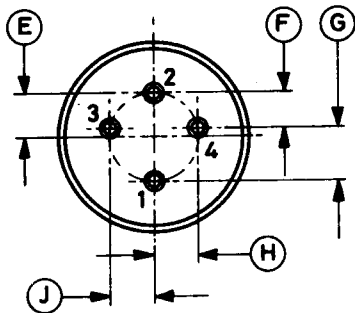
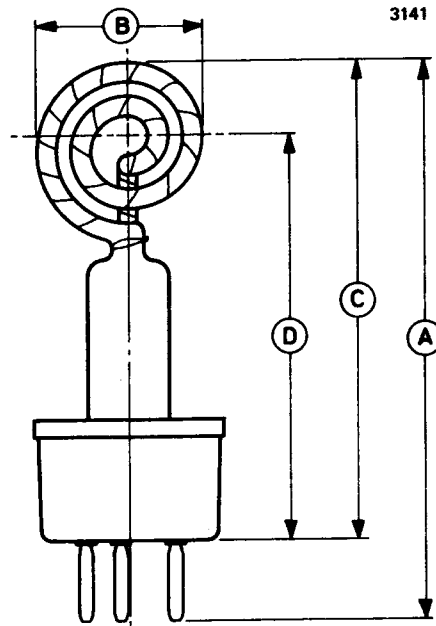
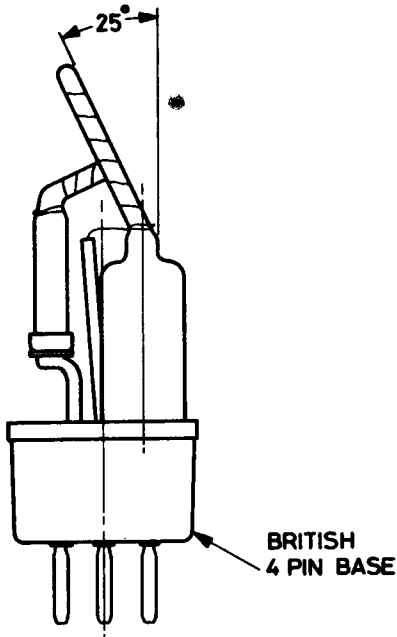

Pin	Element
1	Trigger
2	No connection
3	Anode
4	Cathode

Ref	Millimetres	Inches
A	110.0 max	4.331 max
B	28.0 ± 1.0	1.102 ± 0.039
C	95.0 max	3.740 max
D	75.5 ± 2.5	2.972 ± 0.098
E	8.13	0.320
F	6.10	0.240
G	10.15	0.400
H	8.00	0.315
J	8.00	0.315

Inch dimensions have been derived from millimetres.



### INTRODUCTION

The XL639/4/1.75 is a flash tube of linear design, for operation at medium energy loadings.

### MAXIMUM AND MINIMUM RATINGS (Absolute values)

Maximum input energy per flash (see note)	250	J
Operating voltage:		
maximum	3.0	kV
minimum	1.0	kV
Minimum trigger voltage	12	kV
Minimum series inductance	400	$\mu$ H

### TYPICAL OPERATION

Operating voltage	2.5	kV
Flash rate	1 per 30	s
Series inductance	400	$\mu$ H
Nominal arc resistance during discharge	0.5	$\Omega$

**Note** This rating applies to operation in free air. For cavity operation a reduction in input energy level is necessary, the extent of the reduction depending upon the design and reflectivity of the cavity.

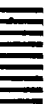

# OUTLINE (All dimensions without limits are nominal)

3632

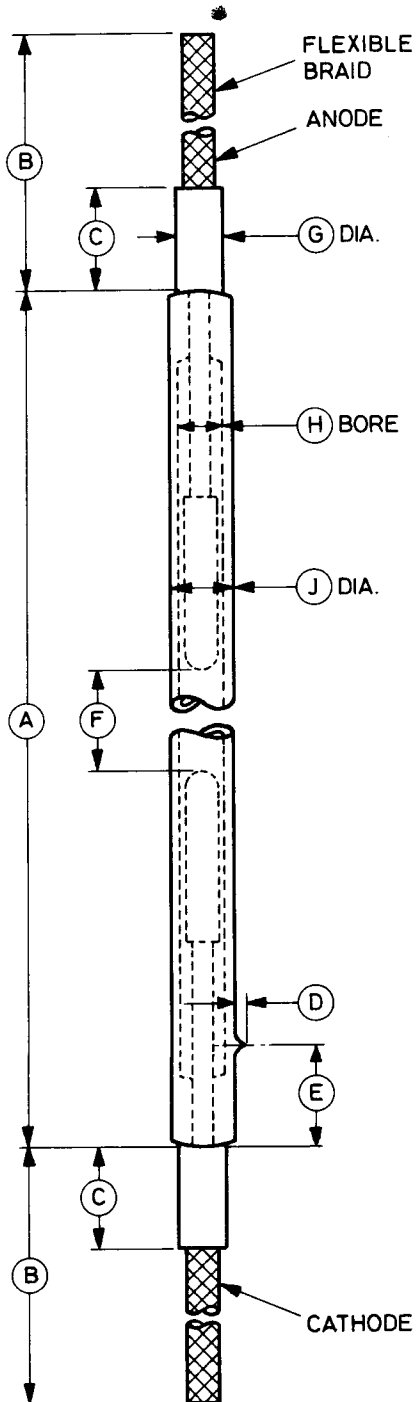

Ref	Inches	Millimetres
A	4.500	114.3
B	3.000	76.20
C	0.375	9.53
D	0.045 max	1.14 max
E	0.375	9.53
F	1.750	44.45
G	0.187	4.75
H*	0.157	4.00
J*	0.236	6.00

Millimetre dimensions have been derived from inches except where indicated thus \*.



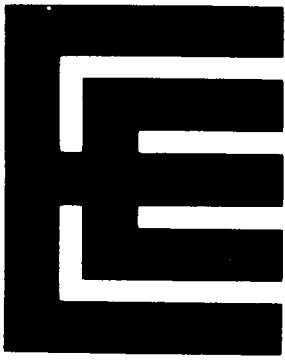

### INTRODUCTION

The XL639/4/2.75 is a flash tube of linear design, for operation at medium energy loadings.

### MAXIMUM AND MINIMUM RATINGS (Absolute values)

Maximum input energy per flash (see note) . . . . .	400	J
Operating voltage:		
maximum . . . . .	3.0	kV
minimum . . . . .	1.0	kV
Minimum trigger voltage . . . . .	12	kV
Minimum series inductance . . . . .	400	$\mu$ H

### TYPICAL OPERATION

Operating voltage . . . . .	2.5	kV
Flash rate . . . . .	1 per 30	s
Series inductance . . . . .	400	$\mu$ H
Nominal arc resistance during discharge . . . . .	0.5	$\Omega$

**Note** This rating applies to operation in free air. For cavity operation a reduction in input energy level is necessary, the extent of the reduction depending upon the design and reflectivity of the cavity.



**OUTLINE (All dimensions without limits are nominal)**

3632

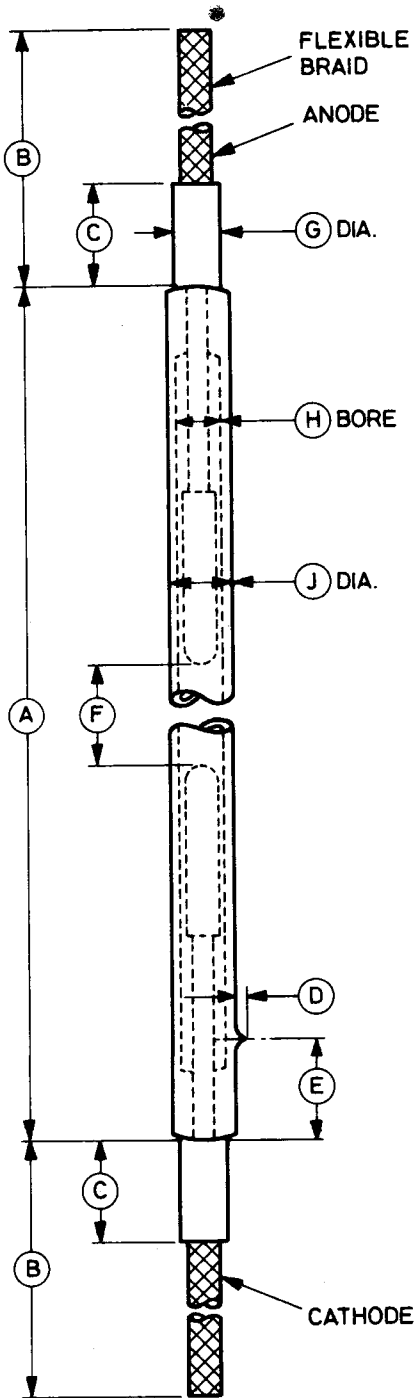

Ref	Inches	Millimetres
A	5.500	139.7
B	3.000	76.20
C	0.375	9.53
D	0.045 max	1.14 max
E	0.375	9.53
F	2.750	69.85
G	0.187	4.75
H*	0.157	4.00
J*	0.236	6.00

Millimetre dimensions have been derived from inches except where indicated thus \*.

**Overseas  
Representatives  
and Distributors**

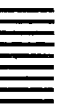

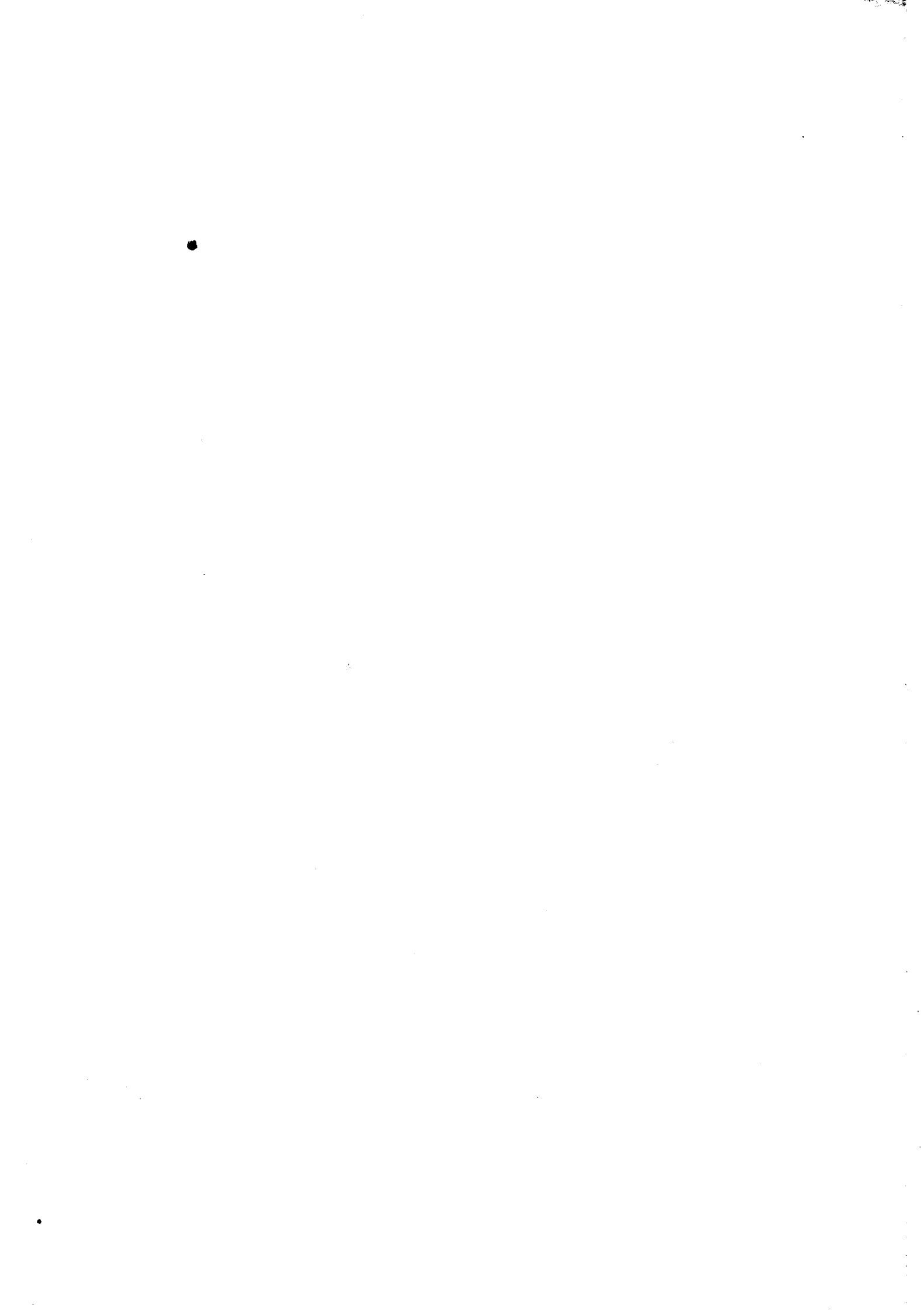



# OVERSEAS REPRESENTATIVES and DISTRIBUTORS

---

## ALBANIA

F. A. Bernhardt G.m.b.H.,  
Isoppgasse 23, Mauer A-1238, Vienna XXIII,  
Austria.  
Tel: (0222) 88 27 512  
Cables: Hankobern Vienna

## ARGENTINE REPUBLIC

English Electric Marconi Argentina S.R.L.,  
Casilla Correo Central No. 4476,  
Paseo Colon 669-4 Piso, Buenos Aires.  
Tel: 34-3071/78 Cables: Gecaires  
Telex: 0122253 Buenos Aires

## AUSTRALIA

GEC-Elliott Automation,  
Electron Tube Division, 373 Horsley Road,  
Milperra N.S.W. 2214.  
(P.O. Box 27, Revesby, N.S.W. 2212).  
Tel: 77 0551 Cables: Ellauto Sydney  
Telex: AA20807

## AUSTRIA

William Pattermann,  
Rudolfnergasse 18, P.O. Box 101,  
1190 Vienna XIX.  
Tel: 36 36 47, 36 35 95  
Cables: Britubium Vienna Telex: 7-4532

## BANGLADESH

The General Electric Company of Bangladesh Ltd.  
72 Dilkhusha Commercial Area, Motijheel,  
P.O. Box 123, Dacca 2.  
Tel: 281859, 252011-13  
Cables: Gecdac Dacca

## BARBADOS

Balmoral Ltd., Hastings,  
Barbados, W.I. Tel: 7763



**BELGIUM,  
LUXEMBOURG,  
ZAIRE, KATANGA,  
RUANDA**

SAIT Electronics,  
66 Chaussée de Ruisbroek, 1190 Brussels.  
Tel: 02/76 20 30 Cables: Wireless Brussels  
Telex: 21601

**BRAZIL**

**Camera Tubes**

Brazileira de Comercio Exterior Ltda.  
(BRASCOM),  
Praça XV de Novembro, 34-2° andar,  
Rio de Janeiro-Guanabara.  
Tel: 231-2899  
Cables: Riobrascom Rio de Janeiro

**General Distributors**

Staub S.A.,  
Caixa Postal 30-318, Sao Paulo.  
Tel: 269 6673, 269 0625  
Cables: Sapestab Sao Paulo Telex: 021678

**BULGARIA**

F. A. Bernhardt G.m.b.H.,  
Isoppgasse 23, Mauer A-1238, Vienna XXIII,  
Austria.  
Tel: (0222) 88 27 512  
Cables: Hankobern Vienna

**CANADA**

English Electric Valve North America Ltd.,  
24 Ronson Drive, Rexdale, Ontario.  
Tel: 416 249 8548 Cables: Enelecan Toronto  
Telex: 06 965864

**CHILE**

Gibbs Y Cia S.A.C.,  
P.O. Box 67-D, Santiago.  
Tel: 82691  
Cables: Antipodean Santiago Chile  
Telex: Gibbs SG0309 (Santiago Chile)

**CHINA and  
HONG KONG**

Marconi (China) Ltd.,  
G.P.O. Box 186, Hong Kong.  
Tel: 221189 Cables: Marchilim Hongkong

<b>COLOMBIA</b>	Repro Ltda., Apartado Aereo 5660, Bogota D.E. Tel: 34 41 40 Cables: Repro Bogota Telex: 441271 Riam Co.
<b>* CZECHOSLOVAKIA</b>	F. A. Bernhardt G.m.b.H., Isoppgasse 23, Mauer A-1238, Vienna XXIII, Austria. Tel: (0222) 88 27 512 Cables: Hankobern Vienna
<b>DENMARK</b>	Sophus Berendsen A.S., 10 Amaliegade, 1256 Copenhagen K. Tel: (01) 14 85 00 Cables: Berendsen Copenhagen Telex: 22285 Sobeas dk
<b>FINLAND</b>	Insinöörtoimisto Oy Aseko Ab, Vuorikatu 22, 00100 Helsinki 10. Tel: 62 59 53, 62 51 19 Cables: Aseko Helsinki Telex: 122242
<b>FRANCE</b>	Société d'Équipement Industriel Electro-Mecanique (S.E.I.E.M.), 8 Rue Polonceau, 75 881 Paris 18. Tel: 076 41 39 Telex: 29269 Inelmec
<b>GERMAN DEMOCRATIC REPUBLIC</b>	F. A. Bernhardt G.m.b.H., Isoppgasse 23, Mauer A-1238, Vienna XXIII, Austria. Tel: (0222) 88 27 512 Cables: Hankobern Vienna
<b>GERMAN FEDERAL REPUBLIC</b>	Nucletron Vertriebs - G.m.b.H., Gartnerstrasse 60, 8 Munich 50. Tel: (0811) 14 60 81-85 Telex: 5215297
<b>GREECE</b>	Telectrotec, 18 Voulis Street, Athens 126. Tel: 322 72 67 Cables: Telectrocom Athens



**HUNGARY**

F. A. Bernhardt G.m.b.H.,  
Isoppgasse 23, Mauer A-1238, Vienna XXIII,  
Austria.  
Tel: (0222) 88 27 512  
Cables: Hankobern Vienna

**ICELAND**

Orka Ltd.,  
P.O. Box 360, Laugavegur 178, Reykjavik.  
Tel: 38000 Cables: Power Reykjavik  
Telex: 2095

**INDIA**

Associated Instrument Manufacturers (India)  
Private Ltd.,  
B5 Gillander House, P.O. Box 2136, Calcutta.  
Tel: 223304 Cables: Aimil Calcutta  
Telex: 021 7731

Also at: India House, Walchand Hirachand  
Marg., Bombay 1.  
Tel: 265654/5 Cables: Aimilbom Bombay  
Telex: 011 2931

Also at: Sunlight Insurance Building,  
26-27 Asaf Ali Road, New Delhi.  
Tel: 273611/2 Cables: Aimildel New Delhi  
Telex: 031 7400

Also at: Post Box 2756, Madras 2  
Tel: 86 Cables: Aimilmad Madras

**IRAN**

Telecom Ltd.,  
Dr. Amid Building, 5th Floor, 325 Avenue Iran  
Novin, Tehran.  
Tel: 48111, 69374 Cables: Bascom Tehran  
Telex: 2664

**IRAQ**

Leon Kouyoumdjian and Co.  
Fixit House, Sa'adoon Street, Alwiya, Baghdad.  
Tel: 96078, 96079  
Cables: Fixit Baghdad



**ITALY**

Marconi Italiana S.p.A.,  
Via A Negrone 1A, 16153 Genova Cornigliano.  
Tel: 47 32 51/5, 47 97 41/4  
Cables: Expanse Cornigliano — Ligure  
Telex: Marconit 27386

Also at: Via Adige 39, 00198 Rome.  
Tel: 863341, 861713, 863326  
Cables: Expanse Rome Telex: Marconir 61272

Also at: Via Comelico 3, 20135 Milan.  
Tel: 592513, 592489, 592379  
Cables: Expanse Milan Telex: Eecomarc 32467

**JAPAN**

Cornes and Co. Ltd.,  
C.P.O. Box 158, Tokyo 100-91.  
Tel: 272-5771 Cables: Cornes Tokyo  
Telex: 222-2987 Cornes Tokyo

Also at: Marden House, C.P.O. Box 329, Osaka  
530-91.  
Tel: (532) 1012/1019 Cables: Cornes Osaka  
Telex: 525-4496 Corosa J

**JORDAN**

Hammad & Kamal Trading Co.,  
P.O.B. 621, Amman.  
Tel: 25331, 30731 Cables: Hammad Amman

**KENYA  
(also TANZANIA)**

Technical and Industrial Representatives Ltd.,  
P.O. Box 45375, Nairobi.  
Tel: 26936/7 Cables: Techind Nairobi

**KOREA**

Korea Electric Company Ltd.,  
P.O. Box 116, Kwang Wha Moon, Seoul.  
Tel: 74-4689, 73-5525, 74-7757  
Cables: Electron Seoul

**KUWAIT**

Fager Development Establishment,  
P.O. Box 1609, Kuwait.  
Tel: 424707 Cables: Abeer



**LEBANON**

Rizk Brothers, P.O. Box 4875, Beirut.  
Tel: 237777, 259535 Cables: Buildbros

**LIBYA**

Figli di B. Miscerghi S.p.A.,  
Errafei Street No. 16, Tripoli.  
Tel: 30105/8 Cables: Miscerghi Tripoli

**MALAYSIA (WEST)**

The General Electric Co. of Malaysia Sendirian  
Berhad,  
Magnet House, P.O. Box 256,  
2 & 4 Jalan Campbell, Kuala Lumpur.  
Tel: 84291  
Cables: Geclumpur Kuala Lumpur  
Telex: KL335

**MEXICO**

Agencias Canadenses Y Occidentales S.A.  
Apartado Postal 8600, Mexico 1, D.F.  
Tel: (5) 46 46 46, 46 48 04/5  
Cables: Asa Mexico City

**NETHERLANDS**

SAIT Electronics Nederland,  
Strevelsweg 700, 507 Rotterdam 3025.  
Tel: 010-81 46 44, 010-81 48 41  
Telex: 24315

**NEW ZEALAND**

Amalgamated Wireless (Australasia) N.Z. Ltd.,  
Commerce House, P.O. Box 830, Wellington C.I.  
Tel: 58-979  
Cables: Expanse Wellington

Also at: P.O. Box 1363 Auckland.

Also at: P.O. Box 2084 Christchurch.

**NIGERIA**

R. T. Briscoe (Nigeria) Ltd.,  
P.O. Box 2104, 8-10 Yakubu Gowan Street,  
Lagos.  
Tel: 22735, 26009 Cables: Briscoe  
Telex: 21249

**NORWAY**

Norsk Marconikompani A/S,  
Instrument & Components Dept.,  
Ryensvingen 5, P.O. Box 50, Manglerud, Oslo 6.  
Tel: 67 04 86 Cables: Marconi Oslo  
Telex: 16218 NMK N

**PAKISTAN**

General Products Group Ltd.  
239 Staff Lines, P.O. Box 3987,  
Fatima Jinnah Road, Karachi 4.  
Tel: 513541-43  
Cables: Products Karachi

**PERU**

Fernando Ezeta B.,  
Casilla 3061, Lima.  
Tel: 45-2335 Cables: Feperu

**POLAND**

F. A. Bernhardt G.m.b.H.,  
Isoppgasse 23, Mauer A-1238, Vienna XXIII,  
Austria.  
Tel: (0222) 88 27 512  
Cables: Hankobern Vienna

**PORTUGAL**

MEDITROM – Comercial de Equipamentos  
Técnicos SARL,  
Avenida 5 de Outubro 89, Lisbon 1.  
Tel: 77 85 95 Cables: Meditrom Lisbon

**RUMANIA**

F. A. Bernhardt G.m.b.H.,  
Isoppgasse 23, Mauer A-1238, Vienna XXIII,  
Austria.  
Tel: (0222) 88 27 512  
Cables: Hankobern Vienna

**SINGAPORE (also  
BRUNEI, EAST  
MALAYSIA)**

The General Electric Co. of Singapore Private Ltd.,  
Magnet House, P.O. Box 4046, Bukit Timah,  
Singapore 21.  
Tel: 663011 Cables: Geccsingap Singapore  
Telex: RS21508



**SOUTH AFRICA**  
(also **BOTSWANA,**  
**LESOTHO,**  
**MOZAMBIQUE,**  
**SWAZILAND**)\*

Marconi (South Africa) Ltd.,  
Private Bag 1038, Benoni.  
Tel: 52-7771/4  
Cables: Expanse Johannesburg  
Telex: 43-0469JH

**SPAIN**

Suministros Electricos Maldonado,  
Fernando el Catolico 63, Madrid 15.  
Tel: 449 04 51/2 Cables: Electronmaldo  
Telex: 23498

**SWEDEN**

Svenska Radio AB,  
Agencies Division, S-102 20, Stockholm.  
Tel: 22 31 40 Cables: Svenskradio Stockholm  
Telex: 100-94

**SWITZERLAND**

Erno Electronic A.G.,  
Restelbergstrasse 49, CH8044, Zurich.  
Tel: (01) 28 94 32 Cables: Eugenerno Zurich  
Telex: 52974

**SYRIA**

Attar Brothers Company Engineering,  
P.O. Box 2771, Damascus.  
Tel: 18100, 18555 Cables: Attarco Damascus  
Telex: 20023 Attars Damascus

**THAILAND**

Vichien Pathana Ltd. Partnership,  
G.P.O. Box 1656, 428/1 Siphya Road, Bangkok.  
Tel: 31793 Cables: Vipat Bangkok

**TRINIDAD &**  
**TOBAGO,**  
**and GUYANA**

CARTEL – Caribbean Telecoms Ltd.,  
Post Bag 732, Port-of-Spain, Trinidad.  
Tel: 62-37727, 38122  
Cables: Cartel Port-of-Spain

**TURKEY**

Ratel Radio Telecommunication Co. Ltd.,  
Okcu Musa Caddesi, Bankalar Sarayi, Karakoy,  
Istanbul.  
Tel: 45 50 05, 45 50 06 Cables: Ratelcom  
Istanbul Telex: 148 Istanbul

**UGANDA**

Technical and Industrial Representations  
(Uganda) Ltd.  
P.O. Box 4335, Kampala.  
Tel: 57402 Cables: Techind Kampala

**UNITED STATES  
OF AMERICA****Camera Tubes**

English Electric Valve North America Ltd.,  
195 Sugg Road, Cheektowaga, New York 14225.  
Tel: (716) 632 5871 Cables: Enelecus Buffalo  
TWX no: 710 523 1862

**General Distributors**

Calvert Electronics International Inc.,  
220 East 23rd Street, New York, N.Y. 10010.  
Tel: (212) 679 1340  
Cables: Calvertron New York  
Telex: 223415

Also at: P.O. Box 5066, San Jose,  
California 95150  
Tel: (408) 265-0521  
TWX no: 910-338-0521

**URUGUAY**

Pellmar S.A.,  
Piedras 676-77, Montevideo.  
Tel: 8-14-47 Cables: Pellicersa Montevideo

**VENEZUELA**

Marconi de Venezuela C.A.,  
Apartado 3923, Caracas, Postal Zone 101.  
Tel: 54-51-16/7/8 Cables: Expanse Caracas  
Telex: 22856 Marconi Caracas

**VIETNAM**

International Group Ltd.,  
P.O. Box 1078, Saigon.

**YUGOSLAVIA**

F. A. Bernhardt G.m.b.H.,  
Isoppgasse 23, Mauer A-1238, Vienna XXIII,  
Austria.  
Tel: (0222) 88 27 512  
Cables: Hankobern Vienna



---



**QUICK REFERENCE TABLES  
AND EQUIVALENTS INDEX**

---



**STORAGE TUBES**

---



**IMAGE ORTHICONS**

---



**IMAGE ISOCONS**

---



**LEDDICONS**

---



**SIDICONS**

---



**VIDICONS**

---



**IMAGE INTENSIFIERS  
AND SHUTTER TUBES**

---



**GLOW MODULATORS**

---



**FLASH TUBES**

---



**OVERSEAS REPRESENTATIVES  
AND DISTRIBUTORS**

---

