

PHILIPS

DATA HANDBOOK



ELECTRONIC COMPONENTS
AND MATERIALS

COMPONENTS AND MATERIALS

PART 2

DECEMBER 1970

Resistors

Capacitors

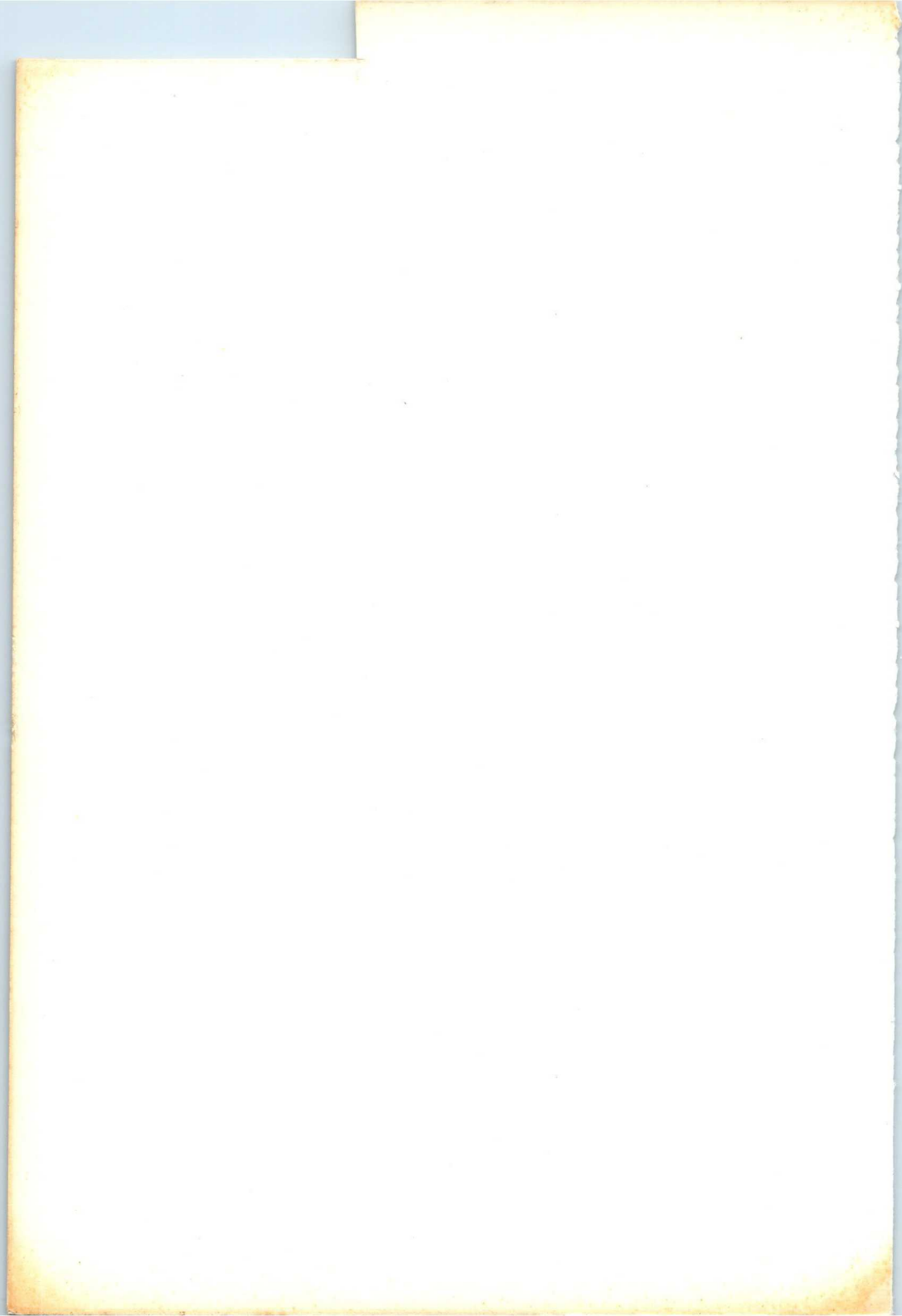

COMPONENTS AND MATERIALS

Part 2

December 1970

Fixed resistors	A
-----------------	---

Variable resistors	B
--------------------	---

Non-linear resistors	C
----------------------	---

Ceramic capacitors	D
--------------------	---

Polyester, polycarbonate, polystyrene, paper capacitors	E
--	---

Electrolytic capacitors	F
-------------------------	---

Variable capacitors	G
---------------------	---

Comprehensive contents list at the back

DATA HANDBOOK SYSTEM

To provide you with a comprehensive source of information on electronic components, subassemblies and materials, our Data Handbook System is made up of three series of handbooks, each comprising several parts.

The three series, identified by the colours noted, are:

ELECTRON TUBES (9 parts)	BLUE
SEMICONDUCTORS AND INTEGRATED CIRCUITS (5 parts)	RED
COMPONENTS AND MATERIALS (5 parts)	GREEN

The several parts contain all pertinent data available at the time of publication, and each is revised and reissued annually; the contents of each series are summarized on the following pages.

We have made every effort to ensure that each series is as accurate, comprehensive and up-to-date as possible, and we hope you will find it to be a valuable source of reference. Where ratings or specifications quoted differ from those published in the preceding edition they will be pointed out by arrows. You will understand that we can not guarantee that all products listed in any one edition of the handbook will remain available, or that their specifications will not be changed, before the next edition is published. If you need confirmation that the published data about any of our products are the latest available, may we ask that you contact our representative. He is at your service and will be glad to answer your inquiries.

ELECTRON TUBES (BLUE SERIES)

This series consists of the following parts, issued on the dates indicated.

Part 1

January 1970

Transmitting tubes (Tetrodes, Pentodes)

Associated accessories

Part 2

February 1970

Tubes for microwave equipment

Part 3

March 1970

Special Quality tubes

Miscellaneous devices

Part 4

April 1970

Receiving tubes

Part 5

May 1970

Cathode-ray tubes

Photoconductive devices

Photo tubes

Associated accessories

Camera tubes

Part 6

June 1970

Photomultiplier tubes

Radiation counter tubes

Scintillators

Semiconductor radiation detectors

Photoscintillators

Neutron generator tubes

Associated accessories

Part 7

July 1970

Voltage stabilizing and reference tubes

Thyratrons

Counter, selector, and indicator tubes

Ignitrons

Trigger tubes

Industrial rectifying tubes

Switching diodes

High-voltage rectifying tubes

Part 8

August 1970

T.V. Picture tubes

Part 9

December 1969

Transmitting tubes (Triodes)

Associated accessories

Tubes for R.F. heating (Triodes)

August 1970

SEMICONDUCTORS AND INTEGRATED CIRCUITS (RED SERIES)

This series consists of the following parts, issued on the dates indicated.

Part 1	Diodes and Thyristors	September 1970
General		Rectifier diodes
Signal diodes		Thyristors, diacs, triacs
Tunnel diodes		Rectifier stacks
Variable capacitance diodes		Accessories
Voltage regulator diodes		Heatsinks
Part 2	Low frequency; Deflection	October 1970
General		Deflection transistors
Low frequency transistors (low power)		Accessories
Low frequency power transistors		
Part 3	High frequency; Switching	November 1970
General		Switching transistors
High frequency transistors		Accessories
Part 4	Special types	December 1970
General		Beam lead devices for thick- and thin-film circuits
Transmitting transistors		Photo devices
Microwave devices		Accessories
Field effect transistors		
Dual transistors		
Microminiature devices for thick- and thin-film circuits		
Part 5	Integrated Circuits	February 1970
General		Linear integrated circuits
Digital integrated circuits		
FC family; standard temperature range		
FC family; extended temperature range		
FD family		
FJ family; standard temperature range		

COMPONENTS AND MATERIALS (GREEN SERIES)

This series consists of the following parts, issued on the dates indicated.

Part 1 Circuit Blocks, Input/Output Devices

September 1970

Circuit blocks 100kHz Series
Circuit blocks 1-Series
Circuit blocks 10-Series
Circuit blocks 20-Series
Circuit blocks 40-Series
Counter modules 50-Series
Norbits 60-Series, 61-Series

Circuit blocks 90-Series
Circuit blocks for ferrite core
memory drive
Input/output devices

Part 2 Resistors, Capacitors

December 1970

Fixed resistors
Variable resistors
Non-linear resistors
Ceramic capacitors

Polyester, polycarbonate, polystyrene,
paper capacitors
Electrolytic capacitors
Variable capacitors

Part 3 Radio, Audio, Television

January 1970

FM tuners
Coils
Piezoelectric ceramic resonators
and filters
Loudspeakers
Electronic organ assemblies

Television tuners
Components for black and white television
Components for colour television
Deflection assemblies for camera tubes
Audio and mains transformers

Part 4 Magnetic Materials, White Ceramics

March 1970

Ferrites for radio, audio
and television
Ferroxcube potcores and square cores
Microchokes

Ferroxcube transformer cores
Piezoxide
Permanent magnet materials

Part 5 Memory Products, Magnetic Heads, Quartz Crystals, Microwave Devices, Variable Transformers, Electro-mechanical Components

June 1970

Ferrite memory cores
Matrix planes, matrix stacks
Complete memories
Magnetic heads

Quartz crystal units, crystal filters
Isolators, circulators
Variable mains transformers
Electro-mechanical components

Technology relating to the products described in this publication is shared by the following firms.

Argentina

FAPESA I.y.C.
Córdoba 1351-2^o piso
Tel. 41-0084
BUENOS AIRES

Australia

Philips Electrical Pty. Ltd.
Miniwatt Electronics Division
20, Herbert St.
Tel. 43-2171
ARTARMON, N.S.W.

Austria

WIVEG
Prinz Eugenstrasse 32
Tel. 65 16 21
1041 WIEN

Belgium

M.B.L.E.
80, rue des Deux Garcs
tel. 23 00 00
BRUXELLES 7

Brazil

IBRAPE S.A.
Rua Manoel Ramos Paiva 506
Tel. 93-5141
SAO PAULO

Canada

Philips Electron Devices
116 Vanderhoof Ave.
Tel. 425-5161
TORONTO 17, Ontario

Chile

Philips Chilena S.A.
Av. Santa Maria 0760
Tel. 39 40 01
SANTIAGO

Columbia

SADAPE S.A.
Calle 19, No. 5-51, Offs. 302/306
Tel. 422-175
BOGOTA D.E. 1

Denmark

Miniwatt A/S
Emdrupvej 115
Tel. 69 16 22
KØBENHAVN NV

Finland

Oy Philips A.B.
Elcoma Division
Kaivokatu 8
Tel. 10 915
HELSINKI 10

France

R.T.C.
La Radiotechnique-Compelec
Avenue Ledru Rollin 130
Tel. 797-99-30
PARIS 11

Germany

VALVO G.m.b.H.
Valvo Haus
Burchardstrasse 19
Tel. (0411) 33 91 31
2 HAMBURG 1

Greece

Philips S.A. Hellénique
Service Division
54, Av. Syngrou
ATHENES

Hongkong

I.D.C.C. ELCOMA
c/o Philips Hongkong Ltd.
Tel. 24 10 18
HONGKONG

India

INBELEC Div. of
Philips India Ltd.
Band Box Building
254-D, Dr. Annie Besant Road
Tel. 45 33 86, 45 64 20, 45 29 86
Worli, BOMBAY 18 (WB)

Ireland

Philips Electrical (Ireland) Pty.
Newstead, Clonskeagh
Tel. 69 33 55
DUBLIN 6

Italy

Philips S.p.A.
Sezione Elcoma
Piazza IV Novembre 3
Tel. 69.94
MILANO

Japan

I.D.C.C. Ltd.
Kokusai Building, 7th floor
Marunouchi
Tel. (213) 6751.7
TOKYO

Mexico

Electronica S.A. de C.V.
Varsovia 36
Tel. 14-33-29, 25-71-29
MEXICO 6, D.F.

Netherlands

Philips Nederland N.V.
Afd. Elonco
Boschdijk, VB
Tel. (040) 43 33 33
EINDHOVEN

New Zealand

EDAC Ltd.
70-72 Kingsfort Smith Street
Tel. 73-159
WELLINGTON

Norway

Electronica A/S
Middelthungsgate 27
Tel. 46 39 70
OSLO 3

Peru

CADESA
Av. Abancay 1176
Offs. 606-607
Tel. 7 73 17
LIMA

Portugal

Philips Portuguesa S.A.R.L.
Rua Joaquim Antonio de Aguiar 66
Tel. 68 31 21/9
LISBOA

South Africa

EDAC (Pty) Ltd.
South Park Lane
New Doornfontein
Tel. 24-2047
JOHANNESBURG

Spain

COPRESA S.A.
Balmes 22
Tel. 2 32 03 00
BARCELONA 7

Sweden

ELCOMA A.B.
Lidingövägen 50
Tel. 08/67 97 80
Fack STOCKHOLM 27

Switzerland

Philips A.G.
Edenstrasse 20,
Tel. 051/44 22 11
CH-8027 ZUERICH

Turkey

Türk Philips Ticaret A.S.
EMET Department
Gümüşsuyu Cad. 78-80
Tel. 44 74 80
Beyoğlu, ISTANBUL

United Kingdom

Mullard Ltd.
Mullard House
Torrington Place
Tel. 01-580 6633
LONDON W.C. 1

United States

Amperex Electronic Corp.
Electron Tubes Div.
Tel. 516 WE 1-6200
HICKSVILLE N.Y.
Sem. and Microcircuits Div.
Tel. 401-762-9000
SLATERSVILLE R.I. 02876
Electronic Components Div.
Tel. 516-234-7000
HAUPTPAGE N.Y.

Venezuela

C.A. Philips Venezolana
Elcoma Department
Colinas de Bello Monte
Tel. 72.01.51
CARACAS

Fixed resistors



STATE OF TEXAS

1846
1847
1848
1849
1850
1851
1852

INTRODUCTION

Two basic versions of film resistors are available, namely carbon film resistors and metal film resistors.

Carbon film resistors are used if moderate demands are made on stability, temperature coefficient and tolerance. To meet higher demands on one or more of these parameters metal-film resistors are used.

The specification of these resistors is based primarily on I.E.C. publication 115, "Recommendations for fixed non-wire-wound resistors type 1 for use in electronic equipment".

A different way of specifying power ratings has been adopted, however, to give the circuit designer better guidance in selecting the proper resistor for a given application.

Before going into detail on this point some remarks have to be made about the basic behaviour of film resistors.

BASIC BEHAVIOUR

Power dissipation in a resistor causes the temperature of the resistor body to increase. The temperature rise is determined by the laws of heat conduction, convection and radiation and will be maximum at the so-called hot spot (usually the middle of the resistor body).

Theoretically in the temperature range where radiation plays only a minor part - and this is the normal temperature range of film resistors - the maximum temperature rise ΔT is proportional to the power dissipated: $\Delta T = A.P.$; experiments confirm this.

The proportionality constant A gives the temperature rise at the hot spot per watt of dissipated power and can be interpreted as a heat resistance with dimensions deg C/W. This heat resistance is a function of the dimensions of the resistor, the heat conductivity of the materials used and, to a lesser degree, of the way of mounting.

The sum of the temperature increase and the ambient temperature T_{amb} is the maximum temperature (hot spot temperature) of the resistor.

$$T_m = T_{amb} + \Delta T$$

The stability of a film resistor under endurance tests is mainly determined by the hot spot temperature and the resistance value. The lower the resistance value with the other conditions kept constant the higher the stability due to the greater film thickness for these lower resistance values.

The above relations can be summarised schematically in the following way:

dimensions determine	=	heat resistance
heat resistance x dissipation	=	temperature rise
temperature rise + ambient temperature	=	hot spot temperature
hot spot temperature and resistance value determine	=	stability

NEW WAY OF SPECIFYING THE PERFORMANCE

Formerly a resistor was characterised by a wattage rating hardly any attention being paid to the above mentioned relations apart from giving a derating line.

In the adopted system the relation between the several variables is given for a certain heat resistance, or, in other words, for certain resistor dimensions; the materials used and the test mounting are in general the same for different resistor types. The resistor is thus characterised by its dimensions.

The dissipation is given as a function of the hot spot temperature with the ambient temperature as a parameter.

From $\Delta T = A \cdot P$ and $T_m = T_{amb} + \Delta T$ it follows that:

$$P = \frac{T_m - T_{amb}}{A}$$

If P is plotted against T_m for a constant value of A , parallel straight lines are obtained for different values of the ambient temperature. The slope of these lines, $\frac{dP}{dT_m} = \frac{1}{A}$, is the reciprocal of the heat resistance and is characteristic for the resistor.

The stability $\frac{\Delta R}{R}$ can be determined experimentally, for instance after 1000 hrs, as a function of the hot spot temperature with the resistance value as a parameter. It has been found that the resistance changes exponentially with temperature, giving a straight line when $\log \frac{\Delta R}{R}$ is plotted against T_m .

A combination of the graphs of P and $\frac{\Delta R}{R}$ against T_m gives a nomogram from which the values of several variables can be determined for a resistor of a given size under different working conditions. An example of such a nomogram with fictitious values is given in Fig.1. The intersection of the dash-dot line with the horizontal axis gives the hot spot temperature under the chosen conditions.

Example 1

Assume that a 10 k Ω resistor whose characteristics are described by the nomogram is to be operated at a power dissipation of 0.4 W and an ambient temperature of 60 $^{\circ}\text{C}$. To find out whether this dissipation is allowable at this ambient temperature and, if so, what the expected stability of the resistor will be, draw in the upper half of the nomogram a horizontal line through A (power dissipation of 0.4 W). This line intersects the 60 $^{\circ}\text{C}$ ambient temperature line at point B, corresponding to a hot spot temperature of 128 $^{\circ}\text{C}$ (point C). This is safely below the maximum indicated by the dashed line at 155 $^{\circ}\text{C}$; therefore a dissipation of 0.4 W at an ambient temperature of 60 $^{\circ}\text{C}$ is well within the allowable limit.

1947
3POT212 49

1947
3POT212 49

CARBON FILM RESISTORS

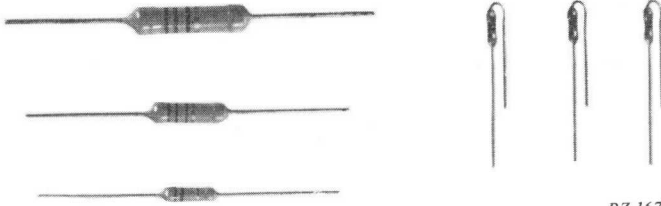

RZ 16737-1

QUICK REFERENCE DATA

Resistance ranges	from 1 Ω to 22 M Ω ; E12 or E24 series
Resistance tolerance	1, 2, 5, 10 %
T _{max} hot spot	155 °C
Typ. dissipation at T _{amb} = 70 °C *)	CR16 = 0.2 W, CR52 = 0.67 W CR25 = 0.33 W, CR68 = 1.15 W CR37 = 0.5 W, CR93 = 2 W
Basic specification	I. E. C. publication 115
Category	55/155/56
Stability after: load	see nomogram
climatic tests	ΔR max. 1.5 % for R \leq 220 k Ω max. 3 % for R > 220 k Ω
soldering	ΔR max. 0.5 % or 0.5 Ω
short time overload	ΔR max. 1 %

*)Dissipation at T_{amb} = 70 °C which causes the maximum permissible hot-spot temperature of 155 °C to occur, irrespective of the resistance drift provoked by this condition.

APPLICATION

In a great variety of electronic circuits, from hearing aids to computers, from telecommunication equipment to portable radios.

DESCRIPTION

On a high grade ceramic body a homogeneous film of pure carbon is deposited by pyrolysis of a hydrocarbon gas *). Contact caps of special alloy are then pressed onto the ends of the resistor body, and next tinned electrolytic copper connecting wires are welded to these caps.

As a rule the required resistance value is not obtained by pyrolysis only; helixing, that is, cutting a helical groove in the carbon film is necessary, in which the desired resistance value is arrived at by regulating the pitch of the helix.

The thinner the carbon layer and the finer the pitch of the helix, the higher the resistance value.

Finally the resistors are coated with three or more layers of a special lacquer for electrical and climatical protection.

MECHANICAL DATA

Dimensions in mm

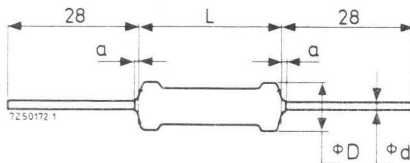

Fig. 1a

style	D _{max}	L _{max}	a _{max}	d
CR16	1.6	4.5	1.0	0.4
CR25	2.5	7.5	1.0	0.6
CR37	3.7	10	1.0	0.7
CR52	5.2	18	1.2	0.8
CR68	6.8	18	1.2	0.8
CR93 (5%)**	9.3	32	1.2	0.8
CR93 (1%)	9.3	38.5	3.2	1

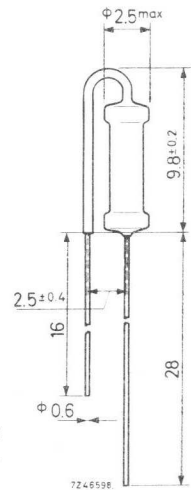

Fig. 1b. Style CR25A

The bent lead is partly covered with an insulating lacquer having a breakdown voltage of at least 50 V_{dc}.

*) Resistors with resistance values lower than 10 ohms have an electroless nickel film instead of a carbon film. The further processing, however, is the same.

**) Lead length 36 mm

The length of the body is measured by inserting the leads into the holes of two identical gauge plates and by moving these plates parallel to each other until the resistor body is clamped without deformation (see I.E.C. publication: Measurement of the dimensions of a cylindrical component having two axial terminations).

nominal lead diameter (mm)	width of hole in gauge plate (mm)
0.4	0.8
0.6/0.7	1.0
0.8	1.2

Weights (per 100 pcs)

CR16	8 g	CR52	96 g
CR25	23 g	CR68	148 g
CR37	42 g	CR93 (5%)	552 g
		CR93 (1%)	650 g

Mounting

The resistors must be mounted stress free so as to allow thermal expansion over the wide permissible temperature range.

Marking

The nominal resistance value and the tolerance are marked on the resistors by means of four coloured bands according to I.E.C. publication 62: "Colour code for fixed resistors"

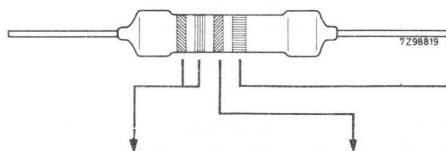

colour	significant figures	multiplier	tolerance
black	0	1 x	
brown	1	10 x	± 1%
red	2	100 x	± 2%
orange	3	1 000 x	
yellow	4	10 000 x	
green	5	100 000 x	
blue	6	1 000 000 x	
violet	7	-	
grey	8	-	
white	9	-	
silver		-	± 10%
gold		0.1 x	± 5%

ELECTRICAL DATA

style	limiting voltage $V_{rms}^{1)}$	resistance range	tolerance \pm	series 2)	catalog number
CR16	150	10 Ω - 220 k Ω	5%	E24	2322 210 03...
		270 k Ω - 1 M Ω	10%	E12	2322 210 02...
CR25	250	1 Ω - 1 M Ω	5%	E24	2322 101 33...
		10 Ω - 220 k Ω	2%	E24	2322 101 34...
		1.2 M Ω - 10 M Ω	10%	E12	2322 101 32...
CR25A	250	1 Ω - 1 M Ω	5%	E24	2322 106 33...
		10 Ω - 220 k Ω	2%	E24	2322 106 34...
		1.2 M Ω - 10 M Ω	10%	E12	2322 106 32...
CR37	350	1 Ω - 1 M Ω	5%	E24	2322 212 13...
		10 Ω - 1 M Ω	2%	E24	2322 212 14...
		10 Ω - 1 M Ω	1%	E24	2322 222 0..0.
		1.2 M Ω - 10 M Ω	10%	E12	2322 212 12...
CR52	500	1 Ω - 1 M Ω	5%	E24	2322 101 63...
		10 Ω - 1 M Ω	1%	E24	2322 223 8..0.
		1.2 M Ω - 22 M Ω	10%	E12	2322 101 62...
CR68	750	1 Ω - 1.6 M Ω	5%	E24	2322 214 13...
		10 Ω - 1.6 M Ω	1%	E24	2322 224 0..0.
		1.8 M Ω - 22 M Ω	10%	E12	2322 214 12...
CR93	1000	10 Ω - 22 M Ω	5%	E24	2322 215 13...
		10 Ω - 1.6 M Ω	1%	E24	2322 225 8..0.

Composition of the catalog number

In the above mentioned catalog number replace the first two dots by the first two digits of the resistance value. Replace the third dot by a figure according to the following table:

1 - 9.1 Ω	8	10 - 91 k Ω	3
10 - 91 Ω	9	100 - 910 k Ω	4
100 - 910 Ω	1	1 - 9.1 M Ω	5
1 - 9.1 k Ω	2	10 - 22 M Ω	6

1) Limiting voltage (element and insulation)

This is the maximum voltage which may be applied continuously to the resistor element (see I. E. C. publication 115 clause 1.3.5.). This voltage is also the maximum voltage which may be applied continuously to the insulation of the resistor.

2) See the table "Standard series of values in a decade" at the back of this book.

Remarks to nomogram

1. The nomogram should not be extended beyond the maximum allowable hot spot temperature of 155 °C.
2. The resistance change given by the nomogram for $P = 0$ at a particular ambient temperature is indicative of the shelf life stability of a resistor at that temperature.
3. The stability lines do not give exact values for $\Delta R/R$, but represent a probability of 95% that the real values will be smaller than those obtained from the nomogram.
4. In the nomogram the limiting voltage of the resistors has not been taken into consideration.
5. I. E. C. publication 115 is still based on the conventional method of rating resistors by a fixed "rated dissipation" at 70 °C requiring at that dissipation a fixed maximum permissible drift.

In our new specification, however, the rated dissipation is no longer specified and also the guaranteed resistance drift is made dependant on the working conditions. To bridge the gap between the system of I. E. C. 115 and our new system, Fig.3 is added. In this figure the permissible dissipation at 70 °C for a resistance drift of max. 1.5% after 1000 hours is given, taking into consideration that the hot spot temperature should not rise above 155 °C (horizontal part of the curves). In our specification the curves of Fig.3 replace the rated dissipation.

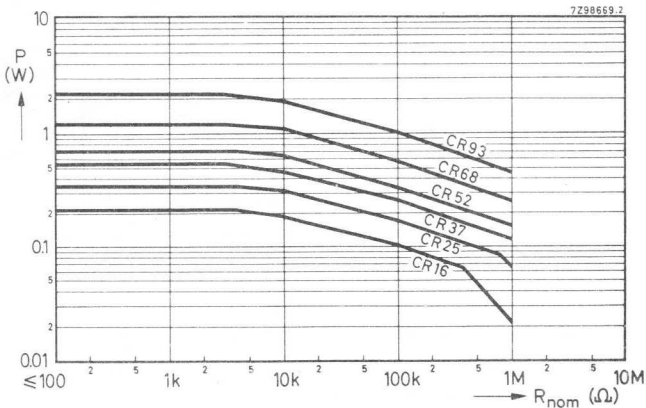

Fig.3. Maximum permissible dissipation at $T_{amb} = 70\text{ °C}$ as a function of the resistance value for a resistance drift of 1.5% after 1000 hours or for a maximum temperature of 155 °C without reaching the resistance drift of 1.5%, limiting voltage being taken into account.

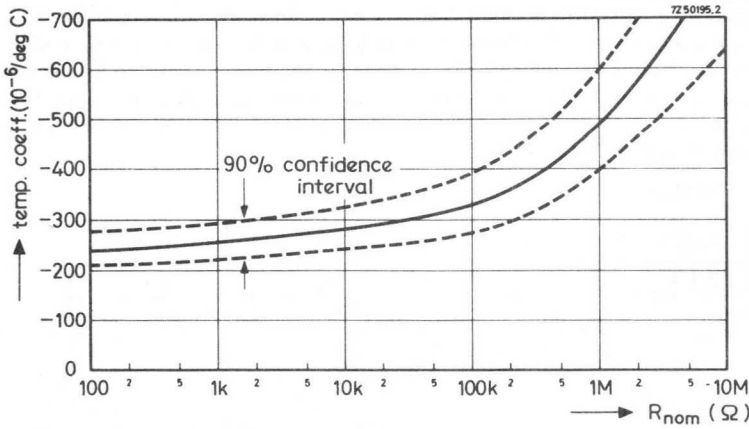

Fig. 4. Temperature coefficient as a function of the resistance value, applicable to all resistor styles.

For values $< 10 \Omega$ the temperature coefficient is $\leq +200 \times 10^{-6}/\text{deg C}$.

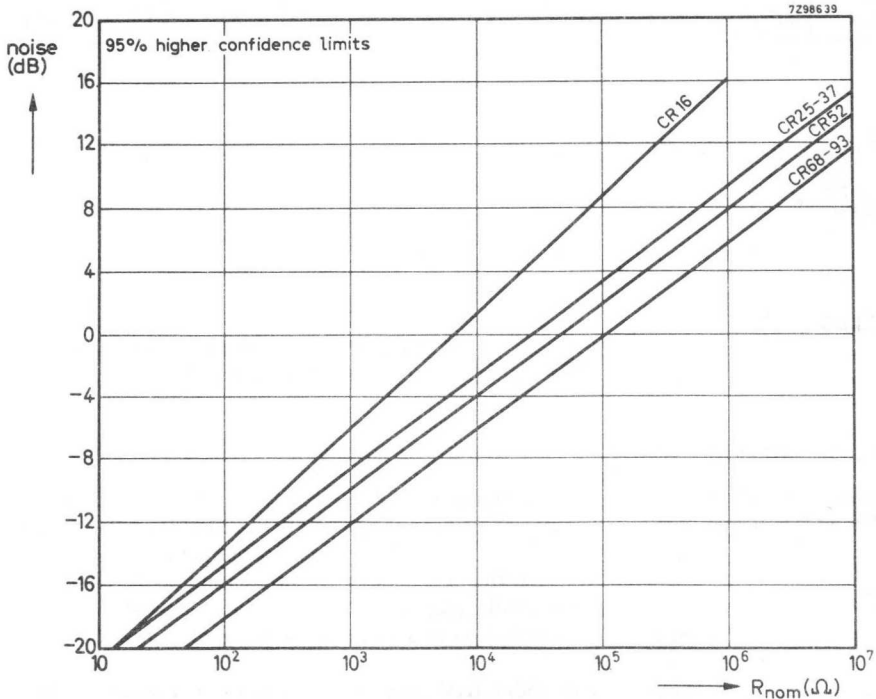

Fig. 5. Noise as a function of the resistance value.

High frequency behaviour

The behaviour of a resistor at high frequencies is influenced not only by its construction but also by external factors such as length of leads, environmental stray capacitances and the measuring apparatus. Thus, these factors have to be considered when measuring. The following table gives typical values under test conditions at 250 MHz using the measuring arrangement shown below. An RX-meter type 250 A of Boonton Radio Corporation is used.

Frequency: 250 MHz

R _{nom} (Ω)	CR16		CR25		CR37		CR52		CR68		CR93	
	$\frac{ Z }{R_{nom}}$	φ°	$\frac{ Z }{R_{nom}}$	φ°	$\frac{ Z }{R_{nom}}$	φ°	$\frac{ Z }{R_{nom}}$	φ°	$\frac{ Z }{R_{nom}}$	φ°	$\frac{ Z }{R_{nom}}$	φ°
10	3.47	70	2.97	70	2.35	61	2.26	61	2.46	63	3.95	71
22	1.72	52	1.61	51	1.43	45	1.40	46	1.37	43	2.42	60
56	1.11	31	1.07	28	1.02	26	1.08	27	1.07	25	1.54	34
100	1.03	23	1.02	22	1.02	17	1.01	18	1.09	20	1.40	32
220	0.99	10	0.99	9	1	6	0.98	4	1	4	0.98	5
560	0.98	0	0.97	-5	0.94	-16	0.97	-5	0.90	-18	0.83	-31
1000	0.96	-9	0.92	-15	0.88	-25	0.86	-24	0.79	-31	0.48	-56
2200	0.84	-32	0.82	-35	0.69	-47	0.64	-50	0.49	-59	0.25	-71
5600	0.50	-60	0.41	-66	0.35	-69	0.31	-72	0.22	-77	0.10	-83

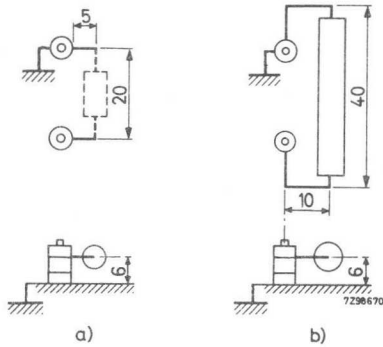

Measuring arrangement: (a) for CR16 to CR68, (b) for CR93

TESTS AND REQUIREMENTS

Essentially all tests mentioned in the schedule of I.E.C. publication 115, category 55/155/56 (rated temperature range -55 to +155 °C; damp heat, long term, 56 days) are carried out along the lines of I.E.C. publication 68. "Recommended basic climatic and mechanical robustness testing procedure for electronic components". In the table below the tests are listed with reference to the relevant clauses of I.E.C. publications 115 and 68; a short description is also given of the test procedure and requirements.

In some instances deviations from the I.E.C. specification were necessary for the new method of specifying.

IEC 115 clause	IEC 68 test method	Test	Procedure	Requirements
2.6.1	B II	<u>Climatic sequence</u>	16 hours 155 °C	
2.6.2	D IV	<u>Dry heat</u>	1 day; 55 °C; 95 - 100% R.H.	
2.6.3	A IV	<u>Damp heat (accel) 1st cycle</u>	2 hours; -55 °C	
2.6.4	M IV	<u>Cold</u>	1 hour; 85 mbar; 15 - 35 °C	
2.6.5	D IV	<u>Low air pressure</u>	5 days; 55 °C; 95 - 100% R.H.	R _{ins} = min. 1000 MΩ, ΔR max. 1.5% for R ≤ 220 kΩ max. 3% for R > 220 kΩ
2.6.6.2	-	<u>Damp heat (accel) re-maining cycles</u>	24 hours; room temp.; dissipation taken from Fig. 3	ΔR as above
2.7	C IV	<u>Load (d.c.)</u>	56 days; 40 °C; 90-95% R.H.; 5V _{dc} on half the number of specimens, but the dissipation should not exceed 1% of the value indicated by Fig. 3.	R _{ins} : min. 1000 MΩ ΔR max.: 1.5% for R ≤ 220 kΩ max.: 3% for R > 220 kΩ
2.7.5	-	<u>Load (d.c.)</u>	24 hours; room temp.; dissipation taken from Fig. 3	ΔR as above

CARBON FILM RESISTORS

CR16 CR25 CR37
CR52 CR68 CR93

IEC 115 clause	IEC 68 test method	Test	Procedure	Requirements
2.9	-	<u>Endurance</u>	1000 hours; 70 °C; dissipation taken from Fig. 3	ΔR max.: 1.5%
2.4.3	-	<u>Temperature coefficient</u>	between -55 °C and +155 °C	see Fig. 4
2.4.5	-	<u>Voltage proof on insulation</u>	2 x limiting voltage, a. c., 1 min.; for CR68 and CR93 $\sqrt{2}$ x limiting voltage, a. c., 1 min.	no breakdown
2.4.6	-	<u>Noise</u>	IEC publication 195	see Fig. 5
2.4.2	-	<u>Insulation resistance</u>	-	min. 10^4 M Ω
-	-	<u>Short time overload</u>	room temperature, dissipation 6.25 x value taken from Fig. 3 (voltage not more than 2 x limiting voltage) 10 cycles 5 s on, 45 s off	ΔR max. 1%
-	-	<u>Voltage coefficient</u>	-	< 5 ppm



STANDARD PACKAGING

Resistors with a tolerance of 2,5 and 10%

Style CR16	bulk packing	100 per box
CR25	tape packing	1000 per box
CR25A	bulk packing	1000 per box
CR37	tape packing	1000 per box
CR52	tape packing	1000 per box
CR68	tape packing	1000 per box
CR93	tape packing	250 per box

Configuration of tape (dimensions in mm)

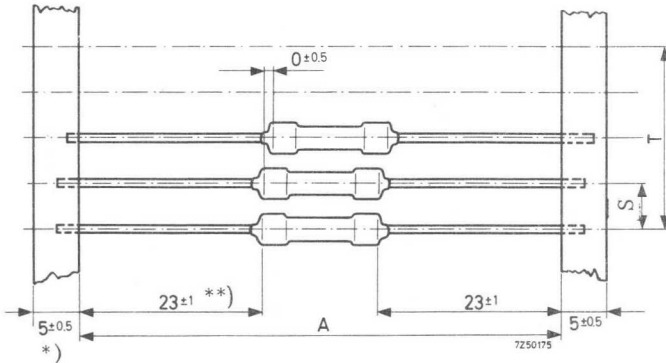

style	A	S	T for number (n) of resistors	
			n < 50	50 < n < 100
CR25	53 ± 2	5 ± 0.3	$5(n-1) \pm 2$	$5(n-1) \pm 4$
CR37	56 ± 2	5 ± 0.3	$5(n-1) \pm 2$	$5(n-1) \pm 4$
CR52	64 ± 2	10 ± 0.3	$10(n-1) \pm 2$	$10(n-1) \pm 4$
CR68	64 ± 2	10 ± 0.3	$10(n-1) \pm 2$	$10(n-1) \pm 4$
CR93	92 ± 2	10 ± 0.3	$10(n-1) \pm 2$	$10(n-1) \pm 4$

*) for CR93: 6 ± 0.3

***) for CR93: 30.5 ± 1

METAL FILM RESISTORS

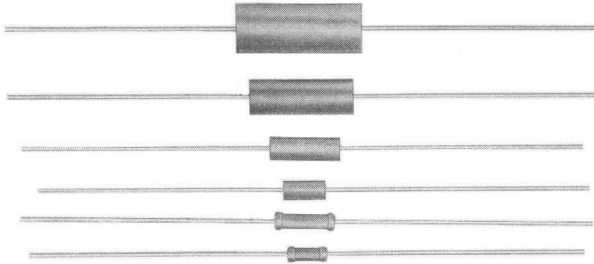

RZ 24108-1

QUICK REFERENCE DATA

Resistance ranges	from 4.99 Ω to 1 M Ω E24, E96, E192 series
Resistance tolerance	2, 1, 0.5, 0.25, 0.1 %
T _{max} hot spot	175 °C
Typical dissipation at T _{amb} = 70 °C *)	MR25 0.4 W MR30 0.5 W MR31 0.5 W MR39 0.65 W MR58 0.85 W MR81 1.3 W
Basic specification	I.E.C. 115, type 1C
lacquered resistors	MIL R 10509F
moulded resistors	
Category	55/175/56
Stability after:	
load	see nomogram
climatic tests	R max. 0.5% + 0.05 Ω
soldering	R max. 0.1% or 0.1 Ω
short time overload	R max. 0.25% + 0.05 Ω

*) This is the dissipation at T_{amb} = 70 °C which causes the max permissible hot-spot temperature of 175 °C to occur, irrespective of the resistance drift provoked by this condition.

APPLICATION

These resistors have been developed for applications in which precision, stability, and a low temperature coefficient are required, e.g. in computers, telecommunication equipment, measuring apparatus, etc.

DESCRIPTION

A homogeneous film of nickel-chromium ¹⁾ is vacuum deposited on a high grade ceramic body. Contact caps of special alloy are then pressed onto the ends of the resistor body, and next the tinned electrolytic copper connecting wires are welded to the caps.

As a rule the required resistance value is not obtained directly by deposition of the film; helixing, that is, cutting a helical groove in the metal film, is also needed.

The range of lacquered resistors is produced by coating the finished body with four or more layers of a special lacquer, the range of moulded resistors by moulding in a suitable thermo-setting resin. In both cases the resistors are fully protected against the commonly used cleaning solvents.

MECHANICAL DATA

Dimensions in mm

Fig.1

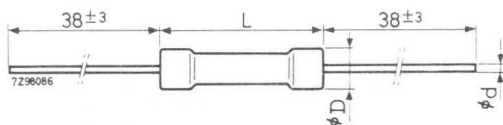

Fig.2

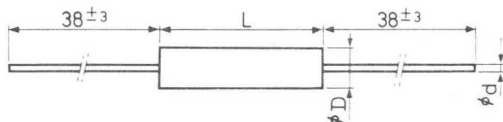

Table I

	style	Fig	D _{max}	L _{max}	d
lacquered	MR25	1	2.5	7.0	0.6
	MR30	1	3.0	10.0	0.6
moulded	MR31	2	3.1	7.0	0.6
	MR39	2	3.9	11.1	0.6
	MR58	2	5.8	16.6	0.6
	MR81	2	8.1	20.6	0.8

¹⁾ Resistors with the lowest resistance values may have an electroless nickel film instead of a vacuum deposited nickel-chromium film. The further processing, however, is the same.

The length of the body is measured by inserting the leads into the holes of two identical gauge plates and by moving these plates parallel to each other until the resistor body is clamped without deformation. (See I.E.C. publication "Measurement of the dimensions of a cylindrical component having two axial terminations").

nominal lead diameter (mm)	width of hole in gauge plate (mm)
0.6	1.0
0.8	1.2

Weight (per 100 pcs)

MR25	25 g	MR31	30 g	MR58	123 g
MR30	32 g	MR39	47 g	MR81	284 g

Mounting

The resistors must be mounted stress free so as to allow thermal expansion over the wide permissible temperature range.

Marking

a. Lacquered resistors

The nominal resistance value and the tolerance are marked on these resistors by means of four or five coloured bands according to I.E.C. publication 62 "Colour code for fixed resistors" (see also I.E.C. publication 115 clause 1.5).

for E96 and
E192 series

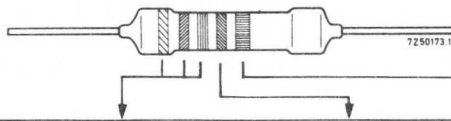

colour	significant figures	multiplier	tolerance
black	0	1 x	
brown	1	10 x	± 1%
red	2	100 x	± 2%
orange	3	1 000 x	
yellow	4	10 000 x	
green	5	100 000 x	
blue	6	1 000 000 x	
violet	7	-	
grey	8	-	
white	9	-	
silver		0.01 x	
gold		0.1 x	

for E24 series

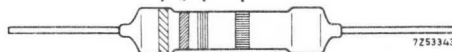

b. Moulded resistors

Moulded resistors are marked according to the MIL specification MIL-R-10509F with additional marking of the value and tolerance in I.E.C. code (see I.E.C. publication 63). This means that the following information is printed on the resistor:

- MIL style
- Value and tolerance in MIL code
- Manufacturers' identification symbol

In the MIL code for value and tolerance the value is indicated by four figures and a letter: first the three significant figures according to the E192 or E96 series, a fourth figure indicating the number of zeros to follow and then a letter indicating the tolerance as follows:

$$B = \pm 0.1\%; C = \pm 0.25\%; D = \pm 0.5\% \text{ and } F = \pm 1\%.$$

Example: $22.1 \text{ k}\Omega \pm 1\%$ is written as 2212 F

ELECTRICAL DATA

Standard values of rated resistance and tolerance

Standard values of rated resistance (nominal resistance) are taken from the E24 series for resistors with a tolerance of $\pm 2\%$, from the E96 series for resistors with a tolerance of $\pm 1\%$, from the E192 series for resistors with a tolerance of $\pm 0.5\%$, $\pm 0.25\%$ or $\pm 0.1\%$ (I.E.C.63, also MIL-R-10509F para 1.2.1.3). Resistors with a tolerance of $\pm 0.1\%$ and 0.25% may also be requested with resistance values deviating from the E192 series, provided the value can be indicated with no more than three significant figures.

The values of the E96 and E192 series are given in a table at the back of this book.

Standard range

Table II

style	maximum temp. coeff. (10 ⁻⁶ /deg C)	resistance range	tolerance ± %	series 1)	cat. number 2322 followed by	limiting voltage**) (V)
MR25	+100	4.99 Ω - 100 kΩ	1	E 96	151 5....	250
MR25	+100	5.1 Ω - 100 kΩ	2	E 24	151 4....	250
MR30	+100	4.99 Ω - 301 kΩ	1	E 96	152 5....	350
MR30	+100	5.1 Ω - 300 kΩ	2	E 24	152 4....	350
MR31E	+ 25	49.9 Ω - 100 kΩ	0.1/0.25/0.5/1	E192*	123	250
MR31C	+ 50	49.9 Ω - 100 kΩ	0.1/0.25/0.5/1	E192*	124	250
MR31D	+100	4.99 Ω - 100 kΩ	1	E 96	125 5....	250
MR39E	+ 25	49.9 Ω - 499 kΩ	0.1/0.25/0.5/1	E192*	126	350
MR39C	+ 50	49.9 Ω - 499 kΩ	0.1/0.25/0.5/1	E192*	127	350
MR39D	+100	4.99 Ω - 301 kΩ	1	E 96	128 5....	350
MR58E	+ 25	49.9 Ω - 1 MΩ	0.1/0.25/0.5/1	E192*	129	500
MR58C	+ 50	49.9 Ω - 1 MΩ	0.1/0.25/0.5/1	E192*	130	500
MR58D	+100	4.99 Ω - 681 kΩ	1	E 96	131 5....	500
MR81E	+ 25	24.9 Ω - 1 MΩ	0.1/0.25/0.5/1	E192*	132	750
MR81C	+ 50	24.9 Ω - 1 MΩ	0.1/0.25/0.5/1	E192*	133	750
MR81D	+100	4.99 Ω - 1 MΩ	1	E 96	134 5....	750

*) For 1% tolerance E96 values only.

**) Limiting voltage (element and insulation).

This is the maximum voltage which may be applied continuously to the resistor element (see I.E.C. publication 115 clause 1.3.5). This voltage is also the maximum voltage which may be applied continuously to the insulation of the resistor.

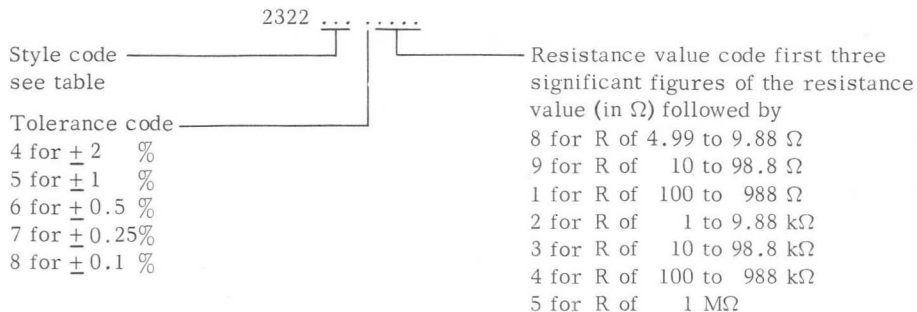
Composition of the catalog number

1) See the table "Standard series of values in a decade" at the back of this book.

Dissipation

The moulded range is designed to meet the military specification MIL-R-10509F and consequently in Table III a nominal dissipation has been stated. This however does not constitute a real limitation for non-military applications, as the resistors may be used at a higher dissipation.

The stability as a function of dissipation and ambient temperature is indicated in the performance nomogram of Fig. 3. The nomogram applies also to lacquered resistors, which are not identified by any nominal dissipation but by style number only.

Remarks to nomogram

The nomogram should not be extended beyond the maximum allowable hot spot temperature of 175 °C.

The resistance change given by the nomogram for $P=0$ at a particular ambient temperature is indicative of the shelf life stability of a resistor at that temperature.

The stability lines do not give exact values $\Delta R/R$, but represent a probability of 95% that the real values will be smaller than those obtained from the nomogram.

In the nomogram the limiting voltage of the resistors has not been taken into consideration.

CONFORMITY WITH MIL-R-10509F STYLES

Table III

style	MIL-R-10509F		max. voltage (V)
	style	dissipation	
MR31E	RN55E	0.1 W at 125 °C	200
MR31C	RN55C	0.1 W at 125 °C	200
MR31D	RN55D	1/8 W at 70 °C	200
MR39E	RN60E	1/8 W at 125 °C	250
MR39C	RN60C	1/8 W at 125 °C	250
MR39D	RN60D	1/4 W at 70 °C	300
MR58E	RN65E	1/4 W at 125 °C	300
MR58C	RN65C	1/4 W at 125 °C	300
MR58D	RN65D	1/2 W at 70 °C	350
MR81E	RN70E	1/2 W at 125 °C	350
MR81C	RN70C	1/2 W at 125 °C	350
MR81D	RN70D	3/4 W at 70 °C	500

TESTS AND REQUIREMENTS

Lacquered resistors

Essentially all tests are carried out according to the schedule of I.E.C. publication 115, clause 2.1.3 for severity 424. This means: rated temperature range -55 to $+155$ °C; damp heat (long term) 56 days. (See I.E.C. publication 115, clause 1.4). The tests are carried out along the lines of I.E.C. publication 68. "Recommended basic climatic and mechanical robustness testing procedure for electronic components".

In table V the tests and requirements are listed with reference to the relevant clauses of I.E.C. publications 115 and 68; a short description of the test procedure is also given. In some instances deviations from the I.E.C. specifications were necessary for the new method of specifying.

Moulded resistors

All tests are carried out according to the schedule of MIL-R-10509F para. 4.4.2. In the table below the tests and requirements are listed with reference to the relevant paragraphs of this specification.

Table IV

MIL method			requirement	
R 10509F paragraph	STD 202 method	procedure	MIL-R-10509F paragraph	requirement 1)
4.6.4	102	Temperature cycling	3.9	$\Delta R \leq 0.25\% + 0.05 \Omega$
4.6.5	-	Low-temperature operation	3.10	$\Delta R \leq 0.25\% + 0.05 \Omega$
4.6.6	-	Short-time overload	3.11	$\Delta R \leq 0.25\% + 0.05 \Omega$
4.6.7	211	Terminal strength	3.12	$\Delta R \leq 0.2\% + 0.05 \Omega$
4.6.8	301/105	Dielectric withstanding voltage	3.13	$\Delta R \leq 0.25\% + 0.05 \Omega$
4.6.9	302	Insulation resistance	3.14	$R_{ins} \geq 10\,000 \text{ M}\Omega$
4.6.10	210	Resistance to soldering heat	3.15	$\Delta R \leq 0.1\% + 0.05 \Omega$
4.6.11	106	Moisture resistance	3.16	$\Delta R \leq 0.5\% + 0.05 \Omega$ $R_{ins} \geq 100 \text{ M}\Omega$
4.6.13	108	Life	3.18	$\Delta R \leq 0.5\% + 0.05 \Omega$
4.6.15	205	Shock, medium impact	3.20	$\Delta R \leq 0.25\% + 0.05 \Omega$
4.6.16	204	Vibration	3.21	$\Delta R \leq 0.25\% + 0.05 \Omega$

1) Though our resistors with a temperature coefficient of $100 \cdot 10^{-6} / \text{deg C}$ correspond with characteristic D resistors of MIL-R-10509F, they meet the more severe test requirements of characteristic C and E resistors.

Table V

IEC 115 clause	IEC 68 test method	Test	Procedure	Requirements
2.5.1		<u>Robustness of terminations</u> a. Tensile all samples b. Bending half number of samples c. Torsion other half number of samples	<p>dia < 0.5 mm : load 5 N (0.5 kg) ; 10 s 0.5 mm < dia ≤ 0.8 mm : load 10 N (1 kg) ; 10 s dia > 0.8 mm : load 20 N (2 kg) ; 10 s</p> <p>dia < 0.5 mm : load 2.5 N (0.25 kg); 4x90° 0.5 mm < dia ≤ 0.8 mm : load 5 N (0.5 kg) ; 4x90° dia > 0.8 mm : load 10 N (1 kg) ; 4x90°</p> <p>2x360° in opposite directions</p>	no damage
2.5.2	T.2	<u>Soldering</u>	<p>solderability: 2 s 230 °C (class II)</p> <p>thermal shock: 3 s 350 °C, 6 mm from body</p> <p>3 hours -55 °C/3 hours +155 °C, 5 cycles</p>	<p>ΔR max. 0.1% or 0.1 Ω</p> <p>good tinning, no damage, ΔR max. 0.1% or 0.1 Ω</p> <p>ΔR max. 0.1% or 0.1 Ω</p>
2.5.3	FB IV	<u>Vibration</u>	<p>frequency: 10-500 Hz; displacement 1.5 mm or acceleration 10 g; three directions: total 9 h</p> <p>3x1500 bumps in three direction; 50 g</p>	<p>no damage, ΔR max. 0.1% or 0.1 Ω</p> <p>no damage, ΔR max. 0.1% or 0.1 Ω</p>
-	-	<u>Bumping</u>		<p>no damage, ΔR max. 0.1% or 0.1 Ω</p>

Table V (continued)

IEC 115 clause	IEC 68 test method	Test	Procedure	Requirements
2.6.1	B II	<u>Climatic sequence</u>	16 hours 155 °C	
2.6.2	D IV	<u>Dry heat</u> <u>Damp heat (accel)</u> <u>1st cycle</u>	1 day: 55 °C ; 95-100% R.H. 2 hours; -55 °C	
2.6.3	A IV	<u>Cold</u>	1 hour; 85 mbar; 15-35 °C	
2.6.4	M IV	<u>Low air pressure</u>		
2.6.5	D IV	<u>Damp heat (accel) re-maining cycles</u>	5 days; 55 °C; 95-100% R.H.	$R_{ins} = \text{min. } 1000 \text{ M}\Omega$, $\Delta R \text{ max. } 0.5\% + 0.05 \Omega$
2.6.6.2	-	<u>Load</u>	24 hours; room temp.; dissipation { 0.25 W for MR25 0.3 W for MR30	ΔR as above
2.7	C IV	<u>Damp heat (longterm exposure)</u>	56 days; 40 °C; 90-95% R.H.; 5 V _{dc} on half the number of specimens, but the dissipation should not exceed 2.5 mW for MR25 and 3.0 mW for MR30	R_{ins} : min. 1000 MΩ ΔR max.: 0.5% + 0.05 Ω
2.7.5	-	<u>Load</u>	24 hours; room temp.; dissipation 0.25 W for MR25 and 0.30 W for MR30	ΔR as above



Table V (continued)

IEC 115 clause	IEC 68 test method	Test	Procedure	Requirements
2.9	-	<u>Endurance</u>	1000 hours; 70 °C; dissipation 0.25 W for MR25 0.3 W for MR30	ΔR max.: see Fig. 3
2.4.3	-	<u>Temperature coefficient</u>	between -55 °C and +155 °C	$\leq 100 \cdot 10^{-6}/\text{deg C}$
2.4.5	-	<u>Voltage proof</u>	2 x limiting voltage with d.c. voltage and with a maximum of 1500 V _{dc}	no breakdown
2.4.6	-	<u>Noise</u>	IEC publication 195	$\leq 0.25 \mu\text{V/V}$
2.4.2	-	<u>Insulation resistance</u>	-	min. $10^4 \text{ M}\Omega$

STANDARD PACKAGING

The styles MR25 and MR30 are supplied on tape.

Configuration of tape (dimensions in mm)

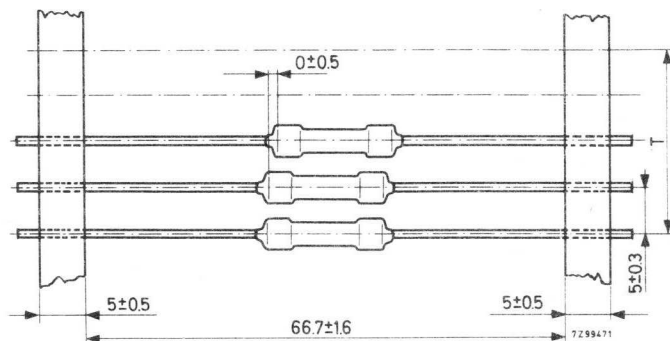

T: for $n \leq 50$
for $50 > n \leq 100$

$5(n-1) \pm 2$
 $5(n-1) \pm 4$

16981 61 300 1

INSULATED PIN-HEAD CARBON RESISTORS

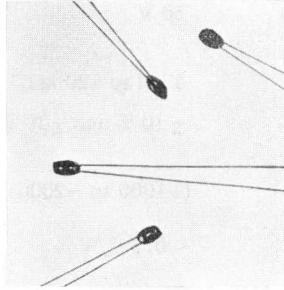

RZ 15568-5

Max. dissipation at 70 °C	0.05 W
Resistance values	47 Ω to 120 kΩ, E12 series
Tolerance	± 10 % and ± 20 %
Noise	< 10 μV/V

APPLICATION

In hearing aids, small-distance communication sets, weather radio probes.

CONSTRUCTION

The resistors consist of a pellet of carbon composition between the parallel connection leads. The pellet is coated with synthetic resin.

Dimensions in mm

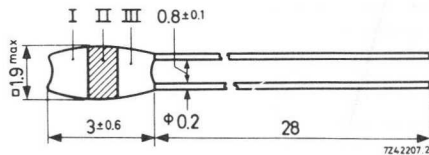

Colour code, for resistance values in Ω;

colour	band I, first digit	band II, second digit	band III, multi- plier
black	-	0	x 1
brown	1	1	x 10
red	2	2	x 100
orange	3	3	x 1000
yellow	4	4	x 10 000
green	5	5	
blue	6	6	
violet	7	7	
grey	8	8	
white	9	9	

Mounting

Do not solder or bend the leads less than 0.5 mm from the resistor body.

TECHNICAL PERFORMANCE

For tests and measuring methods see IEC publications 109 and 115

Max. dissipation at 70 °C (= P _{nom})	0.05 W
at other temperatures	see respective graph
Limiting voltage, peak value	50 V
Resistance values, measured at P ≤ 0.1 P _{nom}	47 Ω to 120 kΩ, E12 series ¹⁾
Tolerances	± 10 % and ± 20 %
Temperature coefficient (from +25 to +70 °C)	(+1000 to -2000) 10 ⁻⁶ /deg C
Voltage dependence $\frac{\Delta R}{R} = f(V)$	< 0.3 %/V
Ambient temperature range	-10 to +100 °C
Noise	< 10 μV/V
Change in resistance after:	
- mechanical force of 1 N (100 g) along axis of connection	< 1 %
- mechanical force of 0.5 N (50 g) normal to axis of connection	< 1 %
- damp-heat test C, 21 days (IEC 68)	< 20 %
- endurance test, P _{nom} at 70 °C	< 10 %
- 10 000 hrs storage	< 5 %

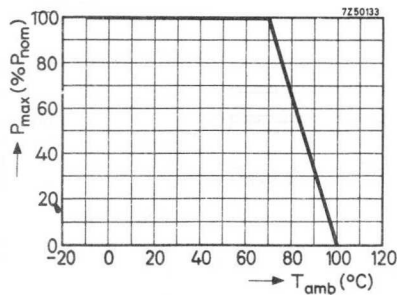

¹⁾ See "Composition of the catalog number".

COMPOSITION OF THE CATALOG NUMBER (for ordering)

For tolerance +10 %: 2322 120 22...

For tolerance +20 %: 2322 120 21...

└ resistance code, see table

resistance (Ω)	code
47	479
56	569
68	689
82	829
100	101
120	121
150	151
180	181
220	221
270	271
330	331
390	391
470	471
560	561
680	681
820	821

resistance (Ω)	code
1000	102
1200	122
1500	152
1800	182
2200	222
2700	272
3300	332
3900	392
4700	472
5600	562
6800	682
8200	822

resistance (k Ω)	code
10	103
12	123
15	153
18	183
22	223
27	273
33	333
39	393
47	473
56	563
68	683
82	823
100	104
120	124

OST RSES

UNIVERSITY OF CALIFORNIA
LIBRARY

1950
1951
1952
1953
1954
1955

PRECISION WIRE-WOUND RESISTORS

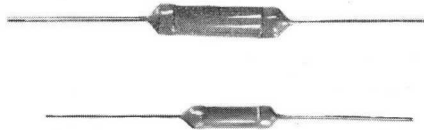

RZ 16737-1B

Max. dissipation at 40 °C	0.4 to 1.8 W
Resistance values	1 Ω to 57 kΩ, E192 series
Tolerance	±0.5 % and ±0.25 %
Temperature coefficient (±)	< 20.10 ⁻⁶ /deg C

APPLICATION

In telecommunication installations, measuring apparatus and other professional equipment. They are particularly suited for use in low-frequency filters. The resistors are tropic proof.

CONSTRUCTION

The resistors consist of a layer of resistance wire on a ceramic bar and two caps with tinned leads. The body is coated with red lacquer against mechanical damage.

Dimensions in mm

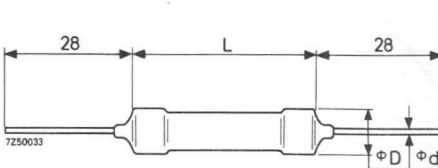

series number	P _{nom} (W)	D _{max} (mm)	L _{max} (mm)	d (mm)
260	0.4	4	13	0.8
261	0.6	5	19	0.8
262	0.7	5	28	0.8
263	1.2	7	43	1
264	1.8	7	67	1

TECHNICAL PERFORMANCE

Max. dissipation at 40 °C (= P_{nom})
at > 40 °C

0.4, 0.6, 0.7, 1.2 and 1.8 W
see respective graph

Resistance values measured at $P \leq 0.1 P_{nom}$

see Schedule

Tolerances

$\pm 0.5\%$ and $\pm 0.25\%$

Temperature coefficient (\pm)

$< 20 \cdot 10^{-6}/\text{deg C}$

Change in resistance
after 1000 hrs P_{nom} at 40 °C and
after 1000 hrs damp-heat test

$< 0.25\%$

Ambient temperature range

-55 to +110 °C

Insulation

the lacquer is non-insulating

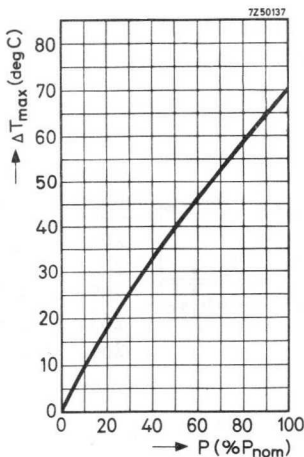
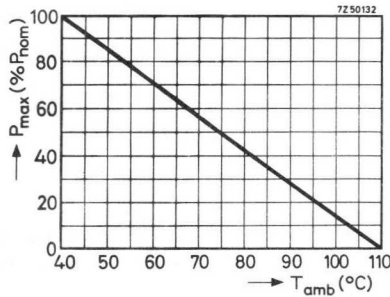

SCHEDULE

P _{nom} (W)	nominal resistances		D _{max} x L _{max} (mm x mm)	catalog series number
	min. (Ω)	max. (kΩ)		
0.4	1	3.2	4 x 13	260
0.6	3	7	5 x 19	261
0.7	6	12.5	5 x 28	262
1.2	17	33	7 x 43	263
1.8	25	57	7 x 67	264

For standard resistance values within the range see column E192 of the table at the back of this handbook. Available tolerances $\pm 0.5\%$ and $\pm 0.25\%$.

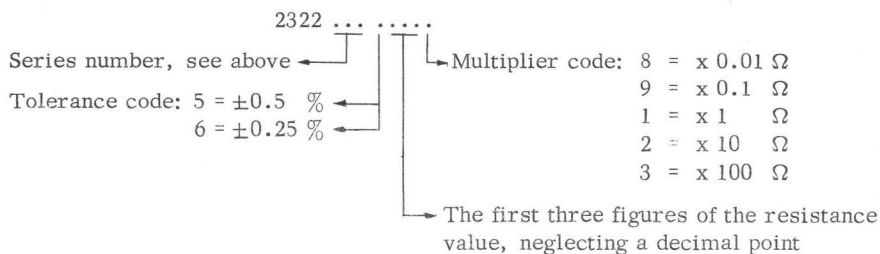
Composition of the catalog number, for ordering:

Examples:

resistance	code
5.11 Ω	5118
59 Ω	5909
100 Ω	1001
1 kΩ	1002
11.3 kΩ	1133

1915

1915

1915

LOW-OHMIC GLASS-SEALED WIRE RESISTORS



Maximum dissipation at 40 °C
Resistance values
Tolerance

1 W
0.1 to 6.8 Ω, E12 series
±10 %

RZ 20704-9

APPLICATION

In transistor circuits

CONSTRUCTION

The resistors consist of a glass-sealed resistance wire provided with tinned leads.

Dimensions in mm

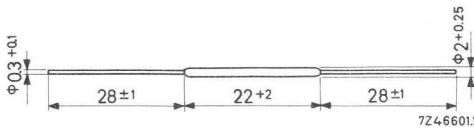

TECHNICAL PERFORMANCE

The resistances (nominal value and tolerance) are measured at $P = 0.1$ W and between points 30 mm apart.

Tolerance	±10 %
Resistance change remaining after climatic tests.	< 5 %
Temperature coefficient	$(-50 \text{ to } +150) 10^{-6} / \text{deg C}$
Operating body temperature	-25 to +275 °C
Max. dissipation at 40 °C (P_{nom})	1 W
Climatic robustness	category 25/155/56 (IEC 68)

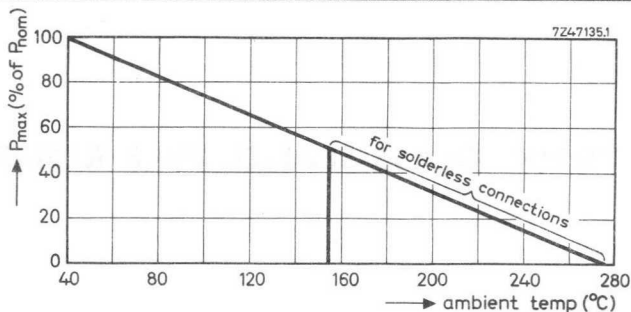

Maximum dissipation as a function of the ambient temperature

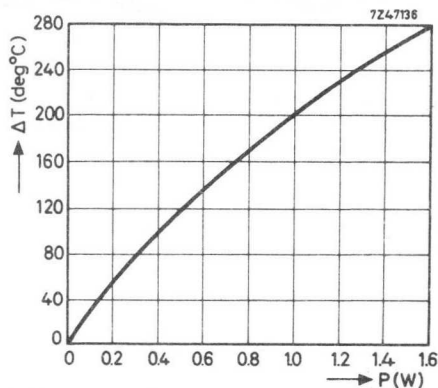

Rise of body temperature as a function of the dissipation

SCHEDULE

Composition of the catalog number, for ordering:

2322 327 61...

└─ resistance code, see table

resistance (Ω)	resistance code
0.1	107
0.12	127
0.15	157
0.18	187
0.22	227
0.27	277
0.33	337
0.39	397
0.47	477
0.56	567
0.68	687
0.82	827

resistance (Ω)	resistance code
1	108
1.2	128
1.5	158
1.8	188
2.2	228
2.7	278
3.3	338
3.9	398
4.7	478
5.6	568
6.8	688

LOW-OHMIC WIRE-WOUND RESISTORS

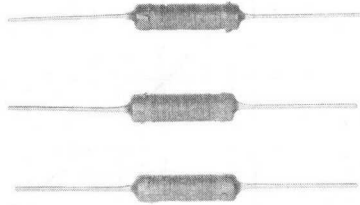

RZ 24108.2

Maximum dissipation at 70 °C
Resistance values
Tolerance

2 W
0.1 to 10Ω, E24 series
 $\pm 10\%$

APPLICATION

In transistor circuits

CONSTRUCTION

The resistors consist of a layer of resistance wire on a ceramic bar and two caps with tinned leads. The body is coated with a green lacquer

Dimension in mm

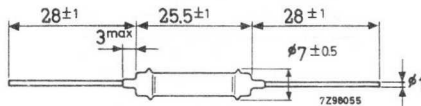

TECHNICAL PERFORMANCE

Max. dissipation at ≤ 40 °C
at other temperatures
Operating body temperature
Resistance values, measured
at $P \leq 0.2$ W
Resistance tolerance
Temperature coefficient
for 0.1 to 1 Ω resistors
for 1.1 to 10 Ω resistors
Change in resistance remaining after
load tests and after climatic tests
Climatic category conforming to
NT-14-2-4

2.6 W
see relevant graph
 -40 to $+190$ °C
0.1 to 10Ω, E24 series
 $\pm 10\%$
(0 to $+600$) $10^{-6}/\text{deg C}$
(-50 to $+25$) $10^{-6}/\text{deg C}$
 ≤ 1.5 %
505

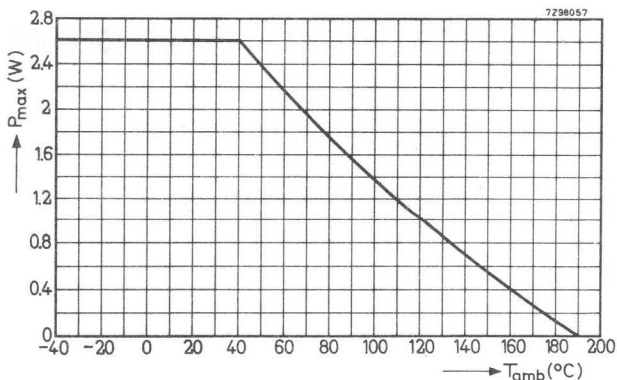

Maximum dissipation as a function of the ambient temperature

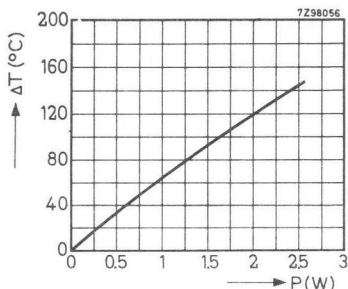

Rise of body temperature as a function of the dissipation

COMPOSITION OF THE CATALOG NUMBER

2322 326 51...

_____ resistance code

The resistance code consists of the two significant figures of the resistance value (in Ω) followed by a figure for the multiplier, the multiplier code being:

- x 0.01 = 7
- x 0.1 = 8
- x 1 = 9

Examples: 107 for 0.1 Ω; 917 for 0.91 Ω; 438 for 4.3 Ω; 109 for 10 Ω

CEMENTED WIREWOUND RESISTORS

QUICK REFERENCE DATA

Resistance ranges	from 5.6 Ω to 27 k Ω , E-12 or E-24 series
Resistance tolerance	10 or 5 %
Max. body temperature	400 $^{\circ}\text{C}$
Rated dissipation at $T_{\text{amb}} = 70^{\circ}\text{C}$	WR0617 4 W WR0825 7 W WR0842 9.5 W WR0865 15 W
Basic specification	I. E. C. publication 266
Category (I. E. C. 68)	40/200/21 or 40/200/56
Stability after:	
load	$\Delta R/R$ max. 5%
climatic tests	$\Delta R/R$ max. 5%
short time overload	$\Delta R/R$ max. 2%

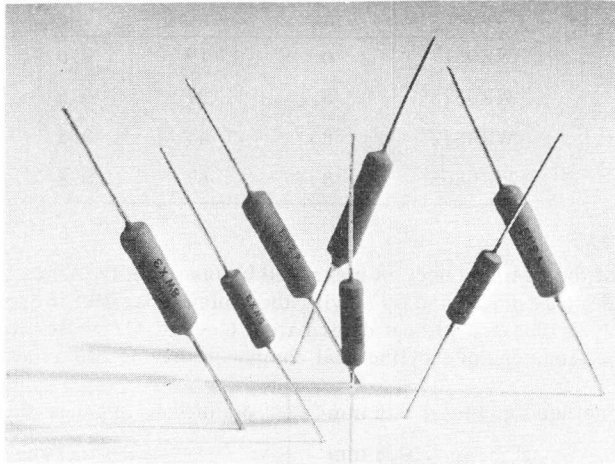

RZ 19806-1

APPLICATION

These wirewound load resistors are specifically designed to dissipate high loads in a small volume.

DESCRIPTION

On a ceramic rod with metal caps pressed over the ends a resistor element is wound in a single layer. The ends of the resistance wire and the leads are connected to the caps by welding. Tinned copperclad leads with a low heat conductivity are employed permitting the use of relatively short leads to obtain stable mounting. The resistor is coated with a green-coloured cement which is nonflammable and cannot drip even at very high overloads. The resistor is not electrically insulated.

MECHANICAL DATA

Dimensions in mm

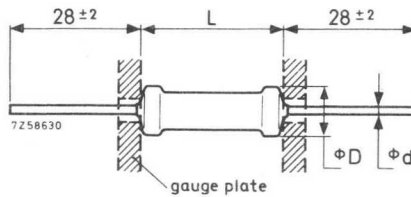

Fig. 1

Table I

Style	D_{max}	L_{max}	d
WR0617	6	19	0.6
WR0825	8	27	0.8
WR0842	8	44	0.8
WR0865	8	67	0.8

The length of the resistor body is measured by inserting the leads into the holes of two identical gauge plates and by moving these plates parallel to each other until the resistor body is clamped without deformation (see I. E. C. publication 294: Measurement of the dimensions of a cylindrical component having two axial terminations).

nominal lead diameter 0.6 mm	dia of hole in gauge plate 1.0 mm
0.8 mm	1.2 mm

Weight (per 100 pcs)

WR0617	100 g
WR0825	225 g
WR0842	530 g
WR0865	730 g

Mounting

The resistors must be mounted in such a way that:

- no stress is exerted on the leads so as to allow thermal expansion over the wide permissible temperature range.
- nearby components and materials are not affected by the dissipated heat.
- the temperature at the soldering spots of the leads does not reach the melting point of the solder.

The temperature rise of the resistor body and of the leads at various distances from the body is given as a function of the dissipation for the different resistor styles in Figs 2, 3a, 3b, 3c and 3d.

Marking

Each resistor is marked with:

- resistance value (R for Ω , K for $k\Omega$)
e.g. 27 Ω = 27R
27 $k\Omega$ = 27K
- tolerance on resistance in \pm %
- style
- date of manufacture

ELECTRICAL DATA

Standard range, Table II

style	rated dissipation at $T_{amb} = 70\text{ }^{\circ}\text{C}$	resistance range	tolerance	series 1)	catalogue number
WR0617	4 W	5.6 - 47 Ω 56 - 4700 Ω	$\pm 10\%$ $\pm 5\%$	E12 E24	2322 325 36... 2322 325 37...
WR0825	7 W	6.8 - 27 Ω 33 - 10 000 Ω	$\pm 10\%$ $\pm 5\%$	E12 E24	2322 325 26... 2322 325 27...
WR0842	9.5 W	10 - 10 000 Ω	$\pm 5\%$	E24	2322 325 17...
WR0865	15 W	15 - 16 000 Ω	$\pm 5\%$	E24	2322 325 07...

Maximum permissible surface temperature

400 $^{\circ}\text{C}$

Ambient temperature range

-40 to +200 $^{\circ}\text{C}$

Temperature coefficient

-50.10⁻⁶ to +140.10⁻⁶/deg C

except for:

WR0617, 10 Ω - 16 Ω and

WR0825, 15 Ω - 33 Ω

Climatic category according to I. E. C. 68

for resistors withstanding 21 days' damp heat test (Table III)

40/200/21

for resistors withstanding 56 days' damp heat test (Table III)

40/200/56

Table III

style	resistance range	
	21 days' damp heat test	56 days' damp heat test
WR0617	160 - 4700 Ω	5.6 - 150 Ω
WR0825	430 - 10000 Ω	6.8 - 390 Ω
WR0842	620 - 15000 Ω	10 - 560 Ω
WR0865	910 - 16000 Ω	16 - 820 Ω

Composition of the catalogue number

In the above mentioned catalogue number replace the first two dots by the first two digits of the resistance value. Replace the third dot by a figure according to the following table:

5.6 -	9.1 Ω : 8
10 -	91 Ω : 9
100 -	910 Ω : 1
1 000 -	9 100 Ω : 2
10 000 -	27 000 Ω : 3

1) See the table "Standard series of values in a decade" at the back of this book.

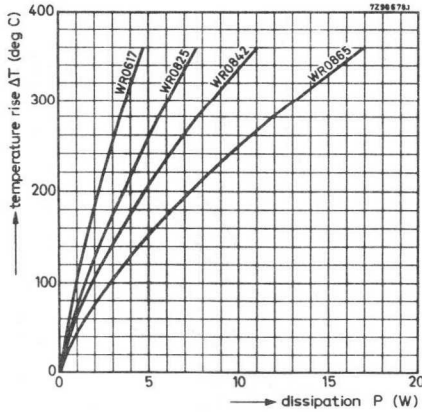

Fig. 2. Temperature rise of the resistor body as a function of the dissipation.

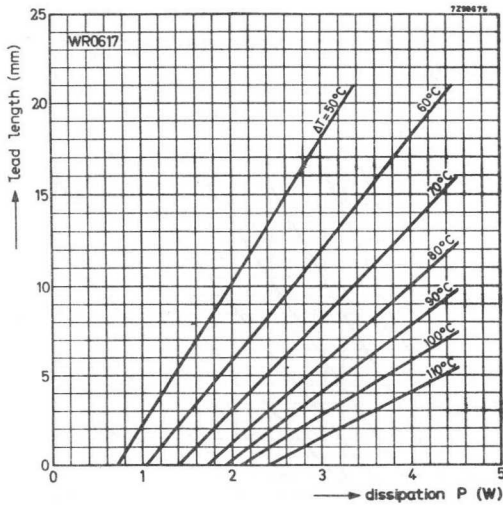

Fig. 3a. Lead length as a function of the dissipation with the temperature rise at the end of the lead (soldering spot) as parameter, for style WR0617.

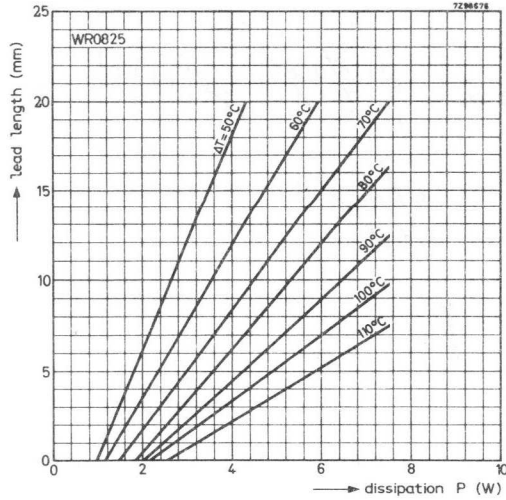

Fig. 3b. Lead length as a function of the dissipation with the temperature rise at the end of the lead (soldering spot) as parameter, for style WR0825.

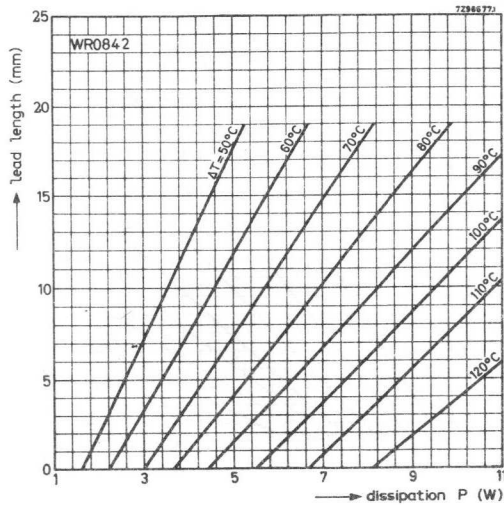

Fig. 3c. Lead length as a function of the dissipation with the temperature rise at the end of the lead (soldering spot) as parameter, for style WR0842.

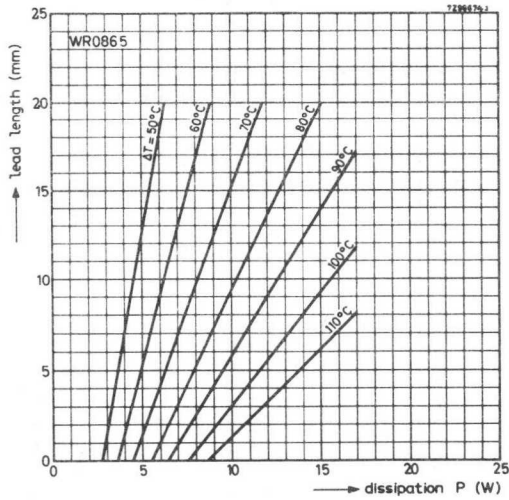



Fig. 3d. Lead length as a function of the dissipation with the temperature rise at the end of the lead (soldering spot) as parameter, for style WR0865.

TESTS AND REQUIREMENTS (in accordance with I. E. C. publ. 266)
Table IV

I. E. C. 266 clause	I. E. C. 68 test method	Test	Procedure	Requirements
14		robustness of resistor body	 load 200 ± 10 N	no visible damage $\Delta R \leq 0.5\%$ or 0.05Ω
15	U Ua Ub Uc	robustness of terminations; tensile, all samples bending, half number of samples torsion, other half number of samples	load 10 N, 10 s load 5 N, 4 x 90° 2 x 180° in opposite directions	no visible damage $\Delta R \leq 0.5\%$ or 0.05Ω
16	T	soldering; solderability thermal shock	2s 230 °C (class II) 3s 350 °C, 2.5 mm from body	good tinning, no damage no damage, $\Delta R \leq 0.5\%$ or 0.05Ω
17	Ma	rapid change of temperature	3 h -40 °C/3 h + 200 °C, 5 cycles	no visible damage $\Delta R \leq 1\%$
18	Fc	vibration	10 - 500 Hz, 0.75 mm or 10 g, whichever is the less, for 6 h 390 m/s ² , 4000 ± 10 bumps	no visible damage $\Delta R \leq 0.5\%$ or 0.05Ω
19	Eb	bumping	16 h 200 °C	no visible damage $\Delta R \leq 0.5\%$ or 0.05Ω
20	Ba Aa M D	climatic sequence; dry heat damp heat (accelerated) 1st cycle cold low air pressure damp heat (accelerated) remaining cycles	1 day 55 °C, 95-100% R.H. 2 h -40 °C 1 h 8.5 kN/m ² , 15-35 °C 5 days 55 °C, 95-100% R.H.	final measurements: $\Delta R \leq 5\%$, category -/21
21	Ca	damp heat long term	21 or 56 days (see Table III) 40 °C, 90-95% R.H., 0.01 P rated	after 24 h at rated diss. $\Delta R \leq 5\%$ $\Delta R \leq 5\%$, after 24 h at rated diss. R $\leq 5\%$
13.6 22 23		overload endurance endurance	10 times rated dissipation, 5 s 1000 h at room temperature 1000 h at upper category temperature	$\Delta R \leq 2\%$ $\Delta R \leq 5\%$ $\Delta R \leq 5\%$

PACKAGING

WR0617
WR0825

WR0842
WR0865

100 pieces per box

50 pieces per box

ENAMELLED WIRE-WOUND RESISTORS

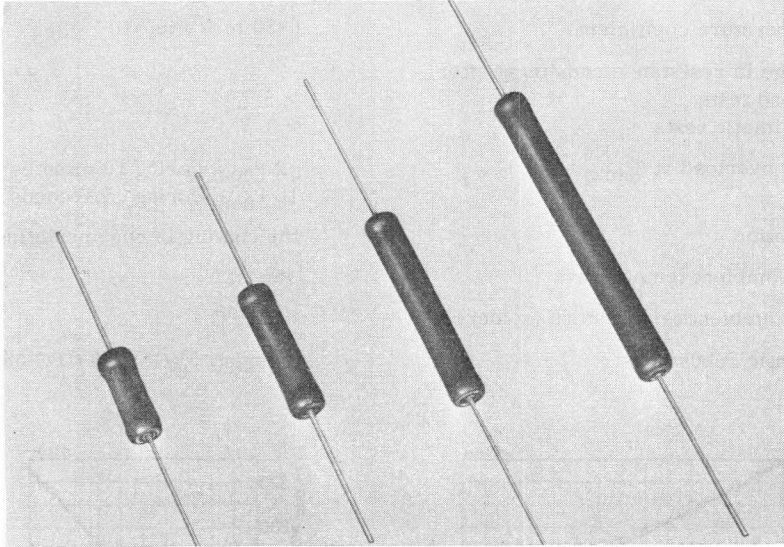

Max. dissipation at 40 °C (P_{nom})

Resistance values

Tolerances

Climatic robustness

5.5, 8, 10 and 16 W

4.7 Ω - 100 k Ω , E12 series

$\pm 10\%$ and $\pm 5\%$

category 55/155/56

C 29153-1

CONSTRUCTION

The resistors consist of one layer of resistance wire wound on a ceramic bar, terminated by caps with tinned leads and coated with brown enamel.

Dimensions in mm

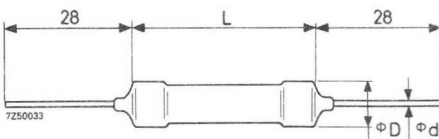

P_{nom} (W)	D_{max} (mm)	d (mm)	L_{max} (mm)
5.5	8	1.0	20
8	8	1.0	29
10	8	1.0	44
16	8	1.0	67

TECHNICAL PERFORMANCE

Max. dissipation at 40 °C (= P_{nom})
at > 40 °C

5.5, 8, 10 and 16 W
see relevant graph

Resistance values measured at P ≤ P_{nom}

see Schedule

Tolerances

±5 % and ±10 %

Temperature coefficient

(-50 to + 140)10⁻⁶/deg C

Change in resistance remaining after

- load tests

< 5 %

- climatic tests

< 1 %

Max. overload at T_{amb} = 40 °C

2 P_{nom} during 10 minutes
10 P_{nom} during 5 seconds

Insulation

the coating is non-insulating

Min. ambient temperature

-55 °C

Max. ambient temperature (soldered)

+155 °C

Climatic robustness

category 55/155/56 (IEC 68)

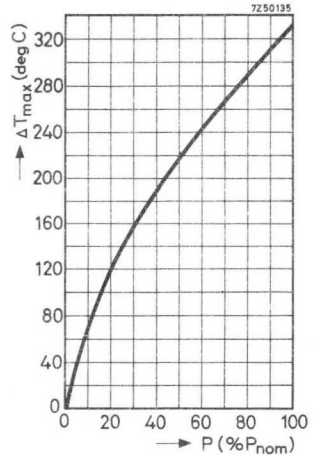
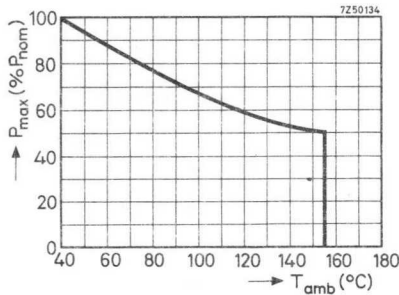

SCHEDULE

P _{nom} (W)	resistance values			D _{max} x L _{max} (mm x mm)	catalog number: 2322 320 followed by
	tolerance (±.. %)	min. (Ω)	max. (Ω)		
5.5	10	4.7	180	8 x 20	31...
5.5	5	220	15 000	8 x 20	32...
8	10	4.7	47	8 x 29	21...
8	5	56	33 000	8 x 29	22...
10	5	10	56 000	8 x 44	12...
16	5	15	100 000	8 x 67	02...

Standard resistance values within the given range can be chosen from the E12 series:

10-12-15-18-22-27-33-39-47-56-68-82

Resistance of the E24 series, tolerance ±5 %, are available on request.

Composition of the catalog number, for ordering

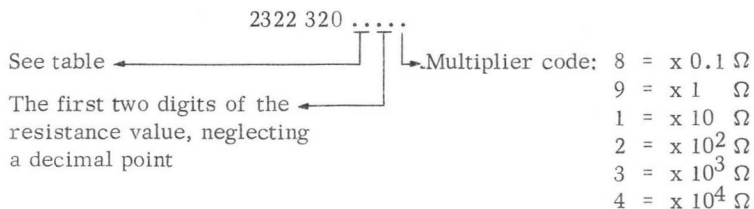

058 0018
058 0018
058 0018
058 0018
058 0018

WIRE-WOUND RESISTORS WITH SIDE TERMINATIONS

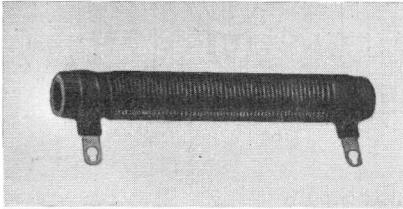

RZ 14250-1A

≤ 40 W

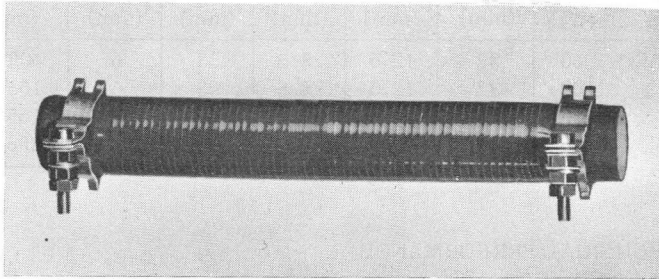

RZ 14250-1B

≥ 60 W

	<u>cemented</u>	<u>enamelled</u>
Max. dissipation at 40 °C (P_{nom})	8 - 250 W	8 - 100 W
Resistance values (E12 series)	1 Ω - 11 k Ω	160 Ω - 120 k Ω
Tolerance	± 5 % (± 10 %)	± 5 %

CONSTRUCTION

The resistors consist of one layer of resistance wire on a ceramic cylinder with side terminations. The 323-resistors are coated with cement, the 321-resistors with enamel for mechanical protection.

Dimensions in mm

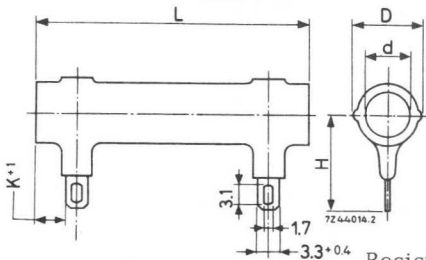

P_{nom} (W)	D_{max}	d_{min}	K	L	H
8	11.5	5	2.5	26^{-2}	14
10	11.5	5	4	41^{-2}	14
16	11.5	5	4	62.5^{-2}	14
25	16	8	4	64^{-2}	20
40	16	8	4	103^{-5}	20

Resistors with $P_{nom} \leq 40$ W

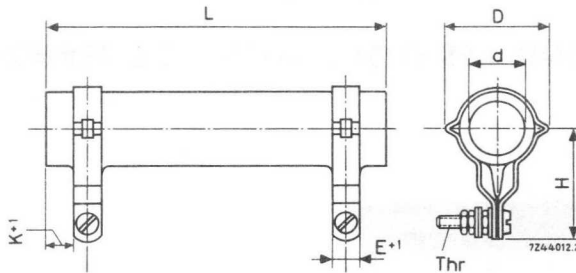

Resistors with $P_{nom} \geq 60$ W

P_{nom} (W)	D_{max} (mm)	d_{min} (mm)	E (mm)	H (mm)	K (mm)	L (mm)	Thr (mm)
60	32	12.5	8.5	33	6	103^{-5}	M4
100	32	12.5	8.5	33	6	165^{-8}	M4
160	44	20	10	40	8	165^{-8}	M5
250	44	20	10	40	8	256^{-10}	M5

TECHNICAL PERFORMANCE

Max. dissipation at 40 °C (= P_{nom})
at > 40 °C

see Schedule
see relevant graph

Max. dissipation, mounted, with a
bolt through the cylinder, against
a metal plate

1.2 x max. dissipations given above

Max. overload at 40 °C

2 P_{nom} during 10 minutes,
10 P_{nom} during 5 seconds

Resistance values (see Schedule)

measured at $P = 0.1 P_{nom}$

Tolerance

$\pm 5\%$ ($\pm 10\%$)

Temperature coefficient

(-50 to +140) $10^{-6}/\text{deg C}$

Change in resistance after load tests
after climatic tests

< 5 %
< 3 %

Insulation

the coating is non-insulating

Ambient temperature range

-55 to +155 °C

Climatic robustness

category 55/155/56 (IEC 68)

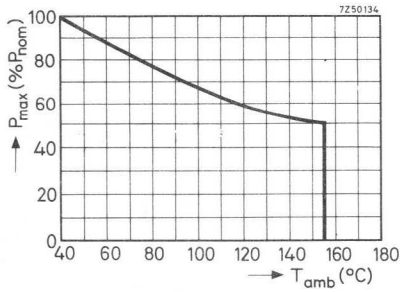

Max. dissipation as a function of the ambient temperature.
With a bolt through the resistor, mounted against a metal plate, P_{max} can be multiplied by 1.2.

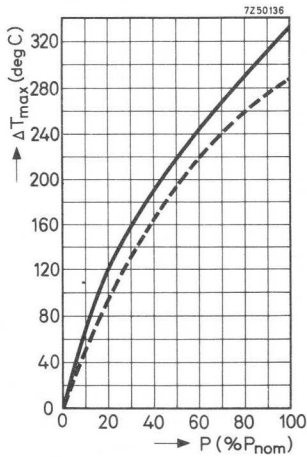

Max. temperature rise as a function of the dissipation.
The broken line applies to mounting with bolt and plate.

SCHEDULE

coating	P _{nom} (W)	resistance values			D _{max} x L _{max} (mm x mm)	catalog number: 2322 followed by
		tol. (±.%)	min. (Ω)	max. (Ω)		
cement	8	10	1	100	11.5 x 26	323 14...
enamel		5	110	150		323 34...
		5	160	6 800		321 34...
cement	10	10	1.2	27	11.5 x 41	323 12...
enamel		5	30	300		323 32...
		5	330	12 000		321 32...
cement	16	10	1.5	2.7	11.5 x 62.5	323 10...
enamel		5	3	620		323 30...
		5	680	24 000		321 30...
cement	25	10	2.7	15	16 x 64	323 08...
enamel		5	16	820		323 28...
		5	1 000	39 000		321 28...
cement	40	5	4.7	1 600	16 x 103	323 26...
enamel		5	1 800	75 000		321 26...
cement	60	5	3	2 200	32 x 103	323 24...
enamel		5	2 400	68 000		321 24...
cement	100	5	6.8	4 300	32 x 165	323 23...
enamel		5	4 700	120 000		321 23...
cement	160	5	10	6 800	44 x 165	323 22...
cement		250	5	16		11 000

Standard resistance values within the given range can be chosen from the E12 series: 10-12-15-18-22-27-33-39-47-56-68-82. Resistance values of the E24 series are available on request, see table at the back of this handbook.

Composition of the catalog number, for ordering

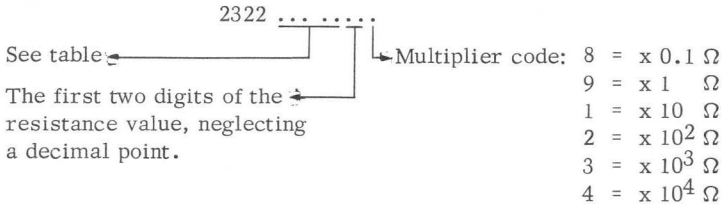

ADJUSTABLE WIRE-WOUND RESISTORS

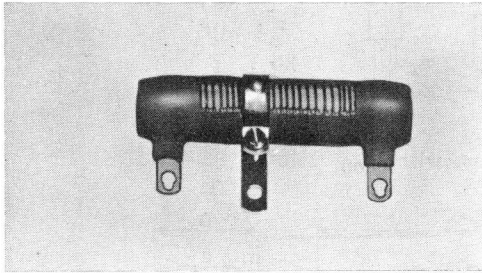

RZ 14250-1C

≤ 40 W

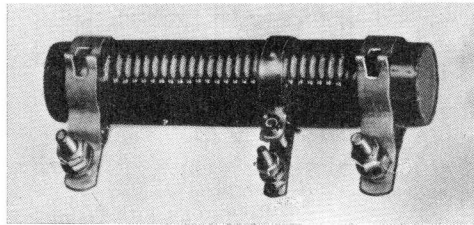

RZ 14250-1D

≥ 60 W

	<u>cemented</u>	<u>enamelled</u>
Max. dissipation at 40 °C (P_{nom})	10 - 250 W	10 - 100 W
Resistance values (E12 series)	1.2 Ω - 11 k Ω	330 Ω - 47 k Ω
Tolerance	± 5 % (10%)	± 5 %

CONSTRUCTION

The resistors consist of one layer of resistance wire on a ceramic cylinder with side terminations. A strap, fitted with a silver contact, may be adjusted to any point along an uncoated strip of the resistor. The 324-resistors are coated with cement, the 322-resistors with enamel for mechanical protection.

Dimensions in mm

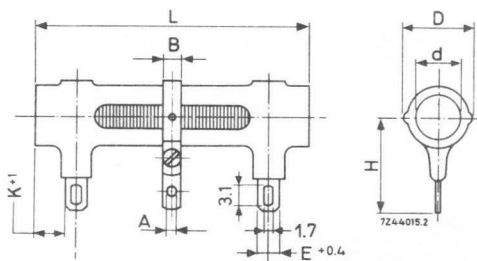

Resistors with $P_{nom} \leq 40$ W

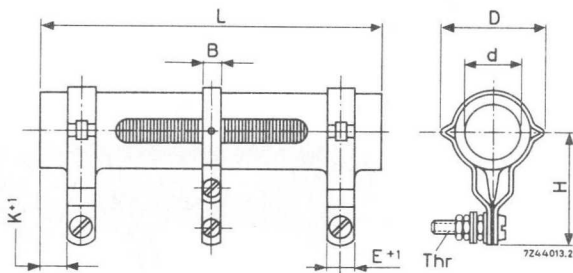

Resistors with $P_{nom} \geq 60$ W

P_{nom} (W)	dimensions in mm								
	D_{max}	d_{min}	H	K	E	L	B	A	Thr
10	11.5	4.2	14	4	3.3	41 ⁻²	5	2.8	-
16	11.5	4.2	14	4	3.3	62.5 ⁻²	5	2.8	-
25	16	7.2	20	4	3.3	64 ⁻²	6	3.2	-
40	16	7.2	20	4	3.3	103 ⁻⁵	6	3.2	-
60	32	12.5	33	6	8.5	103 ⁻⁵	6	-	M4
100	32	12.5	33	6	8.5	165 ⁻⁸	6	-	M4
160	44	20	40	8	10	165 ⁻⁸	8	-	M5
250	44	20	40	8	10	256 ⁻¹⁰	8	-	M5

TECHNICAL PERFORMANCE

Identical to that of the non-adjustable wire-wound resistors with side terminations, see 323 and 321 series.

SCHEDULE

coating	P _{nom} l) (W)	resistance values (R _{nom}) ¹⁾			short circuit l) (% R _{nom})	D _{max} x L _{max} (mm x mm)	cat. number 2322 followed by
		tol. (±. .%)	min. (Ω)	max. (Ω)			
cement	10	10	1.2	27	9	11.5 x 41	324 12...
enamel		5	30	300			324 32...
		5	330	3300			322 32...
cement	16	10	1.5	2.7	5	11.5 x 62.5	324 10...
enamel		5	3	620			324 30...
		5	680	6800			322 30...
cement	25	10	2.7	15	4	16 x 64	324 08...
enamel		5	16	820			324 28...
		5	1000	9100			322 28...
cement	40	5	4.7	1600	2.5	16 x 103	324 26...
enamel		5	1800	18000			322 26...
cement	60	5	3	2200	3	32 x 103	324 24...
enamel		5	2400	24000			322 24...
cement	100	5	6.8	4300	1.5	32 x 165	324 23...
enamel		5	4700	47000			322 23...
cement	160	5	10	6800	1.5	44 x 165	324 22...
cement	250	5	16	11000	1	44 x 256	324 21...

Standard resistance values within the given range can be chosen from the E12 series: 10-12-15-18-22-27-33-39-47-56-68-82. Resistance values of the E24 series are available on request, see table at the back of this handbook.

Composition of the catalog number, for ordering

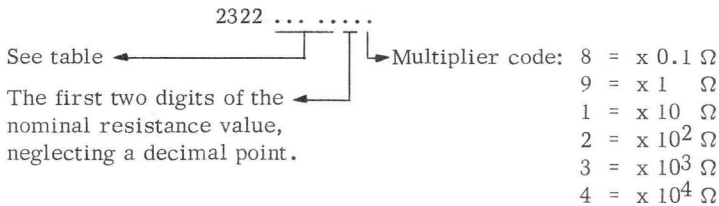

¹⁾ The adjustable contact short-circuits a number of windings. The maximum resistance loss has been given as a percentage of the nominal resistance. Nominal dissipation and nominal resistance values apply if no contact strap were connected.

250 9582

SEP 21 1951

UNIVERSITY OF MICHIGAN LIBRARY

Variable resistors



Wire-wound potentiometers	page B3
Carbon potentiometers	page B37

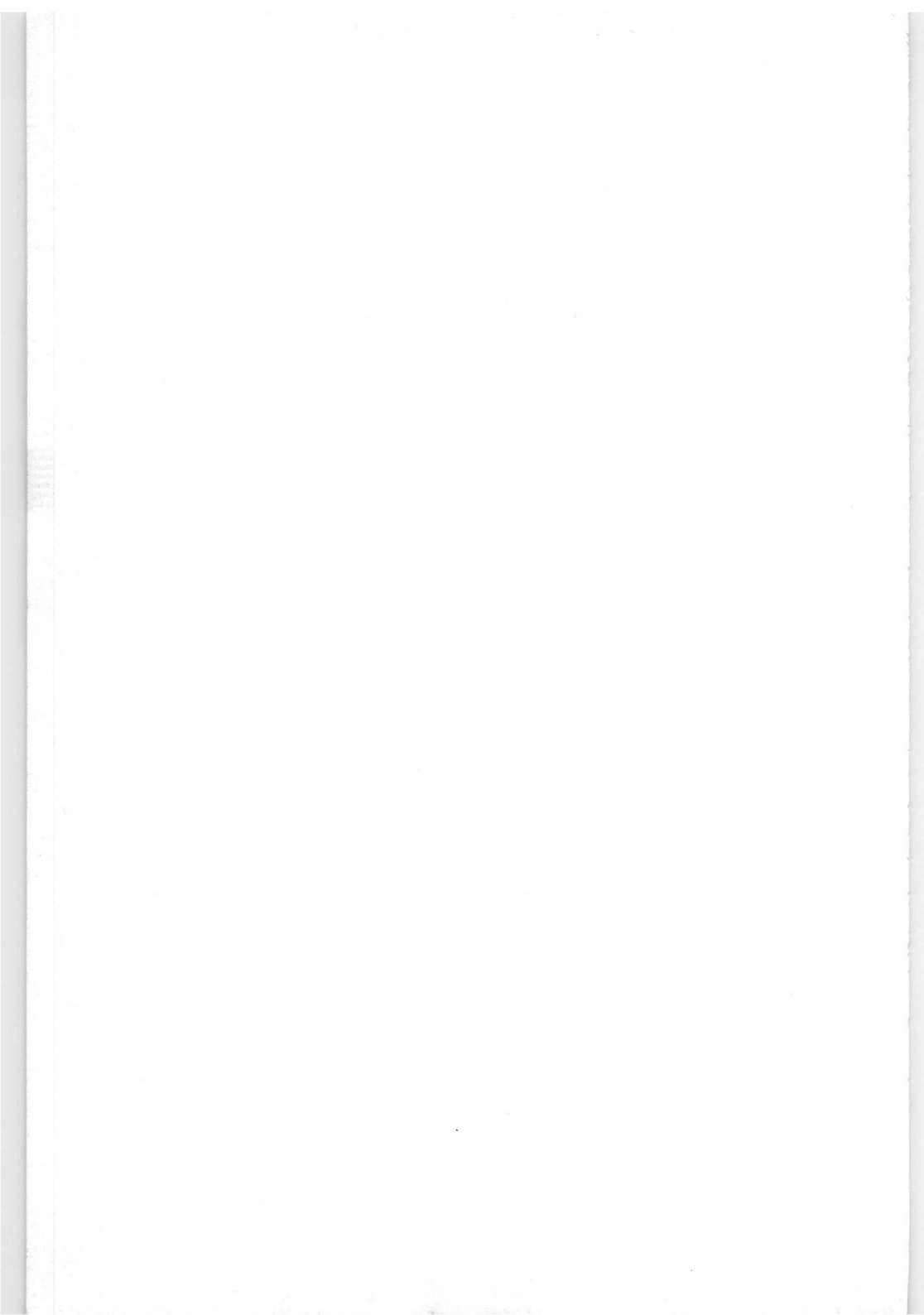

WIRE-WOUND TRIMMING POTENTIOMETERS

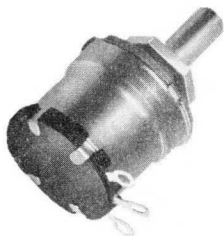

RK 9030-2

Linear resistance law

Resistance range

Maximum permissible dissipation at 40 °C
at 70 °C

47-3300 Ω

3 W

2 W

APPLICATION

In professional electric and electronic equipment where accurate and gradual resistance adjustment and very high stability are required.

The application of precious metals for a.o. resistance wire and sliding contact guarantee a life of at least 500 cycles.

CONSTRUCTION

The potentiometer consists of a single layer of silver paladium resistance wire wound on a strip of resin-bonded paper and housed in a nickel-plated brass case with a bottom of black synthetic resin.

The soldering tags S_1 and S_2 (see the figures on the next page) are connected to the ends of the resistance element; soldering tag S_3 is connected via a central bush to the sliding contact which is insulated from the steel spindle. The contact surfaces of the sliding contact and of the central bush are gold-plated.

The case is attached onto a support of moulded zinc, which is equipped with a location pip, an end stop, and a threaded spindle bush.

The whole is sealed dust-proof.

Dimensions in mm

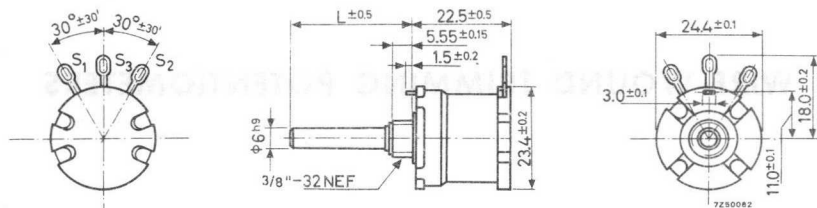

Potentiometers with a spindle suited for knob adjustment.
The spindle length L is 15 or 20 mm.

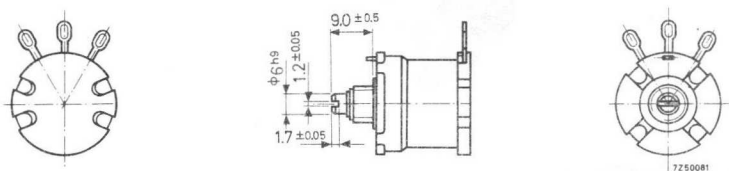

Potentiometers with a spindle suited for screwdriver adjustment.

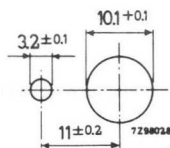

With the supplied nickel-plated brass mounting nut, catalog number 4322 047 00390, the potentiometers can be fixed on the chassis.

Mounting holes

TECHNICAL PERFORMANCE

Nominal resistance values (R_N), measured between the tags S_1 and S_2 (see the figures above)

Tolerance on the nominal resistance

Temperature coefficient of the resistance

Resistance law

Tolerance on the resistance law

Contact resistance

Change of contact resistance

Minimum resistance at both ends

see Table 1

$\pm 5\%$

$+ 100 \cdot 10^{-6} / \text{deg C}$

linear

$\pm 2\%$ of R_N

$\leq 50 \text{ m}\Omega$

$\leq 10 \text{ m}\Omega$

$\leq 50 \text{ m}\Omega$

Change of minimum resistance	$\leq 10 \text{ m}\Omega$
Resistance between resistance element and end contacts	$\leq 5\%$ of R_n
Dissipation as a function of the ambient temperature, the full length of the resistance element being used	see the figures below
Insulation resistance	$> 1000 \text{ M}\Omega$
Test voltage for 1 min	1000 V_{ac}
Maximum working voltage	500 V_p
Working-temperature range	-40 to $+100 \text{ }^\circ\text{C}$
Number of windings	see Table 1
Effective angle of rotation	$290 \pm 5^\circ$
Mechanical angle of rotation	$300 \pm 5^\circ$
Operating torque	$2\text{-}5 \text{ Ncm}$
End stop torque	$\leq 80 \text{ Ncm}$
Maximum axial spindle load	50 N
Life	in excess of 500 cycles

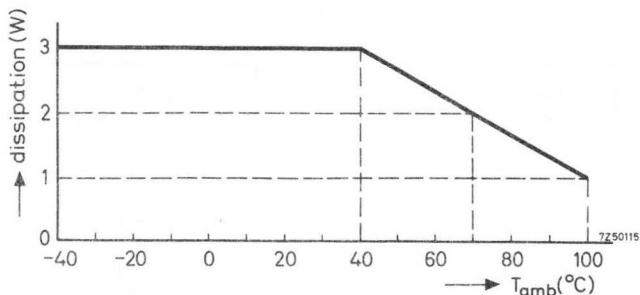

Dissipation as a function of the ambient temperature for potentiometers mounted on a metal chassis of 100 x 100 x 1 mm.

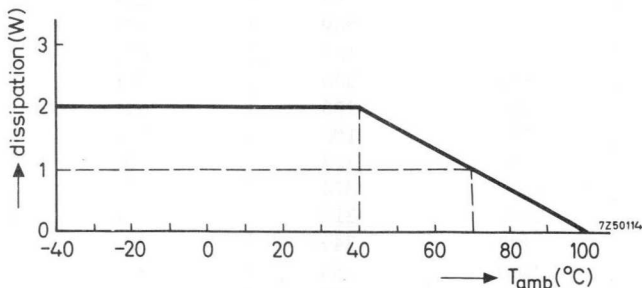

Dissipation as a function of the ambient temperature for potentiometers mounted on an insulating panel.

TYPES

Composition of the
catalog number

2322 000 . 2 . . .

code for resistance value,
see Table 1

indicating the tolerance of
 $\pm 5\%$

figure indicating the spindle type

0 = spindle suited for screwdriver adjustment;

length 9 mm

2 = spindle suited for knob adjustment;

length 15 mm

3 = spindle suited for knob adjustment;

length 20 mm

Example: for a potentiometer with a nominal resistance value of 330 Ω , for screwdriver adjustment, the catalog number is 2322 000 02331.

Table 1

resistance value (Ω)	number of windings $\pm 25\%$	code in catalog number
47	74	479
50	79	509
68	107	689
75	118	759
100	102	101
150	151	151
200	163	201
220	179	221
250	195	251
330	269	331
470	189	471
500	200	501
680	273	681
750	190	751
1000	253	102
1500	378	152
2000	319	202
2200	349	222
2500	253	252
3300	334	332

WIRE-WOUND POTENTIOMETERS

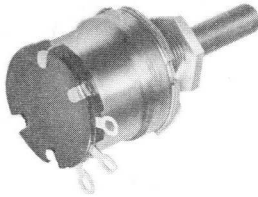

RK 9030-3

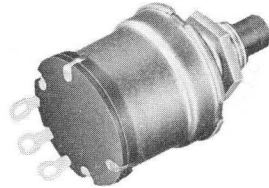

RZ 24052-3

Linear resistance law

Resistance range

Maximum permissible dissipation at 40 °C
at 70 °C

Potentiometers 2322 003

Potentiometers 2322 010

2.2-22000 Ω

3 W

2 W

provided with soldering
tags at the side

provided with soldering
tags at the bottom¹⁾

APPLICATION

In professional electric and electronic equipment where accurate and gradual resistance regulation and high stability are required.

CONSTRUCTION

The potentiometer consists of a single layer of resistance wire wound on a strip of resin-bonded paper and housed in a nickel-plated brass case with a bottom of black synthetic resin.

The soldering tags S_1 and S_2 (see the figures on the next page) are connected to the ends of the resistance element; soldering tag S_3 is connected, via a central bush, to the sliding contact which is insulated from the steel spindle¹⁾.

The case is attached onto a support of moulded zinc, which is equipped with a location pip, an end stop, and a threaded spindle bush.

The whole is sealed dust-proof.

¹⁾ A version with pins for printed-wiring and a tap at 50% of the effective angle of rotation can be supplied on request (catalogue number 2322 010 90013).

Dimensions in mm

The spindle length L is 17, 20, 30 or 60 mm.

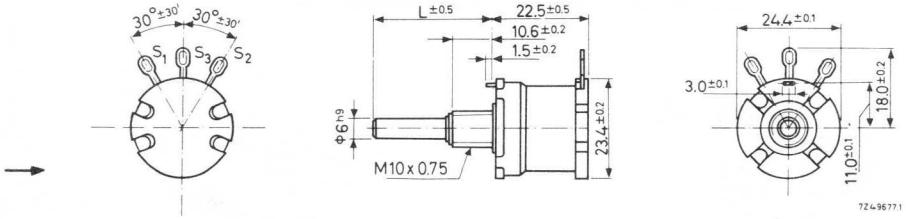

Potentiometers 2322 003 with a spindle suited for knob adjustment.

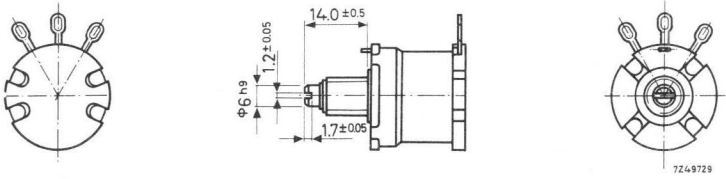

Potentiometers 2322 003 with a spindle suited for screwdriver adjustment.

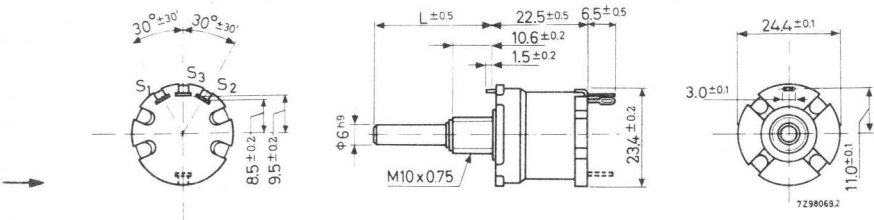

Potentiometers 2322 010 with a spindle suited for knob adjustment.

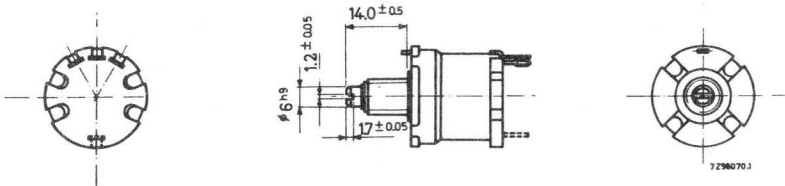

Potentiometers 2322 010 with a spindle suited for screwdriver adjustment.

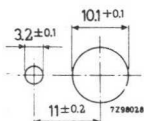

Mounting holes

With the supplied cadmium-plated steel mounting nut, catalogue number 4322 047 00380, the potentiometers can be fixed on the chassis. The minimum thickness of the chassis is 1 mm.

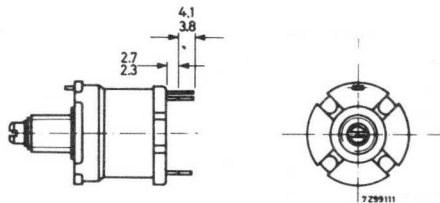
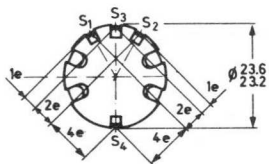

Potentiometer 2322 010 90013; available on request.

Hole pattern of the printed-wiring board for mounting potentiometer 2322 010 90013

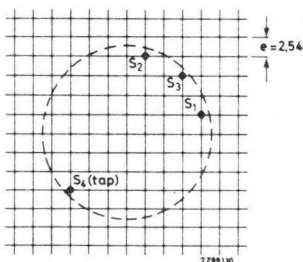

TECHNICAL PERFORMANCE

Nominal resistance values (R_n), measured between the tags S_1 and S_2 (see the figures on the preceding page)

Tolerance on the nominal resistance
for $R_n \leq 47 \Omega$
for $R_n > 47 \Omega$

Resistance law

Tolerance on the resistance law

Dissipation as a function of the ambient temperature, the full length of the resistance element being used

Temperature coefficient of the resistance

Insulation resistance

Test voltage between spindle and contacts for 1 min

Maximum working voltage between resistance element and case

Working-temperature range

Number of windings

see Table 1

$\pm 10\%$
 $\pm 5\%$ and $\pm 10\%$
linear
 $\pm 2\%$ of R_n

see the figures on the next page
see Table 1
 $> 1000 M\Omega$

1000 V_{ac}

500 V_p
-10 to +85 °C

see Table 1

Effective angle of rotation
Mechanical angle of rotation
Operating torque
End stop torque
Maximum axial spindle load

$290 \pm 5^\circ$
 $300 \pm 10^\circ$
0.75-2 Ncm
 ≤ 80 Ncm
50 N

→ Life, for $R_n \leq 6.8 \text{ k}\Omega$
for $R_n > 6.8 \text{ k}\Omega$

in excess of 25 000 cycles
in excess of 10 000 cycles

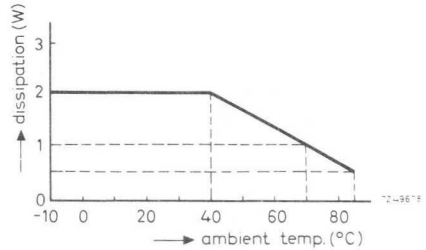
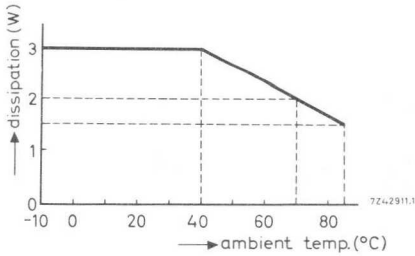

Dissipation as a function of the ambient temperature for potentiometers mounted on a metal chassis of 100 x 100 x 1 mm. TYPES

Dissipation as a function of the ambient temperature for potentiometers mounted on an insulating panel.

Composition of the catalogue number

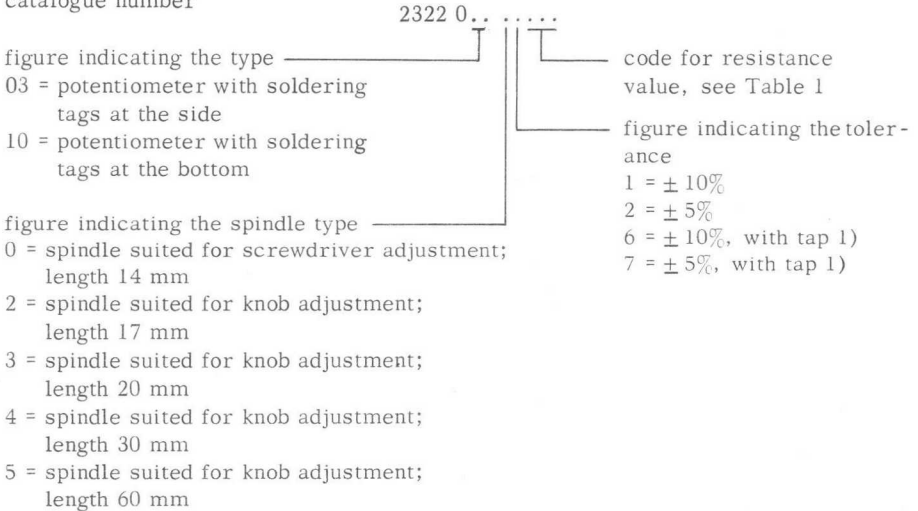

For example: for a potentiometer with soldering tags at the bottom, a nominal resistance value of 3.3 k Ω , tolerance $\pm 10\%$, for screwdriver adjustment, the catalogue number is 2322 002 01332.

1) The potentiometers can be supplied with a tap at 50% of the effective angle of rotation.

Table 1

resistance value in Ω	temperature coefficient in $10^{-6}/\text{deg C}$	number of windings $\pm 25\%$	code in catalogue number
2.2	0 to +600	60	228
3.3		55	338
4.7		79	478
6.8		71	688
10		105	109
15		102	159
22		150	229
7.5+7.5		102	1)
33	-25 to +600	141	339
47		103	479
68	-25 to +25	96	689
100		142	101
150		128	151
220		188	221
330	-25 to +140	182	331
470		191	471
680	0 to +140	172	681
1 000		155	102
1 500		234	152
2 200		227	222
3 300		342	332
4 700		302	472
6 800		438	682
10 000	-20 to +140	413	103
15 000		497	153
22 000		448	223

1) Version with pins for printed-wiring catalogue number 2322 010 90013, available on request.

604 2500
010 1015

WIRE-WOUND POTENTIOMETERS

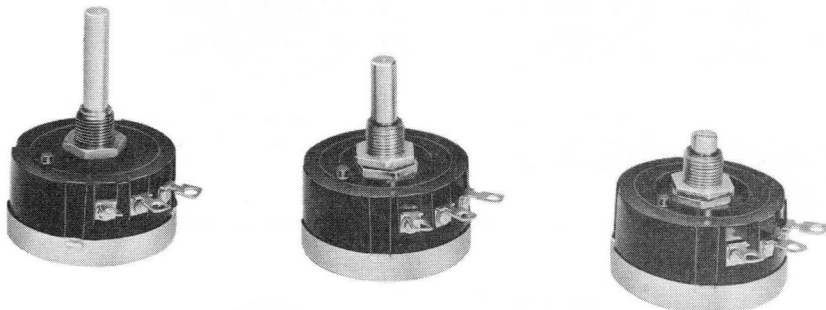

RZ 22358-2

Linear resistance

Resistance range

Maximum permissible dissipation at 40 °C

10-50 000 Ω

3 W

APPLICATION

In professional electric and electronic equipment where accurate and gradual resistance regulation and high stability are required.

Thanks to the large outer diameter compared with some other types a very good resolution has been obtained.

CONSTRUCTION

The potentiometer consists of a single layer of resistance wire wound on a strip of resin-bonded paper and housed in a case of black synthetic resin, which is dust-proof closed by a metal bottom.

The soldering tags S_1 and S_3 (see the figures on the next page) are connected to the ends of the resistance element.

A resilient slider, which is insulated from the steel spindle, slides over the flat top of the winding when the spindle is turned. The slider makes a sliding contact with the soldering tag S_2 by means of a slip ring. A stop prevents the slider from overrunning the resistance element.

Dimensions in mm

The spindle length L is 20, 25, 30, 35 or 80 mm.

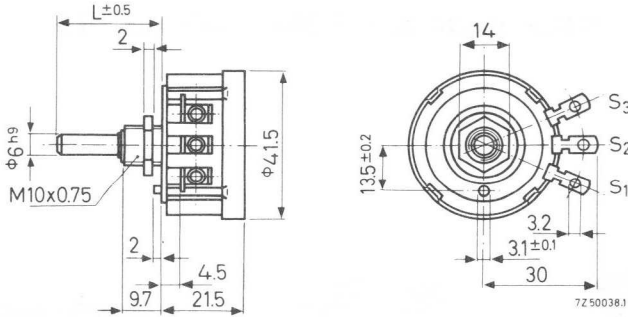

Potentiometers with a spindle suited for knob adjustment.

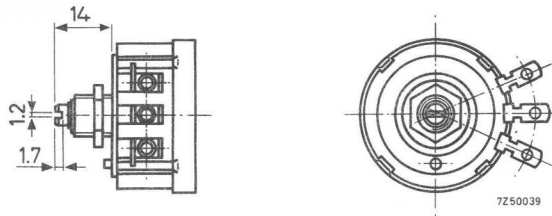

Potentiometers with a spindle suited for screwdriver adjustment.

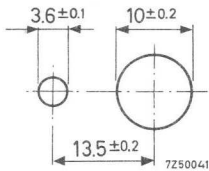

The potentiometers can be fixed on the chassis with the hexagonal steel nut.

Mounting holes

Weight

spindle length (mm)	weight (g)
14	36
20	38
25	39
30	40
35	42
80	56

TECHNICAL PERFORMANCE

Nominal resistance values (R_n), measured between the tags S_1 and S_3 (see the figures on the preceding page)

see Table 1

Tolerance on the nominal resistance
 for $R_n \leq 75 \Omega$
 for $R_n > 75 \Omega$

$\pm 10\%$
 $\pm 5\%$ and $\pm 10\%$
 linear
 $\pm 2\%$ of R_n

Resistance law

Tolerance on the resistance law

Maximum permissible dissipation
 at $T_{amb} = 40^\circ C$ (P_n)
 at $T_{amb} > 40^\circ C$ (P)

3 W
 see figure, below
 see Table 1

Temperature coefficient of the resistance

Insulation resistance

> 100 M Ω

Test voltage between spindle and contacts for 1 min

2000 V_{rms}

Maximum working voltage between resistance element and case

750 V_p
 -55 to +100 °C

Working-temperature range

Number of windings

see Table 1

Effective angle of rotation

280 \pm 4°

Mechanical angle of rotation

300 \pm 2°

Operating torque

1-3 Ncm

End stop torque

\leq 80 Ncm

Maximum axial spindle load

50 N

Life, for $R_n \leq 10 k\Omega$

in excess of 25 000 cycles

for $R_n > 10 k\Omega$

in excess of 10 000 cycles

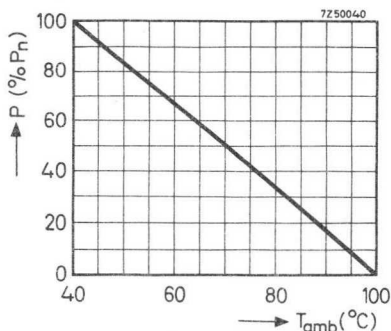

Dissipation as a function of the ambient temperature

TYPES

Composition of the
catalog number

2322 004

code for resistance value,
see Table 1

figure indicating the toler-
ance

1 = $\pm 10\%$

2 = $\pm 5\%$ ($R_n > 75 \Omega$)

figure indicating the spindle type

2 = spindle suited for screwdriver adjustment;

length 14 mm

3 = spindle suited for knob adjustment;

length 20 mm

4 = spindle suited for knob adjustment;

length 25 mm

5 = spindle suited for knob adjustment;

length 30 mm

6 = spindle suited for knob adjustment;

length 35 mm

7 = spindle suited for knob adjustment;

length 80 mm

Example: for a potentiometer with a nominal resistance value of 3.5 k Ω , tolerance $\pm 5\%$, for screwdriver adjustment, the catalog number is 2322 004 22352.

Table 1

resistance value in Ω	temperature coefficient in $10^{-6}/\text{deg C}$	number of windings $\pm 25\%$	code in catalog number
10	0 to +600	200	109
15		300	159
20		250	209
25		320	259
35		275	359
50		400	509
75		375	759
100	-25 to +25	250	101
150		240	151
200		320	201
250		390	251
350		350	351
500		500	501
750		475	751
1 000	625	102	
1 500	0 to +140	450	152
2 000		600	202
2 500		375	252
3 500		620	352
5 000		625	502
7 500		900	752
10 000		750	103
15 000		700	153
20 000		950	203
25 000	1 200	253	
35 000	-20 to +20	1 300	353
50 000		1 500	503



11

100-100000

WIRE-WOUND TRIMMING POTENTIOMETERS

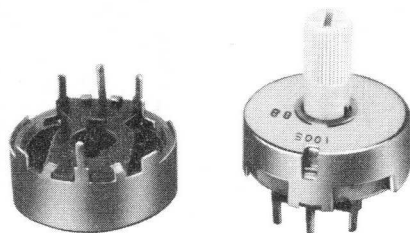

RZ 26449-3

Linear resistance law	
Resistance range	2.2-1000 Ω
Maximum permissible dissipation	
at 40 °C	2 W
at 70 °C	1 W
Intended for mounting on printed-wiring boards	

APPLICATION

In a wide variety of electronic equipment, e.g. for pre-setting of the horizontal and vertical convergence in colour television receivers.

CONSTRUCTION

The potentiometers consist of a single layer of resistance wire housed in a metal case. The resistance element and its terminal pins (S1 and S2) are insulated from the case; the slider is connected to the case (pins S3).

Four potentiometer types are available: with or without a tap (pin S4) in the middle of the resistance element and with or without a plastic knob.

Dimensions in mm

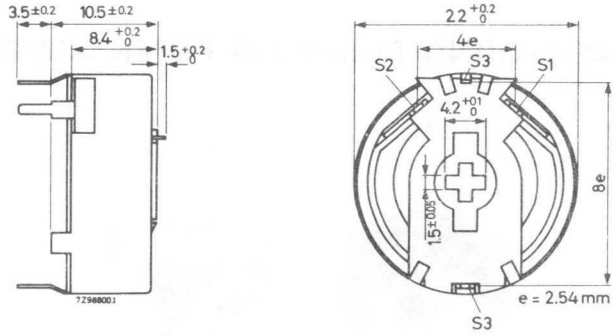

Fig. 1. Non-tapped potentiometer without knob

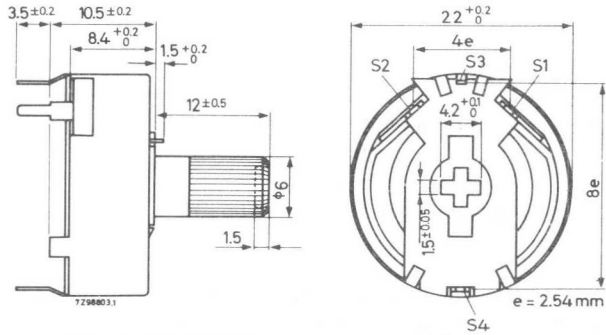

Fig. 2. Tapped potentiometer with knob

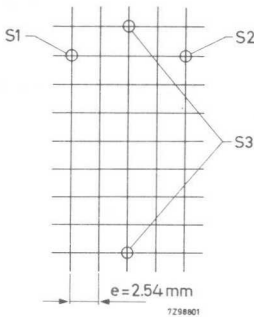

Fig. 3.

Mounting holes for non-tapped potentiometers

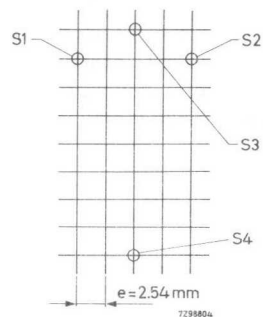

Fig. 4.

Mounting holes for tapped potentiometers

TECHNICAL PERFORMANCE

Nominal resistance value (R_N) between S_1 and S_2	2.2 Ω to 1 k Ω , see Table
Resistance law	linear, see Figs. 5 and 6
Tolerance on R_N	$\pm 10\%$
Resistance at beginning and end	$\leq 5\%$ of R_{total}
Resistance at 50% of effective angle of rotation	$50\% \pm 2\%$ of R_{total}
Contact resistance between resistance element and slider	≤ 500 m Ω
Change of contact resistance between resistance element and slider	≤ 300 m Ω
Temperature coefficient	see Table
Maximum dissipation between S_1 and S_2 , potentiometer mounted on printed-wiring board (Fig. 7)	2 W
at $T_{amb} = 40$ $^{\circ}\text{C}$	1 W
at $T_{amb} = 70$ $^{\circ}\text{C}$	-10 to +100 $^{\circ}\text{C}$
Working temperature range	$255 \pm 10^{\circ}$
Mechanical angle of rotation	$240 \pm 10^{\circ}$
Effective angle of rotation	1-3 Ncm
Operating torque	15 Ncm
Maximum end stop torque	250 cycles
Life	

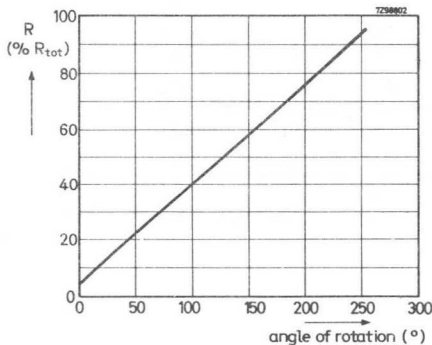

Fig. 5.

Resistance variation with the angle of rotation for non-tapped potentiometers

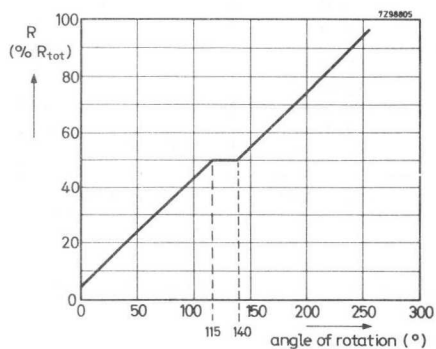

Fig. 6.

Resistance variation with the angle of rotation for tapped potentiometers

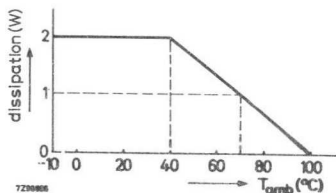

Fig. 7. Dissipation as a function of the ambient temperature; potentiometers mounted on a printed-wiring board.

Table

resistance value in Ω	temperature coefficient in $10^{-6}/\text{degC}$	number of windings	code in catalogue number
2.2	0 to +600	110	228
3.3		108	338
4.7		95	478
6.8		136	688
10		126	109
15		194	159
22	-25 to + 25	113	229
33		134	339
47		120	479
68		172	689
100		160	101
120	0 to +140	138	121
150		178	151
180		207	181
220		165	221
330		155	331
470		222	471
680		200	681
1000		297	102
11 + 11 50 + 50	-25 to + 25	113	229
		160	101
150 + 150	0 to +140	150	301

TYPES

Composition of the catalogue number

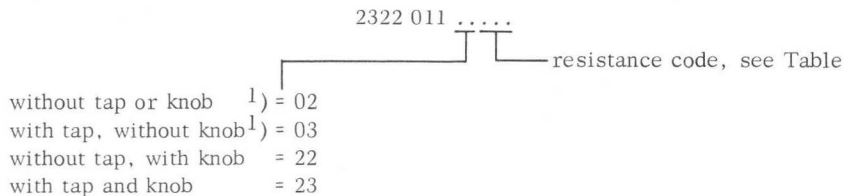

¹⁾ Knobs are available under catalogue number 4322 048 20550.

WIRE-WOUND POTENTIOMETERS

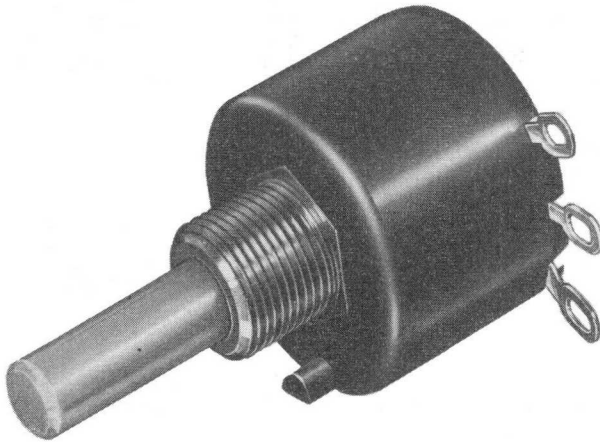

RZ 26297-1

Linear resistance law

Resistance range

2.2-22 000 Ω

Maximum permissible dissipation at 70 °C

1 W

Potentiometers 2322 012.....

provided with a plastic spindle ←

Potentiometers 2322 013.....

provided with a steel spindle

APPLICATION

In professional electric and electronic equipment where accurate and gradual resistance regulation and high stability are required.

CONSTRUCTION

The potentiometer consists of a single layer of resistance wire wound on a strip of resin-bonded paper and housed in a dust-proof case of black plastic material. The resilient slider is affixed to the spindle; a stop prevents the slider from overrunning the resistance element, and the contact between resistance wire and slider is preserved over the entire angle of rotation, so as ensure minimum wear.

Dimensions in mm

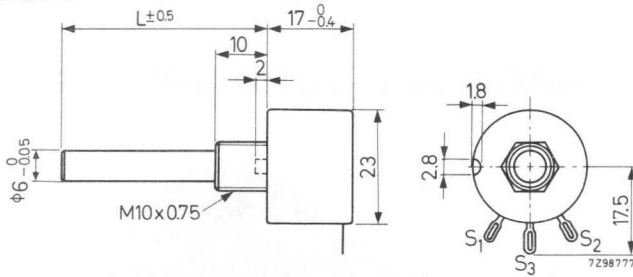

a. Potentiometer with a spindle suited for knob adjustment.
For spindle length L, see section "TYPES".

b. Spindle with screwdriver slot (spindle fully counter clockwise)



Fig.1. Potentiometers 2322 012..... and 2322 013..... and their spindle types.

S₁ and S₂ are connected to the ends of the resistance wire; S₃ is connected to the slider contact.

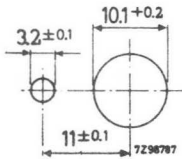

With the supplied cadmium-plated steel mounting nut, catalog number 2522 500 02011, the potentiometers can be fixed on the chassis.

Fig.2. Mounting holes

TECHNICAL PERFORMANCE

Nominal resistance values (R_n), measured between the tags S₁ and S₂ (see figure above)

see Table

Tolerance on the nominal resistance

for $R_n \leq 47 \Omega$

$\pm 10\%$

for $R_n > 47 \Omega$

$\pm 5\%$ and $\pm 10\%$

Resistance law

linear

Tolerance on the resistance law

$\pm 2\%$ of R_n

Contact resistance

see Fig.3

Change of contact resistance

$\leq 300 \text{ m}\Omega$

Maximum permissible dissipation at an ambient temperature of 70°C (P_n)

1 W

at another ambient temperature (P)

see Fig.4

Temperature coefficient of the resistance

see Table 1

Insulation resistance between bushing and contacts

$> 1000 \text{ M}\Omega$

Test voltage between bushing and contacts for 1 min	2000 V, 50 Hz	
Maximum working voltage between bushing and contacts	1000 V _p	
Working-temperature range	-10 to +100 °C	
Climatic robustness	category 10/100/21 (I.E.C. 68)	
Number of windings	see Table	
Effective angle of rotation	245 ± 5°	←
Mechanical angle of rotation	270 ± 5°	←
Operating torque	0.3-2 Ncm	
End stop torque	≤ 80 Ncm	
Maximum axial spindle load	100 N	
Life, for R _n ≤ 3.3 kΩ	in excess of 25 000 cycles	←
for R _n > 3.3 kΩ	in excess of 10 000 cycles	←

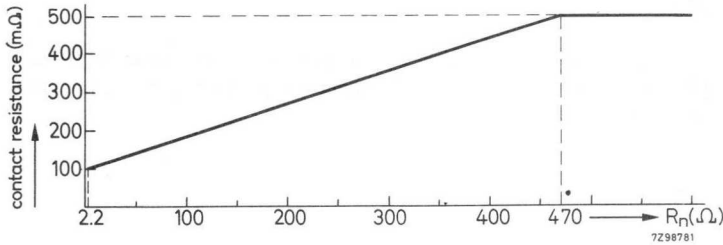

Fig.3 Contact resistance as a function of the nominal resistance.

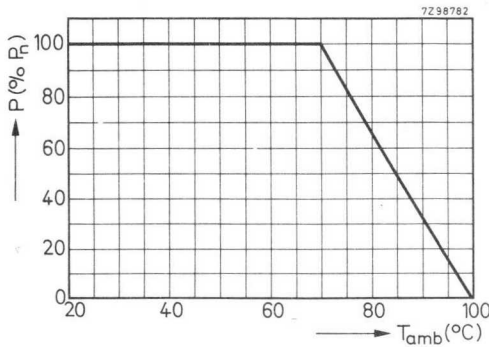

Fig.4 Dissipation as a function of the ambient temperature

→ TYPES

Composition of the catalog number 2322 01.

figure indicating the spindle material

2 = plastic

3 = steel

figure indicating the spindle type

0 = spindle suited for screwdriver adjustment;
length 14 mm

2 = length 17 mm

3 = length 25 mm

4 = length 50 mm

5 = length 60 mm

6 = length 20 mm

7 = length 30 mm

spindle
suited for
knob
adjustment

... ..

code for resistance value,
see Table

figure indicating the toler-
ance

1 = $\pm 10\%$

2 = $\pm 5\%$ ($R_n > 47 \Omega$)

Example: for a potentiometer with a nominal resistance value of 10Ω , tolerance $\pm 10\%$ for screwdriver adjustment, with a plastic spindle, the catalog number is 2322 012 01109.

Table

resistance value in Ω	temperature coefficient in $10^{-6}/\text{deg C}$	number of windings $\pm 25\%$	code in catalog number
2.2	0 to +600	47	228
3.3		70	338
4.7		63	478
6.8		90	688
10		85	109
15		127	159
22	-25 to +25	62	229
33		94	339
47		83	479
68		120	689
100		106	101
150		103	151
220	0 to +140	109	221
330		104	331
470		148	471
680		131	681
1 000		193	102
1 500		187	152
2 200		275	222
3 300		260	332
4 700		369	472
6 800	342	682	
10 000	-20 to +140	405	103
15 000		375	153
22 000		550	223

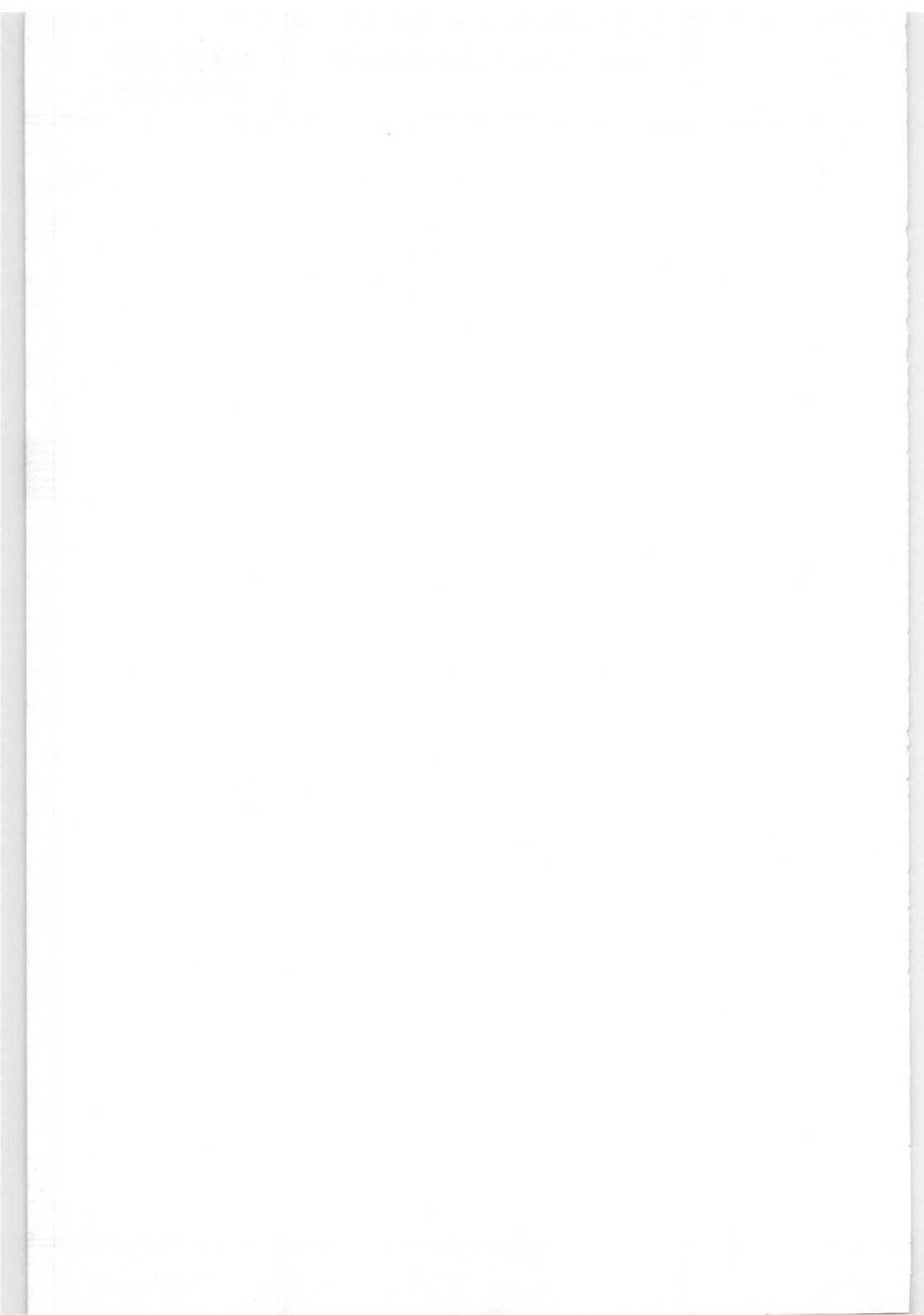

LOAD POTENTIOMETERS

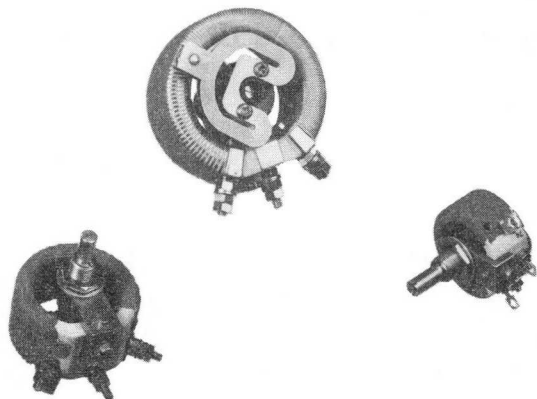

RZ 25706-9

Resistance range
Maximum permissible dissipation at 60 °C

0.5 Ω to 10 k Ω
25, 40, 100 W

APPLICATION

In electric and electronic equipment where current or voltage must be regulated continuously, e.g. control of motor speeds and control of charging current of batteries.

CONSTRUCTION

The potentiometers consist of a ceramic ring A (see figures on next pages) around which a resistance wire or ribbon (consult the Table) has been wound in a single layer - over about 280° in the case of 100 W items, and over about 250° for the other ratings. A terminal B is fitted at each end of the wire or ribbon. With the exception of the top side of the coil, the resistance element is coated with a protective layer of cement which prevents the windings from shifting. The cement is non-inflammable (melting point about 2000 °C).

A carbon brush C is affixed in a double spring-type runner E, the brush being connected to a terminal F through the intermediary of a double sliding-contact. The spring-pressures of the sliding contact and of the carbon brush are independent of each other. In the case of resistance ribbon, the runner of the 40 W and 100 W potentiometers is equipped with an extra spring having a height of 2 and 3 mm, respectively.

By means of an insulating piece G and a central screw H, the runner is affixed to the top of a spindle J which is supported in a sturdy bracket K. A stop prevents the runner from overrunning the track, whereby the runner is not exposed to torsion.

The protrusion N prevents the potentiometers from turning.

All the metal parts are non-corrosive.

The potentiometers are suitable to be ganged (see section "Ganging").

Dimensions in mm

The spindle length L is 17 or 36 mm.

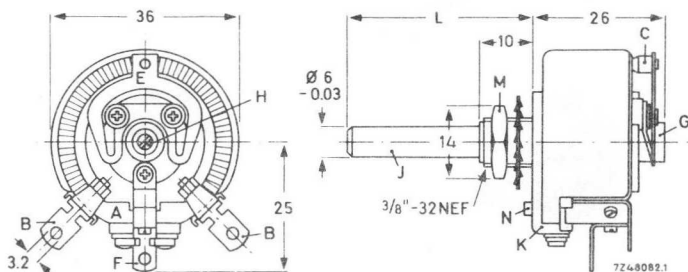

Fig.1. Potentiometers 2322 095;
1 Ω to 7.5 k Ω , 25 W

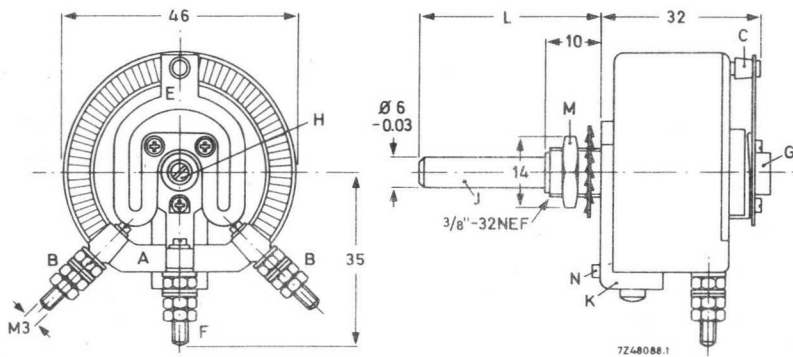

Fig.2. Potentiometers 2322 096;
0.5 Ω to 10 k Ω , 40 W

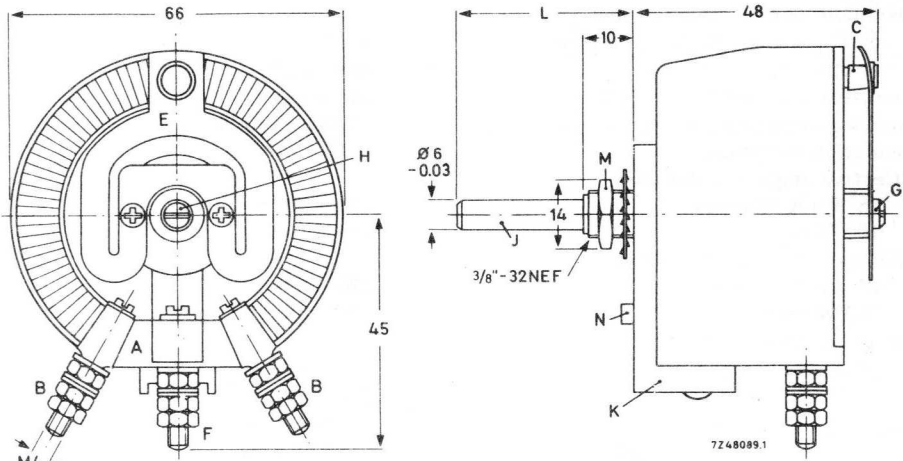

Fig.3. Potentiometers 2322 097;
0.75 Ω to 10 k Ω , 100 W

Mounting and weight

type	a	b	c	panel thickness maximum	weight g
2322 095	10.5	3.5	13.5	5	60
096	10.5	4.8	20	5	95
097	10.5	4.8	20	5	240

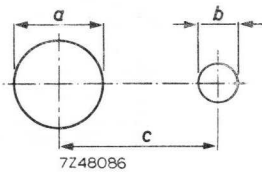

Fig.4. Holes for mounting with supplied nut

TECHNICAL PERFORMANCE

Nominal resistance values (R_n)
measured between end tags

at $P \leq 0.1 P_n$

Tolerance on R_n

Resistance law

Temperature coefficient of the resistance

Maximum permissible dissipation

at $T_{amb} = 60 \text{ }^\circ\text{C}$ (P_n)

see Table

$\pm 10\%$

linear

$(-140 \text{ to } +140) 10^{-6}/\text{deg C}$

see Table

Maximum permissible current
at $T_{amb} = 60\text{ }^{\circ}\text{C}$ ($I_{max} = \sqrt{\frac{P_n}{R}}$)
at other temperatures

Temperature rise ΔT as f (P)

Working-temperature range

Insulation resistance

Effective angle of rotation

25 W, 40 W types

100 W type

Mechanical angle of rotation

25 W, 40 W types

100 W type

Operating torque

25 W, 40 W types

100 W type

End stop torque

Maximum axial spindle load

Life at maximum current

see Table

see Fig.5

see Fig.6

-55 to +100 $^{\circ}\text{C}$

> 100 M Ω

250 \pm 10 $^{\circ}$

280 \pm 10 $^{\circ}$

270 \pm 5 $^{\circ}$

300 \pm 5 $^{\circ}$

1 - 4.5 Ncm

8 - 13 Ncm

\leq 200 Ncm

100 Ncm

> 50 000 cycles

Fig.5

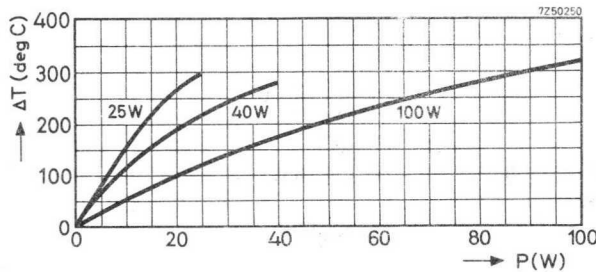
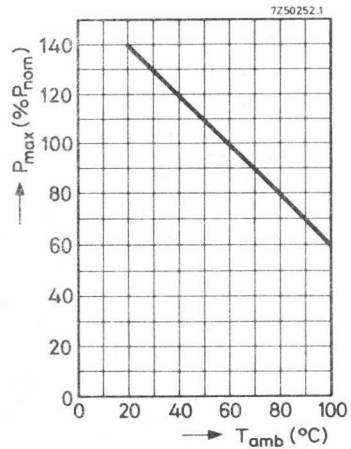

Fig.6

TYPES

Only the types for which I_{max} is listed in the table are available. If I_{max} is stated above the dashed line, the potentiometer is equipped with resistance ribbon.

Table

R_n (Ω)	$P_n = 25$ W		$P_n = 40$ W		$P_n = 100$ W		code in catalog number
	I_{max} (A)	number of windings	I_{max} (A)	number of windings	I_{max} (A)	number of windings	
0.5			8.9	14			507
0.75			7.3	13	11.5	23	757
1	5.0	23	6.3	14	10.0	24	108
1.5	4.0	22	5.15	21	8.15	23	158
2	3.5	23	4.45	28	7.05	24	208
2.5	3.15	22	4.0	23	6.3	32	258
3.5	2.65	23	3.35	28	5.35	42	358
5	2.2	20	2.8	25	4.45	47	508
7.5	1.8	30	2.3	23	3.65	45	758
10	1.55	41	2.0	24	3.15	43	109
15	1.3	39	1.6	27	2.55	40	159
20	1.1	37	1.4	50	2.2	43	209
25	1.0	46	1.25	49	2.0	44	259
35	0.84	60	1.07	49	1.7	75	359
50	0.70	86	0.89	105	1.4	86	509
75	0.58	82	0.73	99	1.15	75	759
100	0.50	109	0.63	132	1.0	143	101
150	0.40	103	0.51	125	0.81	135	151
200	0.35	137	0.44	105	0.70	180	201
250	0.31	108	0.40	132	0.63	142	251
350	0.26	151	0.33	184	0.53	199	351
500	0.22	136	0.28	165	0.44	179	501
750	0.18	204	0.23	157	0.36	268	751
1 000	0.15	172	0.20	210	0.31	226	102
1 500	0.13	258	0.16	214	0.25	340	152
2 000	0.11	345	0.14	286	0.22	286	202
2 500	0.10	272	0.12	357	0.20	357	252
3 500	0.08	380	0.10	392	0.17	316	352
5 000	0.07	343	0.09	417	0.14	450	502
7 500	0.06	513	0.07	395	0.11	428	752
10 000			0.06	528	0.10	570	103

Note - Spare carbon brushes can be supplied under catalog number

- 4322 048 03670 for 25 W types,
- 4322 048 01710 for 40 W types, $R_n \leq 10 \Omega$,
- 4322 048 03530 for 40 W types, $R_n > 10 \Omega$,
- 4322 048 03540 for 100 W types.

COMPOSITION OF THE CATALOG NUMBER

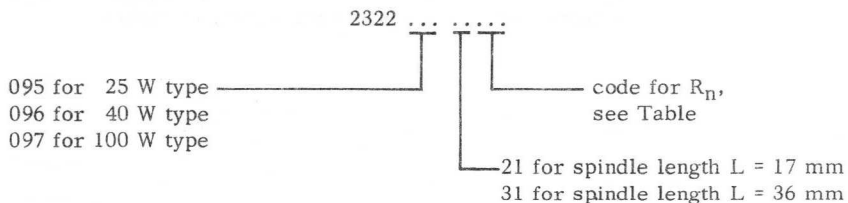

GANGING

For ganging two load potentiometers, sets are available for the coupling of two items and comprising the following parts (see Fig.7), packed in a plastic bag:

- 1 bracket D,
- 1 threaded spindle B,
- 1 cross pin C,
- 1 coupling E,
- 2 set screws K,
- retaining rings

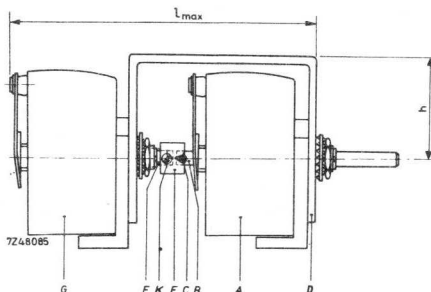

Fig.7

The catalog numbers for ordering these sets and the dimensions are:

potentiometers	catalog number coupling set	l_{max} (mm)	h (mm)
25 W 2322 095 21... + 2322 095	4322 048 06480	83	22
40 W 2322 096 21... + 2322 096	4322 048 06490	95.5	29.5
100 W 2322 097 21... + 2322 097	4322 048 06500	129.5	40

Ganging procedure (see Fig.7)

The central screw H (Figs.1-3) is removed from the potentiometer A and replaced by spindle B having a threaded end that is firmly tightened; the other extremity of B is provided with the round cross-pin C. Thereupon, potentiometer A is attached to the bracket D by means of the hexogonal nut, and coupling E is slipped over the extruding end of B.

The second potentiometer (G) having a spindle (F) with standard length $L = 17$ mm, is now attached to the bracket as well. After placing the runners of both potentiometers in the same position, the coupling is affixed to F by means of the two radial set screws K in the coupling.

When the spindle of potentiometer A is rotated, potentiometer G rotates simultaneously through the intermediary of cross pin C and a V-shaped groove in the coupling. The potentiometers and the coupling should be adjusted so as to obtain a smoothly running assembly.

Mounting

The front face of bracket D is equipped with two 4 mm threaded holes, which allow of fitting two screws through the mounting panel to prevent the ganged assembly from turning when being attached. In this connection, the panel should be provided with apertures according to Fig.8.

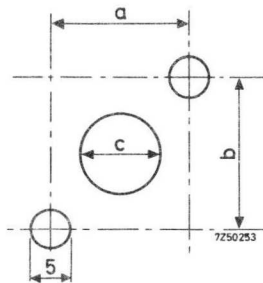

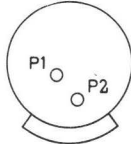
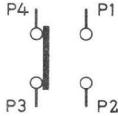
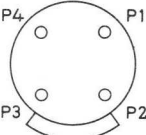
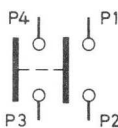
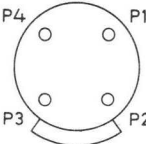
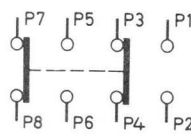
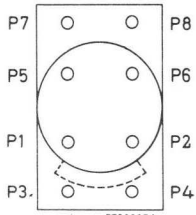

Fig.8

	dimensions in mm			
	a	b	c	panel thickness
25 W	18	20	10.5	≤ 3
40 W	18	30	10.5	≤ 3
100 W	22	30	10.5	≤ 2

CIRCUIT AND CONNECTIONS OF THE SWITCHES

description	circuit in "off"-position of spindle 1)	position of terminals
Single-pole, single throw (s.p.s.t.) rotary switch		
Single-pole, double throw (s.p.d.t.) rotary switch		
Double-pole, single throw (d.p.s.t.) rotary or push-pull switch		
Double-pole, double throw (d.p.d.t.) push-pull switch		 <p style="text-align: center; font-size: small;">7298027.1</p>

1) Spindle turned fully counter clockwise for rotary switches or pushed in for push-pull switches.

UNIVERSITY OF TORONTO
LIBRARY

UNIVERSITY OF TORONTO
LIBRARY

Dimensions in mm (plastic spindles)

The Figs 1a to 1f show the potentiometer types with a plain plastic spindle and with soldering tags. For the dimensions L and d see Table 1.

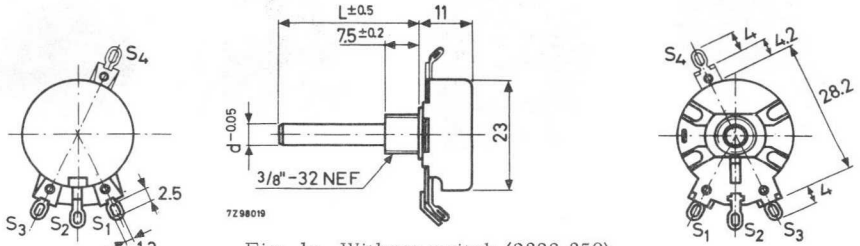

Fig. 1a. Without switch (2322 350)

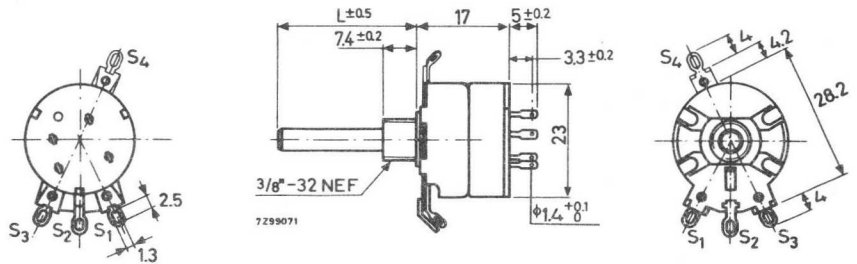

Fig. 1b. With single-pole, double throw rotary switch (2322 352)

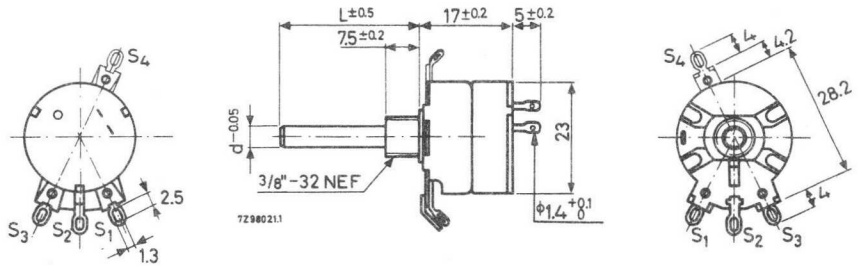

Fig. 1c. With single-pole, single throw rotary switch (2322 353)

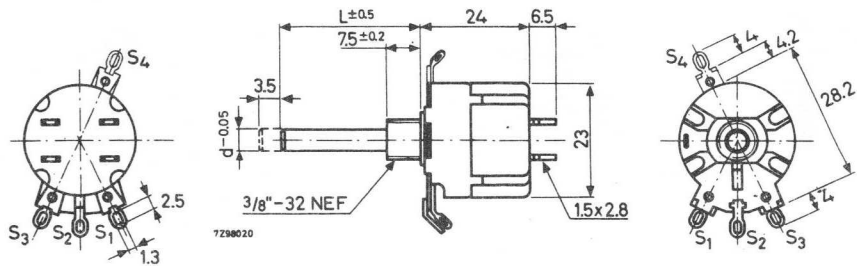

Fig. 1d. With double-pole, single throw push-pull switch (2322 354, 2322 355)

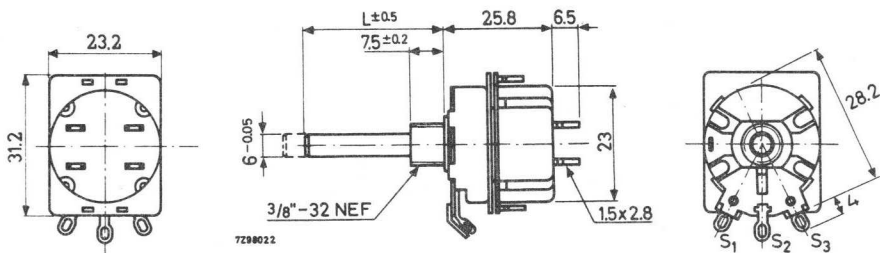

Fig. 1e. With double-pole, double throw push-pull switch (2322 356)

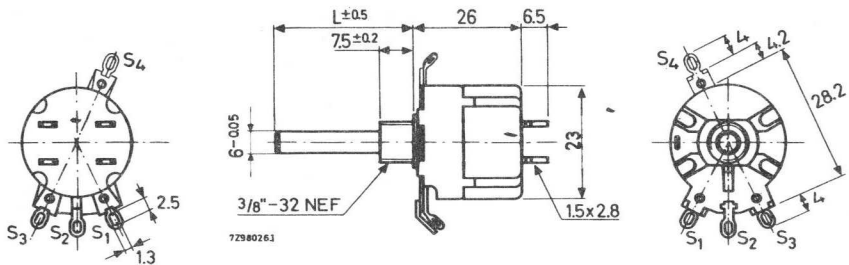

Fig. 1f. With double-pole, single throw rotary switch (2322 357)

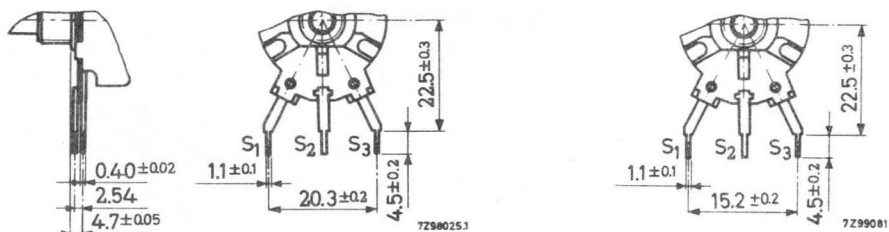

Fig. 2. Detail showing pins for printed-wiring (applicable to all types) Potentiometers with a distance between S_1 and S_3 of 15.2 mm (6e) instead of 20.3 mm (8e) are available on request (e = 0.1 inch).

Spindle types (type b is not applicable with a push-pull switch):

(a) Plain spindle, see Fig.1 and Table 1

(b) Spindle with screwdriver slot



(c) Short spindle with flat face



(d) Long spindle with flat face
For L see Table 1.

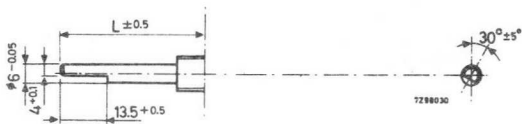

(e) Knurled spindle
For L see Table 1.



Fig. 3. Plastic spindles in fully counter clockwise position ("off" position for rotary switches)

CHASSIS MOUNTING

The potentiometers can be fixed to a chassis with the supplied mounting nut; for mounting holes, see Fig. 4. The minimum thickness of the chassis is 1.5 mm. The maximum torque for tightening the nut is 350 Ncm.

Potentiometers with twist tags for mounting, which are available on request, are fixed by twisting the tags; for mounting holes, see Fig. 5.

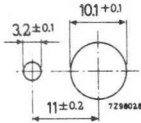

Fig. 4

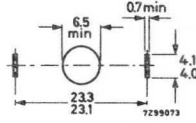

Fig. 5

TYPES

Composition of the catalogue number

2322 35.

- figure indicating the type
- 0 = without switch
 - 2 = with s.p.d.t. rotary switch
 - 3 = with s.p.s.t. rotary switch
 - 4 = with d.p.s.t. push-pull switch
1A
 - 5 = with d.p.s.t. push-pull switch,
2A
 - 6 = with d.p.d.t. push-pull switch
 - 7 = with d.p.s.t. rotary switch

code for resistance law and resistance value, see Tables 2 and 3

code for spindle type and terminals, see Table 1

Table 1

plastic spindle type (Fig. 3)	8th to 10th figure of catalogue number	
	tags (Fig. 1)	pins (Fig. 2)
(a) plain, d = 6 mm, L = 18 mm	706	756
L = 30 mm	703	753
L = 60 mm	707	757
(a) plain, d = 1/4", L = 30 mm	723	773
L = 60 mm	727	777
(b) with screwdriver slot ¹⁾	710	760
(c) short spindle with flat face	740	790
(d) long spindle with flat face		
L = 30 mm	743	793
L = 60 mm	747	797
(e) knurled spindle, L = 30 mm	to be established	
L = 60 mm	to be established	

¹⁾ Not for potentiometers with a push-pull switch

TECHNICAL PERFORMANCE

Potentiometers (Data applicable to all types)

Table 2 - Linear resistance law

nom. resistance value (R_n)*	curve Fig.6	I_{max} through slider contact (mA)	code in catalogue number
220 Ω	a	40	02
300 Ω	a	30	19
470 Ω	a	22	03
1 $k\Omega$	a	16	04
2.2 $k\Omega$	a	11	05
4.7 $k\Omega$	a	7	06
10 $k\Omega$	a	5	07
22 $k\Omega$	a	3.5	08
47 $k\Omega$	a	2	09
100 $k\Omega$	a	1.4	11
220 $k\Omega$	a	1	12
470 $k\Omega$	a	0.65	13
1 $M\Omega$	a	0.45	14
2.2 $M\Omega$	a	0.32	15
4.7 $M\Omega$	a	0.22	16
400 + 600 $k\Omega$	e	0.45	89

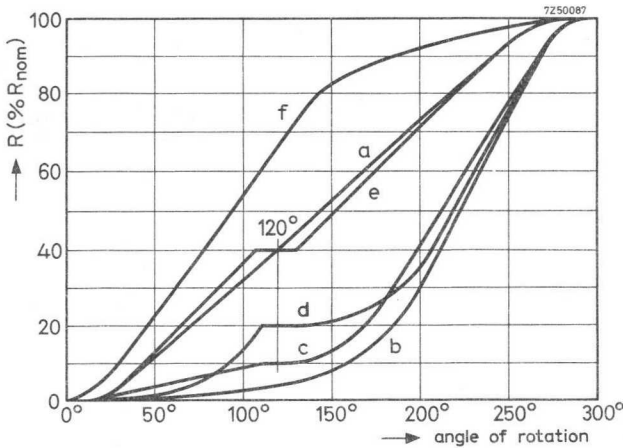

Fig.6. Resistance variation with the angle of rotation, measured between S_1 and S_2

*) Measured between S_1 and S_3 ; for potentiometers with a tap, between S_1 and S_4 and between S_4 and S_3 .

Table 3 - Logarithmic resistance law

nom. resistance value (R_N) 1)	curve Fig. 6	I_{max} through slider contact (mA)	min. resistance at the beginning (Ω)	code in catalogue number
1 k Ω	b	10	≤ 5	24
2.2 k Ω	b	7	≤ 5	25
4.7 k Ω	b	4.5	≤ 5	26
10 k Ω	b	3.2	≤ 10	27
22 k Ω	b	2.2	≤ 22	28
47 k Ω	b	1.4	≤ 35	29
100 k Ω	b	1	≤ 50	31
220 k Ω	b	0.7	≤ 50	32
470 k Ω	b	0.45	≤ 100	33
1 M Ω	b	0.32	≤ 500	34
2.2 M Ω	b	0.22	≤ 2200	35
300 Ω	f 2)	20	≤ 5	59
470 Ω	f 2)	14	≤ 5	43
1 k Ω	f 2)	10	≤ 5	44
2.2 k Ω	f 2)	7	≤ 5	45
4.7 k Ω	f 2)	4.5	≤ 5	46
10 k Ω	f 2)	3.2	≤ 10	47
22 k Ω	f 2)	2.2	≤ 22	48
47 k Ω	f 2)	1.4	≤ 35	49
100 k Ω	f 2)	1	≤ 50	51
220 k Ω	f 2)	0.7	≤ 50	52
470 k Ω	f 2)	0.45	≤ 100	53
1 M Ω	f 2)	0.32	≤ 500	54
2.2 M Ω	f 2)	0.22	≤ 2200	55
20 + 200 k Ω	c	0.7	≤ 220	67
50 + 420 k Ω	c	0.45	≤ 470	73
100 + 900 k Ω	c	0.32	≤ 1000	64
0.2 + 2 M Ω	c	0.22	≤ 2200	68
0.5 + 1.7 k Ω	d	7	≤ 5	81
5 + 17 k Ω	d	2.2	≤ 22	82
10 + 37 k Ω	d	1.4	≤ 50	86
20 + 80 k Ω	d	1	≤ 100	77
50 + 170 k Ω	d	0.7	≤ 220	83
100 + 370 k Ω	d	0.45	≤ 500	87
200 + 800 k Ω	d	0.32	≤ 1000	78
0.5 + 1.7 M Ω	d	0.22	≤ 2200	84

1) Measured between S_1 and S_3 ; for potentiometers with a tap, between S_1 and S_4 and between S_4 and S_3 .

2) Negative logarithmic.

3) Minimum resistance values (in Ω) at the end.

Potentiometers with single-pole rotary switch (2322 352 and 2322 353)

Breaking capacity	250 V _{ac} , 0.5 A, cos φ = 0.9 125 V _{ac} , 1 A, cos φ = 0.9 2000 V, 50 Hz
Test voltage for 1 min*, initially after damp heat test (21 days, T _{amb} = 40 °C, R.H. = 90-95%)	500 V, 50 Hz
Contact resistance with a load of 250 V _{ac} , 0.5 A, initially after 10 000 on-off switching operations with a load of 125 V _{ac} , 1 A	< 25 m Ω \leq 200 m Ω (average value: \leq 100 m Ω)
Insulation resistance *, initially after damp heat test (21 days, T _{amb} = 40 °C, R.H. = 90-95%)	> 100 M Ω > 2 M Ω
Permissible axial spindle load	\leq 100 N
Switching torque	4-8 Ncm
Switching angle	20 \pm 2°
Total angle of rotation	300 \pm 5°

See also section "Potentiometers".

Potentiometers with double-pole rotary switch (2322 357)

Breaking capacity	250 V _{ac} , 1.5 A, cos φ = 0.8 250 V _{dc} , 1.5 A
Test voltage for 1 min*	2000 V, 50 Hz
Contact resistance, initially after 10 000 on-off switching operations	< 10 m Ω < 200 m Ω
Insulation resistance*, initially after damp heat test (21 days, T _{amb} = 40 °C, R.H. = 90-95%)	> 100 M Ω > 2 M Ω
Permissible axial spindle load	\leq 100 N
Switching torque	4-8 Ncm
Switching angle	25-35°
Total angle of rotation	300 \pm 5°
Creepage paths and clearances	\geq 4 mm

See also section "Potentiometers".

*) Measured between the terminals and between the case or spindle and interconnected terminals.

Potentiometers with single throw push-pull switch (2322 354, 2322 355)

Breaking capacity	
potentiometers 2322 354	250 V _{ac} , 1 A, cos φ = 0.8 250 V _{dc} , 1 A
potentiometers 2322 355	250 V _{ac} , 2 A, cos φ = 0.8 250 V _{dc} , 2 A
Test voltage for 1 min*	2 200 V, 50 Hz
Contact resistance, initially	< 10 mΩ
after 10 000 on-off switching operations	< 200 mΩ
Insulation resistance*, initially	> 100 MΩ
after damp heat test (21 days, T _{amb} = 40 °C, R.H. = 90 - 95%)	> 2 MΩ
Permissible axial spindle load	≤ 100 N
Switching force	
potentiometers 2322 354	1.6 - 2.3 N
potentiometers 2322 355	3.5 - 4.5 N
Switching stroke	3.5 mm
Mechanical angle of rotation	302 ± 5°
Tangential backlash	≤ 9°

See also section "Potentiometers".

Potentiometers with double throw push-pull switch (2322 356)

Breaking capacity	250 V _{ac} , 0.5 A, cos φ = 0.9 125 V _{ac} , 1 A, cos φ = 0.9
Terminal to case test voltage for 1 min	500 V _{ac}
Contact resistance, initially	< 10 mΩ
after 10 000 on-off switching operations	< 200 mΩ
Insulation resistance*, initially	> 100 MΩ
after damp heat test (21 days, T _{amb} = 40 °C, R.H. = 90 - 95%)	> 2 MΩ
Permissible axial spindle load	≤ 50 N
Switching force	2 - 3.5 N
Switching stroke	3.5 mm
Mechanical angle of rotation	302 ± 5°
Tangential backlash	≤ 9°

See also section "Potentiometers".

*) Measured between the terminals and between the case or spindle and interconnected terminals.

23 mm TANDEM CARBON POTENTIOMETERS

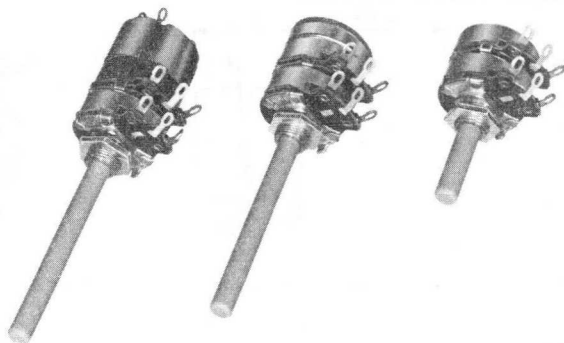

RZ 27317-13

Resistance range

linear resistance law

1 k Ω - 4.7 M Ω

logarithmic resistance law

1 k Ω - 2.2 M Ω

Maximum permissible dissipation

linear resistance law, at 40 °C

0.25 W

at 70 °C

0.125 W

logarithmic resistance law, at 40 °C

0.125 W

at 70 °C

0.0625 W

Potentiometers 2322 360

without switch

2322 362

with s.p.s.t. rotary switch

2322 364

with d.p.s.t. push-pull switch, 1A

2322 365

with d.p.s.t. push-pull switch, 2A

2322 366

with d.p.s.t. rotary switch

APPLICATION

For use in a wide variety of electronic equipment, especially for stereophonic applications

CONSTRUCTION

The tandem potentiometers are composed of two single potentiometers which are ganged; their resistance values and gradings are as identical as possible. Both potentiometers consist of an annular carbon track, which is fitted on to a base plate of resin bonded paper and housed in a metal case.

The terminals S_1 and S_3 (see Figs 1 and 2) are connected to the ends of the carbon track; S_2 is connected, via a contact ring, to the slider contact.

The potentiometers can be supplied with a tap (S_4) at 40% of the total mechanical angle of rotation, that is to say at 40% of the nominal resistance value for potentiometers with linear resistance law and at 20% or at 10% of the nominal resistance value for potentiometers with logarithmic resistance law.

The material of the spindle may be poly-acetal resin (preferred types) or steel; the terminals of the potentiometer may be pins for vertical mounting on printed-wiring boards or soldering tags.

The potentiometers are provided with a mounting bushing; types with twist tags are available on request.

Dimensions in mm (plastic spindles)

For the dimensions L and d, see Table 1.

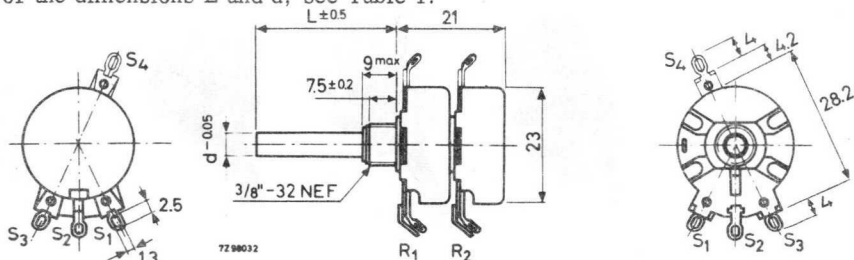

Fig. 1a. Potentiometers without switch, plain spindle, soldering tags (2322 360)

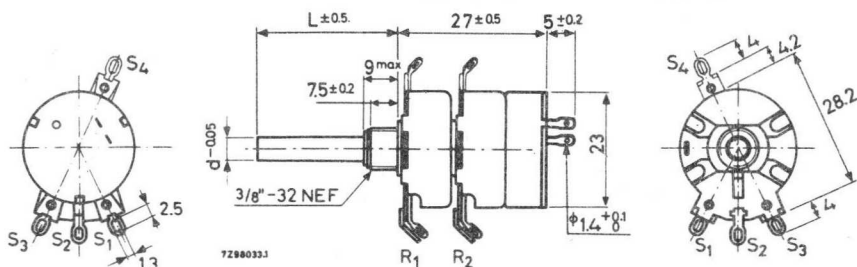

Fig. 1b. Potentiometers with s.p.s.t. rotary switch, plain spindle, soldering tags (2322 362)

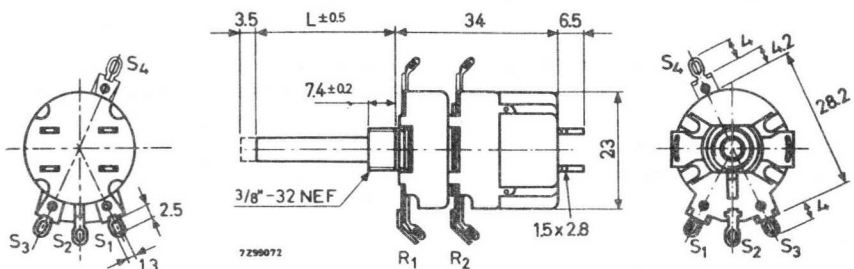

Fig. 1c. Potentiometers with d.p.s.t. push-pull switch, plain spindle, soldering tags (2322 364, 2322 365)

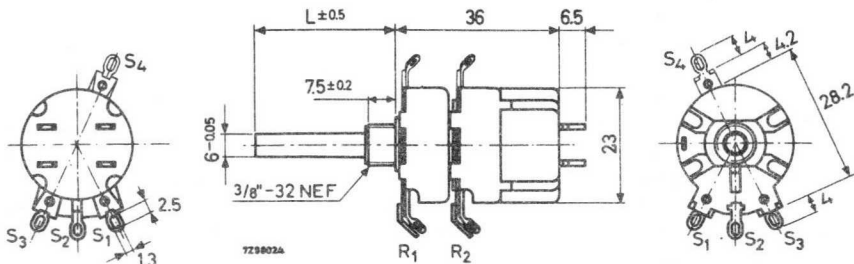

Fig. 1d. Potentiometers with d.p.s.t. rotary switch, plain spindle, soldering tags (2322 366)

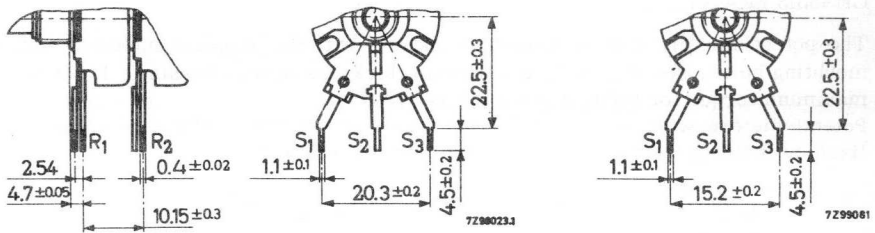

Fig. 2. Detail showing pins for printed-wiring (applicable to all types). Potentiometers with a distance between S₁ and S₃ of 15.2 mm (6e) instead of 20.3 mm (8e) are available on request (e = 0.1 inch).

Spindle types

(a) Plain spindle, see Fig.1 and Table 1

(b) Spindle with screwdriver slot



(c) Short spindle with flat face



(d) Long spindle with flat face
For L see Table 1

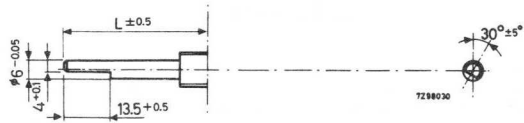

(e) Knurled spindle
For L see Table 1



Fig. 3. Spindles in fully counter clockwise position ("off" position)

CHASSIS MOUNTING

The potentiometers can be fixed to a chassis with the supplied mounting nut; for mounting holes, see Fig. 4. The minimum thickness of the chassis is 1.5 mm. The maximum torque for tightening the nut is 350 Ncm.

Potentiometers with twist tags for mounting, which are available on request, are fixed by twisting the tags; for mounting holes, see Fig. 5.

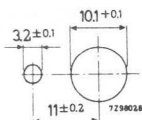

Fig. 4

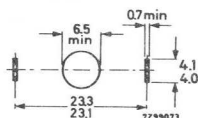

Fig. 5

TYPES

Composition of the catalogue number

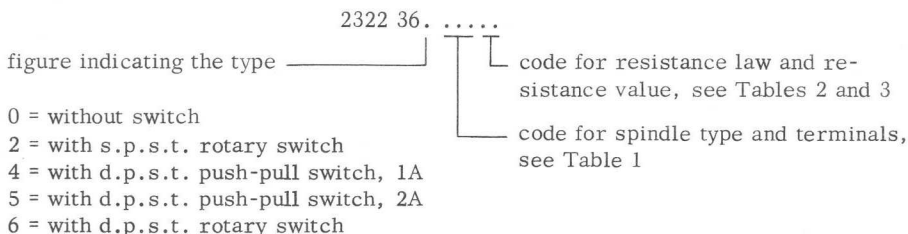

Table 1

plastic spindle type (Fig. 3)	8th to 10th figure of the catalogue number	
	tags (Fig. 1)	pins (Fig. 2)
(a) plain, d = 6 mm, L = 18 mm	706	756
L = 30 mm	703	753
L = 60 mm	707	757
plain, d = 1/4", L = 30 mm	723	773
L = 60 mm	727	777
(b) with screwdriver slot ¹⁾	710	760
(c) short spindle with flat face	740	790
(d) long spindle with flat face, L = 30 mm	743	793
L = 60 mm	747	797
(e) knurled spindle, L = 30 mm	to be established	
L = 60 mm	to be established	

¹⁾ Not applicable to types 2322 364, 2322 365 and 2322 366.

TECHNICAL PERFORMANCE

Potentiometers (data applicable to all types)

Table 2 - Linear resistance law

nom. resistance value (R_{1n} and R_{2n} *)	curve, Fig. 6a and 6b	I_{max} through slider contact (mA)	code in catalogue number
1 k Ω	a	16	04
2.2 k Ω	a	11	05
4.7 k Ω	a	7	06
10 k Ω	a	5	07
22 k Ω	a	3.5	08
47 k Ω	a	2.2	09
100 k Ω	a	1.4	11
220 k Ω	a	1	12
470 k Ω	a	0.65	13
1 M Ω	a	0.45	14
2.2 M Ω	a	0.32	15
4.7 M Ω	a	0.22	16
400 + 600 k Ω	e	0.45	89
22 k Ω **)	g	3.5	92
47 k Ω **)	g	2.2	93
100 k Ω **)	g	1.4	94
220 k Ω **)	g	1	95
470 k Ω **)	g	0.65	96
1 M Ω **)	g	0.45	97

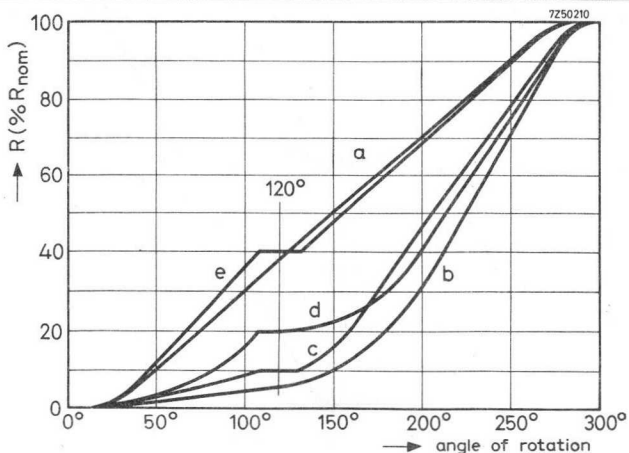

Fig. 6a

*) Measured between S_1 and S_3 ; for potentiometers with a tap, between S_1 and S_4 and between S_4 and S_3 .

**) Balance potentiometers.

Table 3 - Logarithmic resistance law

nom. resistance value (R_n and R_{2n} *)	curve Fig. 6a	I_{max} through slider contact	min. resistance at the beginning (Ω)	code in catalogue number
1 k Ω	b	10	≤ 5	24
2.2 k Ω	b	7	≤ 5	25
4.7 k Ω	b	4.5	≤ 5	26
10 k Ω	b	3.2	≤ 10	27
22 k Ω	b	2.2	≤ 22	28
47 k Ω	b	1.4	≤ 35	29
100 k Ω	b	1	≤ 50	31
220 k Ω	b	0.7	≤ 50	32
470 k Ω	b	0.45	≤ 100	33
1 M Ω	b	0.32	≤ 500	34
2.2 M Ω	b	0.22	≤ 2200	35
20 + 200 k Ω	c	0.7	≤ 220	67
50 + 420 k Ω	c	0.45	≤ 470	73
100 + 900 k Ω	c	0.32	≤ 1000	64
0.2 + 2 M Ω	c	0.22	≤ 2200	68
5 + 17 k Ω	d	2.2	≤ 22	82
10 + 37 k Ω	d	1.4	≤ 50	86
20 + 80 k Ω	d	1	≤ 100	77
50 + 170 k Ω	d	0.7	≤ 220	83
200 + 800 k Ω	d	0.32	≤ 1000	78
0.5 + 1.7 M Ω	d	0.22	≤ 2200	84

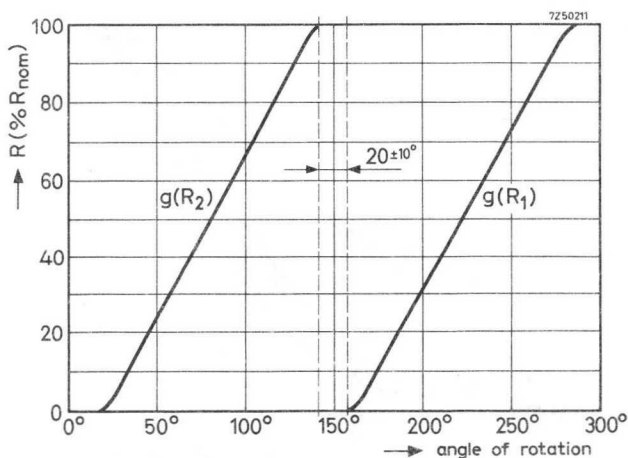

Fig. 6b

*) Measured between S_1 and S_3 ; for potentiometers with a tap, between S_1 and S_4 and between S_4 and S_3 .

Tolerance on the nominal resistance	$\pm 20\%$
Resistance law	linear and logarithmic, see Fig.6
Ganging tolerance	
linear resistance law	
at values between 10 and 90% of R_n	< 2 dB
with a tap at 40% and	
at attenuations between 0 and - 20 dB	< 2 dB
at attenuations between - 20 and - 28 dB	< 3 dB
logarithmic resistance law	
at attenuations between 0 and - 20 dB	< 2 dB
at attenuations between - 20 and - 30 dB	< 3 dB
at attenuations between - 30 and - 40 dB	< 4 dB
with a tap at 10% or 20% and	
at attenuations between 0 and - 20 dB	< 2 dB
at attenuations between - 20 and - 30 dB	< 3 dB
at attenuations between - 30 and - 34 dB	< 4 dB
Minimum resistance at the tap	$\leq 1\%$ of R_n
Contact resistance between carbon track and slider contact	
linear resistance law, $R_n \leq 4.7$ k Ω	$\leq 3\%$ of R_n
$R_n > 4.7$ k Ω	$\leq 2.5\%$ of R_n
with a tap at 40%	$\leq 3\%$ of R_n
logarithmic resistance law	$\leq 4\%$ of R_n
with a tap	$\leq 4\%$ of R_n
balance potentiometers	$\leq 4\%$ of R_n
Insulation resistance between case and inter- connected terminals after damp heat test (21 days, $T_{amb} = 40$ °C, R.H. = 90 -95%)	> 100 M Ω
Maximum permissible dissipation	
linear resistance law, at 40 °C	0.25 W
at 70 °C	0.125 W
logarithmic resistance law, at 40 °C	0.125 W
at 70 °C	0.0625 W
Test voltage for 1 min between case and interconnected terminals	1000 V, 50 Hz
Limiting voltage	500 V _p 500 V _{dc}
Working-temperature range	- 10 to + 70 °C
Category (I.E.C.68)	10/070/21
Effective angle of rotation	250 - 265°
Operating torque	0.7 - 3.5 Ncm
Permissible torque with slider at end stop	≤ 80 Ncm

Potentiometers without switch (2322 360)

Mechanical angle of rotation	$300 \pm 5^{\circ}$
Permissible axial spindle load	$\leq 100 \text{ N}$

See also section "Potentiometers".

Potentiometers with single-pole rotary switch (2322 362)

Breaking capacity	250 V _{ac} , 0.5 A, $\cos \varphi = 0.9$ 125 V _{ac} , 1 A, $\cos \varphi = 0.9$
Test voltage for 1 min *, initially after damp heat test (21 days, T _{amb} = 40 °C, R.H. = 90 - 95%)	2000 V, 50 Hz 500 V, 50 Hz
Contact resistance with a load of 250 V _{ac} , 0.5 A, initially after 10 000 on-off switching operations with a load of 125 V _{ac} , 1 A	$< 25 \text{ m}\Omega$ $\leq 200 \text{ m}\Omega$ (average value: $\leq 100 \text{ m}\Omega$) $> 100 \text{ M}\Omega$
Insulation resistance*, initially after damp heat test (21 days, T _{amb} = 40 °C, R.H. = 90 - 95%)	$> 2 \text{ M}\Omega$
Permissible axial spindle load	$\leq 100 \text{ N}$
Switching torque	4.5 - 9.5 Ncm
Switching angle	$20 \pm 2^{\circ}$
Total angle of rotation	$300 \pm 5^{\circ}$

See also section "Potentiometers".

*) Measured between the terminals and between the case or spindle and interconnected terminals.

Potentiometers with single throw push-pull switch (2322 364, 2322 365)

Breaking capacity	
potentiometers 2322 364	250 V _{ac} , 1 A, cos φ = 0.8 250 V _{dc} , 1 A
potentiometers 2322 365	250 V _{ac} , 2 A, cos φ = 0.8 250 V _{dc} , 2 A
Test voltage for 1 min*	2200 V, 50 Hz
Contact resistance, initially	< 10 mΩ
after 10 000 On-off switching operations	< 200 mΩ
Insulation resistance *, initially	> 100 MΩ
after damp heat test (21 days, T _{amb} = 40 °C, R.H. = 90 - 95%)	> 2 MΩ
Permissible axial spindle load	≤ 100 N
Switching force	
potentiometers 2322 364	1.6 - 2.3 N
potentiometers 2322 365	3.5 - 4.5 N
Switching stroke	3.5 mm
Mechanical angle of rotation	302 ± 5°
Tangential backlash	≤ 9°

See also section "Potentiometers".

Potentiometers with double-pole rotary switch (2322 366)

Breaking capacity	250 V _{ac} , 1.5 A, cos φ = 0.8 250 V _{dc} , 1.5 A
Test voltage for 1 min*	2000 V, 50 Hz
Contact resistance, initially	< 10 mΩ
after 10 000 on-off switching operations	< 200 mΩ
Insulation resistance *, initially	> 100 MΩ
after damp heat test (21 days, T _{amb} = 40 °C, R.H. = 90 - 95%)	> 2 MΩ
Switching torque	4-8 Ncm
Switching angle	25 - 35°
Total angle of rotation	300 ± 5°
Creepage paths and clearances	≥ 4 mm

See also section "Potentiometers".

*) Measured between the terminals and between the case or spindle and interconnected terminals.

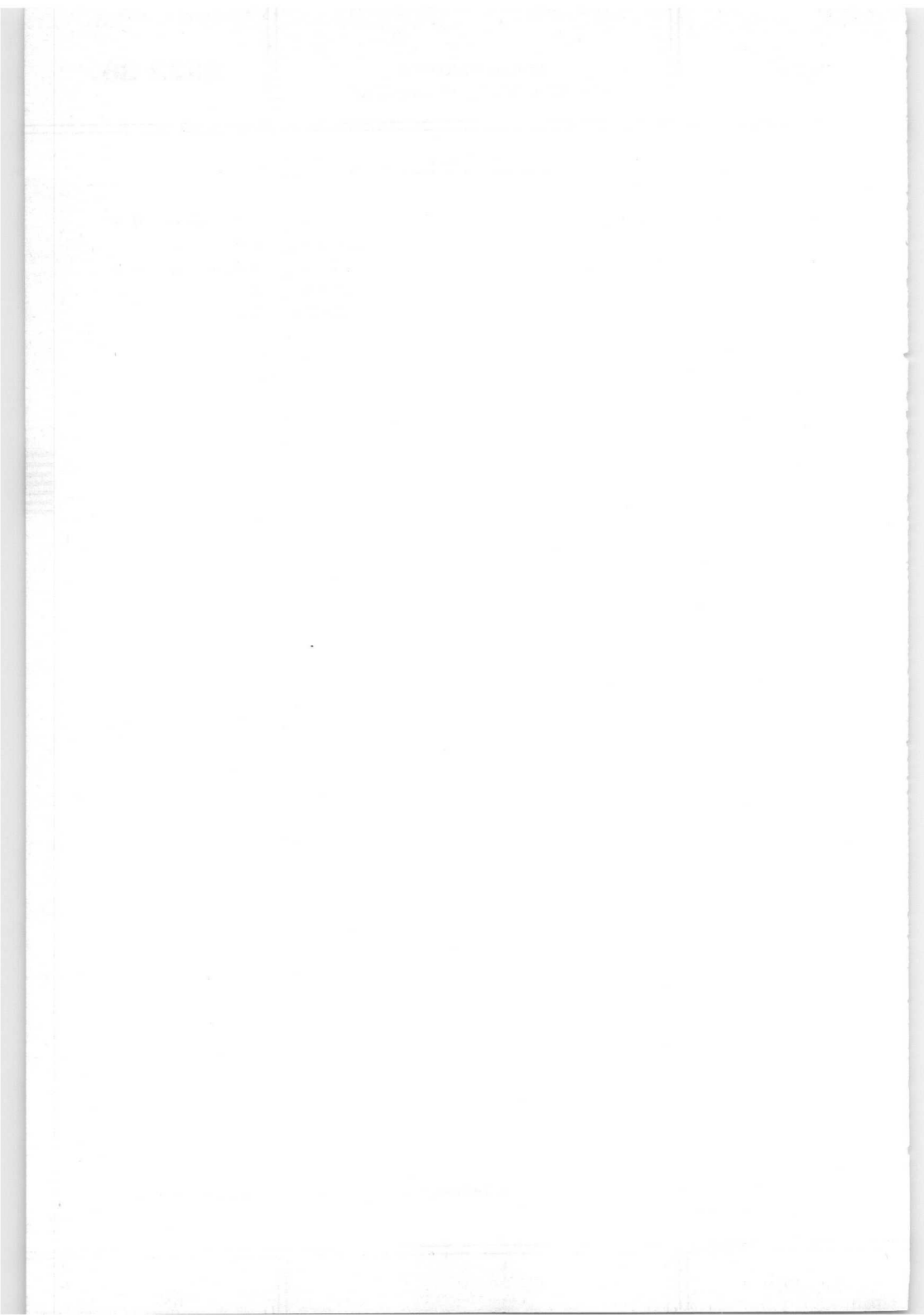

16 mm SINGLE CARBON POTENTIOMETERS

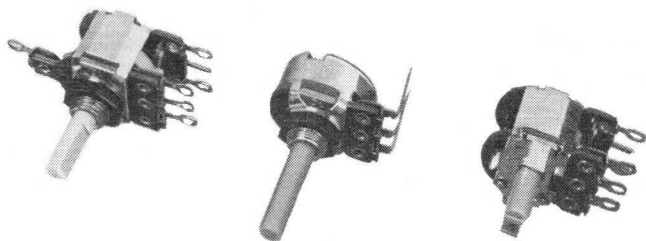

RZ 27512-4

Resistance law	linear and logarithmic
Resistance range	
linear resistance law	1 k Ω -2.2 M Ω
logarithmic resistance law	1 k Ω - 1 M Ω
Maximum permissible dissipation at 40 °C	
linear resistance law	0.1 W
logarithmic resistance law	0.05 W
Potentiometers 2322 380	without switch, with soldering tags or printed-wiring pins, with mounting bushing
2322 387	with s.p.s.t. rotary switch, with soldering tags or printed-wiring pins, with mounting bushing
2322 388	with s.p.s.t. rotary switch, with soldering tags or printed-wiring pins, with twist tags for mounting
2322 389	without switch, with bent printed-wiring pins, with mounting bushing

APPLICATION

For use in a wide variety of electronic equipment, especially in small transistor portable and car radio receivers.

CONSTRUCTION

An annular carbon track is fitted on to a base plate of resin bonded paper and housed in a metal case. The terminals S_1 and S_3 (see Fig.1) are connected to the ends of the carbon track; terminal S_2 is connected to the slider contact.

The potentiometers with logarithmic resistance law can be supplied with a tap (terminal S_4) at 10% or at 20% of the nominal resistance value.

The potentiometers are provided with plastic spindles of poly-acetal resin or with steel spindles ¹⁾. The plastic spindle forms one part with the rotor inside the potentiometer.

The potentiometers 2322 380, 2322 387 and 2322 388 are available with soldering tags suited for use in conventional wiring, as well as with pins suited for printed-wiring connection. The potentiometers 2322 389 are provided with bent pins for printed-wiring connection.

1) Potentiometers with plastic spindles are preferred types.

Dimensions in mm (plastic spindles)

For the dimensions L, see Table I

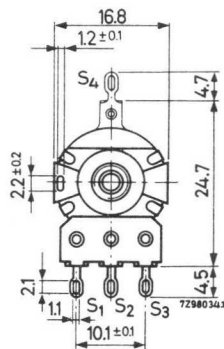
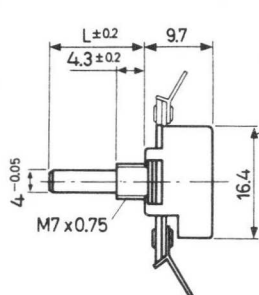
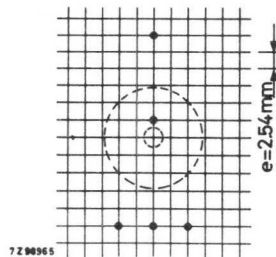
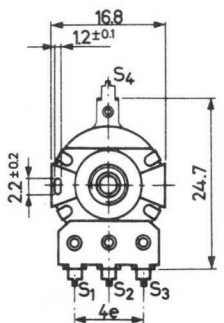
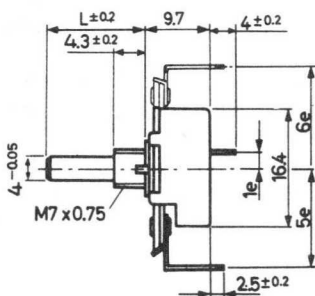

Fig. 1a. Potentiometers 2322 380 with soldering tags; plain spindle



72980365
Hole pattern for mounting on a printed-wiring board

Fig. 1b. Potentiometers 2322 389; plain spindle

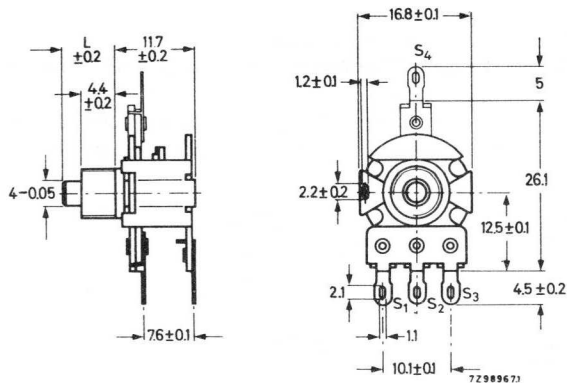
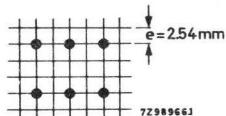
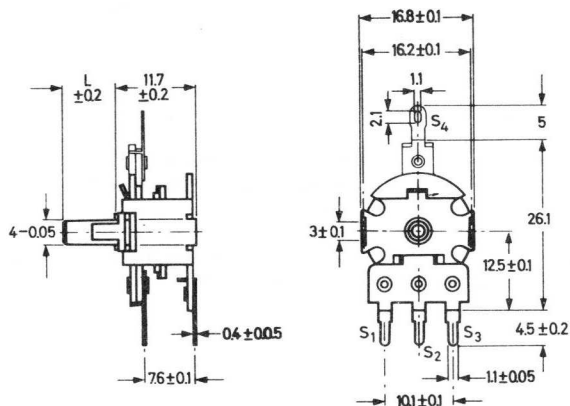

Fig. 1c. Potentiometers
2322 387
with soldering
tags;
plain spindle



Hole pattern for mount-
ing on a printed-wiring
board.

Fig. 1d. Potentiometers 2322 388 with pins for printed-wiring; plain spindle

Spindle types

(a) Plain spindle, see Fig. 1

(b) spindle with
screwdriver
slot

(c) spindle with
flat face

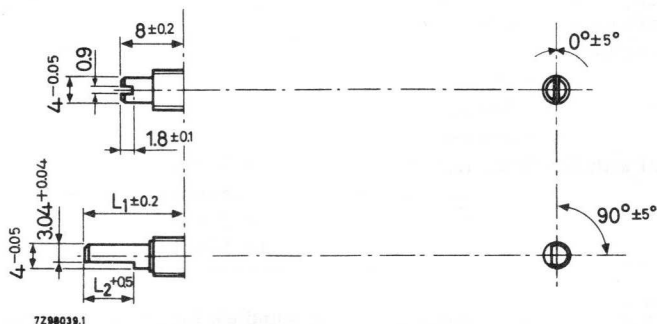

Fig. 2. Plastic spindles in fully counter clockwise position ("off" position)

CHASSIS MOUNTING

The required mounting holes in the chassis are given below:

- Fig. 3 for potentiometers with twist tags. The potentiometers can be fixed by twisting the tags.
- Fig. 4 for potentiometers with mounting bushings. The potentiometers can be fixed with the supplied mounting nut. The maximum torque for tightening the nut is 100 Ncm.

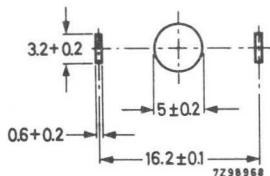

Fig. 3. Mounting holes for potentiometers with twist tags.

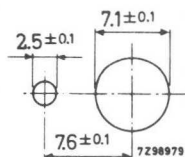

Fig. 4. Mounting holes for potentiometers with mounting bushings.

TYPES

Composition of the catalogue number

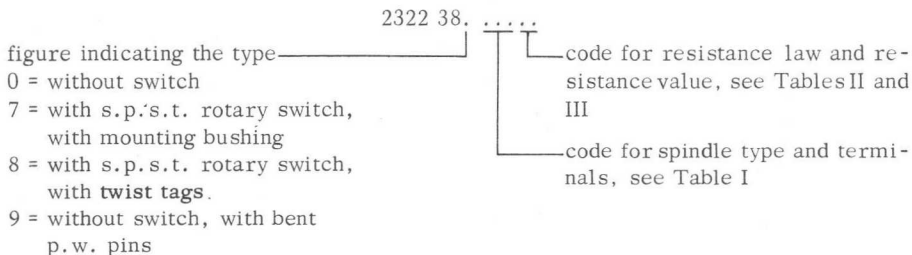

Table I

spindle type (Fig. 2)	8th to 10th figure of catalogue number ¹⁾	
	potentiometers with tags	potentiometers with pins
(b) with screwdriver slot	710	760
(a) plain, L = 10 mm	711	761
L = 15 mm	712	762
L = 20 mm	715	765
L = 30 mm	703	753
(c) with flat face, L ₁ = 10 mm, L ₂ = 3.5 mm	742	792
L ₁ = 15 mm, L ₂ = 8.5 mm	744	794
L ₁ = 20 mm, L ₂ = 8.5 mm	745	795
L ₁ = 20 mm, L ₂ = 13.5 mm	746	796

¹⁾ For the preferred types (plastic spindle); for potentiometers with a steel spindle the 8th figure is 0 instead of 7.

TECHNICAL PERFORMANCE

Potentiometers

Table II - Linear resistance law

nom. resistance value (R_{Ω}) ¹⁾	curve, Fig. 5	I_{max} through slider contact (mA)	code in catalogue number
1 k Ω	a	10	04
2.2 k Ω	a	7	05
4.7 k Ω	a	5	06
10 k Ω	a	3.2	07
22 k Ω	a	2.2	08
47 k Ω	a	1.5	09
100 k Ω	a	1	11
220 k Ω	a	0.7	12
470 k Ω	a	0.5	13
1 M Ω	a	0.32	14
2.2 M Ω	a	0.22	15

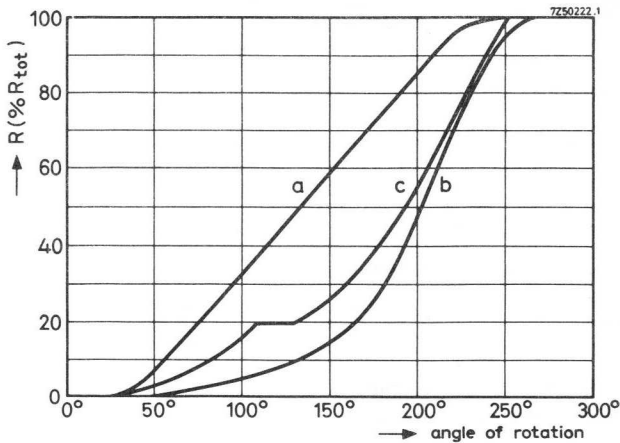

Fig. 5. Resistance variations with the angle of rotation

¹⁾ Measured between the terminals S₁ and S₃.

Table III - Logarithmic resistance law

nom. resistance value (R_n) ¹⁾	curve, Fig. 5	I_{max} through slider contact (mA)	min. resistance at the beginning (Ω)	code in catalogue number
1 k Ω	b	7	≤ 5	24
2.2 k Ω	b	5	≤ 5	25
4.7 k Ω	b	3.2	≤ 5	26
10 k Ω	b	2.2	≤ 10	27
22 k Ω	b	1.5	≤ 20	28
47 k Ω	b	1	≤ 35	29
100 k Ω	b	0.7	≤ 50	31
220 k Ω	b	0.5	≤ 50	32
470 k Ω	b	0.32	≤ 100	33
1 M Ω	b	0.22	≤ 200	34
2 + 8 k Ω	c	2.2	≤ 10	76
5 + 17 k Ω	c	1.5	≤ 20	82
50 + 170 k Ω	c	0.5	≤ 50	83
5 + 42 k Ω		1	≤ 35	72
10 + 37 k Ω	c	1	≤ 35	86
20 + 80 k Ω	c	0.7	≤ 50	77
0.5 + 1.7 M Ω	c	0.15		84

1) Measured between the terminals S_1 and S_3 ; for potentiometers with a tap, between the terminals S_1 and S_4 and between S_4 and S_3

Tolerance on the nominal resistance	$\pm 20\%$
Resistance law	linear and logarithmic, see Fig. 5.
Minimum resistance at the tap	$\leq 1.5\%$ of R_n
Contact resistance between carbon track and slider contact	
linear resistance law	$\leq 4\%$ of R_n
logarithmic resistance law	$\leq 6\%$ of R_n
Insulation resistance between case and interconnected terminals, after damp heat test (21 days, $T_{amb} = 40^\circ C$, R.H. = 90 - 95%)	
potentiometers with steel spindles	$> 10 M\Omega$
potentiometers with plastic spindles	$> 1 M\Omega$
Maximum permissible dissipation at $40^\circ C$	
linear resistance law	0.1 W
logarithmic resistance law	0.05 W
Test voltage for 1 min between case and interconnected terminals	500 V, 50 Hz

Working-temperature range	
potentiometers with steel spindles	-10 to +70 °C
potentiometers with plastic spindles	-20 to +70 °C
Climatic robustness	
potentiometers with steel spindles	category 10/070/21 (I. E. C. 68)
potentiometers with plastic spindles	category 20/070/21 (I. E. C. 68)
Effective angle of rotation	245 - 260°
Mechanical angle of rotation	270 ± 5°
Operating torque	0.3-1.5 Ncm
Permissible torque with slider at end stop	
plastic spindles with flat face	≤ 40 Ncm
other spindles	≤ 60 Ncm
Permissible axial spindle load	≤ 100 N
Axial spindle play	< 0.5 mm
Radial spindle play, measured at a distance of 1 cm from the mounting panel with a load of 2.5 N	< 0.2 mm
Life	in excess of 10 000 cycles
<u>Switches</u>	
Breaking capacity	12 V _{dc} , 2 A
Test voltage for 1 min ¹⁾ , initially after damp heat test (21 days, T _{amb} = 40 °C, R.H. = 90 - 95%)	500 V _{dc} 100 V _{dc}
Contact resistance, initially after 10 000 on-off switching operations	< 10 mΩ < 50 mΩ (average value < 25 mΩ)
Insulation resistance ¹⁾ , initially after damp heat test (21 days, T _{amb} = 40 °C, R.H. = 90 - 95%)	> 10 MΩ > 2 MΩ
Switching torque	1.5-4 Ncm
Switching angle	20 ± 2°
Total angle of rotation	292 ± 5°

¹⁾ Measured between the terminals and between the case and interconnected terminals.

100
100
100
100
100

TANDEM CARBON POTENTIOMETERS

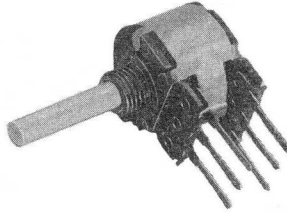

RZ 23963-3

Resistance law	linear and logarithmic
Resistance range	
linear resistance law	1 k Ω - 2.2 M Ω
logarithmic resistance law	1 k Ω - 1 M Ω
Maximum permissible dissipation at 40°C	
linear resistance law	0.1 W
logarithmic resistance law	0.05 W

APPLICATION

For use in a wide variety of electronic equipment, especially where small dimensions are required, e.g. transistorised apparatus for stereophonic purposes.

CONSTRUCTION

The tandem potentiometers are composed of two annular carbon tracks, fitted on base plates of resin bonded paper, which are situated in one housing. The base plates are placed in such a way that the tracks are opposite each other.

The soldering tags S_1 and S_3 (see Fig.1) are connected to the ends of the carbon track; soldering tag S_2 is connected, via a contact ring, to the slider contact.

Potentiometers with logarithmic resistance law can be supplied with a tap (terminal S_4) at 20% of the nominal resistance value.

The potentiometers are available with soldering tags suited for use in conventional wiring, as well as with pins suited for printed-wiring connection.

7Z9 5197

AVAILABLE TYPES

Table I

spindle type	Fig. 1	code in catalog number	
		potentiometers with tags	potentiometers with pins
plain, L = 10 mm	a, b	711	761
L = 15 mm	a, b	712	762
L = 20 mm	a, b	715	765
L = 30 mm	a, b	703	753
with flat face, L = 10 mm	c	742	792
L = 15 mm	c	744	794
L = 20 mm	c	746	796

TECHNICAL PERFORMANCE

Table II - Linear resistance law

nom. resistance value (R_n) ¹⁾	curve, Fig. 2	I_{max} through slider contact (mA)	code in catalog number
1 k Ω	a	10	04
2.2 k Ω	a	7	05
4.7 k Ω	a	5	06
10 k Ω	a	3.2	07
22 k Ω	a	2.2	08
47 k Ω	a	1.5	09
100 k Ω	a	1	11
220 k Ω	a	0.7	12
470 k Ω	a	0.5	13
1 M Ω	a	0.32	14
2.2 M Ω	a	0.22	15
10 k Ω 2)	g	3.2	91
22 k Ω 2)	g	2.2	92
47 k Ω 2)	g	1.5	93
100 k Ω 2)	g	1	94
220 k Ω 2)	g	0.7	95
470 k Ω 2)	g	0.5	96

1) Measured between the terminals S₁ and S₃.

2) Balance potentiometers.

Table III - Logarithmic resistance law

nom. resistance value (R_n) ¹⁾	curve, Fig.2	I_{max} through slider contact (mA)	min. resistance at the beginning (Ω)	code in catalog number
1 k Ω	b	7	5	24
2.2 k Ω	b	5	5	25
4.7 k Ω	b	3.2	5	26
10 k Ω	b	2.2	10	27
22 k Ω	b	1.5	20	28
47 k Ω	b	1	35	29
100 k Ω	b	0.7	50	31
220 k Ω	b	0.5	50	32
470 k Ω	b	0.32	100	33
1 M Ω	b	0.22	200	34
2+8 k Ω	c	2.2	10	76
5+17 k Ω	c	1.5	22	82
50+170 k Ω	c	0.5	50	83

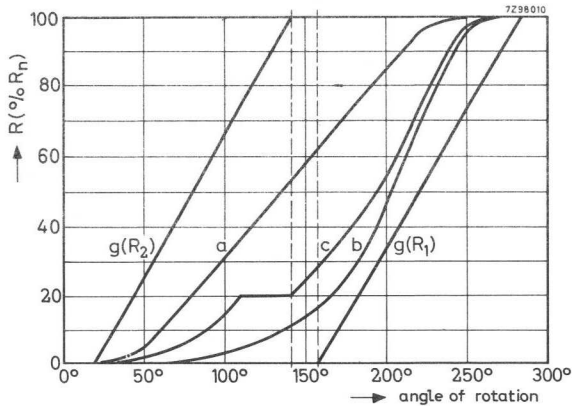

Fig.2. Resistance variations with the angle of rotation

1) Measured between the terminals S_1 and S_3 ; for potentiometers with a tap, between the terminals S_1 and S_4 and between S_4 and S_3 .

Tolerance on the nominal resistance	+20%
Resistance law	linear and logarithmic, see Fig. 2
Ganging tolerance	
linear resistance law	
at values between 10 and 90% of R_N	< 2 dB
logarithmic resistance law	
at attenuations between 0 and -20 dB	< 2 dB
at attenuations between -20 and -30 dB	< 3 dB
at attenuations between -30 and -40 dB	< 4 dB
with a tap at 20% and	
at attenuations between 0 and -20 dB	< 2 dB
at attenuations between -20 and -30 dB	< 3 dB
at attenuations between -30 and -34 dB	< 4 dB
Minimum resistance at the tap	$\leq 1.5\%$ of R_N
Contact resistance between carbon track and slider contact	
linear resistance law	$\leq 4\%$ of R_N
logarithmic resistance law	$\leq 6\%$ of R_N
logarithmic resistance law, tap at 20%	$\leq 6\%$ of R_N
balance potentiometers	$\leq 6\%$ of R_N
Insulation resistance between case and inter-connected terminals after damp heat test (21 days, $T_{amb} = 40^\circ\text{C}$, R.H. = 90-95%)	> 10 M Ω
Maximum permissible dissipation at 40 $^\circ\text{C}$	
linear resistance law	0.1 W
logarithmic resistance law	0.05 W
Test voltage for 1 min between case and interconnected terminals	500 V, 50 Hz
Working-temperature range	-10 to +70 $^\circ\text{C}$
Climatic robustness	category 10/070/21 (I.E.C. 68)
Effective angle of rotation	245-260 $^\circ$
Mechanical angle of rotation	285 \pm 5 $^\circ$
Operating torque	0.5-2 Ncm
Permissible torque with slider at end stop	≤ 50 Ncm
Permissible axial spindle load	≤ 30 N
Axial spindle play	< 0.8 mm

Radial spindle play, measured at a distance of 1 cm from the mounting panel with a load of 2.5 N
 Life

< 0.2 mm
 in excess of 10 000 cycles

MOUNTING

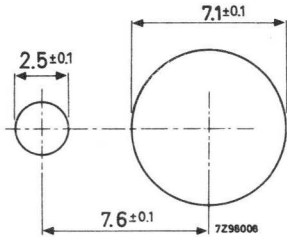

The potentiometers with soldering tags can be fixed on a chassis with the supplied mounting nut. The maximum torque for tightening the nut is 100 Ncm.

The potentiometers with pins can be mounted on printed-wiring boards with a pitch of 2.54 mm.

Fig.3. Mounting holes in the chassis

COMPOSITION OF THE CATALOG NUMBER

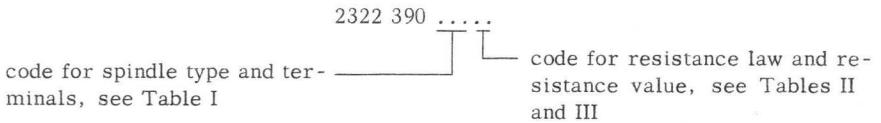

MINIATURE CARBON TRIMMING POTENTIOMETERS

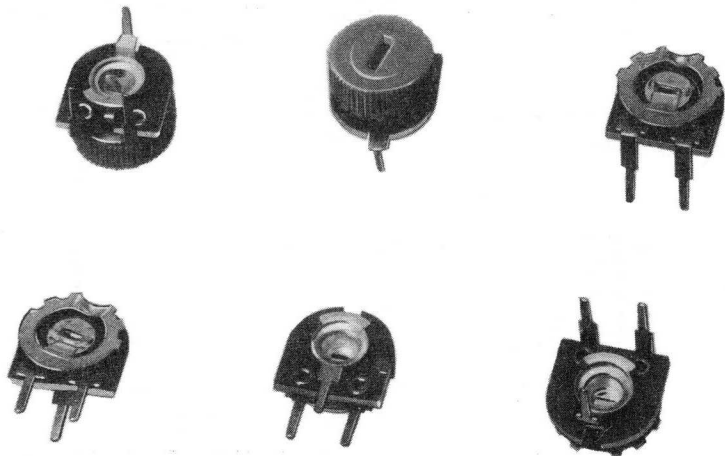

RZ 25706-4

Linear resistance law
Resistance range

100 Ω - 4.7 M Ω ←

APPLICATION

These potentiometers are destined for pre-set resistance controls with provision for re-adjustments. Due to their miniature size these high-reliable potentiometers are very suitable for use in transistorised equipment.

CONSTRUCTION

The annular carbon track is riveted on to a base plate of resin bonded paper. The stop is formed by the tag for the slider. For adjustment the slider has been provided with a central screw-driver slot and notches on the outer edge, or with a knob with central screw-driver slot.

Versions for vertical mounting as well as for horizontal mounting on printed-wiring boards are available. The tags will fit printed-wiring boards with a pitch of 2.54 mm.

The potentiometers are marked with the nominal resistance value. ←

Dimensions in mm

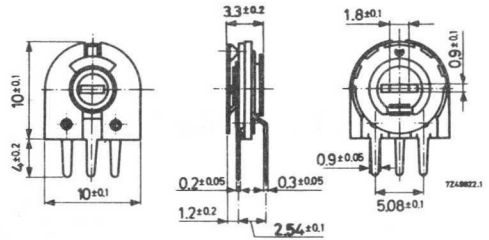

Potentiometers for vertical
mounting; without knob.

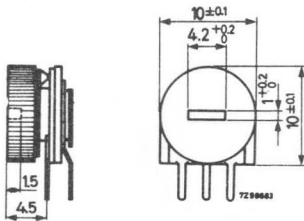
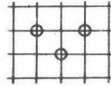

Potentiometers for vertical
mounting; with knob.

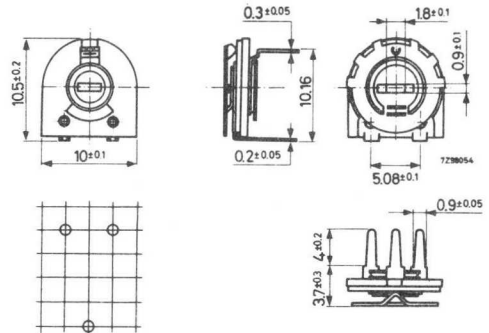

Potentiometers for horizontal
mounting; without knob.

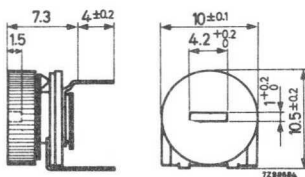
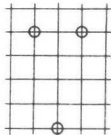

Potentiometers for horizontal
mounting; with knob.

TECHNICAL PERFORMANCE

resistance value R_{nom}	min. resistance at both ends (Ω)	V_{max} (d.c. or rms) at $T_{amb} = 40\text{ }^{\circ}\text{C}$ (V)	I_{max} through slider contact (mA)	code in catalog number
100 Ω	≤ 10	3.2	10	01
220 Ω	≤ 10	4.5	7	02
470 Ω	≤ 10	7	4.5	03
1 k Ω	≤ 20	10	3.2	04
2.2 k Ω	≤ 40	14	2.2	05
4.7 k Ω	≤ 100	22	1.4	06
10 k Ω	≤ 200	32	1.0	07
22 k Ω	≤ 400	45	0.7	08
47 k Ω	≤ 1000	70	0.45	09
100 k Ω	≤ 2000	70	0.32	11
220 k Ω	≤ 4000	70	0.22	12
470 k Ω	≤ 10000	70	0.22	13
1 M Ω	≤ 20000	70	0.22	14
2.2 M Ω	≤ 40000	70	0.22	15
4.7 M Ω	≤ 100000	70	0.14	16

Resistance tolerance	$\pm 20\%$
Resistance value as a function of the rotation angle	linear
Effective angle of rotation	$240 \pm 5^{\circ}$
Maximum permissible power dissipation (of total resistance)	
at an ambient temperature of $40\text{ }^{\circ}\text{C}$	0.1 W
at an ambient temperature of $70\text{ }^{\circ}\text{C}$	0.05 W
Permissible ambient-temperature range	-25 to $+70\text{ }^{\circ}\text{C}$
Resistance change after humidity test ($0.1 P_{nom}$, 21 days, $T_{amb} = 40\text{ }^{\circ}\text{C}$, R.H. = 90 - 95%) for $R_{nom} \leq 2.2\text{ k}\Omega$	$< 5\%$
for $R_{nom} \geq 4.7\text{ k}\Omega$	$< 25\%$
Torque	0.5 - 3 Ncm
Maximum permissible torque with slider at end stop	5 Ncm

COMPOSITION OF THE CATALOG NUMBER

0 = without knob	2322 410	code for resistance value, see table above
4 = with knob		
33 = horizontal mounting	
50 = vertical mounting		

1940-1941

CARBON TRIMMING POTENTIOMETERS

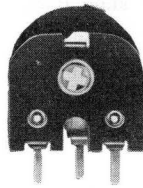
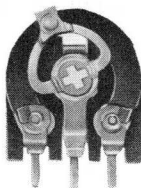
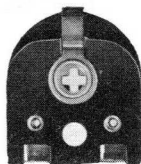
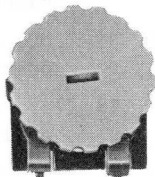
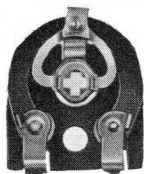

Linear resistance law

Resistance range

RZ 28692-1

100 Ω - 10 M Ω

APPLICATION

These potentiometers are destined for pre-set resistance controls with provision for re-adjustments. They are particularly suitable for use in radio and television receivers.

CONSTRUCTION

The annular carbon track is riveted onto a base plate of resin bonded paper. For adjustment the slider has been provided with a central screwdriver slot, a plastic knob or a knurled wheel.

The material of the soldering tags and pins is tinplated brass.

There are six versions available:

Potentiometers 2322 411 .00.., provided with soldering tags, which are perpendicular on the base plate. They are suited for direct mounting in the wiring; if necessary they can be fitted with a screw in the mounting hole.

Potentiometers 2322 411 .22.., provided with pins, for vertical mounting on printed-wiring boards.

Potentiometers 2322 411 .72..*) provided with pins, for vertical mounting on printed-wiring boards according to DIN 44 150.

Potentiometers 2322 411 .33.., provided with pins, for horizontal mounting on printed-wiring boards.

Potentiometers 2322 411 .83..*) provided with pins, for horizontal mounting on printed-wiring boards according to DIN 44 150.

→ Potentiometers 2322 411 .84.., provided with pins, for horizontal mounting on printed-wiring boards according to DIN 44 151.

All versions mentioned above are available with an adjustment wheel (Fig.7), an adjustment knob (two types, Figs.8 and 9) or with a slot for screwdriver adjustment.

Dimensions in mm

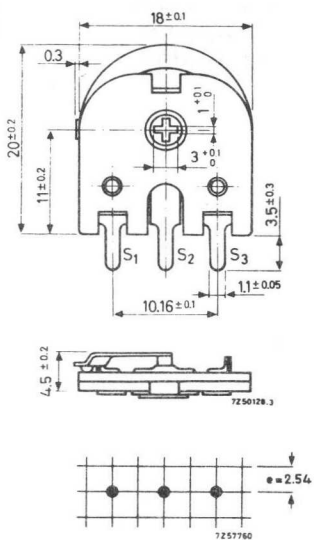
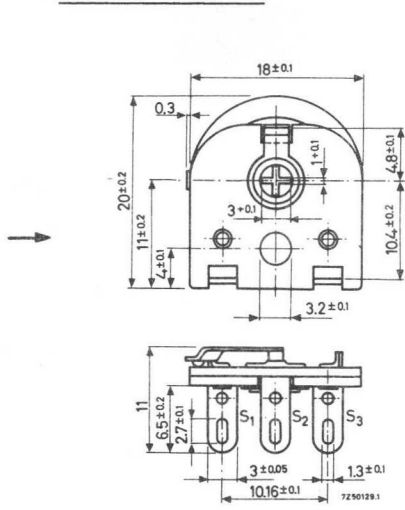

Fig.1. Potentiometers 2322 411 000..

Fig.2. Potentiometers 2322 411 022..

*) Preferred type

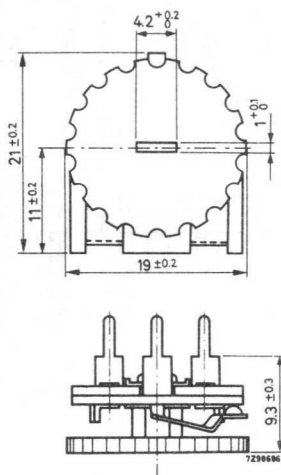

Fig. 7.
Potentiometers
2322 411 433..
(with adjustment wheel)

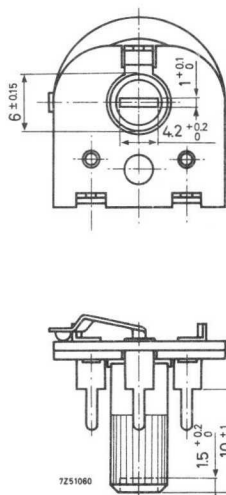

Fig. 8.
Potentiometers
2322 411 133.. (adjust-
ment knob at the side
of the base plate)

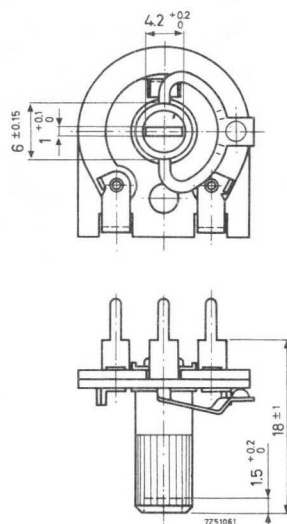

Fig. 9.
Potentiometers
2322 411 233.. (adjust-
ment knob at the side
of the carbon track)

TECHNICAL PERFORMANCE

resistance value R_{nom}	min. resistance at both ends (Ω)	V_{max} (d.c. or rms) at $T_{amb} = 40^\circ C$ (V)	I_{max} through slider contact (mA)	code in catalog number
100 Ω	↖ 20	5	32	01
220 Ω	↖ 20	7	22	02
470 Ω	↖ 50	11	14	03
1 k Ω	↖ 50	16	10	04
2.2 k Ω	↖ 50	22	7	05
4.7 k Ω	↖ 100	35	4.5	06
10 k Ω	↖ 200	50	3.2	07
22 k Ω	↖ 400	70	2.2	08
47 k Ω	↖ 1000	110	1.4	09
100 k Ω	↖ 2000	160	1.0	11
220 k Ω	↖ 4000	220	0.7	12
470 k Ω	↖ 10000	370	0.45	13
1 M Ω	↖ 20000	500	0.32	14
2.2 M Ω	↖ 40000	500	0.22	15
4.7 M Ω	↖ 100000	500	0.14	16
10 M Ω	↖ 200000	500	0.10	17

Resistance tolerance	$\pm 20\%$
Resistance value as a function of the rotation angle	linear
Effective angle of rotation	$220 \pm 5^\circ$
Maximum permissible power dissipation (of total resistance)	
at an ambient temperature of 40°C	0.25 W
at an ambient temperature of 70°C	0.15 W
Limiting voltage	500 V _{dc} 500 V _{rms}
Permissible ambient-temperature range	-25 to $+70^\circ\text{C}$
Resistance change after humidity test (0.1 P _{nom} , 21 days, T _{amb} = 40°C , R.H. = 90-95%) for R _{nom} $\leq 2.2\text{ k}\Omega$ for R _{nom} $\geq 4.7\text{ k}\Omega$	< 5% < 25%
Torque	0.5 - 5 Ncm
Maximum permissible torque with slider at end stop	10 Ncm

COMPOSITION OF THE CATALOG NUMBER

	2322 411	
0 = without knob		code for resistance value, see table
1 = with knob at the side of the base plate		
2 = with knob at the side of the carbon track		
4 = with adjustment wheel		
00 = with soldering tags		
22 = with pins for vertical mounting		
33 = with pins for horizontal mounting		
72 = with pins for vertical mounting (according to DIN 44 150)		
83 = with pins for horizontal mounting (according to DIN 44 150)		
84 = with pins for horizontal mounting (according to DIN 44 151)		

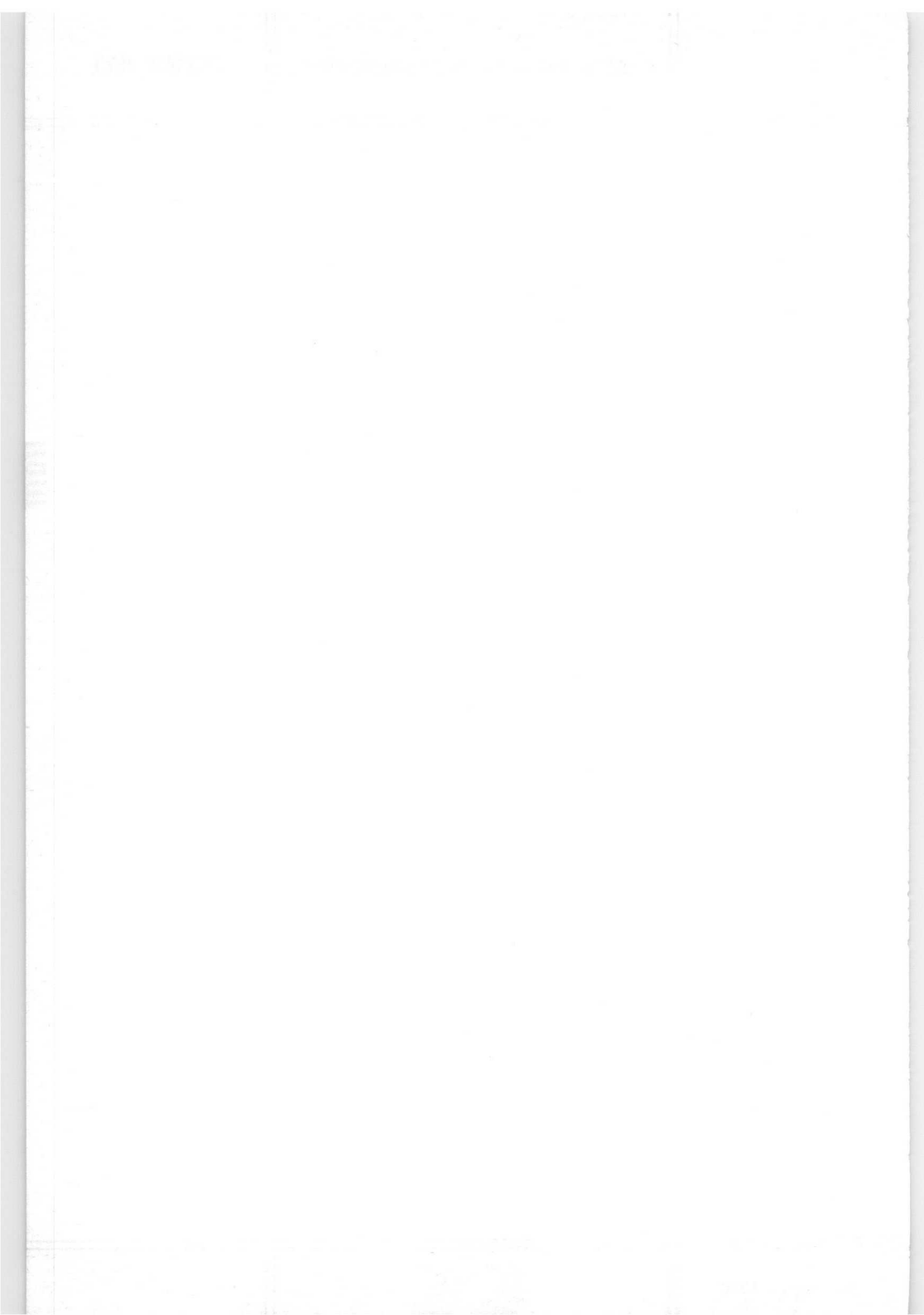

MULTITURN CARBON PRE-SET POTENTIOMETERS

QUICK REFERENCE DATA	
Nominal resistance values	
linear resistance law	220 Ω - 4,7 M Ω
logarithmic resistance law	1 k Ω - 2,2 M Ω
special resistance law	100 k Ω
Maximum dissipation at 40 °C	
linear resistance law	0.4 W
logarithmic and special resistance law	0.3 W
Number of turns of spindle	
potentiometers 2322 412	20
potentiometers 2322 413	10



RZ28770.1

APPLICATION

These potentiometers have been designed for pre-set resistance adjustment in capacitance diode television tuners. However they can also be applied for capacitance diode tuning of other apparatus, e.g. radio receivers, or for any other fine resistance adjustment.

DESCRIPTION

A straight carbon track is fitted on to a base plate of resin bonded paper, which is mounted in a housing of black synthetic resin. The terminals are suited for mounting on printed-wiring boards.

The slider is activated by a silvered threaded spindle. No damage occurs when one continues to turn the spindle after the slider has reached an extreme position.

The potentiometers can be delivered with various adjustment provisions and with or without a scale indicator.

All these versions are available with linear or logarithmic resistance law; besides the 100 k Ω versions are available with special resistance law.

2322 412
2322 413

MULTITURN CARBON
PRE-SET POTENTIOMETERS

Dimensions of the housing (mm)

The housing has been drawn without adjustment provision and scale indicator; these parts are given in the paragraphs below.

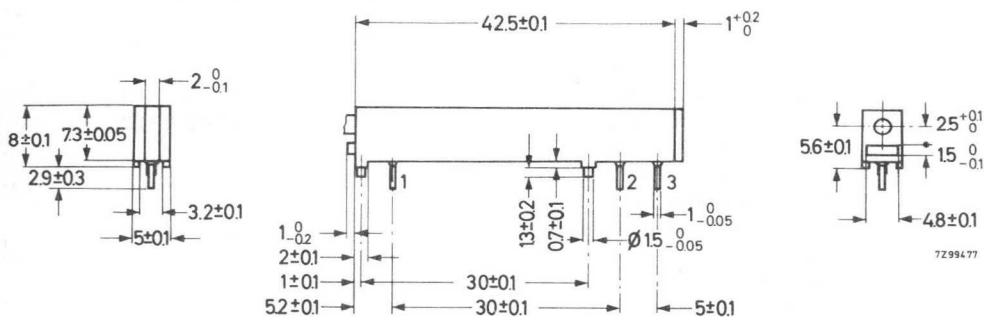

Fig. 1

Terminals 1 and 2 are connected to the ends of the carbon track; terminal 3 is connected to the slider contact.

Adjustment provisions

type (dimensions in mm)	code in catalogue number *
<p>Technical drawing of gear-wheel 51 showing dimensions: $\phi 4^{+0.005}_0$, $0.9^{+0.01}_0$, 6 ± 0.2, 1.8 ± 0.1, and 4.5 ± 0.2. The drawing is identified by the number 7299478.</p>	51
<p>Technical drawing of gear-wheel 52 showing dimensions: $\phi 4^{+0.01}_0$, $3^{+0.01}_0$, $2.5^{+0.03}_{-0.1}$, 12 ± 0.1, 6 ± 0.2, and 8 ± 0.2. The drawing is identified by the number 7299479.</p>	Gear-wheel: module = 0.4 number of teeth = 19 tooth depth = 0.88 52

*) See section "Composition of the catalogue number".

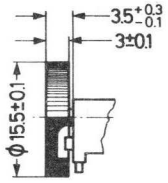
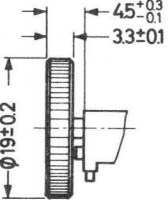
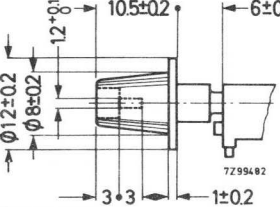
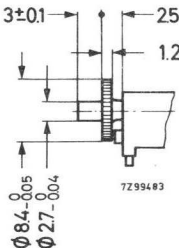
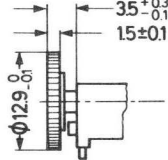
type (dimensions in mm)	code in catalogue number *)
 <p>7299480</p>	<p>Knob: approx. 60 notches</p> <p>61</p>
 <p>7299481</p>	<p>Knob: approx. 48 notches</p> <p>62</p>
 <p>7299482</p>	<p>63</p>
 <p>7299483</p>	<p>Gear-wheel: module = 0.4 number of teeth = 19 tooth depth = 0.88</p> <p>81</p>
 <p>7299484</p>	<p>Gear-wheel: module = 0.5 number of teeth = 24 tooth depth = 1.2</p> <p>82</p>

*) See section "Composition of the catalogue number".

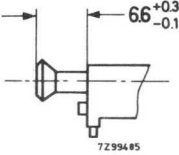
type (dimensions in mm)	code in catalogue number *
 <p data-bbox="460 320 754 400">Gear-wheel: module = 0.5 number of teeth = 12 shape according to DIN 867</p> <p data-bbox="250 432 292 448">7299485</p>	83

Indicators

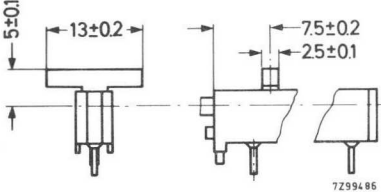
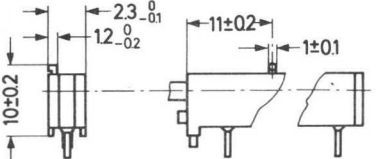
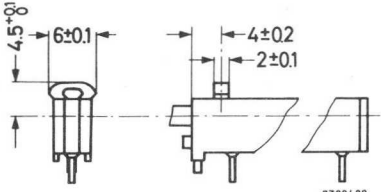
type (dimensions in mm)	with/without dust cover on the housing	code in catalogue number *
 <p data-bbox="474 831 516 847">7299486</p>	without	1
 <p data-bbox="460 1078 501 1094">7299487</p>	without	2
 <p data-bbox="463 1318 505 1334">7299488</p>	without	3

*) See section "Composition of the catalogue number".

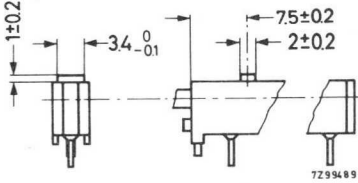
type (dimensions in mm)	with/without dust cover on the housing	code in catalogue number *)
	without	4
without indicator	without	0
without indicator	with	8

*) See section "Composition of the catalogue number".

TECHNICAL DATA

Unless stated otherwise, all electrical values have been determined at an ambient temperature of 15 to 35 °C, an air pressure of 860 to 1060 mbar and a relative humidity of 45 to 75%.

nom. resistance value (R_n)	resistance law	min. resistance at the beginning	max. current through slider contact (mA)	code in catalogue number *)
220Ω	linear	≧ 10Ω	42	02
470Ω		≧ 15Ω	29	03
1kΩ		≧ 25Ω	20	04
2.2kΩ		≧ 40Ω	13	05
4.7kΩ		≧ 80Ω	9.2	06
10kΩ		≧ 150Ω	6.3	07
22kΩ		≧ 250Ω	4.2	08
47kΩ		≧ 500Ω	2.9	09
100kΩ		≧ 1kΩ	2.0	11
220kΩ		≧ 2kΩ	1.3	12
470kΩ		≧ 5kΩ	0.92	13
1MΩ		≧ 10kΩ	0.63	14
2.2MΩ		≧ 20kΩ	0.42	15
4.7MΩ		≧ 50kΩ	0.29	16
1kΩ	logarithmic	≧ 5Ω	4.0	24
2.2kΩ		≧ 8Ω	2.7	25
4.7kΩ		≧ 15Ω	1.9	26
10kΩ		≧ 20Ω	1.3	27
22kΩ		≧ 35Ω	0.86	28
47kΩ		≧ 65Ω	0.59	29
100kΩ		≧ 125Ω	0.40	31
220kΩ		≧ 220Ω	0.27	32
470kΩ		≧ 400Ω	0.19	33
1MΩ		≧ 750Ω	0.13	34
2.2MΩ	≧ 1.5kΩ	0.086	35	
100kΩ	special	≧ 125Ω	0.40	38

*) See section "Composition of the catalogue number".

Tolerance on nominal resistance	$\pm 20\%$ of R_n
Resistance law and tolerance	see Fig. 2
Maximum permissible dissipation	
linear resistance law, at 40 °C	0.4 W
at 70 °C	0.125 W
logarithmic and special resistance law, at 40 °C	0.3 W
at 70 °C	0.10 W
Limiting voltage	200 V
Contact resistance between carbon track and slider contact, the slider being moved 1 mm/s (see also paragraph "Measurement of the contact resistance")	
linear resistance law	$\leq 3\%$ of R_{total}
logarithmic and special resistance law,	
for 0- 60% of effective travel	$\leq 3\%$ of R_{total}
for 60-100% of effective travel	$\leq 6\%$ of R_{total}
Operating temperature range	-30 to +70 °C
Category (IEC68)	30/070/21
Resistance change with temperature	see Figs. 3 and 4 *)
Change of pre-set voltage with temperature	see Figs. 5 and 6 *)
Change of pre-set voltage after vibration test (IEC68, test F VI) and shock test (IEC68, test Ea)	$\leq 0.1\%$ of pre-set voltage

*) Valid only for potentiometers with linear or special resistance law.

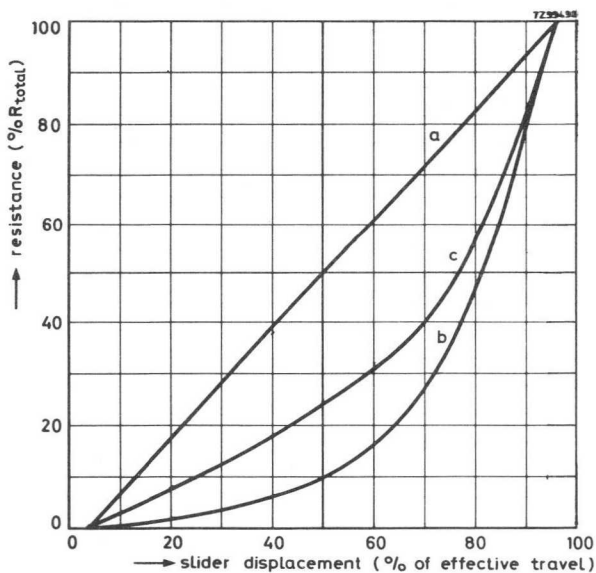

Fig.2. Resistance as a function of slider displacement

curve	resistance law	tolerance on resistance law	
		displacement (% of effective travel)	resistance (% of R_{total})
a	linear	between 36.5 and 38.5 between 61.5 and 63.5	33.5 - 41.5 58.5 - 66.5
b	logarithmic	between 36.5 and 38.5 between 61.5 and 63.5	3.5 - 8.5 12 - 26
c	special	between 36.5 and 38.5 between 61.5 and 63.5 between 86.5 and 88.5	15 - 21 28 - 38 60 - 75

Resistance change as a function of the temperature; relative humidity 40 to 80% at 25 °C.

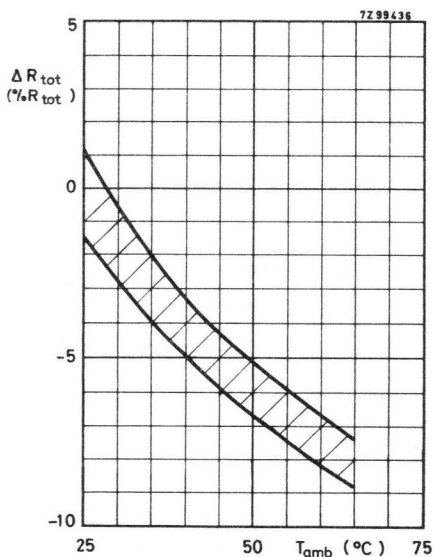

Fig. 3. Linear resistance law

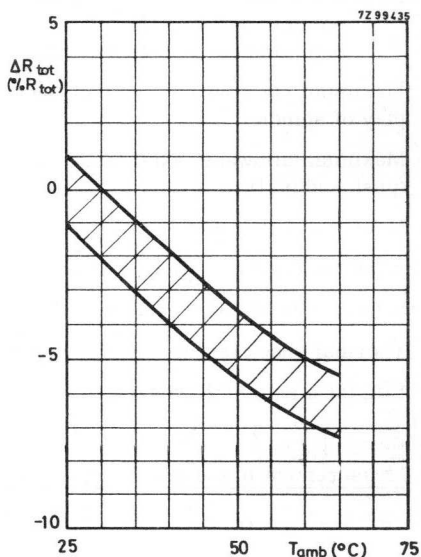

Fig. 4. Special resistance law

Change of pre-set voltage as a function of the temperature, V_{1-3} being 30% of V_{1-2} ; relative humidity 40 to 80% at 25 °C.

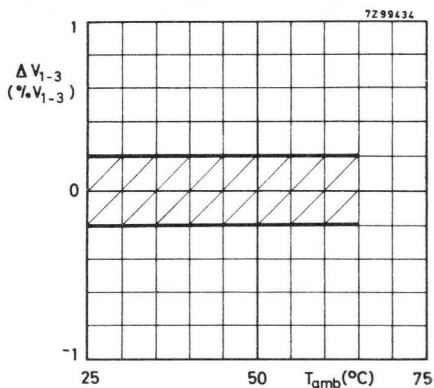

Fig. 5. Linear law

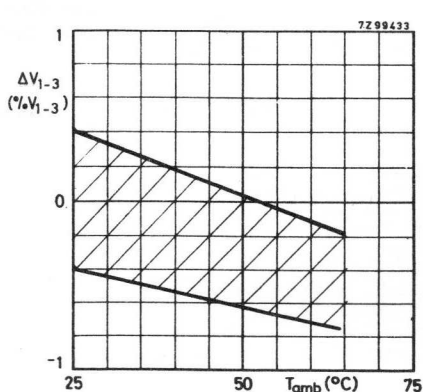

Fig. 6. Special law

Operating torque	0.3 - 1 Ncm (30-100 gcm)
Effective number of turns of spindle	
potentiometers 2322 412	$19 \pm \frac{1}{2}$
potentiometers 2322 413	$10 \pm \frac{1}{2}$
Maximum axial run-out including radial play of spindle	0.15 mm
Maximum allowable axial force on spindle (push and pull)	≤ 250 g
Mechanical travel of slider contact	25.6 ± 0.15 mm
Effective travel of slider contact	24.0 ± 0.5 mm
Solderability (to IEC 68-2, test T)	230 ± 10 °C, for 2 ± 0.5 s
Thermal shock test (to IEC 68-2, test T)	350 ± 10 °C, for 2 ± 0.5 s
Life (at a rate of 20 rev/min)	50 x in both directions + 3 rotations at both ends

Measurement of the contact resistance

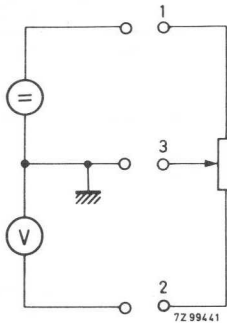

Fig. 7

A d.c. current source which supplies a constant direct current (**I**) of e.g. 1 mA, is connected to the pins 1 and 3 of the potentiometer.

For the diagram of the d.c. current source, see Fig. 8. The d.c. voltage (**V**) resulting from the contact resistance (R_C) and the d.c. current is measured between the pins 2 and 3 ($V = I \cdot R_C$).

During the measurement the slider contact is moved with a constant speed of 1 mm/s.

The input resistance of the d.c. voltmeter must be at least 10 M Ω .

Note - Circuit diagram of the direct current source used for measuring the contact resistance. Open-circuit output voltage is 380 V.

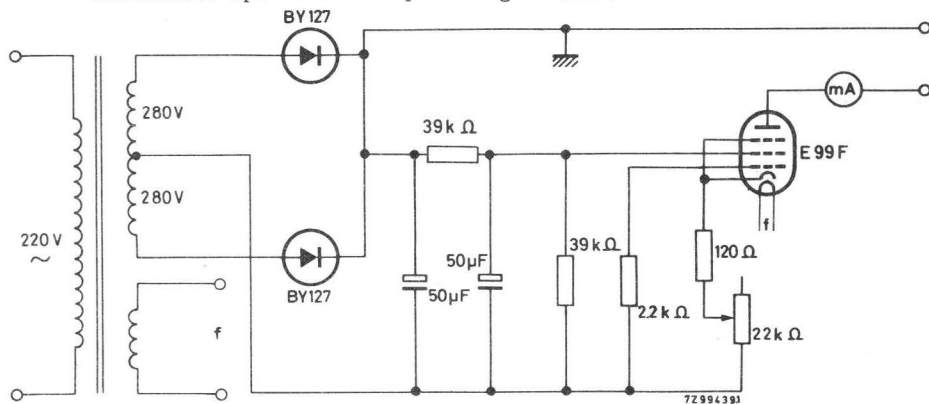

Fig. 8

MOUNTING

The terminals may be dip soldered over a length of 2 mm max. in a solder bath of 260 °C max. for 4 s max.

When a soldering bit is used, its temperature must not exceed 360 °C for 1.5 s and neither axial nor radial stress must be exerted on the terminals.

MARKING

The potentiometers are marked with the nominal resistance value, resistance law, quarter and year of manufacture.

COMPOSITION OF THE CATALOGUE NUMBER

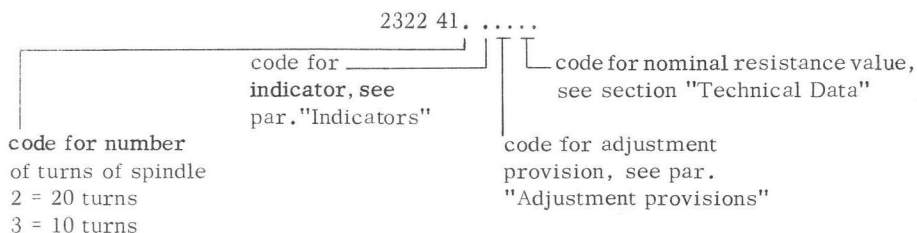

14-00000
14-00000

MINIATURE CARBON POTENTIOMETERS



RZ 27512-2

Nominal resistance values
Resistance law

4, 7, 10 and 22 k Ω
linear and logarithmic

GENERAL

These potentiometers are destined for use in miniaturised electronic equipment such as hearing aids, small radio sets, etc.
On account of their application a special construction has been applied, which makes mounting of a control knob superfluous.

The potentiometers can be fixed on a chassis with the supplied mounting nut, catalogue number 4322 047 09530.

Dimensions in mm

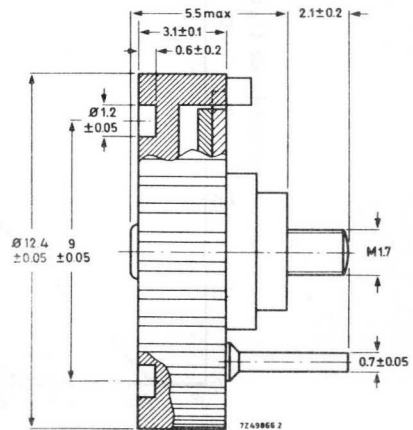
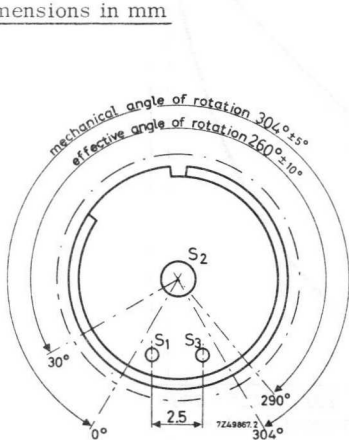

S₁, S₂, S₃ = potentiometer terminals (S₁ and S₃ are connected to the ends of the carbon track; S₂ is connected to the slider contact)

TECHNICAL PERFORMANCE

Nominal resistance values	4.7, 10 and 22 kΩ
Tolerance on the nominal resistance	± 20%
Resistance law	linear and logarithmic
Contact resistance between carbon track and slider	
linear resistance law	≤ 5% of R_N
logarithmic resistance law	≤ 10% of R_N
Minimum resistance	
spindle turned fully counter-clockwise	≤ 0.1% of R_N
spindle turned fully clockwise	≤ 1% of R_N
Maximum attenuation	≥ 60 dB
Maximum voltage over the resistance element	10 V _{dc}
Current through slider	≤ 1 mA
Working-temperature range	-10 to +70 °C
Effective angle of rotation	260 ± 10°
Mechanical angle of rotation	304 ± 5°
Operating torque	0.2 - 1 Ncm
Maximum permissible torque with slider at end stop	5 Ncm
Life	in excess of 15 000 cycles

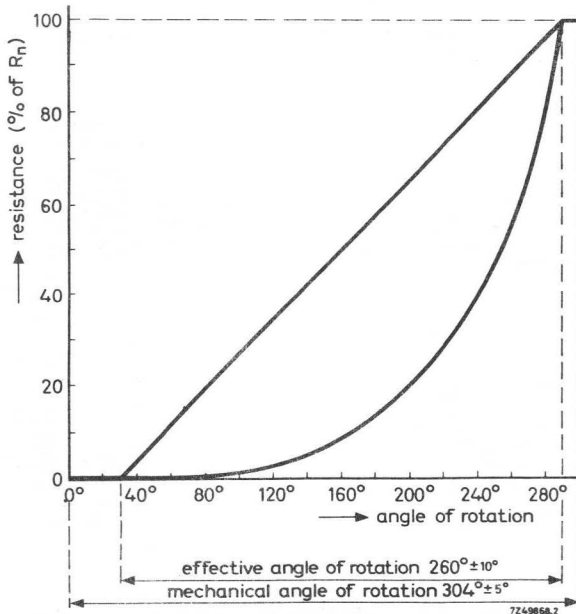

Variation of resistance with the angle of rotation

COMPOSITION OF THE CATALOGUE NUMBER

2322 440 000..

06 = 4.7 k Ω	} linear	
07 = 10 k Ω		} resistance
08 = 22 k Ω		

26 = 4.7 k Ω	} logarithmic
27 = 10 k Ω	
28 = 22 k Ω	} law



THE UNIVERSITY OF CHICAGO PRESS

044 5082

SINGLE CARBON POTENTIOMETERS

conforming to MIL-R94-A and CCTU-05-01

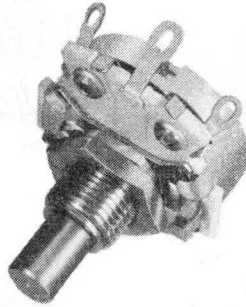

RZ 27512-3

Resistance law	linear and logarithmic
Resistance range	
linear resistance law	100 Ω - 4.7 M Ω
logarithmic resistance law	470 Ω - 2.2 M Ω
Maximum permissible dissipation at 40 °C	
linear resistance law	1 W
logarithmic resistance law	0.5 W

APPLICATION

For use in professional electronic equipment.

CONSTRUCTION

An annular carbon track is fitted onto a ceramic base plate and housed in a metal case.

The soldering tags S_1 and S_3 (see Fig.1) are connected to the ends of the carbon track, soldering tag S_2 is connected to the slider contact.

Material of the soldering tags	tinplated brass
Material of the slider contact and of the centre contact	silverplated brass
Material of other metal parts	nickelplated brass

Dimensions in mm

For L, see Table 1

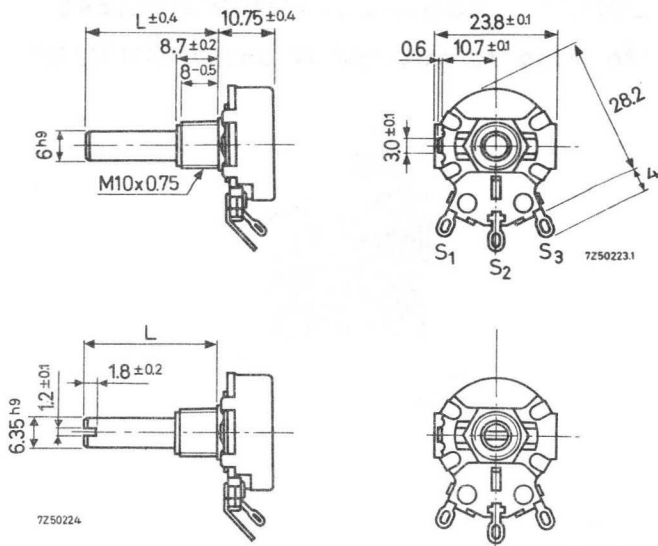

Fig. 1

Table 1

spindle type	code in catalog number
plain, $L = 17$ mm	013
$L = 30$ mm	003
$L = 60$ mm	007
with screwdriver slot	
$L = 12.7$ mm	904
$L = 22.2$ mm	907
$L = 31.8$ mm	910
$L = 63.5$ mm	920

MOUNTING

The potentiometer can be fixed on a chassis with the supplied mounting nut. The minimum thickness of the chassis is 1.5 mm. The maximum torque for tightening the nut is 350 Ncm.

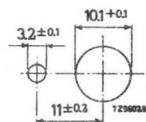
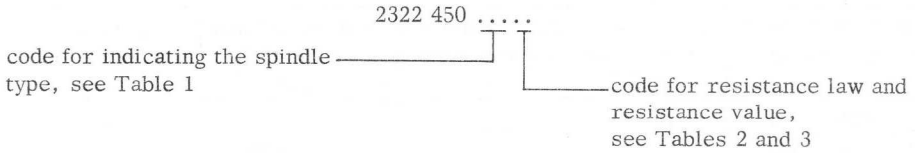

Fig. 2 Mounting holes

COMPOSITION OF THE CATALOG NUMBER



TECHNICAL PERFORMANCE

Table 2 - Linear resistance law, Fig.3 curve a, 1 W

nom. resistance value (R_n)	I_{max} through slider contact (mA)	minimum resistance at both ends (Ω)	code in catalog number
100 Ω	50	≤ 5	01
220 Ω	30	≤ 5	02
470 Ω	22	≤ 5	03
1 $k\Omega$	16	≤ 25	04
2.2 $k\Omega$	11	≤ 25	05
4.7 $k\Omega$	7	≤ 25	06
10 $k\Omega$	5	≤ 25	07
22 $k\Omega$	3	≤ 35	08
47 $k\Omega$	2.2	≤ 35	09
100 $k\Omega$	1.4	≤ 50	11
220 $k\Omega$	0.9	≤ 125	12
470 $k\Omega$	0.65	≤ 250	13
1 $M\Omega$	0.45	≤ 500	14
2.2 $M\Omega$	0.22	≤ 1000	15
4.7 $M\Omega$	0.15	≤ 2000	16

Table 3 - Logarithmic resistance law, Fig.3 curve b, 0.5 W

nom. resistance value (R_N)	I_{max} through slider contact (mA)	min. resistance at the beginning (Ω)	min. resistance at the end (Ω)	code in catalog number
470 Ω	22	≤ 5	≤ 20	23
1 k Ω	10	≤ 25	≤ 100	24
2.2 k Ω	7	≤ 25	≤ 100	25
4.7 k Ω	4.5	≤ 25	≤ 100	26
10 k Ω	3.2	≤ 25	≤ 200	27
22 k Ω	2.5	≤ 35	≤ 250	28
47 k Ω	1.4	≤ 35	≤ 500	29
100 k Ω	1.0	≤ 35	≤ 1000	31
220 k Ω	0.7	≤ 50	≤ 2500	32
470 k Ω	0.45	≤ 100	≤ 5000	33
1 M Ω	0.32	≤ 200	≤ 10000	34
2.2 M Ω	0.22	≤ 500	≤ 25000	35

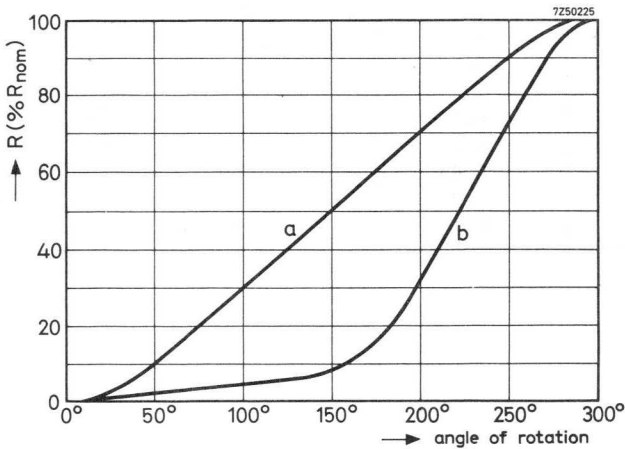

Fig.3. Resistance variation with the angle of rotation

Tolerance on the nominal resistance	$\pm 20\%$
Resistance law	linear and logarithmic, see Fig. 3
Maximum permissible dissipation at 40 °C	
linear resistance law	1 W
logarithmic resistance law	0.5 W
Test voltage for 1 min between inter- connected tags and bearing bushing	
at turning rotor	900 V _{rms}
at low pressure	450 V _{rms}
Resistance change after soldering	$\leq 2\%$
after 15 000 cycles	$\leq 10\%$
after loading during 1 000 hours	$\leq 10\%$
after vibration test	$\leq 2.5\%$
after humidity test	$\leq 20\%$
after cold test, unloaded	$\leq 2\%$
loaded	$\leq 3\%$
after change of temperature test	$\leq 6\%$
Effective angle of rotation	250 - 265 °
Mechanical angle of rotation	300 °
Operating torque	0.75 - 4.3 Ncm
Permissible torque with slider at end stop	≤ 95 Ncm
Permissible axial spindle load	≤ 100 N



CPA-STATE
STATE OF CALIFORNIA
1997

23 mm SINGLE CARBON POTENTIOMETERS

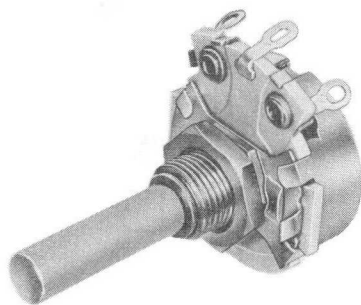

RZ 24108-4

Resistance law	linear and logarithmic
Resistance range	
linear resistance law	220 Ω - 4.7 M Ω
logarithmic resistance law	1 k Ω - 2.2 M Ω
Maximum permissible dissipation at 40 °C	
linear resistance law	1 W
logarithmic resistance law	0.5 W

APPLICATION

These potentiometers are destined for use in radio and television sets, where a dissipation of 0.5 W (potentiometers with logarithmic resistance law) or 1 W (potentiometers with linear resistance law) is required, or where a non-inflammable potentiometer has to be applied.

CONSTRUCTION

An annular carbon track is fitted onto a ceramic base plate and housed in a metal case.

The soldering tags S_1 and S_3 (see Fig.1) are connected to the ends of the carbon track; soldering tag S_2 is connected via a contact ring to the slider contact.

The preferred types of potentiometer have a plastic spindle (poly-acetal resin); potentiometers with a steel spindle are also available.

Dimensions in mm (plastic spindles)

For L and d, see Table I

a. Plain spindle

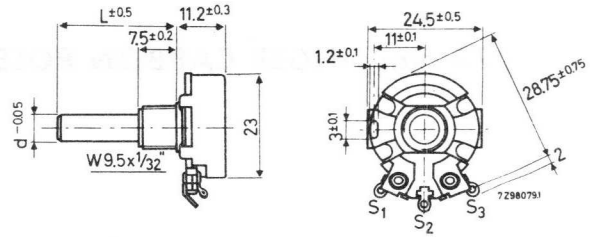

b. Spindle with
screwdriver slot



c. Short spindle with
flat face



d. Long spindle with
flat face

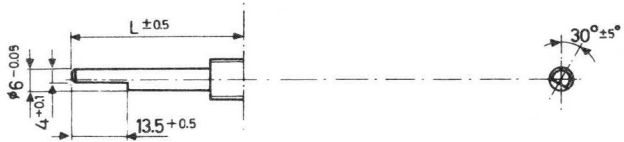

Fig.1. Potentiometers 2322 460 and their various spindle types.
Spindles c and d in fully counter-clockwise position.

MOUNTING

The potentiometer can be fixed on a chassis with the supplied mounting nut. The minimum thickness of the chassis is 1.5 mm.

The maximum torque for tightening the nut is 350 Ncm.

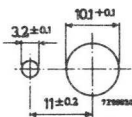



Fig.2. Mounting holes

TYPES

Composition of the catalog number

code for indicating the spindle 2322 460  code for resistance law and resistance value, see Tables 2 and 3

code for indicating the spindle 2322 460  code for resistance law and resistance value, see Tables 2 and 3

Table 1

		Fig. 1	8th to 10th figure of catalog number ¹⁾
plain, d = 6 mm	L = 18 mm	a	706
	L = 30 mm	a	703
	L = 60 mm	a	707
plain, d = 1/4",	L = 30 mm	a	723
	L = 60 mm	a	727
	with screwdriver slot	b	710
short spindle with flat face	c	740	
long spindle with flat face	L = 30 mm	d	743
	L = 60 mm	d	747

¹⁾ Preferred types (with plastic spindle), for potentiometers with a steel spindle the 8th figure is 0 instead of 7.

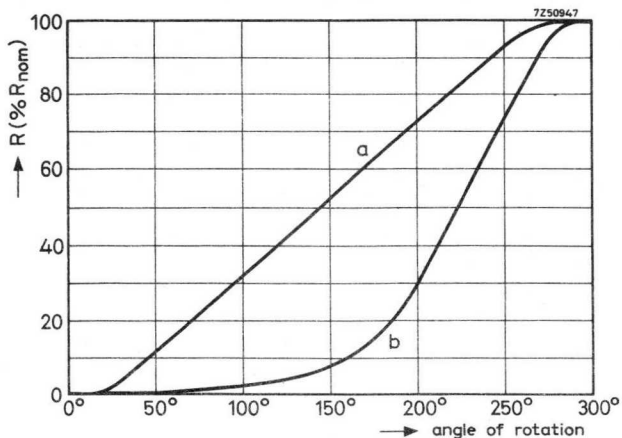

Fig. 3. Resistance variation with the angle of rotation

TECHNICAL PERFORMANCE

Table 2 - Linear resistance law

nom. resistance value (R_n)	curve Fig.3	I_{\max} through slider contact (mA)	code in catalog number
220 Ω	a	67	02
300 Ω	a	57	19
470 Ω	a	46	03
1 $k\Omega$	a	31	04
2.2 $k\Omega$	a	21	05
4.7 $k\Omega$	a	14	06
10 $k\Omega$	a	10	07
22 $k\Omega$	a	6.7	08
47 $k\Omega$	a	4.6	09
100 $k\Omega$	a	3.1	11
220 $k\Omega$	a	2.1	12
470 $k\Omega$	a	1.0	13
1 $M\Omega$	a	0.5	14
2.2 $M\Omega$	a	0.28	15
4.7 $M\Omega$	a	0.10	16

Table 3 - Logarithmic resistance law

nom. resistance value (R_n)	curve Fig.3	I_{\max} through slider contact	min. attenuation at the beginning (dB)	code in catalog number
1 $k\Omega$	b	22	50	24
2.2 $k\Omega$	b	15	60	25
4.7 $k\Omega$	b	10	60	26
10 $k\Omega$	b	7	60	27
22 $k\Omega$	b	4.8	60	28
47 $k\Omega$	b	3.2	70	29
100 $k\Omega$	b	2.2	70	31
220 $k\Omega$	b	1.5	80	32
470 $k\Omega$	b	1	80	33
1 $M\Omega$	b	0.5	80	34
2.2 $M\Omega$	b	0.23	80	35

Tolerance on the nominal resistance	$\pm 20\%$
Resistance law	linear and logarithmic, see Fig.3
Minimum resistance at the beginning	
linear resistance law, $R_n \leq 47 \text{ k}\Omega$	$\leq 50 \Omega$
$R_n > 47 \text{ k}\Omega$	$\leq 0.1\%$ of R_n
logarithmic resistance law, $R_n \leq 4.7 \text{ k}\Omega$	$\leq 5 \Omega$
$R_n > 4.7 \text{ k}\Omega$	$\leq 0.1\%$ of R_n
Minimum resistance at the end	
linear resistance law, $R_n \leq 4.7 \text{ k}\Omega$	$\leq 50 \Omega$
$R_n > 4.7 \text{ k}\Omega$	$\leq 1\%$ of R_n
logarithmic resistance law, $R_n \leq 2.2 \text{ k}\Omega$	$\leq 50 \Omega$
$R_n > 2.2 \text{ k}\Omega$	$\leq 2\%$ of R_n
Contact resistance between carbon track and slider contact	
linear resistance law	$\leq 3\%$ of R_n
logarithmic resistance law	$\leq 6\%$ of R_n
Insulation resistance between case and interconnected tags, after damp heat test (21 days, $T_{\text{amb}} = 40 \text{ }^\circ\text{C}$, R.H. = 90 - 95%)	$> 100 \text{ M}\Omega$
Maximum permissible dissipation at $40 \text{ }^\circ\text{C}$	
linear resistance law	1 W
logarithmic resistance law	0.5 W
Test voltage for 1 min between case and interconnected tags	1 000 V, 50 Hz
Limiting voltage	500 V _p 500 V _{dc}
Working-temperature range	-10 to +70 $^\circ\text{C}$
Climatic robustness	category 10/070/21 (I.E.C. 68)
Effective angle of rotation	250 - 265 $^\circ$
Operating torque	0.3 - 2 Ncm
Permissible torque with slider at end stop	$\leq 80 \text{ Ncm}$
Mechanical angle of rotation	$300 \pm 5 \text{ }^\circ$
Permissible axial spindle load	$\leq 50 \text{ N}$

084 0315

7-20-1915
C. J. ...

Page
Number
Date
Time

23 mm TWIN CARBON POTENTIOMETERS

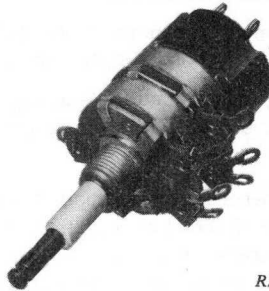
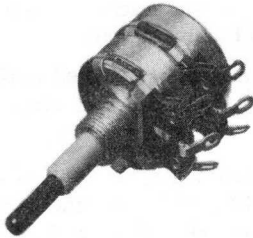

RZ 25706-7

Resistance law	linear and logarithmic
Resistance range	
linear resistance law	220 Ω - 4.7 M Ω
logarithmic resistance law	300 Ω - 2.2 M Ω
Maximum permissible dissipation	
linear resistance law, at 40 °C	0.25 W
at 70 °C	0.125 W
logarithmic resistance law, at 40 °C	0.125 W
at 70 °C	0.0625 W
Potentiometers 2322 470	without switch
2322 476	with double-pole rotary switch, 23 mm diameter

APPLICATION

For use in a wide variety of electronic equipment.

CONSTRUCTION

The twin potentiometers are composed of two single potentiometers R_1 and R_2 (see Figs. 1 and 2). Potentiometer R_1 is operated by means of a hollow plastic spindle of poly-acetal resin, through which a steel spindle protrudes for the operation of potentiometer R_2 .

Both potentiometers consist of an annular carbon track, which is fitted onto a base plate of resin bonded paper and housed in a metal case.

The soldering tags S_1 and S_3 (see Figs. 1 and 2) are connected to the ends of the carbon track; soldering tag S_2 is connected, via a contact ring, to the slider contact.

The potentiometers can be supplied with a tap (tag S_4) at 40 % of the total mechanical angle of rotation, that is to say at 40 % of the nominal resistance value for potentiometers with linear resistance law and at 20 % or at 10 % of the nominal resistance value for potentiometers with logarithmic resistance law.

Dimensions in mm

For the dimensions L_1 and L_2 , see Table I.

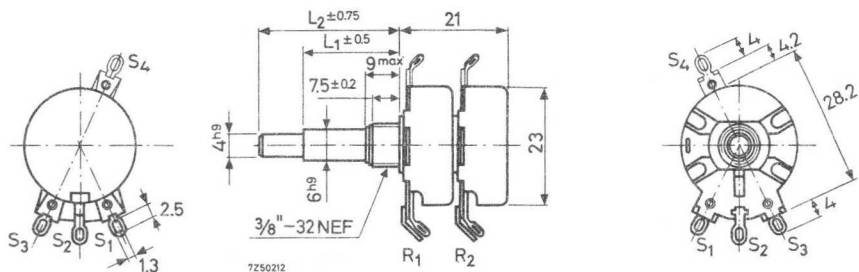

Fig. 1. Potentiometers without switch.

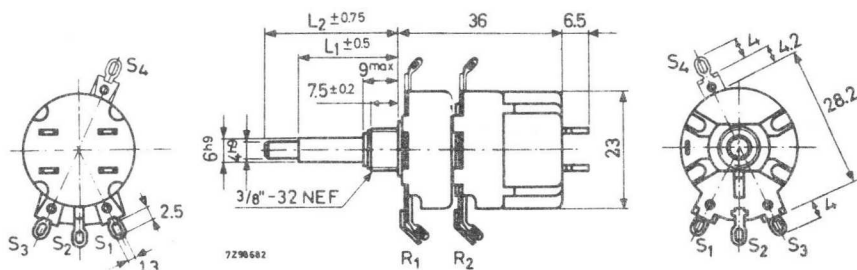

Fig. 2. Potentiometers with double-pole rotary switch, 23 mm diameter.

MOUNTING

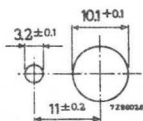

Fig.3. Mounting holes

The potentiometers can be fixed on a chassis with the supplied mounting nut.

The minimum thickness of the chassis is 1.5 mm.

The maximum torque for tightening the nut is 350 Ncm.

TYPES

Composition of the catalog number

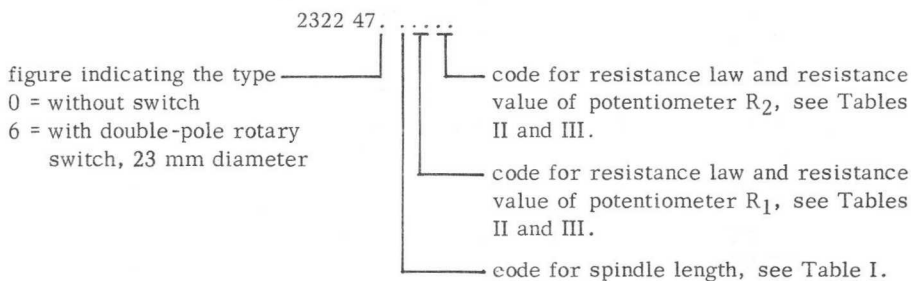

Table I

spindle length	Fig.	code in catalog number
$L_1 = 18 \text{ mm}, L_2 = 30.5 \text{ mm}$	} 1 and 2	0
$L_1 = 30 \text{ mm}, L_2 = 42.5 \text{ mm}$		1
$L_1 = 60 \text{ mm}, L_2 = 72.5 \text{ mm}$		2

TECHNICAL PERFORMANCE

Potentiometers (Data applicable to all types)

Table II - Linear resistance law

nom. resistance value (R_{1n}, R_{2n}) ¹⁾	curve, Fig.4	I_{max} through slider contact (mA)	code in catalog number
220 Ω	a	34	02
300 Ω	a	30	19
470 Ω	a	22	03
1 k Ω	a	16	04
2.2 k Ω	a	11	05
4.7 k Ω	a	7	06
10 k Ω	a	5	07
22 k Ω	a	3.5	08
47 k Ω	a	2.2	09
100 k Ω	a	1.4	11
220 k Ω	a	1	12
470 k Ω	a	0.65	13
1 M Ω	a	0.45	14
2.2 M Ω	a	0.32	15
4.7 M Ω	a	0.22	16
400 + 600 k Ω	e	0.45	89

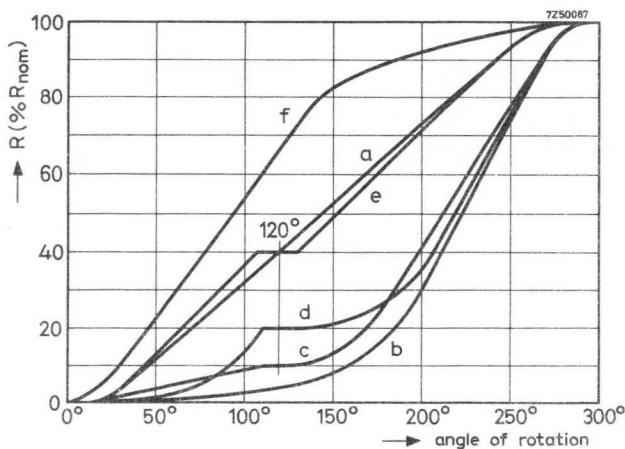

Fig.4. Resistance variation with the angle of rotation, measured between S_1 and S_2 .

¹⁾ Measured between the tags S_1 and S_3 ; for potentiometers with a tap, between the tags S_1 and S_4 and between S_4 and S_3 .

Table III - Logarithmic resistance law

nom. resistance value (R_{1n}, R_{2n}) ¹⁾	curve, Fig.4	I_{\max} through slider contact (mA)	min. resistance at the beginning (Ω)	code in catalog number
300 Ω	f	20	≤ 5	59
1 k Ω	b	10	≤ 5	24
2.2 k Ω	b	7	≤ 5	25
4.7 k Ω	b	4.5	≤ 5	26
10 k Ω	b	3.2	≤ 10	27
22 k Ω	b	2.2	≤ 22	28
47 k Ω	b	1.4	≤ 35	29
100 k Ω	b	1	≤ 50	31
220 k Ω	b	0.7	≤ 50	32
470 k Ω	b	0.45	≤ 100	33
1 M Ω	b	0.32	≤ 500	34
2.2 M Ω	b	0.22	≤ 2200	35
1 M Ω	f	0.32	≤ 500) ²⁾	54
2.2 M Ω	f	0.22	≤ 2200) ²⁾	55
100 + 900 k Ω	c	0.32	≤ 1000	64
0.2 + 2 M Ω	c	0.22	≤ 2200	68
50 + 420 k Ω	c	0.45	≤ 470	73
200 + 800 k Ω	d	0.32	≤ 1000	78
5 + 17 k Ω	d	2.2	≤ 22	82
50 + 170 k Ω	d	0.7	≤ 220	83
0.5 + 1.7 M Ω	d	0.22	≤ 2200	84

Tolerance on the nominal resistance $\pm 20\%$

Resistance law linear and logarithmic, see Fig.4.

Contact resistance between carbon track and slider contact

linear resistance law, $R_n \leq 4.7$ k Ω $\leq 3\%$ of R_n
 $R_n > 4.7$ k Ω $\leq 2.5\%$ of R_n

linear resistance law, tap at 40% $\leq 3\%$ of R_n logarithmic resistance law $\leq 4\%$ of R_n

negative logarithmic resistance law, $R_n \leq 4.7$ k Ω $\leq 6\%$ of R_n
 $R_n > 4.7$ k Ω $\leq 4\%$ of R_n

1) Measured between the tags S_1 and S_3 ; for potentiometers with a tap, between the tags S_1 and S_4 and between S_4 and S_3 .

2) Minimum resistance values (in Ω) at the end.

logarithmic resistance law, with tap	$\leq 4\%$ of R_n
Insulation resistance between case and interconnected tags, after damp heat test (21 days, $T_{amb} = 40\text{ }^\circ\text{C}$, R.H. = 90 - 95 %)	$> 100\text{ M}\Omega$
Maximum permissible dissipation	
linear resistance law, at $40\text{ }^\circ\text{C}$	0.25 W
at $70\text{ }^\circ\text{C}$	0.125 W
logarithmic resistance law, at $40\text{ }^\circ\text{C}$	0.125 W
at $70\text{ }^\circ\text{C}$	0.0625 W
Test voltage for 1 min between case and interconnected tags	1000 V, 50 Hz
Limiting voltage	500 V_p 500 V_{dc}
Working-temperature range	-10 to +70 $^\circ\text{C}$
Climatic robustness	category 10/070/21 (I.E.C.68)
Effective angle of rotation	250 - 265 $^\circ$
Operating torque	0.3-2 Ncm
Permissible torque with slider at end stop	$\leq 80\text{ Ncm}$

Potentiometers without switch

Mechanical angle of rotation	$300 \pm 5^\circ$
Permissible axial load on hollow spindle	$\leq 100 \text{ N}$
on protruding spindle	$\leq 50 \text{ N}$

See also section "Potentiometers".

Potentiometers with double-pole rotary switch, 23 mm diameter

Breaking capacity	250 V _{ac} , 1.5 A, $\cos \varphi = 0.8$ 250 V _{dc} , 1.5 A
Test voltage for 1 min ¹⁾	2000 V, 50 Hz
Contact resistance, initially	$< 10 \text{ m}\Omega$
after 10 000 on-off switching operations	$< 100 \text{ m}\Omega$
Insulation resistance ¹⁾ , initially	$> 100 \text{ M}\Omega$
after test (500 hours, T _{amb} = 45 °C, R.H. = 95 %)	$> 2 \text{ M}\Omega$
Switching torque	8-12 Ncm
Switching angle	20 - 30°
Total angle of rotation	$308 \pm 5^\circ$
Backlash	$\leq 5^\circ$

See also section "Potentiometers".

¹⁾ Measured between the tags and between the case or spindle and interconnected tags.

078 5408

074 2508

078 5408
074 2508
078 5408
074 2508
078 5408
074 2508

Non-linear resistors



NTC thermistors	page C3
PTC thermistors	page C87
Voltage-dependent resistors	page C159
Light-dependent resistors	page C225

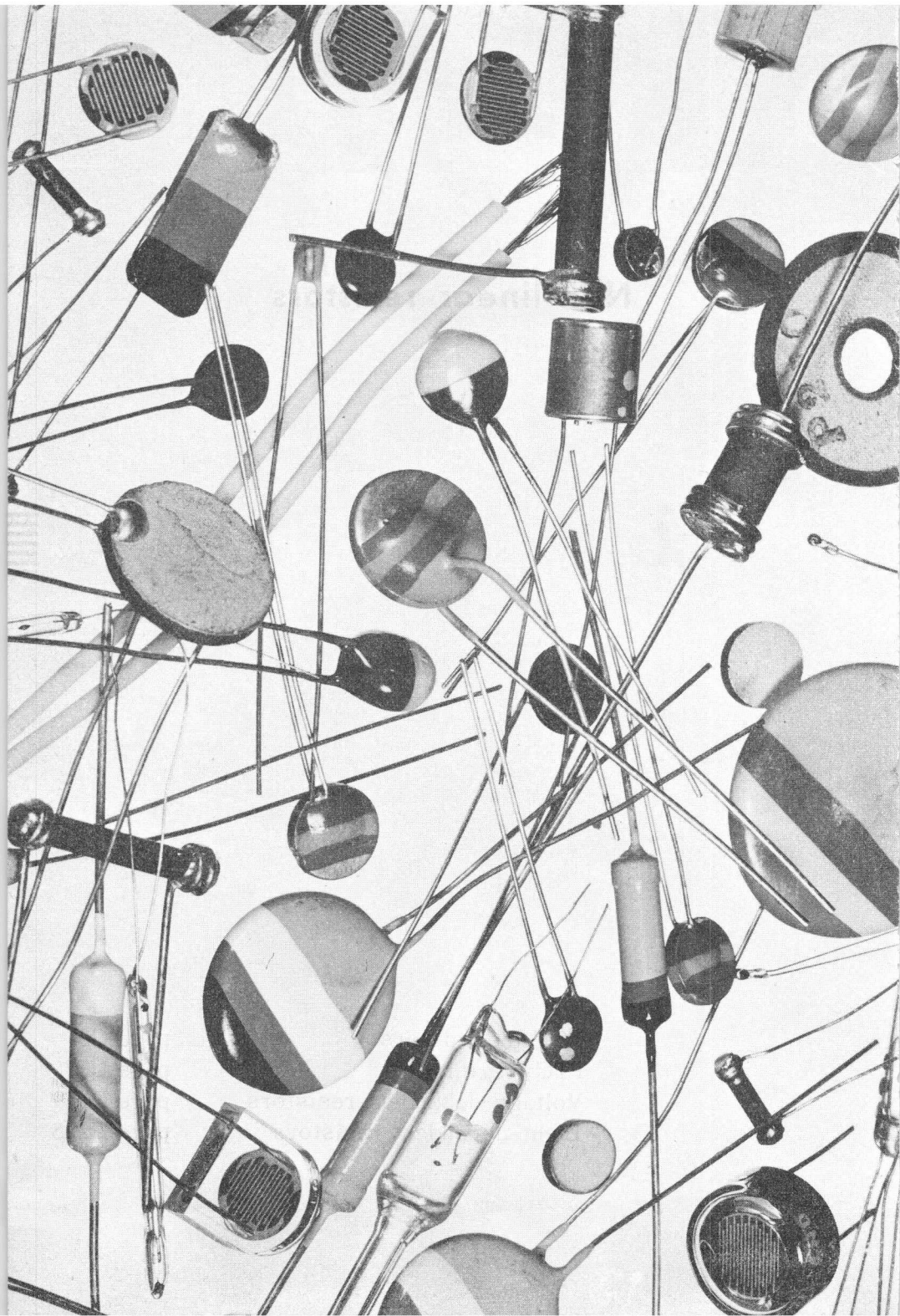

NTC THERMISTORS



INTRODUCTION

NTC thermistors are resistors with a high negative temperature coefficient of resistance. They are prepared from oxides of the iron group of transition elements e.g. Cr, Mn, Fe, Co or Ni. These oxides have a high resistivity in the pure state, but can be transformed into semiconductors by adding small amounts of foreign ions which have a different valency.

Examples are:

- a) iron oxide Fe_2O_3 , where a small part of the Fe^{3+} -ions are replaced by Ti^{4+} -ions. These Ti^{4+} -ions are compensated by an equal amount of Fe^{2+} -ions in order to maintain electroneutrality. At low temperatures the extra electrons of the Fe^{2+} -ions are situated on Fe-ions next to the Ti^{4+} -ions, but at higher temperatures they are gradually loosened from these sites and contribute to the conductivity. In this case we have obtained an electron- or n-type semiconductor.
- b) Nickel oxide NiO , or cobalt oxide CoO , with a partial substitution of Li^{1+} -ions for the Ni^{2+} - or Co^{2+} -ions. In this case the Li^{1+} -ions are compensated by an equal amount of Ni^{3+} - or Co^{3+} -ions. At low temperatures the so-called electron-holes (missing electrons) of the trivalent ions are situated near the foreign ions and again free to move through the crystals at higher temperatures. In this case virtually a positively charged particle is the mobile charge carrier and therefore these materials are called p-type semiconductors.

Stabilizing oxides are sometimes added to obtain a better reproducibility and stability of the characteristics. Which of these compositions is used entirely depends on the required temperature coefficient and the specific resistance.

In both cases a) and b) the conductivity σ of the materials can be generally described by

$$\sigma = n e \mu$$

where e represents the unit of electric charge and n and μ the concentration and the mobility of the charge carriers respectively.

Both n and μ depend on temperature. For n this dependence is an exponential one, according to a Boltzmann law.

$$n \propto e^{-q_1/kT}$$

where q_1 is related to the electrostatic binding energy of the carriers to the foreign ions. For the mobility it is not certain whether the temperature depend-

ence is comparable to that of charge carriers in germanium-type semiconductors ($\mu \propto T^{-b}$) or comparable to that of ionic conductors where the ions need a thermal activation energy q_2 for each jump to a neighbour site (hopping process). In the latter case the temperature dependence is described by

$$\mu \propto \frac{e^{-q_2/kT}}{T}$$

The total temperature dependence of the conductivity is generally proportional to:

$$\sigma \propto T^{-c} \cdot e^{-(q_1 + q_2)/kT}$$

where q_2 may be zero. In practice the exponential factor is the most important one, so that the resistance variation of these thermistors in a broad temperature region can be represented by the simple formula

$$R = A e^{B/T}$$

MANUFACTURING PROCESS

The manufacturing process can be compared with that used in ceramic industry. After intensive mixing and after addition of a plastic binder the mass is shaped into the appropriate forms by extrusion (rods) or hydraulic pressing (discs). The parts are then fired at a temperature high enough to sinter the constituent oxide. The final step is the making of the electrical contacts. This is done in the usual way by burning in with silver paste or by other methods e.g. electroplating or metal spraying.

Miniature NTC thermistors are made by applying a drop of oxide paste between two parallel platinum alloy wires, followed by drying and sintering. The platinum alloy wires are 60 μm in diameter and 0.25 mm apart. By the sintering process the bead is shrunk onto the wires, thus establishing a solid and reliable contact. For most applications the miniature NTC thermistors are mounted in glass for protection against influence by aggressive gases and fluids.

\propto = direct proportional with

ELECTRICAL PROPERTIES

RESISTANCE VERSUS TEMPERATURE CHARACTERISTICS

As is shown in the introduction the relation between resistance and temperature of an NTC thermistor can be approximated by:

$$R = Ae^{B/T}, \quad (1)$$

where R is the resistance value at an absolute temperature T , A and B being constants for a given resistor and e the base of the natural logarithm ($e = 2.718$). This equation is illustrated in Fig. 1 where R has been plotted against the temperature in $^{\circ}\text{C}$.

This is quite in contrast with the behaviour of metals, with which in first approximation the resistance increases proportionally to the absolute temperature.

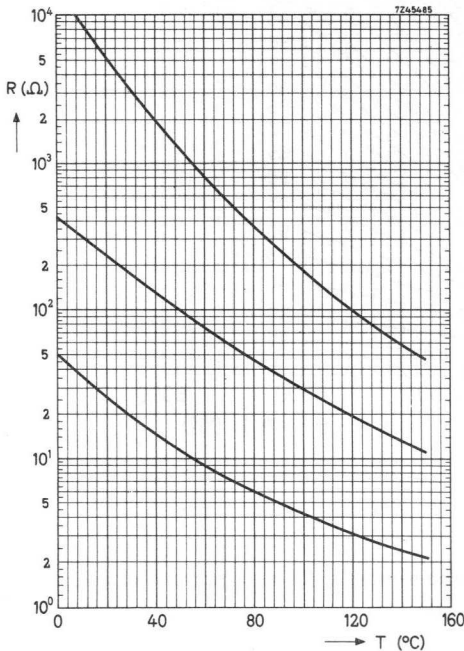

Fig. 1.
Resistance R as a function of temperature drawn for three different values of A and B .

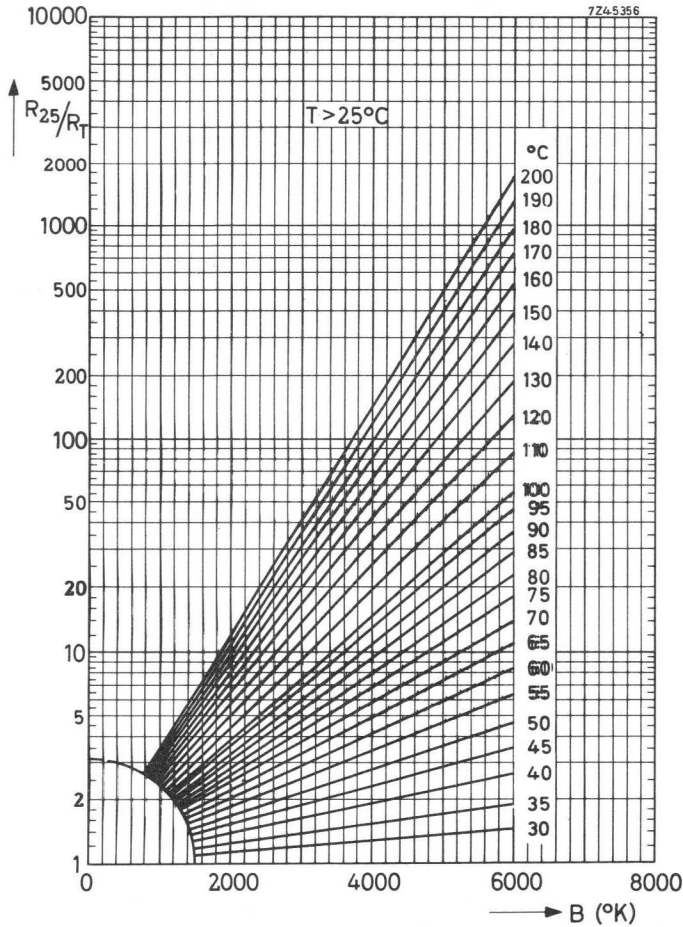

Fig.2.
 R_{25}/R_T as a function of the B-value with the temperature as a parameter.
 Temperatures above 25 °C.

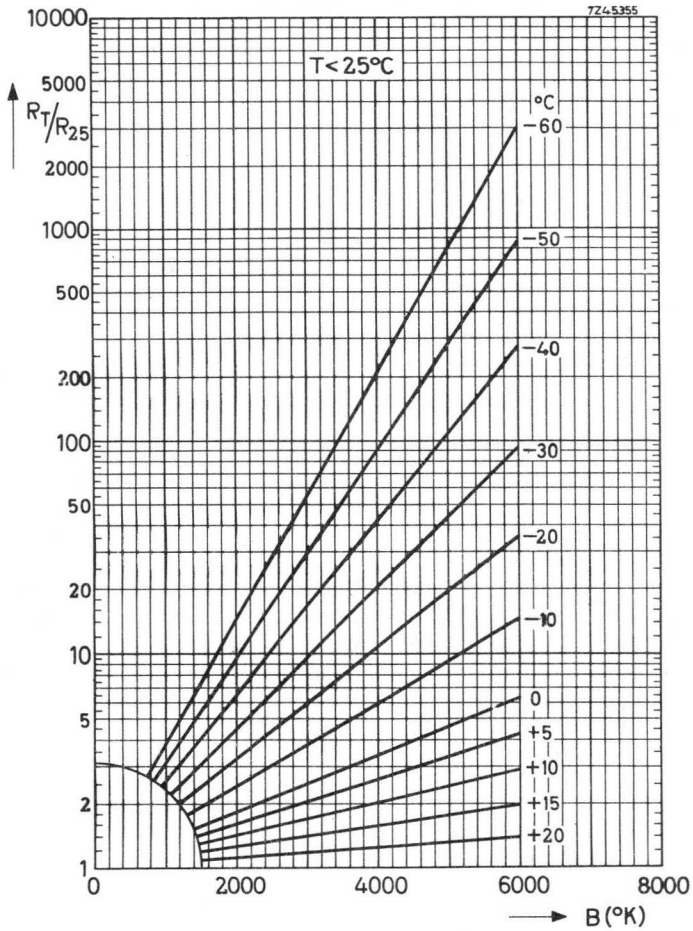

Fig. 3.
 R_T/R_{25} as a function of the B-value with the temperature as a parameter.
 Temperatures below 25°C .

For a given NTC thermistor the value of B may be found in the following way. The resistance value is measured at two temperatures, T_1 and T_2 ,

$$R_1 = Ae^{B/T_1} \text{ and } R_2 = Ae^{B/T_2};$$

dividing these two, yields:

$$\frac{R_1}{R_2} = e^{(B/T_1 - B/T_2)},$$

or:

$$\log R_1 - \log R_2 = B (1/T_1 - 1/T_2) \log e,$$

which gives:

$$B = \frac{1}{\log e} \cdot \frac{\log R_1 - \log R_2}{1/T_1 - 1/T_2} \quad (2)$$

In practice B is found not to be a true constant; with increasing temperature there are small deviations.

A better formula for the resistance value is:

$$R = AT^C e^{B/T},$$

where C is a small positive or negative number and in some cases is zero. From eq. (1) the temperature coefficient of an NTC may be derived:

$$\alpha = \frac{1}{R} \cdot \frac{dR}{dT} = - \frac{B}{T^2} \quad (3)$$

For the different materials the constant B may vary between 2000 and 5500 °K. A value of e.g. 3600 yields $\alpha = -4\%$ per degree at a temperature of 300 °K.

For calculating the resistance of an NTC at a given temperature, when R_{25} and B are given in the data, the graphs of Fig. 2 and 3 may be used, where for different B-values R_{25}/R_T and R_T/R_{25} are plotted against the B-value with the temperature of the NTC thermistor as parameter.

VOLTAGE VERSUS CURRENT CHARACTERISTICS

It is interesting to investigate the relation between current and voltage drop over the NTC thermistor when the latter is heated by this current to a temperature much higher than the ambient temperature. Fig.4 shows this relation for an arbitrary sample. This so-called static characteristic, plotted on a double logarithmic scale, was measured at a constant ambient temperature and the readings of V were taken after equilibrium had been reached. For very small currents, the power consumption is too small to register a distinct rise in temperature or

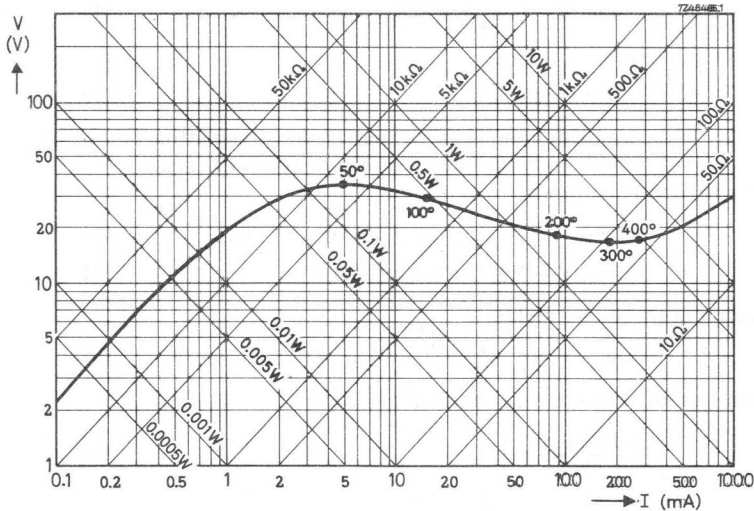

Fig. 4. Voltage versus current characteristics of an NTC thermistor.

a decrease in resistance. In that part of the characteristic the relationship between voltage and current is linear. For the sample chosen this linearity ends at approximately 0.01 W.

At a certain value of I the voltage reaches a maximum value and will decrease as the current increases still further.

Assuming:

- (a) a constant temperature throughout the body of the thermistor;
- (b) the heat transfer to be proportional to the difference in temperature between thermistor and surrounding medium (which is true for low temperatures);
- (c) the resistance to be defined by eq. (1)

$$R = A e^{B/T};$$

the following may be written:

$$\log_e R = \log_e A + B/T \tag{4}$$

In case of equilibrium

$$W = D (T - T_0), \tag{5}$$

in which T_0 is the ambient temperature and D the dissipation factor, i.e. the power needed for a rise in temperature of one degree centigrade.

From eqs (5) and (4) follows:

$$\log_e V + \log_e I = \log_e D + \log_e (T - T_0), \tag{6}$$

$$\log_e V - \log_e I = \log_e A + B/T \tag{7}$$

Combination of these two yields:

$$\log_e V = \frac{1}{2} \log_e AD + \frac{1}{2} \log_e (T - T_0) + B/2T \tag{8}$$

This form has an extreme as a function of T if:

$$\frac{d \log_e V}{dT} = 0 \tag{9}$$

In that case

$$\frac{1}{2(T - T_0)} - \frac{B}{2T^2} = 0 \tag{10}$$

which is true only for those values of T which answer to the equation:

$$T^2 - BT + BT_0 = 0, \tag{11}$$

$$T_{\max} = \frac{1}{2}B \pm \sqrt{\frac{1}{4}B^2 - BT_0} \tag{12}$$

(The value with the minus sign gives the temperature corresponding to the maximum value of the voltage). Only if $B > 4T_0$ will this maximum be present. For the practical values of B (2000-4000 °K) the temperature T_{\max} lies between 85 °C and 45 °C.

From these considerations, which are valid for stationary circumstances only, it follows that the temperature corresponding to the maximum voltage only depends on the B -value of the material and not the actual resistance value.

THERMAL TIME CONSTANT OF NTC THERMISTORS

If the thermistor has a uniform temperature during cooling, the following equation is valid for the cooling of an NTC in the time interval dt :

$$-HdT = D (T - T_0) dt \quad (13)$$

in which T_0 is the ambient temperature and H the heat capacity of the resistor in joules per degree C.

Eq. (13) yields:

$$(T - T_0) = (T_1 - T_0) e^{-t/\tau} \quad (14)$$

The value $\tau = H/D$ is termed the thermal time constant, and represents the time required for a thermistor to change 63.2% of the total difference between its initial and final body temperatures when subjected to a step function change in temperature under zero-power conditions.

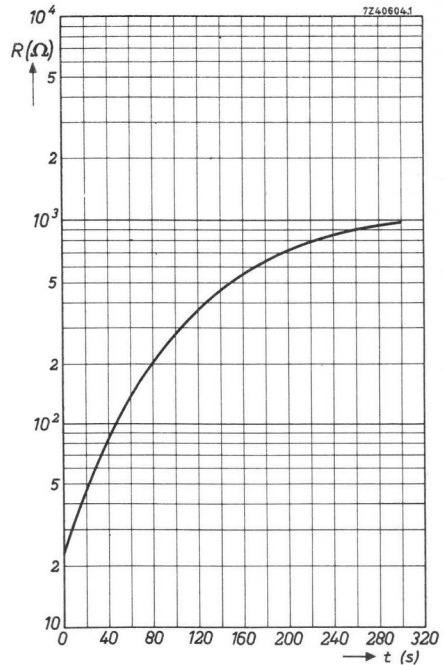

Fig. 5.
Variation of resistance with time under normal cooling conditions of a rod type NTC. Ambient temperature 25 °C.

STW

RESEARCH CENTER

1950

THE HISTORY

1950

1950

HOW TO MEASURE NTC THERMISTORS

- (1) The published R_T values are measured at the temperature T .
- (2) The published B -value at 25°C is the result of a measurement at 25°C and one at 50°C . So please use these two temperatures for checking.

The following general precautions have to be taken when measuring NTC thermistors:

- (1) Never measure thermistors in air as this is quite inaccurate and easily gives deviations of 1 or 2°C . For measurement at room temperature or below, use petrol or some other non-conductive and non-aggressive fluid. For higher temperatures use oil, preferably silicon oil.
- (2) Use a thermostat with a precision of at least 0.1°C .
Even if the liquid is well stirred, there is still a temperature gradient in the fluid.
So measure the temperature as close to the NTC as possible.
- (3) After placing the NTC in the thermostat wait until temperature equilibrium between the NTC and the fluid is obtained. For some types this may take more than 1 minute.
- (4) Keep the measuring voltage as low as possible otherwise the NTC will be heated by the measuring current. Miniature NTC thermistors are specially sensitive to measuring voltages. Voltages of less than 0.5 V are recommended.
- (5) For high temperature measurements it is recommended to apply stem correction. See also "How to measure PTC thermistors".

SPREAD

The R_{25} and B-value are specified with a certain spread. The tolerance on 25 °C resistance is normally $\pm 20\%$. The B-value has in most cases a tolerance of $\pm 5\%$. Due to the spread in B-value, the deviation from the nominal curve at other temperatures than 25 °C can be greater than the specified tolerance at 25 °C. Fig. 6

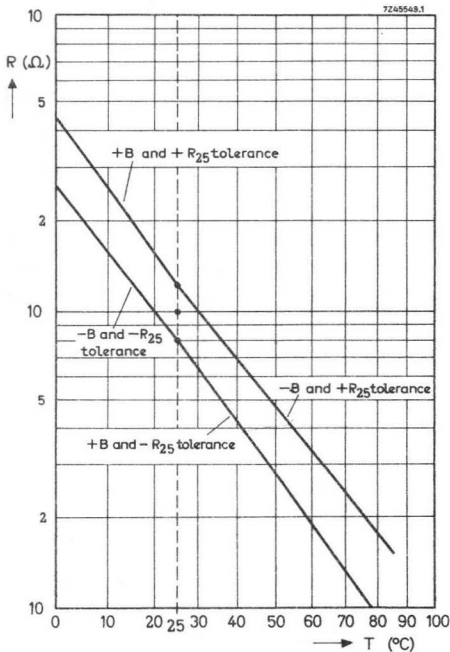

Fig. 6.
The influence of the tolerance on the B-value.

shows this for a resistor of 10 k Ω .

Starting from 25 °C the upper curves give the limit resistance values for combinations of:

- (a) +B and + R_{25} tolerance going from 25 °C to lower temperatures;
- (b) -B and + R_{25} tolerance going from 25 °C to higher temperatures.

The lower curves give the limit resistance values for combinations of:

- (c) -B and - R_{25} tolerance going from 25 °C to lower temperatures;
- (d) +B and - R_{25} tolerance going from 25 °C to higher temperatures.

The resistance value will thus always be between the upper and the lower curves, although the unfavourable combinations will obviously seldom occur in practice. For some applications a close tolerance at a given temperature is required. In these cases special selections can be made.

CHOICE OF TYPE

When an NTC thermistor has to be selected for a certain purpose, the following questions have to be considered:

- (1) Which form is best suited for the purpose?
The normal types are cylindrical rods, discs or beads.
- (2) What is the resistance value and temperature coefficient required?
- (3) What is the power to be dissipated
 - (a) without perceptible change in resistance value due to heating-up
 - (b) with maximum change in resistance value?
- (4) What is the required thermal time constant?

Whenever it is impossible to find an NTC thermistor to fulfil all requirements, it is often more economical to adapt the values of other circuit components to the value of a series-manufactured NTC. Sometimes, with simple parallel and series resistors, a standard NTC can be used where otherwise a special type would have been necessary.

If no suitable combination can be found the development of a special type can be considered. In this case a specification of the requirements is necessary. In addition a description of the circuit in which the NTC has to be used is most useful.

DEVIATING CHARACTERISTICS

The following example explains the resistance values resulting from combinations of NTC's with normal resistors.

Suppose for compensation purposes an NTC is wanted with a resistance value of 50Ω at 30°C and 10Ω at 100°C . A standard type having this characteristic is not included in our program. The problem may, however, be solved by using a standard NTC and two fixed resistors. If an NTC disc with a cold resistance of 130Ω is mounted in a series and parallel arrangement with two fixed resistors of 6Ω and 95Ω as illustrated in Fig. 7, the resistance of the combination at 30°C and at 100°C will meet the requirements. Fig. 8 shows the new resistance versus temperature graph, together with that of the NTC thermistor.

An adaption of this kind should be calculated for every individual case. It should be remembered of course that the temperature-coefficient of the combination will always be lower than that of the NTC thermistor alone. This is clearly illustrated by Fig. 9, where the change in the resistance/temperature graph is shown for different values of series and parallel resistors.

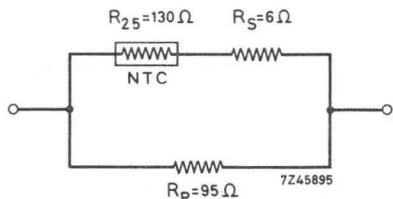

Fig. 7.
NTC thermistor connected in series and parallel with two fixed resistors to obtain deviating characteristics.

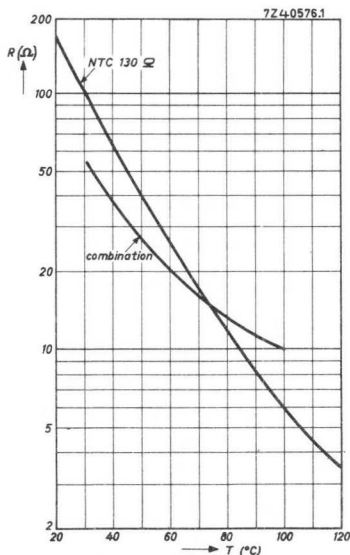

Fig. 8.
Resistance versus temperature graph of the circuit of Fig. 13.

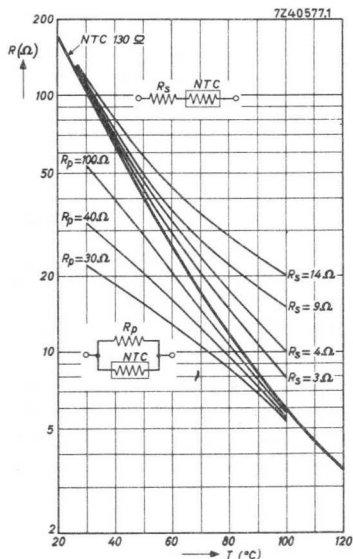

Fig. 9.
Resistance versus temperature graphs of an NTC in combination with different series or parallel resistors.

SOLDERING DISC NTC THERMISTORS

It is often necessary to solder mounting brackets or connecting leads to disc NTC's either to provide efficient thermal contact or to facilitate their mounting. Owing to the ceramic nature of the thermistor and its silver coating, special precautions must be taken to ensure a satisfactory joint.

The iron, its temperature, the solder and flux as well as the material of the bracket all affect the result.

The soldering iron

This should have a wedge shaped copper bit with an angle of 30° to 45°. Before use, and when necessary during use, it should be cleaned and tinned with the solder recommended below. It is most important that the bit temperature is maintained between 275 °C and 300 °C. A means of measuring and controlling this temperature is considered necessary.

The solder

To prevent migration of the silver coating of the thermistor into the solder and eventual failure of the joint, a silver rich solder should be used. A satisfactory composition is 56% tin, 37% lead and 7% silver, without a resin core ¹⁾.

The flux

The correct iron temperature and an approved flux are the two most important factors in this process. It is recommended to use a flux of the following composition:

1 kg colofonium
10 g ureum
500 ml aethylalcohol 98% ²⁾.

The bracket or wire

Tinned copper wire is satisfactory but the end should be bent into a loop. It is best to avoid sizes heavier than 0.5 mm. Brackets should be electro-tinned copper not more than 3 mm thick. A hole, preferably star shaped and about 3 mm diameter, in the bracket should coincide with the centre of the thermistor disc.

- ¹⁾ This is available from Multicore Solders Ltd., of Hemel Hempstead, England, with a diameter of 1.6 mm.
- ²⁾ Also entirely satisfactory is Dynoline 59810 manufactured by DYNA of 36, Avenue Gambetta, Paris 20, France. Sufficient flux to cover the whole thermistor surface must be used.

The process

The whole face of the thermistor should be coated with special flux and the bracket or wire held in position. About a 6 mm length of solder is melted onto the iron and transferred to the joint so that the solder flows over the bracket onto the thermistor. The soldering time should be kept as short as possible. Preheating of the thermistor on a hot plate at 80 °C to 100 °C helps to ensure rapid and reliable soldering. The soldering must be completed before the flux hardens.

Unless this process is followed, it is not possible to ensure entirely satisfactory results (and no responsibility can be taken for failures).



APPLICATIONS

According to the essential properties of the NTC their applications may be classified into three main groups:

- (I) Applications in which advantage is taken of the dependence of the resistance on the temperature:

$$R = f(T)$$

This group is split into two subsections:

- (a) The temperature of the NTC thermistor is determined only by the temperature of the ambient medium (or by the current in a separate heater winding).
- (b) The temperature of the NTC thermistor is also determined by the dissipation in the NTC thermistor itself.

- (II) Applications in which the time dependence is decisive.

In that case the temperature is considered as a parameter, and is written:

$$R = f(t)$$

This group comprises all applications which make use of the thermal inertia of NTC thermistors.

- (III) The third group of applications uses mainly the property of the temperature coefficient being highly negative:

$$\alpha < 0$$

Also in this group applications are listed which take advantage of the fact that the absolute value of the temperature coefficient is so high, that a part of the $V = f(I)$ curve shows a negative slope.

REMARKS ON THE USE OF NTC THERMISTORS

Do not use thermistors in parallel to obtain a higher dissipation as one of the thermistors may heat up and take all the current while the others remain cold.

Do not use unprotected thermistors in conducting fluids or aggressive and reducing gases as they may cause a change in characteristics.

For temperature measurements do not use a too high voltage on the NTC thermistor as it may heat-up the thermistor, thus giving incorrect readings. The dissipation constant is an indication for the maximum permissible measuring power.

Do not solder-on NTC discs without consulting the soldering instructions.

Some of the more familiar application circuits in the entertainment and industrial field are given on the following pages.

APPLICATION EXAMPLES

Temperature measurement.
Industrial and medical thermometers.

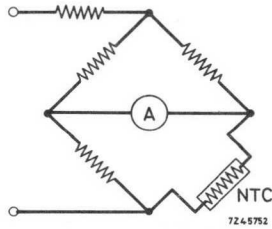

Temperature measurement in cars.
Cooling water measurements with bi-metal or differential milliamper meters.

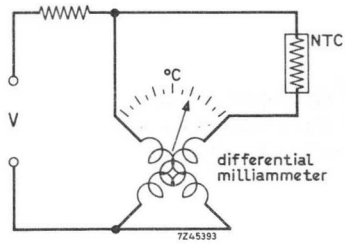
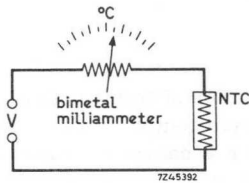

Temperature control.
The bridge incorporating an NTC and a relay can be used for a number of applications where control of temperature with a relay is acceptable.

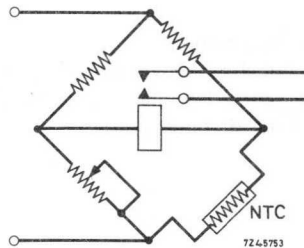

Flow measurement of liquids.
The temperature difference between T_1 and T_0 is a measure for the velocity of the fluid.

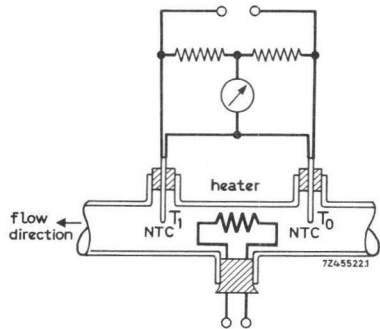

Compensation of frame deflection coils.
The positive temperature coefficient of the copper windings is compensated by means of an NTC thermistor.

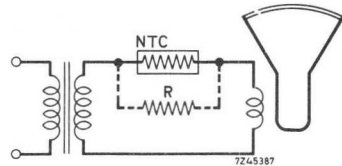

Heat chain protection.
Protection against current surges in TV and radio circuits.

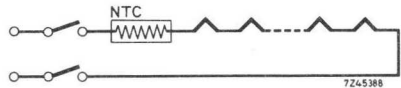

Protection of Si-diode and switch.
Protection in TV circuits using Si-diodes as rectifiers.

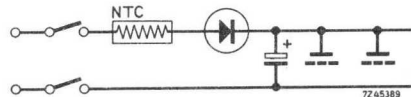

Shunt of dial lamps.
In case of breakdown of dial lamp the NTC becomes low ohmic and the heater chain is not disconnected.

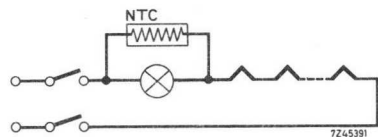

Model trains.

As soon as the train comes on the isolated supply strip it stops. The NTC heats up and gradually the train starts again.

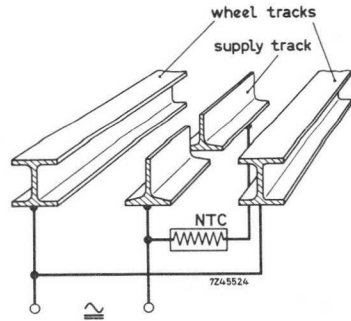

Delaying action of relays.

Due to the thermal inertia of the NTC it takes some time before the relay is activated. If necessary the NTC can be short-circuited after the relay is activated thus leaving the NTC time for cooling.

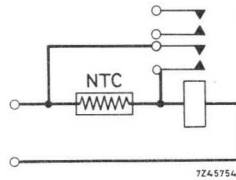

Temperature compensation in transistor circuits

Push-pull compensation

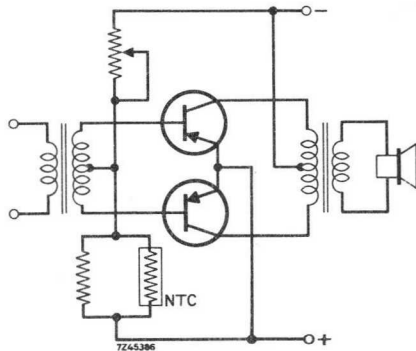

Gain compensation

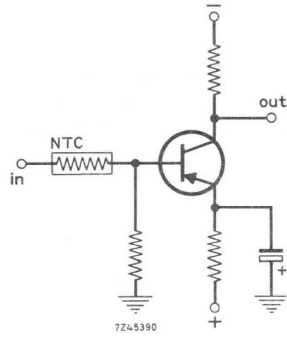

Pnp-npn compensation

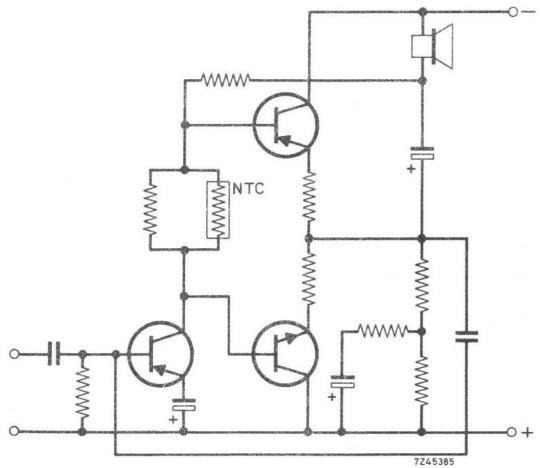

NTC THERMISTORS standard disc types

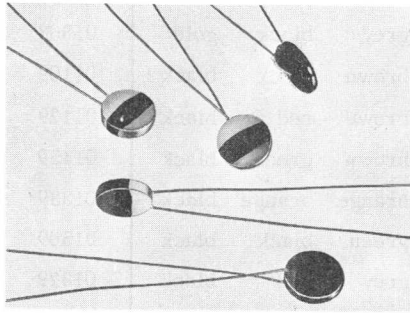

RZ 19269-6

These disc type NTC thermistors are available in three versions:

- | | |
|---------------------------|-------|
| without leads | Fig.A |
| with leads | Fig.B |
| soldered on a metal strip | Fig.C |

Catalog number 2322 610 For the suffix of this number see table.

Dimensions in mm

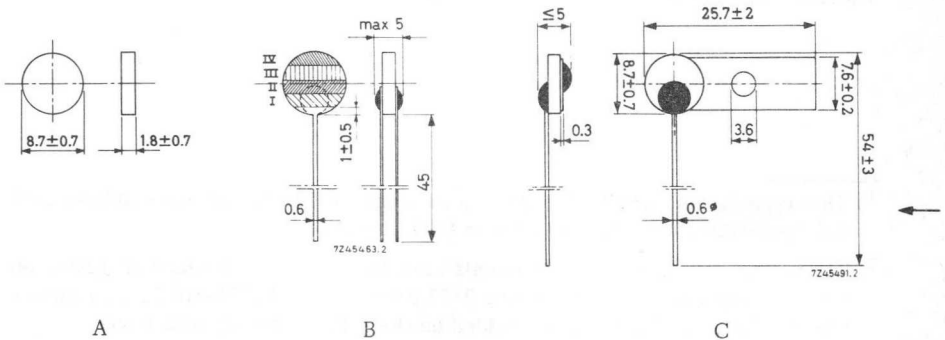

R ₂₅ (Ω)	B-value at 25 °C (°K)	colour code for version with leads			suffix of catalog number		
		I	II	III	without leads	with leads	with a metal strip
2.2	2650	red	red	gold	01228	11228	
4	2800	yellow	black	gold	01408	11408	90012
6	2800	blue	black	gold	01608	11608	
8	2900	grey	black	gold	01808	11808	90015
10	2950	brown	black	black	01109	11109	
12	2950	brown	red	black	01129	11129	
15	3000	brown	green	black	01159	11159	
33	3250	orange	orange	black	01339	11339 ¹⁾	
50	3300	green	black	black	01509	11509	90016
82	4400	grey	red	black	01829	11829	
130	4600	brown	orange	brown	01131	11131	90004
500	5200	green	black	brown	01501	11501	90017
1300	5450	brown	orange	red	01132	11132	90018

Tolerance on R ₂₅	±20 % ²⁾
Tolerance on the B-value	± 5 %
Maximum dissipation	1 W
Maximum temperature	120 °C
Dissipation factor	10 mW/deg C
Thermal time constant	60 s

¹⁾ This type is also available with a lead length of 65 mm, catalog numbers 2322 610 90039 (20%) and 2322 610 90038 (10%) respectively.

²⁾ The versions of Fig. A and B are also available with a tolerance of ±10 % on request. The catalog numbers are 2322 610 02... and 2322 610 12... respectively. A silver colour band is added on the ±10 % version with leads.

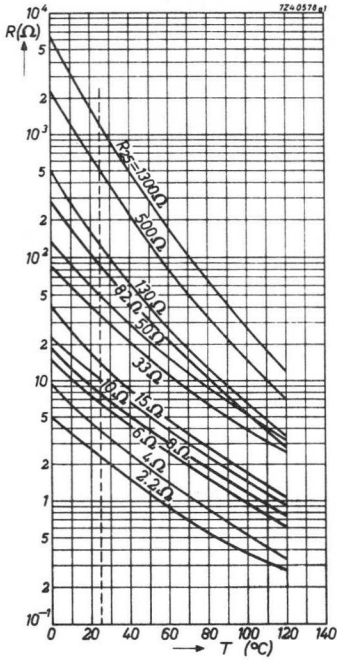

Resistance/temperature characteristics

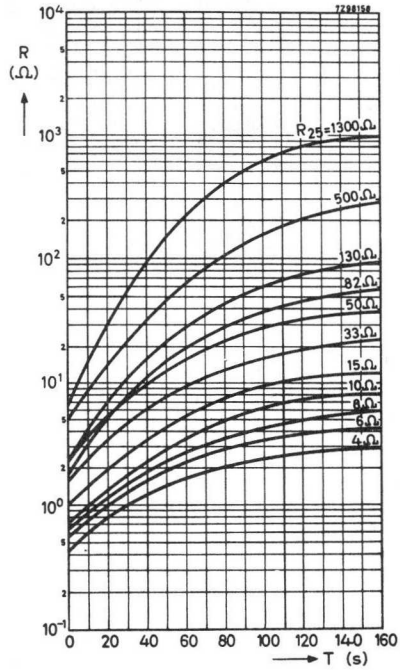

Cooling characteristics

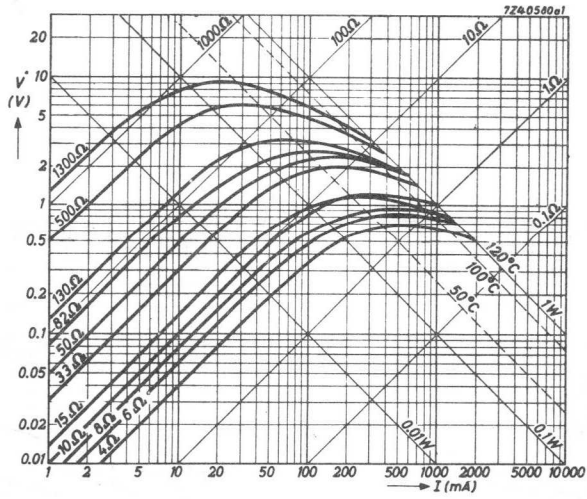

Voltage/current characteristics

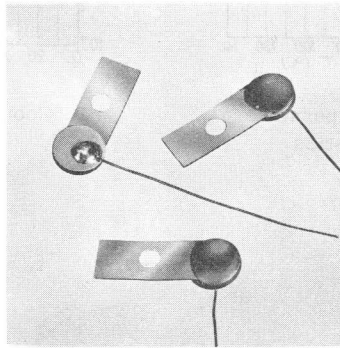

RZ 19269-4

Disc type NTC thermistor soldered on a metal strip
for simple mounting with nut and bolt

NTC THERMISTORS

for radio and television

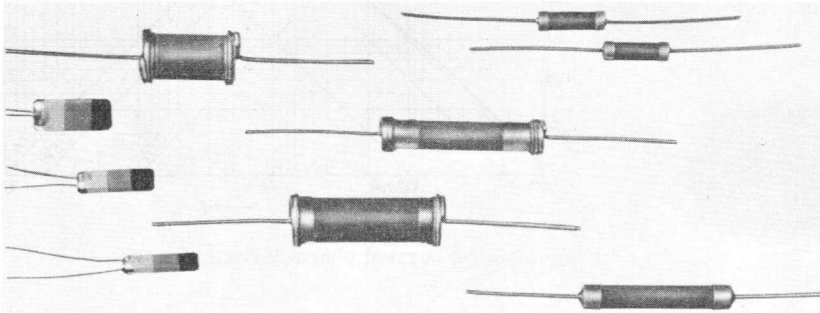

RZ 19269-2

application	R ₂₅ (Ω)	B at 25 °C approx. (°K)	W _{max} (W)	normal operating conditions		dissipation factor approx. (mW/deg C)	catalogue number
				(mA)	(Ω)		
compensation positive tem- perature coeff. of deflection coils	1.1 ± 20%	2650	1	2200	0.15-0.25	14	2322 619 90002
	32 + 30%/-20%	4200	1	1000	0.7 -1.1	14	619 90003
	6 ± 20%	2800	1	1000	~ 1	10	2322 610
	10 ± 20%	2950	1	900	~ 1.1	10	610
	12 ± 20%	2950	1	800	~ 1.2	10	610
	15 ± 20%	3000	1	800	~ 1.2	10	610
	33 ± 20%	3250	1	700	~ 1.4	10	610
shunt dial lamp	3870 - 7750	3000	3	200	60-90	10	2322 620 90001
heater chain protection	800 - 1315	3800	2	200	36-52	16	2322 621 90004
	6700 - 12600	3000	3	100	200-280	10	621 90003
	300 - 500	3700	2.5	300	25-32	30	622 90005
	645 - 1210	3600	5	300	35-48	60	622 90004
	1750 - 3250	3000	3	100	200-250	20	622 90002
	2470 - 5370	4000	4	300	38-50	24	622 90001



For dimensions and characteristics see following pages

*For more information see standard disc thermistors 2322 610 (page C27)

2322 619 90002

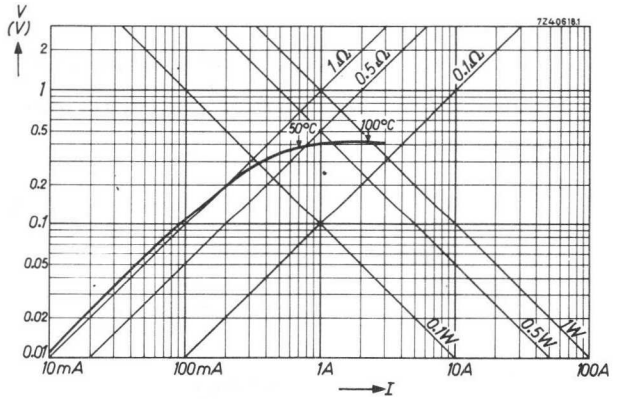
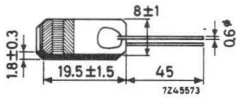

Voltage/current characteristics

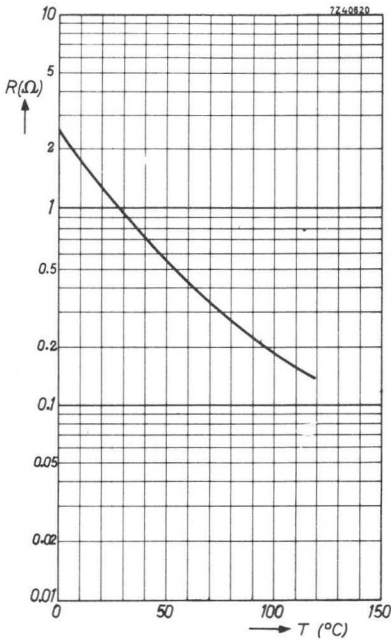

Resistance/temperature characteristic

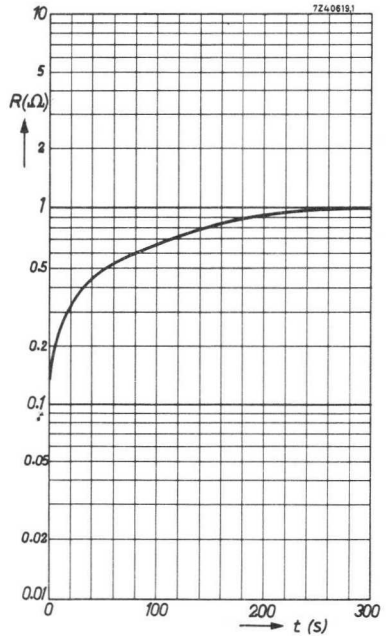

Cooling characteristic

2322 619 90003

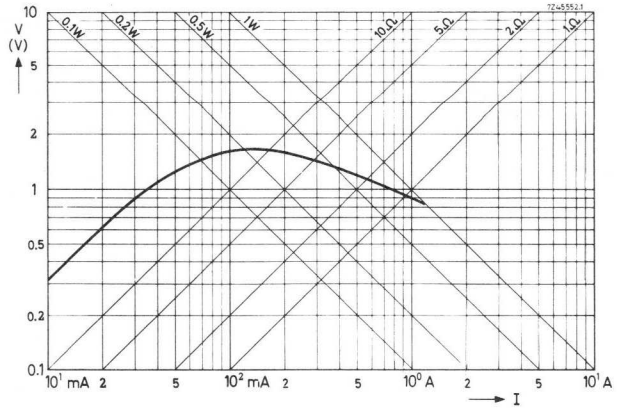
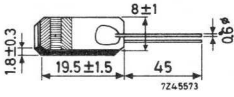

Voltage/current characteristic

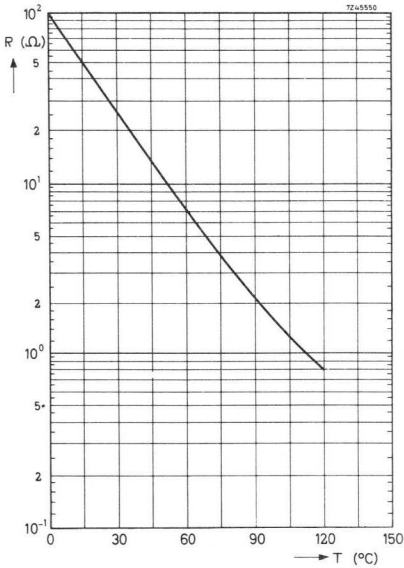

Resistance/temperature characteristic

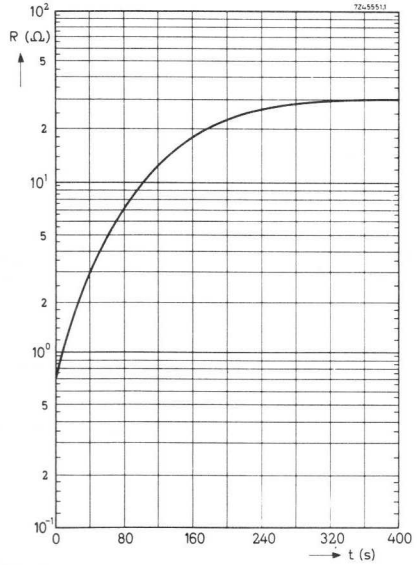

Cooling characteristic

2322 620 90001

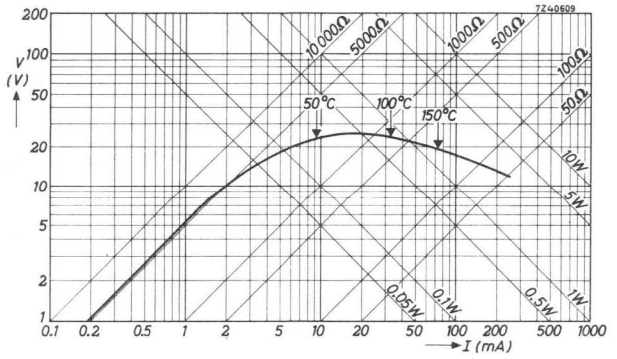
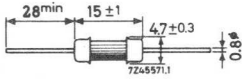

Voltage/current characteristic

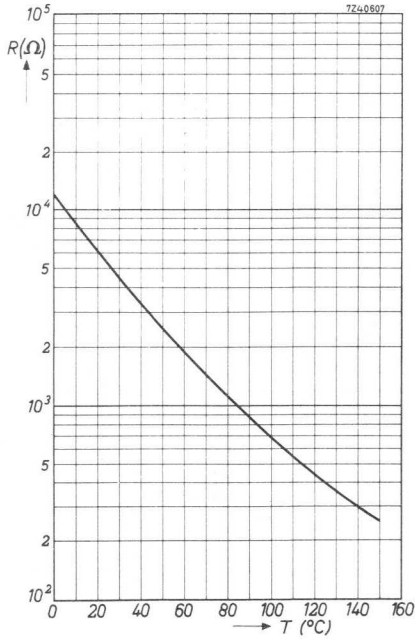

Resistance/temperature characteristic

2322 621 90003

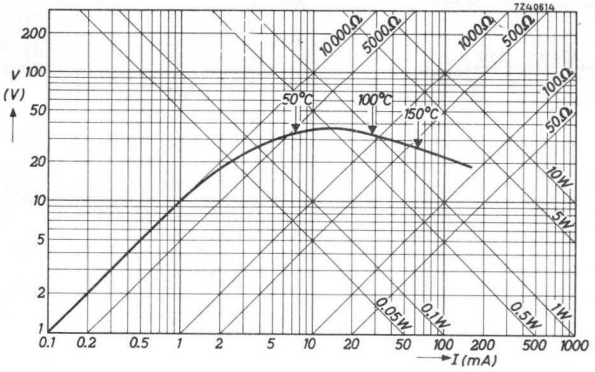
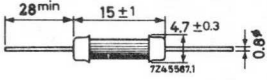

Voltage/current characteristic

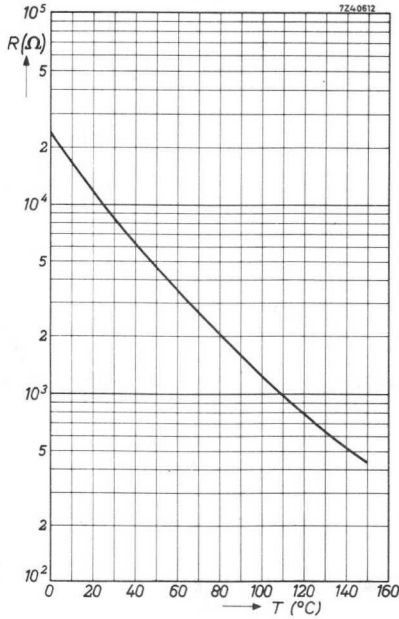

Resistance/temperature characteristic

2322 610
2322 619 - 622

NTC THERMISTORS
 for radio and television

2322 621 90004

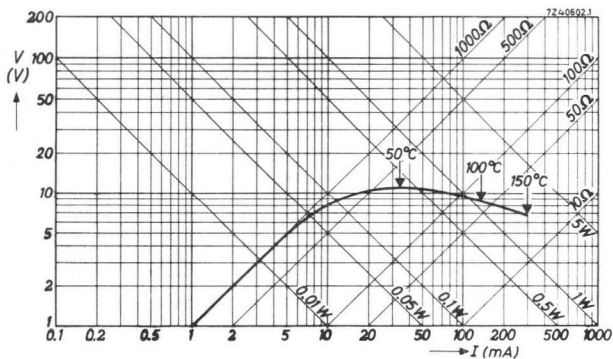
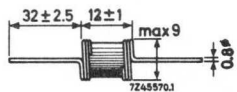

Voltage/current characteristic

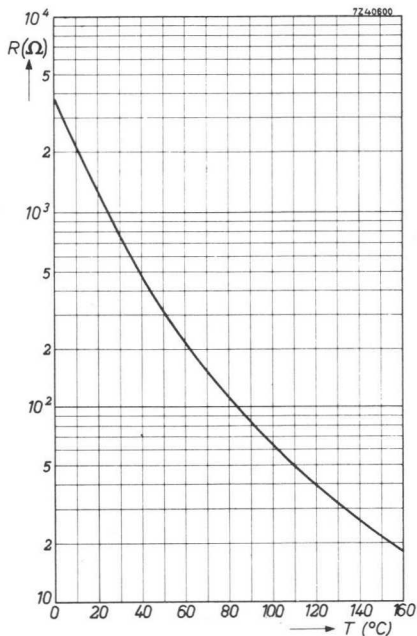

Resistance/temperature characteristic

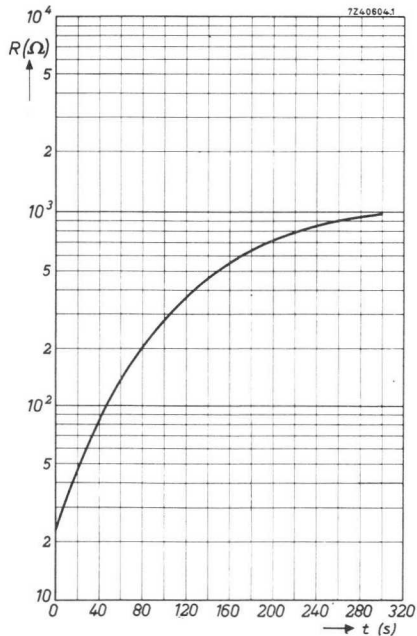

Cooling characteristic

2322 622 90001

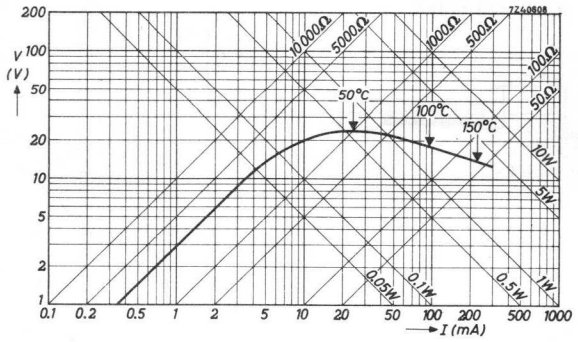
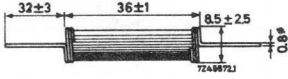

Voltage/current characteristic

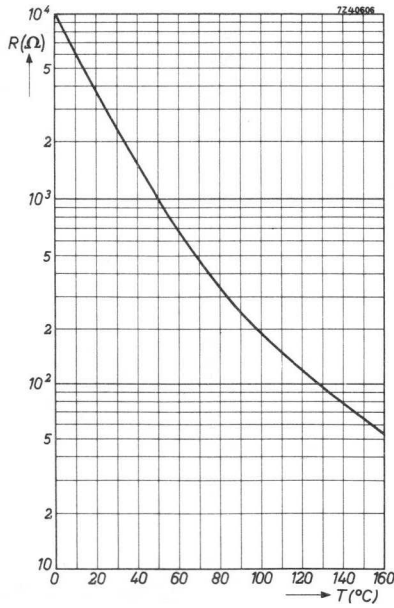

Resistance/temperature characteristic

2322 610
2322 619 - 622

NTC THERMISTORS
 for radio and television

2322 622 90002

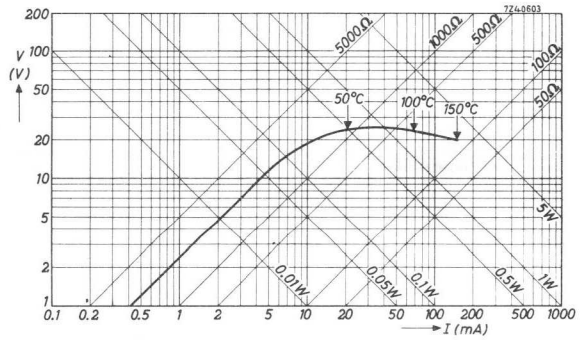
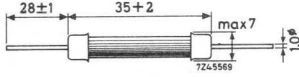

Voltage/current characteristic

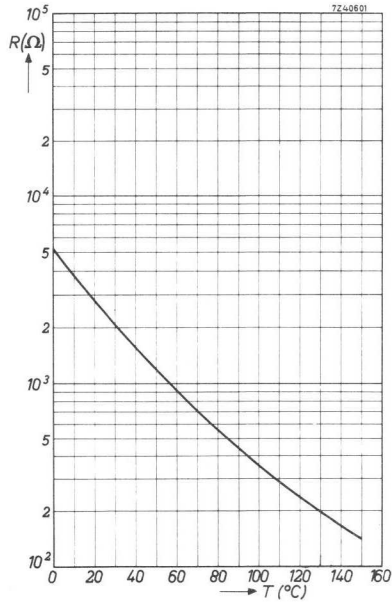

Resistance/temperature characteristic

2322 622 90004

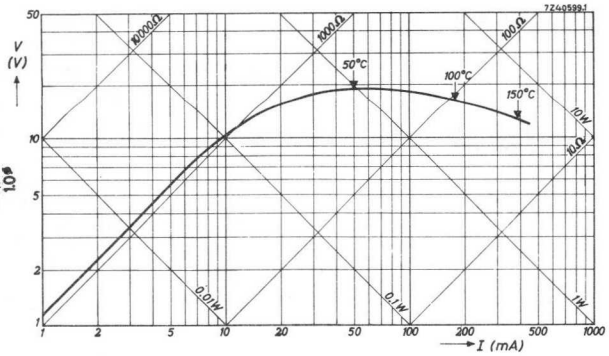
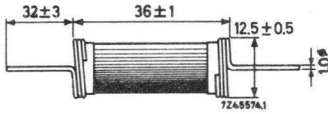

Voltage/current characteristic

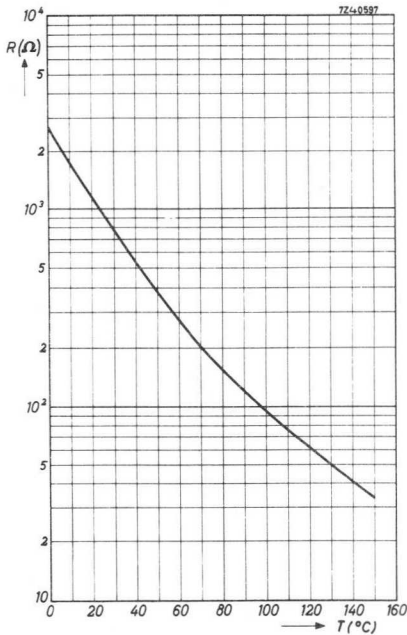

Resistance/temperature
characteristic

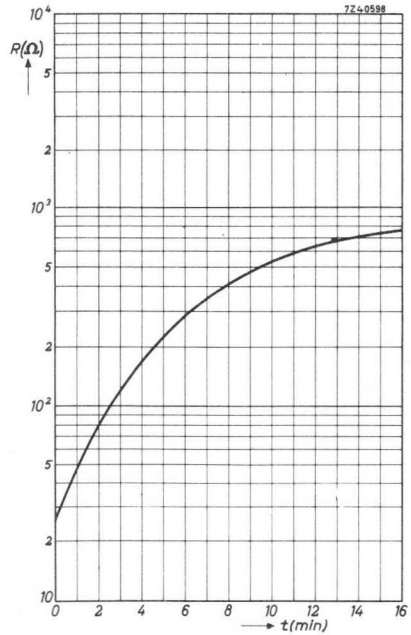

Cooling characteristic

2322 610
2322 619 - 622

NTC THERMISTORS
 for radio and television

2322 622 90005

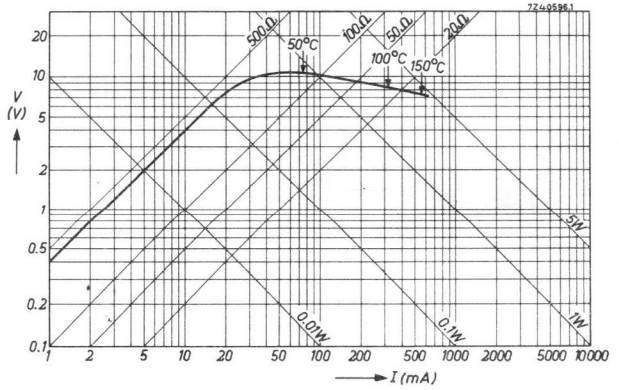
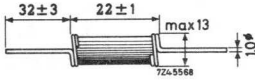

Voltage/current characteristics

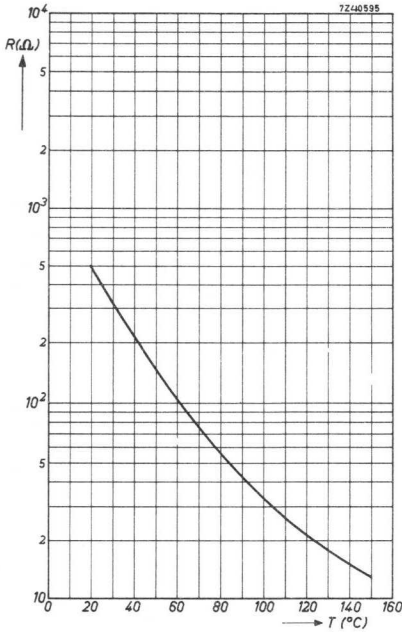

Resistance/temperature characteristic

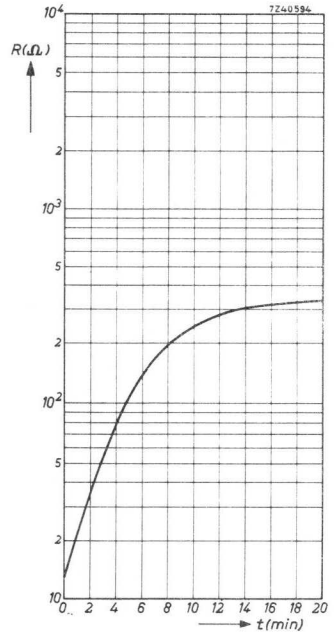

Cooling characteristic

NTC THERMISTORS for motor cars

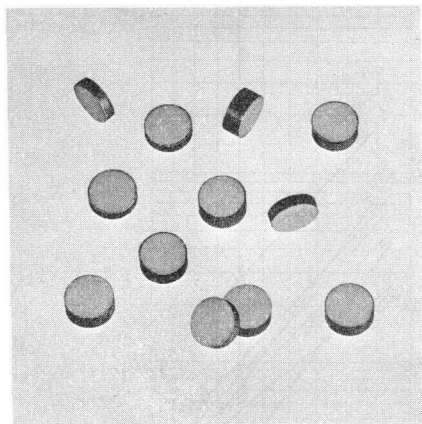

RZ 19269-3

This range of discs has been developed for temperature sensors for the cooling water in motor cars. The NTC's are specified at a medium temperature (40-50 °C) and a higher temperature (96.5 to 100 °C), so that a high accuracy at the working temperature is obtained.

They are also suitable for temperature control in household appliances, such as washing machines.

R25 (Ω)	R40 (Ω)	R50 (Ω)	R96.5 (Ω)	R100 (Ω)	diameter (mm)	catalog number
2200	1030-1310		147-173		7.0 ± 0.3	2322 611 90003
500		175 - 215		30 - 43	6.9 ± 0.2	90013
500		92.5 - 134		12 - 15	6.9 ± 0.2	90001
1000		221.5 - 318.5		30 - 36	6.9 ± 0.2	90004
270		97 - 143		29.5 - 36.5	6.9 ± 0.2	90009
700		207 - 264		41.4 - 48.6	6.9 ± 0.2	90011
800		244 - 315		48.0 - 58.6	6.9 ± 0.2	90008

Resistance/temperature characteristics

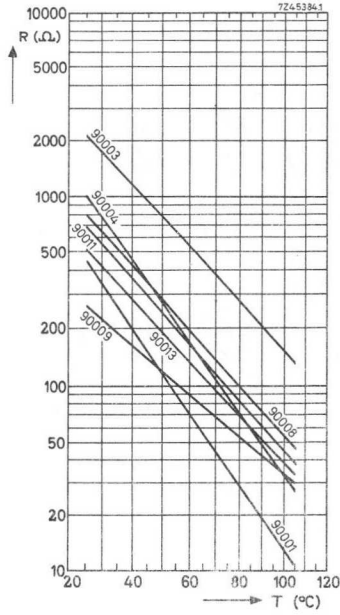

NTC THERMISTORS

miniature types

Miniature NTC thermistors are available in 7 versions all built around the same NTC-bead. The range of resistance values and the resistance temperature characteristics for all versions are the same.

R ₂₅ (Ω)	B-value at 25 °C (°K)	colour code			catalog number suffix
		I	II	III	
1 000	2350	brown	black	red	102
1 500	2450	brown	green	red	152
2 200	2600	red	red	red	222
3 300	2775	orange	orange	red	332
4 700	3650	yellow	violet	red	472
6 800	3725	blue	grey	red	682
10 000	3800	brown	black	orange	103
15 000	3750	brown	green	orange	153
22 000	3800	red	red	orange	223
33 000	3750	orange	orange	orange	333
47 000	3800	yellow	violet	orange	473
68 000	3850	blue	grey	orange	683
100 000	3900	brown	black	yellow	104
150 000	3975	brown	green	yellow	154
220 000	4075	red	red	yellow	224
330 000	4175	orange	orange	yellow	334
470 000	4225	yellow	violet	yellow	474
680 000	4300	blue	grey	yellow	684

Tolerance on R ₂₅	± 20 % (± 10 % on request ¹⁾)
Tolerance on B-value	± 5 %
Maximum dissipation	60 mW
Maximum temperature (T _{max})	200 °C
Dissipation factor	approximately 0.4 mW/deg C
Stability after 1000 hrs at T _{max}	< 1 %

¹⁾ The catalog numbers are 2322 6... .2...

2322 627
2322 634

NTC THERMISTORS
 Miniature types

Resistance/temperature characteristics

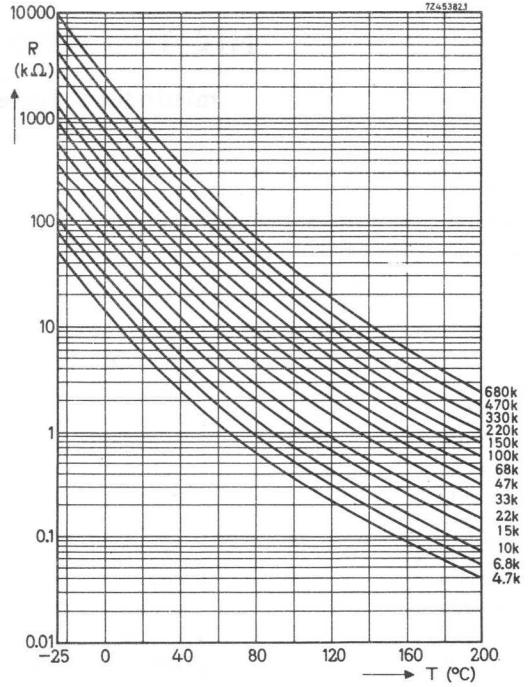
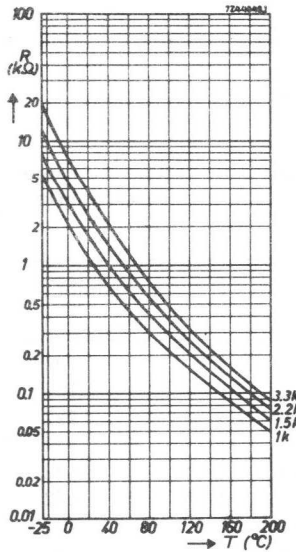

VERSIONS

2322 634 01... Naked bead

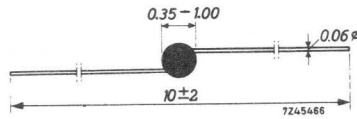

2322 634 11... Naked bead

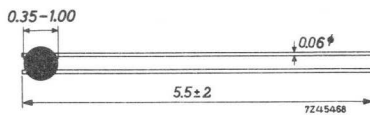

2322 634 21... Glass encapsulated bead

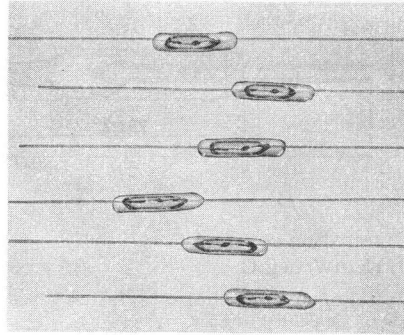
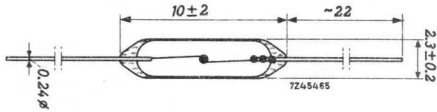

Voltage/current characteristics

RZ 19323-3

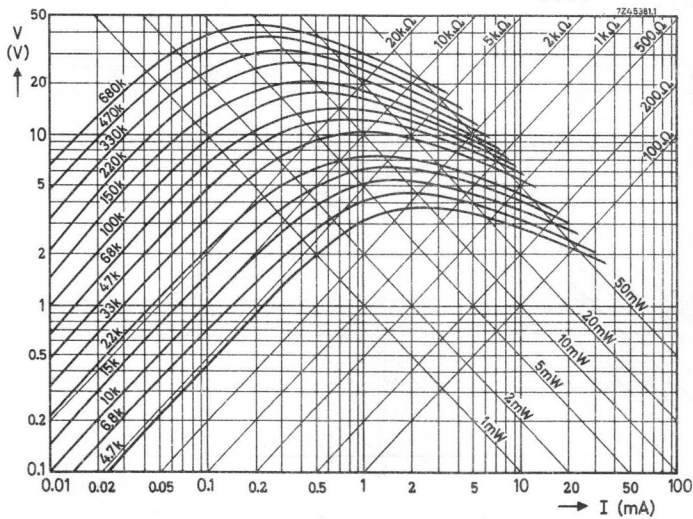
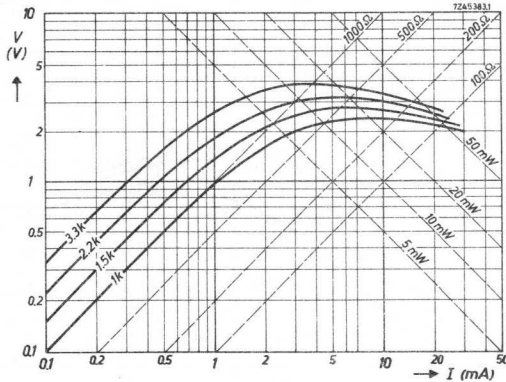

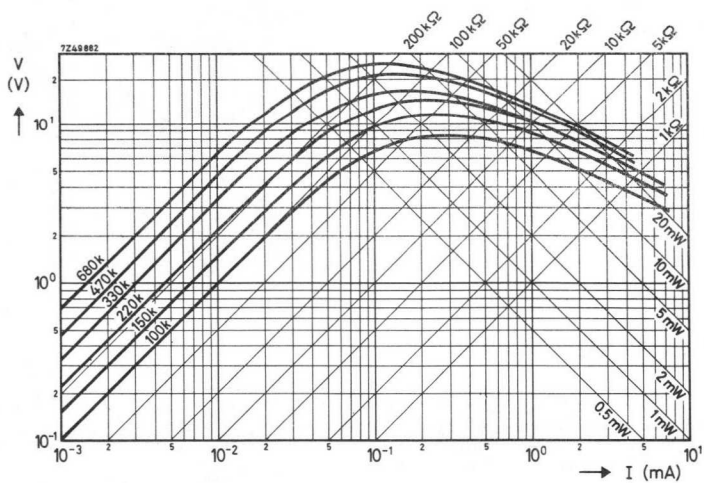

2322 634 41... Vacuum gauge

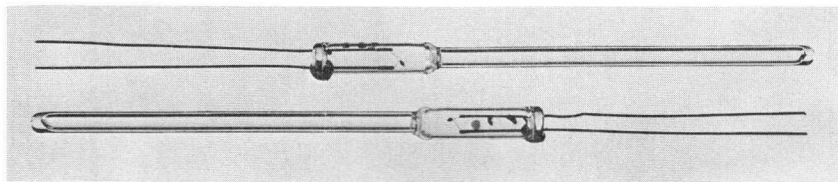
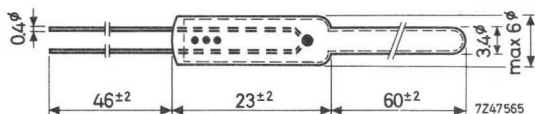

RZ 21384-1

2322 627
2322 634

NTC THERMISTORS
Miniature types

2322 627 11... Thermometer

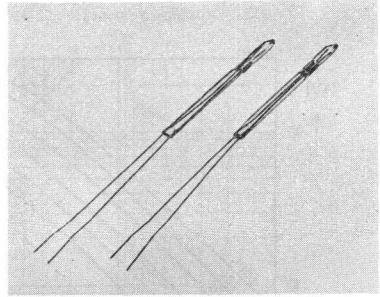
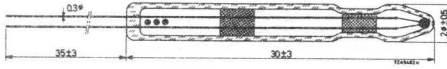

RZ 17758-4

2322 627 21... Thermometer

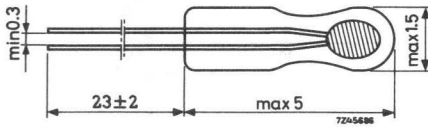

B-value tolerance for values lower than $4.7 \text{ k}\Omega$ is $\pm 10\%$ instead of 5%.

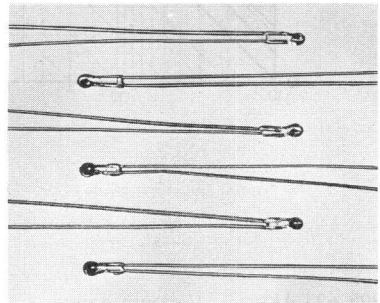

NTC THERMISTORS indirectly heated

Two versions are available, vacuum mounted in glass and mounted in air-filled metal casing. The latter has a much higher heater power due to the higher dissipation factor; therefore, the thermal time constant is lower.

2322 628 01332 vacuum mounted in glass
2322 628 01334

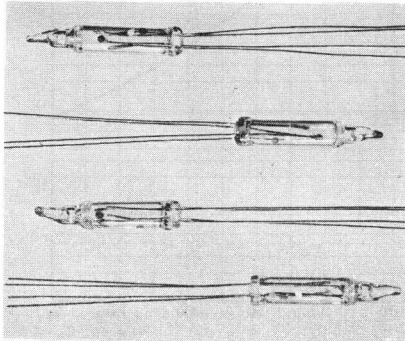

RZ 20946-2

2322 628 01332

2322 628 01334

R25	3.3 kΩ ± 20%	330 kΩ ± 20%
B-value	2775 °K ± 10%	4175 °K ± 10%
Colour code	orange orange red	orange orange yellow

W _{max} heater	30 mW
T _{max}	200 °C
Resistance heater	100 Ω ± 10 %
W _{max} NTC	25 mW
Dissipation factor	0.18 mW/deg C
Heater efficiency ¹⁾	97.5 %
Time constant ¹⁾	2.2 s
Capacitance heater/bead	1.6 pF
Dielectric strength heater/bead	≥ 200 V
Insulation resistance heater/bead at 50 V	> 10 MΩ

Dimensions in mm

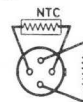
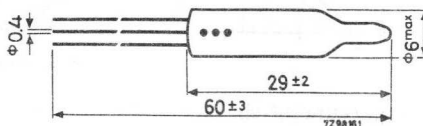

¹⁾ Defined according to CCTU 11-01

2322 628 01332

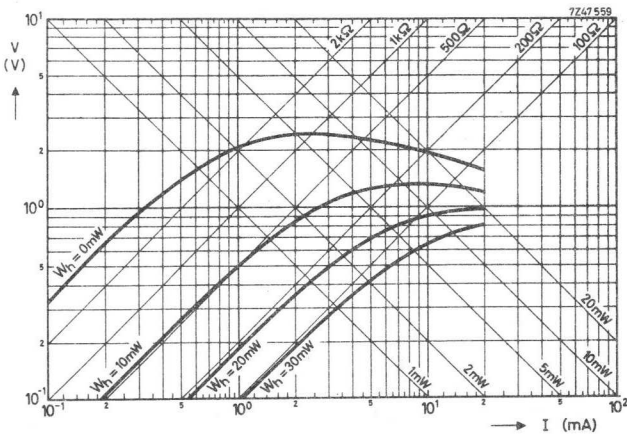
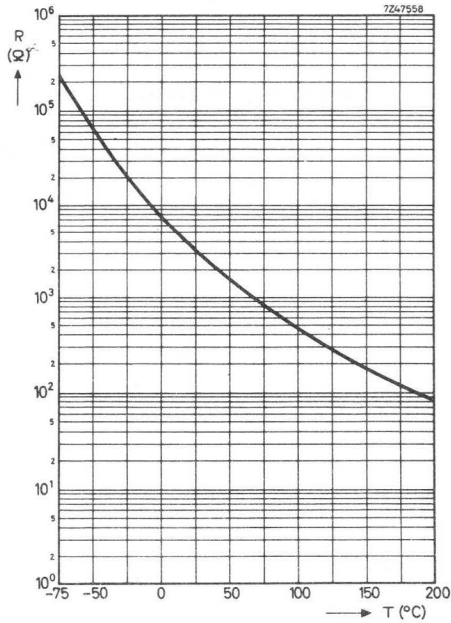

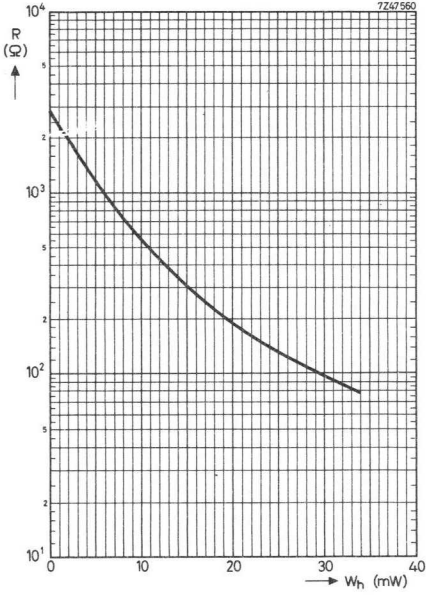

Resistance/power characteristic

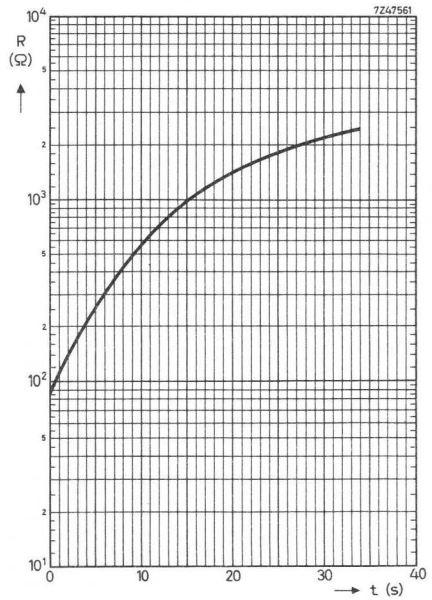

Cooling characteristic

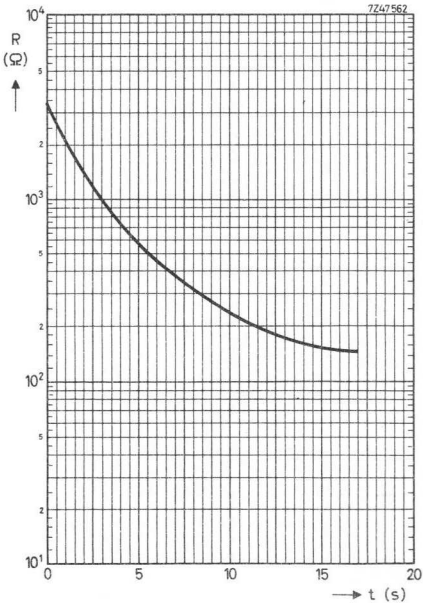

Response time characteristic
($W_{heater} = 30$ mW)

2322 628 01334

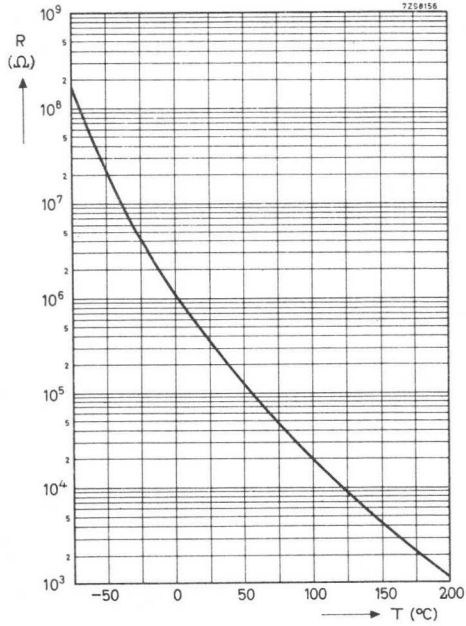

Resistance / temperature characteristic

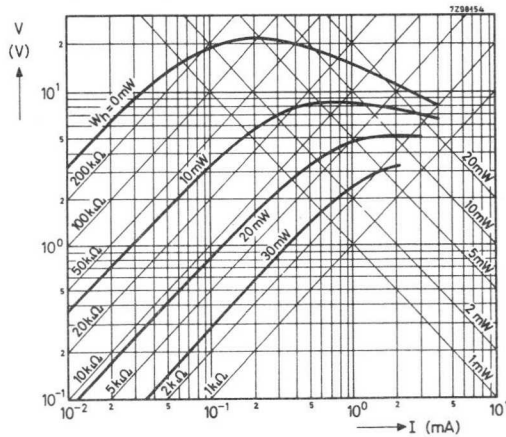

Voltage / current characteristics

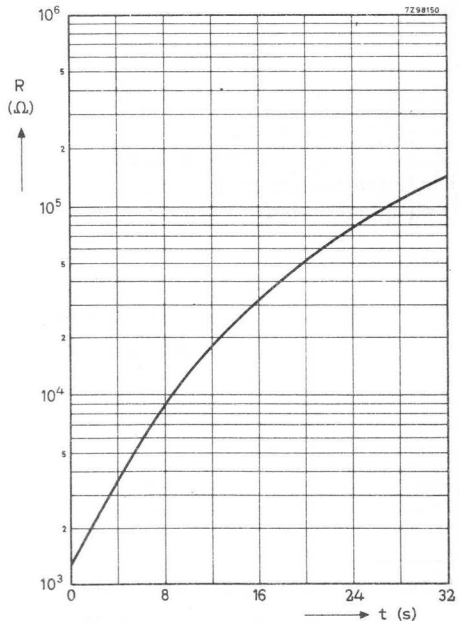
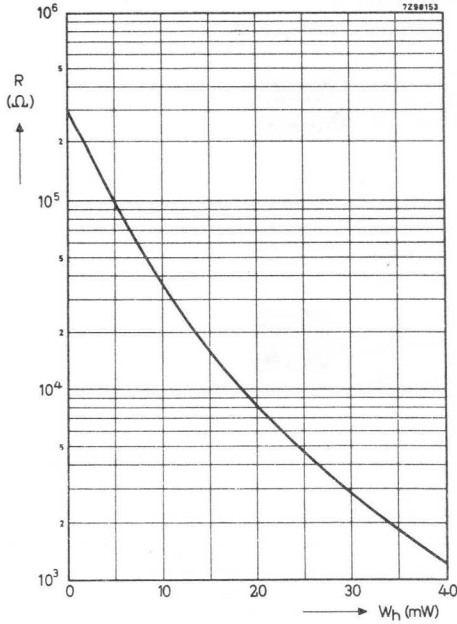

2322 628 11332 mounted in air-filled metal casing
2322 628 11334

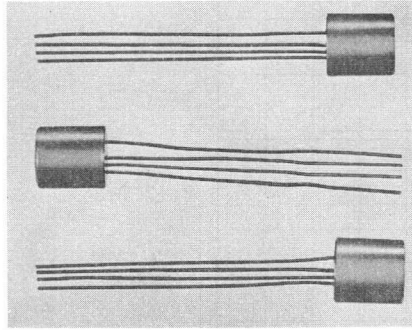

RZ 20932-1

	<u>2322 628 11332</u>	<u>2322 628 11334</u>
R ₂₅	3.3 kΩ ± 20%	330 kΩ ± 20%
B-value	2775 °K ± 5%	4175 °K ± 5%
Colour code	orange orange red	orange orange yellow

W _{max} heater		80 mW
T _{max}		125 °C
Resistance heater		100 Ω ± 10 %
W _{max} NTC		60 mW
Dissipation factor		0.50 mW/deg C
Heater efficiency ¹⁾		90 %
Time constant ¹⁾		1.2 s
Capacitance heater/bead		1.1 pF
Dielectric strength heater/bead		≥ 200 V
Insulation resistance heater/bead		10 MΩ
<u>Dimensions in mm</u>		

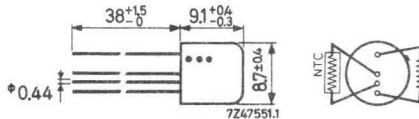

¹⁾ Defined according to CCTU 11-01

2322 628 11332

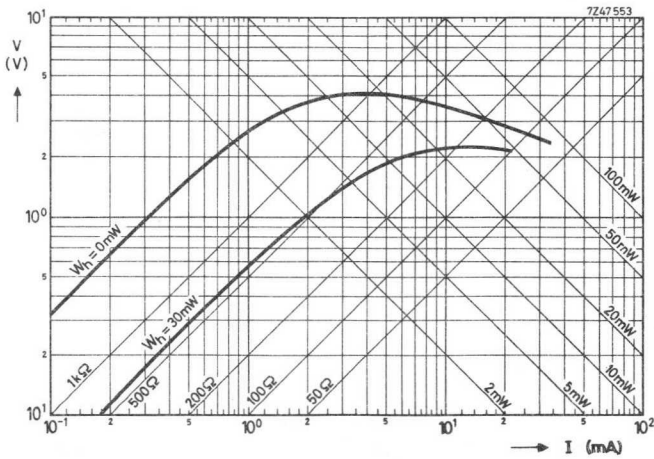
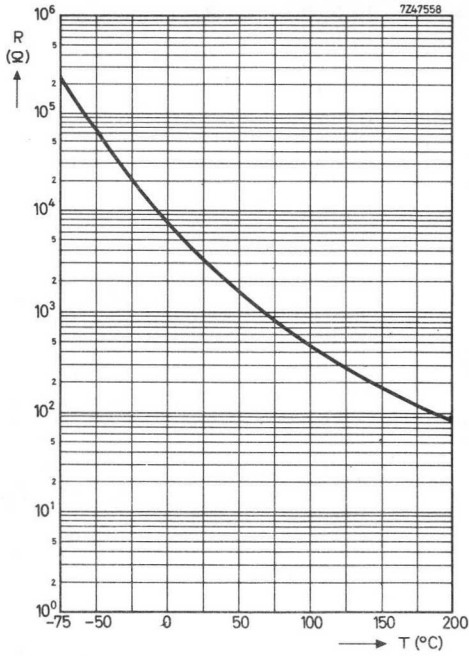

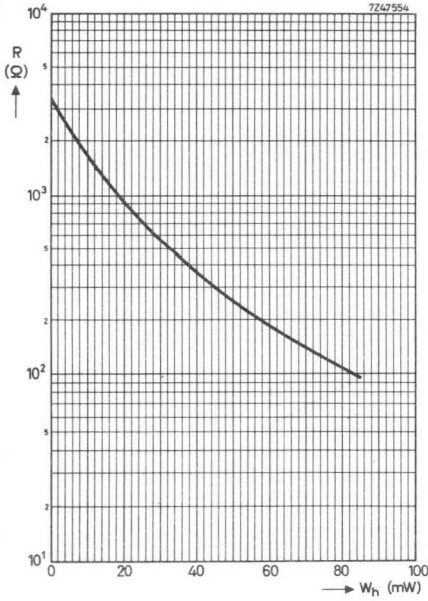

Resistance/power characteristic

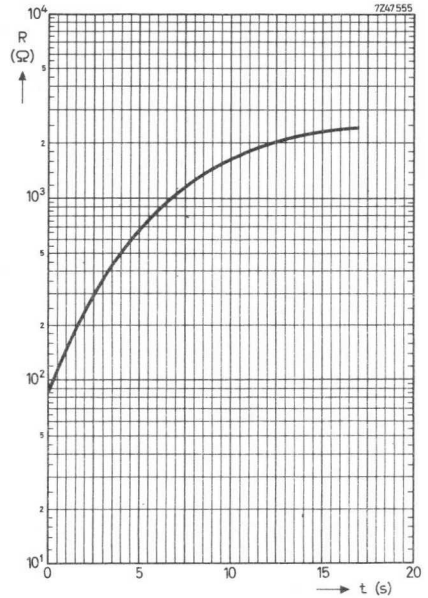

Cooling characteristic

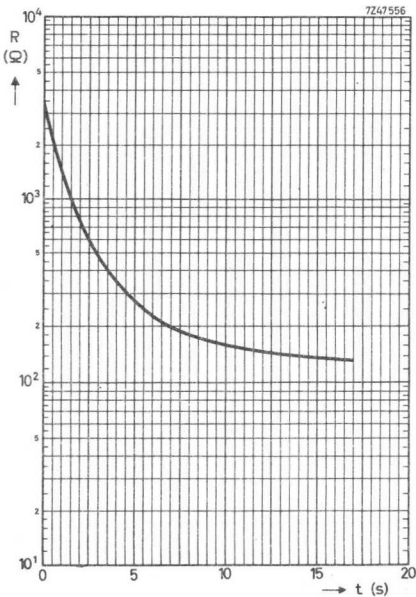

Response time characteristic
($W_{heater} = 80$ mW)

2322 628 11334

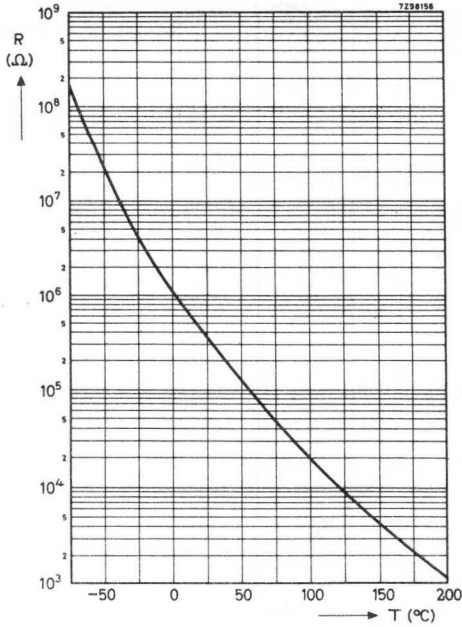

Resistance / temperature characteristic

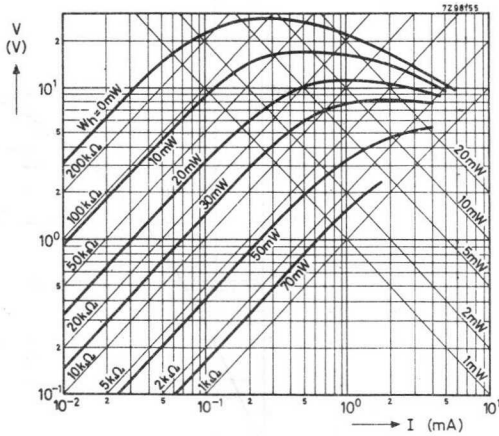

Voltage / current characteristics

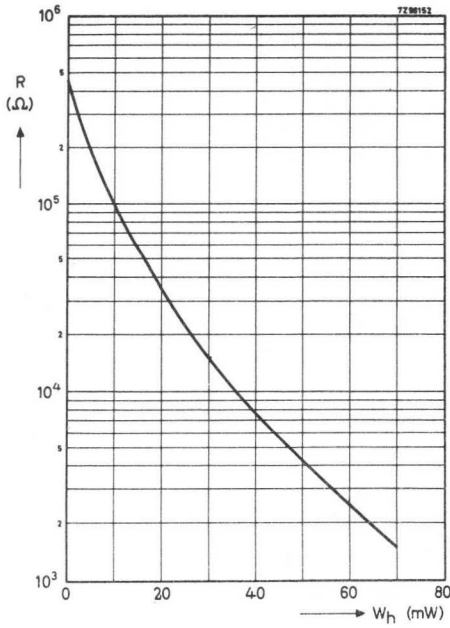

Resistance / power characteristic

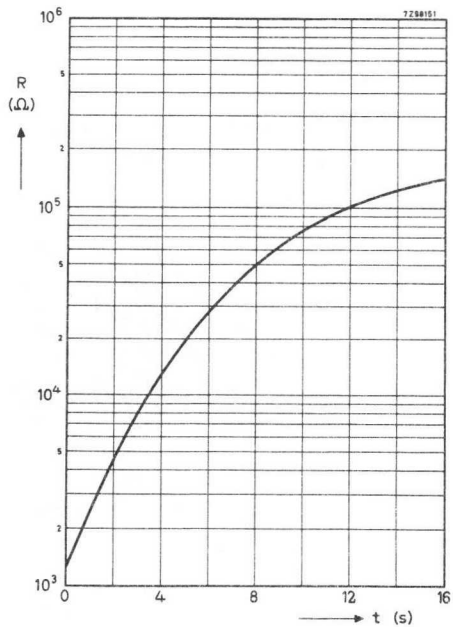

Cooling characteristic

NTC THERMISTORS standard rod types

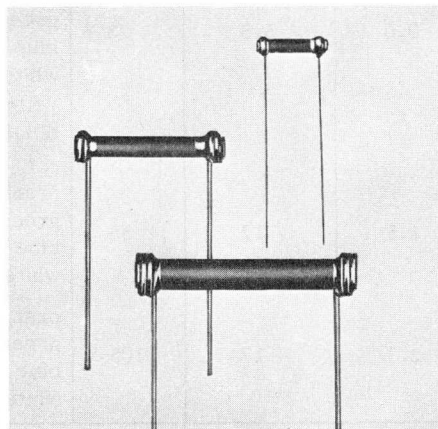

RZ 19225-2

These rods are extremely stable and can be used for critical professional and industrial applications.

Dimensions in mm

series	A	B	C
2322 635	3.2 ± 0.5	11 ± 1	0.4
2322 636	4.7 ± 0.5	21 ± 1	0.8
2322 637	6.2 ± 0.5	31 ± 1	0.8

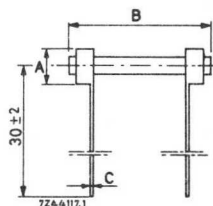

2322 635
2322 636
2322 637

NTC THERMISTORS
 Standard rod types

R ₂₅ (kΩ)	B-value at 25 °C (°K)	W _{max} at 25 °C amb (W)	dissipation factor (mW/deg C)	thermal time constant (s)	colour code	catalog number
4.7	3250	0.6	5.5	28	orange	2322 635 01472
15	3550				green	153
47	3925				blue	473
150	4075				white	154
330	4200				yellow/ blue	334
4.7	3250	1.5	12	55	orange	2322 636 01472
15	3550				green	153
47	4000				blue	473
150	4150				white	154
4.7	3250	2.3	17	105	orange	2322 637 01472
15	3650				green	153
47	4050				blue	473
150	4200				white	154

Tolerance on R₂₅ ± 20 % (± 10 % on request ¹⁾)

Tolerance on B-value ± 5 %

Maximum temperature 150 °C

Stability ΔR₂₅ after 1000 hrs at W_{max} < 5 %

ΔR₂₅ after 1000 hrs at 2/3 W_{max} < 3 %

¹⁾ The catalog numbers are 2322 635 02..., 2322 636 02... and 2322 637 02... respectively.

Resistance / temperature characteristics

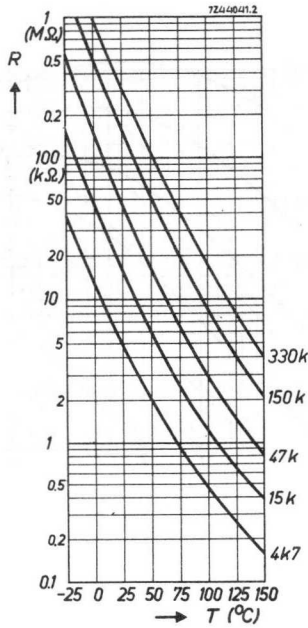

2322 635
2322 636
2322 637

Voltage / current characteristics

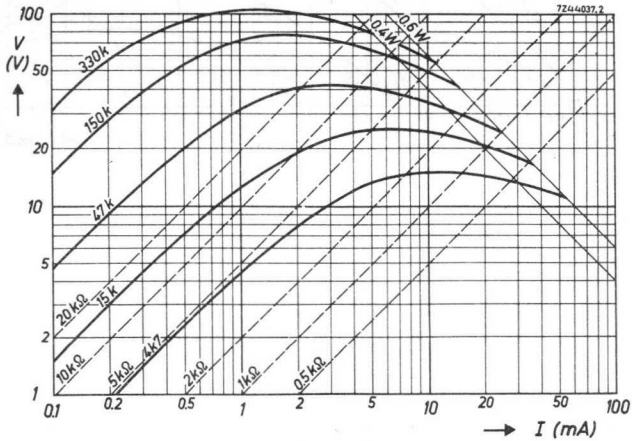

2322 635

2322 635
 2322 636
 2322 637

NTC THERMISTORS
 Standard rod types

2322 636

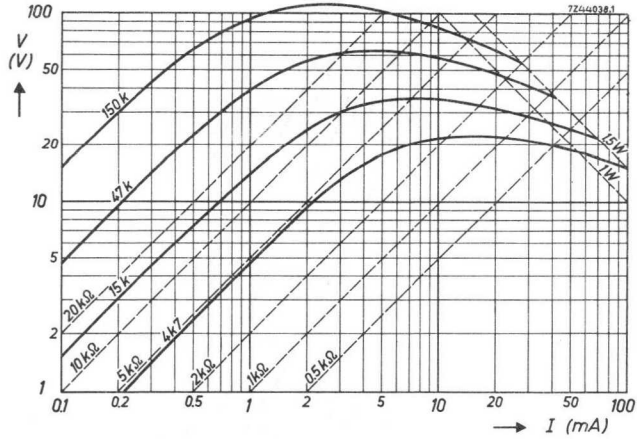

2322 637

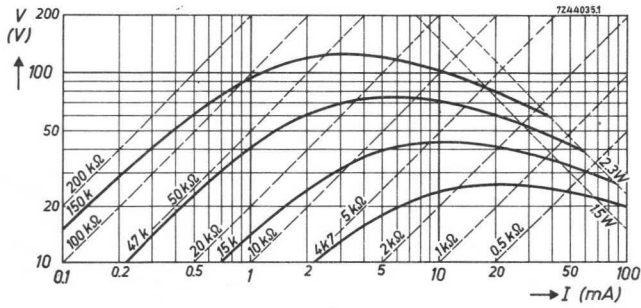

NTC THERMISTORS

standard disc type



RZ 27317-5

QUICK REFERENCE DATA

Resistance values at 25 °C	3.3 Ω to 330 k Ω according to E6-series
B-values	between 2650 and 4650 °K
Max. dissipation at $T_{amb} = 55$ °C	0.5 W
Operating temperature range at zero power	-25 to +125 °C
Dissipation factor	8 to 9 mW/degC
Thermal time constant	20 to 30 s

APPLICATION

Suitable for all kinds of applications.

DESCRIPTION

These thermistors have a negative temperature coefficient. They consist of a disc provided with two solid tinned copper wires. They are not insulated nor lacquered. The thermistors are colour coded.

MECHANICAL DATA

Dimensions in mm

Fig. 1

Marking

The thermistors are marked with three bands showing their resistance value (R_{25}) in colour code; the types with a tolerance on R_{25} of 10% also have a silver band, those with a tolerance on R_{25} of 5% a gold band (see Fig. 1).

Weight 0.5 g approximately

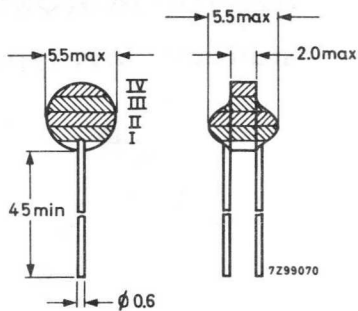
Mounting In any position by soldering

- 1) B-value is subject to change
- 2) Replace dot in catalogue number (9th digit) by
 - 1 for a tolerance of 20% on R_{25} ,
 - 2 for a tolerance of 10% on R_{25} ,
 - 3 for a tolerance of 5% on R_{25} .

ELECTRICAL DATA

R ₂₅ (Ω)	B _{25/85} (1) (°K)	dissipation factor approx. (mW/degC)	thermal time constant approx. (s)	colour code (see Marking)			catalogue number (2)
				I	II	III	
3.3	2650	9	30	orange	orange	gold	2322 642 1.338
4.7	2650	9	30	yellow	violet	gold	1.478
6.8	2675	9	30	blue	grey	gold	1.688
10	2775	9	30	brown	black	black	1.109
15	2875	9	30	brown	green	black	1.159
22	2950	9	25	red	red	black	1.229
33	3050	9	25	orange	orange	black	1.339
47	3200	9	25	yellow	violet	black	1.479
68	3225	8	25	blue	grey	black	1.689
100	3250	8	25	brown	black	brown	1.101
150	3275	8	25	brown	green	brown	1.151
220	3325	8	25	red	red	brown	1.221
330	3375	8	25	orange	orange	brown	1.331
470	3425	8	25	yellow	violet	brown	1.471
680	3575	8	25	blue	grey	brown	1.681
1000	3650	8	25	brown	black	red	1.102
1500	3700	8	25	brown	green	red	1.152
2200	3750	8	25	red	red	red	1.222
3300	4000	8	25	orange	orange	red	1.332
4700	4225	8	25	yellow	violet	red	1.472
6800	4225	8	25	blue	grey	red	1.682
10000	4250	8	25	brown	black	orange	1.103
15000	4250	8.5	25	brown	green	orange	1.153
22000	4300	8.5	25	red	red	orange	1.223
33000	4325	8.5	25	orange	orange	orange	1.333
47000	4350	8.5	25	yellow	violet	orange	1.473
68000	4350	8.5	25	blue	grey	orange	1.683
100000	4350	8.5	25	brown	black	yellow	1.104
150000	4350	8.5	25	brown	green	yellow	1.154
220000	-	8.5	25	red	red	yellow	1.224
330000	-	8.5	25	orange	orange	yellow	1.334

Tolerance on resistance value

at 25 °C (R₂₅)

± 20, ± 10 and ± 5% 2)

Tolerance on B-value

± 5%

Max. dissipation at 55 °C

0.5 W

Operating temperature range

at zero power

-25 to +125 °C

For notes see opposite

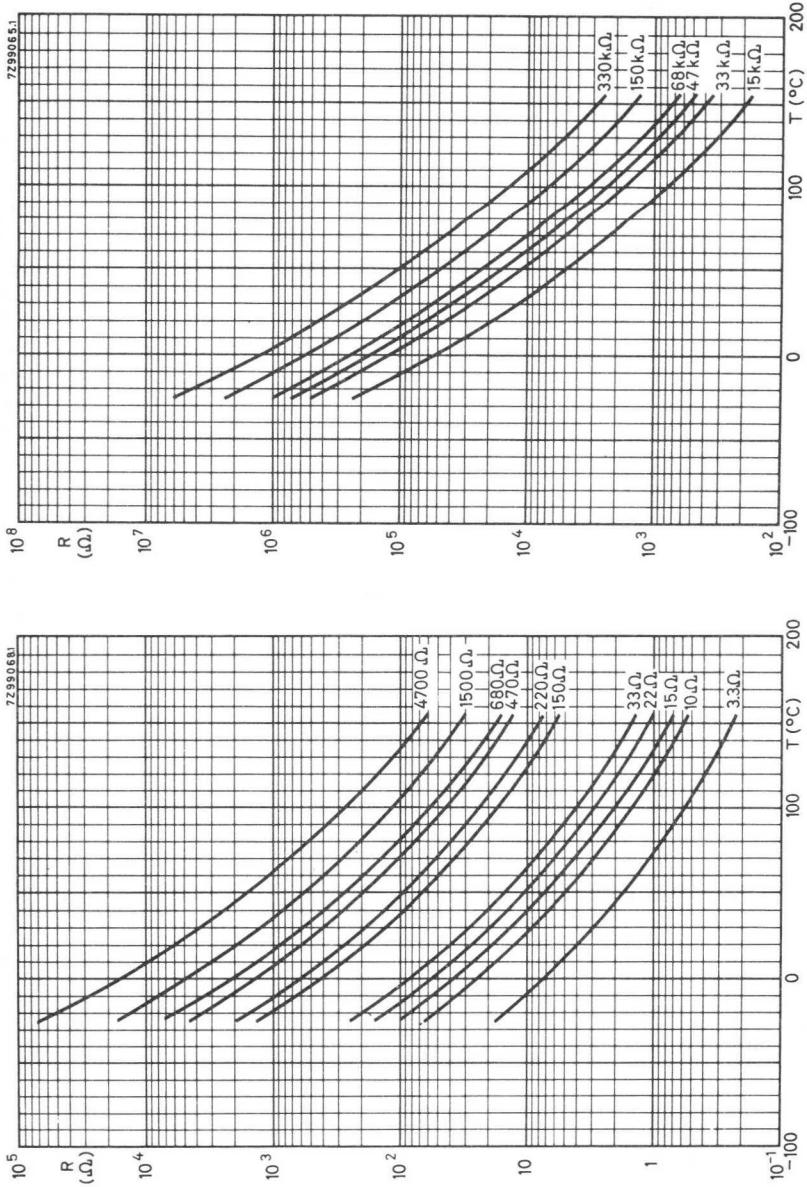
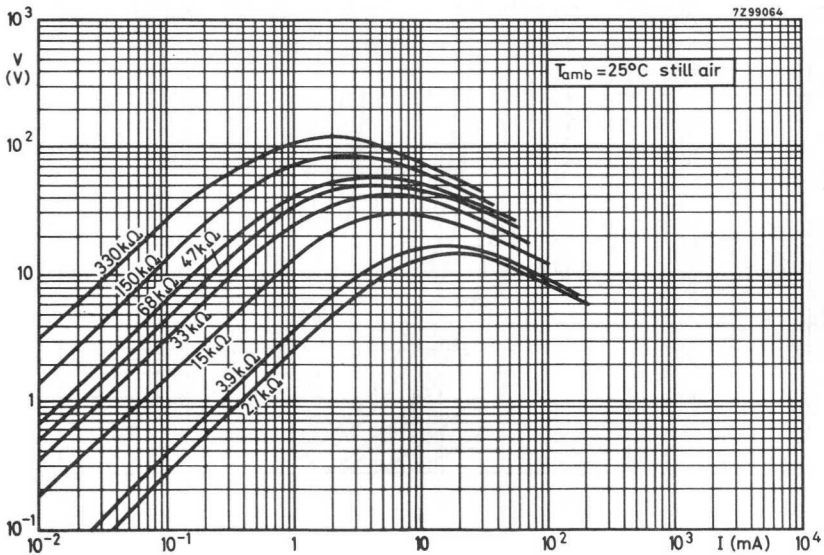
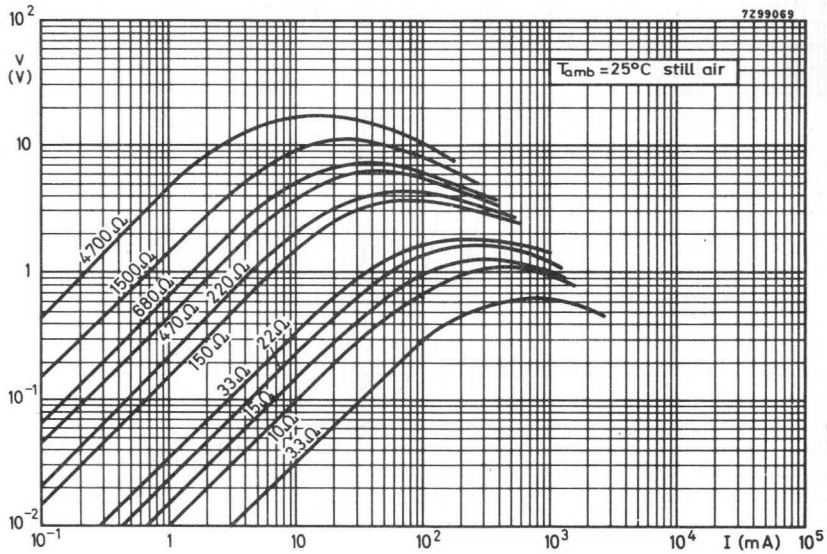

Fig. 2 a and b. Resistance/temperature characteristics

Fig.3 a and b. Voltage/current characteristics



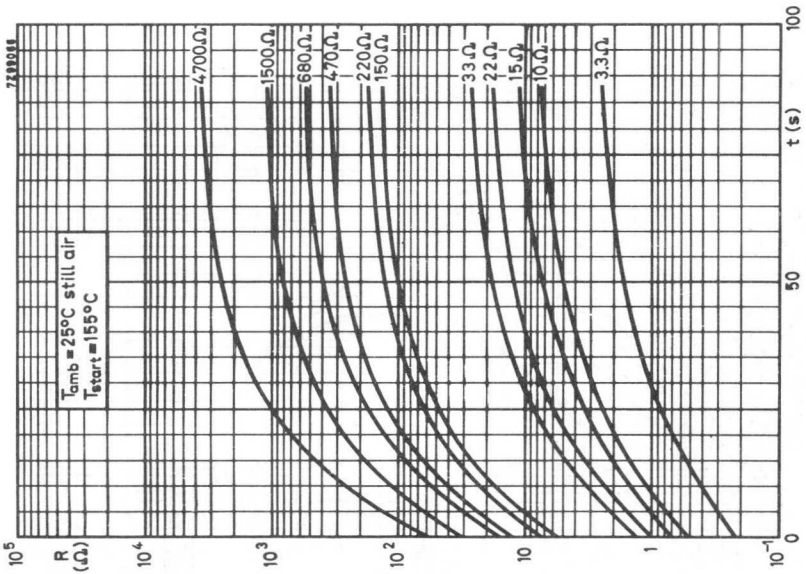
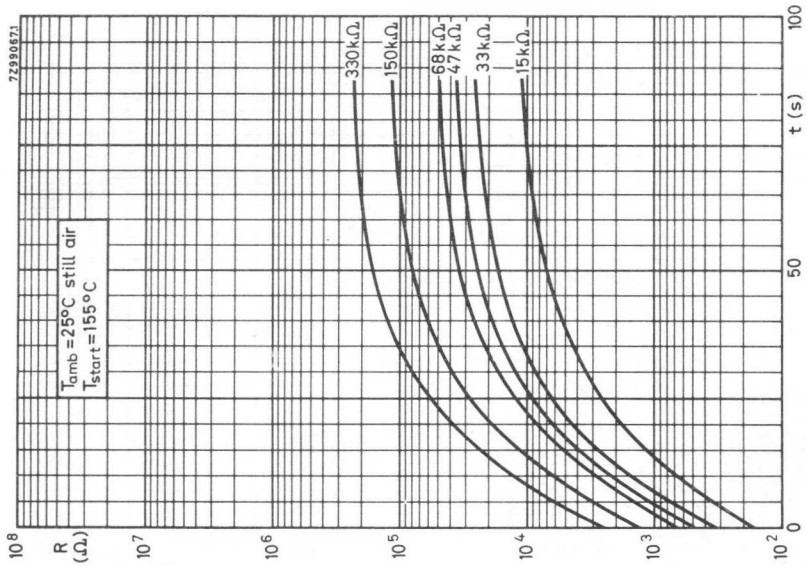

Fig. 4 a and b. Resistance/time (Cooling) characteristics

TESTS AND REQUIREMENTS

According to I. E. C. publication 68

tests	I. E. C. 68 test method	duration	requirements	
			$\Delta R/R$ (%)	$\Delta B/B$ (%)
Storage at $+25 \pm 10$ °C	H	1000 h	± 3	± 1
Dry heat at $+125$ °C	B	1000 h	± 5	± 2
Thermal shock -25 to $+125$ °C	Ha	5 cycles	± 3	± 2
Damp heat	C	1000 h	± 5	± 3
Max. dissipation at $T_{amb} = +55$ °C		1000 h	± 5	± 2
Robustness of terminations				
Tensile strength 10 N	Ua	10 s	*)	
Bending 5 N	Ub	2 times	*)	
Soldering	T			
Solderability at 230 °C	Par. 3.2.3	3 to 4 s	**)	
Resistance to heat at 230 °C	Par. 3.2.4	3 to 4 s	± 2	± 2

*) Leads should neither come loose nor break

***) Leads must be solderable initially and after six months storage with solder containing resin flux.

QUALITY LEVEL

Sampling and data evaluation for quality level in accordance with MIL-STD-105D

- A. Q. L. 1 % , major defects-Electrical
- A. Q. L. 1.5 % , major defects-Mechanical
- A. Q. L. 4 % , minor defects-Physical

PACKAGING

250 pieces per box (cardboard)

1985 045 0000

1985 045 0000

1985 045 0000

NTC THERMISTORS

standard disc type with mounting stud

RZ 27317-6



QUICK REFERENCE DATA

Resistance value(s) at 25 °C	3.3 Ω to 68 k Ω acc. to E 6-series
B-values	between 2650 and 4450 °K
Max. dissipation at 55 °C	0.5 W
Operating temperature range at zero power	-25 to +100 °C
Dissipation factor	9.5 mW/deg C approx.
Thermal time constant	80 s approx.

APPLICATION

Suitable for all kinds of applications, especially when a good insulation and/or a good thermal contact with the chassis is required.

DESCRIPTION

The same as for the standard disc type without mounting stud (2322 642 1....), but encapsulated in a metal stud.

MECHANICAL DATADimensions in mm

Fig.1

Marking

The resistance value is printed on the stud in code.

Weight

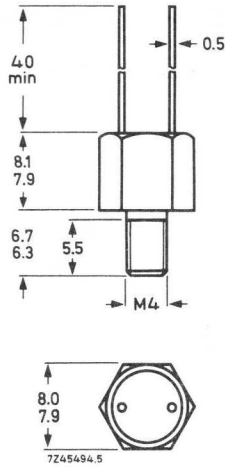
2 g approximately.

Mounting

By means of an M4 nut and ring supplied for the purpose.

ELECTRICAL DATA

R ₂₅ (Ω)	B _{25/85} 1) (°K)	catalogue number 2)	R ₂₅ (Ω)	B _{25/85} 1) (°K)	catalogue number 2)
3.3	2650	2322 642 2.338	1500	3700	2322 642 2.152
4.7	2650	2.478	2200	3750	2.222
6.8	2675	2.688	3300	4000	2.332
10	2775	2.109	4700	4225	2.472
15	2875	2.159	6800	4225	2.682
22	2950	2.229	10000	4250	2.103
33	3050	2.339	15000	4250	2.153
47	3200	2.479	22000	4300	2.223
68	3225	2.689	33000	4325	2.333
100	3250	2.101	47000	4350	2.473
150	3275	2.151	68000	4350	2.683
220	3325	2.221	100000	4350	2.104
330	3375	2.331	150000	4350	2.154
470	3425	2.471	220000	-	2.224
680	3575	2.681	330000	-	2.334
1000	3650	2.102			

Tolerance on resistance value
at 25 °C (R₂₅).

± 20 and ± 10% 2)

Tolerance on B-value

± 5%

Dissipation factor

without heatsink

9.5 mW/degC approx.

mounted on a heatsink

of 1 dm², thickness 1.5 mm

19 mW/degC approx.

Thermal time constant

without heatsink

80 s approx.

mounted on a heatsink

of 1 dm², thickness 1.5 mm

15 s approx.

Max. dissipation at 55 °C

0.5 W

Operating temperature range

at zero power

-25 to +100 °C

Dielectric withstanding

voltage

> 100 V

Insulation resistance

> 100 MΩ

1) B-value is subject to change

2) Replace dot in catalogue number (9th digit) by

1 for a tolerance of 20% on R₂₅

2 for a tolerance of 10% on R₂₅

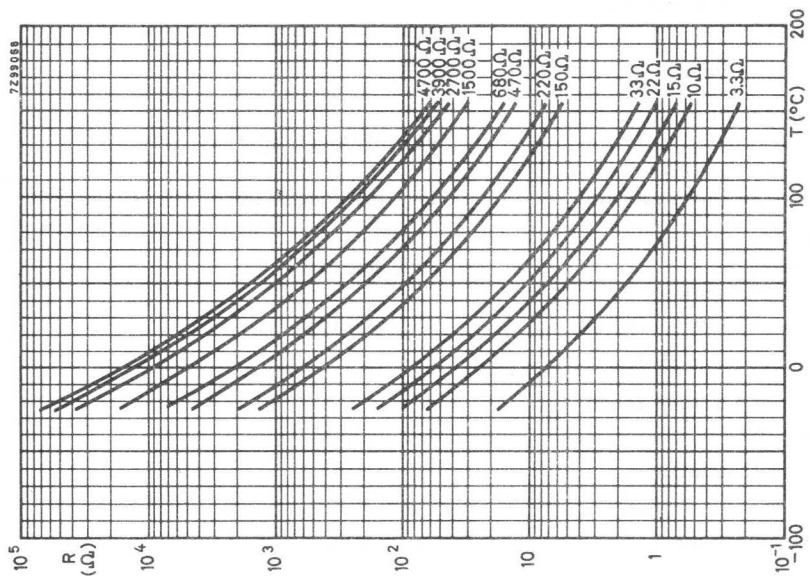
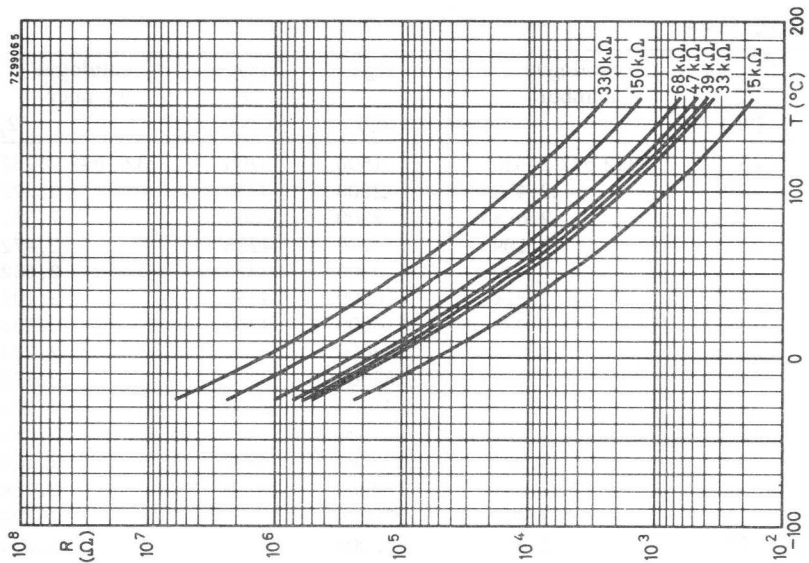

Fig. 2 a and b. Resistance/temperature characteristics

PACKAGING

100 pieces per box (cardboard) together with the necessary rings and nuts.

NTC THERMISTORS

standard disc types



RZ 27317-8

QUICK REFERENCE DATA

Resistance values at 25 °C	150 Ω, 470 Ω, 1.5 kΩ, 4.7 Ω	
B-values	between 3400 and 4200 °K	
Operating temperature range at zero power	-25 to +125 °C	
	<u>type 2322 643</u>	<u>type 2322 644</u>
Max. dissipation at 25 °C	1 W	1.5 W
Dissipation factor	10 mW/deg C	13 mW/deg C
Thermal time constant	55 s	120 s

APPLICATION

These discs are suitable for all kinds of applications.

DESCRIPTION

The thermistors have a negative temperature coefficient. They consist of a disc provided with two solid tinned copper wires. They are not insulated nor lacquered. The thermistors are colour coded.

MECHANICAL DATA

Dimensions in mm

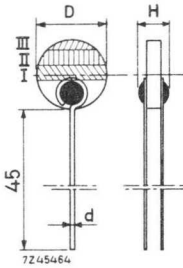

Fig. 1

series	D	H _{max}	d
2322 643	9 ± 0.5	6	0.6
2322 644	16 ± 0.5	7	0.8

Marking

The thermistors are marked with three bands showing their resistance value (R₂₅) in colour code (see Fig. 1); the types with a tolerance on R₂₅ of 10% also have a silver band.

Weight

Type 2322 643 0.9 g approximately

Type 2322 644 2 g approximately

Mounting

In any position by soldering.

ELECTRICAL DATA

R ₂₅ (Ω)	B-value at 25 °C 1) (°K)	P _{max} at T _{amb} = 25 °C (W)	dissipation factor approx. (mW/degC)	thermal time constant approx. (s)	colour code see Marking			catalogue number 2)
					I	II	III	
150	3400	1	10	55	brown	green	brown	2322 643 1.151
470	3800	1	10	55	yellow	violet	brown	1.471
1500	4100	1	10	55	brown	green	red	1.152
4700	4200	1	10	55	yellow	violet	red	1.472
150	3400	1.5	13	120	brown	green	brown	2322 644 1.151
470	3900	1.5	13	120	yellow	violet	brown	1.471 ←
1500	4050	1.5	13	120	brown	green	red	1.152
4700	4200	1.5	13	120	yellow	violet	red	1.472

Tolerance on resistance value
at 25 °C (R₂₅) ±20 and ± 10% 2)

Tolerance on B-value ±5%

Operating temperature range
at zero power -25 to +125 °C

PACKAGING

Type 2322 643	250 pieces per box (cardboard)
Type 2322 644	100 pieces per box (cardboard)

- 1) B-value is subject to change
2) Replace dot in catalogue number (9th digit)
by: 1 for a tolerance of 20% on R₂₅
2 for a tolerance of 10% on R₂₅

NTC THERMISTORS disc type

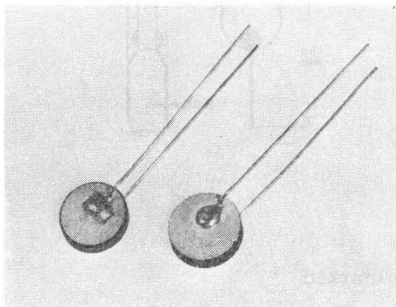

RZ28770.5

QUICK REFERENCE DATA

	2322 644 90004	2322 644 90005
Resistance value at +25 °C	82 Ω ± 20%	min. 15 Ω
Resistance at T _{amb} = +25 °C, and I _{rms} = 1.7 A and 2.2 A respectively	max. 0.85 Ω	max. 1 Ω
B25/85-value	4650 °K	3350 °K
Maximum current (r. m. s.)	1.7 A	2.2 A
Dissipation factor	19 mW/degC	17 mW/degC
Thermal time constant	115 s	148 s
Operating temperature range		
at zero power	-25 to +155 °C	-25 to +155 °C
at maximum power	0 to +55 °C	0 to +55 °C

APPLICATION

For limiting surge current, e.g. diode and switch protection.

DESCRIPTION

This thermistor has a negative temperature coefficient. It consists of a disc provided with two solid tinned copper wires. The thermistor body is neither lacquered nor insulated.

2322 644 90004
2322 644 90005

NTC THERMISTORS
disc type

MECHANICAL DATA

Dimensions in mm

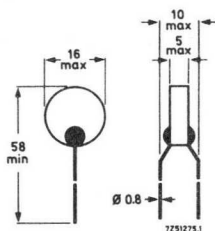

Marking

The thermistors are not marked.

Weight

Type 2322 644 90004 approx. 3.2 g
Type 2322 644 90005 approx. 4 g

Mounting

In any position by soldering. Soldering should be done at least 10 mm from the thermistor body.

Robustness of terminations

Tensile strength 20 N
Bending 10 N

Soldering

Solderability max. 240 °C, max. 4 s
Resistance to heat max. 240 °C, max. 4 s

ELECTRICAL DATA

	2322 644 90004	2322 644 90005	unit
R at 25 °C	82 ± 20%	min. 15	Ω
R at T _{amb} = 55 °C, I _{rms} = 1.7 A	max. 0.85		Ω
R at T _{amb} = 55 °C, I _{rms} = 2.2 A		max. 1	Ω
B25/85-value, approx.	4650	3350	°K
Max. current (r.m.s.) at T _{amb} = +55 °C	1.7	2.2	A
Dissipation factor, approx.	19	17	mW/degC
Thermal time constant, approx.	115	148	s
Heat capacity, approx.	2.2	2.5	J/degC
Operating temperature range			
at zero power	-25 to +155	-25 to +155	°C
at maximum power	0 to +55	0 to +55	°C
Max. repetitive peak voltage 50-60 Hz ¹⁾	345	380	V

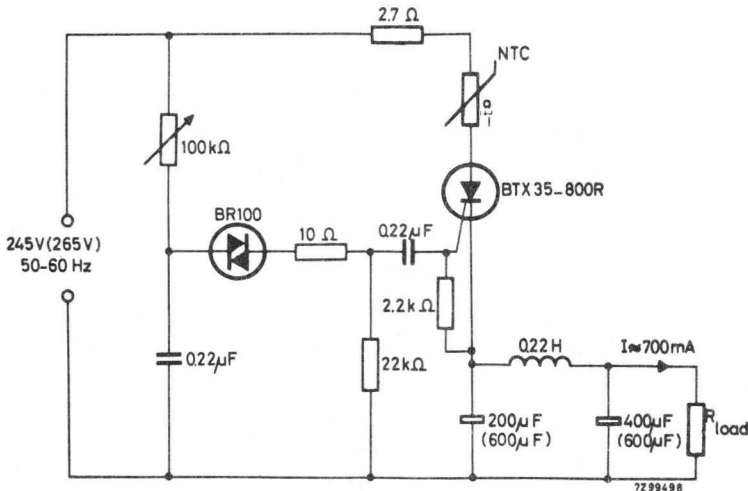

Fig. 2. (Values between brackets apply to thermistor 2322 644 90005)

¹⁾ Measured in the circuit shown in Fig. 2.

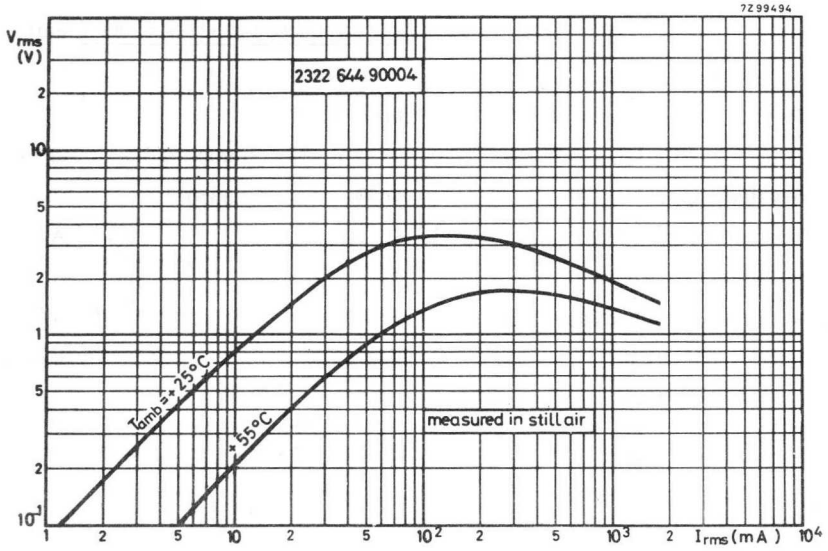

Fig. 3. Typical voltage/current characteristics

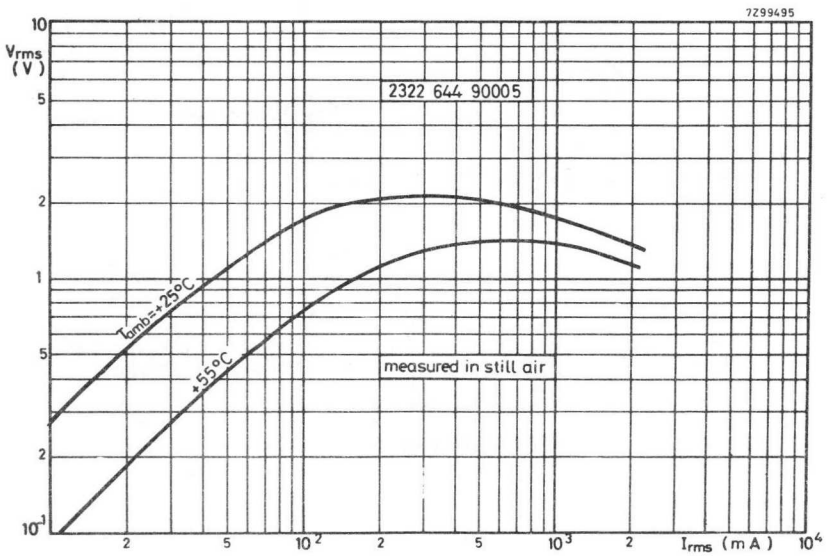

Fig. 4. Typical voltage/current characteristics

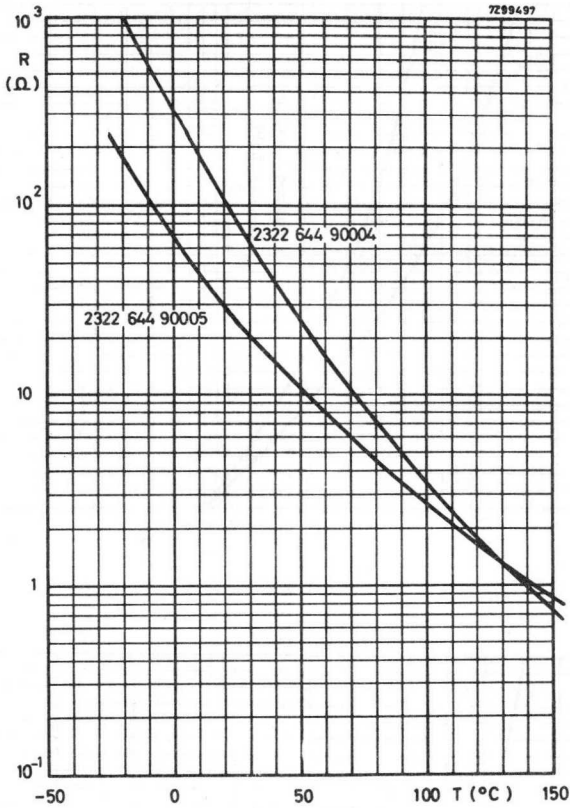

Fig. 5. Typical resistance/temperature characteristics

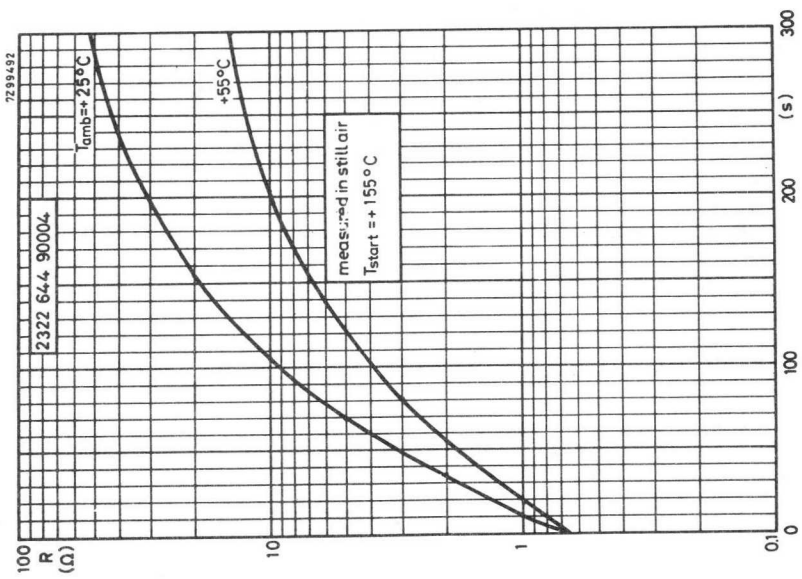
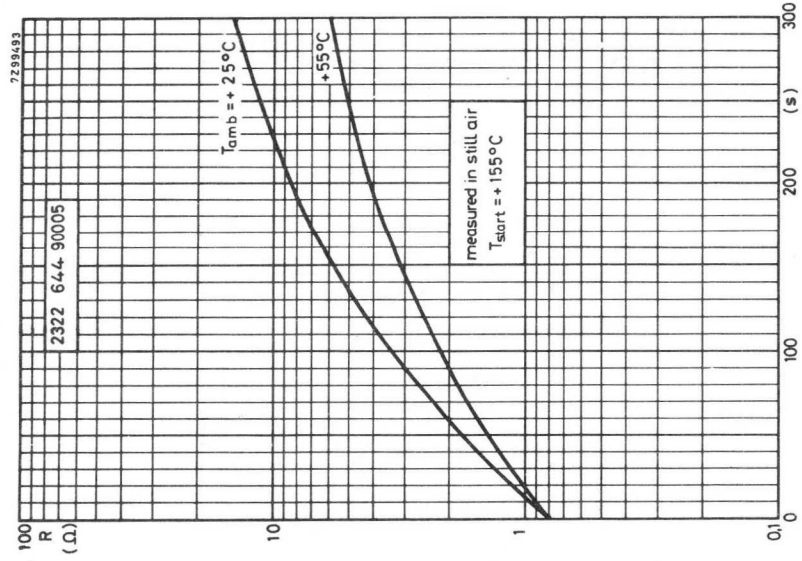

Fig. 6. Typical resistance/time (Cooling) characteristics Fig. 7. Typical resistance/time (Cooling) characteristics

TESTS AND REQUIREMENTS

According to IEC 68 recommendations, unless otherwise specified.

test	test method	duration	$\Delta R/R_{25}$ (%)
Cold at $-25\text{ }^{\circ}\text{C}$	A	1000 h	± 10
Storage at $+25\text{ }^{\circ}\text{C}$	H	1000 h	± 10
Dry heat at $+155\text{ }^{\circ}\text{C}$	B	1000 h	± 20
Thermal shock -25 to $+155\text{ }^{\circ}\text{C}$	Na	5 cycles	± 20
Damp heat at $+ \text{ }^{\circ}\text{C}$	Ca	1000 h	± 15
Maximum current at $T_{\text{amb}} = +25\text{ }^{\circ}\text{C}$		1000 h	± 20
Cycling ³⁾ Quick		250 cycles 5 s on/5 s off	± 20
Slow		2000 cycles 1 min on/9 min off	± 20
Robustness of terminations	U		
Tensile strength 20 N	Ua	10 s	1)
Bending 10 N	Ub	2 times	1)
Soldering	T		
Solderability at $230 \pm 10\text{ }^{\circ}\text{C}$	par. 3.2.3	3 to 4 s	2)
Resistance to heat at $230 \pm 10\text{ }^{\circ}\text{C}$	par. 3.2.4	3 to 4 s	± 2

1) Leads should neither come loose nor break.

2) Leads must be solderable initially and after 6 months storage with solder containing resin flux.

3) Measured in the circuit shown in Fig. 2.

QUALITY LEVEL

Sampling and data evaluation for quality level in accordance with MIL-STD-105D

A.Q.L. 1 %, major defects - Electrical

A.Q.L. 1.5%, major defects - Mechanical

A.Q.L. 4 %, minor defects - Physical

PACKAGING

Cardboard boxes containing 50 items.

1331 644 8000
1331 644 8000

PTC THERMISTORS



INTRODUCTION

P(ositive) T(emperature) C(oefficient) thermistors are resistors with a high positive temperature coefficient of resistance. In several aspects they differ from NTC thermistors described in this booklet:

- (1) The temperature coefficient of a PTC thermistor is positive only between certain temperatures, outside these temperatures the temperature coefficient is zero or negative.
- (2) The absolute value of the temperature coefficient of PTC thermistors is in most cases much higher than that of NTC thermistors.

PTC thermistors are applied as excess current limiters, temperature sensors and protection devices against overheating in all kind of apparatus such as electric motors, washing machines, alarm installations etc. They are also used as level indicators, time delay devices, thermostats, compensation resistors etc.

PTC thermistors are prepared from BaTiO_3 , or solid solutions of BaTiO_3 and SrTiO_3 in a way which is analogous to the method for preparing NTC thermistors. A certain amount of extra electrons on the Ti-ions are created by the introduction of foreign ions having a different valency. In these compounds there are two possibilities: substitution of trivalent ions like La or Bi for Ba or substitution of pentavalent ions like Sb^{5+} or Nb^{5+} for Ti. Both methods lead to identical results. If carefully prepared, in the absence of oxygen, these semiconductors have a normal, weakly negative temperature coefficient. The interesting PTC effect is obtained by firing the ceramic samples in the presence of oxygen. It is caused by the penetration of oxygen from the atmosphere along pores and crystal boundaries during the cooling part of the firing process. The oxygen atoms, adsorbed on the crystal surfaces attract electrons from a thin zone of the semiconducting crystals. In this way electrical potential barriers are formed consisting of a negative surface charge with on both sides thin layers having a positive space charge resulting from the now uncompensated foreign ions. These barriers cause an extra resistance of the thermistor.

$$R_b \propto \frac{1}{a} e^{eV_b/kT}$$

Here a represents the size of the crystallites, thus $\frac{1}{a}$ the number of barriers per unit length of the thermistor. V_b represents the electrical potential of the barriers. As V_b is inversely proportional to the value of the dielectric constant of the crystals it is clear that R_b is extremely sensitive to variations of the dielectric constant. Such a variability of the dielectric constant is a special property of materials with a ferro-electric nature like BaTiO_3 and its solid solu-

tions. Above their ferro-electric Curie temperature Θ the relative dielectric constant decreases with temperature according to

$$\epsilon_r = \frac{C}{T - \Theta}$$

where C has a value of roughly 10^5 K. As a result the resistivity increases steeply just above the Curie temperature.

Below the Curie temperature the barriers are weak or absent, partly as a result of the high effective dielectric constant of BaTiO_3 in strong fields and partly as a result of the spontaneous polarization of the crystals which may compensate the boundary charges.

At very high temperatures, above 160 to 200 °C, the electrons captured at the boundaries are gradually liberated. As a result the potential barriers decrease in strength, so that the PTC temperature region is followed by an NTC region. Therefore the applications of PTC thermistors are restricted by a certain temperature limit.

As the PTC effect is caused by crystal boundary barriers the extra resistance R_b is shunted by a high parallel capacitance C_b . This leads to a frequency dependence of R_b , or better of the extra impedance Z_b . Above 1 to 5 MHz Z_b has completely disappeared. The characteristic properties described in the following paragraphs are thus restricted to low frequencies.

MANUFACTURING PROCESS

The manufacturing process can be compared with that of NTC thermistors. Mixtures of barium carbonate, strontium and titanium oxides and other materials depending on the required electrical characteristics are milled, mixed and pressed into a suitable form. After drying, the PTC's are sintered at a very high temperature. After the contacts have been applied with the utmost care on this n-type semiconductor, leads can be soldered on the contact surfaces. Most PTC types with leads are further protected by a special lacquer.

\propto = directly proportional with

ELECTRICAL PROPERTIES

RESISTANCE VERSUS TEMPERATURE CHARACTERISTICS

The relation between resistance value and temperature is difficult to express in a compact formula (as was done for NTC). Being not simply the reverse of an NTC curve, the PTC characteristic is more complicated. In Fig.1 a comparison is given of the general behaviour of NTC and PTC thermistors. Generally speak-

Fig.1.
Resistance/temperature characteristics
of an NTC and PTC thermistor.

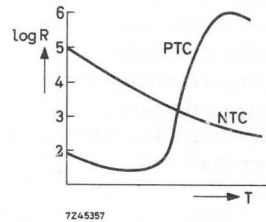

ing, PTC thermistors have at the lower end of the temperature scale a zero or negative temperature coefficient of resistance. Going to higher temperatures the temperature coefficient of resistance changes to a high positive value up to a temperature of approximately 150 °C. Above that temperature the temperature coefficient decreases and becomes negative.

In some cases the resistance/temperature relation can be expressed by the formula:

$$R_T = A + Ce^{BT}, \text{ for } T_1 < T < T_2$$

in which R_T = resistance at the temperature T of the PTC

T = temperature of the PTC

A , C and B constants

T_1 = minimum temperature for which the formula applies.

T_2 = maximum temperature for which the formula applies.

From this formula we find after differentiation the temperature coefficient:

$$\alpha = \frac{1}{R} \cdot \frac{dR}{dT} = \frac{BC e^{BT}}{A + Ce^{BT}}$$

which yields to

$$\alpha = 100B \% \text{ per deg C}$$

for that part of the characteristic where $R_T \gg A$.

However, in practice it seldom occurs that the R/T characteristic can be described by the above or another simple formula, so calculations have to be based on graphical methods. As a practical indication of the temperature at which the PTC thermistor starts to have a usable temperature coefficient, the switch temperature T_{switch} has been introduced, being defined as the higher of the two temperatures at which the value of the resistance of the PTC is twice that of the minimum resistance ¹).

VOLTAGE VERSUS CURRENT CHARACTERISTICS

The static voltage/current characteristics are very interesting as these curves clearly show the current limiting ability of the PTC thermistors. Up to a certain voltage the V/I characteristic is a straight line following ohm's law but as soon as the PTC is heated up by the current so much that its temperature reaches the switch temperature, the resistance value increases (Fig.2).

Of course the V/I characteristic depends on the ambient temperature and on the heat transfer coefficient to the ambience.

In Fig.2 the characteristic is plotted on a linear scale, in practice, however, logarithmic scales are used more often (Fig.3). PTC thermistors show a certain degree of voltage dependency. At higher voltages the resistance value is somewhat lower than expected. This is the reason why a V/I characteristic is difficult to calculate from the R/T curve with the given dissipation constant. (see: Electrical properties of NTC thermistors, page C7).

It is, however, possible to calculate the top of the V/I characteristic with very good approximation if the R/T characteristic and the dissipation constant is known.

The calculation goes as follows:

The power dissipation is: $W = I^2R$

Thus a small increase in W: $\Delta W = 2IR\Delta I + I^2 \Delta R$

At the top of the V/I curve $\Delta I_p = 0$ thus:

$$\Delta W_p = I_p^2 \Delta R_p \text{ (p indicates that the values are taken at the top of the V/I characteristic).}$$

Also $\Delta W = D \Delta T$ thus:

$$\Delta W_p = D \Delta T_p = I_p^2 \Delta R_p$$

or $\frac{\Delta T_p}{\Delta R_p} \cdot D = I_p^2$

¹) The curie temperature, wellknown as an indication for the behaviour of ceramic capacitors and magnetic materials, is less suitable for use as a practical measure for PTC thermistors.

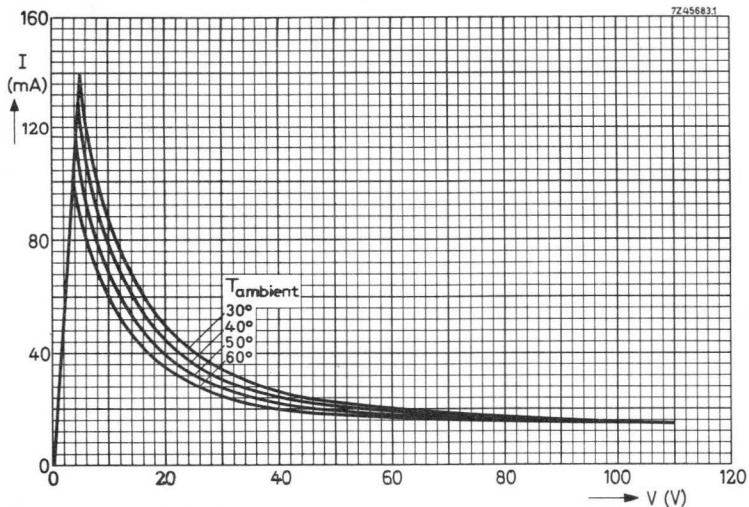

Fig. 2.
Voltage/current characteristics of a PTC thermistor at different ambient temperatures on a linear scale.

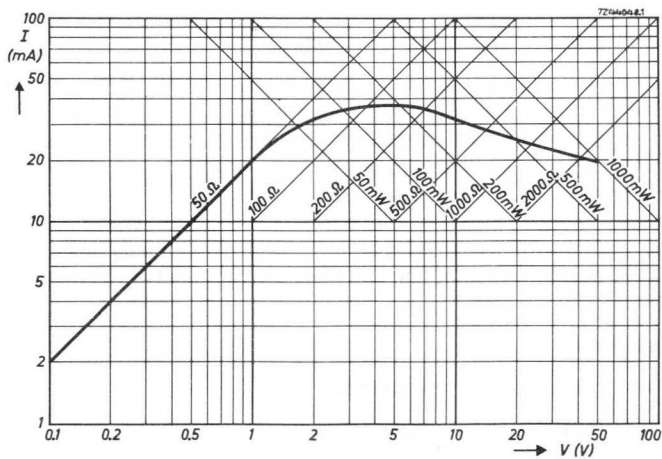
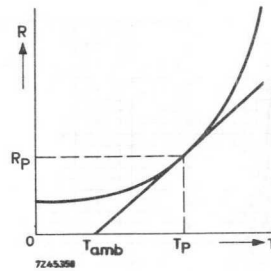

Fig. 3.
Voltage/current characteristic on a logarithmic scale.

Fig. 4.
Part of the resistance/temperature characteristic on a linear scale.



In Fig. 4, the R/T characteristic on linear scale, we see:

$$\frac{\Delta T_p}{\Delta R_p} = \frac{T_p - T_{amb}}{R_p}$$

so

$$I_p = \sqrt{\frac{D(T_p - T_{amb})}{R_p}}$$

With given ambient temperature (T_{amb}) and D, the values R_p and T_p can easily be found (see Fig. 4).

The calculation shows that if D is increased n times (e.g. by a heatsink, or ambience with better heat conductivity) I_p increases \sqrt{n} times.

Furthermore it can be seen that R_p and T_p are independent of the surrounding medium.

PTC THERMISTOR IN SERIES WITH A LOAD

With the voltage/current characteristic it can be shown that due to the non-linearity of the PTC-curve three working points are possible when a load R is connected in series with the PTC (Fig. 5). The characteristic of the load is a straight line intersecting the voltage ordinate at V_a , the supply voltage. P_1 and P_2 are stable working points, P_3 is unstable.

When the voltage V_a is applied to the series connection, equilibrium will be reached at P_1 , a point with a relatively high current. P_2 can only be reached when the top of the V/I curve comes below the load characteristic. This may happen in the following cases:

- (1) V_a increases (Fig. 6);
- (2) the ambient temperature increases (Fig. 7);
- (3) the load resistance decreases (Fig. 8).

The PTC is thus an excellent protective device as it limits the current through the load to a safe value if supply voltage, temperature or current surpass a critical value.

Fig.5.
PTC thermistor in series with a load
showing the possible working points.

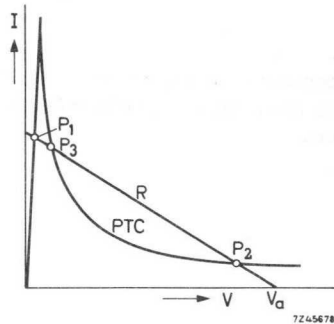

Fig.6.
PTC thermistor in series with a load
showing the influence of the supply
voltage V_a .

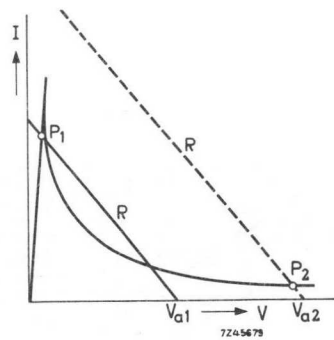

Fig.7.
PTC thermistor in series with a load
showing the influence of the ambient
temperature.

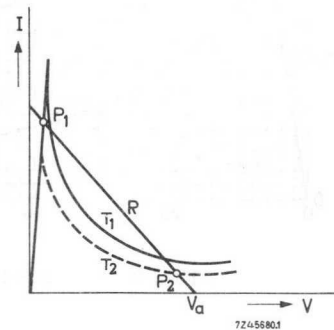

Fig.8.
PTC thermistor in series with a load showing the influence of the load resistance.

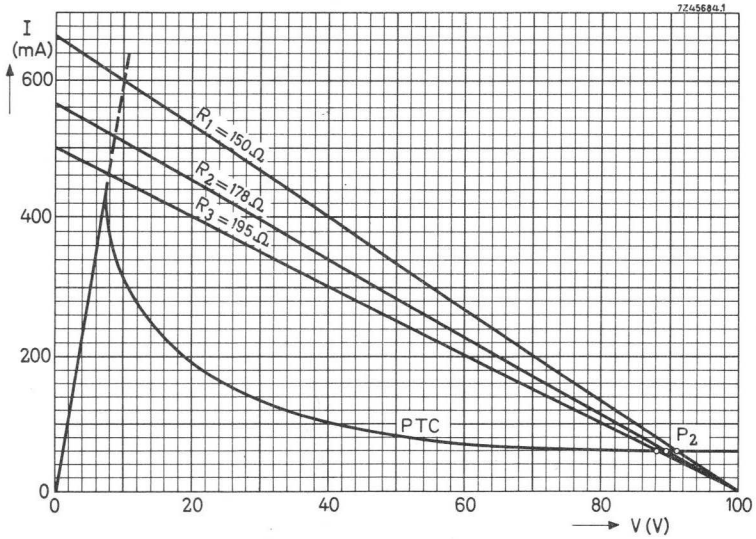
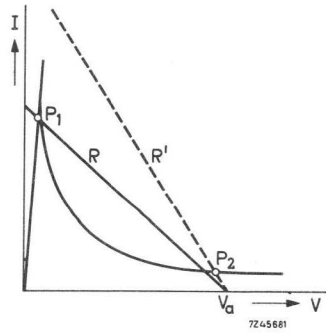

Fig.9. PTC thermistors in series with different resistors.

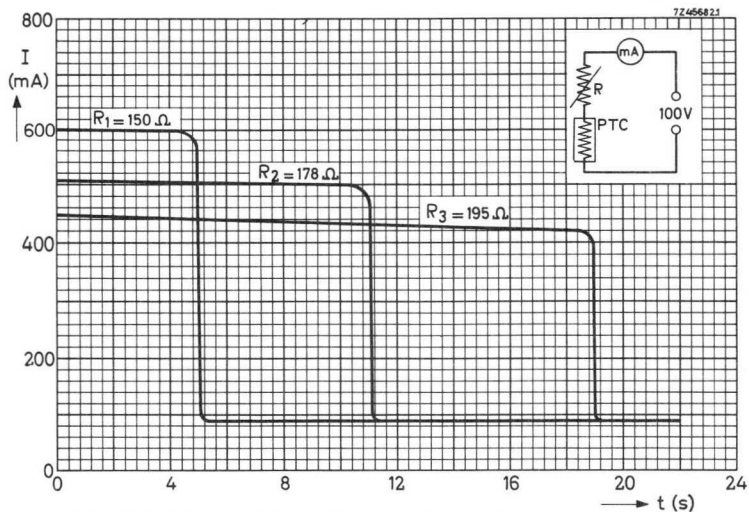

Fig.10. Current/time characteristics showing the influence of the value of the load.

CURRENT/TIME CHARACTERISTICS

If a PTC thermistor is connected in series with a resistance of such a value that the top of the V/I curve lies under the load line, the PTC will heat up till the stable working point P_2 is reached (Fig.9). The time it takes to reach this point depends very much on the value of the load R (Fig.10) and the ambient temperature.

1876
1877
1878
1879
1880
1881
1882

EXPLANATION OF TERMS

Switch temperature (T_S)

The switch temperature T_S is the higher of the two temperatures at which the resistance R_S is twice the minimum resistance R_{min} (see Fig. 1).

So, at $T_S > T_{Rmin}$: $R_S = 2 R_{min}$

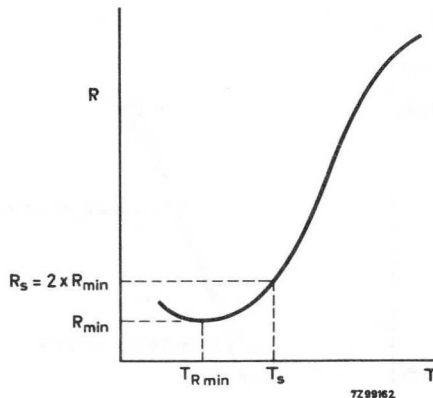
Temperature coefficient (α)

The temperature coefficient $\alpha = \frac{1}{R} \frac{dR}{dT}$.

For R-T curves plotted on a log R-lin T scale, as they practically all are, we can work out

$$\alpha = \frac{d \ln R}{dT} = \frac{1}{0.4343} \cdot \frac{d \log R}{dT}$$

It can be seen that the tangent at a point of the R-T characteristic (see Fig. 2) is proportional to the α at that point.

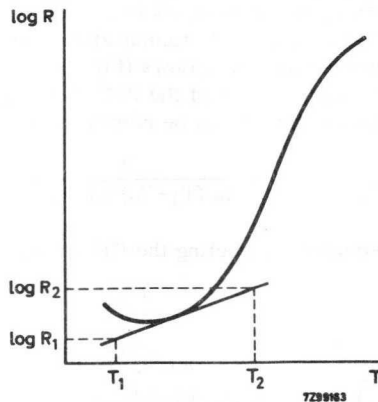

α can be calculated from

$$\alpha = \frac{100}{0.4343} \cdot \frac{\log R_2 - \log R_1}{T_2 - T_1} \text{ \% / deg C}$$

where R_1 and R_2 are points on the tangent with T_1 and T_2 being the corresponding temperatures.

In the data sheets the maximum temperature coefficient is given, this is the α measured at the inflection point of the $\log R$ -lin T characteristic (i.e. the point where $\frac{d^2 \log R}{dT^2} = 0$, see Fig.3)

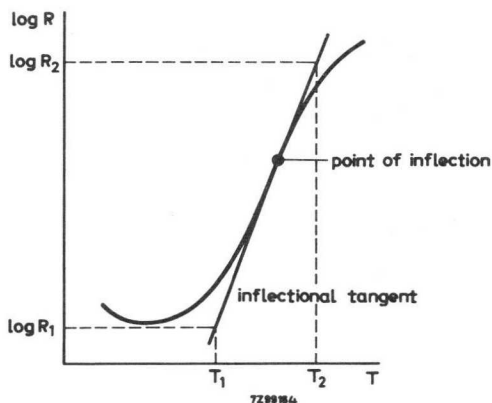

When one resistance decade is taken ($R_2 = 10 R_1$) the formule reduces to

$$\alpha = \frac{100}{0.4343} \cdot \frac{1}{T_2 - T_1} \text{ \% / deg C}$$

Thermal time constant (τ)

The thermal time constant represents the time required for a thermistor to change 63.2% of the total difference between its initial and final body temperatures when subjected to a step function change in temperature under zero-power conditions.

The τ given in the data is found as follows (for $T_S > 25^\circ\text{C}$):

Measure T_1 , being the temperature of the PTC at V_{\max} , at an ambient temperature of $T_0 = 25^\circ\text{C}$; T_S is known, then τ can be calculated from:

$$\tau = \frac{t}{\ln (T_1 - T_0) / (T_S - T_0)},$$

where t is the time required for cooling the PTC from T_1 to T_S in still air of 25°C .

Voltage dependence aspects

PTC thermistors show a voltage dependence. This effect can be explained with the aid of a parallel connection of an "ideal PTC" having no voltage dependence and an "ideal VDR" following exactly the formula $V = C \cdot I^\beta$ (see Fig. 4).

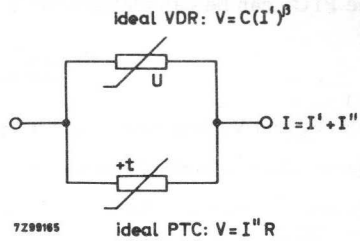

Plotted on a log I-log V scale at an arbitrary constant temperature the ideal PTC and ideal VDR can be represented by 2 straight lines (see Fig. 5).

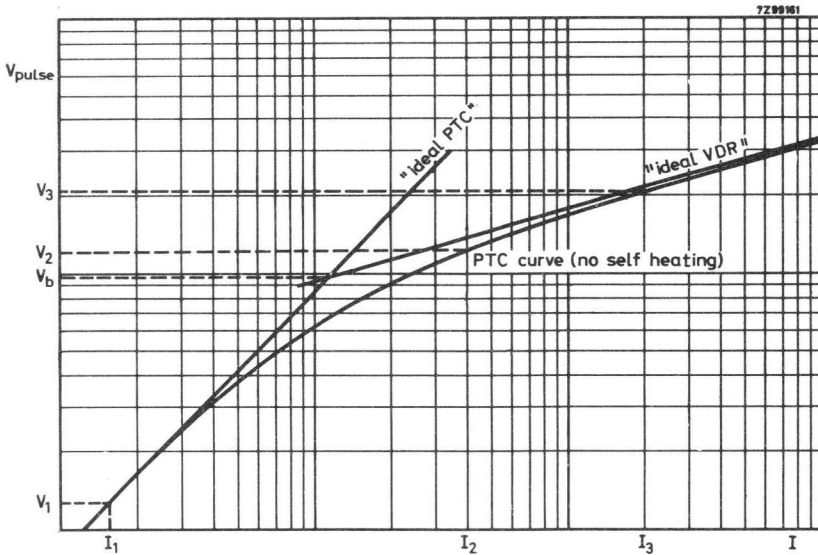

These lines can be seen to coincide with the PTC curve (measured under pulse conditions to avoid internal heating) at low voltages where the ohmic behaviour is the deciding factor, and at high voltages where the VDR effect becomes more important.

Two aspects of the voltage dependence are specified in the data sheets:

Balance voltage (V_b)

Where the two straight lines intersect the current through the ideal PTC is equal to the current through the ideal VDR. The voltage at which this occurs is called the balance voltage V_b and is specified at a certain temperature.

Voltage dependence (β)

The β -value of the ideal VDR, being a measure for the voltage dependence of the

the PTC, can be calculated with the formula:

$$\beta = \frac{\log V_3/V_2}{\log (I_3 - V_3/R)/(I_2 - V_2/R)}$$

with V_3 and V_2 being pulse voltages $> V_b$ and $R = \frac{V_1}{I_1}$, measured at $V_1 \leq 1.5 V_{dc}$.

The β -value is also specified at a certain temperature.

V_b and β -value are useful parameters for estimating the voltage dependence of a particular PTC.

HOW TO MEASURE PTC THERMISTORS

For general information regarding measuring techniques and apparatus we refer to the section "How to measure NTC thermistors" on p.C15, which covers the same problems. As PTC thermistors often show a very high temperature coefficient especially at high temperatures, measurements at these high temperatures must be carried out with particular care. Even an error in temperature of 0.1 deg C can give an error in resistance of a few percent. Specially calibrated thermometers have to be used. Stem correction has to be applied; this is often forgotten but deviations of more than 0.1 deg C may result if it is not. (See e.g. "Handbook of Chemistry and Physics", 44th edition, page 2418.)

The stem correction formula for fluid thermometers is:

$$T_C = T_O + F \cdot L (T_O - T_M)$$

T_C = corrected temperature

T_O = observed temperature

T_M = mean temperature of exposed stem

L = length of the exposed column in degrees above the surface of the substance whose temperature is being determined.

F = correction factor.

For approximate work and when the liquid in the thermometer is mercury a value for F of 0.00016 is generally used.

So e.g. with $T_O = 110$ °C; $T_M = 70$ and $L = 50$ °C we find: $T_C = 110.32$, thus without stem correction an error of more than 0.3 deg C would have been made. It is also necessary to measure the resistance with a voltage below 2 V in order not to heat the PTC and also to diminish voltage-dependent effects.

TOLERANCES

The resistance values of standard PTC thermistors are specified at the following temperatures.

(1) 25 °C;

(2) A temperature above the switch temperature.

Further the switch temperature is given.

For each standard type tolerances are specified for the R_{25} and the high temperature resistance value. The tolerance on switch temperature is not specified; normally it is only a few degrees C.

Special types are often specified according to the requirements for the particular application. The PTC thermistors for motor control, for instance, can be specified at a high temperature with a rather close tolerance, while the tolerance below the switch temperature, being less important, is much wider. PTC thermistors for current limiting applications are in most cases specified in terms of voltage and current.

It will be clear that the specification and the tolerances of PTC thermistors depend on the application, and are not limited to the standard range published in this book.

THE UNIVERSITY OF CHICAGO

UNIVERSITY OF CHICAGO
LIBRARY

APPLICATIONS

The applications of PTC thermistors can be classified in two main groups:

- (1) Applications where the temperature of the PTC is primary determined by the temperature of the ambient medium.
- (2) Applications where the temperature of the PTC is primary determined by the current through the PTC thermistor.

The first group comprises applications such as temperature-measurement and control and circuits for protection against excessive temperatures (e.g. motor protection.)

The second group includes applications such as current stabilization and limiting of current relay retardation, fluid-level indication and circuits for protection against over-voltages and short circuits.

Principle circuits of the above mentioned applications are given in the following pages.

No details of component data are mentioned as these can be calculated on basis of available supply voltages and data of relays or other vital components. Details on more complicated circuits will be given on request.

REMARKS ON THE USE OF PTC THERMISTORS

Do not apply a voltage above V_{max} to the PTC, since this may result in a breakdown of the thermistor.

Do not connect PTC thermistors in series in order to obtain higher permissible voltages or wattages: this may lead to a breakdown of the PTC which heats up a bit faster than the other(s) which results in too high voltage over this particular PTC.

If special PTC characteristics are required which cannot be found in this book please specify your requirements as they can perhaps be fulfilled by one of our non-listed types.

APPLICATION EXAMPLES

Protection against over-voltage and short circuit

As soon as the current increases the PTC limits the current to a safe value.

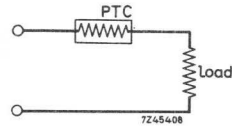

Current stabilization

By applying a parallel resistor a current stabilization circuit is obtained which compensates slowly varying supply voltages.

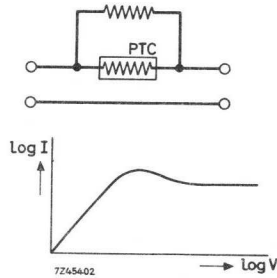

Spark suppression

A PTC across the switch acts as a spark suppressor. When the switch opens the low resistance of the cold PTC prevents sparking.

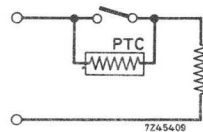

Delaying action relays

A certain time after applying the voltage the relay is activated.

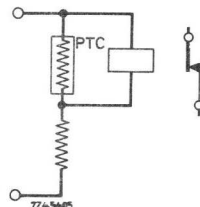

Temperature protection
of electric motors

As soon as one or more windings become too hot the motor is switched-off.

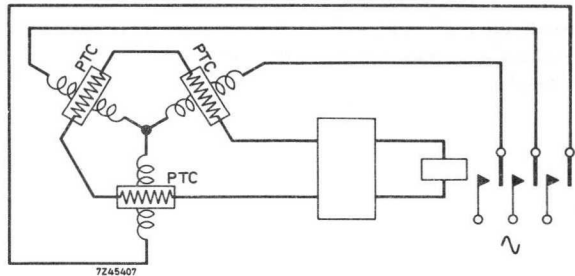
Alarm installation

The PTC reacts on ambient temperature (too low or too high).

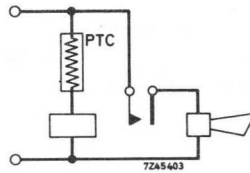
Time delay circuit

When the button is pressed the relay is activated and the lamp lights up. After some time the relay falls off due to the increase in resistance value of the PTC.

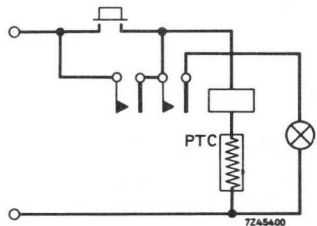
Liquid-level indication

The PTC thermistors above the fluid-level will be heated to a temperature above T_{switch} while when immersed they are cooled so that their resistance value is low.

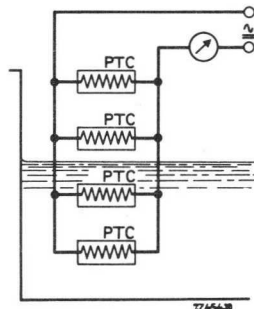

Thermal oscillator

With an NTC and a PTC thermistor in series a thermal oscillator can be obtained.

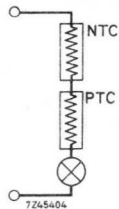

PTC-NTC multivibrator

One of the PTC's will heat up, as its resistance value increases the NTC in parallel will heat up while leaving the first one time to cool etc.

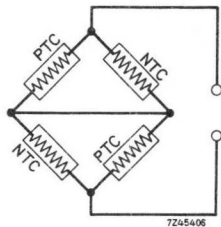

Thermostat circuits

Two principle circuits are possible. In the first circuit the PTC thermistors act as a control element and as a heater at the same time while in the second circuit they function only as a control element.

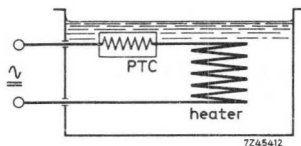
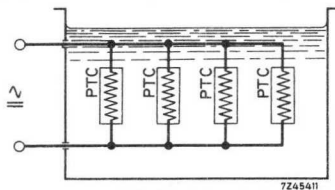

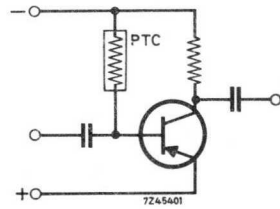
Temperature compensation of transistor circuitsThermostat for washing machines

A thermostat for three temperatures.

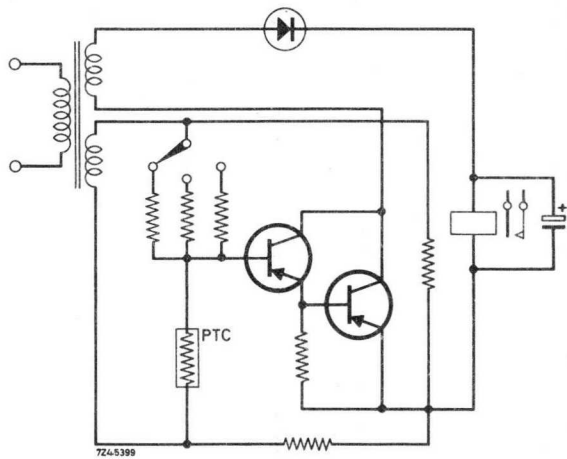

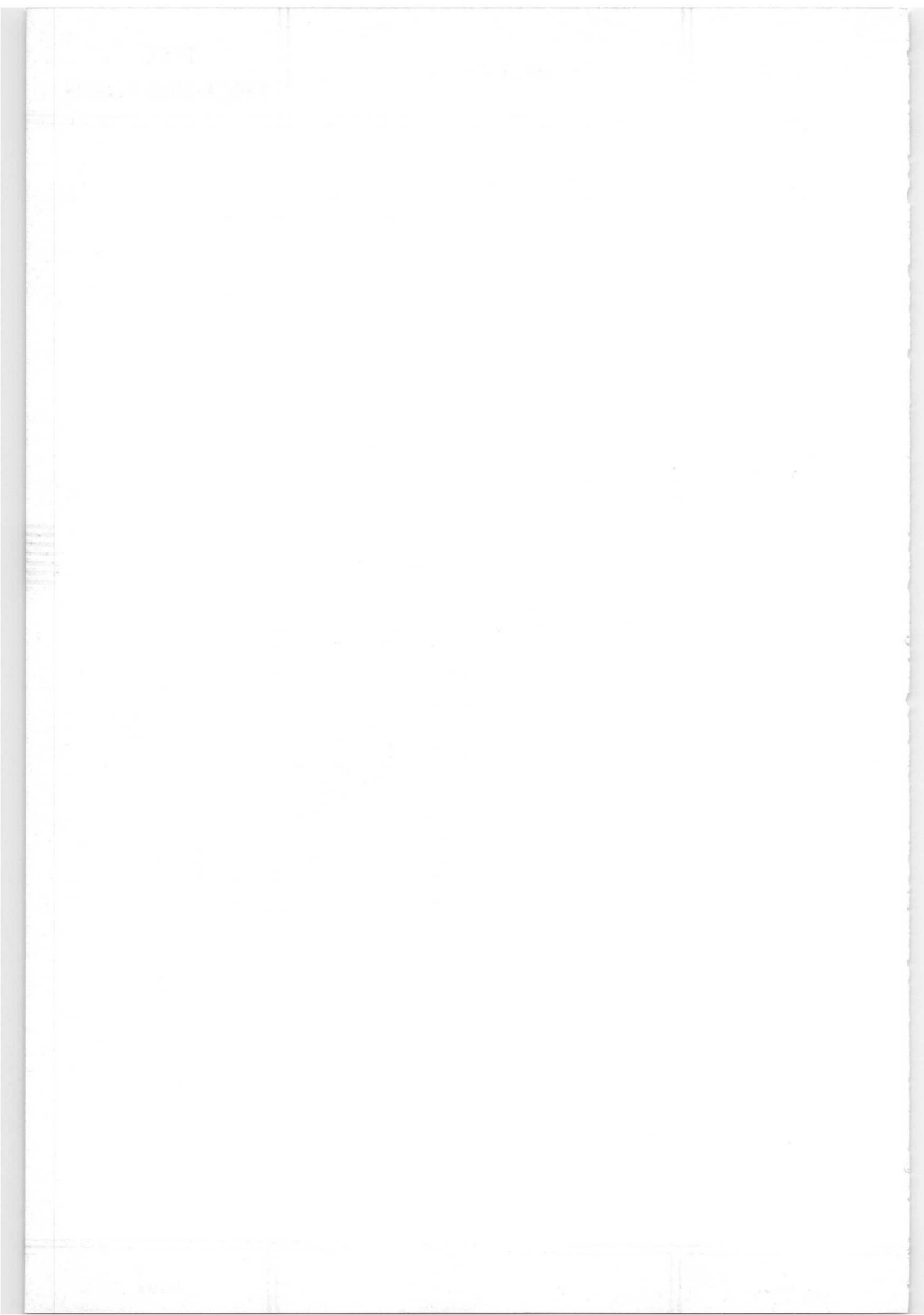

PTC THERMISTORS standard disc type

QUICK REFERENCE DATA

Resistance values at +25 °C	50 and 60 $\Omega \pm 30\%$
Resistance at other temperatures	} see table
Switch temperature	
Temperature coefficient	
Max. voltage	25 V d.c.
Dissipation factor	7 mW/deg C approx.
Operating temperature range at zero power	-10 to +125 °C 1)
at V_{\max}	0 to +55 °C

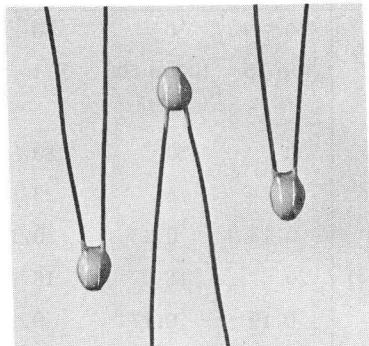

RZ 19269-7

APPLICATION

Suitable for all kinds of applications.

DESCRIPTION

The thermistors have a positive temperature coefficient. They consist of a disc provided with two solid tinned copper wires. The thermistor body is lacquered but not insulated.

1) PTC thermistor 2322 660 91009: -10 to +150 °C.

2322 660 91006
to
2322 660 91009

PTC THERMISTORS
standard disc type

MECHANICAL DATA

Dimensions in mm

catalogue number	colour band
2322 660 91006	red
2322 660 91007	orange
2322 660 91008	yellow
2322 660 91009	green

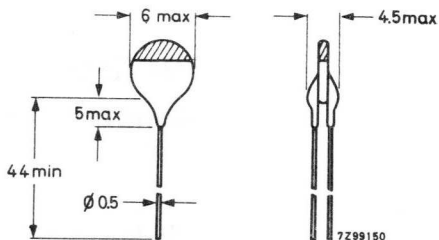

Fig. 1.

Marking

The thermistors are marked with a colour band at the top of the body according to Fig. 1.

Weight 0.4 g approximately

Mounting In any position by soldering

ELECTRICAL DATA

	catalogue number 2322 660 followed by				unit
	91006	91007	91008	91009	
Resistance at 25 °C 1)	60	50	50	50	Ω
Resistance at 125 °C 1)	3 to 15	100 to 500	50 to 500		kΩ
Resistance at 150 °C 1)				0.1 to 1.2	MΩ
Switch temperature	30	50	80	105	°C
Temperature coefficient	7	16	23	40	%/deg C
Heat capacity 2)	0.13	0.13	0.13		J/deg C
Thermal time constant 2)	20	18	18		ε
Voltage dependence β	0.19	0.17	0.18		
Balance voltage	35	12.5	23		V _{dc}

Tolerance on R₂₅ ± 30%
 Max. voltage 25 V_{d.c.}
 Dissipation factor 7 mW approx.
 Operating temperature range
 at zero power -10 to +125 °C 3)
 at V_{max} 0 to +55 °C

- 1) Measuring voltage not exceeding 1.5 V_{dc} to avoid internal heating.
- 2) Measurements made with specimen in phosphor bronze clips, in still air.
- 3) PTC thermistor 2322 660 91009; -10 to +150 °C.

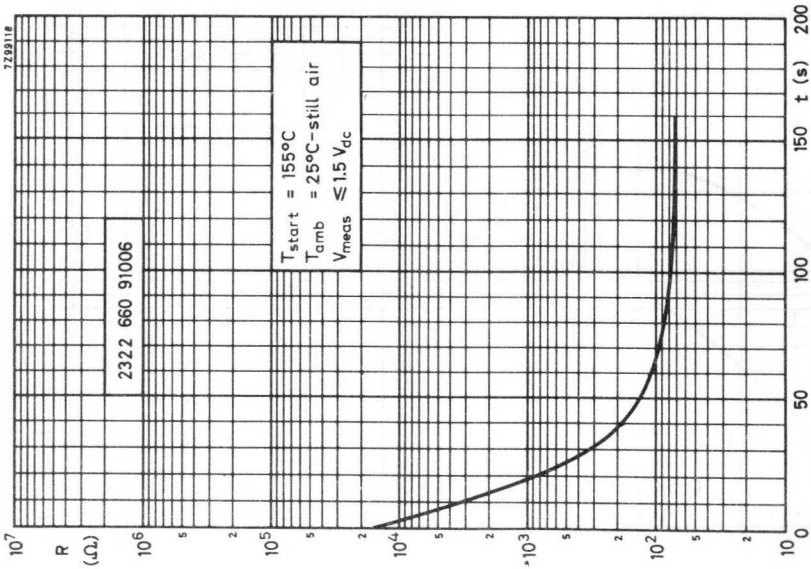

Fig. 3.

Typical resistance/time (cooling) characteristic

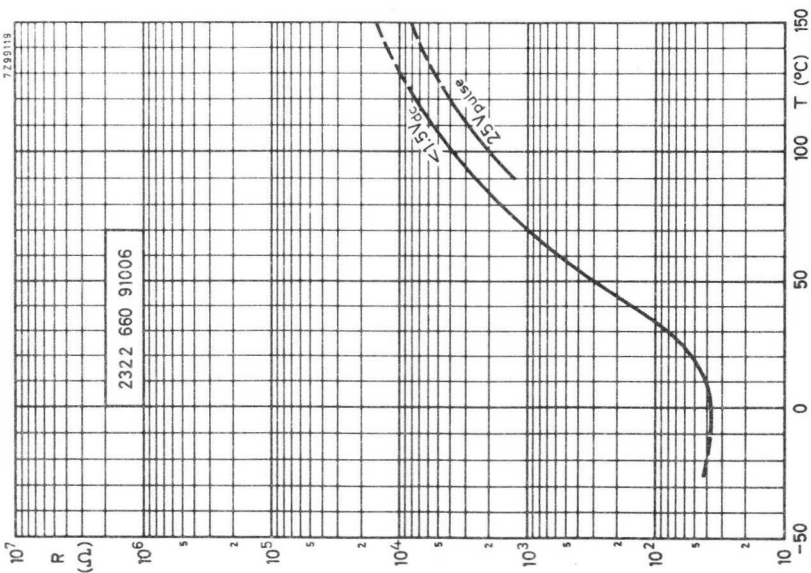

Fig. 2.

Typical resistance/temperature characteristics



2322 660 91006
to
2322 660 91009

PTC THERMISTORS
standard disc type

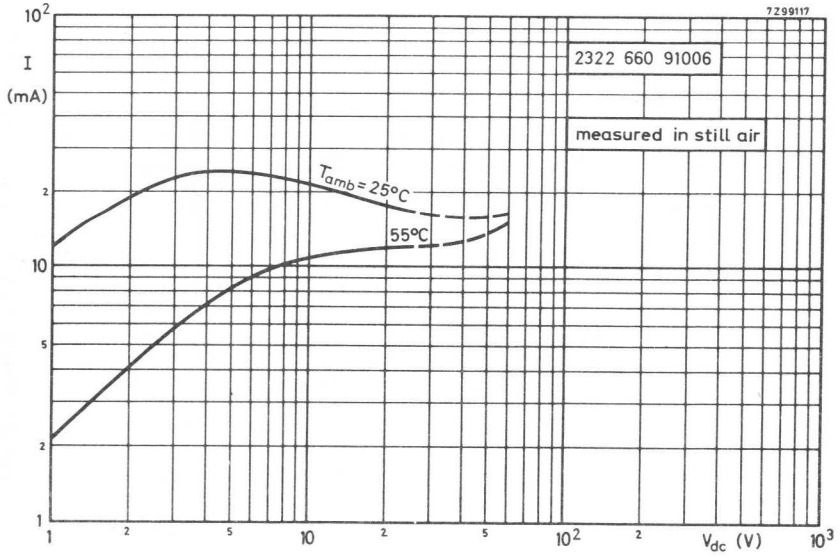

Fig. 4. Typical voltage/current characteristics

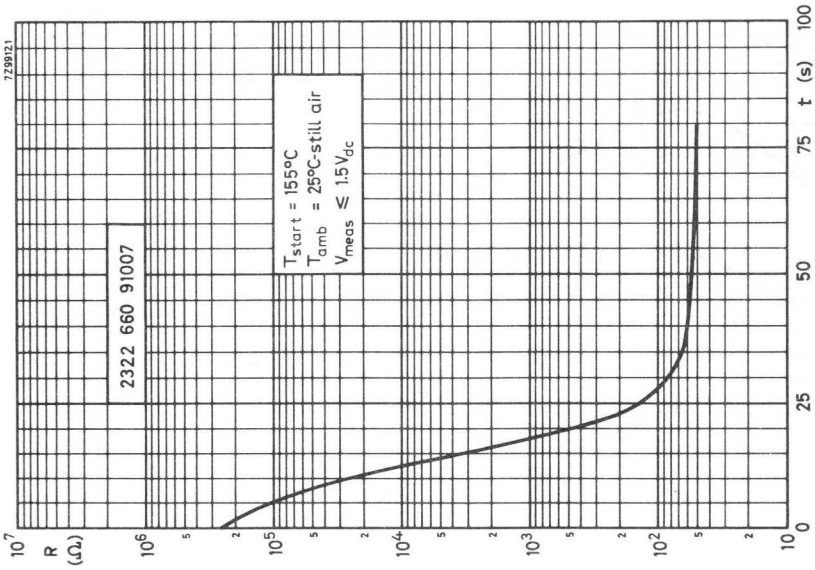

Fig. 6.
Typical resistance/time (cooling) characteristic

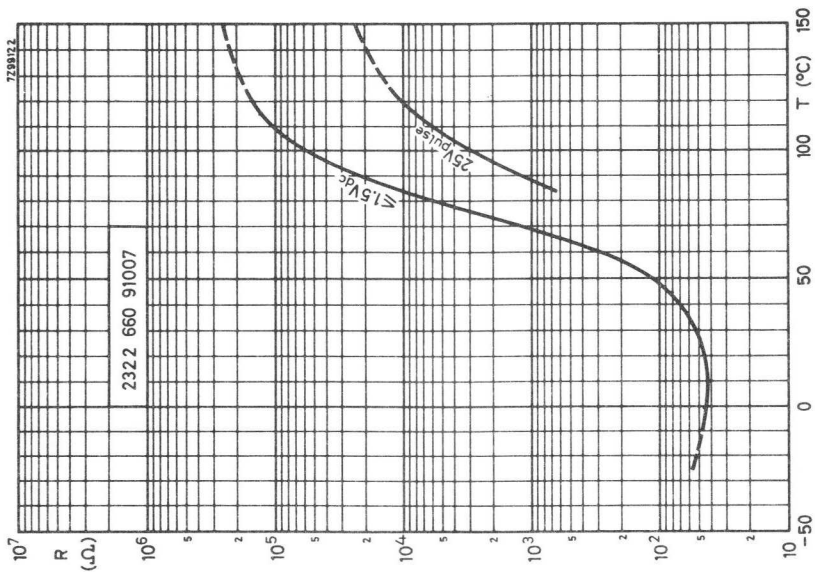

Fig. 5.
Typical resistance/temperature characteristics



2322 660 91006
to
2322 660 91009

PTC THERMISTORS
standard disc type

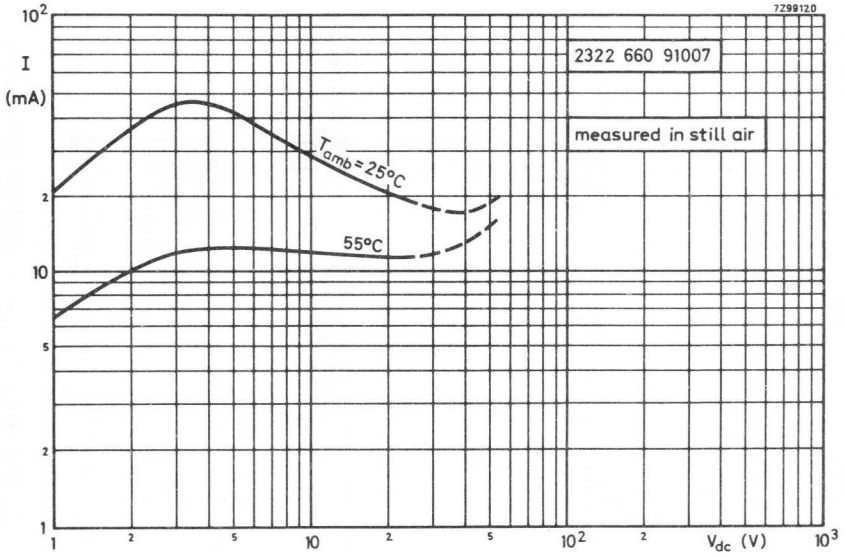

Fig. 7. Typical voltage/current characteristics

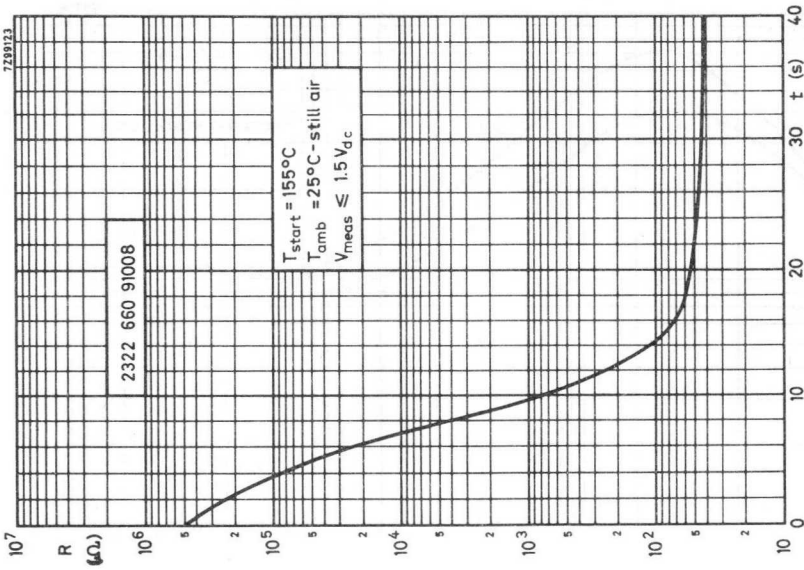

Fig. 9.

Typical resistance/time (cooling) characteristic

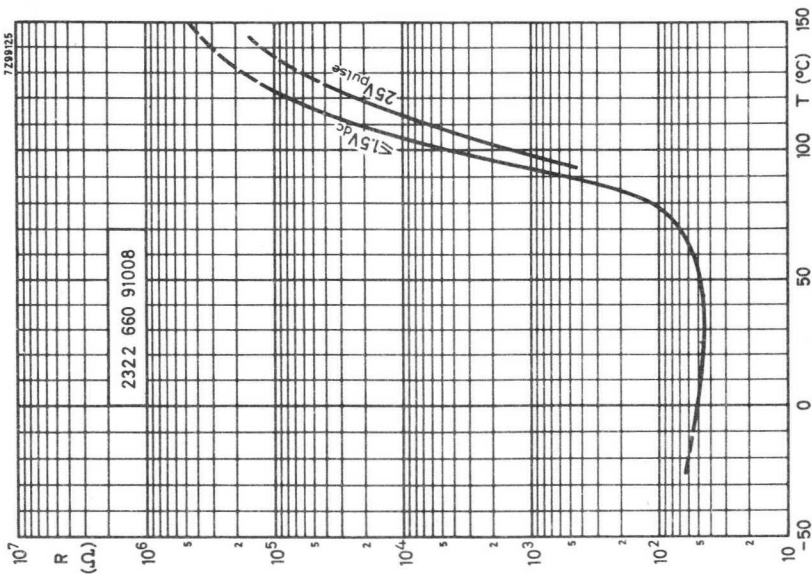

Fig. 8.

Typical resistance/temperature characteristics



2322 660 91006
to
2322 660 91009

PTC THERMISTORS
standard disc type

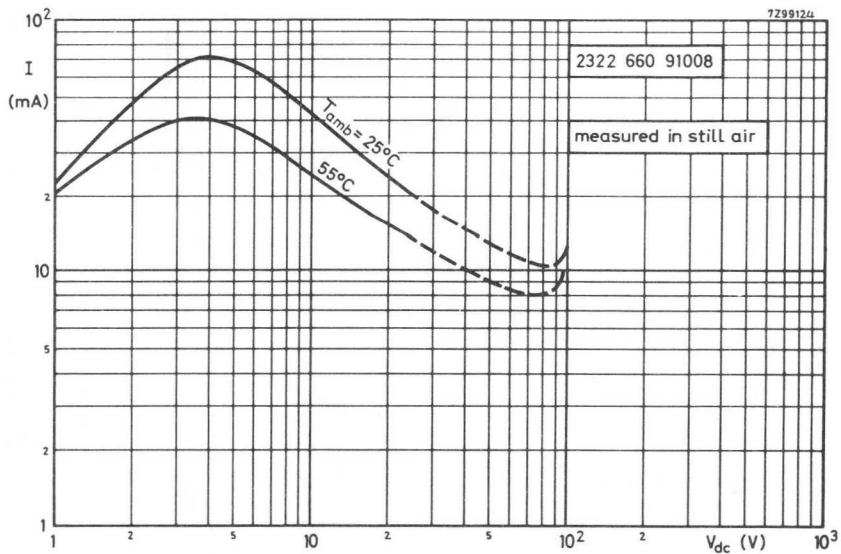

Fig. 10. Typical voltage/current characteristics

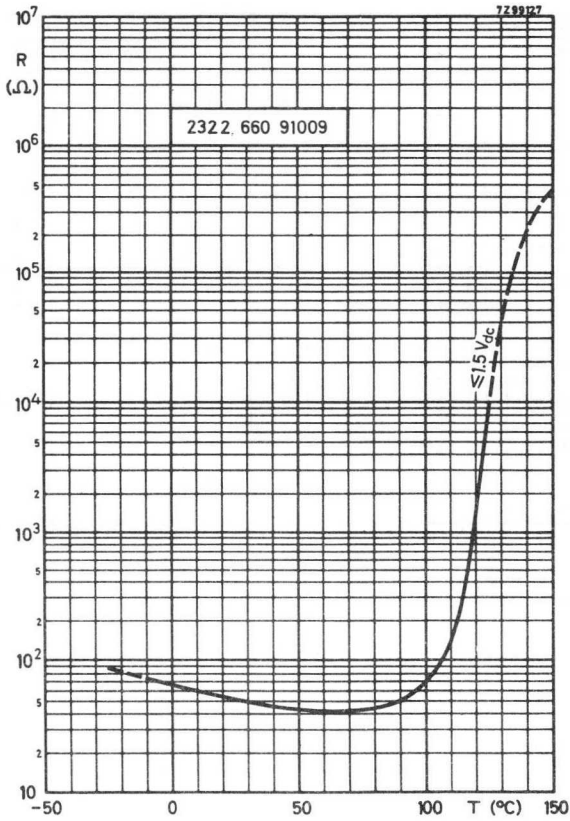

Fig. 11. Typical resistance/temperature characteristic

2322 660 91006
to
2322 660 91009

PTC THERMISTORS
standard disc type

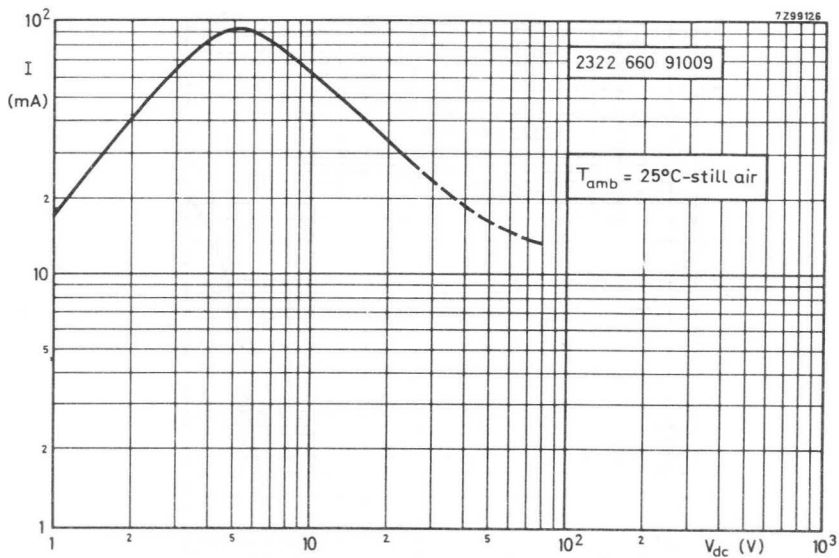

Fig. 12. Typical voltage/current characteristic

TESTS AND REQUIREMENTS

According to I. E. C. 68, unless otherwise specified.

test	test method	duration	$\Delta R/R$ in %	
			at 25°C	at 125°C ³⁾
Cold at -10 °C	A	1000 h	± 3	± 3
Storage at +25 °C	H	1000 h	± 3	± 3
Dry heat +125 °C	B	1000 h	± 5	± 5
Thermal shock -10 to +125°C	Na	5 cycles	± 3	± 3
Damp heat	C	1000 h	± 5	± 5
Dissipation at V = 25 V _{rms} and T _{amb} = +55 °C		1000 h	± 5	± 5
Cycles test at V = 25 V _{rms} and T _{amb} = 0 °C		1000 cycles 1 min. on/ 9 min. off	± 10	± 10
Robustness of terminations	U			
Tensile strength 10 N	Ua	10 s	1)	
Bending 5 N	Ub	2 times	1)	
Soldering	T			
Solderability	par. 3.2.3	3 to 4 s	2)	
Resistance to heat	par. 3.2.4	3 to 4 s	± 2	± 2

1) Leads should neither come loose nor break.

2) Leads must be solderable initially and after 6 months storage with solder containing resin flux.

3) For thermistor 2322 660 91009 at 150 °C.

QUALITY LEVEL

Sampling and data evaluation for quality level in accordance with MIL-STD-105D.

A.Q.L. 1 %, major defects - Electrical

A.Q.L. 1.5 %, major defects - Mechanical

A.Q.L. 4 %, minor defects - Physical

PACKAGING

250 pieces per box (cardboard)

Page 100 of 100

100

PTC THERMISTORS standard disc type

QUICK REFERENCE DATA

Resistance value at 25 °C	30 to 50 Ω
Resistance value at other temperatures	}
Switch temperature	
Temperature coefficient	
Max. voltage	
Dissipation factor	
Operating temperature range at zero power	-10 to +125 °C
at V_{\max}	0 to +55 °C

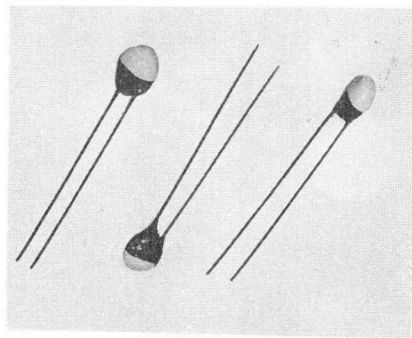

RZ 17758-7

APPLICATION

Suitable for all kinds of applications.

DESCRIPTION

The thermistors have a positive temperature coefficient. They consist of a disc provided with two solid tinned copper wires. The thermistor body is lacquered but not insulated.

2322 661 91002
to
2322 661 91005

PTC THERMISTORS
standard disc type

MECHANICAL DATA

Dimensions in mm

Table 1

catalogue number	colour band	H _{max}
2322 661 91002	yellow	6.5
2322 661 91003	green	6.5
2322 661 91004	orange	6.5
2322 661 91005	red	5.5

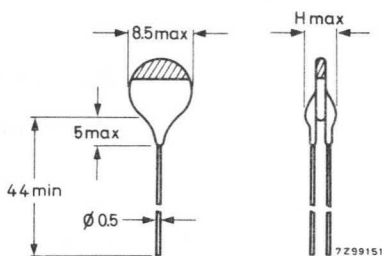

Fig. 1.

Marking

The thermistors are marked with a colour band at the top of the body according to Fig. 1.

Weight

1 g approximately

Mounting

In any position by soldering

ELECTRICAL DATA

Table 2 1)

R ₂₅ 2)	R at other temperatures 3)		switch temper- ature	temperature coefficient	V _{max}	dissipation factor 4)	thermal time constant 4)	heat capacity 4)	voltage depen- dence β	balance voltage	catalogue number
(Ω)	T (°C)	R (Ω)	(°C)	(%/deg C)	(Vd. c.)	(mW/deg C)	(s)	(J/deg C)		(V)	
50	60 100	< 100 > 10000	+ 80	18	50	8.5	50	0.425	0.48	110	2322 661 91002
40	95 130	< 80 > 10000	+ 110	75	50	8.5	50	0.425	0.48	25	2322 661 91003
30	40 100	< 90 > 10000	+ 45	16	50	8.5	50	0.425	0.25	65	2322 661 91004
50	100	3000 - 20 000	+ 25	9	40	6	40	0.240	0.35	25	2322 661 91005

Tolerance on resistance
at 25 °C (R₂₅)

± 15 Ω

Operating temperature range

at zero power
at V_{max}

-10 to +125 °C
0 to +55 °C

1) Typical values, except R and V_{max}.

2) Measuring voltage not exceeding 1.5 V_{dc} to avoid internal heating.

3) Measurements made without internal heating occurring.

4) Measurements made with specimen in phosphor-bronze clips, in still air.



2322 661 91002
to
2322 661 91005

PTC THERMISTORS
standard disc type

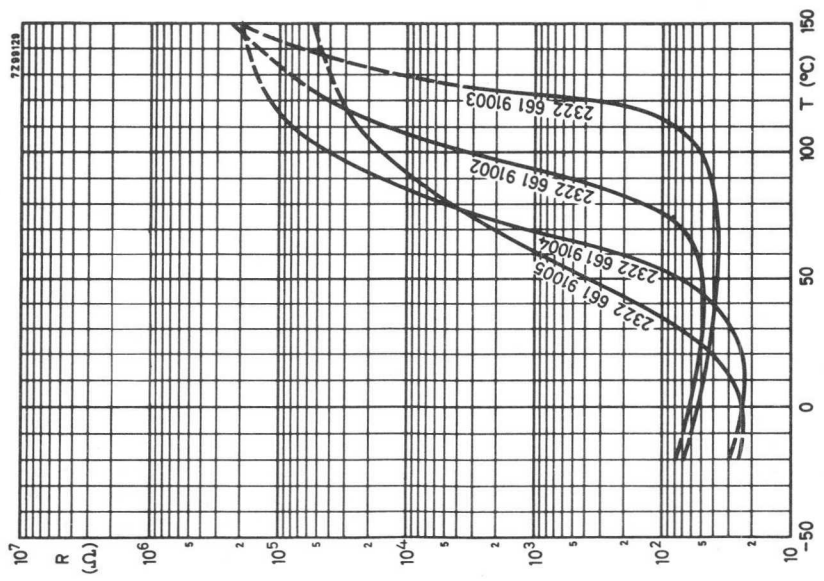
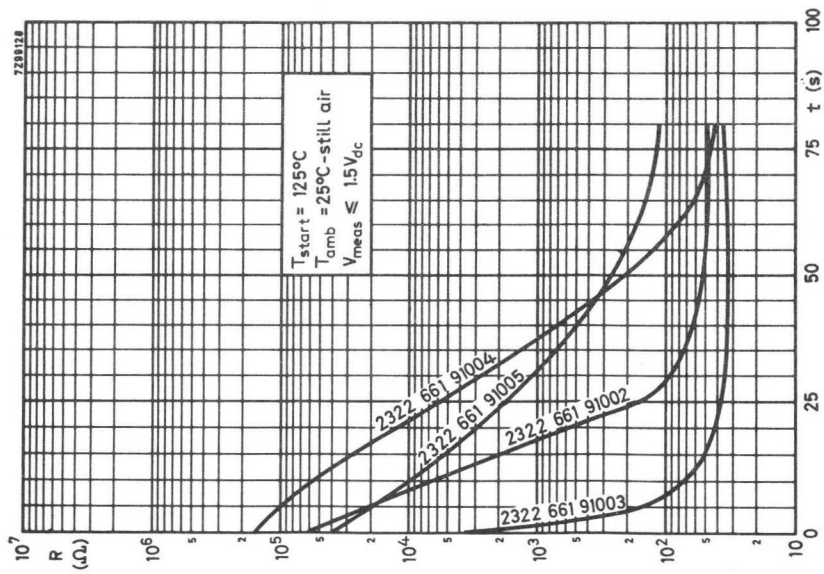

Fig. 2. Typical resistance/temperature characteristics Fig. 3. Typical resistance/time (cooling) characteristics

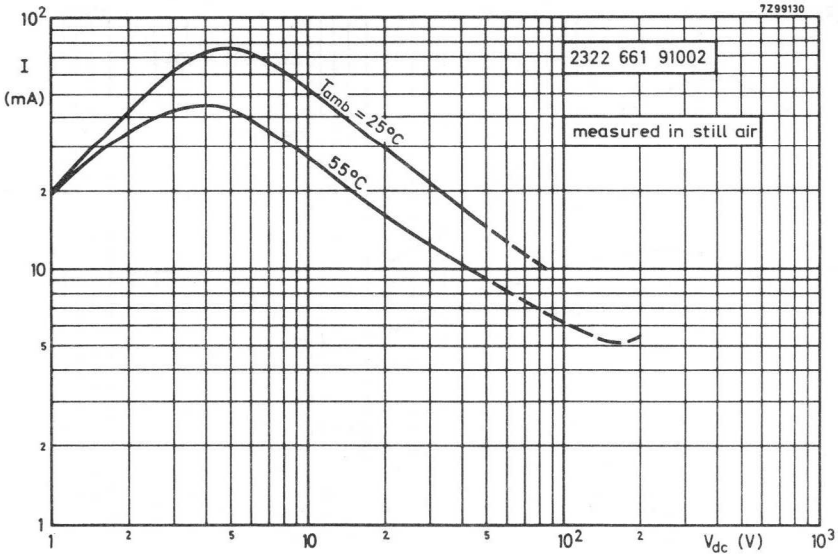

Fig.4a. Voltage/current characteristics

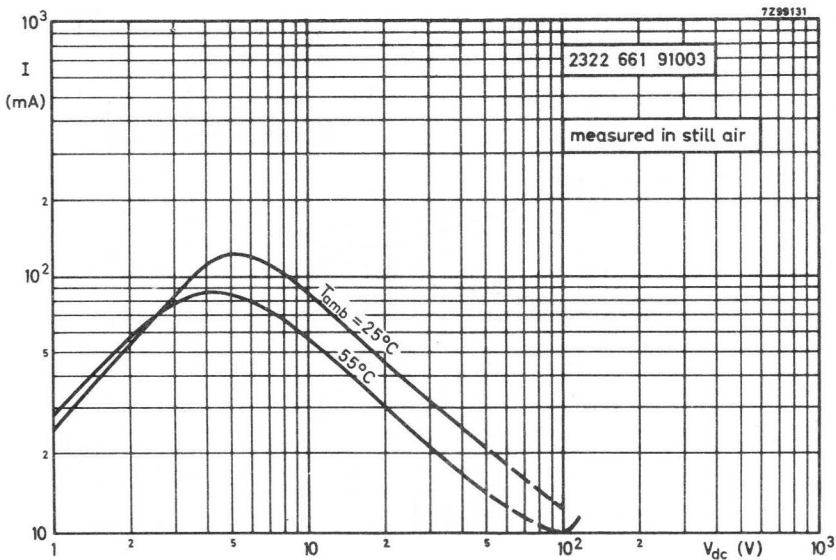

Fig.4b. Voltage/current characteristics

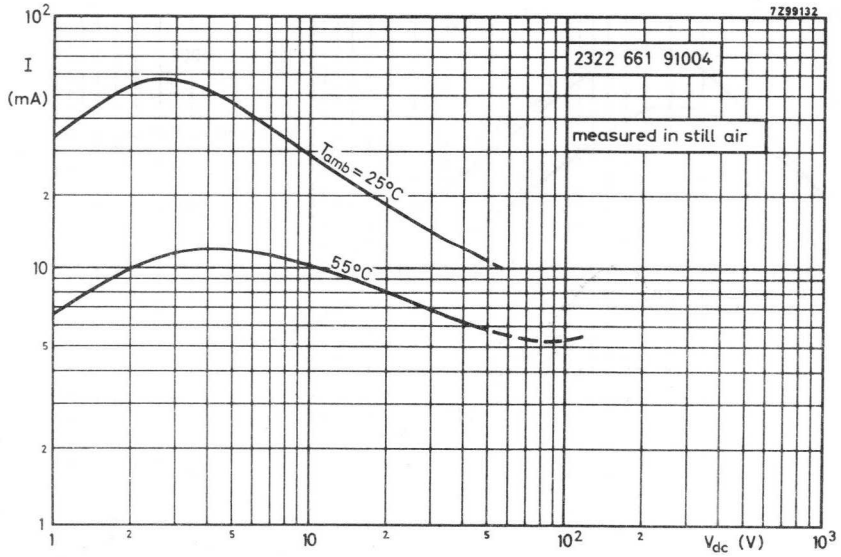

Fig. 4c. Voltage/current characteristics

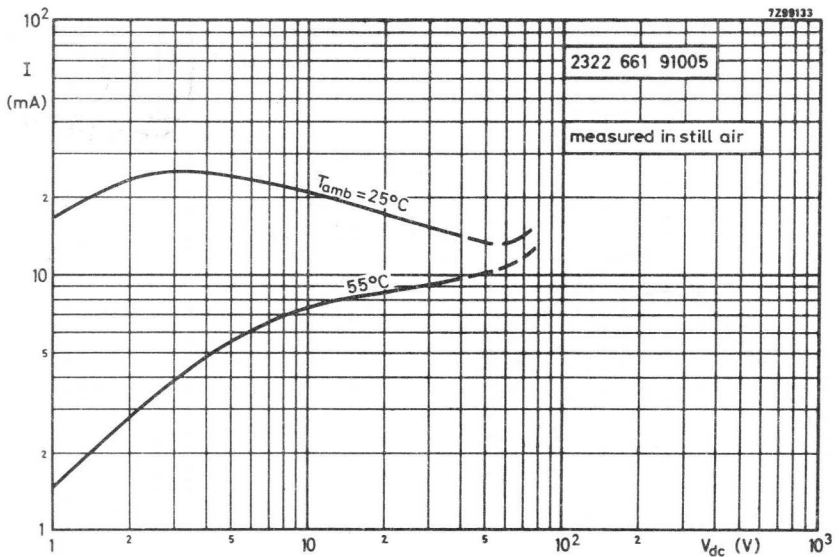

Fig. 4d. Voltage/current characteristics

TESTS AND REQUIREMENTS

According to I.E.C. 68, unless otherwise specified.

Table 3

test	test method	duration	$\Delta R/R$ in %	
			at 25 °C	at 3)
Cold at -10 °C	A	1000 h	± 3	± 3
Storage at +25 °C	H	1000 h	± 3	± 3
Dry heat +125 °C	B	1000 h	± 5	± 5
Thermal shock -10 to +125 °C	Na	5 cycles	± 3	± 3
Damp heat	C	1000 h	± 5	± 5
Dissipation at V_{max} 4) and $T_{amb} = +55$ °C		1000 h	± 5	± 5
Cycle test at V_{max} 4) and $T_{amb} = 0$ °C		1000 h 1 min on/9 min off	± 10	± 10
Robustness of terminations	U			
Tensile strength 10 N	Ua	10 s	1)	
Bending 5 N	Ub	2 times	1)	
Soldering	T			
Solderability at 230 °C	par. 3.2.3	3 to 4 s	2)	
Resistance to heat at 230 °C	par. 3.2.4	3 to 4 s	± 2	± 2

1) Leads should neither come loose nor break.

2) Leads must be solderable initially and after six months storage with solder containing resin flux.

3) At temperatures stated in table 2, second column.

4) V_{max} stated in table 2.

QUALITY LEVEL

Sampling and data evaluation for quality level in accordance with MIL-STD-105D

A.Q.L. 1 %, major defects - Electrical

A.Q.L. 1.5 %, major defects - Mechanical

A.Q.L. 4 %, minor defects - Physical

PACKAGING 250 pieces per box (cardboard)

00070 130 9900

04

00070 130 9900

PTC THERMISTOR

QUICK REFERENCE DATA

Resistance value at 25 °C	36 to 50 Ω
Resistance value at 175 °C $V_{\text{pulse}} = 180 \text{ V}$	> 25 k Ω
Switch temperature	115 °C approx.
Temperature coefficient	46 %/deg C approx.
Max. voltage	180 V _{dc}
Dissipation factor	11 mW/deg C approx.
Operating temperature range at zero power	0 to 155 °C
at V_{max} .	0 to +55 °C

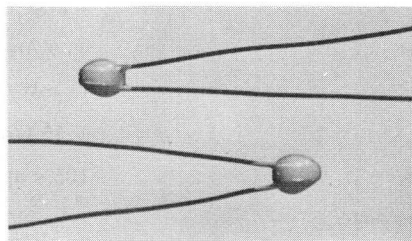

RZ 19269-7

APPLICATION

This PTC thermistor has been designed for the protection of telegraphy relay contacts.

DESCRIPTION

This type has a positive temperature coefficient. It consists of a disc provided with two solid tinned brass wires. The thermistor body is lacquered but not insulated.

MECHANICAL DATA

Dimensions in mm

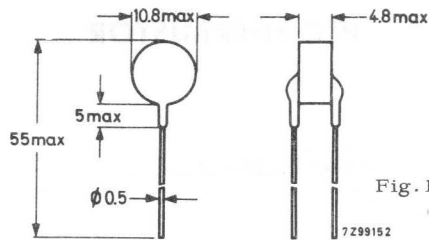

Weight 0.5 g approximately
Mounting In any position by soldering

ELECTRICAL DATA

Resistance at +25 °C (T_{ref})	36 to 50 Ω ¹⁾
Resistance at +115 °C	< 120 Ω ¹⁾
Resistance at +175 °C, $V_{pulse} = 180$ V	> 25 k Ω ²⁾
Current at +25 °C, $V_{dc} = 180$ V continuously	< 10 mA ³⁾
Switch temperature	+115 °C approx
Temperature coefficient	46 %/deg C approx
Dissipation factor	11 mW/deg C approx ³⁾
Heat capacity	1.15 J/deg C ³⁾
Thermal time constant	105 s approx ³⁾
Operating temperature range	
at zero power	0 to +155 °C
at V_{max}	0 to +55 °C
Voltage dependence β at +150 °C	0.34 approx
Balance voltage	125 V_{dc} approx
Maximum voltage (V_{max}) at +55 °C	180 V_{dc}

1) Measuring voltage not exceeding 1.5 V_{dc} to avoid internal heating

2) Measurement made without internal heating occurring.

3) Measurement made with specimen in phosphor bronze clips, in still air.

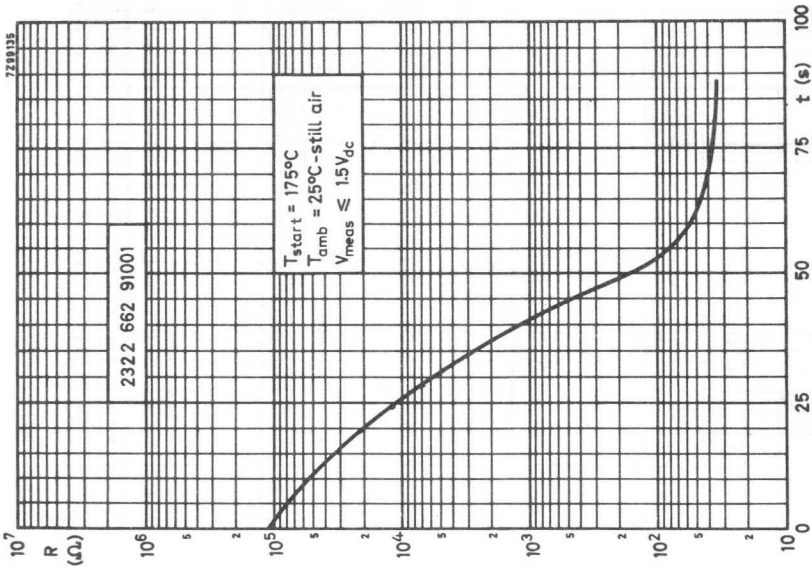

Fig. 3
Typical resistance/time (cooling) characteristic

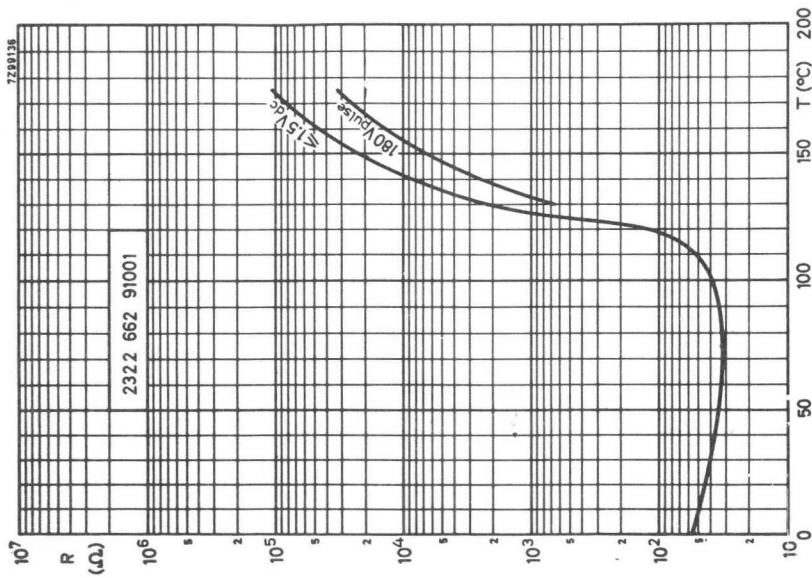

Fig. 2
Typical resistance/temperature characteristics



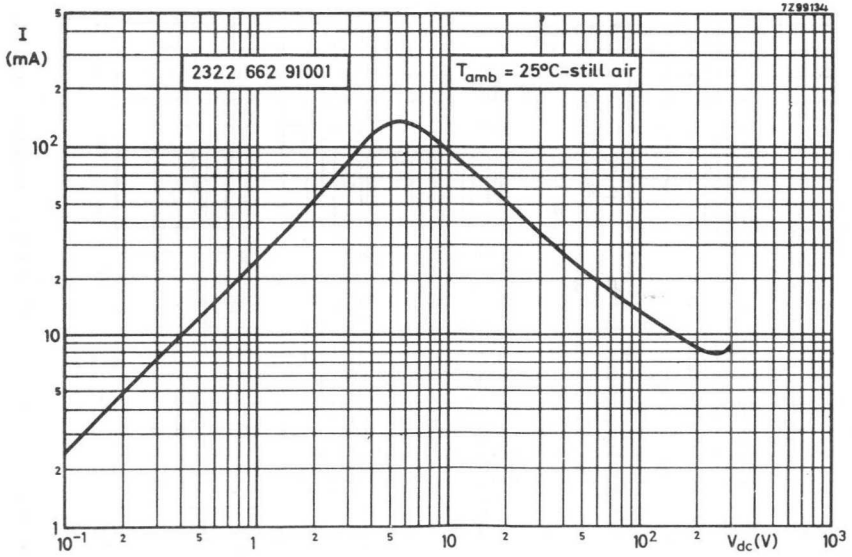

Fig.4. Typical voltage/current characteristic

TESTS AND REQUIREMENTS

According to I.E.C. publication 68, unless otherwise specified.

Tests	test method	duration	max. $\Delta R/R$ in %	
			at 25 °C	at 175 °C
Robustness of terminations	U			
Tensile strength 5 N	U _a	10 S	1)	
Bending 2.5 N	U _b	2 times	1)	
Soldering	T			
Solderability	par.3.2.3	3 to 4 S	2)	
Resistance to heat	par.3.2.4	3 to 4 S	<u>+ 2</u>	<u>+ 2</u>
Non-flammability	CCTU 01-01 A par. 22			

1) Leads should neither come loose nor break

2) Leads must be solderable initially and after six months storage with solder containing resin flux.

QUALITY LEVEL

Sampling and data evaluation for quality level in accordance with MIL-STD-105D

A.Q.L. 1 %, major defects - Electrical

A.Q.L. 1.5 %, major defects - Mechanical

A.Q.L. 4 %, minor defects - Physical

PACKAGING

50 pieces per box (cardboard)

1
2
3
4
5
6
7
8
9
10
11
12
13
14
15
16
17
18
19
20
21
22
23
24
25
26
27
28
29
30
31
32
33
34
35
36
37
38
39
40
41
42
43
44
45
46
47
48
49
50
51
52
53
54
55
56
57
58
59
60
61
62
63
64
65
66
67
68
69
70
71
72
73
74
75
76
77
78
79
80
81
82
83
84
85
86
87
88
89
90
91
92
93
94
95
96
97
98
99
100

PTC THERMISTOR

QUICK REFERENCE DATA

Resistance value at + 25 °C	45 to 60 Ω
Resistance value at + 150 °C $V_{\text{pulse}} = 340 \text{ V}$	>45 k Ω
Switch temperature	+ 75 °C approx
Temperature coefficient	+ 23 %/degC approx.
Max. voltage at $T_{\text{amb}} \leq 60 \text{ }^\circ\text{C}$	245 V_{rms}
Dissipation factor	17 mW/degC approx.
Operating temperature range at zero power at V_{max}	0 to + 155 °C 0 to + 60 °C



RZ 27317-11

APPLICATION

Intended primarily to be used in the degaussing circuit of colour television sets.

DESCRIPTION

This thermistor has a positive temperature coefficient. It consists of a disc provided with two solid tinned copper wires. The thermistor body is blue lacquered, but not insulated.

MECHANICAL DATA

Dimensions in mm

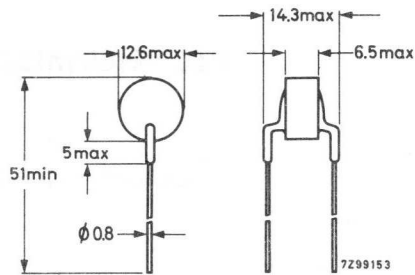

Fig. 1

Weight 4.5 g approximatelyMounting In any position by soldering. Soldering should be done at least 15 mm from the thermistor body.**ELECTRICAL DATA**

Resistance at + 25 °C	45 to 60 Ω ¹⁾
Resistance at + 75 °C	< 160 Ω ¹⁾
Resistance at + 150 °C, $V_{\text{pulse}} = 340$ V	> 45 k Ω ²⁾
Switch temperature	+ 75 °C approx.
Temperature coefficient	+23 %/deg C approx.
Dissipation factor	17 mW/deg C approx. ³⁾
Heat capacity	2.3 J/deg C approx. ³⁾
Thermal time constant	130 s approx. ³⁾
Operating temperature range	
at zero power	0 to +155 °C
at V_{max}	0 to + 60 °C
Voltage dependence β at + 150 °C	0,30 approx.
Balance voltage at + 150 °C	175 V_{dc} approx.
Maximum voltage (V_{max}) at + 60 °C	245 V_{rms}

1) Measuring voltage not exceeding 1.5 V_{dc} to avoid internal heating.

2) Measurement made without internal heating occurring.

3) Measurement made with specimen in phosphor bronze clips, in still air.

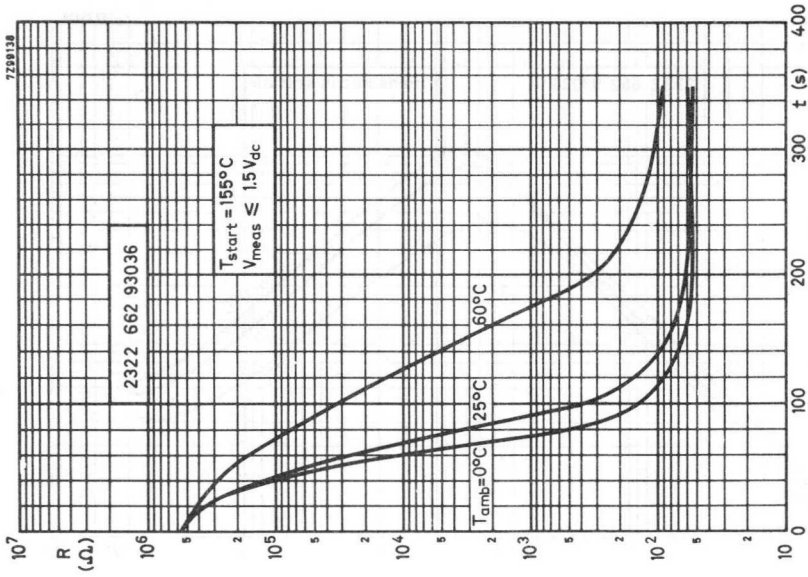

Fig. 3.

Typical resistance/time (cooling) characteristics

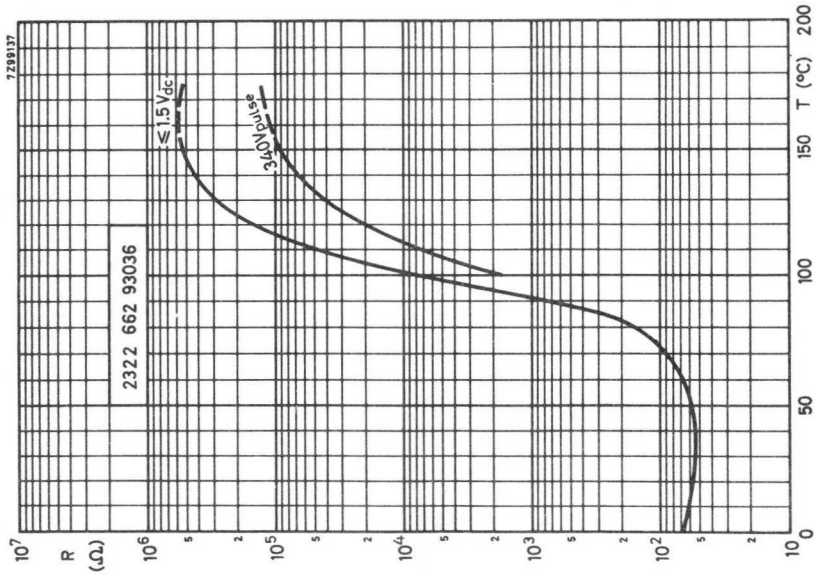

Fig. 2.

Typical resistance/temperature characteristics
(no internal heating)

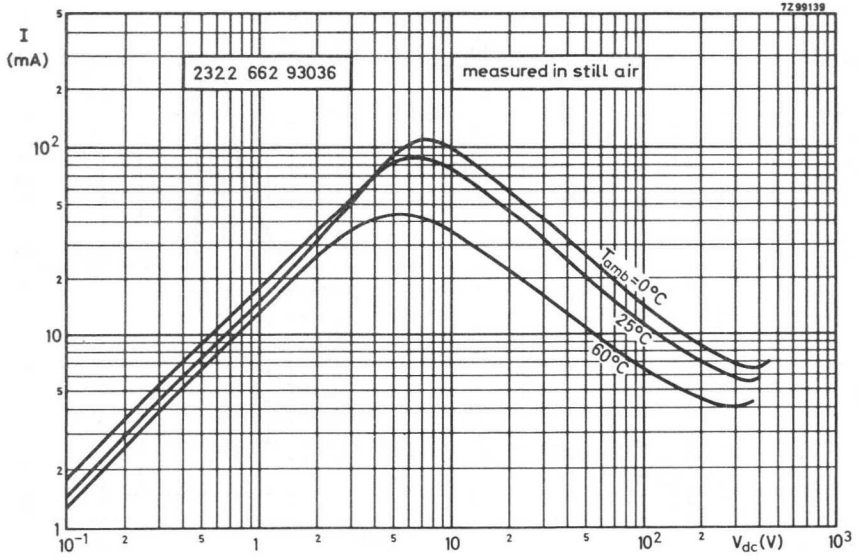

Fig. 4. Typical voltage/current characteristics

TESTS AND REQUIREMENTS

According to I.E.C. 68

test	test method	duration	$\Delta R/R$ in %	
			at 25 °C	at 150 °C
Robustness of terminations	U			
Tensile strength 20 N	Ua	10 s	1)	
Bending 10 N	Ub	2 times	1)	
Soldering	T			
Solderability at 230 °C	par. 3.2.3	3 to 4 s	2)	
Resistance to heat at 230 °C	par. 3.2.4	3 to 4 s	± 2	± 2

1) Leads should neither come loose nor break.

2) Leads must be solderable initially and after six months storage with solder containing resin flux.

QUALITY LEVEL

Sampling and data evaluation for quality level in accordance with MIL-STD-105D

A.Q.L. 1 %, critical defects - Electrical

A.Q.L. 1.5 %, major defects - Mechanical

A.Q.L. 4 %, minor defects - Physical

10/10/10
10/10/10
10/10/10
10/10/10
10/10/10

PTC THERMISTOR

QUICK REFERENCE DATA

Resistance value at +25 °C	100 Ω \pm 20%
Resistance value at +150 °C $V_{\text{pulse}} = 340 \text{ V}$	> 40 k Ω
Switch temperature	80 °C
Max. voltage at $T_{\text{amb}} \leq +60 \text{ °C}$	245 V_{rms}
Dissipation factor	15 mW/deg C approx.
Operating temperature range at zero power	0 to 150 °C
at V_{max}	0 to +60 °C



RZ 27317-11

APPLICATION

Intended primarily to be used in the degaussing circuit of colour television sets.

DESCRIPTION

This thermistor has a positive temperature coefficient. It consists of a disc provided with two solid tinned brass wires. The thermistor body is blue lacquered, but not insulated.

MECHANICAL DATADimensions in mm

Fig.1

Marking

The thermistor is marked with a red dot.

Weight 2 g approximately

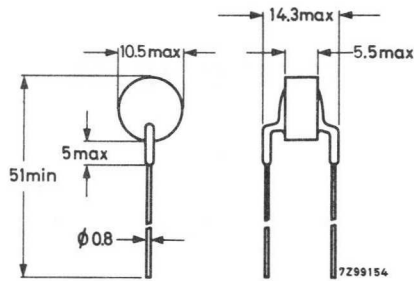
Mounting In any position by soldering. Soldering should be done at least 15 mm from the thermistor body.

ELECTRICAL DATA

Resistance at +25 °C (T_{ref})	$100 \Omega \pm 20\%$ 1)
Resistance at +72 °C	$< 2 \times R_{25}$ 1)
Resistance at +85 °C	$> 2 \times R_{25}$ 1)
Resistance at +150 °C, $V_{pulse} = 340 V$	$> 40 k\Omega$ 2)
Switch temperature	80 °C approx.
Dissipation factor	15 mW/deg C approx. 3)
Operating temperature range	
at zero power	0 to 150 °C
at V_{max}	0 to 60 °C
Maximum voltage (V_{max}) at 60 °C	245 V_{rms}

1) Measuring voltage not exceeding 1.5 V_{dc} to avoid internal heating.

2) Measurement made without internal heating occurring.

3) Measurement made with specimen in phosphor bronze clips, in still air.

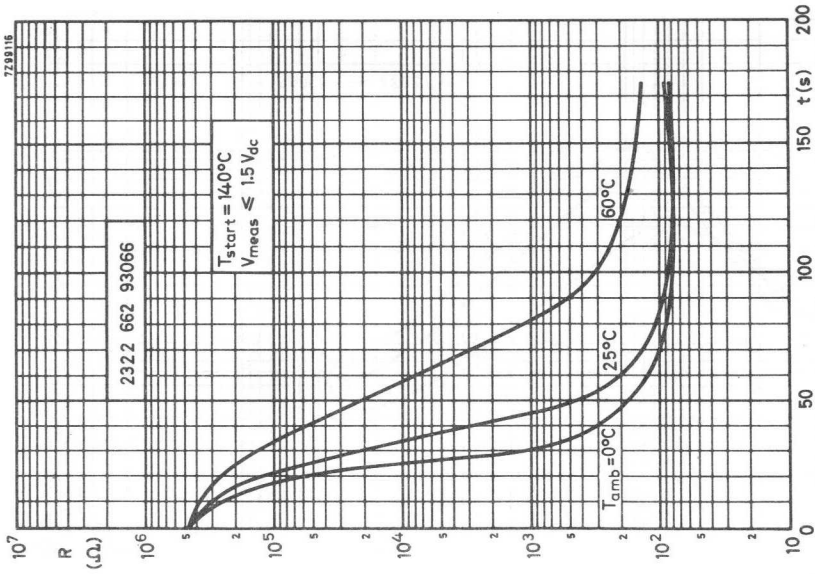

Fig. 3.

Typical resistance/time (cooling) characteristics

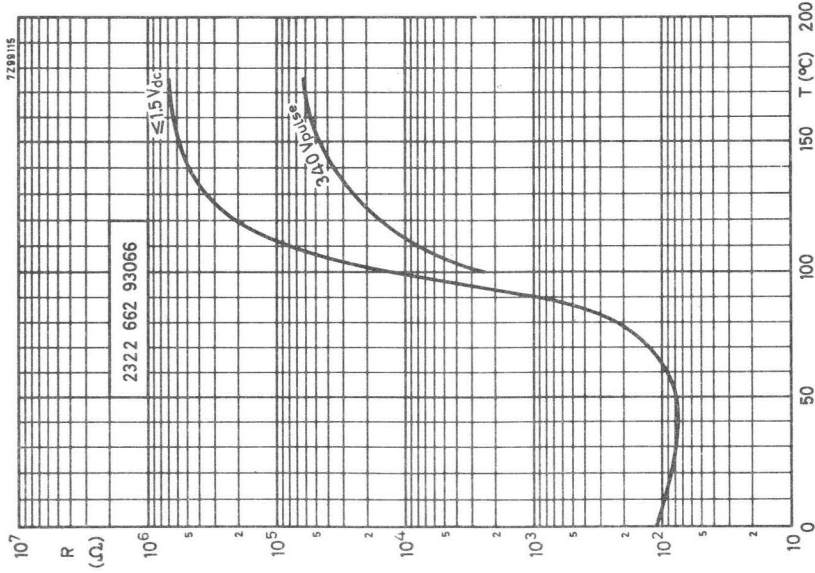

Fig. 2.

Typical resistance/temperature characteristics

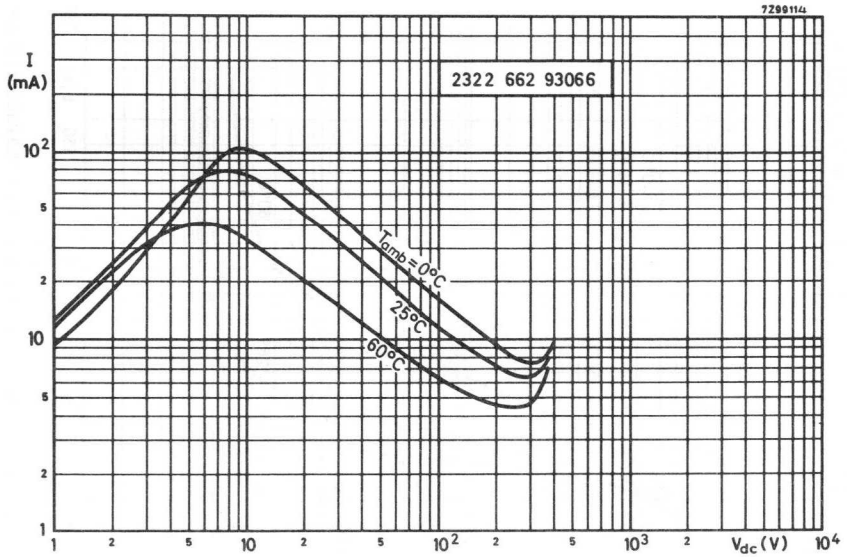

Fig.4. Typical voltage/current characteristics

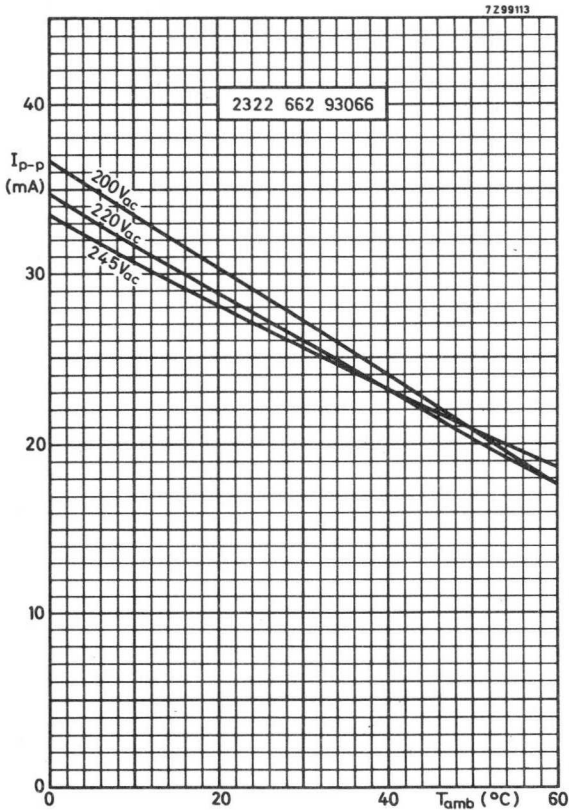

Fig. 5. Typical characteristics of peak to peak current against the ambient temperature at different voltages.

QUALITY LEVEL

Sampling and data evaluation for quality level in accordance with MIL-STD-105D.

- A.Q.L. 1 % , critical defects - Electrical
- A.Q.L. 1.5 % , major defects - Mechanical
- A.Q.L. 4 % , minor defects - Physical

PACKAGING 100 pieces per box (cardboard)

1875

PTC THERMISTORS for motor protection

QUICK REFERENCE DATA

Resistance value at -20 and $T_{ref} -20$ °C	30 to 250 Ω
Resistance value at $T_{ref} + 15$ °C $V_{pulse} = 7.5$ V	> 4000 Ω
Switch temperature	see table
Temperature coefficient	see table
Max. voltage	15 V_{dc}
Dissipation factor	7 mW/deg C approx.
Operating temperature range at zero power	-20 to $T_{ref} + 30$ °C
at V_{max}	-20 to $T_{ref} + 15$ °C

DIMENSIONS in mm

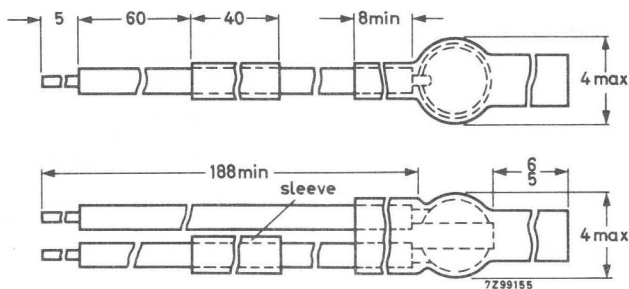

APPLICATION

These thermistors have been designed for use in transistorized circuits for the protection of electric motors against overheating. They are to be built into the windings of the stator (one PTC thermistor per phase).

DESCRIPTION

This type has a positive temperature coefficient. It consists of a disc provided with two tinned copper "Litze" wires with a cross-section not greater than 7/.0076 inch (0.194 mm) and insulated with PTFE material complying with the requirements of the ministry of aviation specification EL 1930.

2322 672 92046
to
2322 672 92053

PTC THERMISTORS
for motor protection

MECHANICAL DATA

See outline drawing on previous page.

Marking The last five figures of the catalogue number are printed on the sleeve, e.g. PTC 92046

Weight 1.6 g approximately

Mounting In motor windings; connections to be soldered or clamped.

→ **ELECTRICAL DATA**

Table

$T_{ref}^1)$ (°C)	T_s (°C)	temperature coefficient (%/deg C)	voltage dependence β	balance voltage (V _{dc})	catalogue number
90	75	21	0.40	27	2322 672 92046
100	88	31	0.36	6.5	92047
110	99	33	0.35	17	92048
120	113	38	0.36	11	92049
130	113	27	0.38	34	92051
140	130	33	0.34	13	92052
150	137	33	0.35	20	92053

Resistance between -20 and $T_{ref} -20$ °C 30 to 250 Ω ²⁾

Resistance at $T_{ref} -5$ °C < 550 Ω ²⁾

Resistance at $T_{ref} +5$ °C > 1330 Ω

Resistance at $T_{ref} +15$ °C, $V_{pulse} = 7.5$ V > 4000 Ω ³⁾

Dissipation factor 7 mW/deg C approx. ⁴⁾

Heat capacity 0.1 J/deg C approx. ⁴⁾

Thermal time constant 14 s approx. ⁴⁾

Response time ⁵⁾ ≤ 8 s

Operating temperature range
at zero power -20 to $+T_{ref} +30$ °C
at V_{max} -20 to $+T_{ref} +15$ °C

Maximum voltage 15 V_{dc}

Dielectric withstanding voltage
between terminals and lead insulation > 2500 V_{rms}

Insulation resistance between
terminals and lead insulation > 1 M Ω

- 1) T_{ref} is the temperature at which the thermistor has to make the protective system operative.
- 2) Measuring voltage not exceeding $1.5 V_{DC}$ to avoid internal heating.
- 3) Measurements made without internal heating occurring.
- 4) Measurements made with specimen in phosphor-bronze clips, in still air.
- 5) Response time is the time in which the thermistor-body temperature rises to 63.2% of the difference between initial and final body temperature, when the thermistor is subjected to a step function change in ambient temperature.
Initial temperature: $25^{\circ}C$ (air)
Final temperature : $T_{ref} + 15^{\circ}C$ (silicon oil MS 200/50)

Typical resistance/temperature characteristics of the different types

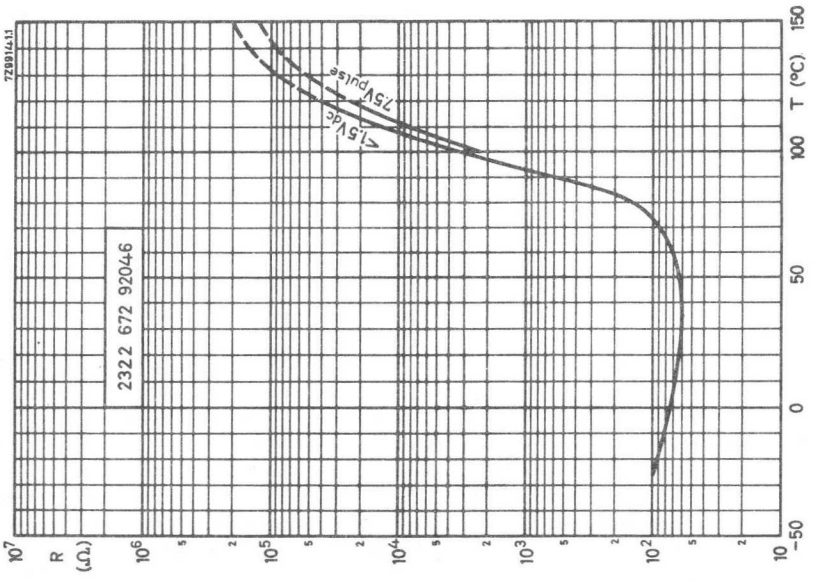

Fig. 2

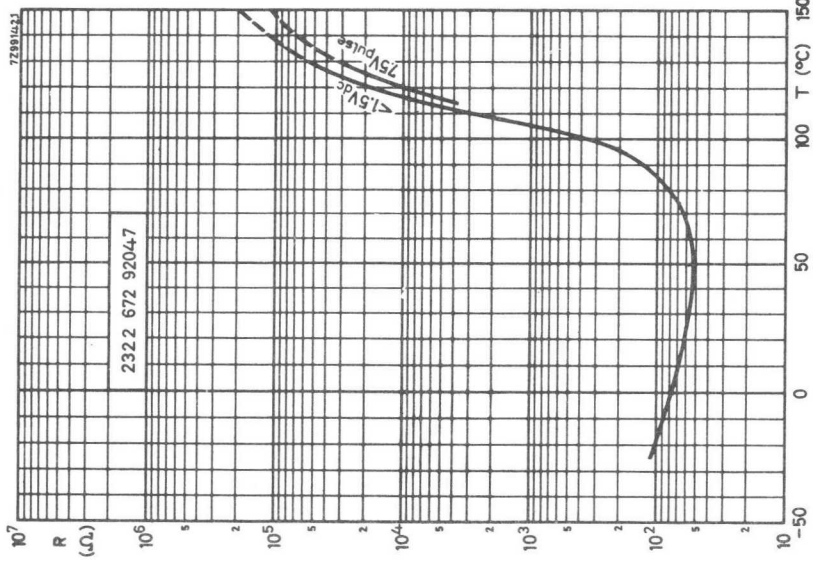

Fig. 3

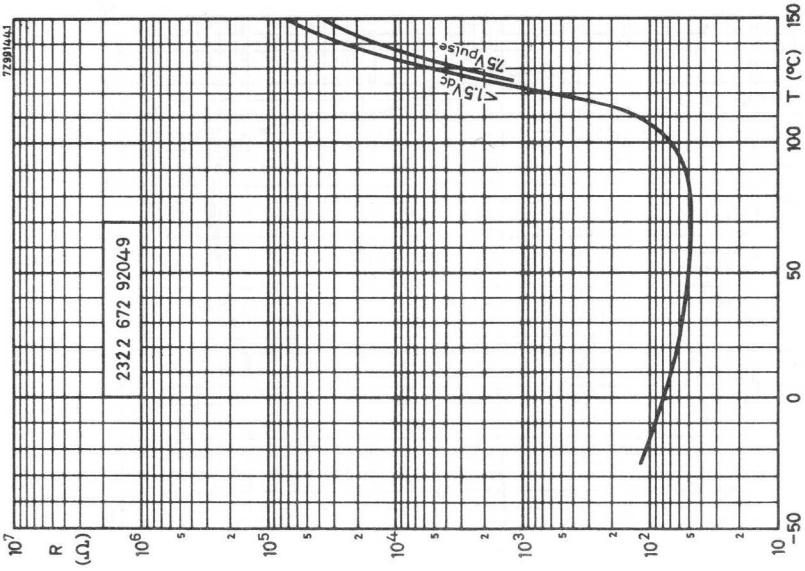

Fig. 5

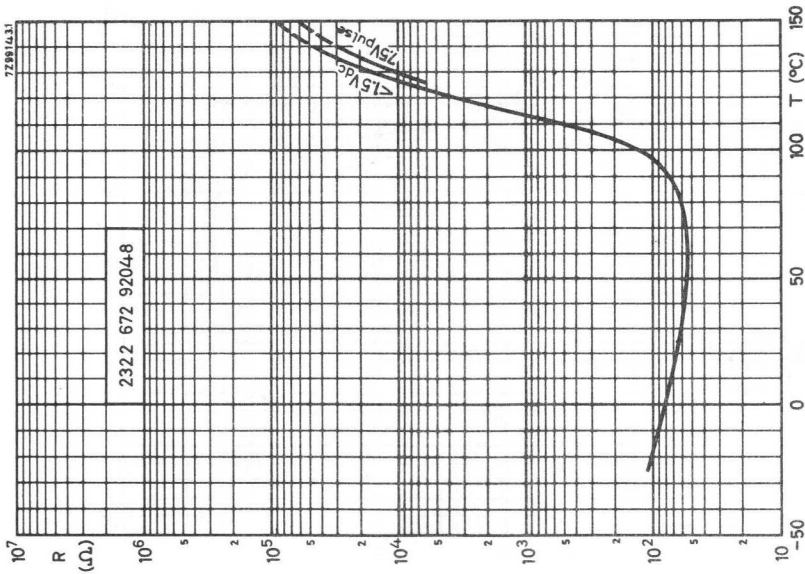

Fig. 4

2322 672 92046

to

2322 672 92053

PTC THERMISTORS
for motor protection

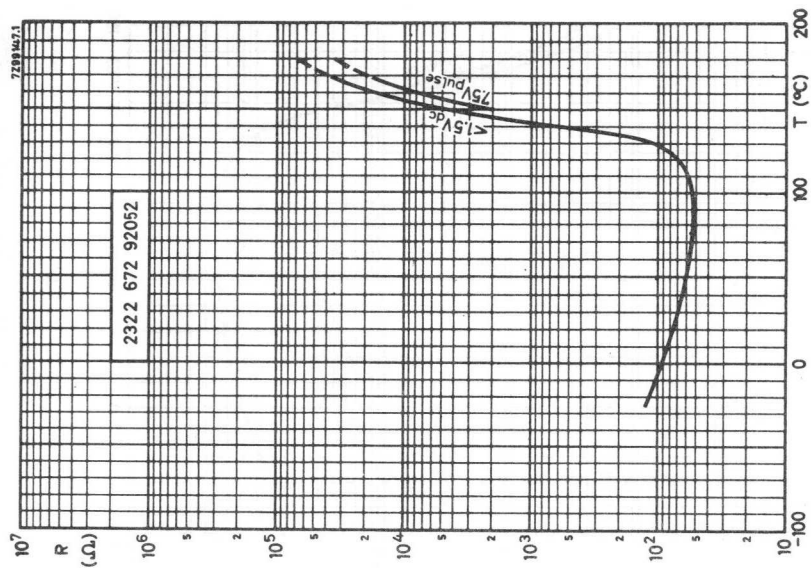

Fig. 7

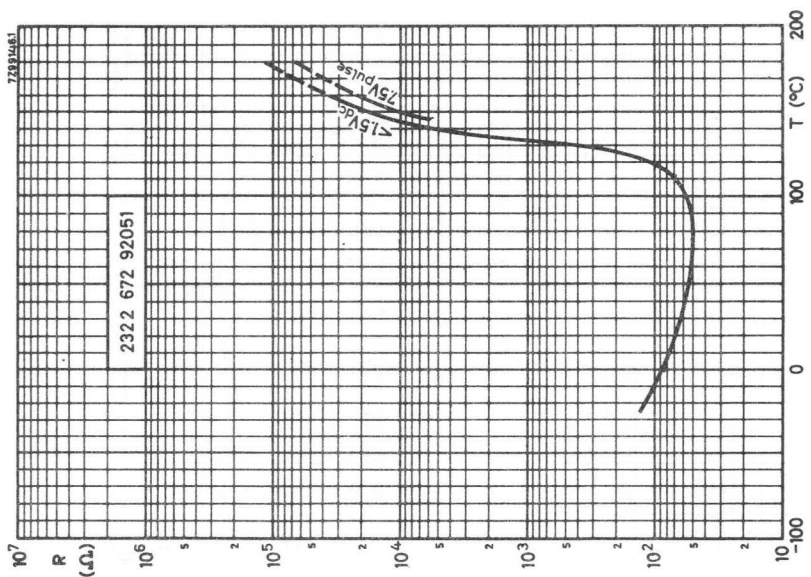

Fig. 6

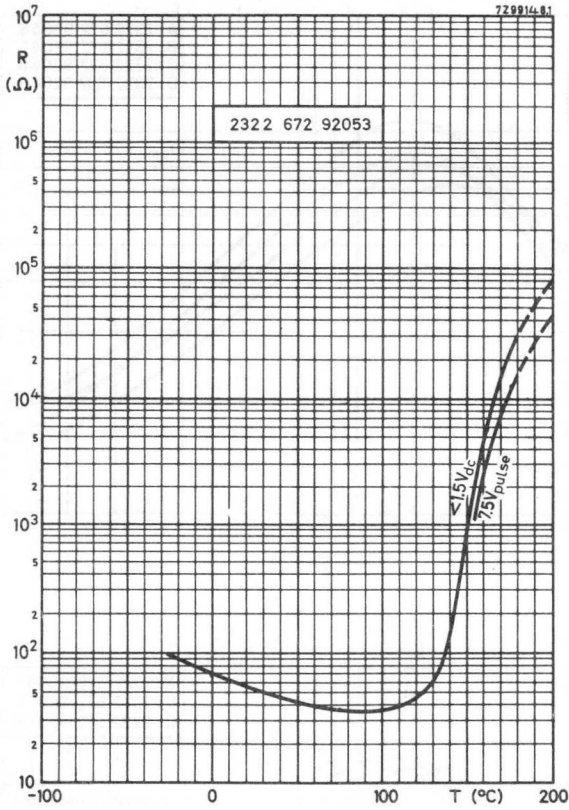

Fig. 8

Typical voltage/current characteristics

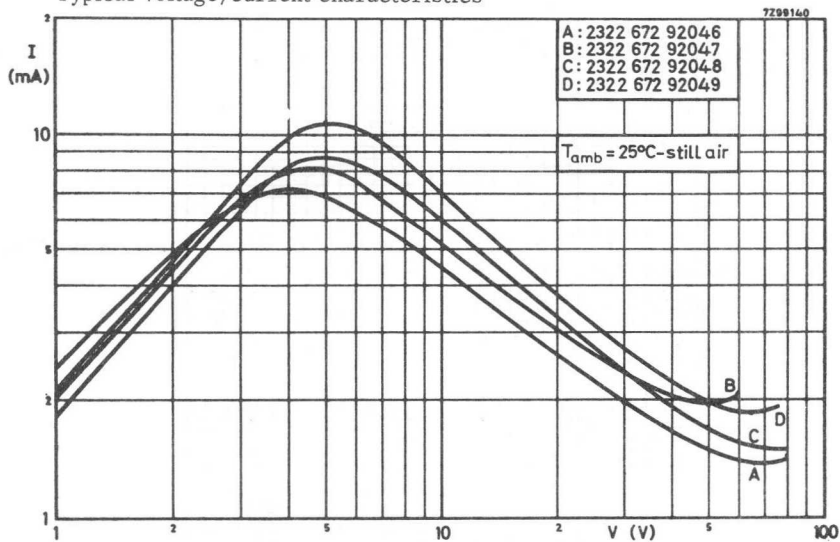

Fig. 9

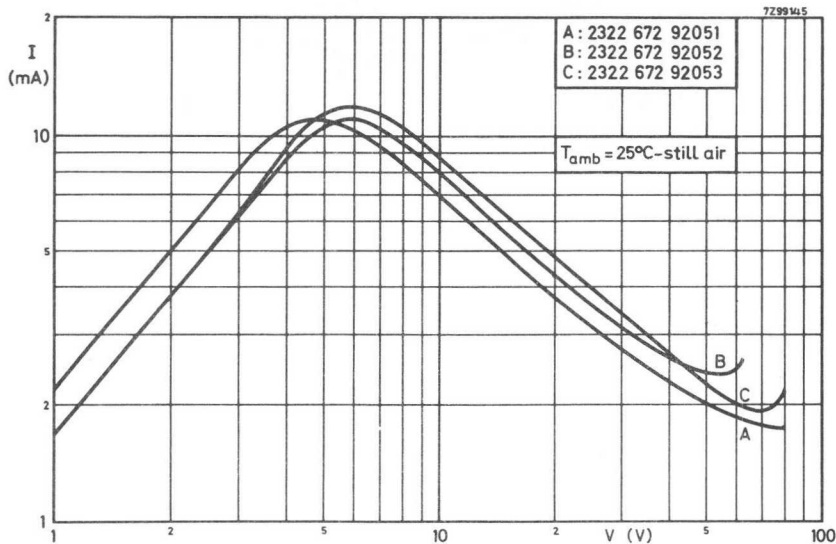

Fig. 10

TESTS AND REQUIREMENTS

According to I. E. C. 68, unless otherwise specified.

Test	test method	duration	$\Delta R/R$ in %	
			at 25 °C	at $T_{ref} + 30$ °C
Cold at -25 °C	A	1000 h	± 5	± 5
Storage at +25 °C	H	1000 h	± 5	± 5
Dry heat at $T_{ref} + 25$ °C	B	1000 h	± 10	± 10
Dry heat at 200 °C	-	2 cycles ³⁾	± 10	± 10
Thermal shock -25 to $T_{ref} + 30$ °C	Na	5 cycles	± 10	± 10
Max. peak temperature $T_{ref} + 90$ °C	-	6 cycles ⁴⁾	± 20	± 20
Damp heat	C	1000 h	± 5	± 5
Dissipation at $V = 15 V_{rms}$ and $T_{amb} = +25$ °C		1000 h	± 5	± 5
Robustness of terminations	U			
Tensile strength 10 N	Ua	10 s	1)	
Bending 5 N	Ub	2 times	1)	
Soldering	T			
Solderability at 230 °C	par. 3.2.3	3 to 4 s	2)	
Resistance to heat at 230 °C	par. 3.2.4	3 to 4 s	± 2	± 2

1) Leads should neither come loose nor break.

2) Leads must be solderable initially and after 6 months storage with solder containing resin flux.

3) One cycle = 16 h at +200 °C, 1 h at +25 °C.

4) One cycle = 1 h at $T_{ref} + 90$ °C, 168 h at T_{ref} , in silicon oil free of oxidation.

QUALITY LEVEL

Sampling and data evaluation for quality level in accordance with MIL-STD-105D.

A.Q.L. 1 %, major defects - Electrical

A.Q.L. 1.5 %, major defects - Mechanical

A.Q.L. 4 %, minor defects - Physical.

VOLTAGE-DEPENDENT RESISTORS



100
100
100
100
100

INTRODUCTION

V(oltage) D(ependent) R(esistors), which are made of silicon carbide show a high degree of non-linearity between their resistance value and the applied voltage. The voltage dependency is caused by the contact resistance between the carbide crystals. The electrical characteristic of the pressed conglomeration is determined by a large number of crystal contacts which form a complicated network of series and parallel resistors. Simple stabilization circuits may be realized with the help of these resistors and they have found a diversity of applications in television and industrial circuits. Used as spark suppressors they offer a cheap and reliable solution for protection of relay contacts.

MANUFACTURING PROCESS

Silicon carbide grains with the right electrical and dimensional properties are pressed together with a ceramic binder to the shape of discs or rods. The method of forming the VDR's is one of those usually employed in the ceramic industry.

After a drying period the VDR's are sintered at a high temperature. Firing time and temperature have an important influence on the electrical characteristics. The terminals are metallized with zinc or copper for making good electrical contact. After leads have been soldered to the contacts the VDR's are lacquered and impregnated. Some types, made for clamp contacts or other mounting methods, are delivered unlacquered and without leads.

During and after the manufacturing process the electrical properties are controlled not only to ensure that the VDR's are within the specification but also to control stability and reliability of the resistors.

ELECTRICAL PROPERTIES

DIRECT CURRENT

The relation between voltage and current of a VDR resistor can be approximated by:

$$V = C \cdot I^\beta \quad (1)$$

where V is the voltage in volts, I the current in amperes and C and β are constants. This equation is illustrated in Fig.1. In principle the same characteristic is plotted for a specific type on a double logarithmic scale in Fig.2.

For not too small values of current this relation is a straight line which follows directly from the equation $\log V = \log C + \beta \log I$. In this case β is the directional coefficient of the straight line.

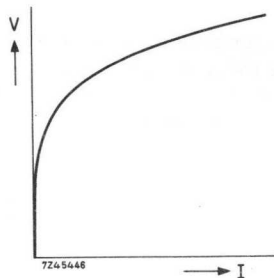

Fig.1.
Shape of the voltage/current characteristic of a VDR when plotted on a linear scale.

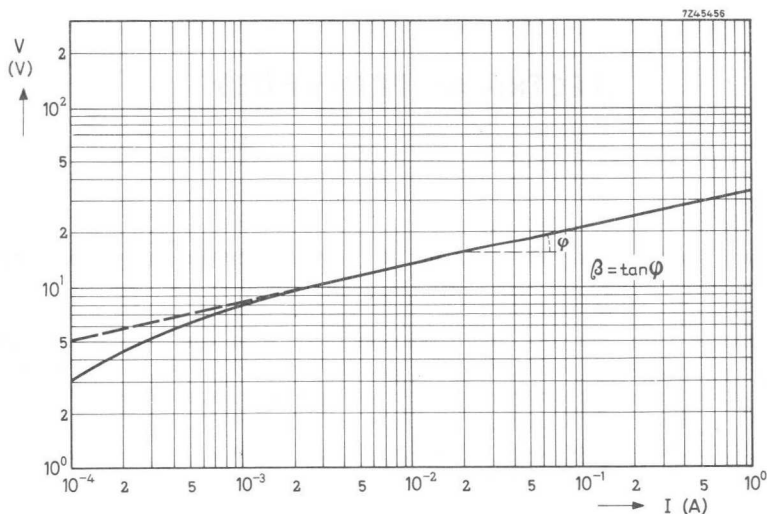

Fig. 2. Voltage/current characteristic of a VDR plotted on a logarithmic scale.

In order to determine the exact values of the constants C and β it is necessary to measure three points of the characteristic. Only when these are on a straight line when plotted on a double logarithmic scale, extrapolation (only to higher values) is permitted. Equation (1) may also be written:

$$I = kV^\alpha, \quad (2)$$

in which:

$$\alpha = 1/\beta \quad (3a)$$

and

$$K = \frac{1}{C^{1/\beta}} = \frac{1}{C^\alpha} \quad (3b)$$

The VDR do not have a polar effect; this means that when the voltage is changed from positive to negative, the current changes its direction, but retains its value. Strictly speaking the eqs (1) and (2) are valid only when the absolute values are taken for I and V . In a.c. calculations this may be very important.

To avoid cumbersome calculations with broken exponents eq. (1) is elaborated into a nomogram, Fig. 3, which gives by a simple construction the corresponding values of voltage and current for any given VDR.

When a straight line is drawn between the point for $I = I_1$ mA on the first scale and the point for V_1 volts on the third scale, then the elongated line will intersect the β -line in question at a certain point. All straight lines starting from this point will intersect the scales for voltage and current at points which give values of I and V that belong together. E.g. for a VDR measuring 10 mA at 100 V and having a β of 0.20 it can easily be found that at 70 V the current will be 1.6 mA. The dissipated energy can be found on the second scale. In our example this is 0.11 W.

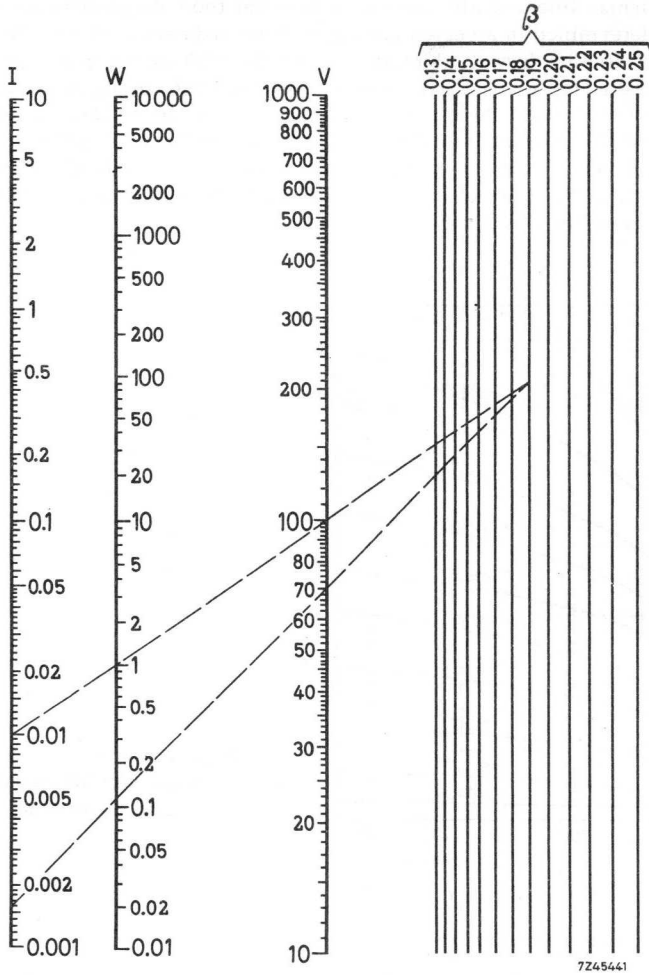

Fig.3.

Nomogram giving the relation between voltage, current, power dissipation and β -value of any VDR.

Although the nomogram will be used in most cases, it is sometimes convenient to use a normal linear scale, for example when the voltage drop across a VDR has to be determined in a series circuit with an ordinary resistor. In that case a resistance line is drawn, which intersects the VDR-curve in a point which by its ordinate directly gives the voltage across the VDR. In Fig.4 the characteristics of several standard types are drawn on a linear scale, this figure has been derived from the published voltage current relation on a double logarithmic scale. The broken lines correspond to the example shown in the insert. For a VDR 2322 552 03401 the voltage drop will be 90 V, whilst for a VDR 2322 552 02381 a drop of 140 V is found.

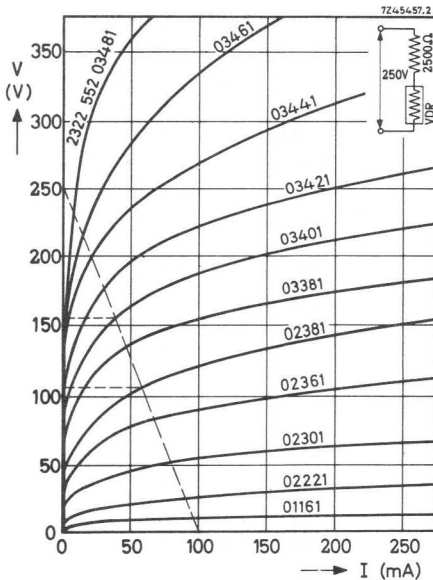

Fig.4.
Voltage/current characteristics
plotted on a linear scale.

Practical values and specification

The C - and β -values of a VDR depend on the composition of the material and on the method used in the processing; the C -value depends furthermore on the shape and the dimensions of the VDR. Practical β -values range between 0.15 and 0.35. It is inherent to the material properties that the β -value of VDR with a low C -value will always be higher than that of a VDR with a high C -value. Practical C -values range from 14 to a few thousand. As the method of fabrication compels a minimum thickness and, as will be seen further, enlarging of the surface area gives little change in the C -value, the latter has for practical reasons a limited lowest value.

According to formula (1) it is possible to specify the electrical characteristics of a VDR resistor by giving its C - and β -values. The advantage of this specification is that only two parameters are used. The disadvantage is, however, that due to the inevitable tolerances on the β -values, the spread in voltages at low currents (in the working area) becomes very large. It is for this reason that the method of specifying by the C -value defined at 1 A is abandoned and we now specify the voltage across the VDR at currents which lie in the working area (1, 10 or 100 mA instead of 1 A). In this way it is possible to supply VDR's which have much closer tolerances in the area where they are used, see Fig. 14. In theoretical calculations it is much easier, however to use the C -value. Therefore the formula $V = CI^\beta$ is used. When a calculation leads to a certain C -value, the voltage at currents of 1, 10 or 100 mA can be found with the aid of the nomogram (Fig. 3).

VDR in series

For every VDR we can write the equation:

$$V = CI^\beta \quad (1)$$

When n equal elements are connected in series and a voltage of n times the original voltage is applied, the current will be the same as for V volts over one VDR. Consequently we may write for a series circuit of n VDR:

$$nV = C' \cdot I^\beta \quad (4)$$

From eqs (1) and (4) it is evident that,

$$C' = nC, \quad (5)$$

which means that the C -value of a VDR can be increased ad libitum by series connection.

VDR in parallel

For one VDR again we have:

$$V = CI^\beta \quad (1)$$

Now when n of these VDR's are connected in parallel and the same voltage V is applied, the current in each VDR will still be the same. The total current in the circuit will be nI . This gives the following equation:

$$V = C''(nI)^\beta \quad (6)$$

From eqs (1) and (6) it follows:

$$C'' = \frac{C}{n^\beta} \quad (7)$$

As VDR's have a β -value from 0.15 - 0.35, it is clear that the C-value will decrease very little by connecting two or more elements in parallel. When e.g. $\beta = 0.20$, 32 VDR's are needed for a 50 % reduction of the C-value. It is important that in parallel circuits all VDR's have about the same β - and C-values. Otherwise the current division will very much depend on the voltage across the circuit.

Note: On no occasion may a VDR be connected in parallel with the aim of obtaining higher power dissipation.

Resistance value

When defining R as usual as the quotient of voltage and current, we find:

$$R = \frac{V}{I} = \frac{CI\beta}{I} = \frac{C}{I^{1-\beta}} \quad (8)$$

or when starting from the form $I = KV^\alpha$:

$$R = \frac{V}{I} = \frac{V}{KV^\alpha} = \frac{1}{K \cdot V^{\alpha-1}} \quad (9)$$

From these equations it is once more evident that the resistance value is not a constant one, but is very much dependent on the values of voltage and current.

Dissipated power

The power dissipated in a VDR is equal to the product of voltage and current, so it may be written:

$$W = I \cdot V = K \cdot V^{\alpha+1} \quad (10)$$

When the coefficient $\alpha = 5$, the power dissipated by the VDR is proportional to the 6th power of the voltage. A voltage increase of only 12 % will in this case double the dissipated power. Consequently it is very important that the applied voltage does not rise above a certain maximum value, as otherwise the permissible rating will be exceeded.

This is even more cogent, as the VDR have a negative temperature coefficient, which means that at higher dissipation (and accordingly higher temperature) the resistance value will decrease and the dissipated power will increase still more.

Temperature coefficient

In the foregoing formulas no temperature effects have been taken into account. These, however, may not always be neglected, as the C-value has an appreciable negative temperature coefficient. The β -value is practically independent from the temperature. With good approximation it may be written:

$$C_t = C_0 (1 + at), \quad (11)$$

in which:

C_t = C-value of the VDR at t °C

C_0 = C-value of the VDR at 0 °C

α = temperature coefficient.

For different materials the value of α lies between -0.0010 and -0.0018 . So for circuits where the current is constant the temperature coefficient on voltage lies between -0.10 and -0.18 % per degree C.

For circuits where the voltage is constant the temperature coefficient on current lies between $+0.4$ and $+0.8$ % per degree C, depending on the β -value.

ALTERNATING CURRENT

If a sinusoidal voltage is applied to a VDR, the non-linear voltage current characteristic will cause the current to be non-sinusoidal, but the latter will for reasons of symmetry include only odd harmonics. Fig.5 shows an oscillogram of this phenomenon. If a VDR is carrying a sinusoidal current, the voltage across the VDR will be non-sinusoidal.

Sinusoidal voltage

R.M.S. value of the current

This value is defined by

$$I_{\text{rms}} = \sqrt{\frac{1}{T} \int_0^T I^2 dt.}$$

As the momentary relation between voltage and current is given by $I = K \cdot V^\alpha$ and $V = v \sin \omega t$ in which $v = V_{\text{rms}} \sqrt{2}$, it is found:

$$I_{\text{rms}} = K \cdot V_{\text{rms}}^\alpha \cdot 2^{\alpha/2} \sqrt{\frac{2}{T} \int_0^{T/2} (\sin \omega t)^{2\alpha} dt.}$$

A d.c. voltage of $V = V_{\text{rms}}$ would cause a current in the VDR equal to:

$$I = K \cdot V_{\text{rms}}^\alpha.$$

The relation $r = I_{\text{rms}}/I$ between these two current values is given by:

$$r = 2^{\alpha/2} \sqrt{\frac{2}{T} \int_0^{T/2} (\sin \omega t)^{2\alpha} dt.} \quad (12)$$

This factor r has been calculated and is plotted as a function of α in Fig. 6.

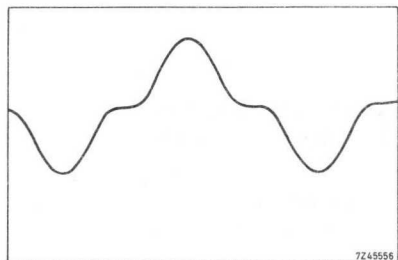
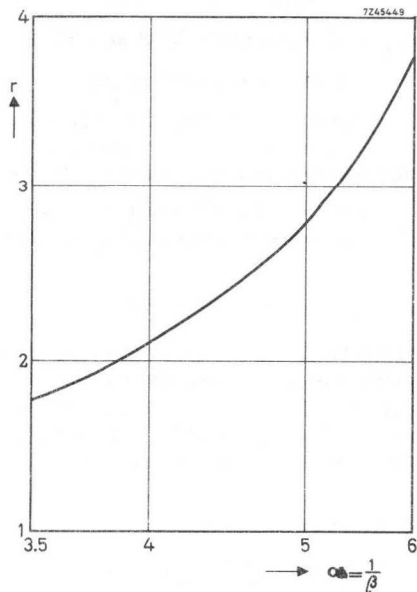

Fig. 5.
Current as a function of time, when a sinusoidal voltage is applied to a VDR.

Fig. 6.
Relation between the currents caused by a d.c. voltage V and an a.c. voltage $V_{rms} = V$.

$$r = I_{rms}/I$$



Mean value of the current in a VDR during half a cycle

This value is defined by:

$$I_m = \frac{2}{T} \int_0^{T/2} I dt.$$

Making the same assumption as for the I_{rms} -calculation it is found:

$$I_m = \frac{2 K \cdot V_{rms}^\alpha \cdot 2^{\alpha/2}}{T} \int_0^{T/2} (\sin \omega t)^\alpha dt.$$

Again a d.c. voltage of $V = V_{rms}$ would cause a current of

$$I = K \cdot V_{rms}^\alpha$$

The relation $m = I_m/I$ between these two currents is:

$$m = \frac{2^{(\alpha+2)/2}}{T} \int_0^{T/2} (\sin \omega t)^\alpha dt. \quad (13)$$

The factor m has been calculated for different α values and is plotted in Fig. 7.

When measuring the alternating current in a VDR erroneous readings will be obtained if a moving-coil instrument, operating with rectifiers, is used. Normally these instruments are calibrated in r.m.s. values and are correct only for sinusoidal alternating voltages or currents. Actually they indicate the mean values of these magnitudes. When a current according to Fig.5 has to be measured with an assembly of this kind, the deflection of the instrument will be proportional to the mean value of the current. For obtaining the r.m.s. value the reading must be multiplied by a factor f which is given in Fig.8 as a function of \underline{a} .

Dissipated power with sinusoidal alternating voltage

Again the assumptions made in the foregoing paragraphs are used and it is found:

$$W_{ac} = \frac{2}{T} \int_0^{T/2} K \cdot V^{\alpha+1} (\sin \omega t)^{\alpha+1} dt =$$

$$\frac{2 K \cdot V_{rms}^{\alpha+1} \cdot 2^{(\alpha+1)/2}}{T} \int_0^{T/2} (\sin \omega t)^{\alpha+1} dt.$$

The power for a d.c. voltage of $V = V_{rms}$ is $W = KV_{rms}^{\alpha+1}$. The quotient of these power values is:

$$p = \frac{W_{ac}}{W} = \frac{2^{(\alpha+3)/2}}{T} \int_0^{T/2} (\sin \omega t)^{\alpha+1} dt. \quad (14)$$

The value of p has been plotted in Fig.9 as a function of \underline{a} .

Sinusoidal current

R.M.S. value of the voltage

When a sinusoidal current flows in the VDR the r.m.s.-value of the voltage across it may be expressed as follows:

$$V_{rms} = C I_{rms}^{\beta} \cdot 2^{\beta/2} \sqrt{\frac{T}{2} \int_0^{T/2} (\sin \omega t)^{2\beta} dt}.$$

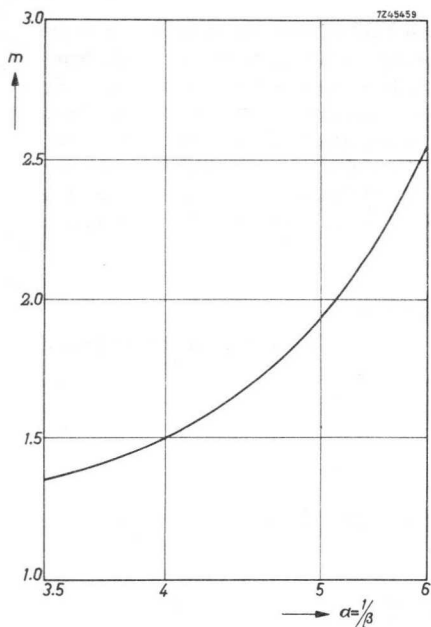

Fig. 7.
Relation between the mean values of the currents caused by a d.c. voltage V and an a.c. voltage $V_{rms} = V$.
 $m = I_m/I$

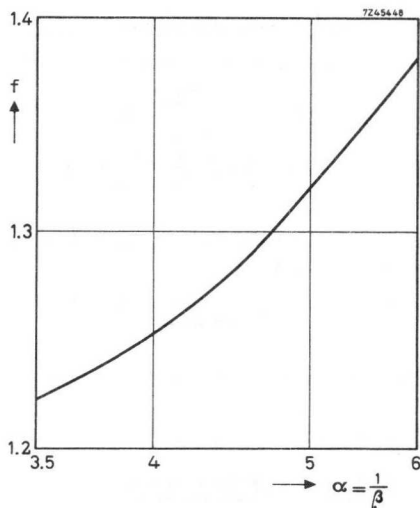

Fig. 8.
Error in the reading of I_{rms} on a moving coil ammeter with rectifiers.

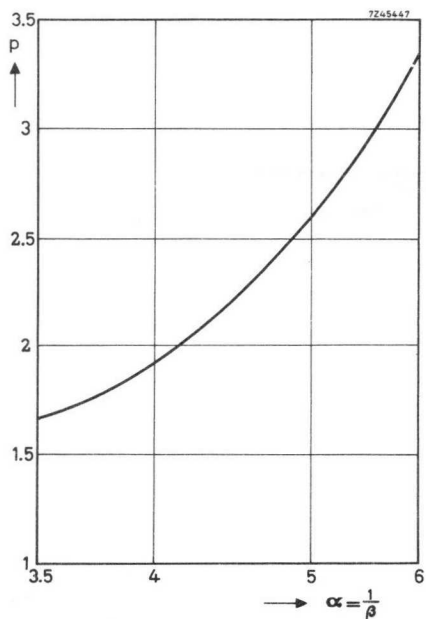

Fig. 9.
Relation between the power dissipations caused by a d.c. voltage V and an a.c. voltage $V_{rms} = V$. The dissipation caused by the a.c. voltage is p times that caused by the d.c. voltage.

The d.c. voltage drop in a VDR when this carries a direct current $I = I_{\text{rms}}$, is:

$$V = C I_{\text{rms}}^{\beta}$$

The relation $n = V_{\text{rms}}/V$ between these voltages has been calculated:

$$n = \frac{V_{\text{rms}}}{V} = 2^{\beta/2} \sqrt{\frac{2}{T} \int_0^{T/2} (\sin \omega t)^{2\beta} dt}. \quad (15)$$

This value is plotted in Fig.10 as a function of β .

Dissipated power

For a sinusoidal current the dissipated power can be calculated as:

$$W_{\text{ac}} = C I_{\text{rms}}^{\beta+1} 2^{(\beta+1)/2} \frac{2}{T} \int_0^{T/2} (\sin \omega t)^{\beta+1} dt.$$

For a direct current $I = I_{\text{rms}}$ the dissipated power is:

$$W = C I_{\text{rms}}^{\beta+1}$$

The relation $I = W_{\text{ac}}/W$ has been calculated:

$$I = \frac{W_{\text{ac}}}{W} = 2^{(\beta+1)/2} \frac{2}{T} \int_0^{T/2} (\sin \omega t)^{\beta+1} dt. \quad (16)$$

In Fig.11 this value is plotted as a function of β . From this graph it is clear that variations in β value have but little influence on the dissipated power, provided the current and the peak voltage are constant.

In practical use neither a sinusoidal voltage nor a sinusoidal current will generally occur. The first will only be the case if an inductance is shunted with a VDR for spark suppression. For those applications it is often required to know the power used by the VDR. The graph of Fig.9 helps in answering this question. If an ordinary linear resistance is connected in series with a VDR the shape of the current oscillogram will gradually deviate from that of Fig.5. If the linear resistance value is very large compared to the resistance value of the VDR the current will take a sinusoidal form.

Higher harmonics of the alternating current in a VDR

The curve as shown in Fig.5 can be developed into a Fourier series. In that way the ratio of strength between the first, the third, and the fifth harmonic can be found. Harmonics of the seventh or higher order are very small and of no practical importance, Fig.12 shows the relative strength of these harmonics including the fifth, as a function of $\alpha = 1/\beta$.

High frequency alternating current

For low frequencies the small capacitance of the VDR does not affect the voltage dependency of the resistance. For high frequencies, however, this parallel capacitance may not be neglected. For low voltages and currents they may even determine the impedance of the VDR. At high voltages, the influence of the capacitance is less serious; because in that case the resistance over which this

Fig.10.
Relation between the voltages across a VDR carrying a direct current I or a sinusoidal alternating current $I_{RMS} = I$.

$$n = V_{rms}/V$$

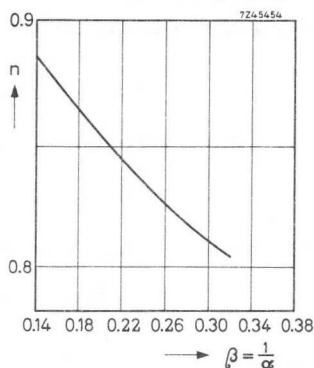

Fig.11.
Relation between the power dissipations caused by a direct current I and by a sinusoidal alternating current $I_{RMS} = I$. The dissipation caused by the alternating current is I times that caused by the direct current.

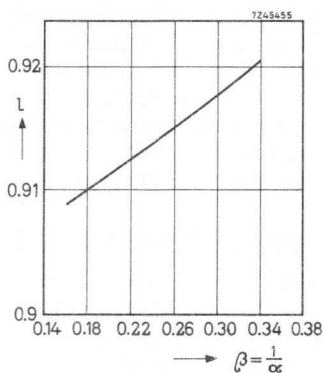
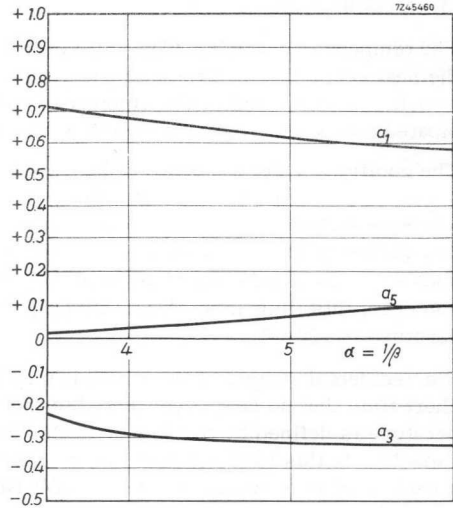

Fig.12.
Relative strength of the harmonics
of a current according to Fig.5.



capacitance is shunted has decreased. In general the effect of the capacitance in h.f. circuits will be an apparent increase of β . Furthermore the voltage current graph on a logarithmic scale will no longer be a straight line.

A number of curves demonstrating this effect are given in Fig.13.

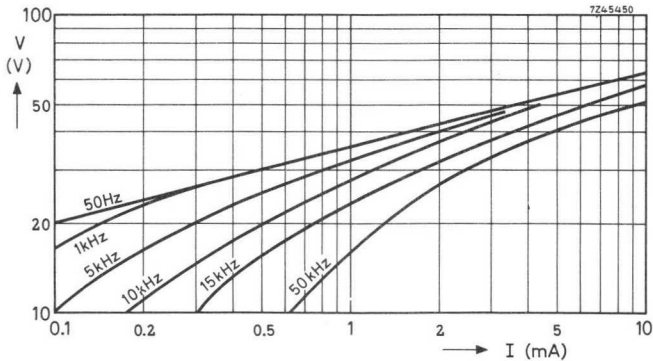

Fig.13. Voltage/current relation for different frequencies.

PERMISSIBLE DISSIPATION

The temperature which a VDR will reach is determined by the dissipated power, the heat conductivity of the material, the contact with and the nature of the surrounding medium and by the ambient temperature. As already explained the dissipated power will increase rapidly with increasing voltage.

The cooling per degree centigrade, though increasing slightly with temperature, depends mainly on the total surface area of the VDR; it can be improved by forced ventilation, by immersion in oil, or by using cooling fins or heatsinks. The permissible temperature of a VDR is generally limited by secondary effects, such as contact and insulation problems. For VDR's which are not lacquered or soldered, this limit is at about 150 °C. For lacquered VDR the permissible temperature is 120 °C.

For incidental surges, from which it may be assumed that they occur for such a short time that no heat is conducted to the surrounding medium, the rise in temperature is defined by the energy in this surge, the mass of the VDR and its heat capacity. In this case we find that a rise in temperature of 100 °C is caused by a load of 60 watt sec/gram. For a VDR having a weight of 1 gram the load may be 60 W during 1 sec or 6 W during 10 sec, etc. The shorter the time the higher the permissible load during that time. This is limited, however, by the properties of the material, which are liable to change at too high current densities.

HOW TO MEASURE VDR RESISTORS

The following points have to be considered when measuring VDR's.

1. Use only d.c. voltage.
2. Keep the measuring time as short as possible. Self-heating effects may influence the measurements due to the negative temperature coefficient of the VDR's.
3. In case the VDR's are specified at a voltage and current which is above the maximum dissipation, pulses should be used. For instance all 2322 564 VDR types which are used in television circuits are measured under pulse-conditions. These types are measured with a rectangular current pulse with a duration of 10 ms.
4. The β -value measurement needs some explanation. As mentioned on page C164 the β -value is not always constant but depends on the voltage and current. The β -values of our discs are measured between 0.3 I and 3 I, those of our rods between I and 10 I (unless otherwise specified), where I is the current at which the VDR is specified.

$$\text{E.g. } \beta = \log \frac{V_2}{V_1}; \text{ with } V_2 = \text{voltage at } 3 I \\ V_1 = \text{voltage at } 0.3 I$$

TOLERANCES

Standard VDR's are specified with a certain tolerance on voltage and a spread on β -value. It can be seen in Fig. 14 that due to the spread in β -value the tolerance on voltage may increase at other currents than the specified current at which the VDR is measured.

For some applications, where tolerances have to be kept as low as possible, the VDR's are measured at a current or voltage which lies near to its working point in the circuit, e.g. the standard rod types for TV series 2322 564 are measured at 10 mA.

For other applications, specially spark suppression, it is often important to specify a maximum permissible current at a low voltage and a minimum permissible current at a higher voltage e.g. the series 2322 577.

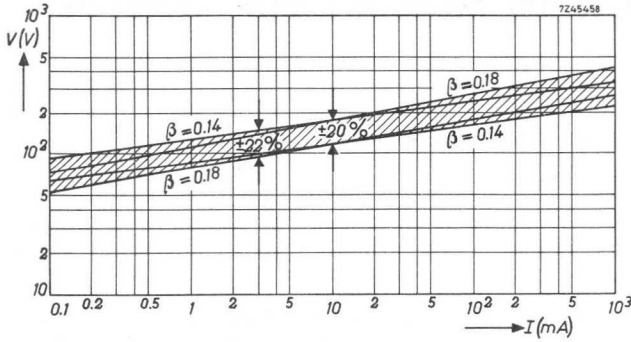

Fig. 14. Spread of voltage/current characteristic due to β -tolerance.

CHOICE OF TYPE

The voltage/current characteristics will indicate which standard type comes nearest to the required specification. The power to be dissipated will give the dimensions of the disc.

If the selected VDR has its specified values far from the working point in the circuit, it is recommended to calculate the tolerances in the working point (see section on tolerances). If necessary a 10 % tolerance can be selected instead of a 20 % type.

In case a specification is required in the form of

$$\text{at } V_1 \text{ volt } I < I_1$$

$$\text{at } V_2 \text{ volt } I > I_2$$

it is recommended to select a type which fulfils the first requirement (including tolerances); with the aid of a nomogram or by graphical solution on double logarithmic paper the second requirement can be checked.

If no standard type is available it is often possible to create or select a special type for a particular application.

FOR
REVISION

ASYMMETRIC VDR RESISTORS

In order to extend our VDR-range to lower C-values a new VDR has been developed based on a barrier layer effect. As this device shows different characteristics in the two different directions, it is called an asymmetric VDR.

In one direction (the conduction direction) the VDR has a low C-value and a very low β -value (in the order of 0.07). In the reverse direction the resistance value and so the C-value is considerably higher.

Although there is some correspondence with diode characteristics there are important differences e.g.:

the asymmetric VDR has a high capacitance (about $0.15 \mu\text{F}$ measured in the reverse direction);

the tolerances of the asymmetric VDR are closer;

the temperature coefficient of asymmetric VDR's is very low;

the characteristic of the asymmetric VDR is steeper (low β -value);

the asymmetric VDR is made for voltages from 1 to 1.35 V at 1 mA, so higher than most semiconductor diodes.

The present range is limited to two values, other types are in development. The asymmetric VDR is applied in radio and transistorized TV circuits.

1954

1954

1954

1954

1954

1954

1954

1954

1954

1954

1954

APPLICATIONS

In the following pages some of the most important application principles are given. Wellknown are the television applications where the VDR is applied as a rectifier of non-symmetrical pulses and for stabilization against supply voltage variations and aging of components. Also in TV sets the VDR is used across the primary of the frame output transformer for damping oscillations while in other parts of the circuits VDR fulfil the functions of a voltage stabilization device. Outside the entertainment field we find e.g. VDR's applied in telecommunication for use as a contact protector of relays. Besides the standard range a special range of VDR's has been developed for this purpose. A similar application can be found in small battery motors where the VDR increases the collector life considerably.

There are many more uses for VDR's and the following selection is by no means complete.

Contact-protection and
spark suppression

Two principle circuits are used. As soon as the contacts open, the energy stored in the inductance ($\frac{1}{2} L I^2$) is dissipated by the VDR and limits the voltage across the contacts to a safe value.

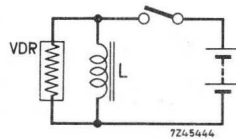
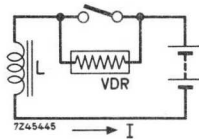

Protection of small battery motors

Sparking brush-contacts limit the collector life and give rise to interference with nearby radio or audio circuits. A small VDR in parallel to the rotor windings prevents the sparking and so increases the collector life considerably.

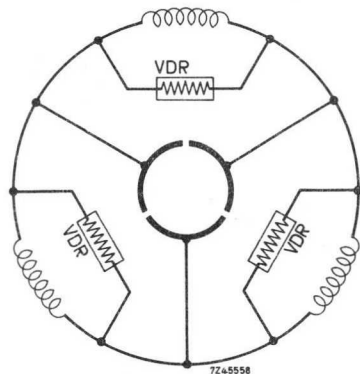

VDR for adapting meter sensitivity

A VDR in series with a voltmeter or parallel to a milliamperemeter will give increased sensitivity in a certain range.

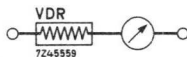

Stabilization of a voltage without load when the supply voltage varies

It can be shown that the VDR stabilizes varying supply voltages by a factor

$$S = \frac{\Delta V/V}{\Delta V_2/V_2} = \frac{1}{\beta} - \frac{1-\beta}{\beta} \cdot x \quad \text{where } x = V/V_2.$$

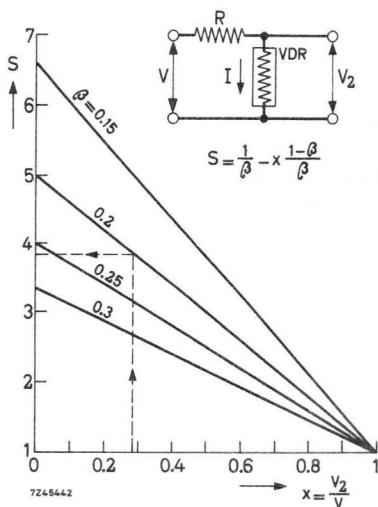

Stabilization of a voltage with load

In this case the stabilization factor also depends on the current through the load.

$$S = \frac{1}{\beta} - \frac{1-\beta}{\beta} \cdot \frac{x+y}{1+y} \text{ where } y = I_2/I_1$$

In the nomogram S can easily be found.

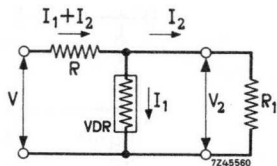
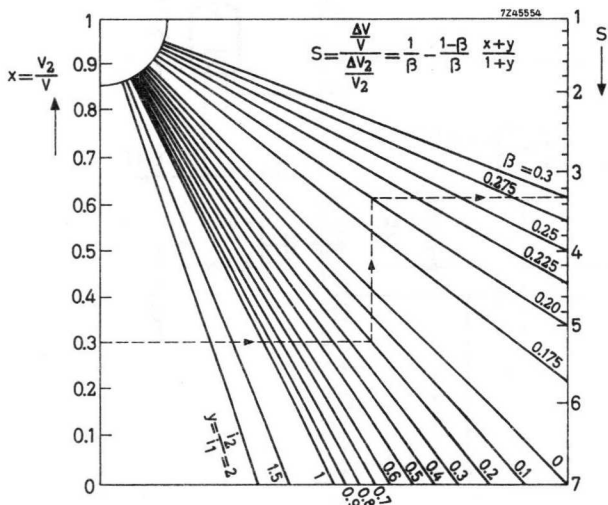

VDR for limiting the anode peak voltage and damping oscillations in vertical output stages of TV circuits

The VDR is shunted across the primary of the frame output transformer.

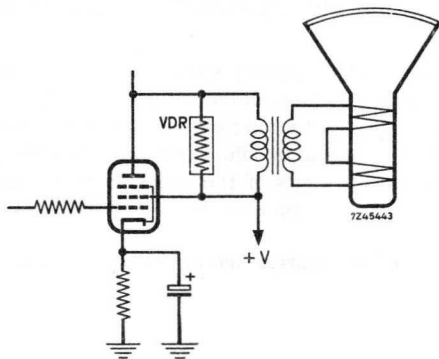

VDR as a rectifier for obtaining a negative voltage for stabilization of the picture width and the EHT against supply voltage variations and aging of tubes

The VDR acts as a diode when asymmetrical pulses of sufficient amplitude are applied to its terminals. The negative voltages can be used to regulate the line-output tube.

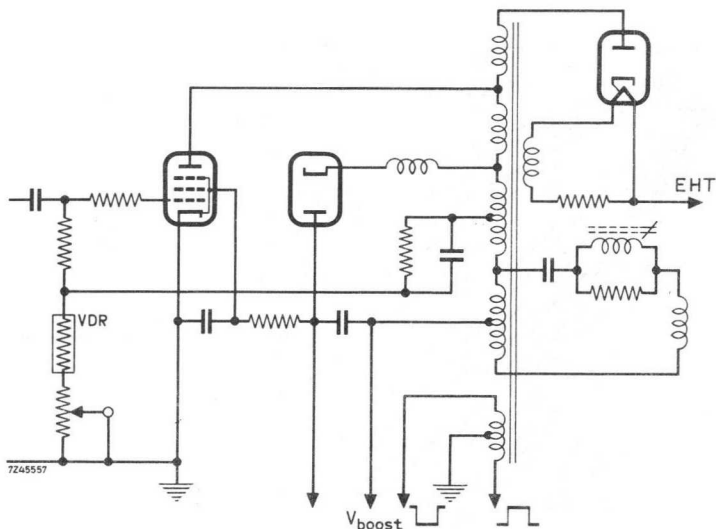

Stabilization of the operation current of transistors in an a.m. portable receiver.

It is known that due to decreasing battery voltage during life the sensitivity of a portable receiver decreases, so the number of stations that can be clearly received is reduced. Furthermore the distortion level increases and spurious effects, like "motorboating", caused by audio frequency instability occur.

By stabilizing the operation currents of the transistors by means of an asymmetric VDR the above effects can be eliminated and the useful battery life will be much longer.

Extensive literature on this application and circuits are available on request.

VOLTAGE DEPENDENT RESISTORS

standard disc type with leads

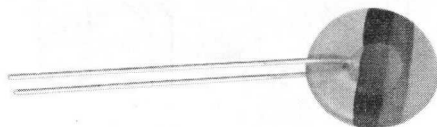

RZ 19624-1

QUICK REFERENCE DATA

Voltages at $I_{nom} = 100 \text{ mA d.c.}$	8 to 12 V
Voltages at $I_{nom} = 10 \text{ mA d.c.}$	8 to 68 V
Voltages at $I_{nom} = 1 \text{ mA d.c.}$	56 to 330 V
β between $0.3 I_{nom}$ and $3 I_{nom}$	0.14 to 0.40
Maximum dissipation	0.8 W
Operating temperature range	
at zero power	-25 to +125 °C
at maximum power	0 to +55 °C

APPLICATION

Very suitable for e.g. voltage stabilisation, contact protection and spark suppression.

DESCRIPTION

This type consists of a disc provided with two solid tinned copper wires. The resistor body is tan lacquered and impregnated, but non insulated.

MECHANICAL DATA

Dimensions in mm

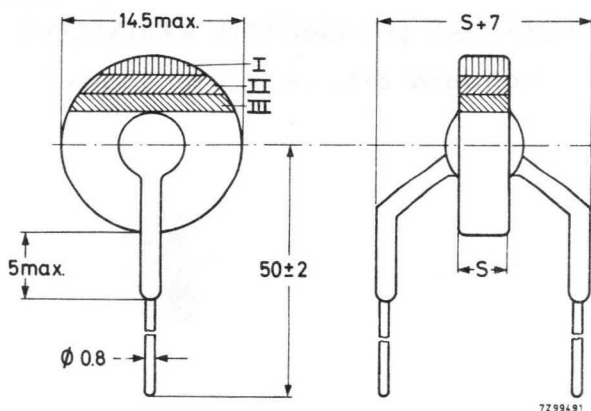

Fig. 1. For S see Table 1

Marking

The resistors are marked with three colour bands according to Fig. 1 and Table 1.

Weight

See Table 1

Mounting

In any position by soldering.

Robustness of terminations

Tensile strength	20 N
Bending	10 N

Soldering

Solderability	max. 240°C, max. 4 s
Resistance to heat	max. 240°C, max. 4 s

VOLTAGE DEPENDENT RESISTORS
standard disc type with leads

2322 552 0. . . .

ELECTRICAL DATA

d.c. current I_{nom} (mA)	voltage at I_{nom} (V)	β	C approx.	S max. Fig. 1 (mm)	weight approx. (g)	colour code 2)			catalogue number 1)
						I	II	III	
100	8	0.25-0.40	14	5	1.0	brown	brown	blue	2322 552 01161
100	10	0.25-0.40	18	5	1.0	brown	brown	grey	2322 552 01181
100	12	0.25-0.40	21	5	1.0	brown	red	black	2322 552 01201
10	8	0.25-0.40	25	5	1.0	red	brown	blue	2322 552 02161
10	10	0.25-0.40	32	5	1.1	red	brown	grey	2322 552 02181
10	12	0.25-0.40	40	5	1.1	red	red	black	2322 552 02201
10	15	0.25-0.40	48	5	1.1	red	red	red	2322 552 02221
10	18	0.21-0.35	57	5	1.15	red	red	yellow	2322 552 02241
10	22	0.21-0.35	60	5	1.15	red	red	blue	2322 552 02261
10	27	0.21-0.35	70	5	1.15	red	red	grey	2322 552 02281
10	33	0.18-0.25	85	5	1.15	red	orange	black	2322 552 02301
10	39	0.18-0.25	100	5	1.15	red	orange	red	2322 552 02321
10	47	0.18-0.25	130	5	1.15	red	orange	yellow	2322 552 02341
10	56	0.18-0.25	150	5	1.15	red	orange	blue	2322 552 02361
10	68	0.18-0.25	180	5	1.15	red	orange	grey	2322 552 02381
1	56	0.14-0.23	190	5	1.15	orange	orange	blue	2322 552 03361
1	68	0.14-0.23	230	5	1.15	orange	orange	grey	2322 552 03381
1	82	0.14-0.21	300	5	1.2	orange	yellow	black	2322 552 03401
1	100	0.14-0.21	350	5.5	1.3	orange	yellow	red	2322 552 03421
1	120	0.14-0.21	400	6	1.35	orange	yellow	yellow	2322 552 03441
1	150	0.14-0.21	500	6.5	1.45	orange	yellow	blue	2322 552 03461
1	180	0.14-0.21	600	7	1.6	orange	yellow	grey	2322 552 03481
1	220	0.14-0.21	750	7.5	1.85	orange	green	black	2322 552 03501
1	270	0.14-0.21	900	8	2.0	orange	green	red	2322 552 03521
1	330	0.14-0.21	1100	9	2.3	orange	green	yellow	2322 552 03541

1) For a voltage tolerance of $\pm 10\%$ the last figure of the catalogue number is 2 instead of 1.

2) The 10% types have an extra silver band on the top.



Tolerance on voltage at I_{nom}	$\pm 20\%$ ¹⁾
Maximum dissipation	0.8 W
Asymmetry	max. 2%
Operating temperature range	
at zero power	-25 to +125 °C
at maximum power	0 to +55 °C

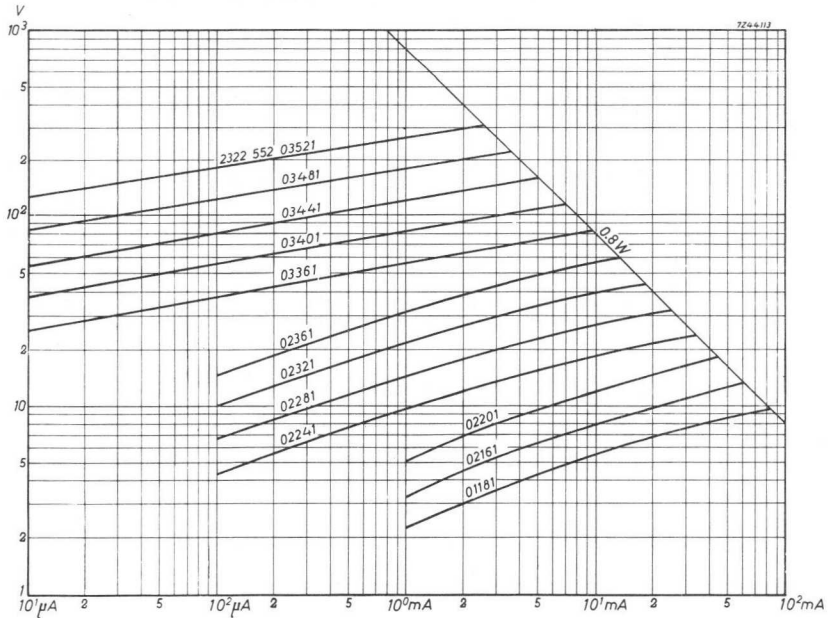

Fig. 2. Voltage/current characteristics

¹⁾ Also available with a tolerance of 10%.

The voltage is so measured that the internal heat development is negligible.

TESTS AND REQUIREMENTS

According to IEC 68 recommendations, unless otherwise specified.

test	test method	duration	$\Delta V/V$ (%)	$\Delta\beta/\beta$ (%)
Cold at -25 °C	A	1000 h	±3	±3
Storage at +25 °C	H	1000 h	±2	±3
Dry heat at +125 °C	B	1000 h	±3	±5
Thermal shock -25 to +125 °C	Na	5 cycles	±3	±5
Damp heat at +40 °C	Ca	1000 h	±3	±5
Dissipation in damp heat		336 h	±3.5	±7
Max. dissipation at T _{amb} = +25 °C		1000 h	±5	±10
Robustness of terminations	U			
Tensile strength 20 N	Ua	10 s		1)
Bending 10 N	Ub	2 times		1)
Soldering	T			
Solderability at +230 ±10 °C	par 3.2.3	3 to 4 s		2)
Resistance to heat +230 ±10 °C	par 3.2.4	3 to 4 s	±2	±2

1) Leads should neither come loose nor break.

2) Leads must be solderable initially and after six months storage with solder containing resin flux.

QUALITY LEVEL

Sampling and data evaluation for quality level in accordance with MIL-STD-105D

- A.Q.L. 1 %, major defects - Electrical
- A.Q.L. 1.5%, major defects - Mechanical
- A.Q.L. 4 %, minor defects - Physical

PACKAGING

Cardboard boxes containing 100 items.

0 508 5265

STATE OF CALIFORNIA
DEPARTMENT OF REVENUE

RECEIVED
FEB 10 1964

VOLTAGE DEPENDENT RESISTORS

standard disc type with leads

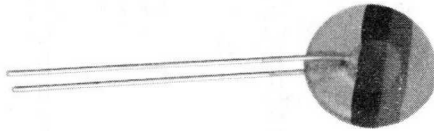

RZ 19624-1

QUICK REFERENCE DATA

Voltages at $I_{nom} = 100 \text{ mA}$	8 to 15 V
Voltages at $I_{nom} = 10 \text{ mA}$	10 to 82 V
Voltages at $I_{nom} = 1 \text{ mA}$	68 to 330 V
β between $0.3 I_{nom}$ and $3 I_{nom}$	0.14 to 0.40
Maximum dissipation	1 W
Operating temperature range	
at zero power	-25 to +125 °C
at maximum power	0 to +55 °C

APPLICATION

Very suitable for e.g. voltage stabilisation, contact protection and spark suppression.

DESCRIPTION

This type consists of a disc provided with two solid tinned copper wires. The resistor body is tan lacquered and impregnated, but non insulated.

MECHANICAL DATA

Dimensions in mm

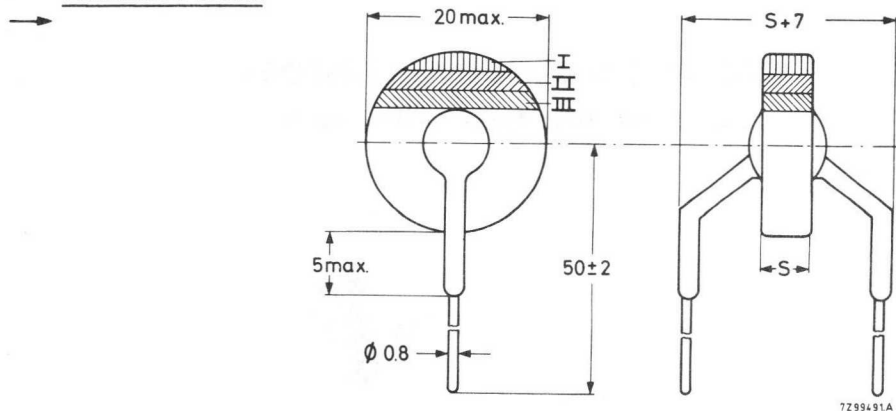

Fig. 1. For S see Table 1

Marking

The resistors are marked with three colour bands according to Fig. 1 and Table 1.

Weight

See Table 1

Mounting

In any position by soldering.

Robustness of terminations

Tensile strength	20 N
Bending	10 N

Soldering

Solderability	max. 240 °C, max. 4 s
Resistance to heat	max. 240 °C, max. 4 s

ELECTRICAL DATA

d. c. current I_{nom} (mA)	voltage at I_{nom} (V)	β	C approx.	S max. Fig. 1 (mm)	weight approx. (g)	colour code 2)			catalogue number 1)
						I	II	III	
100	8	0.25-0.40	14	5	1.2	brown	brown	blue	2322 553 01161
100	10	0.25-0.40	18	5	1.3	brown	brown	grey	2322 553 01181
100	12	0.25-0.40	21	5	1.4	brown	red	black	2322 553 01201
100	15	0.25-0.40	26	5	1.4	brown	red	red	2322 553 01221
10	10	0.25-0.40	32	5	1.5	red	brown	grey	2322 553 02181
10	12	0.25-0.40	40	5	1.5	red	red	black	2322 553 02201
10	15	0.25-0.40	48	5	1.5	red	red	red	2322 553 02221
10	18	0.21-0.35	57	5	1.5	red	red	yellow	2322 553 02241
10	22	0.21-0.35	60	5	1.6	red	red	blue	2322 553 02261
10	27	0.21-0.35	70	5	1.6	red	red	grey	2322 553 02281
10	33	0.18-0.25	85	5	1.6	red	orange	black	2322 553 02301
10	39	0.18-0.25	100	5	1.6	red	orange	red	2322 553 02321
10	47	0.18-0.25	130	5	1.6	red	orange	yellow	2322 553 02341
10	56	0.18-0.25	150	5	1.6	red	orange	blue	2322 553 02361
10	68	0.18-0.25	180	5	1.6	red	orange	grey	2322 553 02381
10	82	0.14-0.23	190	5	1.6	red	yellow	black	2322 553 02401
1	68	0.14-0.23	230	5	1.6	orange	orange	grey	2322 553 03381
1	82	0.14-0.21	300	5	1.6	orange	yellow	black	2322 553 03401
1	100	0.14-0.21	350	5, 5	1.8	orange	yellow	red	2322 553 03421
1	120	0.14-0.21	400	6	1.9	orange	yellow	yellow	2322 553 03441
1	150	0.14-0.21	500	6, 5	2.1	orange	yellow	blue	2322 553 03461
1	180	0.14-0.21	600	7	2.4	orange	yellow	grey	2322 553 03481
1	220	0.14-0.21	750	7, 5	2.8	orange	green	black	2322 553 03501
1	270	0.14-0.21	900	8	3.2	orange	green	red	2322 553 03521
1	330	0.14-0.21	1100	9	3.7	orange	green	yellow	2322 553 03541

1) For a voltage tolerance of $\pm 10\%$ the last figure of the catalogue number is 2 instead of 1.

2) The 10% types have an extra silver band on the top.



Tolerance on voltage at I_{nom}	$\pm 20\%$ 1)
Maximum dissipation	1 W
Asymmetry	max. 2%
Operating temperature range	
at zero power	-25 to +125 °C
at maximum power	0 to +55 °C

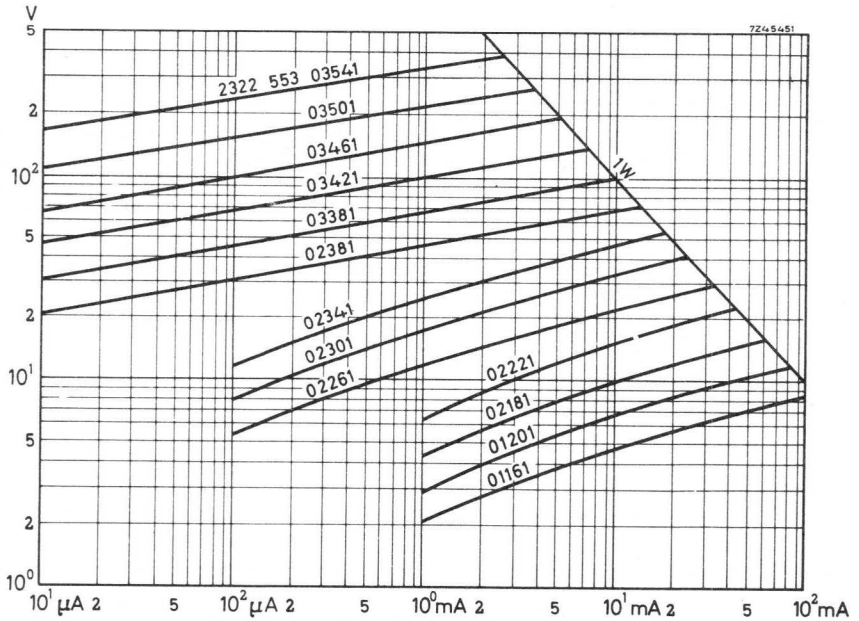

Fig. 2. Voltage/current characteristics

1) Also available with a tolerance of 10%.

The voltage is so measured that the internal heat development is negligible.

TESTS AND REQUIREMENTS

According to IEC 68 recommendations, unless otherwise specified.

test	test method	duration	$\Delta V/V$ (%)	$\Delta\beta/\beta$ (%)
Cold at $-25\text{ }^{\circ}\text{C}$	A	1000 h	± 3	± 3
Storage at $+25\text{ }^{\circ}\text{C}$	H	1000 h	± 2	± 3
Dry heat at $+125\text{ }^{\circ}\text{C}$	B	1000 h	± 3	± 5
Thermal shock -25 to $+125\text{ }^{\circ}\text{C}$	Na	5 cycles	± 3	± 5
Damp heat at $+40\text{ }^{\circ}\text{C}$	Ca	1000 h	± 3	± 5
Dissipation in damp heat		336 h	± 3.5	± 7
Max. dissipation at $T_{\text{amb}} = +25\text{ }^{\circ}\text{C}$		1000 h	± 5	± 10
Robustness of terminations	U			
Tensile strength 20 N	Ua	10 s		1)
Bending 10 N	Ub	2 times		1)
Soldering	T			
Solderability at $230 \pm 10\text{ }^{\circ}\text{C}$	par 3.2.3	3 to 4 s		2)
Resistance to heat at $230 \pm 10\text{ }^{\circ}\text{C}$	par 3.2.4	3 to 4 s	± 2	± 2

1) Leads should neither come loose nor break.

2) Leads must be solderable initially and after six months storage with solder containing resin flux.

QUALITY LEVEL

Sampling and data evaluation for quality level in accordance with MIL-STD-105D

A.Q.L. 1 %, major defects - Electrical

A.Q.L. 1.5%, major defects - Mechanical

A.Q.L. 4 %, minor defects - Physical

PACKAGING

Cardboard boxes containing 100 items.

3823 503 0

1910

1910

1910

VOLTAGE DEPENDENT RESISTORS

standard disc type with leads



RZ 19624-1

QUICK REFERENCE DATA

Voltages at $I_{nom} = 100 \text{ mA}$	8 to 18 V
Voltages at $I_{nom} = 10 \text{ mA}$	10 to 82 V
Voltages at $I_{nom} = 1 \text{ mA}$	150 to 330 V
β between $0.3 I_{nom}$ and $3 I_{nom}$	0.14 to 0.40
Maximum dissipation	2 W
Operating temperature range	
at zero power	-25 to +125 °C
at maximum power	0 to +55 °C

APPLICATION

Very suitable for e.g. voltage stabilisation, contact protection and spark suppression.

DESCRIPTION

This type consists of a disc provided with two solid tinned copper wires. The resistor body is tan lacquered and impregnated, but non insulated.

MECHANICAL DATA

Dimensions in mm

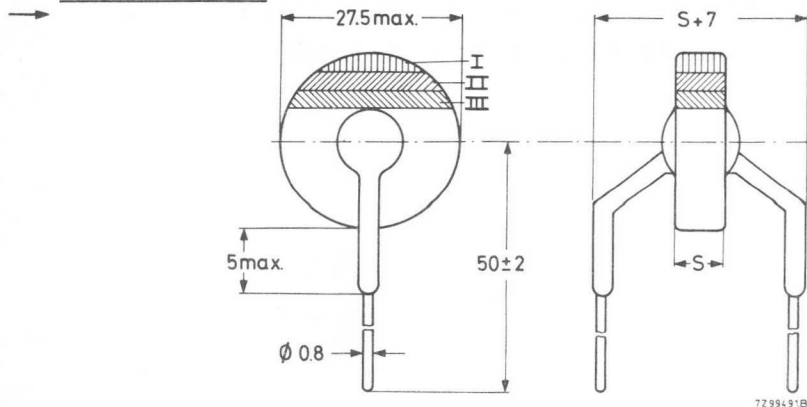

Fig.1. For S see Table 1

Marking

The resistors are marked with three colour bands according to Fig.1 and Table 1.

Weight

See Table 1

Mounting

In any position by soldering.

Robustness of terminations

Tensile strength	20 N
Bending	10 N

Soldering

Solderability	max. 240 °C, max. 4 s
Resistance to heat	max. 240 °C, max. 4 s

VOLTAGE DEPENDENT RESISTORS
standard disc type with leads

2322 554 0...

ELECTRICAL DATA

d. c. current I _{nom} (mA)	voltage at I _{nom} (V)	β	C approx.	S max. Fig. 1 (mm)	weight approx. (g)	colour code 2)			catalogue number 1)
						I	II	III	
100	8	0.25-0.40	14	5	1.9	brown	brown	blue	2322 554 01161
100	10	0.25-0.40	18	5	1.95	brown	brown	grey	2322 554 01181
100	12	0.25-0.40	21	5	2.0	brown	red	black	2322 554 01201
100	15	0.25-0.40	26	5	2.0	brown	red	red	2322 554 01221
100	18	0.25-0.40	32	5	2.05	brown	red	yellow	2322 554 01241
10	12	0.25-0.40	38	5	2.05	red	red	black	2322 554 02201
10	15	0.25-0.40	47	5	2.1	red	red	red	2322 554 02221
10	18	0.21-0.35	57	5	2.1	red	red	yellow	2322 554 02241
10	22	0.21-0.35	60	5	2.2	red	red	blue	2322 554 02261
10	27	0.21-0.35	70	5	2.3	red	red	grey	2322 554 02281
10	33	0.18-0.25	84	5	2.4	red	orange	black	2322 554 02301
10	39	0.18-0.25	97	5	2.45	red	orange	red	2322 554 02321
10	47	0.18-0.25	125	5	2.5	red	orange	yellow	2322 554 02341
10	56	0.18-0.25	140	5	2.55	red	orange	blue	2322 554 02361
10	68	0.18-0.25	175	5	2.6	red	orange	grey	2322 554 02381
10	82	0.14-0.23	170	5	2.65	red	yellow	black	2322 554 02401
10	100	0.14-0.23	210	5	2.7	red	yellow	red	2322 554 02421
10	120	0.14-0.21	250	5	2.75	red	yellow	yellow	2322 554 02441
10	150	0.14-0.21	320	5.5	2.8	red	yellow	blue	2322 554 02461
10	180	0.14-0.21	380	6	3.2	red	yellow	grey	2322 554 02481
1	150	0.14-0.21	450	6.5	3.6	orange	yellow	blue	2322 554 03461
1	180	0.14-0.21	540	7	4.2	orange	yellow	grey	2322 554 03481
1	220	0.14-0.21	660	7.5	4.8	orange	green	black	2322 554 03501
1	270	0.14-0.21	810	8	5.7	orange	green	red	2322 554 03521
1	330	0.14-0.21	980	9	6.7	orange	green	yellow	2322 554 03541

1) For a voltage tolerance of ±10% the last figure of the catalogue number is 2 instead of 1.

2) The 10% types have an extra silver band on the top.



Tolerance on voltage at I_{nom}	$\pm 20\%$ ¹⁾
Maximum dissipation	2 W
Asymmetry	max. 2%
Operating temperature range	
at zero power	-25 to +125 °C
at maximum power	0 to +55 °C

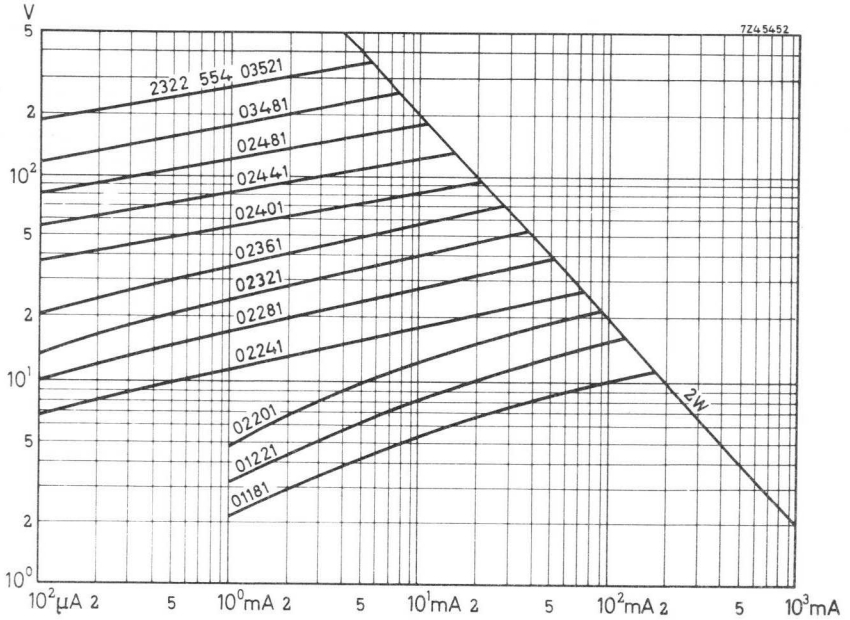

Fig. 2. Voltage/current characteristics

¹⁾ Also available with a tolerance of 10%.

The voltage is so measured that the internal heat development is negligible.

TESTS AND REQUIREMENTS

According to IEC 68 recommendations, unless otherwise specified.

test	test method	duration	$\Delta V/V$ (%)	$\Delta\beta/\beta$ (%)
Cold at -25 °C	A	1000 h	± 3	± 3
Storage at $+25$ °C	H	1000 h	± 2	± 3
Dry heat at $+125$ °C	B	1000 h	± 3	± 5
Thermal shock -25 to $+125$ °C	Na	5 cycles	± 3	± 5
Damp heat at $+40$ °C	Ca	1000 h	± 3	± 5
Dissipation in damp heat		336 h	± 3.5	± 7
Max. dissipation at $T_{amb} = +25$ °C		1000 h	± 5	± 10
Robustness of terminations	U			
Tensile strength 20 N	Ua	10 s		1)
Bending 10 N	Ub	2 times		1)
Soldering	T			
Solderability at 230 ± 10 °C	par 3.2.3	3 to 4 s		2)
Resistance to heat at 230 ± 10 °C	par 3.2.4	3 to 4 s	± 2	± 2

1) Leads should neither come loose nor break.

2) Leads must be solderable initially and after six months storage with solder containing resin flux.

QUALITY LEVEL

Sampling and data evaluation for quality level in accordance with MIL-STD-105D

A.Q.L. 1 ‰, major defects - Electrical

A.Q.L. 1.5‰, major defects - Mechanical

A.Q.L. 4 ‰, minor defects - Physical

PACKAGING

Cardboard boxes containing 50 items.

PLATE 10

VOLTAGE DEPENDENT RESISTORS

standard disc type with leads



RZ 19624-1

QUICK REFERENCE DATA

Voltages at $I_{nom} = 100$ mA d. c.	8 to 33 V
Voltages at $I_{nom} = 10$ mA d. c.	22 to 270 V
Voltages at $I_{nom} = 1$ mA d. c.	220 to 330 V
β between $0.3 I_{nom}$ and $3 I_{nom}$	0.14 to 0.40
Maximum dissipation	3 W
Operating temperature range	
at zero power	-25 to +125 °C
at maximum power	0 to +55 °C

APPLICATION

Very suitable for e.g. voltage stabilisation, contact protection and spark suppression.

DESCRIPTION

This type consists of a disc provided with two solid tinned copper wires. The resistor body is tan lacquered and impregnated, but non insulated.

MECHANICAL DATA

Dimensions in mm

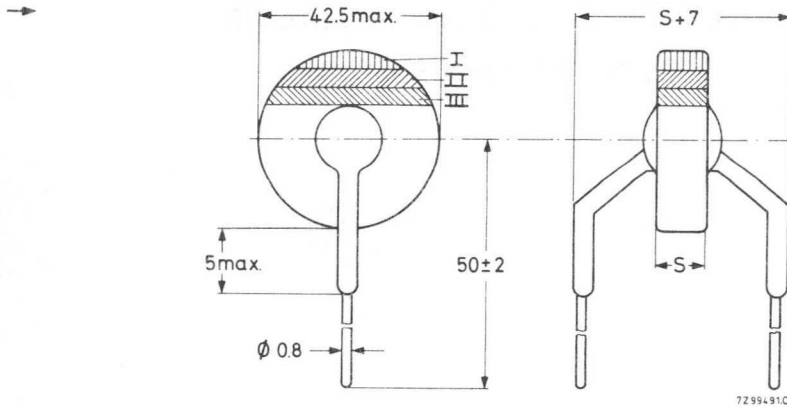

Fig. 1. For S see Table 1

Marking

The resistors are marked with three colour bands according to Fig. 1 and Table 1.

Weight

See Table 1

Mounting

In any position by soldering.

Robustness of terminations

Tensile strength	20 N
Bending	10 N

Soldering

Solderability	max. 240 °C, max. 4 s
Resistance to heat	max. 240 °C, max. 4 s

VOLTAGE DEPENDENT RESISTORS
standard disc type with leads

2322 555 0

ELECTRICAL DATA

d. c. current I _{nom} (mA)	voltage at I _{nom} (V)	β	C approx.	S max. Fig. 1 (mm)	weight approx. (g)	colour code 2)			catalogue number 1)
						I	II	III	
100	8	0.25-0.40	14	5	2.2	brown	brown	blue	2322 555 01161
100	10	0.25-0.40	18	5	2.3	brown	brown	grey	2322 555 01181
100	12	0.25-0.40	21	5	2.4	brown	red	black	2322 555 01201
100	15	0.25-0.40	26	5	2.5	brown	red	red	2322 555 01221
100	18	0.25-0.40	32	5	2.7	brown	red	yellow	2322 555 01241
100	22	0.25-0.40	39	5	2.9	brown	red	blue	2322 555 01261
100	27	0.25-0.40	48	5	3.0	brown	red	grey	2322 555 01281
100	33	0.21-0.35	53	5	3.6	brown	orange	black	2322 555 01301
10	22	0.21-0.35	60	5	3.8	red	red	blue	2322 555 02261
10	27	0.21-0.35	70	5	4.0	red	red	grey	2322 555 02281
10	33	0.18-0.25	84	5	4.5	red	orange	black	2322 555 02301
10	39	0.18-0.25	97	5	5.0	red	orange	red	2322 555 02321
10	47	0.18-0.25	125	5	5.0	red	orange	yellow	2322 555 02341
10	56	0.18-0.25	140	5	5.0	red	orange	blue	2322 555 02361
10	68	0.18-0.25	175	5	5.0	red	orange	grey	2322 555 02381
10	82	0.14-0.23	170	5	5.0	red	yellow	black	2322 555 02401
10	100	0.14-0.23	210	5	5.0	red	yellow	red	2322 555 02421
10	120	0.14-0.21	250	5	5.0	red	yellow	yellow	2322 555 02441
10	150	0.14-0.21	320	5.5	5.7	red	yellow	blue	2322 555 02461
10	180	0.14-0.21	380	6	6.7	red	yellow	grey	2322 555 02481
10	220	0.14-0.21	460	6.5	8.0	red	green	black	2322 555 02501
10	270	0.14-0.21	550	7	10	red	green	red	2322 555 02521
1	220	0.14-0.21	660	7.5	12	orange	green	black	2322 555 03501
1	270	0.14-0.21	810	8	14	orange	green	red	2322 555 03521
1	330	0.14-0.21	980	9	16	orange	green	yellow	2322 555 03541

1) For a voltage tolerance of ± 10% the last figure of the catalogue number is 2 instead of 1.

2) The 10% types have an extra silver band on the top.



Tolerance on voltage at I_{nom}	$\pm 20\%$ 1)
Maximum dissipation	3 W
Asymmetry	max. 2%
Operating temperature range	
at zero power	-25 to +125 °C
at maximum power	0 to +55 °C

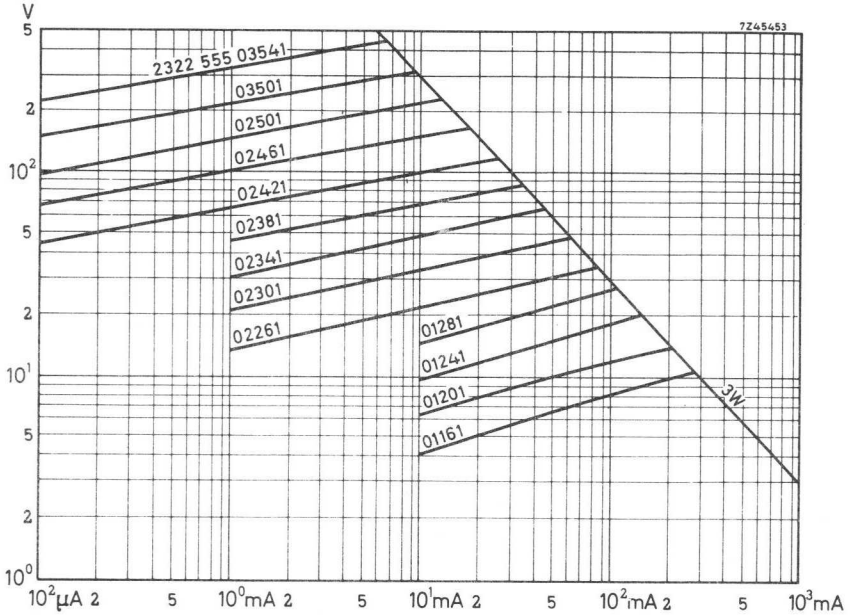

Fig. 2. Voltage/current characteristics

1) Also available with a tolerance of 10%. The voltage is so measured that the internal heat development is negligible.

TESTS AND REQUIREMENTS

According to IEC 68 recommendations, unless otherwise specified.

test	test method	duration	$\Delta V/V$ (%)	$\Delta\beta/\beta$ (%)
Cold at $-25\text{ }^{\circ}\text{C}$	A	1000 h	± 3	± 3
Storage at $+25\text{ }^{\circ}\text{C}$	H	1000 h	± 2	± 3
Dry heat at $+125\text{ }^{\circ}\text{C}$	B	1000 h	± 3	± 5
Thermal shock -25 to $+125\text{ }^{\circ}\text{C}$	Na	5 cycles	± 3	± 5
Damp heat at $+40\text{ }^{\circ}\text{C}$	Ca	1000 h	± 3	± 5
Dissipation in damp heat		336 h	± 3.5	± 7
Max. dissipation at $T_{amb} = +25\text{ }^{\circ}\text{C}$		1000 h	± 5	± 10
Robustness of terminations	U			
Tensile strength 20 N	Ua	10 s		1)
Bending 10 N	Ub	2 times		1)
Soldering	T			
Solderability at $230 \pm 10\text{ }^{\circ}\text{C}$	par 3.2.3			2)
Resistance to heat at $230 \pm 10\text{ }^{\circ}\text{C}$	par 3.2.4		± 2	± 2

1) Leads should neither come loose nor break.

2) Leads must be solderable initially and after six months storage with solder containing resin flux.

QUALITY LEVEL

Sampling and data evaluation for quality level in accordance with MIL-STD-105D

A.Q.L. 1 %, major defects - Electrical

A.Q.L. 1.5%, major defects - Mechanical

A.Q.L. 4 %, minor defects - Physical

PACKAGING

Cardboard boxes containing 25 items.

THE
LONDON
CORRESPONDENT
OF THE
TIMES

VOLTAGE DEPENDENT RESISTORS

standard rod types

$W_{max} 0.7 W$

These types are lacquered

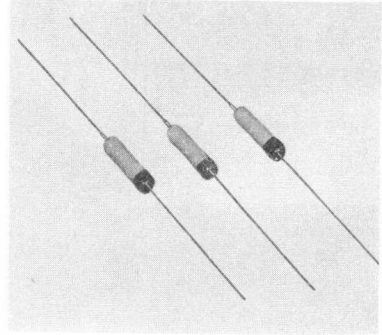
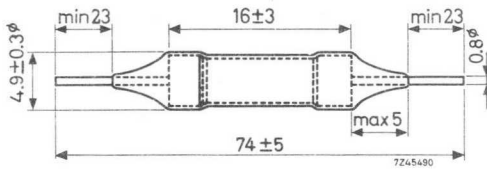

RZ 17758-5

I (mA) ¹	E (V) ¹	β	colour code	catalog number
10	470 \pm 10%	0.20-0.25	green	2322 564 02582
10	560 \pm 10%	0.18-0.23	blue	02602
10	680 \pm 10%	0.18-0.23	violet	02622
10	910 \pm 10%	0.18-0.23	white	90014
10	1200 \pm 20%	0.17-0.22	grey	02681
10	1300 \pm 10%	0.16-0.21	red	90015
1	300 \pm 20%	0.18-0.25	yellow	90016
2	950 \pm 10%	0.16-0.21	black/blue	90005

¹) Measured under pulse conditions

Voltage/current characteristics

The characteristic of the 2322 564 90005 can be compared with that of the 2322 564 90015.

The same holds for the 2322 564 90016 and 2322 564 02602.

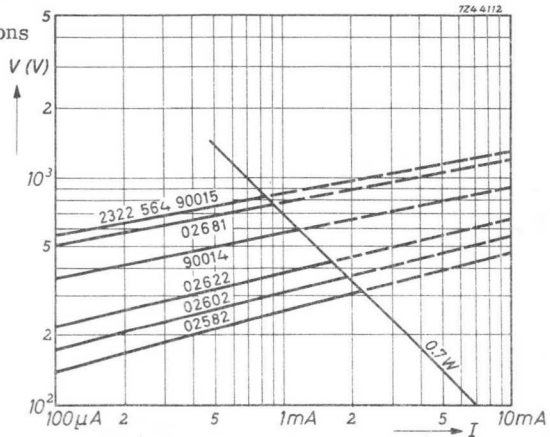

ADP 212

VOLTAGE DEPENDENT RESISTOR

QUICK REFERENCE DATA

Current at $V_{dc} = 7 \text{ kV}$ and $T_{amb} = +50 \text{ }^\circ\text{C}$	100 to 150 μA
Maximum current	175 μA
β -value between 4 kV and 7 kV	0.17 to 0.25
Operating temperature range at zero power	-25 to +125 $^\circ\text{C}$
at max. power	0 to +50 $^\circ\text{C}$

DIMENSIONS (in mm)

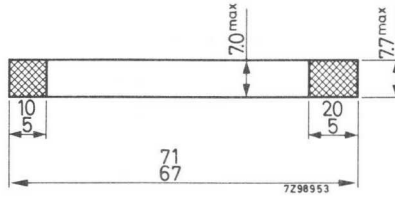

Fig. 1.

Maximum bow in the centre of the VDR rod is 1 mm.

APPLICATION

For focus tracking in line time-base circuits of colour television sets.

DESCRIPTION

The resistor consists of a rod of which the ends are tinned. It is neither lacquered nor insulated.

MECHANICAL DATA

Marking	none
Weight	approximately 4.5 g
Mounting	in any position by soldering
Solderability	$230 \pm 10 \text{ }^\circ\text{C}$, 3 s

ELECTRICAL DATA

Measurements and ratings are given at an ambient temperature of +50 °C + 2 °C unless otherwise stated.

Current at $V_{dc} = 7 \text{ kV} \pm 0.3\%$	100 to 150 μA
Maximum current (See Note below)	175 μA
β -value between 4 kV and 7 kV	0.17 to 0.25
Dissipation factor	22 mW/deg C
Temperature coefficient (α) between +25 °C and +125 °C	see Fig.4
Symmetry	< 5%
Operating temperature range	
at zero power	-25 to +125 °C
at max. power	0 to +50 °C

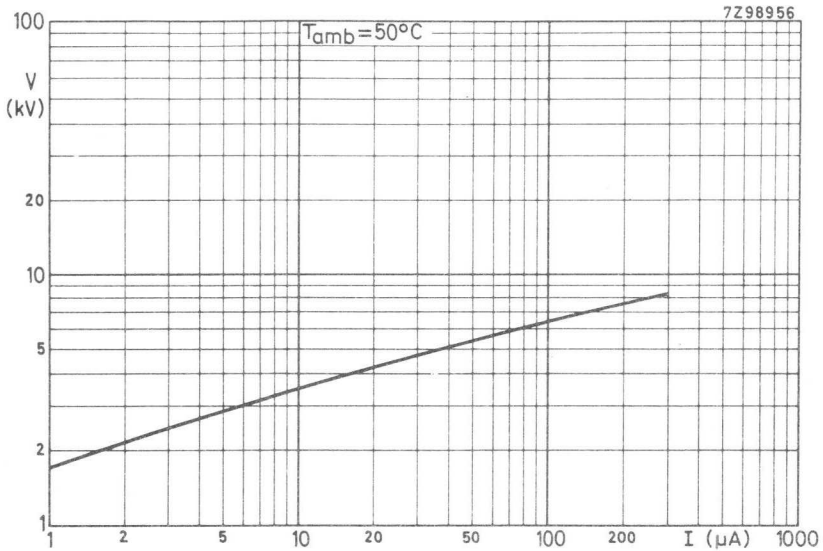

Fig.2. Voltage/current characteristic

Note Absolute maximum, i.e. VDR may only be used in such applications, where under no circumstances (excessive voltage, temperature, aging, etc.) the current through the VDR exceeds 175 μA .

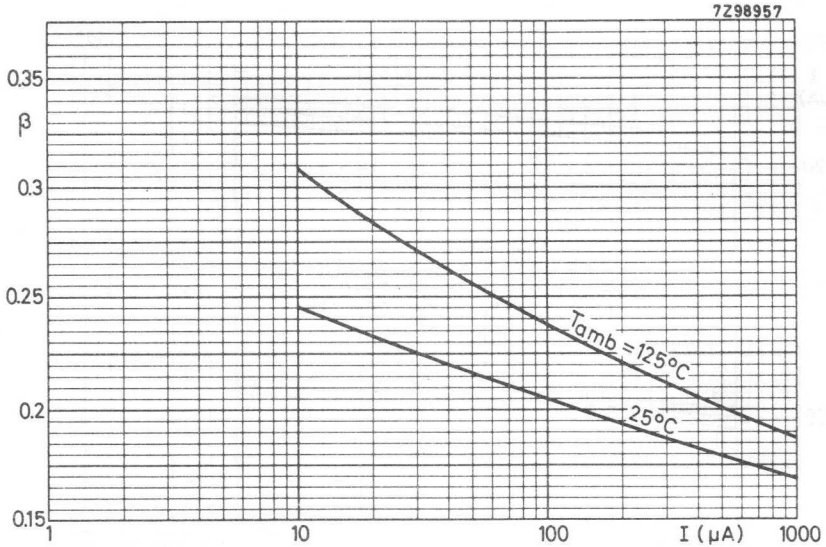

Fig. 3. β as a function of the current at a body temperature of 25°C and of 125°C .

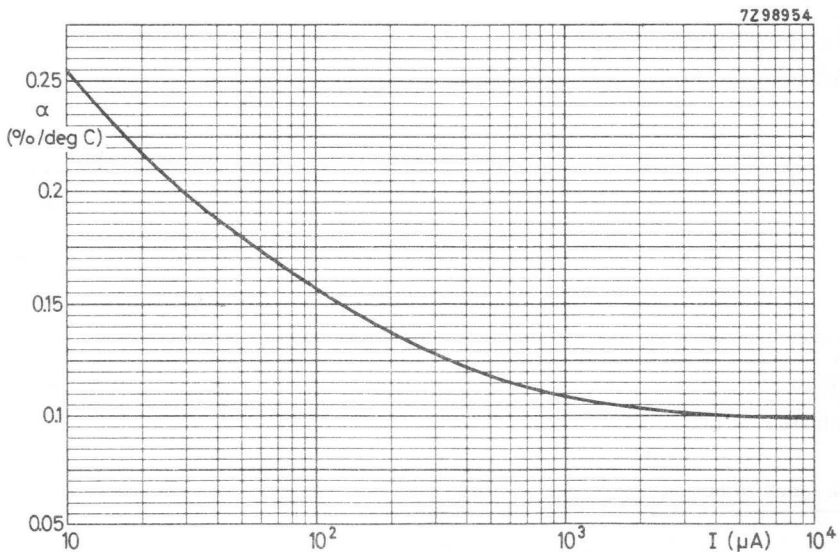

Fig. 4. Temperature coefficient α as a function of the current. Body temperature between 25 and 125°C .

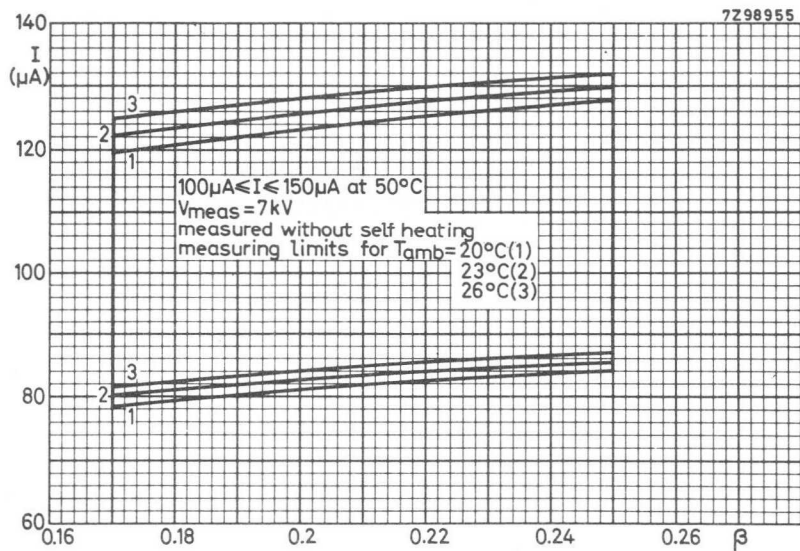

Fig. 5. Conversion graph for the current at 50 °C to the currents at 20, 23 and 26 °C.

TESTS AND REQUIREMENTS

According to I.E.C. 68, unless otherwise specified

Test	Duration	Requirements	
		$\frac{\Delta I}{I}$ (%)	$\frac{\Delta \beta}{\beta}$ (%)
Storage at $T_{amb} = +25 \text{ }^\circ\text{C} \pm 10 \text{ }^\circ\text{C}$	1000 h	± 10	± 5
Dry heat at $T_{amb} = 125 \text{ }^\circ\text{C}$	1000 h	± 20	± 10
Thermal shock $-25 \text{ }^\circ\text{C}$ to $+125 \text{ }^\circ\text{C}$	5 cycles	± 20	± 10
Damp heat	1000 h	± 20	± 10
Dissipation at $I_{dc} = 175 \text{ } \mu\text{A}$ and $T_{amb} = +25 \text{ }^\circ\text{C} \pm 10 \text{ }^\circ\text{C}$	1000 h	± 30	± 15
Resistance to heat at $+230 \text{ }^\circ\text{C}$	3-4	± 2	± 2

All measurements must be performed with a voltage of $7 \text{ kV} \pm 0.3\%$ at $T_{amb} = 23 \text{ }^\circ\text{C} \pm 1 \text{ }^\circ\text{C}$, without self-heating of the specimen and after a recovery at $+23 \text{ }^\circ\text{C} \pm 3 \text{ }^\circ\text{C}$ of minimum 60 minutes.

QUALITY LEVEL

Sampling and data evaluation for quality level in accordance with MIL-STD-105D

A.Q.L. 1 %, major defects - Electrical

A.Q.L. 1.5%, major defects - Mechanical

A.Q.L. 4 %, minor defects - Physical

PACKAGING

250 pieces per box



VOLTAGE DEPENDENT RESISTORS

small disc types for special purposes

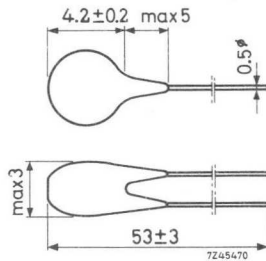
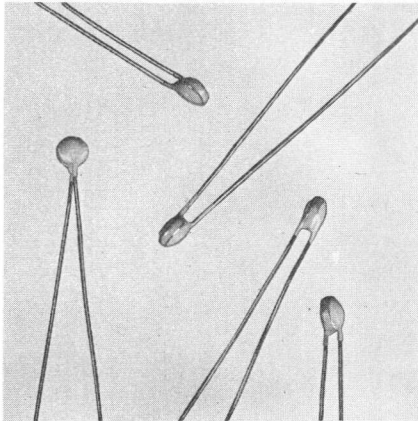

RZ 19269-8

For use in e.g. small battery motors (to protect the collector and to suppress interferences in radio and television) the 2322 565 90001 has been developed, which can be mounted in the rotor.

current at $5 V_{dc} \leq 1 \text{ mA}$
 current at $28 V_{dc} \geq 10 \text{ mA}$
 $W_{max} \quad \quad \quad 0.1 \text{ W}$

For use in colour television a special range of VDR discs has been developed:

I (mA)	E (V)	tolerance on voltage	catalog number
1	6	$\pm 20\%$	2322 565 90002
1	9	$\pm 20\%$	90003
1	12	$\pm 15\%$	90004
1	15	$\pm 15\%$	90005
1	18	$\pm 12\%$	90006

1000
1000
1000
1000
1000

VOLTAGE DEPENDENT RESISTORS

asymmetric types

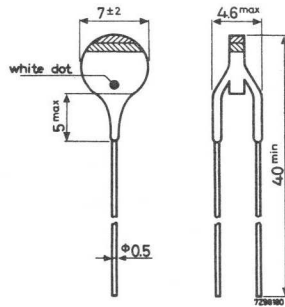
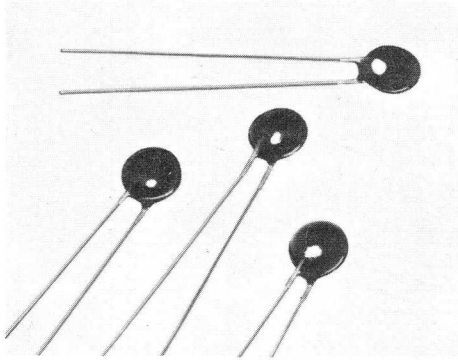

RZ 19225-4

Based on a barrier-layer effect, the asymmetric voltage-dependent resistors differ in many aspects from the well-known voltage dependent resistors made of silicon carbide. Its characteristic is asymmetric; in the forward direction, the characteristic shows a very low β -value and C-value while in the reverse direction β - and C-values are much higher. Its parallel capacitance in forward as well as in reverse direction is relatively high. (See also "General" page C131). They can be used for instance for stabilisation of the supply current in transistorised battery receivers.

For the time being two types are available.

at $T_{amb} = 25\text{ }^{\circ}\text{C}$		catalog number	
		2322 574 90001	2322 574 90002
forward direction	voltage at 1 mA temp. coeff.	$1.0\text{ V} \pm 10\%$ $> -0.2\%/deg\text{ C}$	$1.35\text{ V} \pm 10\%$ $> -0.2\%/deg\text{ C}$
	β	0.05-0.08	0.06-0.09
	capacitance at 0 mA at 5 mA max. permissible current	$\sim 0.15\text{ }\mu\text{F}$ $\sim 10\text{ }\mu\text{F}$ 25 mA	$\sim 0.15\text{ }\mu\text{F}$ $\sim 10\text{ }\mu\text{F}$ 20 mA
reverse direction	current at 5 V	$< 2\text{ }\mu\text{A}$	$< 2\text{ }\mu\text{A}$
	capacitance at 0 V at 5 V	$\sim 0.15\text{ }\mu\text{F}$ $\sim 0.05\text{ }\mu\text{F}$	$\sim 0.15\text{ }\mu\text{F}$ $\sim 0.05\text{ }\mu\text{F}$
	max. permissible voltage	5 V	5 V

Temperature range: -30 to +70 °C

Cathode is indicated by a white dot.

Colour code 2322 574 90001 black and brown band

2322 574 90002 black and red band

Voltage/current characteristics

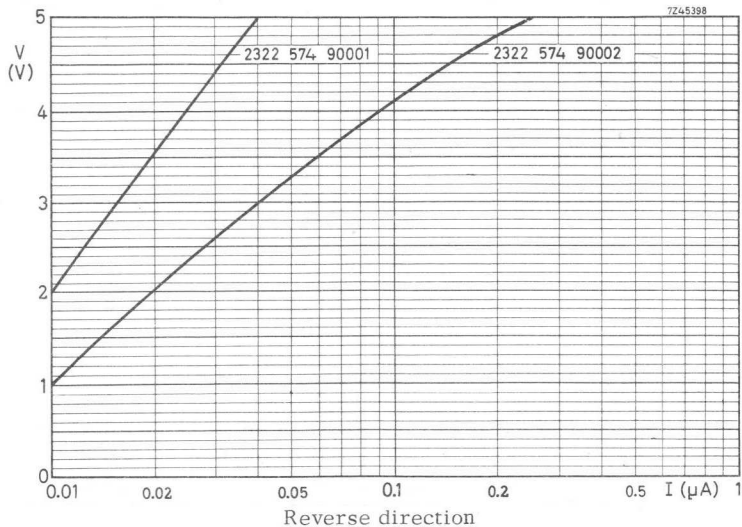
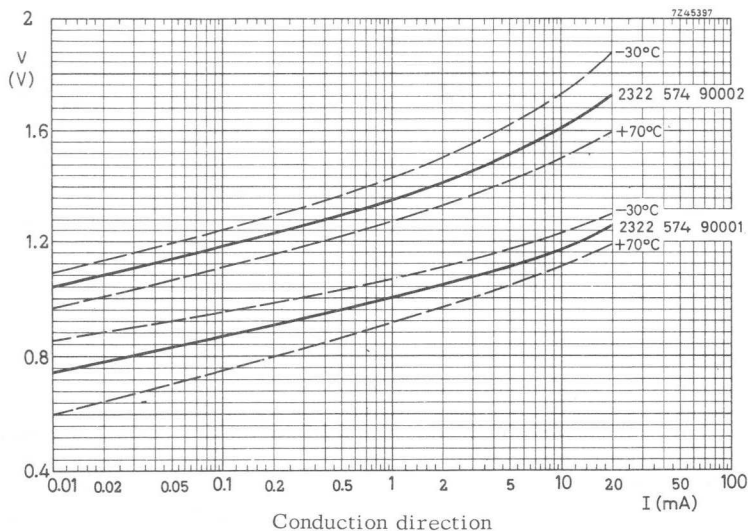

VOLTAGE DEPENDENT RESISTORS

disc types for contact protection

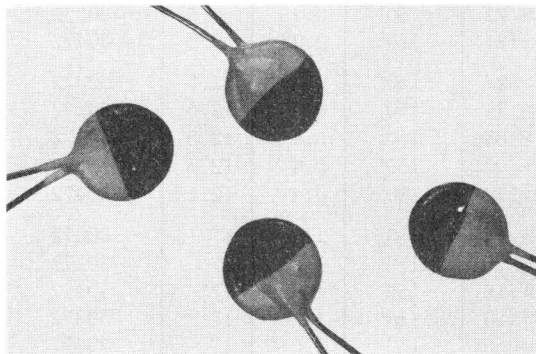

RZ 25666-8

These VDR's are developed for contact protection of relays in telephone exchanges. They are extremely stable and can stand current surges of decimals of Amps without changing their characteristics perceptibly.

Two series are available: the series without leads in a non-lacquered, fully impregnated version and the series with leads in a lacquered and also impregnated version. These resistors meet the severe specifications of official inspection offices for telephone equipment.

Dimensions and marking

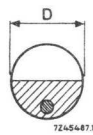

Discs without leads: white colour band, colour dot indicates 10th digit of catalog number.

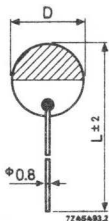

Discs with leads: body colour white, colour band indicates 10th digit of catalog number

Colour code

0 = black	4 = yellow
1 = brown	5 = green
2 = red	6 = blue
3 = orange	

W_{max}	L	Additional marking
0.25 W	58.5 mm	VAP3
0.4 W	62 mm	VAP2
1 W	65 mm	VAP1

2322 575
2322 576
2322 577

VOLTAGE DEPENDENT RESISTORS
 disc types for contact protection

V _{dc} (V)	I (mA)	I ¹⁾ (mA)	V _{pulse} ²⁾ (V)	W _{max} (W)	D (mm)	catalog number suffix	
						without leads	with leads
48	< 1.7	> 52	150	0.25	9.5	30272	00272
48	< 3	> 72	150	0.25	9.5	30372	00372
48	< 5	>121	150	0.25	9.5	30472	00472
48	< 0.5	> 27	150	0.4	12.5	30072	00072
48	< 0.9	> 34	150	0.4	12.5	30172	00172
48	< 1.7	> 65	150	0.4	12.5	30272	00272
48	< 3	> 91	150	0.4	12.5	30372	00372
48	< 5	>152	150	0.4	12.5	30472	00472
48	< 0.5	> 42	150	1	17	30072	00072
48	< 0.9	> 76	150	1	17	30172	00172
48	< 1.7	>115	150	1	17	30272	00272
48	< 3	>180	150	1	17	30372	00372
48	< 5	>268	150	1	17	30472	00472
48	< 9	>430	150	1	17	30572	00572
48	<15	>455	150	1	17	30672	00672

CATALOG NUMBER

for W _{max} = 0.25 W	2322 575	} for suffix see table
for W _{max} = 0.4 W	2322 576	
for W _{max} = 1 W	2322 577	

- 1) current through a VDR and a coil in parallel, with the switch closed (see diagram)
- 2) maximum voltage which develops across a VDR when the switch is opened (see diagram)

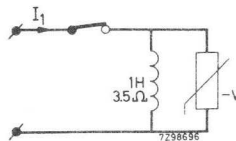

Measuring diagram

LIGHT-DEPENDENT RESISTORS



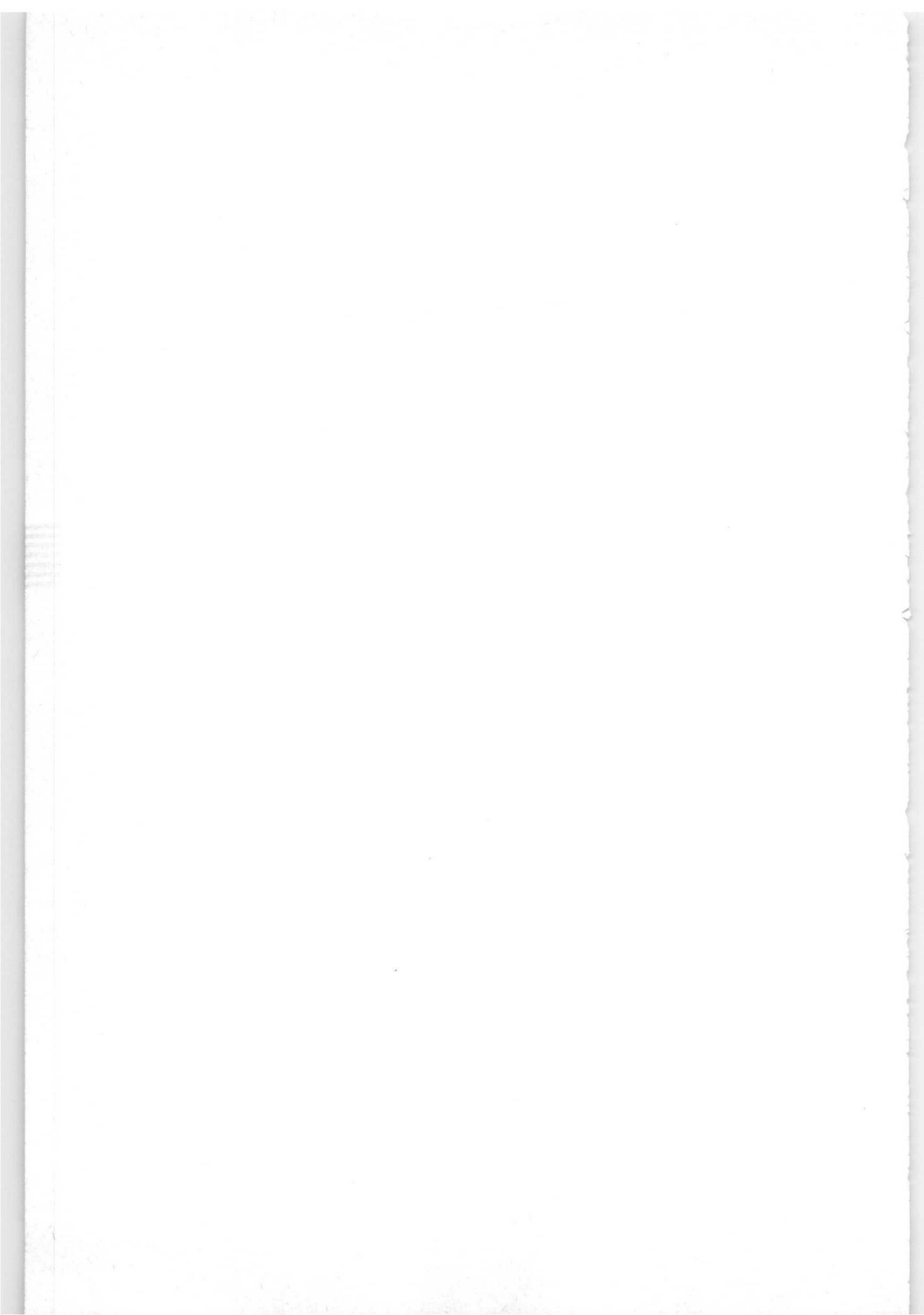

INTRODUCTION

L(ight) D(ependent) R(esistors) are made from cadmium sulphide, a material which, when prepared properly, contains no or very few free electrons when kept in complete darkness. Its resistance is therefore quite high. When it absorbs light, electrons are liberated and thus the material becomes more conducting. Cadmium sulphide is therefore called a photoconductor. The electrons are free only for a limited time and when the light is switched off, they are captured again by those places where they originally came from and thus the conductor turns again to an insulator.

Let us consider a disk of cadmium sulphide provided with two electrodes (Fig.1). The distance between the electrodes is d and the length is l . When the disk is exposed to an illumination L a number of electrons N are liberated per second in the disk between the two electrodes:

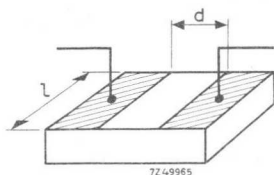

Fig.1

$$N = \eta L l d \quad (1)$$

where η is a constant depending on the wave length of the light. When a voltage V is applied to the electrodes the electrons move with a velocity v which is proportional to the field strength E :

$$v = \mu E = \frac{\mu V}{d} \quad (2)$$

The proportionality constant μ is called the mobility. Not all electrons may reach the positive electrode but only those which are liberated within a distance $v \tau$ from this electrode when τ = average life time of a free electron. The fraction of the electrons that contribute to the current is therefore $\frac{v \tau}{d}$

$$(3)$$

and the measured photocurrent i is from (1), (2) and (3) given by:

$$i = Ne \frac{v \tau}{d} = \frac{\eta e \mu \tau l LV}{d} \quad (4)$$

where e = electric charge of an electron.

The resistance R , caused by the illumination, is then:

$$R = \frac{V}{i} = \frac{d}{\eta e \mu \tau l} L^{-1} \quad (5)$$

The life time τ is usually not constant but depends on the wave length λ of the light and on the illumination L:

$$\tau = \tau_0 (\lambda) L^{-\beta} \quad (6)$$

The relation between the resistance and the illumination can therefore be expressed in good approximation by

$$R = A L^{-\alpha} \quad (7)$$

From (6) and (7)

$$A = \frac{d}{\eta e \mu \tau_0 l} \quad (8)$$

To have a sensitive L D R it is important to make A as low as possible. This can be done by choosing the right material such as cadmium sulphide with a high value of η , μ and τ_0 , and by making $\frac{1}{d}$ as large as possible. The latter is done by making a long and narrow slit and $\frac{1}{d}$ then folding it up as it were on a small area. This is accomplished by giving the electrodes an interdigital comb-like structure.

MANUFACTURING PROCESS

Highly purified cadmium-sulphide powder mixed with suitable additives is pressed in the form of discs.

The discs are sintered at a high temperature and carefully controlled conditions such as atmospheric pressure, temperature and time.

The electrodes are applied by vacuum evaporation. Afterwards leads are fixed to the electrodes and the LDR disc with leads is mounted in a suitable casing or covered by a special lacquer.

ELECTRICAL PROPERTIES

RESISTANCE/ILLUMINATION CHARACTERISTICS

As shown in the introduction the relationship between resistance value and illumination can be expressed with good approximation by the formula (7):

$$R = A L^{-\alpha}$$

where R = resistance value in Ω

L = illumination in lux (see under "photometric concepts, definitions and units" page C161).

A and α are constants

The value of α depends e.g. on the cadmium sulphide used and the manufacturing process. Values around 0.7-0.9 are quite normal. In Fig.2 the relationship between the resistance R and the illumination in lux is depicted for a normal LDR type.

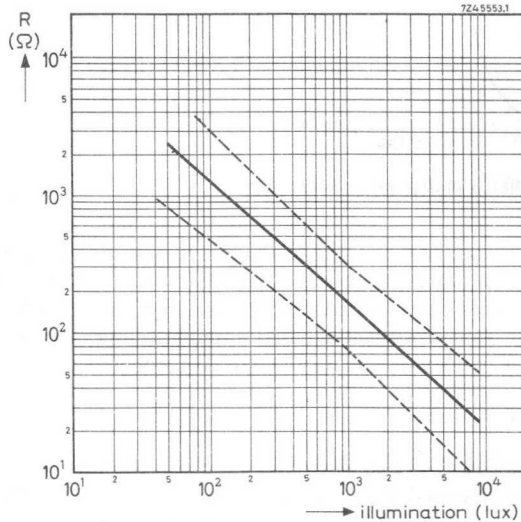

Fig.2.
Resistance/illumination
characteristic of an LDR

SPECTRAL RESPONSE

LDR's only produce an electric effect with the incident radiation of a limited range of wavelengths. At the red end of the spectrum there is a threshold wavelength above which no photoelectric effect can occur. The photons ($h\nu$) of the

radiation beyond that wavelength carry insufficient energy to liberate electrons. At wavelengths lower than the threshold value the response increases at first because η increases and more electrons are excited. There is, however, a critical wavelength below which the response decreases mainly because of a decrease in life time of the excited electrons.

The spectral response curve is a curve which shows the relationship between the resistance properties and the wavelength of the incident flux, the ordinates indicating the ratio of the resistance at any given wavelength to the resistance at a wavelength where the resistance is a maximum. The spectral sensitivity is determined by the properties of the photosensitive material. LDR's have their maximum response at about 6800 Å (see Fig.3).

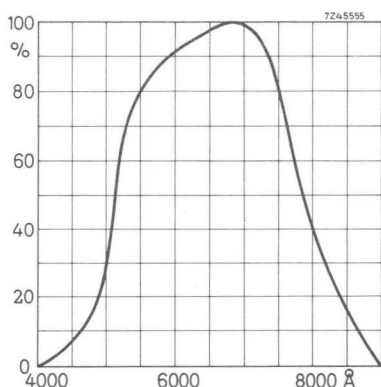

Fig.3.
Spectral response characteristic of an
LDR

TEMPERATURE DEPENDENCY

Electrons can be excited not only by photons but also by thermal agitation. The dark resistance is therefore not infinite at normal temperatures. It increases with the ambient temperature and can be decreased by cooling the device.

The temperature can also affect the resistance under illumination. At practical illumination levels and normal ambient temperatures the temperature coefficient is, however, very small and can be neglected.

RECOVERY RATE

When an LDR is brought from a certain illumination level into total darkness, it can be observed that the resistance value of the LDR does not increase immediately to the dark value but only reaches it after a certain time. The recovery rate is a practical measure for the increase in resistance value in time. It is specified in $k\Omega/s$ and for current LDR types it is more than 200 $k\Omega/s$ (during the first 20 seconds starting at a light level of 1,000 lux).

The speed is much greater in the reverse direction, e.g. going from darkness to an illumination level of 300 lux, it takes less than 10 ms to reach a resistance value which corresponds with a light level of 400 lux.

HOW TO MEASURE LDR RESISTORS

Preconditioning

Before starting measurements the LDR's have to be adapted to darkness for at least 16 hours. Then, during a minimum of 1 hour and a maximum of 2 hours the LDR's must be exposed to an illumination of 1,000 lux.

Mounting

The LDR must be mounted in a blackened box or cylinder in such a way that reflections on the surface of the LDR are avoided entirely.

The distance between the lamp and the LDR must be so that the unloaded LDR does not reach a temperature above 30 °C.

Illumination

The illumination source must be a voltage stabilized incandescent lamp with a colour temperature of 2850 °K \pm 150 °K.

Measuring the light value R_L

After preconditioning R_L can be measured at an illumination level of 1,000 lux. The measuring voltage has to be adjusted so that the dissipation in the LDR is less than 50 mW. The light level is controlled by a reference cell, situated at the same level as the LDR.

Measuring the dark value R_D

The dark resistance is measured after the LDR has been in total darkness for 30 minutes at a voltage of 20 V.

Recovery rate

When bringing an LDR from light to total darkness it takes some time before the resistance reaches an end value. The recovery rate is a check on this time, and is measured as the increase in resistance value after 20 seconds, starting from a light level of 1,000 lux. Preconditioning as above.

Drift D_L

Although not specified, it is sometimes of interest to measure the change of resistance value during a certain time at a constant light level immediately after a period of staying in total darkness.

$$D_L = \frac{R_{1L} - R_{0L}}{R_{0L}} \cdot 100\% \text{ with:}$$

R_{0L} = resistance value at $t = 0$ when the resistor comes out of the total darkness and is illuminated with L lux.

R_{1L} = resistance value at $t = t_1$ (1 or 2 hours), so exposed during a time t_1 to L lux.

SPREAD VALUES

The resistance illumination characteristics of LDR's are measured at two points, namely at 1,000 lux and in total darkness. At 1,000 lux a maximum and a minimum resistance value are specified. In total darkness the minimum resistance value, reached after a certain time, is specified.

As the value of α is not a constant (see section on properties of LDR's) but shows some spread, the spread at another light level may be somewhat wider than the spread values at 1,000 lux (see fig.2).

Influence of illumination level

At very high illumination levels (above 10,000 lux) the R/L characteristics tend to flatten. At this level the influence of the resistance of the electrodes (compared with the resistance of the CdS) is no longer negligible.

PHOTOMETRIC CONCEPTS, DEFINITIONS AND UNITS

A light source emits radiation of many different wavelengths and in all directions into space. The spectral distribution of the emitted radiation, i.e. the distribution of energy at different wavelengths, is determined by the properties of the source. Thus, practically all the light emitted by a sodium lamp is of one characteristic wavelength ($589\text{ m}\mu$). This is called monochromatic light. Other sources, such as fluorescent lamps, emit light of a number of discrete wavelengths, together with a continuous spectrum, so that the spectral distribution approximates to that of daylight. On the other hand, an incandescent light source, such as a tungsten lamp, emits radiation over a continuous range of wavelengths only. The intensity of the flux depends on the material of the filament and its temperature.

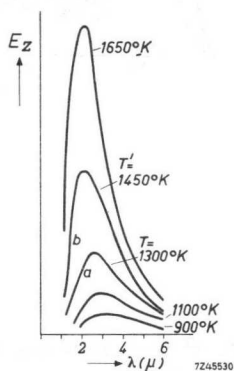

Fig.4.
Black-body radiation as a function of the wavelength.

As the radiation of a black body (full radiator) can be expressed by an exact formula, so that for a given temperature the spectral distribution of energy is fixed (Fig.4), the flux of an incandescent lamp is referred to the black-body radiation.

"Wien" has shown that curve a of Fig.4 can be transposed into curve b by multiplying the wavelengths by T/T' , and the ordinates by $(T'/T)^5$. The curves therefore have a uniform shape.

Now the spectral distribution of the radiation emitted by an incandescent lamp is approximately the same as that of a black-body radiator, but with an intensity multiplied by a factor less than unity. By definition, this factor, which is called the emission factor, is equal to unity only for a black body. For tungsten the emission factor is about 0.5, slightly increasing from longer to shorter wavelengths, so that the maximum of radiation is shifted slightly to the left compared

with a black body. The intensity of the radiation of a tungsten lamp can be expressed as the "luminance temperature", i.e. the absolute temperature a black body should have in order to emit radiation of the same intensity as the tungsten lamp. This luminance temperature of tungsten is obviously some hundreds of degrees below the true temperature of the filament.

Fig.5.
Curves relating the radiation of a tungsten filament with black-body radiation.

true temperature 2800 °K
luminance temperature 2520 °K
colour temperature 2870 °K

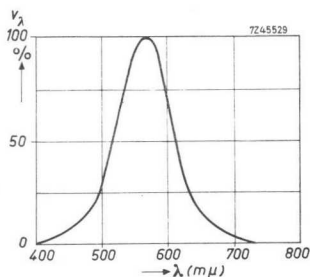
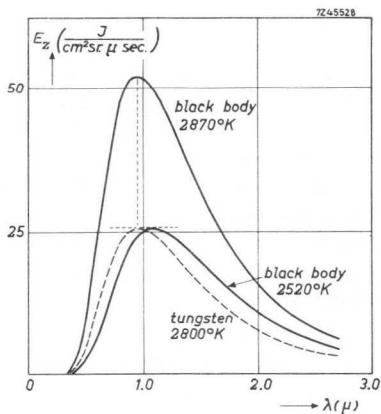

Fig.6.
Sensitivity of the human eye as a function of the wavelength.

The spectral distribution of the radiation from an incandescent lamp is expressed by the colour temperature, i.e. the absolute temperature of a black body when its maximum of radiation is of the same wavelength as that of the tungsten radiation. As the emission factor of tungsten is almost constant, the colour temperature is practically equal to the true temperature (Fig.5).

In general, the flux of energy emitted is expressed in watts. In photometry, however, it is usual to express the light flux, that is to say the total amount of visible radiation emitted or received by a given surface, in lumens. This quantity, denoted by ϕ , is given by the expression

$$\phi = 680 \int_{380}^{760} V_\lambda d\lambda \text{ lumen}$$

where E_λ is the flux in watts between λ and $\lambda+d\lambda$, and v_λ the "international luminosity factor", representing the sensitivity of the average human eye as a function of the wavelength (Fig.6). The constant 680 has the dimension of lumens per watt. It can thus be seen that at the maximum sensitivity of the eye (550 m μ) 1 watt corresponds to 680 lumen (since then $v_\lambda = 1$).

In the case of an incandescent lamp the flux is completely described by its colour temperature and the number of lumens which it emits.

The illumination E of an area A is defined as the incident light flux per square metre, i.e. $E = d\phi/dA$. The unit of illumination is the lux, one lux corresponding to one lumen per square metre.

The portion of a spherical space occupied by a given beam of light emitted from a light source (point source) situated at the centre of the sphere is called the solid angle of the beam, and is expressed in steradians (sr). The steradian is defined as follows: Imagine a point source located at the centre of a sphere of 1 metre radius (Fig.7). A beam impinging upon one square metre of the surface of the sphere is said to have a solid angle of one steradian.

If the radius of the sphere is increased to R_m , this beam of 1 sr will irradiate a surface of R^2m^2 . Consequently, a spherical surface S at a distance R from the source receives radiation over a solid angle $\omega = S/R^2$ sr. A sphere contains a total of 4π sr.

The light flux in lumens emitted in a given direction per unit of solid angle is called the intensity of the source. The intensity $I = d\phi/d\omega$ and is expressed in candela (cd) or lumens per steradian.

Finally the luminance is defined as the flux in lumens radiated into a steradian of solid angle per unit of projected area as seen in the considered direction. In other words, the luminance is the intensity per projected unit area of radiating surface (in cm^2) in a given direction. Thus $B = dI/dA \cos \phi$; it is expressed in candela per square centimetre (cd/cm^2) i.e. lumens per square centimetre per steradian.

The relationships between the above-mentioned units are indicated in a simple manner in Fig.8.

If a light source which radiates with a uniform intensity of 1 cd in all directions is located at the centre of a sphere of radius 1 m, it emits a light flux of 1 lumen into each steradian of solid angle. The total emission of this light source is 4π lm. The illumination of the surface of the sphere is 1 lux. If this light source has a radiating surface of 1 cm^2 perpendicular to the considered direction, its luminance is 1 cd/cm^2 .

Consider now a surface S located at a distance R from a light source of intensity 1 (cd) in the direction of the line joining the source and the surface S . This surface receives a flux of IS/R^2 lumens, provided the direction of the beam is normal to the surface, and no optical system is inserted between the lamp and the surface (Fig.9). The normal incandescent lamps are manufactured for a colour temperature of 2700-2900 °K. Their emission, in lumens/watt, is therefore approximately constant. A value of 13 lm/W can be taken for design calculations. If the lamps emitted equally in all directions, the intensity would be $1/4\pi$ times

the flux. For practical purposes, the intensity in candela in the forward direction is equal to the number of lumens divided by 10.

Fig. 7.
Diagram illustrating the definition of the solid angle

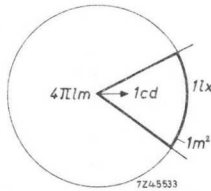
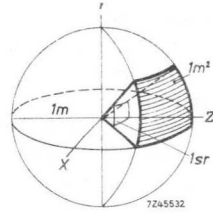

Fig. 8.
Relation between various photometric units.

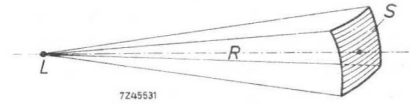
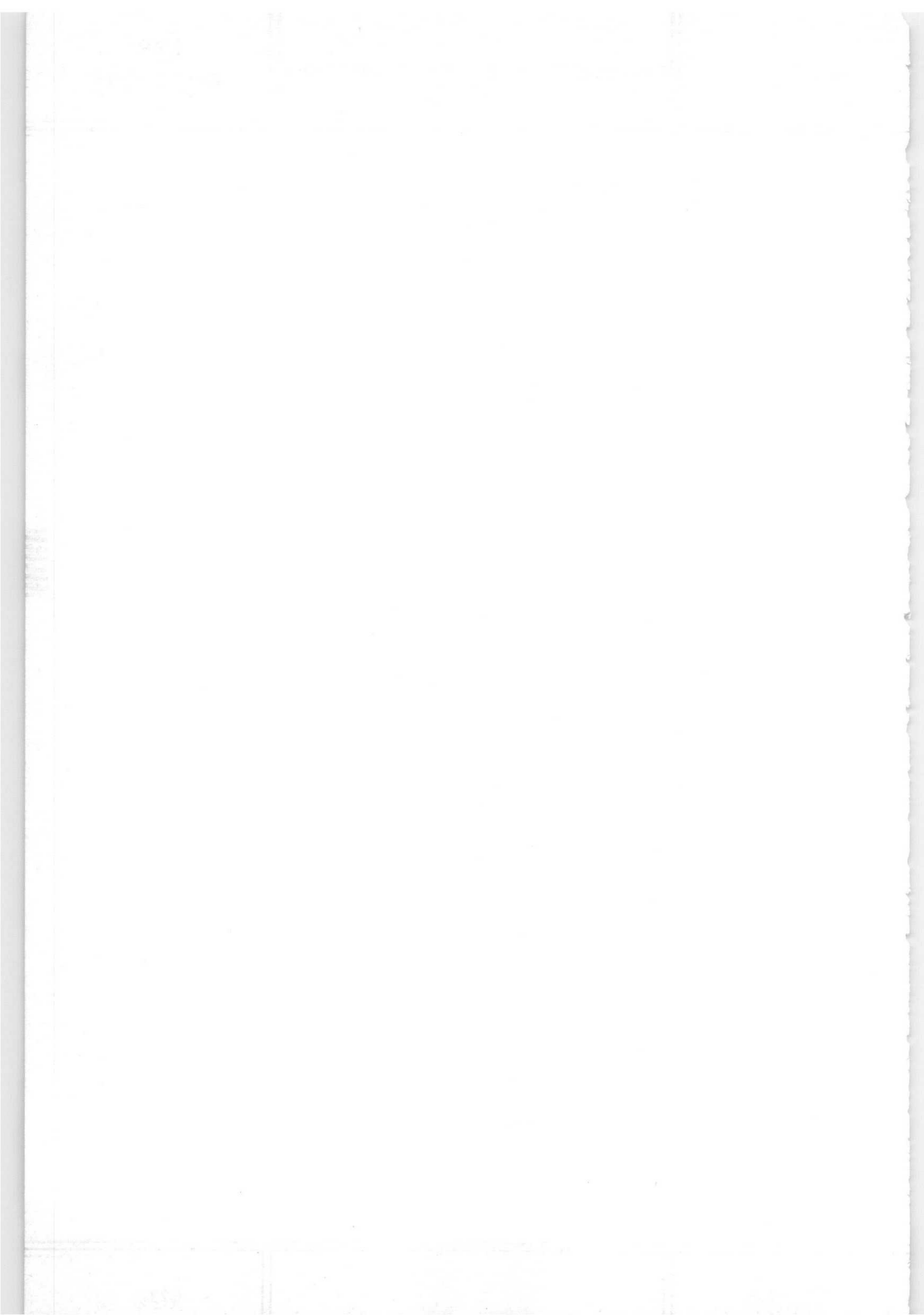

Fig. 9.
Point source L illuminating area S.

The photometric units described above are those employed in modern practice. However, a number of older, obsolete units are still met with occasionally. The relation between the old and the new units is given below:

$$\begin{aligned} \text{illumination } E &= \frac{\text{light flux}}{\text{surface}} ; \\ \text{lux (lx)} &= \frac{\text{lumen}}{\text{metre}^2} \\ \text{foot-candle (fc)} &= \frac{\text{lumen}}{\text{foot}^2} \\ \text{phot (ph)} &= \frac{\text{lumen}}{\text{cm}^2} \\ 1 \text{ lux} &= 1/10,764 \text{ foot-candle} \\ &= 10^{-4} \text{ phot.} \\ \text{luminance } B &= \frac{\text{light flux}}{\text{surface area} \times \text{solid angle}} ; \\ \text{nit} &= \frac{\text{candela}}{\text{metre}^2} = \frac{\text{lumen}}{\text{m}^2 \text{ steradian}} \\ \text{stilb} &= \frac{\text{cm}^2}{\text{cd}} \\ \text{apostilb} &= \frac{\text{lux}}{\pi \text{ steradian}} \\ \text{foot-lambert} &= \frac{\text{foot-candle}}{\pi \text{ steradian}} \\ \text{lambert} &= \frac{\text{phot}}{\pi \text{ steradian}} \\ 1 \text{ cd/cm}^2 &= 1 \text{ stilb} \\ &= 10^4 \text{ nit} \\ &= \pi \cdot 10^4 \text{ apostilb} \\ &= \frac{1}{3.426} \cdot 10^4 \text{ foot-lambert} \\ &= \pi \text{ lambert} \end{aligned}$$



APPLICATIONS

Most LDR applications are on-off applications, either directly operating a lamp or a relay of sufficiently low power or for larger power by means of a suitable amplifier. It is important to calculate the maximum dissipation occurring in the LDR. If the maximum supply voltage (V_{\max}) and the resistance value of the load (R) are known, this maximum dissipation in the LDR occurs when its resistance value is equal to R . The power to be dissipated by the LDR is then: $(V_m)^2/4R$. This value has to be smaller than the maximum permissible dissipation at the given ambient temperature, otherwise the LDR will be damaged by overheating. Furthermore it is important to note that partial illumination of the sensitive area of the LDR can be dangerous (use of lenses or diafragma), namely in that case a small part of the CdS disc has to dissipate all the power and damage may follow even if the dissipated power is lower than the maximum permissible. Combinations lamp-LDR are often mounted in a light-tight container. Care must be taken that the LDR is not heated over 60°C . Low power lamps, open construction, and heatsinks are meant to keep the temperature as low as possible. In the following some circuits for a variety of applications are given. No details on component values, voltages, etc. are mentioned; for most circuits these are highly dependent on the relays, lamps and mounting used and can be worked out easily. For the more complicated transistor circuits we will gladly supply full details.

LDR-relays with holding circuit

A temporary short circuit of the LDR or a voltage pulse on the lamp energises the "relay" LDR's.

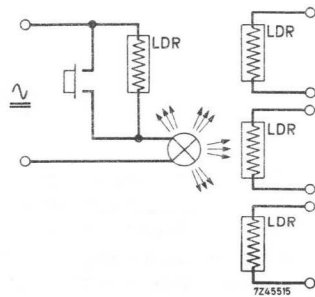

Level control

If the prism is immersed in a fluid there is practically no reflection. As soon as the prism comes above the fluid level total reflection occurs and the LDR is illuminated.

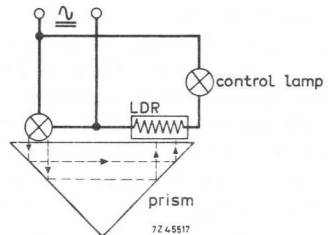

Twilight switch

Operates with a bi-metal relay so that incident light flashes have no influence.

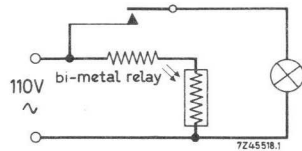

Gain limiting control

With increasing V_i , the resistance value of the LDR decreases and V_o remains low.

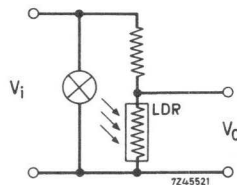

Remote control and/or crackle-free potentiometer

The connection between the lamp and the potentiometer regulating the lamp current can be made as long as necessary.

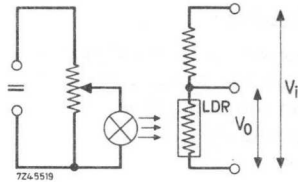

Switch without click

Used in electronic musical instruments e.g. organs.

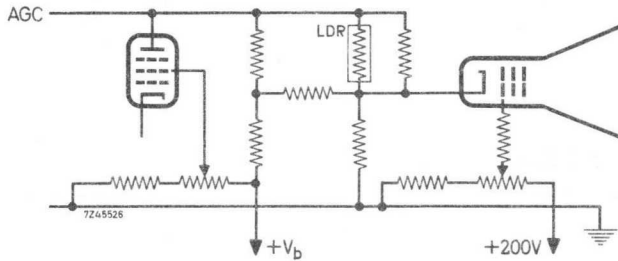
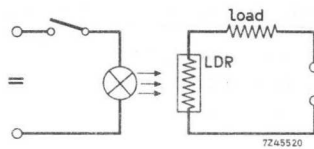

Automatic brightness and contrast control in television

Brightness and contrast are automatically adjusted at changing ambient illumination.

Flashing light

As soon as the lamp lights up, the LDR becomes low ohmic and the relays disconnect the lamp, thus the LDR becomes high ohmic etc.

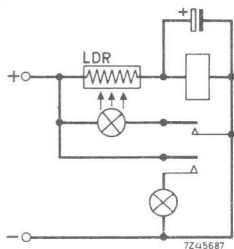

Warning circuit for tail-light failure

As soon as one of the tail-lights breaks down the control lamp on the dashboard extinguishes.

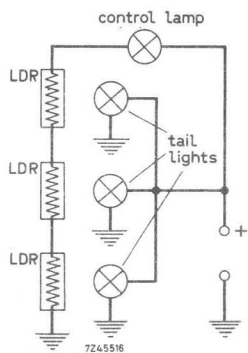

Warning circuit for tail-light failure

Transistorized circuit.

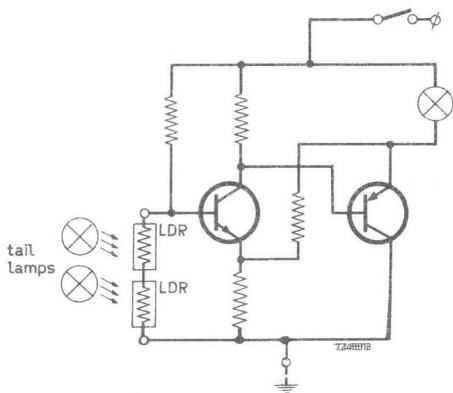

Parking light

The parking light is gradually switched-on.

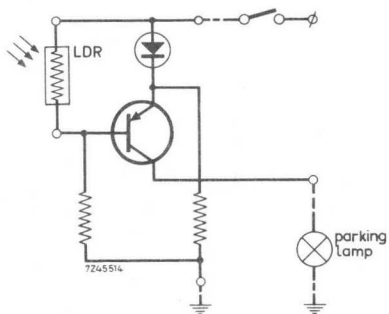

Rifle range with LDR

The rifle gives by means of a capacitor discharge a short light flash. A hit can be registered by a buzzer and/or lamp.

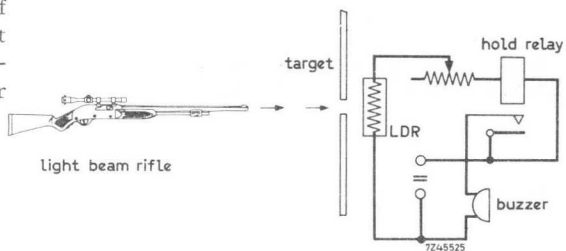

Model train control

Different simple and complex control circuits can be made with LDR's.

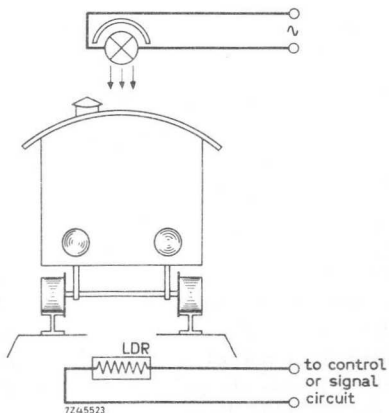

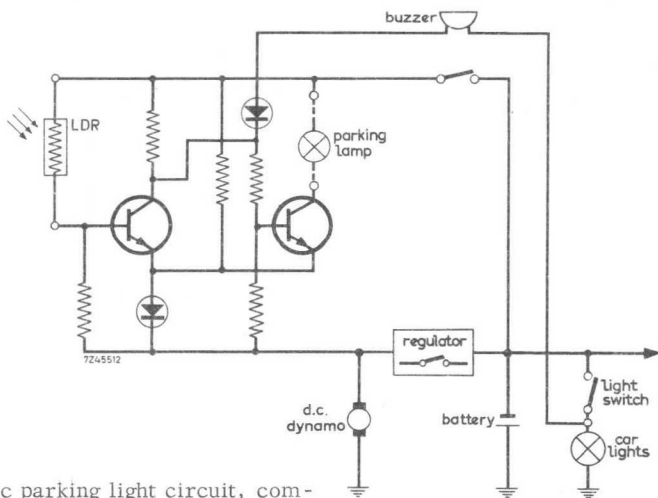

Automatic parking light circuit, combined with a light switch-off alarm

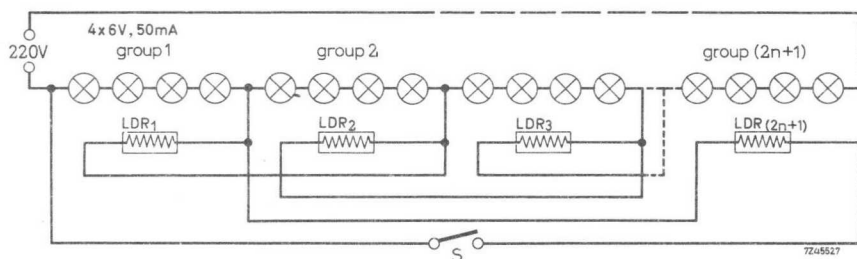

Flashing lights for advertising purposes

Operation is started by applying the supply voltage at opened switch S. Because of the lamps of group 1 lighting up, LDR₁ is illuminated, short-circuiting and thus extinguishing group 2. Consequently, LDR₂ is high-ohmic, so that group 3 lights up. This sequence of every other group lighting up continues until the last group is lighted.

When now the switch is closed, the last (low-ohmic) LDR short-circuits group 1 so that, sequentially, group 1 is extinguished, group 2 is lit up, and so forth. With the switch closed, this cycle of operations is repeated continuously. It follows as a matter of course that there should be an odd number of groups. At 220 V supply voltage, approximately 15 groups of four 6 V/50 mA lamps in series should be used.

LIGHT DEPENDENT RESISTORS

The light dependent resistors are virtually small photoconductive cells, provided with two tinned copper connecting leads.

Three versions are available differing mainly in shape and coating.

Electrical performance

dark value	R_D	$> 10 \text{ M}\Omega$ (measured after 30 min. in total darkness)
light value	R_L	75-300 Ω (measured at 1 000 lux)
recovery rate		$> 200 \text{ k}\Omega/\text{s}$ (i.e. the resistance rise per second at falling light intensity)
permissible voltage		150 V_{peak}
capacitance		$< 6 \text{ pF}$

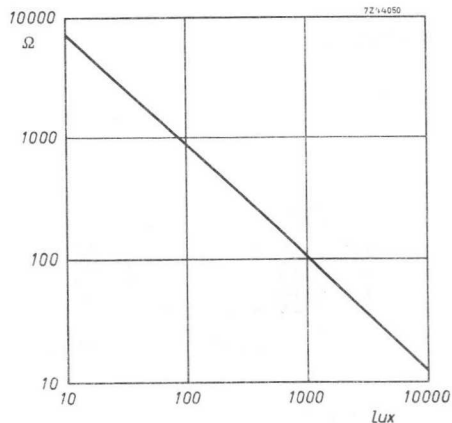

Resistance value as a function of light intensity

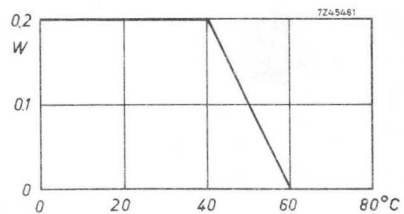

Permissible dissipation

Important: Soldering and handling instructions available on request.

Version 2322 600 95001

Encapsulated in plastic case and synthetic resin

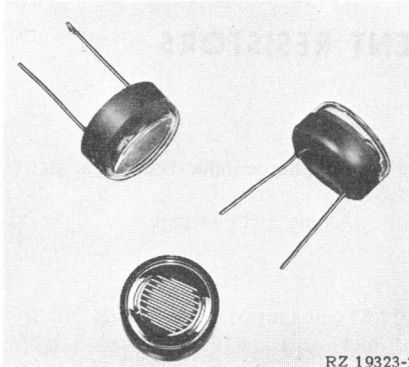

RZ 19323-2

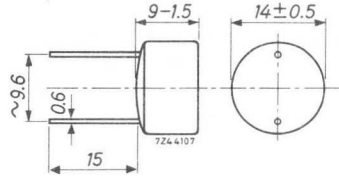

Ambient temperature range -20 to $+60$ °C

A special version with a lower light value is available under catalog number 2322 600 95006

Deviating characteristics $R_D > 1 \text{ M}\Omega$
 $R_L < 110 \Omega$

Version 2322 600 93001

This cell is sealed by means of a plastic coating

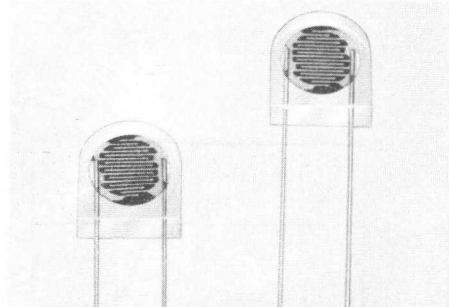

RZ 19225-1

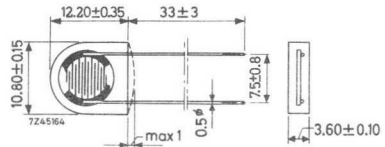

Ambient temperature range -30 to $+60$ °C

A special version with a lower light value is available under catalog number 2322 600 93002

Deviating characteristics $R_D > 1 \text{ M}\Omega$
 $R_L < 150 \Omega$

Note: Do not solder closer than 10 mm to the body.

Version 2322 600 94001

This cell is covered with lacquer.

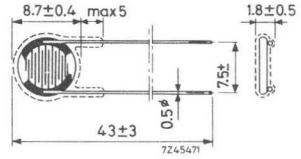
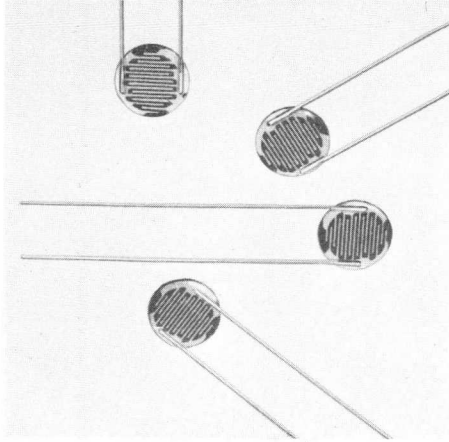

RZ 19225-3

Ambient temperature range -30 to $+60$ °C

1850

THE UNIVERSITY OF CHICAGO

1850

1850
1850
1850
1850
1850

Ceramic capacitors



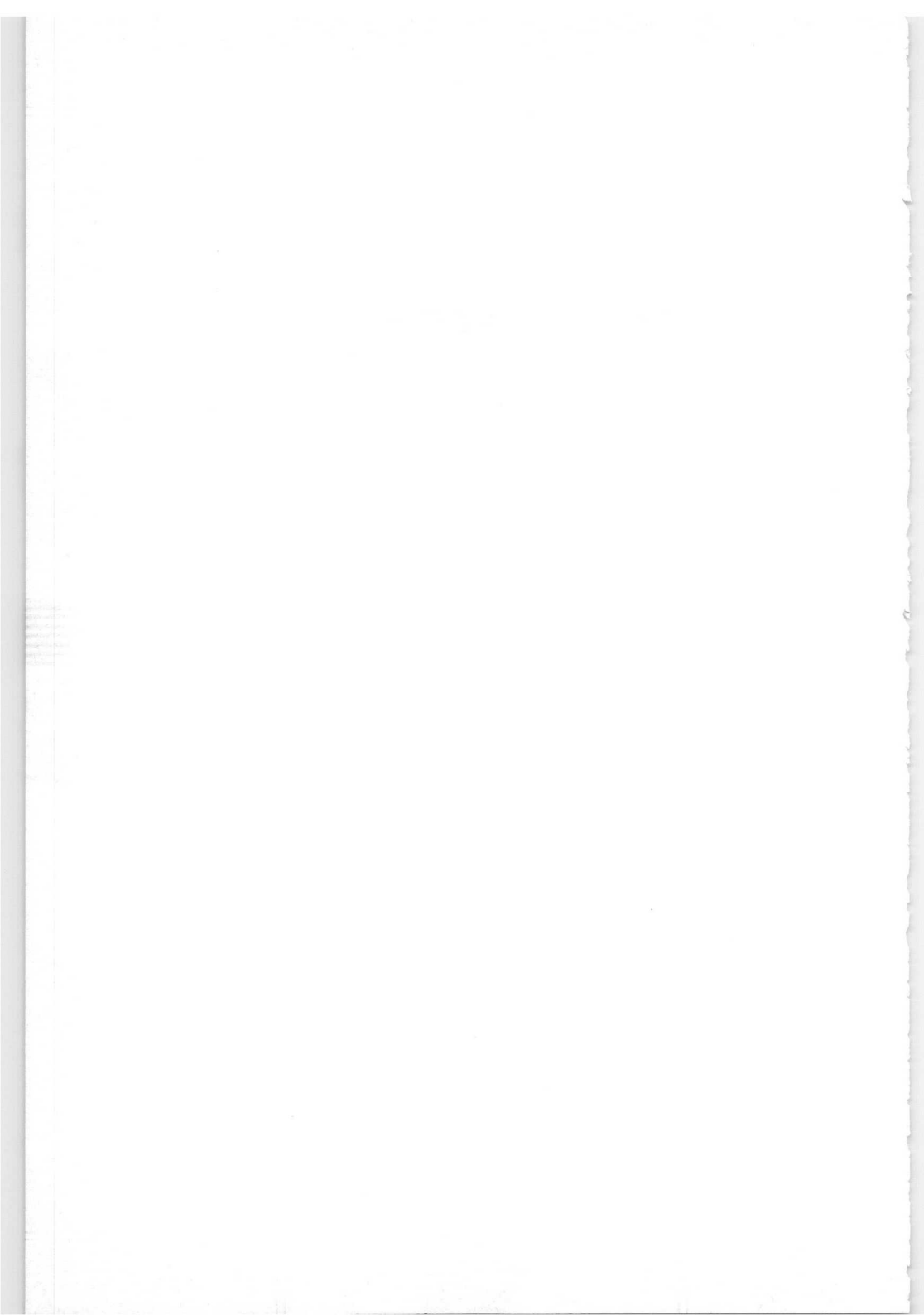



SURVEY

Application class 1 = for tuning and other applications where low losses and a linear temperature dependence are required.

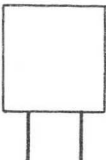
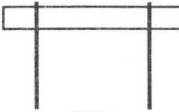
Application class 2 = for all coupling and decoupling purposes.

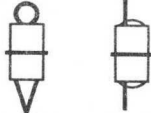
shape	application	capacitance range (pF)	rated voltage (V _{dc})	capacitor series 2222 ...  1)	page
	class 1	0,68- 560	63	631 632 638 (C333) 641 642	D41
	class 2	180- 4700 1 000- 22 000	100 40	630 (C332) 629 (C331)	D33 D33
	class 3	22 000-100 000	6	675 (C330)	D55
 7247541	class 1	0.8- 820	500	555 (C304)	D13
	class 2	680- 22 000 1 000- 10 000	500 500	552 (C301) 561 (C318)	D5 D5
	safety	10- 560	700	562 (C321)	D17
 7247542	class 2	1.5- 10 000 2 200- 10 000	500 125	563 (C322) 565 (C325)	D21 D21
	filter	3.9- 180	70 (a.c.)	553 (C302)	D9
 7247544	class 1	0.5- 33	500	625 626 (C306)	D27
	class 2	220- 1500	500	627 (C307)	D31
 7247545 7247546	class 1	2.5- 47	350	700 (C309)	D59
	class 2	68- 2 200	350	700 (C309)	D59
	class 2	2.5- 4 700	350	702 (C309)	D59

1) The number between brackets is the old series number.

MARKING

Colour code

	temperature coefficient	first digit	second digit	multiplier for the capacitance	tolerance on capacitance	
					$C \leq 10 \text{ pF}$ (pF)	$C > 10 \text{ pF}$ (%)
red/violet	P100					
black	NP0		0	1		± 20
brown	N033	1	1	10	± 0.1	± 1
red	N075	2	2	10^2	± 0.25	± 2
orange	N150	3	3	10^3		
yellow	N220	4	4	10^4		
green	N330	5	5		± 0.5	± 5
blue	N470	6	6			
violet	N750	7	7			
grey		8	8	10^{-2}		
white		9	9	10^{-1}	± 1	± 10

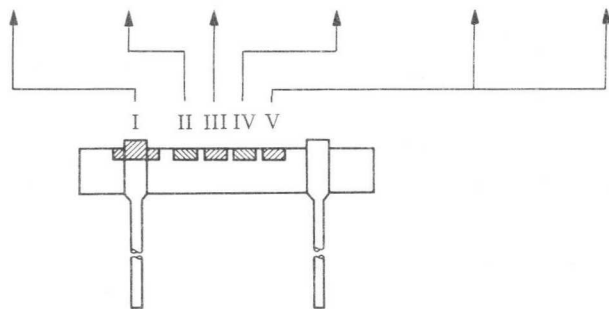
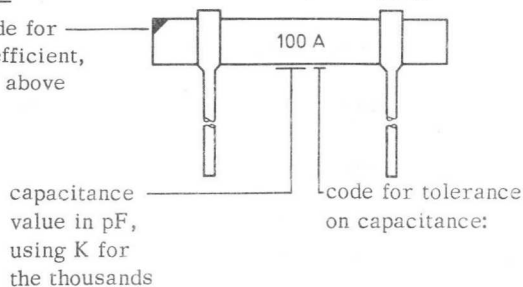

Figure code

colour code for temp. coefficient, see Table above



	$C \leq 10 \text{ pF}$	$C > 10 \text{ pF}$	
tol (pF)	code	tol (%)	code
0,25	N	1	D
0,5	L	2	C
1	M	5	B
		10	A

TUBULAR CERAMIC CAPACITORS CLASS II

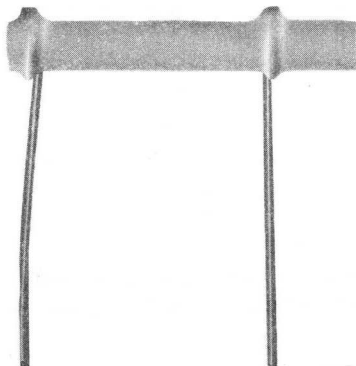

RZ 22070-5

Capacitance range 552-series
561-series
Maximum working voltage

680 to 22 000 pF (-20/+50 %)
1000 to 10 000 pF (± 10 %)
500 V_{dc}

APPLICATION

Class II tubular ceramic capacitors are made of high-K dielectric materials. They are suitable for bypass and coupling purposes in all kinds of equipment where a high capacitance and small dimensions are of importance and the losses need not be minimized. These capacitors can be supplied in the 552 and in the 561-series. If small dimensions are essential, preference is given to the former series, but if a linear temperature dependence is of greater importance, the latter series are recommended. The temperature dependence of the series 552 and 561 is illustrated by the Graphs 1 and 2 respectively, the latter of which conforms to the class IIA requirements.

CONSTRUCTION

The capacitors of both ranges consist of a ceramic tube, internally and partly externally covered with a fired-on coating of silver. Two leads of tinned copper, wound around the tube, are soldered to these coatings. A coating of special lacquer protects the non-insulated versions against atmospheric influences. The coating of the insulated versions allows them to be mounted close together or against a metal frame.

Dimensions in mm

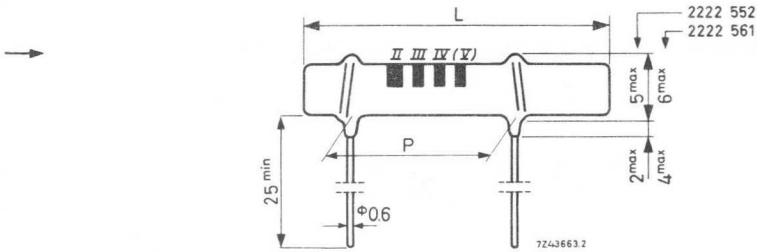

For L and P see Tables 1 and 2.

Marking. See Survey Ceramic Capacitors.

TECHNICAL PERFORMANCE

Unless otherwise specified, all electrical values apply to a temperature of 20 ± 5 °C, an atmospheric pressure of 930-1060 mbar and a relative humidity of $\leq 75\%$.

Max. working voltage	500 V _{dc}
Test voltage for 1 min	1250 V _{dc}
Test voltage against coating (insulated capacitors) for 1 s	750 V _{dc}
Insulation resistance at 500 V _{dc} (within 1 min) for C $\leq 10\,000$ pF	$> 10\,000$ M Ω
for C $> 10\,000$ pF	$> \frac{10\,000 \times 10^{10}}{C(\text{pF})} \Omega$
Losses (tan δ) at 1 kHz measured at a voltage of < 3.5 V _{ac}	$< 350 \times 10^{-4}$
Temperature dependence for 552-series	see Graph 1
for 561-series	see Graph 2
Working temperature range	-40 to +85 °C
Climatic robustness	category 40/085/21 (I.E.C. 68)

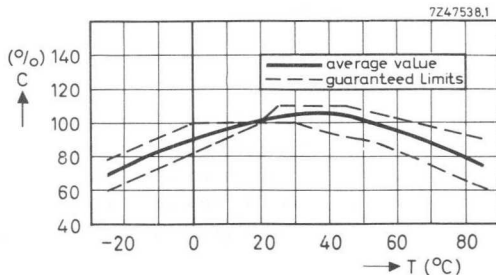

Graph 1

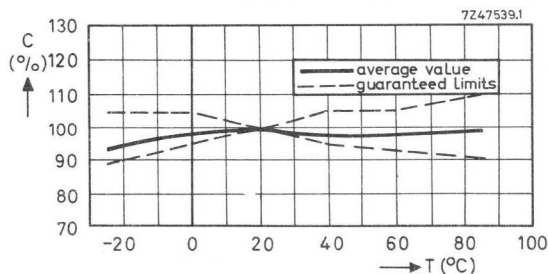

Graph 2

AVAILABLE VERSIONS

Composition of the catalog number

Class II series : 2222 552
suffix, see Table 1

Class IIA series: 2222 561
suffix, see Table 2

Capacitance and tolerance

The tables give the E6 capacitance series. Capacitance values out of the E12 series are subject to minimum order release requirements.

552-series, tolerance on the capacitance $-20/+50\%$

Table 1

capacitance (pF)	L (mm)	P (mm)	suffix (insulated)	suffix (non-insulated) ¹⁾
680	12	7.6	04681	03681
1 000	12	7.6	04102	03102
1 500	12	7.6	04152	03152
2 200	12	7.6	04222	03222
3 300	12	7.6	04332	03332
4 700	16	10.2	04472	03472
6 800	20	15.2	04682	03682
10 000	22	17.7	04103	03103
15 000	30	20.3	04153	03153
22 000	40	30.5	04223	03223

¹⁾ Available on request

2222 552**2222 561**TUBULAR CERAMIC CAPACITORS
CLASS II

(C301)

(C318)

561-series, tolerance on the capacitance $\pm 10\%$

Table 2

capacitance (pF)	L (mm)	P (mm)	suffix
1 000	12	7.6	01102
1 500	12	7.6	01152
2 200	14	7.6	01222
3 300	18	12.7	01332
4 700	22	17.7	01472
6 800	28	20.3	01682
10 000	38	30.5	01103

MIDGET TUBULAR CERAMIC CAPACITORS CLASS IC

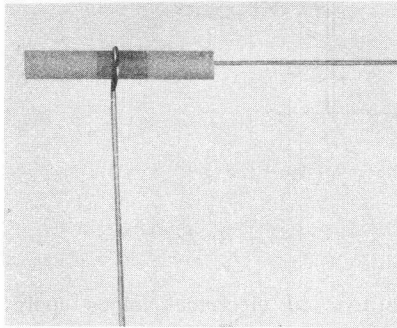

RZ 22070-15

Capacitance range
Maximum working voltage

3.9 to 180 pF
70 V_{ac}

APPLICATION

These midget-type ceramic capacitors are characterised by their low h.f. losses, high stability and a very low inductance. Therefore they are widely used in r.f. tuned circuits. The capacitors have been specially designed for use in small filters such as miniaturised i.f. transformers, bandpass filters for radio and television receivers, discriminators, noise limiters, etc.

CONSTRUCTION

The capacitors consist of a tiny ceramic tube, covered internally and externally with a fired-on silver electrode, each electrode being provided with a tinned copper connecting lead. The connecting leads can withstand a strain of at least 450 gram. The capacitors are colour-coded according to I.E.C. recommendations, except those having values of 3.9-8.2 pF and 39 pF, which are marked in black script.

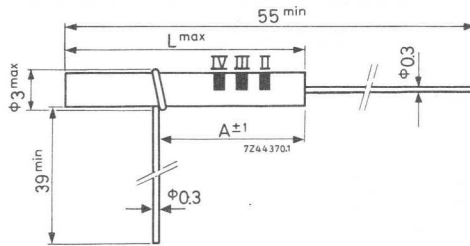
Dimensions in mm

For L and A see table.

TECHNICAL PERFORMANCE

Unless otherwise specified, all electrical values apply to a temperature of 20 ± 5 °C, an atmospheric pressure of 930-1060 mbar and a relative humidity of < 75 %.

Maximum working voltage at a frequency > 100 kHz	70 V _{ac}
Test voltage for 1 min	300 V _{dc}
Insulation resistance measured within 1 min at 100 V _{dc} at R.H. < 75 %	> 10 000 M Ω
at R.H. between 75 % and 95 %	> 100 M Ω
Losses at 1 MHz, measured at < 1 V _{ac}	
parallel damping for C < 10 pF	> 5 M Ω
tan δ for C \geq 10 pF	< 10 x 10 ⁻⁴
Change of capacitance after humidity test according to NT 14-5-3.1	< 1% or 0.5 pF
Working temperature range	-25 to +85 °C
Climatic robustness	category 25/085/04 (I.E.C. 68)

AVAILABLE VERSIONS

Catalog number 2222 553

suffix, see table.

capacitance			L	A	suffix
nom. (pF)	tol. (±)	temp. coeff. ($10^{-6}/\text{deg C}$)	(mm)	(mm)	
3.9	0.5 pF	+100	9	5	01398
4.7	0.5 pF	+100	9	5	01478
5.6	0.5 pF	+100	9	5	01568
6.8	1 pF	+100	9	5	02688
8.2	1 pF	+100	9	5	02828
10	1 pF	0	9	5	02109
12	1 pF	0	9	5	02129
15	1 pF	0	9	5	02159
18	1 pF	0	9	5	02189
22	1 pF	0	9	5	02229
27	1 pF	0	9	5	02279
33	3 %	-150	9	5	03339
39	3 %	-150	9	5	03399
47	3 %	-150	9	5	03479
56	3 %	-150	9	5	03569
68	3 %	-150	9	5	03689
82	3 %	-150	9	5	03829
100	3 %	-150	11	7	03101
120	3 %	-150	13.5	7	03121
150	3 %	-150	16.5	11	03151
180	3 %	-150	20	11	03181

1912

TUBULAR CERAMIC CAPACITORS CLASS 1B

QUICK REFERENCE DATA

Capacitance range	0.8 to 820 pF
Rated voltage	500 V d. c.
Tolerance on capacitance	5%, 0.5 or 0.25 pF
Temperature coefficients	NP0, N150, N750
Basic specification	IEC 108, class 1B
Category (IEC 68)	40/085/21

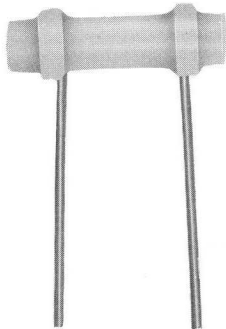

RZ 22070-1

APPLICATION

Because low-K ceramic material is used, these capacitors have low losses, a high stability and display a linear temperature dependence of the capacitance. These features render the capacitors ideally suited for application in high frequency equipment, especially in resonant circuits in which advantage can be taken of the linear temperature coefficient to compensate the temperature dependence of other components.

These capacitors have connecting leads of 0.6 mm diameter with a pitch of a multiple of one tenth of an inch, so that they are suitable for printed wiring circuits.

DESCRIPTION

The capacitors consist of a ceramic tube, partly metallised on the outside, and - except for the smallest capacitances - internally metallised. A coating of special grey lacquer protects the capacitors against atmospheric influences. The temperature coefficient, the capacitance and the tolerances are indicated by means of a colour or a figure code. The inner electrode is connected to the lead at the side of the colour dot for the temperature coefficient.

MECHANICAL DATA

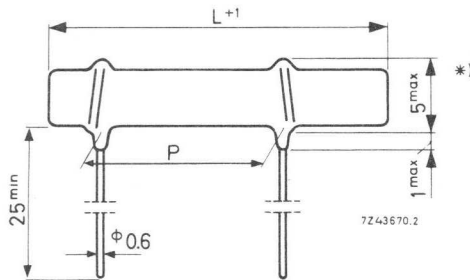
Dimensions in mmWeight

0.4 to 0.9 g, depending on the dimensions.

Marking

Colour coded or figure coded, see Survey Ceramic capacitors

Mounting

Soldering conditions max. 270°C , max. 10 s

$*)$ maximum 6 mm for capacitors of 2.7 and 3.3 pF.

ELECTRICAL DATA

The capacitors are in conformity with IEC 108.

Unless stated otherwise, all electrical values have been determined at a temperature of 20 ± 5 °C, an atmospheric pressure of 930 to 1060 mbar and a relative humidity of 45 to 75 %.

Cap. values and tolerances

measured at 1 MHz, < 5 V

see table II

Rated voltage

500 V d. c. *)

Test voltage for 1 min.

1250 V d. c.

Insulation resistance at 500 V d. c.

after 1 min.

> 10.000 MΩ

Tan δ at 1 MHz, < 5 V for $C \leq 10$ pF
for $C > 10$ pF

$\leq \frac{0.01}{C}$ (C in pF)
 $\leq 10^{-4} \times 10^{-4}$, average < 5×10^{-4}

Category temperature range

-40 to +85 °C

Climatic category (IEC 68)

40/085/21

Temperature coefficients (Table I)

temp. coeff. ($10^{-6}/\text{deg C}$)	tolerance ($10^{-6}/\text{deg C}$)
<u>NP0</u> : 0	for $C < 3$ pF: -40 to +250 for $3 < C \leq 20$ pF: -40 to +120 for $C > 20$ pF: ± 40
<u>N150</u> : -150	for $C \leq 20$ pF: -40 to +60 for $C > 20$ pF: ± 40
<u>N750</u> : -750	for $C < 3$ pF: ± 250 for $3 < C \leq 20$ pF: -120 to +250 for $C > 20$ pF: ± 120

Capacitors with a temperature coefficient according to P100, N033, N075, N220, N330, N470 and N1500 can be supplied, provided acceptable quantities are ordered.

Capacitance and tolerance

The following table gives the E12 capacitance series with a tolerance of 0.25 pF, 0.5 pF and 5 %, depending on the capacitance value. On request values appertaining to the E24 series can be supplied, provided acceptable quantities are ordered. This also applies to capacitors with tolerances of 20% of the E6 series, of 10% of the E12 series and with 2 % and 1 % tolerances for higher capacitance values.

*) If the capacitor is connected to an a. c. source, the r. m. s. current must not exceed 500 mA, whilst the maximum r. m. s. voltage is $\frac{500}{\sqrt{2}}$ volts.

Table II

capacitance		temperature coefficient								
		NPO			N150			N750		
nom. (pF)	tol. (±)	L (mm)	P (mm)	suffix	L (mm)	P (mm)	suffix	L (mm)	P (mm)	suffix
0.8	0.25 pF							12	7.6	57807
1	0.25 pF							12	7.6	57108
1.2	0.25 pF							12	7.6	57128
1.5	0.25 pF							12	7.6	57158
1.8	0.25 pF	12	7.6	09188				12	7.6	57188
2.2	0.25 pF	12	7.6	09228				12	7.6	57228
2.7	0.5 pF	12	7.6	08278				12	7.6	56278
3.3	0.5 pF	12	7.6	08338				12	7.6	56338
3.9	0.5 pF	12	7.6	08398				12	7.6	56398
4.7	0.5 pF	12	7.6	08478				12	7.6	56478
5.6	0.5 pF	12	7.6	08568	12	7.6	32568	12	7.6	56568
6.8	0.5 pF	12	7.6	08688	12	7.6	32688	12	7.6	56688
8.2	0.5 pF	10	5.1	08828	10	5.1	32828	10	5.1	56828
10	0.5 pF	10	5.1	08109	10	5.1	32109	10	5.1	56109
12	5 %	10	5.1	08129	10	5.1	32129	10	5.1	56129
15	5 %	10	5.1	08159	10	5.1	32159	10	5.1	56159
18	5 %	10	5.1	08189	10	5.1	32189	10	5.1	56189
22	5 %	10	5.1	08229	10	5.1	32229	10	5.1	56229
27	5 %	12	7.6	08279	12	7.6	32279	10	5.1	56279
33	5 %	12	7.6	08339	12	7.6	32339	10	5.1	56339
39	5 %	12	7.6	08399	12	7.6	32399	10	5.1	56399
47	5 %	14	7.6	08479	12	7.6	32479	10	5.1	56479
56	5 %	14	7.6	08569	14	7.6	32569	12	7.6	56569
68	5 %	16	10.2	08689	16	10.2	32689	12	7.6	56689
82	5 %	18	12.7	08829	16	10.2	32829	12	7.6	56829
100	5 %	20	15.2	08101	18	12.7	32101	12	7.6	56101
120	5 %	22	17.7	08121	20	15.2	32121	14	7.6	56121
150	5 %	26	20.3	08151	24	17.7	32151	16	10.2	56151
180	5 %	30	20.3	08181	26	20.3	32181	18	12.7	56181
220	5 %	34	25.4	08221	30	20.3	32221	20	15.2	56221
270	5 %				36	25.4	32271	22	17.7	56271
330	5 %							24	17.7	56331
390	5 %							28	20.3	56391
470	5 %							32	25.4	56471
560	5 %							38	30.5	56561
680	5 %							44	35.6	56681
820	5 %							52	40.6	56821

CATALOGUE NUMBER (for ordering) 2222 555 , for suffix see Table II

TUBULAR CERAMIC CAPACITORS SAFETY

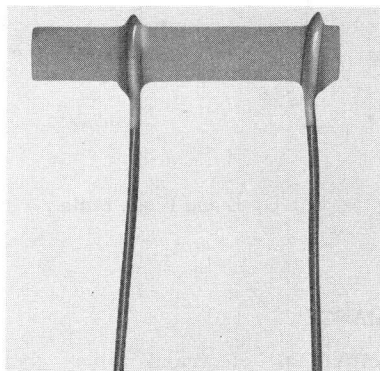

RZ 22070-2

Capacitance range	10 to 560 pF
Maximum working voltage	700 V _{dc}
Test voltage	2000 V _{rms}

APPLICATION

These ceramic capacitors withstand a test voltage of 2000 V_{rms} for 1 minute, the international requirement for capacitors connected between the mains and conductive parts which might be touched. Therefore, they are very suitable for use in radio and television sets.

CONSTRUCTION

The capacitor consists of a ceramic tube internally and partly externally covered with a fired-on coating of silver. The connecting leads are soldered to the silver electrodes. A coating of special grey lacquer protects the capacitors against atmospheric influences. The capacitors are marked in black script with an H followed by capacitance value in pF and a letter indicating the tolerance (see Survey Ceramic capacitors).

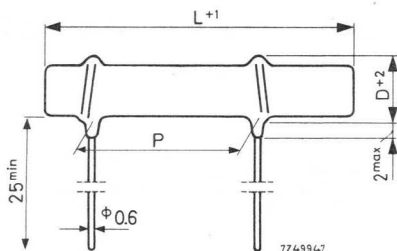

For D, L and P see table

TECHNICAL PERFORMANCE

Unless otherwise specified, all electrical values apply to a temperature of 20 ± 5 °C, an atmospheric pressure of 930-1060 mbar and a relative humidity of ≤ 75 %.

Maximum working voltage	700 V _{dc}
Test voltage for 1 min	2000 V _{rms}
Insulation resistance measured at 500 V _{dc} (within 1 min)	> 50 000 MΩ
Losses (tan δ) at 1 MHz, measured at a voltage < 3.5 V _{ac}	< 10×10^{-4}
Working temperature range	-40 to +85 °C
Climatic robustness	category 40/085/21 (I.E.C. 68)

AVAILABLE VERSIONS

Composition of the catalog number

2222 562
suffix, see Table

Capacitance and toleranceThe tolerance on the capacitances is $\pm 10\%$.

capacitance (pF)	dimensions			suffix
	D (mm)	L (mm)	P (mm)	
10	3	18	10.2	01109
12	3	18	10.2	01129
15	3	18	10.2	01159
18	3	18	10.2	01189
22	3	18	10.2	01229
27	3	18	10.2	01279
33	3	18	10.2	01339
39	3	18	10.2	01399
47	3	18	10.2	01479
56	4	18	10.2	01569
68	4	18	10.2	01689
82	4	18	10.2	01829
100	4	20	10.2	01101
120	4	20	10.2	01121
150	4	22	12.7	01151
180	4	24	12.7	01181
220	4	28	17.7	01221
270	4	32	20.3	01271
330	4	36	25.4	01331
390	4	40	30.5	01391
470	4	46	35.6	01471
560	4	52	40.6	01561

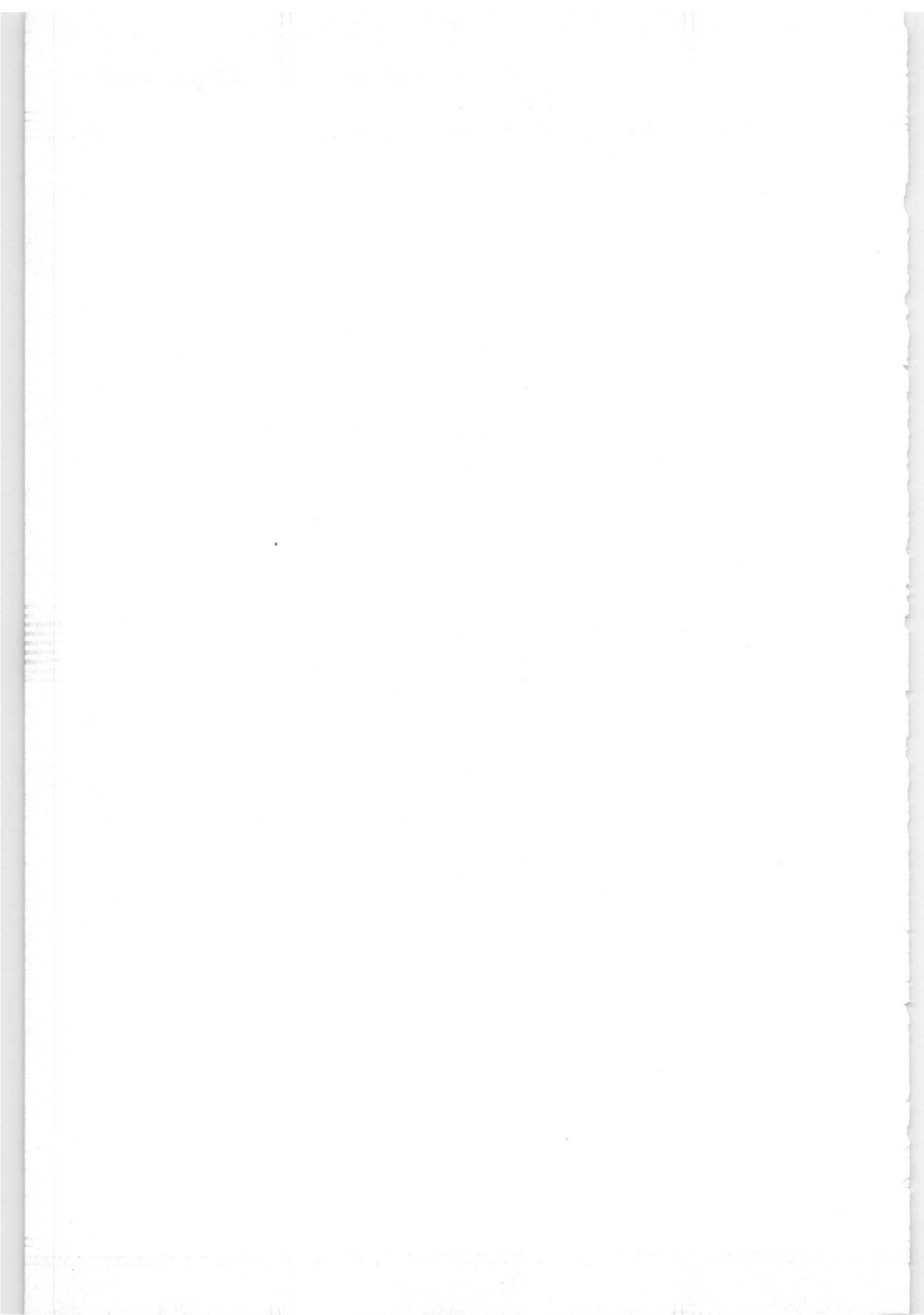

UPRIGHT-MOUNTING CERAMIC CAPACITORS CLASS II

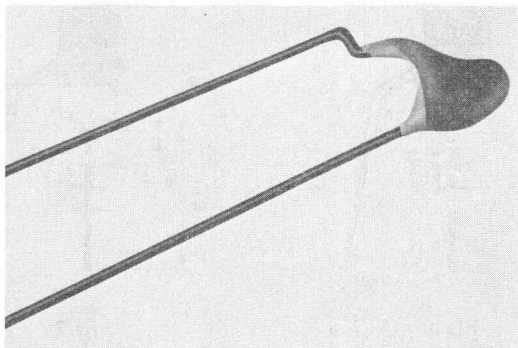

RZ 22070-12

563-series: Capacitance range	1.5 to 10 000 pF
Max. working voltage	500 V _{dc}
565-series: Capacitance range	2200 to 10 000 pF
Max. working voltage	125 V _{dc}

APPLICATION

These ceramic capacitors are suitable for bypass, coupling and general purposes, where low losses and high stability of capacitance are not of major importance. They feature a high insulation resistance and a low inductance. The configuration of the terminals is adapted to the printed wiring technique; when mounted in a vertical position, the capacitors occupy a small area.

The 565-series of capacitors have been designed for application where high voltages are not required, e.g. transistor equipment.

CONSTRUCTION

The capacitor consists of an internally and externally fully metallised ceramic tube. The connecting leads are of tinned copper, soldered to the metal layers. The capacitors are coated with a tan-coloured insulation lacquer, which acts as a seal against moisture and mechanical damage, and permits the capacitors to be mounted close together, or against a metal plate. The capacitors are colour coded.

Dimensions in mm

563-series

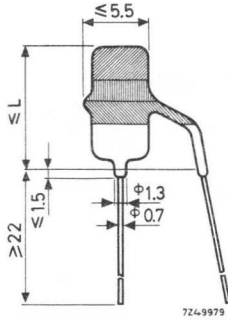

Fig. 1

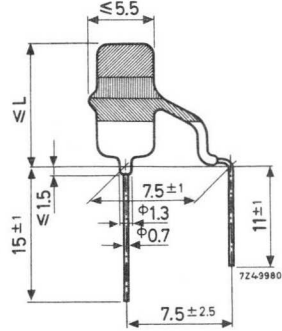

Fig. 2

565-series

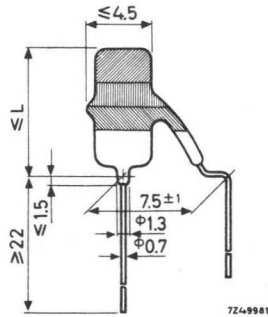

Fig. 3

(C322)
(C325)

UPRIGHT-MOUNTING CERAMIC
CAPACITORS - CLASS II

2222 563
2222 565

TECHNICAL PERFORMANCE

Unless otherwise specified, all electrical values apply to a temperature of 20 ± 5 °C, at atmospheric pressure of 930-1060 mbar and a relative humidity of ≤ 75 %.

	<u>563-series</u>	<u>565-series</u>
Maximum working voltage	500 V _{dc}	125 V _{dc}
Test voltage for 1 min	1250 V _{dc}	375 V _{dc}
Test voltage against coating for 1 min	1250 V _{dc}	1250 V _{dc}
Insulation resistance at 500 V _{dc} (within 1 min)	> 10 000 MΩ	
Insulation resistance at 100 V _{dc} (within 1 min)		
for C < 2500 pF		> 10 000 MΩ
for C > 2500 pF		> $\frac{2500 \times 10\,000}{C \text{ (pF)}} \text{ M}\Omega$
Losses measured at < 3.5 V		
for C \leq 10 pF, parallel damping at 100 kHz	> 5 MΩ	
for C = 10 to 180 pF, tan δ at 100 kHz	see Table I	
for C > 200 pF, tan δ at 1 kHz	see Table I	< 350 · 10 ⁻⁴
Temperature dependence from -25 to +85 °C	see Table I	+30 to -50 %
Working temperature range	-40 to +85 °C	-25 to +85 °C
Climatic robustness, I.E.C. 68 category	40/085/21	25/085/21

2222 563
2222 565

UPRIGHT-MOUNTING CERAMIC
 CAPACITORS - CLASS II

(C322)
 (C325)

AVAILABLE VERSIONS

563-series (500 V)

Catalog number 2222 563
 suffix, see Table I.

Table I

capacitance (pF)	tolerance	L (mm)	$\tan \delta$ ($\times 10^{-4}$)	$\frac{\Delta C}{C} = f(T)$	suffix of Fig.1 versions	suffix of Fig.2 versions	
1.5	1 pF	6.5			01158	05158	
2		8.5			01208	05208	
3		8.5			01308	05308	
4		6.5			01408	05408	
5		8.0			01508	05508	
6		7.5			01608	05608	
7		8.5			±10 %	01708	05708
8		9.0			01808	05808	
9		6.5			01908	05908	
10		7.0			01109	05109	
15	20 %	9.0	25		02159	06159	
22		7.5			02229	06229	
33		8.5			02339	06339	
47		6.5			02479	06479	
68		7.0			02689	06689	
100		9.0			100	02101	06101
150		7.5			+15/-25 %	02151	06151
220		8.0				02221	06221
330		11.0				02331	06331
470		8.0				02471	06471
680	8.5	02681	06681				
1 000	8.0	350	03102	07102			
1 500	9.0		03152	07152			
2 200	12.0		03222	07222			
3 300	-20/+50 %		15.0	+15/-40 %		03332	07332
4 700	19.0		03472	07472			
6 800	23.0		03682	07682			
10 000	29.0		03103	07103			

Capacitance values of the E12 series are subject to minimum order release requirements.

(C322)
(C325)

UPRIGHT-MOUNTING CERAMIC
CAPACITORS - CLASS II

2222 563
2222 565

565-series (125 V)

Catalog number 2222 565
suffix, see Table II

Table II

capacitance (pF)	tolerance	L (mm)	suffix of Fig.3 versions
2 200	-20/+50 %	8	02222
3 300		9	02332
4 700		9.5	02472
6 800		12	02682
10 000		16.5	02103

Capacitance values of the E12 series are subject to minimum order release requirements.

1890

1891

1892

1893

1894

1895

1896

1897

1898

1899

1900

1901

1902

1903

1904

1905

1906

1907

1908

1909

1910

1911

1912

1913

1914

1915

1916

1917

1918

1919

1920

1921

1922

1923

1924

1925

1926

1927

1928

1929

1930

1931

1932

1933

1934

1935

1936

1937

DISC TYPE CERAMIC CAPACITORS CLASS 1B

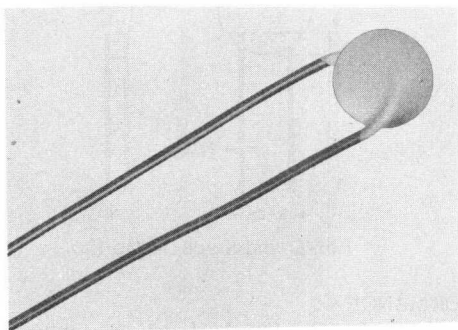

RZ 22070-9

Capacitance range	0.47 to 33 pF
Maximum working voltage	500 V _{dc}

APPLICATION

Because low-K ceramic material is used, these capacitors have low losses, a high stability and display a linear temperature dependence of the capacitance. These features render the capacitors ideally suited for application in high frequency equipment, especially in resonant circuits in which advantage can be taken of the linear temperature coefficient to compensate the temperature dependence of other components.

CONSTRUCTION

The capacitor consists of a ceramic disc, provided with a silver plating at both sides to which the connecting leads are soldered. In order to avoid lacquer on the leads the capacitor is only partly lacquered, after which the whole is covered with a solderable film which protects the unlacquered part against atmospheric influences.

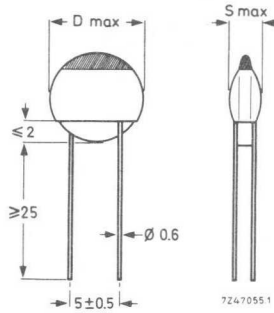
Dimensions in mm

For D and S see Table II.

TECHNICAL PERFORMANCE

Unless otherwise specified, all electrical values apply to a temperature of 20 ± 5 °C, an atmospheric pressure of 930-1060 mbar and a relative humidity of < 75 %.

Maximum working voltage	500 V _{dc}
Test voltage for 1 min	1250 V _{dc}
Insulation resistance at 500 V _{dc} (within 1 min)	> 10 000 MΩ
Losses (tan δ) at 1 MHz, measured at a voltage of < 3.5 V _{ac} for C < 10 pF	$< \frac{0.01}{C \text{ (pF)}}$
for C > 10 pF	$< 10 \times 10^{-4}$
Working temperature range	-40 to +85 °C
Climatic robustness	category 40/085/21 (I.E.C. 68)
Capacitance and tolerances	see Table II

AVAILABLE VERSIONSComposition of the catalog number

Non-insulated versions: 2222 625

Insulated versions: 2222 626 (available on request)
suffix, see Table II

Temperature coefficients (Table I)

temp. coeff. ($10^{-6}/\text{deg C}$)	tolerance ($10^{-6}/\text{deg C}$)	t.c. marking colour
<u>P100</u> : +100	-40 to +120	red/violet
<u>NP0</u> : 0	for $C \leq 20$ pF: -40 to +120 for $C > 20$ pF: -40 to +40	black
<u>N150</u> : -150	for $C \leq 20$ pF: -40 to +60 for $C > 20$ pF: -40 to +40	orange
<u>N750</u> : -750	for $C \leq 20$ pF: -120 to +250 for $C > 20$ pF: -120 to +120	violet

Capacitors with temperature coefficients according to N075, N220, N470 and N1500 can be supplied, provided acceptable quantities are ordered.



Capacitances and tolerances (Table II)

capacitance		temperature coefficient											
		P100			NPO			N150			N750		
nom. (pF)	tol. (±)	Dmax (mm)	Smax (mm)	suffix	Dmax (mm)	Smax (mm)	suffix	Dmax (mm)	Smax (mm)	suffix	Dmax (mm)	Smax (mm)	suffix
0.47	0.25 pF	5	4.5	03507	5	3.5	09188	5	5	33228	5	5	57188
0.75	0.25 pF	5	3.5	03757	6	3.5	09228	5	5	32278	5	4.5	57228
1.0	0.25 pF	6	3	03108	5	4	08278	5	4	32338	5	4	56278
1.2	0.25 pF	5	4	03128	5	3.5	08338	5	4	32398	6	4	56338
1.5	0.25 pF	5	3.5	03158	6	4	08398	5	3.5	32478	6	3.5	56398
1.8	0.25 pF	5	3.5	03188	6	3.5	08478	6	3	32568	6	3	56478
2.2	0.25 pF	6	3.5	03228	6	3	08568	6	3	32688	5	4	56568
2.7	0.5 pF	6	3	02278	6	3	08688	6	3	32828	5	3.5	56688
3.3	0.5 pF	6	3	02338	6	3	08828	6	3	32109	5	3	56828
3.9	0.5 pF	6	3	02398	8	3	08109	6	3	32129	6	3.5	56109
4.7	0.5 pF	8	3	02478	8	3	08129	8	3	32159	6	3	56129
5.6	0.5 pF	8	3	02568	8	3	08159	8	3	32189	6	3	56159
6.8	0.5 pF	8	3					8	3		6	3	56189
8.2	0.5 pF										6	3	56229
10	0.5 pF										8	3	56279
12	5 %										8	3	56339
15	5 %												
18	5 %												
22	5 %												
27	5 %												
33	5 %												

DISC TYPE CERAMIC CAPACITORS CLASS II

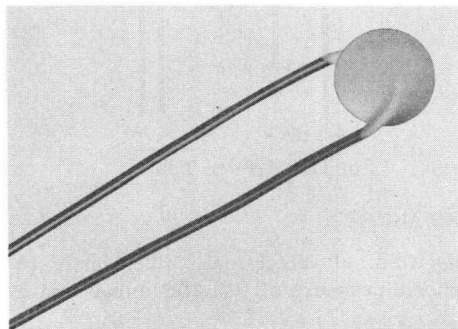

RZ 22070-9

Capacitance range	100 to 1500 pF
Maximum working voltage	500 V _{dc}

APPLICATION

These capacitors are suitable for coupling and decoupling where a low self-inductance and a high insulation resistance are required. They occupy only a minor area on printed-wiring boards.

CONSTRUCTION

The capacitor consists of a ceramic disc, provided with a silver plating at both sides to which the connecting leads are soldered. In order to avoid lacquer on the leads the capacitor is only partly lacquered, after which the whole is covered with a solderable film which protects the unlacquered part against atmospheric influences.

Dimensions in mm

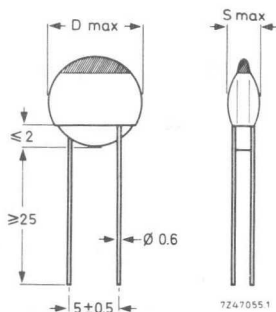

For D and S see Table.

TECHNICAL PERFORMANCE

Unless otherwise specified, all electrical values apply to a temperature of 20 ± 5 °C, an atmospheric pressure of 930-1060 mbar and a relative humidity of < 75 %.

Maximum working voltage	500 V _{dc}
Test voltage for 1 min	1250 V _{dc}
Insulation resistance at 500 V _{dc} (within 1 min)	> 10 000 MΩ
Losses (tan δ) at 1 kHz, measured at < 3.5 V _{ac}	< 350 · 10 ⁻⁴
Working temperature range	-40 to +85 °C
Climatic robustness	category 40/085/21 (I.E.C. 68)

AVAILABLE VERSIONS

Catalog number 2222 627
suffix, see Table

capacitance (pF)	tolerance (%)	Dmax (mm)	Smax (mm)	suffix
100	-20/+50	5	4.5	14101
150		5	3.5	14151
220		6	3.5	14221
330		6	3	14331
470		6	3	14471
680		6	3	14681
1000		8	3	14102
1500		9	3	14152

MINIATURE CERAMIC PLATE CAPACITORS CLASS 2 High-K types

QUICK REFERENCE DATA

	2222 630-series	2222 629-series
Capacitance range	180-4700 pF E12-series	1000-22000 pF E3-series
Rated voltage	100 V d. c.	40 V d. c.
Tolerance on capacitance	10 %	-20/+100 %
Basic specification	IEC187, class 2	IEC187, class 2
Category (IEC 68)	55/085/21	10/055/21

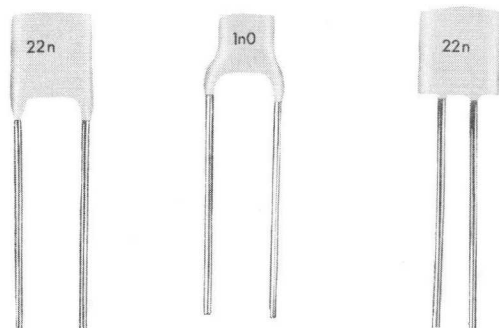

RZ 25596-8

APPLICATION

For use in a wide variety of electronic equipment where a non-linear change of the capacitance with temperature is permissible and low losses are not of major importance, e. g. for coupling and decoupling purposes.

DESCRIPTION

The capacitors consist of a thin rectangular plate of high-K ceramic material, both sides being metallised and provided with connecting leads. They are insulated by a coating method that ensures an excellent behaviour under humid conditions. The capacitors are tan coloured.

Because of their high dielectric constants these capacitors combine high capacitances with small dimensions.

The high stability capacitors of the 630-series belong to class 2A, which means a very small non-linear temperature dependence of the capacitances. The capacitance of the 629-series varies less linearly with temperature (class 2); however, these capacitors have a higher capacitance value than those of the 630-series at the same dimensions.

Due to the absence of silver an extremely good d. c. behaviour has been obtained*).

Mechanically the capacitors distinguish themselves by small dimensions, narrow tolerances on the lead spacing and very little and well defined lacquer on the leads.

MECHANICAL DATA

The capacitors are available in five versions:

lead spacing	lead length L	lead dia	Fig.	catalogue number
5.08 (0.2 in)	≥ 15	0.6 (0.024 in)	1	2222 629 03... 2222 630 03...
5.08 (0.2 in)	6^{-2}	0.6 (0.024 in)	1	2222 629 06... 2222 630 06...
2.54 (0.1 in)	≥ 15	0.6 (0.024 in)	2	2222 629 01... 2222 630 01...
2.54 (0.1 in)	6^{-2}	0.6 (0.024 in)	2	2222 629 05... 2222 630 05...
2.54 (0.1 in)	≥ 15	0.4 (0.016 in)**)	3	2222 629 02... 2222 630 02...

Dimensions in mm

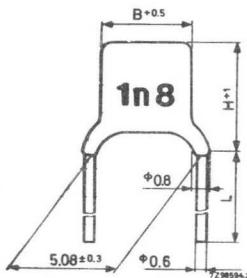

Fig. 1

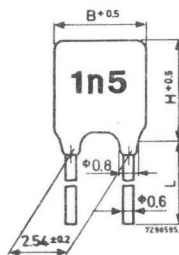

Fig. 2

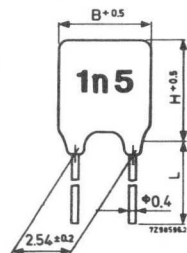

Fig. 3

*) Capacitors with silver electrodes suffer from the "silver migration" effect. Silver particles move from one electrode to the other under the influence of a d. c. voltage and moisture. Capacitors with silver electrodes are considerably larger.

***) Flexible leads

(C331)
(C332)

MINIATURE CERAMIC PLATE
CAPACITORS
CLASS II

2222 629
2222 630

size	BxH (mm)		BxH (inches)		approx. weight (g)
	Fig. 1	Figs. 2 and 3	Fig. 1	Figs. 2 and 3	
I	6x5	3x4	0.24x0.20	0.12x0.16	0.14
II	6x6	4x5	0.24x0.24	0.16x0.20	0.15
III	6x7	5x6	0.24x0.28	0.20x0.24	0.17
IV	6x8	6x7	0.24x0.32	0.24x0.28	0.19

The thickness of the capacitors does not exceed 2.1 mm (0.08 in), except for a few types as is indicated in Table 1.

Lacquer on the leads

When capacitors shown in Fig. 1 and 2 are mounted on printed-wiring boards with a thickness of 1.5 mm and with holes of 1.3 mm diameter or on printed-wiring boards with a thickness of 1 mm and with holes of 0.8 mm diameter, there will be no lacquer on the leads at the lower side of the board.

Marking

The capacitance value is indicated in black script according to table 1 and 2.

Mounting

When bending, cutting or flattening the leads, one should relieve them of the applied load at the capacitor body.

Soldering conditions max. 250 °C, max 5 s

ELECTRICAL DATA

Capacitors 2222 630

The capacitors are in conformity with IEC 187.

Unless stated otherwise all electrical values have been determined at a temperature of 20 ± 5 °C, an atmospheric pressure of 930 to 1060 mbar and a relative humidity of 45 to 75%.

Capacitance values,

measured at 1 kHz, < 1.5 V

180 - 4700 pF, E12 series (see Table 1)

Tolerance on the capacitance

$\pm 10\%$

Rated voltage

100 V d.c.

Test voltage for 1 min

300 V d.c.

Test voltage of coating for 1 min

300 V d.c.

Insulation resistance at 100 V d.c.

after 1 min

$> 1000 M\Omega$

Tan δ at 1 kHz, < 1.5 V

$< 350 \cdot 10^{-4}$

Maximum voltage dependence of the capacitance between 0 and 4) V

-5%

Category temperature range

-55 to +85 °C

Climatic category (IEC68)

55/085/21

Capacitance change versus temperature

see Fig. 4

Table 1

cap. (pF)	size	marking	catalogue number		
			0.4 mm leads 2.54 mm spacing	0.6 mm leads 2.54 mm spacing	0.6 mm leads 5.08 mm spacing
180 ^{*)}	I	n18	2222 630 02181	2222 630 01181	2222 630 03181
220 ^{*)}	I	n22	02221	01221	03221
270	I	n27	02271	01271	03271
330	I	n33	02331	01331	03331
390	I	n39	02391	01391	03391
470	I	n47	02471	01471	03471
560	I	n56	02561	01561	03561
680	I	n68	02681	01681	03681
820	I	n82	02821	01821	03821
1000	II	1n0	02102	01102	03102
1200	II	1n2	02122	01122	03122
1500	II	1n5	02152	01152	03152
1800	II	1n8	02182	01182	03182
2200	III	2n2	02222	01222	03222
2700	III	2n7	02272	01272	03272
3300	IV	3n3	02332	01332	03332
3900	IV	3n9	02392	01392	03392
4700	IV	4n7	02472	01472	03472

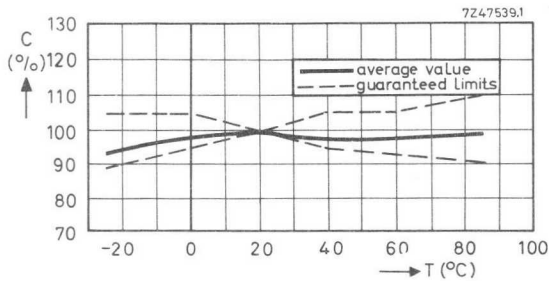

Fig.4. Capacitance-temperature curve of the capacitors of the 630-series.

*) maximum thickness 2.5 mm (0.1 in)

(C331)
(C332)

MINIATURE CERAMIC PLATE
CAPACITORS
CLASS II

2222 629
2222 630

Capacitors 2222 629

The capacitors are in conformity with the IEC publ. 187.

Unless otherwise specified all electrical values apply to a temperature of 20 ± 5 °C, an atmospheric pressure of 930-1060 mbar and a relative humidity $\leq 75\%$.

Capacitance values	1000 - 22 000 pF (See table 2) ; E3 series. All capacitances are measured at 1 kHz, with a voltage < 1.5 V a. c.
Tolerance on the capacitance	-20 to +100%
Rated voltage	40 V d. c.
Test voltage for 1 min	120 V d. c.
Test voltage of coating for 1 min	120 V d. c.
Insulation resistance at 10 V d. c. after 1 min	> 1000 M Ω
Tan δ at 1 kHz, measured at < 1.5 V a. c.	$< 350 \cdot 10^{-4}$
Category temperature range	-10 to +55 °C
Storage temperature range	-40 to +55 °C
Climatic category (IEC68)	10/055/21
Capacitance change versus temperature	see Fig. 5

Table 2

cap. (pF)	size	marking	catalogue number		
			0.4 mm leads 2.54 mm spacing	0.6 mm leads 2.54 mm spacing	0.6 mm leads 5.08 mm spacing
1000	I	1n0	2222 629 02102	2222 629 01102	2222 629 03102
2200	I	2n2	02222	01222	03222
4700	I	4n7	02472	01472	03472
10000	II	10n	02103	01103	03103
22000	IV	22n	02223	01223	03223

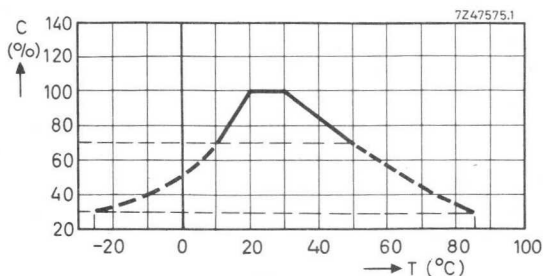

Fig. 5

Capacitance-temperature curve of the capacitors of the 629-series. The capacitances will be higher than or equal to the curve given for +10 up to +55 °C. The dotted lines give an indication of the behaviour at higher and lower temperatures.

PACKAGING 500 pieces per box

QUALITY CONTROL AND TEST SPECIFICATIONS

After manufacturing each capacitor is checked on the following electrical characteristics:

- capacitance
- loss factor
- test voltage

Apart from this several other quality checks are carried out by frequent inspections. Due to the construction and the carefully controlled manufacturing process these ceramic capacitors are capable of withstanding severe climate and electrical tests. The aforementioned tests conform with the recommendations laid down by I.E.C. 68-2.

Some of the more important tests and parameters are described below.

Life test

The capacitors shall withstand a 1000 hours life test at a voltage of 1.5 times nominal voltage at 85 °C. After the test the capacitance change shall not be more than $\pm 10\%$ for capacitors of class II A and $\pm 20\%$ for capacitors of class II compared with pre-test value, the loss factor shall not be more than 1.5 times the initial requirements, and the insulation resistance shall not be less than 300 M Ω .

Humidity test

The capacitors shall withstand a damp heat test for 21 days at a relative humidity of 95% and an ambient temperature of 40 °C with or without nominal voltage applied. After the test the capacitance change shall not be more than $\pm 10\%$ for capacitors of class II A and $\pm 20\%$ for capacitors of class II compared with pre-test value, the loss factor shall not be more than 2 times the initial requirements and the insulation resistance shall not be less than 100 M Ω .

Temperature change test

The class IIA capacitors shall withstand a temperature cycle 3 hours at 85 °C and 3 hours at -40 °C temperature being changed between 2 and 3 minutes. After the test the capacitance change shall not be more than $\pm 10\%$ compared with pre-test value. The class II capacitors shall withstand a temperature cycle 3 hours at 55 °C and 3 hours at -10 °C temperature being changed between 2 and 3 minutes. After the test the capacitance change shall not be more than $\pm 20\%$ compared with pre-test value. The loss factor shall not be more than 2 times the initial requirements and the insulation resistance shall not be less than 100 M Ω .

Bend-pull test

The capacitors shall withstand a bend-pull test consisting of 1 cycle of 4 bends of 90° with a weight of 250 gram. During test the capacitors are mounted on a board of resin bonded paper with a thickness of 1.0 mm and holes of 0.8 mm diameter.

(C331)
(C332)

MINIATURE CERAMIC PLATE
CAPACITORS
CLASS II

2222 629
2222 630

Vibration test

The capacitors shall withstand a 6 hours vibration test. In three directions 120 cycles of 1 minute vibration with an amplitude of 0.75 mm are applied. During each cycle the frequency changes from 10 to 55 to 10 Hz.

Vacuum test

The capacitors shall withstand a low pressure of 85 mbar during at least 2 minutes.



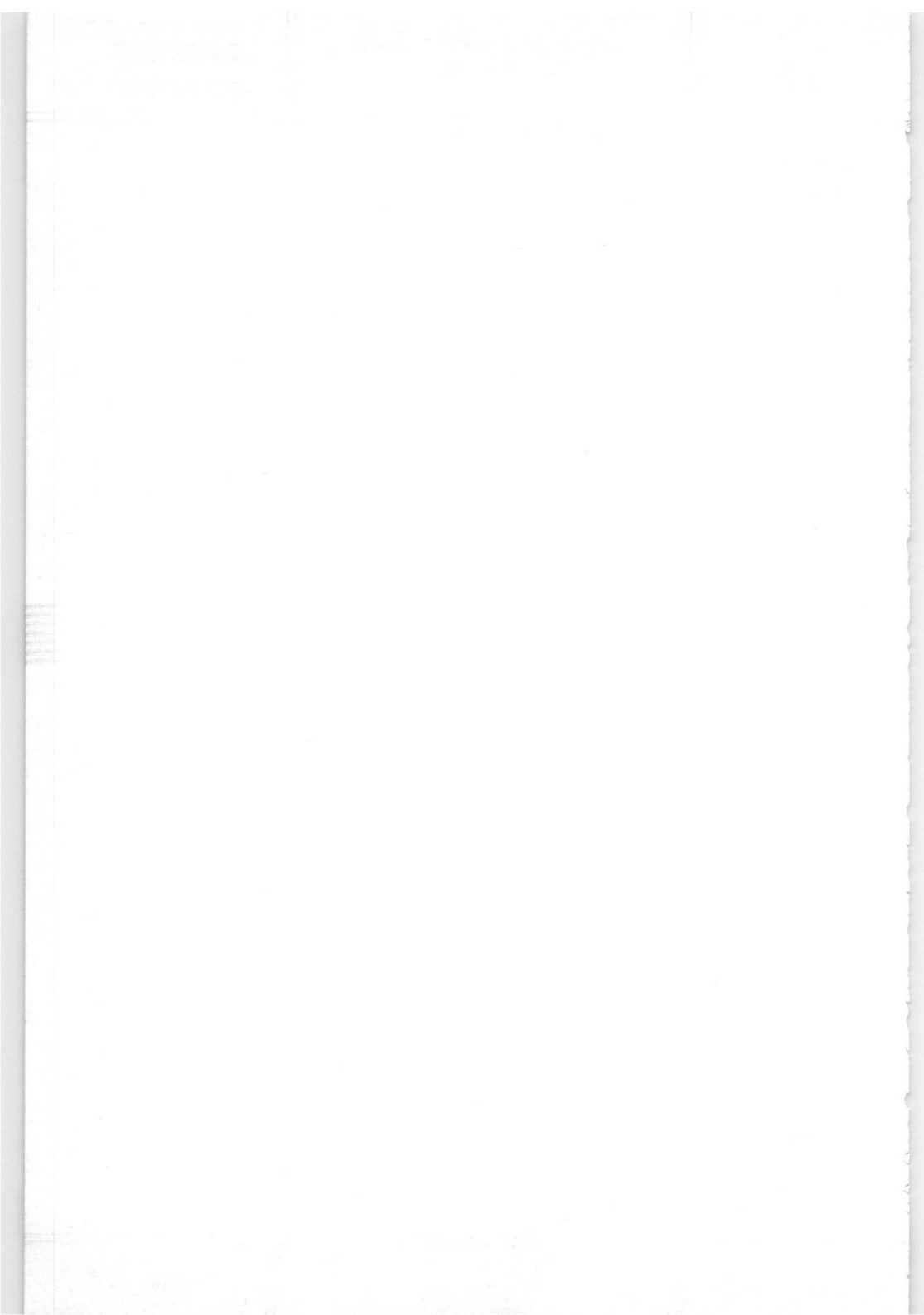

MINIATURE CERAMIC PLATE CAPACITORS CLASS 1B Temperature compensating types

QUICK REFERENCE DATA

Capacitance range	0.68 to 560 pF (E12 series)
Rated voltage	63 V d.c.
Tolerance on capacitance	2% or 0.25 pF
Temperature coefficients	P100, NP0, N075, N150, N220 N330, N470, N750, N1500
Basic specification	IEC 108, class 1B
Category (IEC publ. 68)	55/085/21

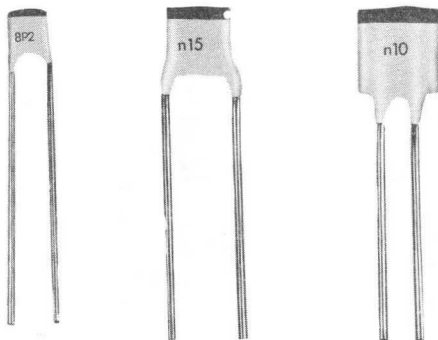

RZ 25596-7

APPLICATION

In a wide variety of electronic equipment, e.g. as temperature compensating capacitors in tuning circuits and filters, as coupling and decoupling capacitors in high-frequency circuits where low losses and good d.c. behaviour are required. Their small dimensions are an advantage in all cases where space-saving is important.

DESCRIPTION

The capacitors consist of a thin rectangular ceramic plate, both sides being metalised and provided with connecting leads. They are insulated by a coating method that ensures an excellent behaviour under humid conditions.

The colour of the capacitor body is grey.

The capacitors distinguish themselves by small dimensions, narrow tolerances on the lead spacing and very little and well defined lacquer on the leads. The electrical properties are characterised by low losses, a very close standard tolerance on the capacitance (± 0.25 pF or 2 %), high stability and, owing to the absence of silver, an extremely good d.c. behaviour*).

MECHANICAL DATA

The capacitors are available in five versions:

lead spacing	lead length L	lead diameter	Fig.	catalogue number
5.08 (0.2 in)	≥ 15	0.6 (0.024 in)	1	2222 638
5.08 (0.2 in)	6-2	0.6 (0.024 in)	1	2222 642
2.54 (0.1 in)	≥ 15	0.6 (0.024 in)	2	2222 631
2.54 (0.1 in)	6-2	0.6 (0.024 in)	2	2222 641
2.54 (0.1 in)	≥ 15	0.4 (0.016 in)**)	3	2222 632

Dimensions in mm

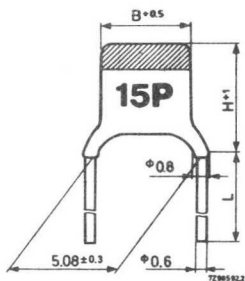

Fig. 1

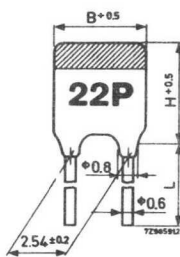

Fig. 2

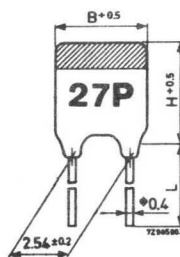

Fig. 3

*) Capacitors with silver electrodes suffer from the "silver migration" effect. Silver particles move from one electrode to the other under the influence of a d.c. voltage and moisture. Capacitors with silver electrodes are considerably larger.

***) Flexible leads

size	BxH (mm)		BxH (inches)		approx. weight (g)
	Fig. 1	Fig. 2, 3	Fig. 1	Fig. 2, 3	
I	6 x 5	3 x 4	0.24 x 0.20	0.12 x 0.16	0.14
II	6 x 6	4 x 5	0.24 x 0.24	0.16 x 0.20	0.15
III	6 x 7	5 x 6	0.24 x 0.28	0.20 x 0.24	0.17
IV	6 x 8	6 x 7	0.24 x 0.32	0.24 x 0.28	0.19
V	6 x 11	6 x 10	0.24 x 0.40	0.24 x 0.36	0.19

The thickness of the capacitors does not exceed 2.1 mm (0.08 in), except for a few types as is indicated in tables 1 to 9.

Lacquer on the leads

When capacitors shown in Fig. 1 and 2 are mounted on printed-wiring boards with a thickness of 1.5 mm and with holes of 1.3 mm diameter or on printed-wiring boards with a thickness of 1 mm and with holes of 0.8 mm diameter, there will be no lacquer on the leads at the lower side of the board.

Marking

The temperature coefficient is indicated by a colour code as per I. E. C. and E. I. A. recommendations.

The capacitance value is indicated by figures in black script.

Mounting

When bending, cutting or flattening the leads, one should relieve them of the applied load at the capacitor body.

Soldering conditions

max. 250 °C, max. 5 s

2222 631-632
2222 638
2222 641-642

MINIATURE CERAMIC PLATE
CAPACITORS
CLASS 1B

(C333)

ELECTRICAL DATA

The capacitors meet the essential requirements of IEC 108.
Unless stated otherwise all electrical values have been determined at a temperature of 20 ± 5 °C, an atmospheric pressure of 930 to 1060 mbar and a relative humidity of 45 to 75 %.

Capacitance values and tolerances, measured at 1 MHz, < 5 V *)	see tables 1 to 9
Rated voltage	63 V d.c.
Test voltage for 1 min	200 V d.c.
Test voltage of coating for 1 min	200 V d.c.
Insulation resistance at 10 V d.c. after 1 min	> 1000 M Ω
Tan δ at 1 MHz, < 5 V *) for C < 50 pF	$\leq 15 \left(\frac{15}{C} + 0.7\right) 10^{-4}$; max. $55 \cdot 10^{-4}$
for C > 50 pF	$\leq 15 \cdot 10^{-4}$
Category temperature range	-55 to +85 °C
Climatic category (IEC 68)	55/085/21

*) including 2 mm per connecting lead

Capacitors with a temperature coefficient P100

Capacitance range 0.68 to 22 pF (E12 series)

 Temperature coefficient of the
 capacitance $\left(\frac{\Delta C}{C \cdot \Delta T}\right)$ $+100 \cdot 10^{-6}/\text{deg C}$

 Tolerance on the temperature
 coefficient $(-40 \text{ to } +120) 10^{-6}/\text{deg C}$

 Marking colour of the temperature
 coefficient red/violet

Table 1

cap. (pF)	tol.	size	marking	catalogue number		
				0.4 mm leads 2.54 mm spacing	0.6 mm leads 2.54 mm spacing	0.6 mm leads 5.08 mm spacing
0.68 [*])	±0.25 pF	I	p68	2222 632 03687	2222 631 03687	2222 638 03687
0.82 [*])	±0.25 pF	I	p82	03827	03827	03827
1.0	±0.25 pF	I	1p0	03108	03108	03108
1.2	±0.25 pF	I	1p2	03128	03128	03128
1.5	±0.25 pF	I	1p5	03158	03158	03158
1.8	±0.25 pF	I	1p8	03188	03188	03188
2.2	±0.25 pF	I	2p2	03228	03228	03228
2.7	±0.25 pF	I	2p7	03278	03278	03278
3.3	±0.25 pF	I	3p3	03338	03338	03338
3.9	±0.25 pF	II	3p9	03398	03398	03398
4.7	±0.25 pF	II	4p7	03478	03478	03478
5.6	±0.25 pF	II	5p6	03568	03568	03568
6.8	±0.25 pF	II	6p8	03688	03688	03688
8.2	±0.25 pF	III	8p2	03828	03828	03828
10	±2 %	III	10p	04109	04109	04109
12	±2 %	IV	12p	04129	04129	04129
15	±2 %	IV	15p	04159	04159	04159
18	±2 %	V	18p	04189	04189	04189
22	±2 %	V	22p	04229	04229	04229

*) maximum thickness 2.5 mm (0.1 in)

2222 631-632
2222 638
2222 641-642

MINIATURE CERAMIC PLATE
 CAPACITORS
 CLASS 1B

(C333)

Capacitors with a temperature coefficient NPO

Capacitance range 1.8 to 120 pF (E12 series)

Temperature coefficient of the
 capacitance ($\frac{\Delta C}{C \cdot \Delta T}$) $0.10 \cdot 10^{-6}/\text{deg C}$

Tolerance on the temperature
 coefficient
 for $C < 20$ pF $(-40 \text{ to } +120) 10^{-6}/\text{deg C}$
 for $C > 20$ pF $\pm 40 \cdot 10^{-6}/\text{deg C}$

Marking colour of the temperature
 coefficient black

→ Table 2

cap. (pF)	tol.	size	marking	catalogue number		
				0.4 mm leads 2.54 mm spacing	0.6 mm leads 2.54 mm spacing	0.6 mm leads 5.08 mm spacing
1.8*)	± 0.25 pF	I	1p8	2222 632 09188	2222 631 09188	2222 638 09188
2.2	± 0.25 pF	I	2p2	09228	09228	09228
2.7	± 0.25 pF	I	2p7	09278	09278	09278
3.3	± 0.25 pF	I	3p3	09338	09338	09338
3.9	± 0.25 pF	I	3p9	09398	09398	09398
4.7	± 0.25 pF	I	4p7	09478	09478	09478
5.6	± 0.25 pF	I	5p6	09568	09568	09568
6.8	± 0.25 pF	I	6p8	09688	09688	09688
8.2	± 0.25 pF	I	8p2	09828	09828	09828
10	± 2 %	I	10p	10109	10109	10109
12	± 2 %	I	12p	10129	10129	10129
15	± 2 %	I	15p	10159	10159	10159
18	± 2 %	I	18p	10189	10189	10189
22	± 2 %	II	22p	10229	10229	10229
27	± 2 %	II	27p	10279	10279	10279
33	± 2 %	II	33p	10339	10339	10339
39	± 2 %	II	39p	10399	10399	10399
47	± 2 %	III	47p	10479	10479	10479
56	± 2 %	III	56p	10569	10569	10569
68	± 2 %	IV	68p	10689	10689	10689
82	± 2 %	IV	82p	10829	10829	10829
100	± 2 %	V	n10	10101	10101	10101
120	± 2 %	V	n12	10121	10121	10121

*) maximum thickness 2.5 mm (0.1 in)

Capacitors with a temperature coefficient N075 (non-preferred)

Capacitance range 3.9 to 120 pF (E12 series)

Temperature coefficient of the

 capacitance $\left(\frac{\Delta C}{C \cdot \Delta T}\right)$ $-75 \cdot 10^{-6}/\text{deg C}$

 Tolerance on the temperature
 coefficient

 for $C < 20$ pF $(-40 \text{ to } +60) 10^{-6}/\text{deg C}$

 for $C > 20$ pF $\pm 40 \cdot 10^{-6}/\text{deg C}$

 Marking colour of the temperature
 coefficient

red

Table 3

cap. (pF)	tol.	size	marking	catalogue number		
				0.4 mm leads 2.54 mm spacing	0.6 mm leads 2.54 mm spacing	0.6 mm leads 5.08 mm spacing
3.9 [*])	± 0.25 pF	I	3p9	2222 632 27398	2222 631 27398	2222 638 27398
4.7	± 0.25 pF	I	4p7	27478	27478	27478
5.6	± 0.25 pF	I	5p6	27568	27568	27568
6.8	± 0.25 pF	I	6p8	27688	27688	27688
8.2	± 0.25 pF	I	8p2	27828	27828	27828
10	$\pm 2\%$	I	10p	28109	28109	28109
12	$\pm 2\%$	I	12p	28129	28129	28129
15	$\pm 2\%$	I	15p	28159	28159	28159
18	$\pm 2\%$	I	18p	28189	28189	28189
22	$\pm 2\%$	II	22p	28229	28229	28229
27	$\pm 2\%$	II	27p	28279	28279	28279
33	$\pm 2\%$	II	33p	28339	28339	28339
39	$\pm 2\%$	II	39p	28399	28399	28399
47	$\pm 2\%$	III	47p	28479	28479	28479
56	$\pm 2\%$	III	56p	28569	28569	28569
68	$\pm 2\%$	IV	68p	28689	28689	28689
82	$\pm 2\%$	IV	82p	28829	28829	28829
100	$\pm 2\%$	V	n10	28101	28101	28101
120	$\pm 2\%$	V	n12	28121	28121	28121

*) maximum thickness 2.5 mm (0.1 in)

2222 631-632
2222 638
2222 641-642

MINIATURE CERAMIC PLATE
 CAPACITORS
 CLASS 1B

(C333)

Capacitors with a temperature coefficient N150

Capacitance range 3.9 to 150 pF (E12 series)

Temperature coefficient of the capacitance $\left(\frac{\Delta C}{C \cdot \Delta T}\right)$ $-150 \cdot 10^{-6}/\text{deg C}$

Tolerance on the temperature coefficient

for $C < 20$ pF $(-40 \text{ to } +60) 10^{-6}/\text{deg C}$

for $C > 20$ pF $\pm 40 \cdot 10^{-6}/\text{deg C}$

Marking colour of the temperature coefficient orange

→ Table 4

cap. (pF)	tol.	size	marking	catalogue number		
				0.4 mm leads 2.54 mm spacing	0.6 mm leads 2.54 mm spacing	0.6 mm leads 5.08 mm spacing
3.9*	± 0.25 pF	I	3p9	2222 632 33398	2222 631 33398	2222 638 33398
4.7*	± 0.25 pF	I	4p7	33478	33478	33478
5.6	± 0.25 pF	I	5p6	33568	33568	33568
6.8	± 0.25 pF	I	6p8	33688	33688	33688
8.2	± 0.25 pF	I	8p2	33828	33828	33828
10	$\pm 2\%$	I	10p	34109	34109	34109
12	$\pm 2\%$	I	12p	34129	34129	34129
15	$\pm 2\%$	I	15p	34159	34159	34159
18	$\pm 2\%$	I	18p	34189	34189	34189
22	$\pm 2\%$	I	22p	34229	34229	34229
27	$\pm 2\%$	II	27p	34279	34279	34279
33	$\pm 2\%$	II	33p	34339	34339	34339
39	$\pm 2\%$	II	39p	34399	34399	34399
47	$\pm 2\%$	II	47p	34479	34479	34479
56	$\pm 2\%$	III	56p	34569	34569	34569
68	$\pm 2\%$	III	68p	34689	34689	34689
82	$\pm 2\%$	IV	82p	34829	34829	34829
100	$\pm 2\%$	IV	n10	34101	34101	34101
120	$\pm 2\%$	V	n12	34121	34121	34121
150	$\pm 2\%$	V	n15	34151	34151	34151

* maximum thickness 2.5 mm (0.1 in)

Capacitors with a temperature coefficient N220 (non-preferred)

Capacitance range 3.9 to 150 pF (E12 series)

Temperature coefficient of the

 capacitance $(\frac{\Delta C}{C \cdot \Delta T})$ $-220 \cdot 10^{-6}/\text{deg C}$

 Tolerance on the temperature
 coefficient

 for $C < 20$ pF $(-40 \text{ to } +60) 10^{-6}/\text{deg C}$

 for $C > 20$ pF $\pm 40 \cdot 10^{-6}/\text{deg C}$

 Marking colour of the temperature
 coefficient

yellow

Table 5

cap. (pF)	tol.	size	marking	catalogue number		
				0.4 mm leads 2.54 mm spacing	0.6 mm leads 2.54 mm spacing	0.6 mm leads 5.08 mm spacing
3.9*)	± 0.25 pF	I	3p9	2222 632 39398	2222 631 39398	2222 638 39398
4.7	± 0.25 pF	I	4p7	39478	39478	39478
5.6	± 0.25 pF	I	5p6	39568	39568	39568
6.8	± 0.25 pF	I	6p8	39688	39688	39688
8.2	± 0.25 pF	I	8p2	39828	39828	39828
10	$\pm 2\%$	I	10p	40109	40109	40109
12	$\pm 2\%$	I	12p	40129	40129	40129
15	$\pm 2\%$	I	15p	40159	40159	40159
18	$\pm 2\%$	I	18p	40189	40189	40189
22	$\pm 2\%$	I	22p	40229	40229	40229
27	$\pm 2\%$	II	27p	40279	40279	40279
33	$\pm 2\%$	II	33p	40339	40339	40339
39	$\pm 2\%$	II	39p	40399	40399	40399
47	$\pm 2\%$	II	47p	40479	40479	40479
56	$\pm 2\%$	III	56p	40569	40569	40569
68	$\pm 2\%$	III	68p	40689	40689	40689
82	$\pm 2\%$	IV	82p	40829	40829	40829
100	$\pm 2\%$	IV	n10	40101	40101	40101
120	$\pm 2\%$	V	n12	40121	40121	40121
150	$\pm 2\%$	V	n15	40151	40151	40151

*) maximum thickness 2.5 mm (0.1 in)

2222 631-632
2222 638
2222 641-642

MINIATURE CERAMIC PLATE
 CAPACITORS
 CLASS 1B

(C333)

Capacitors with a temperature coefficient N330 (non-preferred)

Capacitance range 4.7 to 180 pF (E12 series)

Temperature coefficient of the capacitance $\left(\frac{\Delta C}{C \cdot \Delta T}\right)$ $-330 \cdot 10^{-6}/\text{deg C}$

Tolerance on the temperature coefficient $\pm 60 \cdot 10^{-6}/\text{deg C}$

Marking colour of the temperature coefficient green

Table 6

cap. (pF)	tol.	size	marking	catalogue number		
				0.4 mm leads 2.54 mm spacing	0.6 mm leads 2.54 mm spacing	0.6 mm leads 5.08 mm spacing
4.7*	± 0.25 pF	I	4p7	2222 632 45478	2222 631 45478	2222 638 45478
5.6*	± 0.25 pF	I	5p6	45568	45568	45568
6.8	± 0.25 pF	I	6p8	45688	45688	45688
8.2	± 0.25 pF	I	8p2	45828	45828	45828
10	$\pm 2\%$	I	10p	46109	46109	46109
12	$\pm 2\%$	I	12p	46129	46129	46129
15	$\pm 2\%$	I	15p	46159	46159	46159
18	$\pm 2\%$	I	18p	46189	46189	46189
22	$\pm 2\%$	I	22p	46229	46229	46229
27	$\pm 2\%$	I	27p	46279	46279	46279
33	$\pm 2\%$	II	33p	46339	46339	46339
39	$\pm 2\%$	II	39p	46399	46399	46399
47	$\pm 2\%$	II	47p	46479	46479	46479
56	$\pm 2\%$	II	56p	46569	46569	46569
68	$\pm 2\%$	III	68p	46689	46689	46689
82	$\pm 2\%$	III	82p	46829	46829	46829
100	$\pm 2\%$	IV	n10	46101	46101	46101
120	$\pm 2\%$	IV	n12	46121	46121	46121
150	$\pm 2\%$	V	n15	46151	46151	46151
180	$\pm 2\%$	V	n18	46181	46181	46181

*) maximum thickness 2.5 mm (0.1 in)

Capacitors with a temperature coefficient N470 (non-preferred)

Capacitance range 6.8 to 220 pF (E12 series)

Temperature coefficient of the

 capacitance $\left(\frac{\Delta C}{C \cdot \Delta T}\right)$ $-470 \cdot 10^{-6}/\text{deg C}$

 Tolerance on the temperature
 coefficient

 for $C < 20$ pF $(-90 \text{ to } +250) 10^{-6}/\text{deg C}$

 for $C > 20$ pF $\pm 90 \cdot 10^{-6}/\text{deg C}$

 Marking colour of the temperature
 coefficient

blue

Table 7

cap. (pF)	tol.	size	marking	catalogue number		
				0.4 mm leads 2.54 mm spacing	0.6 mm leads 2.54 mm spacing	0.6 mm leads 5.08 mm spacing
6.8 [*]	± 0.25 pF	I	6p8	2222 632 51688	2222 631 51688	2222 638 51688
8.2	± 0.25 pF	I	8p2	51828	51828	51828
10	$\pm 2\%$	I	10p	52109	52109	52109
12	$\pm 2\%$	I	12p	52129	52129	52129
15	$\pm 2\%$	I	15p	52159	52159	52159
18	$\pm 2\%$	I	18p	52189	52189	52189
22	$\pm 2\%$	I	22p	52229	52229	52229
27	$\pm 2\%$	I	27p	52279	52279	52279
33	$\pm 2\%$	I	33p	52339	52339	52339
39	$\pm 2\%$	II	39p	52399	52399	52399
47	$\pm 2\%$	II	47p	52479	52479	52479
56	$\pm 2\%$	II	56p	52569	52569	52569
68	$\pm 2\%$	II	68p	52689	52689	52689
82	$\pm 2\%$	III	82p	52829	52829	52829
100	$\pm 2\%$	III	n10	52101	52101	52101
120	$\pm 2\%$	IV	n12	52121	52121	52121
150	$\pm 2\%$	IV	n15	52151	52151	52151
180	$\pm 2\%$	V	n18	52181	52181	52181
220	$\pm 2\%$	V	n22	52221	52221	52221

^{*}) maximum thickness 2.5 mm (0.1 in)

2222 631-632
2222 638
2222 641-642

MINIATURE CERAMIC PLATE
 CAPACITORS
 CLASS 1B

(C333)

Capacitors with a temperature coefficient N750

Capacitance range 3.9 to 330 pF (E12 series)

Temperature coefficient of the
 capacitance $\left(\frac{\Delta C}{C \cdot \Delta T}\right)$ $-750 \cdot 10^{-6}/\text{deg C}$

Tolerance on the temperature
 coefficient

for $C < 20 \text{ pF}$ $(-120 \text{ to } +250) 10^{-6}/\text{deg C}$

for $C > 20 \text{ pF}$ $\pm 120 \cdot 10^{-6}/\text{deg C}$

Marking colour of the temperature
 coefficient violet

→ Table 8

cap. (pF)	tol.	size	marking	catalogue number		
				0.4 mm leads 2.54 mm spacing	0.6 mm leads 2.54 mm spacing	0.6 mm leads 5.08 mm spacing
3.9*	±0.25 pF	I	3p9	2222 632 57398	2222 631 57398	2222 638 57398
4.7	±0.25 pF	I	4p7	57478	57478	57478
5.6	±0.25 pF	I	5p6	57568	57568	57568
6.8	±0.25 pF	I	6p8	57688	57688	57688
8.2	±0.25 pF	I	8p2	57828	57828	57828
10	± 2 %	I	10p	58109	58109	58109
12	± 2 %	I	12p	58129	58129	58129
15	± 2 %	I	15p	58159	58159	58159
18	± 2 %	I	18p	58189	58189	58189
22	± 2 %	I	22p	58229	58229	58229
27	± 2 %	I	27p	58279	58279	58279
33	± 2 %	I	33p	58339	58339	58339
39	± 2 %	I	39p	58399	58399	58399
47	± 2 %	I	47p	58479	58479	58479
56	± 2 %	II	56p	58569	58569	58569
68	± 2 %	II	68p	58689	58689	58689
82	± 2 %	II	82p	58829	58829	58829
100	± 2 %	II	n10	58101	58101	58101
120	± 2 %	III	n12	58121	58121	58121
150	± 2 %	III	n15	58151	58151	58151
180	± 2 %	IV	n18	58181	58181	58181
220	± 2 %	IV	n22	58221	58221	58221
270	± 2 %	V	n27	58271	58271	58271
330	± 2 %	V	n33	58331	58331	58331

*) maximum thickness 2.5 mm (0.1 in)

Capacitors with a temperature coefficient N1500 (non-preferred)

Capacitance range 18 to 560 pF (E12 series)

Temperature coefficient of the

 capacitance $\left(\frac{\Delta C}{C \cdot \Delta T}\right)$ $-1500 \cdot 10^{-6}/\text{deg C}$

Tolerance on the temperature
 coefficient

 $\pm 250 \cdot 10^{-6}/\text{deg C}^{**}$

Marking colour of the temperature
 coefficient

red/yellow

Table 9

cap. (pF)	tol.	size	marking	catalogue number		
				0.4 mm leads	0.6 mm leads	0.6 mm leads
				2.54 mm spacing	2.54 mm spacing	5.08 mm spacing
18 [*])	± 2 %	I	18p	2222 632 70189	2222 631 70189	2222 638 70189
22	± 2 %	I	22p	70229	70229	70229
27	± 2 %	I	27p	70279	70279	70279
33	± 2 %	I	33p	70339	70339	70339
39	± 2 %	I	39p	70399	70399	70399
47	± 2 %	I	47p	70479	70479	70479
56	± 2 %	I	56p	70569	70569	70569
68	± 2 %	I	68p	70689	70689	70689
82	± 2 %	I	82p	70829	70829	70829
100	± 2 %	II	n10	70101	70101	70101
120	± 2 %	II	n12	70121	70121	70121
150	± 2 %	II	n15	70151	70151	70151
180	± 2 %	II	n18	70181	70181	70181
220	± 2 %	III	n22	70221	70221	70221
270	± 2 %	III	n27	70271	70271	70271
330	± 2 %	IV	n33	70331	70331	70331
390	± 2 %	IV	n39	70391	70391	70391
470	± 2 %	V	n47	70471	70471	70471
560	± 2 %	V	n56	70561	70561	70561

^{*}) Maximum thickness 2.5 mm (0.1 in)

^{**}) Temporarily these capacitors are delivered with a tolerance of (+0 to -500).
 $10^{-6}/\text{deg C}$

QUALITY CONTROL AND TEST SPECIFICATIONS

After manufacturing each capacitor is checked on the following electrical characteristics:

- capacitance
- loss factor
- test voltage

Apart from this several other quality checks are carried out by frequent inspections. Due to the construction and the carefully controlled manufacturing process the ceramic capacitors are capable of withstanding severe climate and electrical tests. The aforementioned tests conform with the recommendations laid down by I.E.C. 68-2.

Some of the more important tests and parameters are described below.

Life test

The capacitors shall withstand a 1000 hours life test at a voltage of 1.5 times nominal voltage at 85 °C. After the test the capacitance change shall not be more than 1% or 1 pF compared with pre-test value, the loss factor shall not be more than 1.5 times the initial requirements and the insulation resistance shall not be less than 300 MΩ.

Humidity test

The capacitors shall withstand a damp heat test for 21 days at a relative humidity of 95% and an ambient temperature of 40 °C with or without nominal voltage applied. After the test the capacitance change shall not be more than 1% or 1 pF compared with pre-test value, the loss factor shall not be more than 2 times the initial requirements and the insulation resistance shall not be less than 100 MΩ.

Temperature change test

The capacitors shall withstand a temperature cycle 3 hours at 85 °C and 3 hours at -55 °C temperature being changed between 2 and 3 minutes. After the test the capacitance change shall not be more than 0.5% or 0.5 pF compared with pre-test value, the loss factor shall not be more than 2 times the initial requirements and the insulation resistance shall not be less than 100 MΩ.

Bend-pull test

The capacitors shall withstand a bend-pull test consisting of 1 cycle of 4 bends of 90° with a weight of 250 gram. During test the capacitors are mounted on a board of resin bonded paper with a thickness of 1.0 mm and holes of 0.8 mm diameter.

Vibration test

The capacitors shall withstand a 6 hours vibration test. In three directions 120 cycles of 1 minute vibration with an amplitude of 0.75 mm are applied. During each cycle the frequency changes from 10 to 55 to 10 Hz.

Vacuum test

The capacitors shall withstand a low pressure of 85 mbar during at least 2 minutes.

CERAMIC BARRIER LAYER CAPACITORS

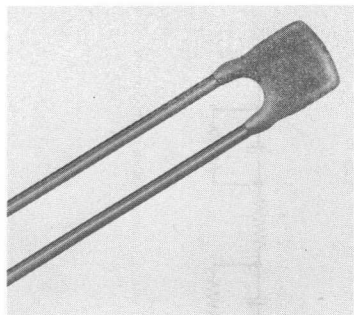

RZ 22070-10

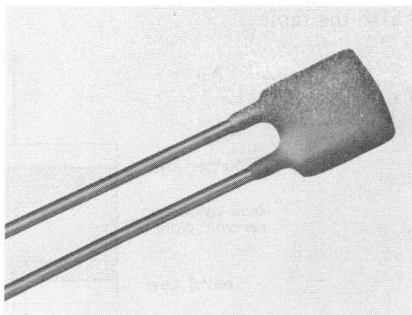

RZ 22070-7

Capacitance range

22 000 to 100 000 pF

Maximum working voltage

6 Vdc

APPLICATION

The capacitors have a very high capacitance at very small dimensions. Therefore they are very suited for coupling and decoupling purposes in small transistorised equipment, for example in i.f. stages of radio receivers.

CONSTRUCTION

The capacitors consist of a thin rectangular ceramic plate, which has been given semiconducting properties by a reducing process. The surface is oxidised on both sides, thus forming a barrier layer. Both surfaces are metallised and provided with connecting leads. Thus two capacitances with a series resistance in between are formed (see Fig.1).

The whole is covered with a blue insulating lacquer.

The capacitors are provided with rigid connecting leads of 0.6 mm diameter or with flexible connecting leads of 0.4 mm diameter.

The capacitors of the first mentioned version are intended to be used on printed-wiring boards with a pitch of 0.1". The distance between the leads is 2.54 mm with a tolerance of ± 0.2 mm, which assures an easy mounting. It must be pointed out that the leads should not be bent, e.g. for use on printed-wiring boards with a pitch of 5 mm.

For the latter application use must be made of the version with connecting leads of 0.4 mm diameter. When bending, cutting or flattening these leads, they should be relieved of the applied load at the capacitor body.

The capacitor width never exceeds 5 mm. The capacitance value is indicated by letters or figures in black script on the capacitor body as shown in Figs 2 and 3; see also the table.

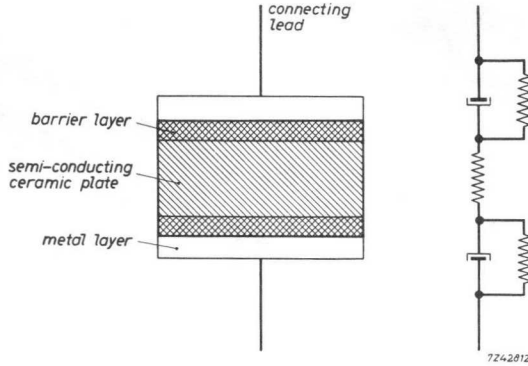

Fig. 1

Dimensions in mm

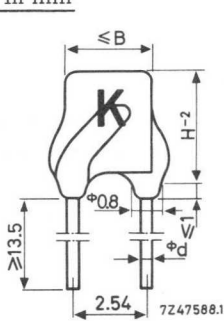

Fig. 2

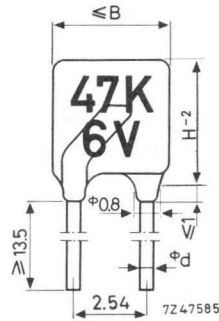

Fig. 3

$d = 0.4$ mm (flexible connecting leads)

$= 0.6$ mm (rigid connecting leads)

$B =$ see table

$H =$ see table

TECHNICAL PERFORMANCE

Unless otherwise specified, all electrical values apply to a temperature of 20 ± 5 °C, an atmospheric pressure of 930-1060 mbar and a relative humidity $\le 75\%$.

Capacitance values and tolerances	see table
Maximum working voltage at 55 °C	6 V _{dc}
Test voltage coating for t = 1 min	15 V _{dc}
Insulation resistance measured at 6 V _{dc} within 1 min	> 150 000 Ω
measured at 3 V _{dc} within 1 min	> 500 000 Ω
Impedance at 10 MHz for the 47 000 pF and 100 000 pF versions	≤ 5 Ω
for the 22 000 pF version	≤ 10 Ω
Working-temperature range	-10 to +55 °C
Storage-temperature range	-40 to +55 °C
Solderability	250 °C, 5 s
Climatic robustness	category 10/055/21 (I.E.C. 68)

AVAILABLE VERSIONS

Catalog numbers: 2222 675
 suffix, see table

capacitance		dimensions			suffix		marking
nom. (pF)	tol. (%)	B (mm)	H (mm)	Fig	version with 0.6 mm leads	version with 0.4 mm leads	
22 000	-20/+100	3.7	5.2	2	01223	02223	K
47 000	-20/+100	5.0	6.5	3	01473	02473	47 K 6 V
100 000	-20/+100	5.0	10.5	3	01104	02104	0.1 6 V

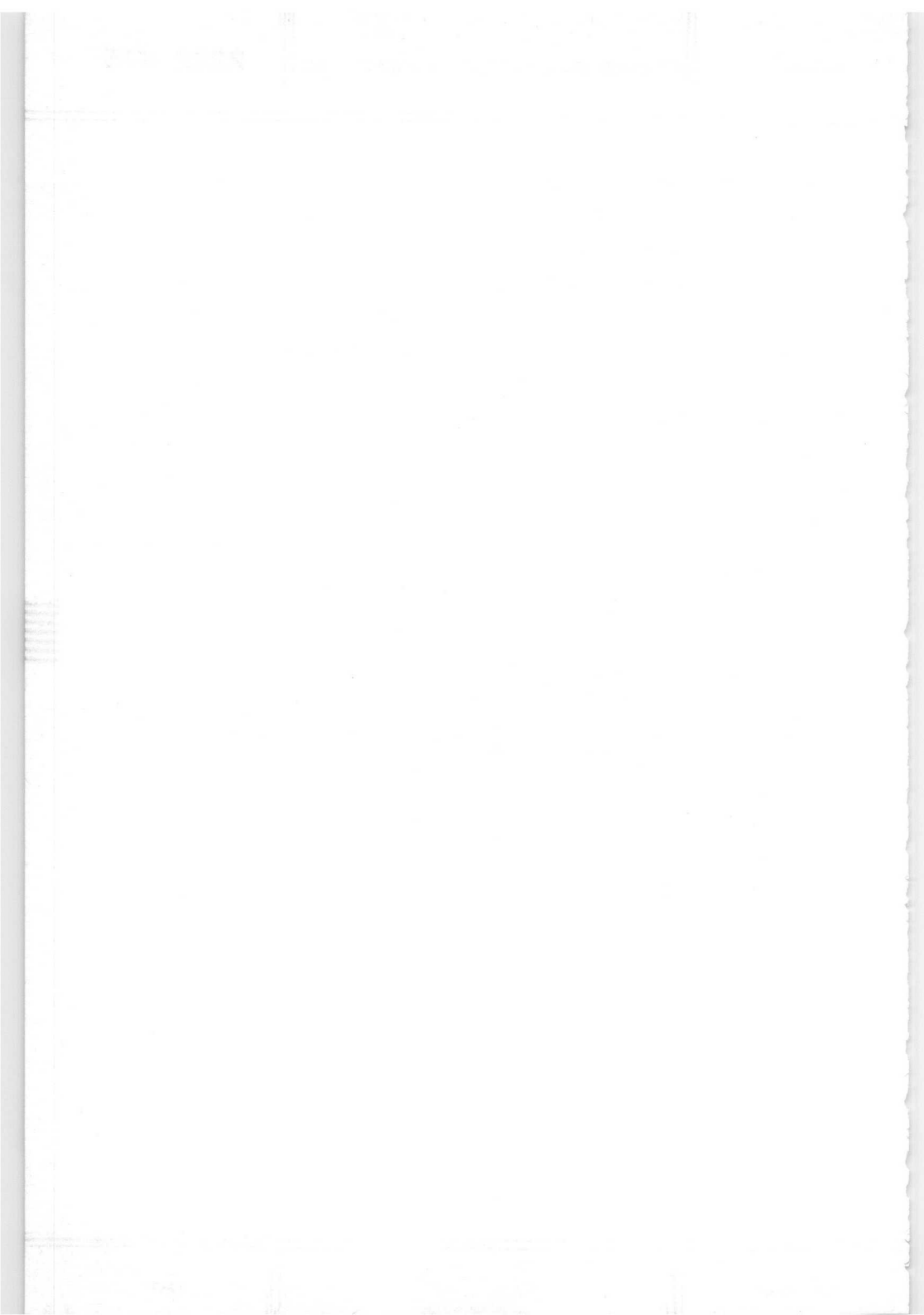

CERAMIC FEED-THROUGH CAPACITORS CLASS I, CLASS II

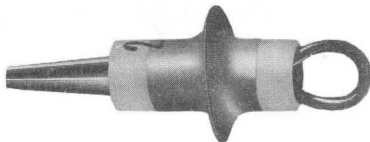

RZ 22070-3

700-series: Maximum working voltage	350 V _{dc}
Class IC, capacitance range	2.5 to 47 pF
Class II, capacitance range	68 to 2200 pF

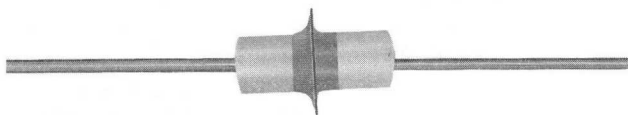

702-series: Maximum working voltage	350 V _{dc}	RZ 22070-4
Class II, capacitance range	2.5 to 4700 pF	

APPLICATION

Ceramic feed-through capacitors are designed for decoupling the supply leads of high-frequency equipment, for instance in TV tuners. However, due to their extremely low inductances, they might also be used in frequency-determining circuits in similar equipment. Since in this application (e.g. in v.h.f./u.h.f. tuners) low losses are required, class I types should be chosen.

CONSTRUCTION

The capacitors consist of a ceramic tube provided with silver electrodes. The outer connection is formed by a flange, and the inner one by a split pen (700-series) or an axial lead (702-series). Both types are provided with sufficient soldering tin to facilitate mounting.

The split pen capacitors are marked in black script or with a colour dot. The lead feed-through type is not marked.

2222 700
2222 702

CERAMIC FEED-THROUGH CAPACITORS
 CLASS I, CLASS II

(C309)

Dimensions in mm

700-series

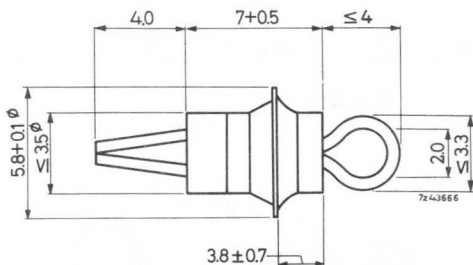

702-series

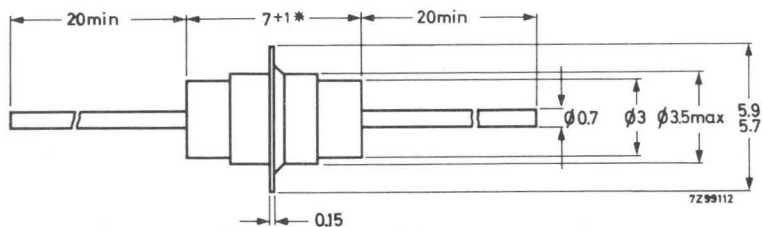

*) 10+1 mm for the 3300pF capacitor
 12+1 mm for the 4700pF capacitor

TECHNICAL PERFORMANCE

Unless otherwise specified all electrical values apply to a temperature of 20 ± 5 °C, an atmospheric pressure of 930-1060 mbar and a relative humidity of ≤ 75 %.

Maximum working voltage	350 V _{dc}
Test voltage for 1 min	1050 V _{dc}
Losses (tan δ) measured at < 3.5 V	
for $C \leq 68$ pF at 1 MHz	$< 10 \cdot 10^{-4}$
for $C > 68$ pF at 1 kHz	$< 20 \cdot 10^{-4}$
Insulation resistance at 100 V _{dc} (within 1 min)	$> 10\,000$ M Ω
Temperature dependence of the capacitance	see table
Working temperature range	-40 to +85 °C
Climatic robustness	category 40/085/21 (I.E.C. 68)

(C309)

 CERAMIC FEED-THROUGH CAPACITORS
 CLASS I, CLASS II
2222 700**2222 702**

AVAILABLE VERSIONS

Split pen feed-through capacitors

Catalog number 2222 700

suffix, see table

capacitance (pF)	tolerance	temperature coefficient ($10^{-6}/\text{deg C}$)	class	suffix
≤ 2.5				00258
3.3	±0.5 pF			01338
4.7	±0.5 pF	+100		01478
6.8	±1 pF			02688
10	±1 pF		1C	02109
15				03159
22		-150		03229
33	±10 %			03339
47		-750		03479
68				04689
100				04101
150				04151
220	±20 %			04221
330				04331
470			II	04471
680				04681
1000				05102
1500	-20/+50 %			05152
2200				05222

2222 700
2222 702

CERAMIC FEED-THROUGH CAPACITORS
 CLASS I, CLASS II

(C309)

Lead feed-through capacitors (class II)

Catalog number 2222 702

suffix, see table

cap. (pF)	tolerance	suffix	cap. (pF)	tolerance	suffix
≤ 2.5	± 0.5 pF	04258	100	± 20%	08101
3.3		04338	150		08151
4.7		04478	220		08221
6.8		04688	330		08331
10	± 10%	05109	470	-20/+50%	08471
15		07159	680		09681
22		07229	1000		09102
33		07339	1500		09152
47		07479	2200		09222
68		07689	3300		09332
			4700		09472

Capacitance values of the E12 series are subject to minimum order release requirements.

Polyester capacitors

Polycarbonate capacitors

Polystyrene capacitors

Paper d.c. capacitors

Paper a.c. capacitors



1000000
1000000
1000000
1000000
1000000
1000000

METALLISED POLYESTER CAPACITORS

"flat film" type

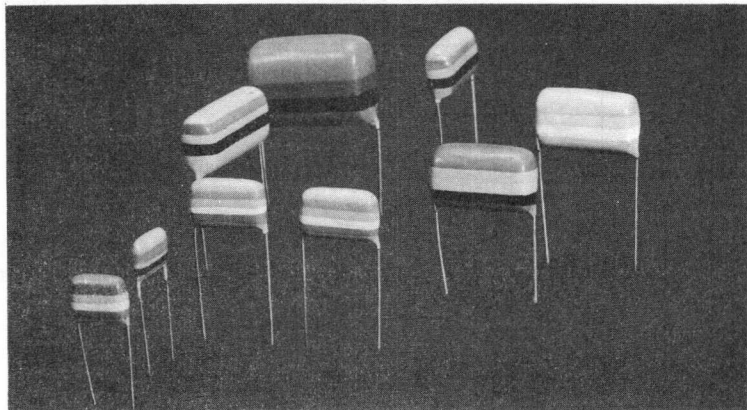

RZ 22359-4

Nominal voltage	250	400	630 V
Capacitance range	0.01-2.2	0.01-1	0.01-0.47 μ F

APPLICATION

These capacitors are designed primarily for use as coupling and decoupling capacitors for electronic circuits employing printed wiring.

Due to the almost negligible temperature dependency they offer in many cases essential advantages over ceramic disc capacitors.

Maximum overvoltage

Special attention is drawn to the fact that the allowed 40% overvoltage for the 250 V versions permits these capacitors to be employed in anode and screen grid circuits, instead of previously used 400 V capacitors.

CONSTRUCTION

Dielectric material

- of 250 V capacitors : metallised polyethylene-terephthalate (PETP)
- of 400 V capacitors : metallised PETP and metallised polycarbonate
- of 630 V capacitors : metallised polycarbonate

Table II

capacitance (μF)	capacitance code	max. dimensions (mm)								
		250 V versions			400 V versions			630 V versions		
		D	B	H	D	B	H	D	B	H
0.010	103	4	12.5	9	4	12.5	9	4	12.5	9
0.015	153	4	12.5	9	4	12.5	9	5	12.5	10
0.022	223	4	12.5	9	4	12.5	9	6	12.5	11
0.033	333	4	12.5	9	5	12.5	10	6	17.5	11
0.047	473	4	12.5	9	6	12.5	11	7	17.5	12
0.068	683	5	12.5	10	6	17.5	11	6.5	22.5	11.5
0.10	104	6	12.5	11	7	17.5	12	7.5	22.5	12.5
0.15	154	6	17.5	11	6.5	22.5	11.5	9.5	22.5	14.5
0.22	224	7	17.5	12	7.5	22.5	12.5	9.5	30	14.5
0.33	334	6.5	22.5	11.5	9.5	22.5	14.5	10	30	18
0.47	474	7.5	22.5	12.5	9.5	30	14.5	12	30	20
0.68	684	9.5	22.5	14.5	10	30	18			
1.0	105	9.5	30	14.5	12	30	20			
1.5	155	10.5	30	18						
2.2	225	12.5	30	20.5						

Intermediate values according to the E12 range are available on request. The dimensions are identical to those of the next higher value in the standard E6 range. The capacitance tolerance is either $\pm 10\%$ or $+20\%$. The preferred tolerance is $\pm 20\%$ for $\leq 0.22 \mu\text{F}$, and $\pm 10\%$ for $> 0.22 \mu\text{F}$.

TECHNICAL PERFORMANCE

Unless otherwise specified all electrical characteristics apply to an ambient temperature of $20 \pm 5 \text{ }^\circ\text{C}$, an atmospheric pressure of 930-1060 mbar and a relative humidity of 45-75 %.

Working temperature range	-40/+100 $^\circ\text{C}$
Maximum d.c. working voltage up to 85 $^\circ\text{C}$ derating	nominal voltage (V_{nom}) 1.25% per deg C above 85 $^\circ\text{C}$
Maximum overvoltage for 1 minute per hour.	250 V versions: 40% 400 V and 630 V versions: 25%
Maximum a.c. voltage, 50-60 Hz (never to be exceeded at other frequencies)	250 V versions: 160 V 400 V versions: 200 V 630 V versions: 220 V
Calculation of the dissipation	with the aid of Fig.1
Maximum dissipation	Fig.2
Pulse loads, maximum steepness	see Table III

Test voltage (d.c.) for 1 minute	1.6 x nominal voltage
Capacitance drift during life	
d.c. loaded, at 1.5 V _{nom} and 85 °C	< 5%
at 25 °C	< 2%
a.c. loaded, for B = 12.5 mm	< 25%
B = 17.5 mm	< 20%
B = 22.5 mm	< 15%
B = 30 mm	< 10%
Capacitance as a function of temperature and frequency	Fig.3 and Fig.4
Insulation resistance at 20 °C	
for C ≤ 0.33 μF	R > 30 000 MΩ
for C > 0.33 μF	RC > 10 000 s (MΩ.μF)
Insulation resistance as a function of temperature	Fig.5. Decrease of minimum values is a factor 2 per 10 degC above 20 °C
Losses (tan δ) at 1 kHz and 20 °C	250 V versions: < 75 x 10 ⁻⁴
	400 and 630 V versions: < 30 x 10 ⁻⁴
at 10 kHz and 20 °C	250 V versions: < 250x10 ⁻⁴
	400 and 630 V versions: < 100x10 ⁻⁴
Losses as a function of temperature and frequency	Fig.6 and Fig.7
Resonance frequency	Fig.8
Climatic robustness	category 40/100/21 (I.E.C. 68); 500 hours at 40 °C and 90-95% R.H.
Solderability conforming to	I.E.C. 68-2, test T3.2 on 6 mm from the capacitor body
Soldering conditions for p.w. boards	5 seconds, 250 °C
Thermal shock proof	2 seconds, 350 °C
Lead strength, radial	> 5 N (> 500 g)
axial	> 2.5 N (> 250 g)

Table III

nominal voltage	maximum steepness (V/μs)			
	dimension B			
	12.5 mm	17.5 mm	22.5 mm	30 mm
250 V	20	10	7	5
400 V	30	20	10	8
630 V	45	30	15	10

→ **Important note:** A metallised film capacitor must not be used in a low-impedance circuit in which any short-circuit current through the capacitor might exceed 400 mA.

CALCULATION OF THE MAXIMUM A. C. VOLTAGE

A maximum permissible a. c. voltage has been specified for 50-60 Hz and at 20 °C. This voltage value must also never be exceeded at other frequencies. The permissible a. c. voltage may further be limited by the following requirements:

- 1) The power dissipation must not exceed the specified limit P_{\max} .
- 2) The steepness of the a. c. voltage must not exceed the specified limit.

Ad 1.

The power dissipated by a capacitor is a function of the voltage over the series resistance (R_S) or of the current through the series resistance and is expressed by

$$P = \frac{V_{R_S}^2}{R_S} = I^2 R_S \quad (1)$$

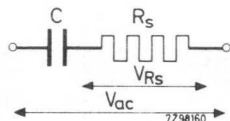

$$V_{R_S}^2 = \frac{R_S^2}{R_S^2 + 1/\omega^2 C^2} V_{ac}^2 \quad (2a)$$

As for these capacitors $\tan \delta = R_S \omega C =$ always < 0.1 , the formula (2a) can be simplified to

$$V_{R_S}^2 = \frac{R_S^2}{1/\omega^2 C^2} V_{ac}^2 = R_S^2 \omega^2 C^2 V_{ac}^2 \quad (2b)$$

Thus
$$P = R_S \omega^2 C^2 V_{ac}^2 \quad (3a)$$

or
$$P = (R_S C) C \omega^2 V_{ac}^2 \quad (3b)$$

The term $R_S C$ can be found from Fig. 1. C (in farads), $\omega = 2\pi f$ and V_{ac} are assumed to be known.

The maximum permissible value of power dissipation (P_{\max}), which depends on the dimensions of the capacitor and on the ambient temperature, can be found from Fig. 2. Thus, when the actual power has been calculated with formula (3b), Fig. 2 gives the minimum size of capacitor which can dissipate this power.

May be two or three capacitors having this size can be chosen, namely with different nominal working voltages.

Example of using Fig.1. and Fig.2

A capacitor with dielectric of polycarbonate and a value of $0.33 \mu\text{F}$ should be used at an a.c. voltage $V_{ac} = 180 \text{ V}$, a frequency of 1 kHz and an ambient temperature of 50°C .

The $R_S C$ -product is $5 \cdot 10^{-7} \Omega\text{F}$ (from Fig.1), so that the power to be dissipated

$$P = (R_S C) C \omega^2 V_{ac}^2$$

$$= 5 \times 10^{-7} \times 0.33 \times 10^{-6} \times 4\pi^2 \times 1000^2 \times 180^2 = 0.214 \text{ W.}$$

Fig.2 shows that at 50°C capacitors with curve numbers 15 to 23 can be used, thus a minimum size of $9.5 \times 22.5 \times 14.5 \text{ mm}$. It can be seen from Table II that a choice can be made between $0.33 \mu\text{F} - 400 \text{ V}$ and $0.33 \mu\text{F} - 630 \text{ V}$ capacitors.

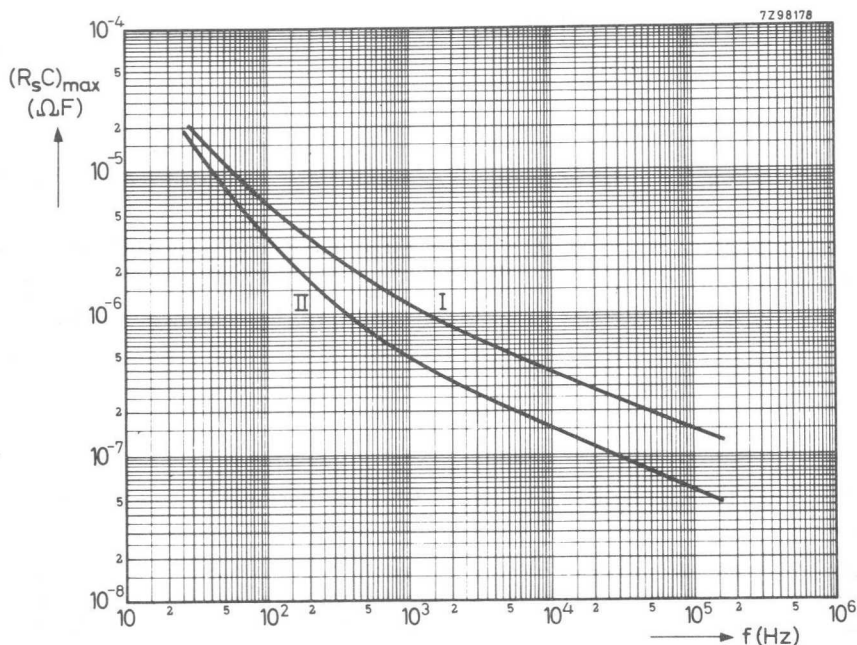
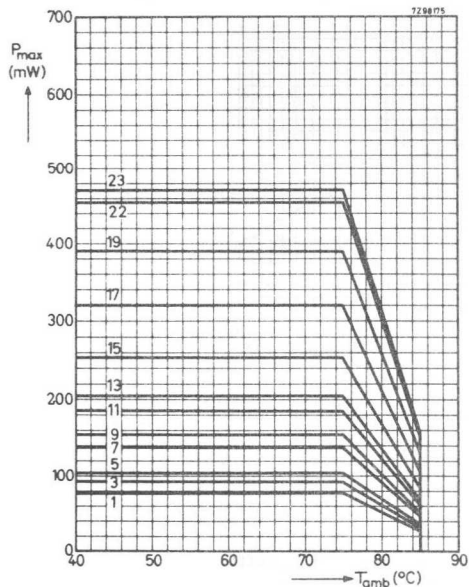

Fig.1. Maximum product of series resistance and capacitance as a function of the frequency

I = PETP versions

II = polycarbonate versions



curve	dimensions in mm		
	D	B	H
1	4	12.5	9
3	5	12.5	10
5	6	12.5	11
7	6	17.5	11
9	7	17.5	12
11	6.5	22.5	11.5
13	7.5	22.5	12.5
15	9.5	22.5	14.5
17	9.5	30	14.5
19	10	30	18
22	12	30	20
23	12.5	30	20.5

Fig.2. Maximum permissible power dissipation as a function of the temperature

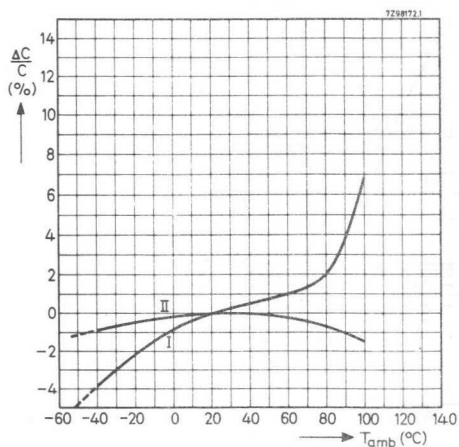

I = PETP versions
II = polycarbonate versions

Fig.3. Capacitance as a function of the temperature

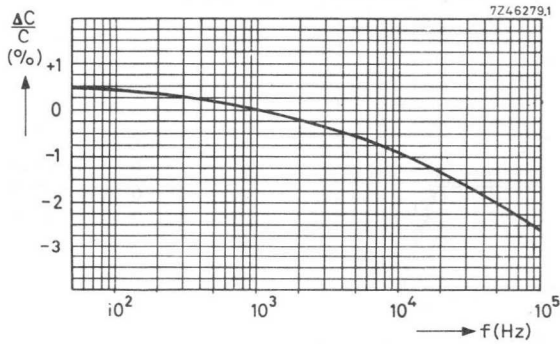

Fig. 4. Capacitance as a function of the frequency

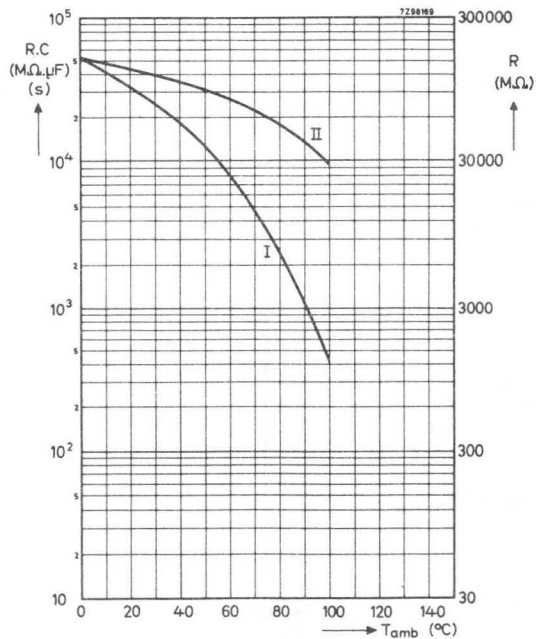

Fig. 5. Insulation resistance as a function of the temperature

I = PETP versions II = Polycarbonate versions

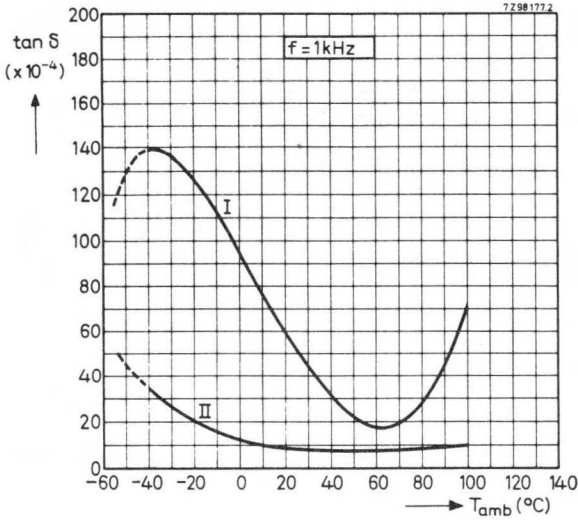

Fig.6. Losses at 1 kHz as a function of the temperature
I = PETP versions II = polycarbonate versions

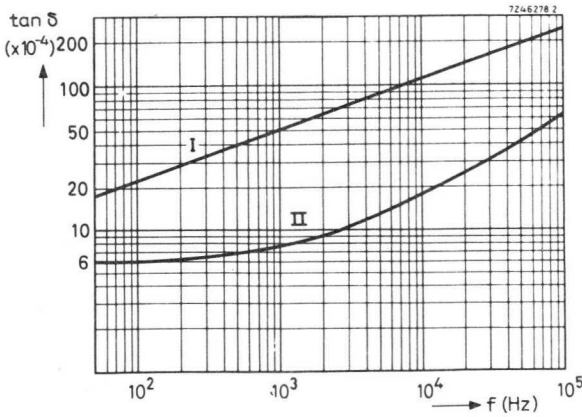

Fig.7. Losses as a function of the frequency
I = PETP versions II = polycarbonate versions

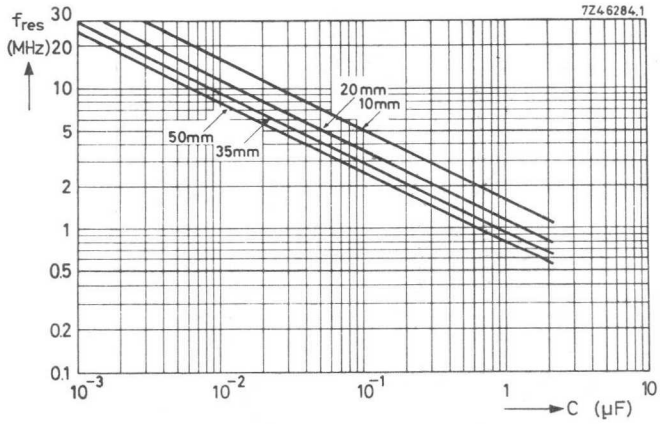
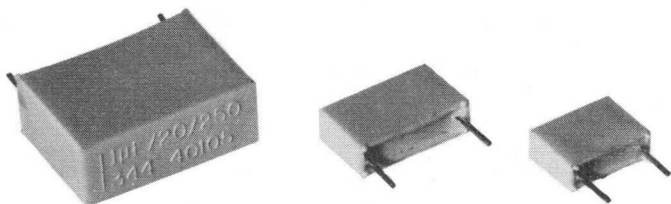

Fig. 8. Resonance frequency as a function of the capacitance, at different total wire lengths

MOULDED METALLISED POLYESTER CAPACITORS

"nugget" type



RZ 24298

Nominal voltage	100	250	400	630 V
Capacitance range	0.068-6.8	0.01-2.2	0.01-1	0.01-0.47 μ F

APPLICATION

This series of capacitors is an extension of the "flat film" series, and is especially suitable for those applications where the insulation of the winding should meet higher requirements and well-defined dimensions are needed. These capacitors have an easy-plug-in shape for use on printed-wiring boards even with a high component density. They are marked on the top with an embossed print.

Maximum overvoltage:

Special attention is drawn to the fact that the allowed 40% overvoltage for the 100 V and 250 V versions permits these capacitors to be employed in anode and screen grid circuits, instead of previously used 400 V types.

CONSTRUCTION

Dielectric material

of 100 V capacitors : metallised polyethyleneterephthalate and polycarbonate
 of 250 V capacitors : metallised polyethylene-terephthalate (PETP)
 of 400 V and 630 V capacitors: metallised polycarbonate

Dimensions in mm (See also the tables)

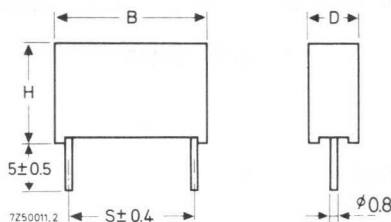

Marking (top view)

0.22/20/250

- value in μF /tolerance/nominal voltage

344 40224

- last 8 digits of catalog number

TYPES

Composition of the catalog number

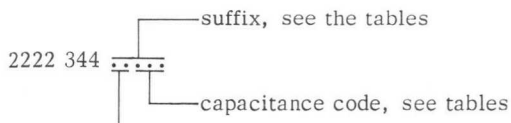

code for dielectric material, nominal voltage and capacitance tolerance:

- 24 = PETP, 100 V, 20%
- 25 = PETP, 100 V, 10%
- 40 = PETP, 250 V, 20%
- 41 = PETP, 250 V, 10%

- 20 = polycarbonate, 100 V, 20%
- 21 = polycarbonate, 100 V, 10%
- 50 = polycarbonate, 400 V, 20%
- 51 = polycarbonate, 400 V, 10%
- 60 = polycarbonate, 630 V, 20%
- 61 = polycarbonate, 630 V, 10%

The capacitance values in the tables are of the E6 series. Intermediate capacitance values of the E12 series can be supplied on request. The dimensions of the latter capacitors are identical to those with the next higher E6 value.

The preferred tolerance on all values $\leq 0.22 \mu\text{F}$ is $\pm 20\%$, and on all values $> 0.22 \mu\text{F}$ it is $\pm 10\%$.

100 V versions

capacitance (μ F)	dimensions (mm)				capacitance code
	D	B	H	S	
0.068	4.5	13	10	10	683
0.1	4.5	13	10	10	104
0.15	4.5	13	10	10	154
0.22	5	13	11	10	224
0.33	5	17.5	11	15	334
0.47	6	17.5	11.5	15	474
0.68	7	17.5	13	15	684
1.0	8.5	17.5	14.5	15	105
1.5	7.5	26	16.5	22.5	155
2.2	8.5	26	18	22.5	225
3.3	9.5	26	19	22.5	335
4.7	11	30	19.5	27.5	475
6.8	13.5	30	22	27.5	685

250 V versions

capacitance (μ F)	dimensions (mm)				catalog No. suffix	
	D	B	H	S	+20 %	+10 %
0.01	4.5	13	10	10	40103	41103
0.015	4.5	13	10	10	40153	41153
0.022	4.5	13	10	10	40223	41223
0.033	4.5	13	10	10	40333	41333
0.047	4.5	13	10	10	40473	41473
0.068	5	13	11	10	40683	41683
0.1	5	17.5	11	15	40104	41104
0.15	6	17.5	11.5	15	40154	41154
0.22	7	17.5	13	15	40224	41224
0.33	8.5	17.5	14.5	15	40334	41334
0.47	6.5	26	15.5	22.5	40474	41474
0.68	7.5	26	16.5	22.5	40684	41684
1.0	9.5	26	19	22.5	40105	41105
1.5	11	30	19.5	27.5	40155	41155
2.2	13.5	30	22.5	27.5	40225	41225

400 V versions

capacitance (μF)	dimensions (mm)				catalog No. suffix	
	D	B	H	S	+20 %	+10 %
0.01	4.5	13	10	10	50103	51103
0.15	4.5	13	10	10	50153	51153
0.022	4.5	13	10	10	50223	51223
0.033	5	13	11	10	50333	51333
0.047	5	17.5	11	15	50473	51473
0.068	6	17.5	11.5	15	50683	51683
0.1	7	17.5	13	15	50104	51104
0.15	8.5	17.5	14.5	15	50154	51154
0.22	6.5	26	15.5	22.5	50224	51224
0.33	7.5	26	16.5	22.5	50334	51334
0.47	9.5	26	19	22.5	50474	51474
0.68	11	30	19.5	27.5	50684	51684
1.0	13.5	30	22	27.5	50105	51105

630 V versions

capacitance (μF)	dimensions (mm)				catalog No. suffix	
	D	B	H	S	+20 %	+10 %
0.01	4.5	13	10	10	60103	61103
0.015	5	13	11	10	60153	61153
0.022	6	13	12	10	60223	61223
0.033	6	17.5	11.5	15	60333	61333
0.047	7	17.5	13	15	60473	61473
0.068	8.5	17.5	14.5	15	60683	61683
0.1	6.5	26	15.5	22.5	60104	61104
0.15	7.5	26	16.5	22.5	60154	61154
0.22	9.5	26	19	22.5	60224	61224
0.33	11	30	19.5	27.5	60334	61334
0.47	13.5	30	22	27.5	60474	61474

TECHNICAL PERFORMANCE

Unless otherwise specified all electrical characteristics apply to an ambient temperature of 20 ± 5 °C, an atmospheric pressure of 930-1060 mbar and a relative humidity of 45-75 %.

Working temperature range	-55/+100 °C
Maximum d.c. working voltage up to 85 °C derating	nominal voltage (V_{nom}) 1.25% per deg C above 85 °C
Maximum overvoltage for 1 minute per hour	100 and 250 V versions: 40% 400 and 630 V versions: 25%
Maximum a.c. voltage, 50-60 Hz (never to be exceeded at other frequencies)	100 V versions: 63 V 250 V versions: 160 V 400 V versions: 200 V 630 V versions: 220 V
Calculation of the dissipation	with the aid of Fig.1
Maximum dissipation	Fig.2
Maximum steepness (pulse loads) 1)	see table next page
Test voltage (d.c.) for 1 minute	1.6 x nominal voltage
Breakdown voltage of encasing	> 2500 V_{rms}
Capacitance drift during life:	
d.c. loaded, at $1.5 V_{nom}$ and 85 °C at 25 °C	< 3% < 1.5%
a.c. loaded, for B = 13 mm	< 25%
B = 17.5 mm	< 20%
B = 26 mm	< 15%
B = 30 mm	< 10%
Capacitance as a function of temperature and frequency	Fig.3 and Fig.4
Insulation resistance (at 20 °C) for $C < 0.33 \mu F$ for $C > 0.33 \mu F$	$R > 30\,000 M\Omega$ $RC > 10\,000 s (M\Omega \cdot \mu F)$
Insulation resistance as a function of temperature	Fig. 5. Decrease of minimum values is a factor 2 per 10 deg C above 20 °C.

1) Important: A metallised film capacitor must not be used in a low-impedance circuit in which any short-circuit current through the capacitor might exceed 400 mA.

→ Losses (tan δ) at 1 kHz and 20 °C
at 10 kHz and 20 °C

PETP versions : < 75 x 10⁻⁴
polycarbonate versions: < 30 x 10⁻⁴
PETP versions : < 250 x 10⁻⁴
polycarbonate versions: < 100 x 10⁻⁴

Losses as a function of temperature and frequency

Fig.6 and Fig.7

Resonance frequency

Fig.8

Category (I. E. C. 68)

55/100/56; 1300 hours at 40 °C and 90-95% R.H.

Solderability conforming to

I.E.C. 68-2, test T3.2 on 6 mm from the capacitor body

Soldering conditions for p.w. boards

5 seconds, 250 °C

Thermal shock proof

2 seconds, 350 °C

nominal voltage	pulse loads, max. steepness (V/μs)			
	dimension B			
	13 mm	17.5 mm	26 mm	30 mm
100 V	10	7	3.5	3
250 V	20	10	6	5
400 V	30	20	9	8
630 V	45	30	13	10

CALCULATION OF THE MAXIMUM A.C. VOLTAGE

A maximum permissible a.c. voltage has been specified for 50-60 Hz and at 20 °C. This voltage value must also never be exceeded at other frequencies. The permissible a.c. voltage may further be limited by the following requirements:

- 1) The power dissipation must not exceed the specified limit P_{max}.
- 2) The steepness of the a.c. voltage must not exceed the specified limit.

Ad 1.

The power dissipated by a capacitor is a function of the voltage over the series resistance (R_S) or of the current through the series resistance and is expressed by

$$P = \frac{V_{R_S}^2}{R_S} = I^2 R_S \tag{1}$$

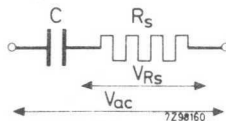

$$V_{R_S}^2 = \frac{R_S^2}{R_S^2 + 1/\omega^2 C^2} V_{ac}^2 \quad (2a)$$

As for these capacitors $\tan \delta = R_S \omega C = \text{always} < 0.1$, the formula (2a) can be simplified to

$$V_{R_S}^2 = \frac{R_S^2}{1/\omega^2 C^2} V_{ac}^2 = R_S^2 \omega^2 C^2 V_{ac}^2 \quad (2b)$$

Thus $P = R_S \omega^2 C^2 V_{ac}^2 \quad (3a)$

or $P = (R_S C) C \omega^2 V_{ac}^2 \quad (3b)$

The term $R_S C$ can be found from Fig.1. C (in farads), $\omega = 2\pi f$ and V_{ac} are assumed to be known.

The maximum permissible value of power dissipation (P_{max}), which depends on the dimensions of the capacitor and on the ambient temperature, can be found from Fig.2. Thus, when the actual power has been calculated with formula (3b), Fig.2 gives the minimum size of capacitor which can dissipate this power.

May be two or three capacitors having this size can be chosen, namely with different nominal working voltages.

Example of using Fig.1 and Fig.2

A capacitor with a dielectric of polycarbonate and a value of $1 \mu F$ should be used at an a.c. voltage $V_{ac} = 100 V$, a frequency of $1 kHz$ and an ambient temperature of $50^\circ C$.

The $R_S C$ -product is $5 \cdot 10^{-7} \Omega F$ (from Fig.1), so that the power to be dissipated

$$P = (R_S C) C \omega^2 V_{ac}^2 \\ = 5 \times 10^{-7} \times 10^{-6} \times 4\pi^2 \times 1000^2 \times 100^2 = 0.198 W$$

Fig.2 shows that at $50^\circ C$ capacitors with curve numbers 6 to 12 can be used, thus a minimum size of $7 \times 17.5 \times 13 mm$. It can be seen from the tables that a choice can be made between the 400 and 630 V capacitors of $1 \mu F$.

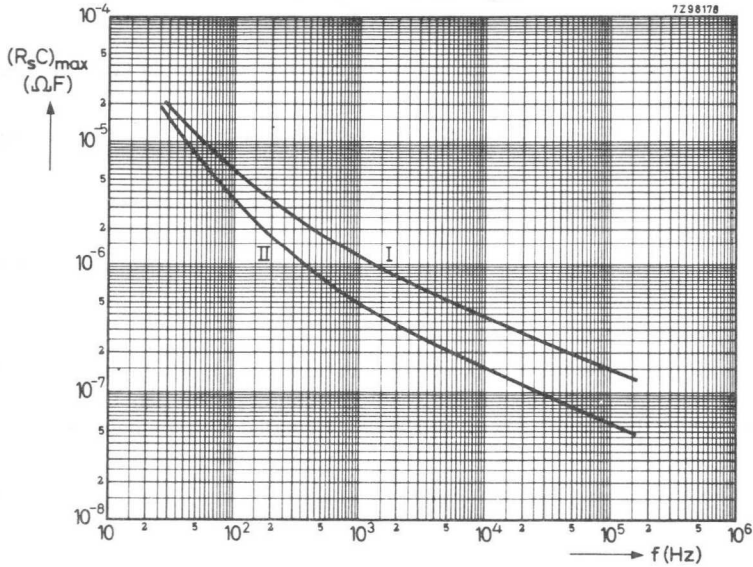
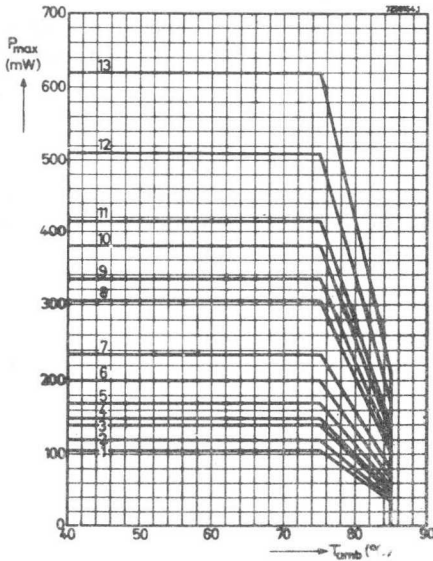

Fig.1. Maximum product of series resistance and capacitance as a function of the frequency. I = PETP versions; II = polycarbonate versions



curve	dimensions (mm)		
	D	B	H
1	4.5	13	10
2	5	13	11
3	6	13	12
4	5	17.5	11
5	6	17.5	11.5
6	7	17.5	13
7	8.5	17.5	14.5
8	6.5	26	15.5
9	7.5	26	16.5
10	8.5	26	18
11	9.5	26	19
12	11	30	19.5
13	13.5	30	22

Fig.2. Maximum permissible power dissipation as a function of the temperature

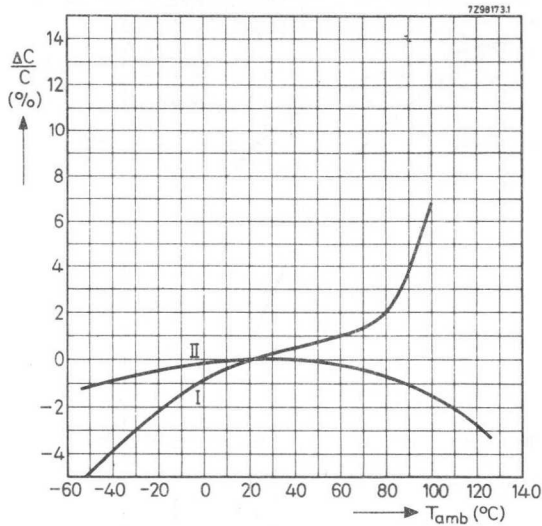

Fig. 3. Capacitance as a function of the temperature
I = PETP versions II = polycarbonate versions

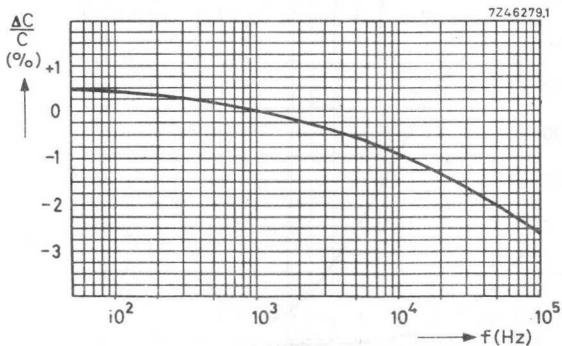

Fig. 4. Capacitance as a function of the frequency

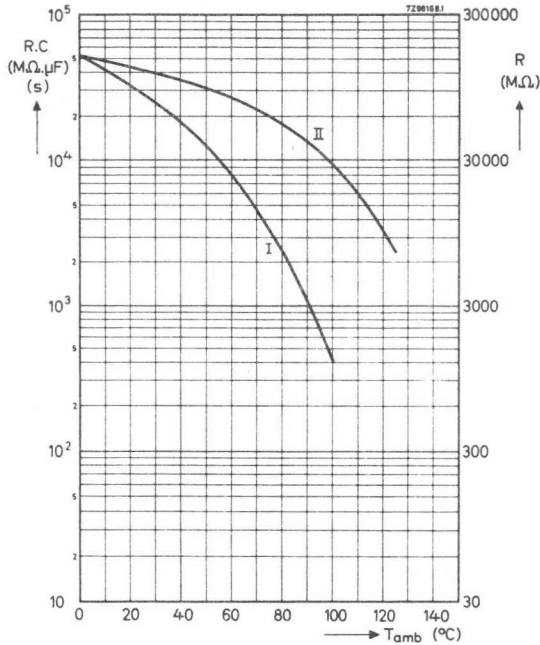

Fig.5. Insulation resistance as a function of the temperature
I = PETP versions II = polycarbonate versions

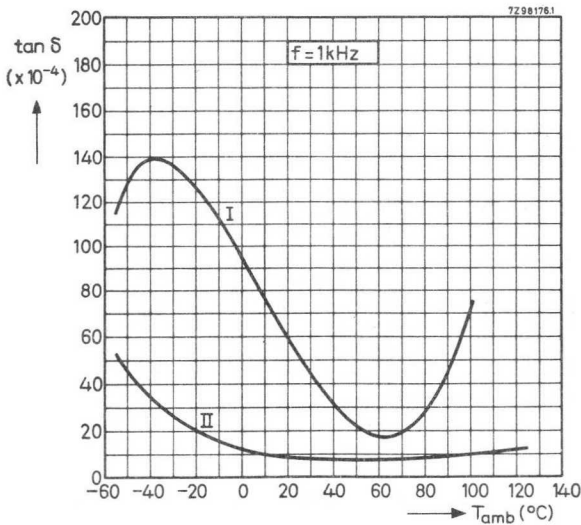

Fig.6. Losses at 1 kHz as a function of the temperature
I = PETP versions II = polycarbonate versions

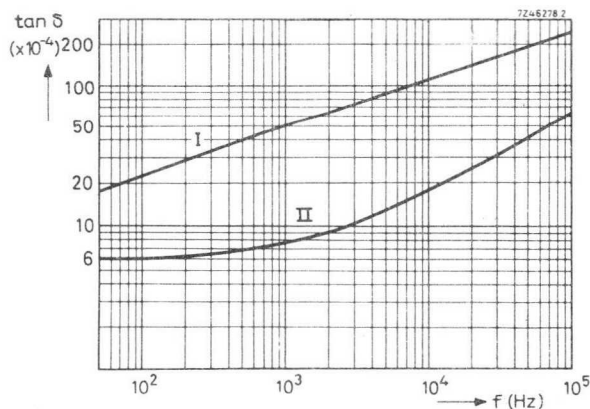

Fig. 7. Losses as a function of the frequency

I = PETP versions II = polycarbonate versions

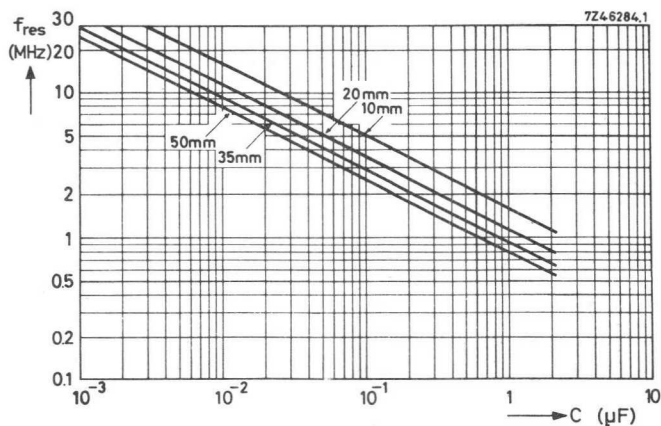

Fig. 8. Resonance frequency as a function of the capacitance,
at different total wire lengths

1955 314

1955 314

1955 314

MOULDED METALLISED POLYESTER CAPACITORS

"mepolesco" type

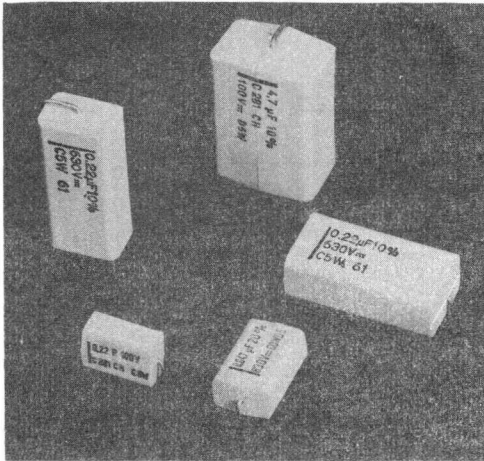

RZ 22359-2

nominal voltage	capacitance range
100 V	0.068 - 6.8 μF
250 V	0.010 - 2.2 μF
400 V	0.010 - 1.0 μF
630 V	0.010 - 0.47 μF
1000 V	0.010 - 0.15 μF
1600 V	0.001 - 0.068 μF

APPLICATION

These capacitors are designed for use as bypass and general-purpose capacitors in electronic equipment, both in the entertainment field and for industrial purposes. The throughout rectangular shape of these capacitors renders them most suitable for wobble-free mounting on printed-wiring boards, either upright or level.

Maximum overvoltage:

Special attention is drawn to the fact that the allowed 40 % overvoltage for the 100 V and 250 V versions permits these capacitors to be employed in anode and screen grid circuits, instead of previously used 400 V capacitors.

→ CONSTRUCTION

Dielectric material

of 100 V capacitors: metallised polyethyleneterephthalate (PETP) and metallised polycarbonate

of 250 V capacitors: metallised (PETP)

of 400, 630, 1000 and 1600 V capacitors: metallised polycarbonate

Dimensions in mm

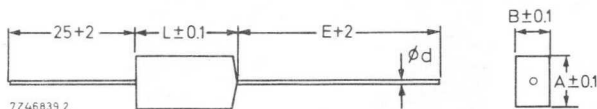

Where L = 14.5, 18 or 23.5 mm (see table): E = 40 and d = 0.8 mm;
where L = 31 mm: E = 50 and d = 1 mm.

Marking

0.1/10/250	- value in μF /tolerance/voltage
341 89104	- last 8 digits of catalog number

TYPES

Composition of the catalog number

2222 341

code for nominal voltage, _____ capacitance code, see tables
capacitance tolerance and dielectric material

polycarbonate:	polycarbonate:	PETP:
28 = 100 V, $\pm 20\%$	60 = 630 V, $\pm 20\%$	26 = 100 V, $\pm 20\%$
29 = 100 V, $\pm 10\%$	61 = 630 V, $\pm 10\%$	27 = 100 V, $\pm 10\%$
88 = 250 V, $\pm 20\%$	70 = 1000 V, $\pm 20\%$	88 = 250 V, $\pm 20\%$
89 = 250 V, $\pm 10\%$	71 = 1000 V, $\pm 10\%$	89 = 250 V, $\pm 10\%$
58 = 400 V, $\pm 20\%$	80 = 1600 V, $\pm 20\%$	
59 = 400 V, $\pm 10\%$	81 = 1600 V, $\pm 10\%$	

The capacitance values in the tables are of the E6 series. Intermediate capacitance values of the E12 series can be supplied on request.

The preferred tolerance on all values $\leq 0.22 \mu\text{F}$ is $\pm 20\%$, and on all values $> 0.22 \mu\text{F}$ it is $\pm 10\%$.

capacitance (μF)		dimensions in mm								
		100 V versions			250 V versions			400 V versions		
		A	B	L	A	B	L	A	B	L
1)	code									
0.01	103				8.7	4.7	14.5	8.7	4.7	14.5
0.015	153				8.7	4.7	14.5	8.7	4.7	14.5
0.022	223				8.7	4.7	14.5	8.7	4.7	14.5
0.033	333				8.7	4.7	14.5	9.4	5.5	14.5
0.047	473				8.7	4.7	14.5	10.4	6.5	14.5
0.068	683	8.7	4.7	14.5	9.4	5.5	14.5	10.4	6.5	18
0.1	104	8.7	4.7	14.5	10.4	6.5	14.5	11.5	7.6	18
0.15	154	9.4	5.5	14.5	10.4	6.5	18	11.5	7.4	23.5
0.22	224	10.4	6.5	14.5	11.5	7.6	18	12.8	8.7	23.5
0.33	334	10.4	6.5	18	11.5	7.4	23.5	14.4	10.4	23.5
0.47	474	11.5	7.6	18	12.8	8.7	23.5	14.6	10.4	31
0.68	684	11.5	7.4	23.5	14.4	10.4	23.5	19.5	12.4	31
1.0	105	12.8	8.7	23.5	14.6	10.4	31	22	15	31
1.5	155	14.4	10.4	23.5	19.5	12.4	31			
2.2	225	14.6	10.4	31	22	15	31			
3.3	335	19.5	12.4	31						
4.7	475	22	15	31						

1) For 0.001 to 0.0068 μF (1 to 6.8 nF) see next table.

capacitance		dimensions in mm								
		630 V versions			1000 V versions			1600 V versions		
(μ F)	code	A	B	L	A	B	L	A	B	L
0.001	102							9.4	5.5	14.5
0.0015	152							10.4	6.5	14.5
0.0022	222							10.4	6.5	18
0.0033	332							10.4	6.5	18
0.0047	472							10.4	6.5	18
0.0068	682							11.5	7.6	18
0.01	103	8.7	4.7	14.5	10.4	6.5	18	11.5	7.4	23.5
0.015	153	9.4	5.5	14.5	11.5	7.6	18	12.8	8.7	23.5
0.022	223	10.4	6.5	14.5	11.5	7.4	23.5	14.4	10.4	23.5
0.033	333	10.4	6.5	18	12.8	8.7	23.5	14.6	10.4	31
0.047	473	11.5	7.6	18	14.4	10.4	23.5	19.5	12.4	31
0.068	683	11.5	7.4	23.5	14.6	10.4	31	22	15	31
0.1	104	12.8	8.7	23.5	19.5	12.4	31			
0.15	154	14.4	10.4	23.5	22	15	31			
0.22	224	14.6	10.4	31						
0.33	334	19.5	12.4	31						
0.47	474	22	15	31						
0.68	684									
1.0	105									
1.5	155									

TECHNICAL PERFORMANCE

Unless otherwise specified all electrical characteristics apply to an ambient temperature of 20 ± 5 °C, an atmospheric pressure of 930-1060 mbar and a relative humidity of 45-75%.

Working temperature range

-55/+100 °C

Maximum d.c. working voltage

up to 85 °C

derating

nominal voltage (V_{nom})

1.25% per deg C above 85 °C

Maximum overvoltage during

1 minute per hour

100 and 250 V versions: 40%

400 and 630 V versions: 25%

→ Maximum a.c. voltage, 50 - 60 Hz
(never to be exceeded at other frequencies)

100 V versions: 63 V

250 V versions: 160 V

400 V versions: 200 V

630 V versions: 220 V

1000 and 1600 V versions: 250 V

Calculation of the dissipation

with the aid of Fig.1

Maximum dissipation

Fig.2

Maximum steepness (pulse loads):

(See also the note below)

nominal voltage	dimension L			
	14.5 mm	18 mm	23.5 mm	31 mm
100 V	10 V/ μ s	7	4	3
250 V	20	10	7	5
400 V	30	20	10	8
630 V	45	30	15	10
1000 V	-	45	30	20
1600 V	200	90	50	30

Test voltage (d.c.) for 1 minute 1.6 x nominal voltage

 Breakdown voltage of encasing > 2500 V_{rms}

Capacitance drift during life

 d.c. loaded, at 1.5 x V_{nom} and 85 °C < 3%
 at 25 °C < 1.5%

a.c. loaded (max. a.c. voltage)

for L = 14 mm < 25%

L = 17.5 mm < 20%

L = 23 mm < 15%

L = 30 mm < 10%

Capacitance as a function of temperature and frequency

Fig.3 and Fig.4

Insulation resistance (at 20 °C)

for C ≤ 0.33 μF

for C > 0.33 μF

R > 30 000 MΩ

RC > 10 000 s (MΩ.μF)

Insulation resistance as a function of temperature

Fig.5. Decrease of minimum values is a factor 2 per 10 deg C above 20 °C.

Losses (tan δ) at 1 kHz (and 20 °C)

 PETP versions : < 75 x 10⁻⁴

 polycarbonate versions: < 30 x 10⁻⁴

at 10 kHz (and 20 °C)

 PETP versions : < 250 x 10⁻⁴

 polycarbonate versions: < 100 x 10⁻⁴

Losses as a function of temperature and frequency

Fig.6 and Fig.7

Resonance frequency

Fig.8

Category (I.E.C. 68)

55/100/56; 1300 hrs at 40 °C and 90-95% R.H.

Solderability conforming to

I.E.C. 68-2, test T3.2 on 6 mm from the capacitor body

Important: A metallised film capacitor must not be used in a low-impedance circuit in which any short-circuit current through the capacitor might exceed 400 mA. ←

Soldering conditions for stress-free mounted capacitors

solder temperature	max. solder time for distance between solder point and capacitor body				
	0.8 mm	1.6 mm	2.5 mm	4 mm	6 mm
250 °C		5 s	6 s	8 s	10 s
260 °C	2.5 s	3 s	4 s	6 s	8 s
270 °C			2 s	4 s	6 s

Thermal shock proof

2 seconds, 350 °C

CALCULATION OF THE MAXIMUM A.C. VOLTAGE

A maximum permissible a.c. voltage has been specified for 50-60 Hz and at 20 °C. This voltage value must also never be exceeded at other frequencies. The permissible a.c. voltage may further be limited by the following requirements:

- 1) To power dissipation must not exceed the specified limit P_{max} .
- 2) The steepness of the a.c. voltage must not exceed the specified limit.

Ad 1.

The power dissipated by a capacitor is a function of the voltage over the series resistance (R_s) or of the current through the series resistance and is expressed by

$$P = \frac{V_{R_s}^2}{R_s} = I^2 R_s \tag{1}$$

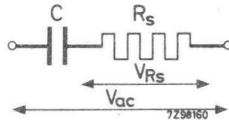

$$V_{R_s}^2 = \frac{R_s^2}{R_s^2 + 1/\omega^2 C^2} V_{ac}^2 \tag{2a}$$

As for these capacitors $\tan \delta = R_s \omega C$ is always < 0.1 , the formula (2a) can be simplified to

$$V_{R_s}^2 = \frac{R_s^2}{1/\omega^2 C^2} V_{ac}^2 = R_s^2 \omega^2 C^2 V_{ac}^2 \tag{2b}$$

Thus $P = R_s \omega^2 C^2 V_{ac}^2 \tag{3a}$

or $P = (R_s C) C \omega^2 V_{ac}^2 \tag{3b}$

The term $R_s C$ can be found from Fig.1. C (in farads), $\omega = 2\pi f$ and V_{ac} are assumed to be known.

The maximum permissible value of power dissipation (P_{\max}), which depends on the dimensions of the capacitor and on the ambient temperature, can be found from Fig.2. Thus, when the actual power has been calculated with formula (3b), Fig.2 gives the minimum size of capacitor which can dissipate this power.

Maybe two or three capacitors having this size can be chosen, namely with different nominal working voltages.

Example of using Fig.1 and Fig.2

A capacitor with a dielectric of polycarbonate and a value of $1 \mu\text{F}$ should be used at an a.c. voltage $V_{\text{ac}} = 140 \text{ V}$, a frequency of 1 kHz and an ambient temperature of 50°C .

The R_sC -product is $5 \cdot 10^{-7} \Omega\text{F}$ (from Fig.1), so that the power to be dissipated

$$P = (R_sC) C \omega^2 V_{\text{ac}}^2$$

$$= 5 \times 10^{-7} \times 10^{-6} \times 4\pi^2 \times 1000^2 \times 140^2 = 0.39 \text{ W.}$$

Fig.2 shows that at 50°C capacitors with curve numbers 9 to 11 can be used, thus a minimum size of $14.6 \times 10.4 \times 30 \text{ mm}$. It can be seen from the tables that the $1 \mu\text{F} - 400 \text{ V}$ capacitor can be chosen.

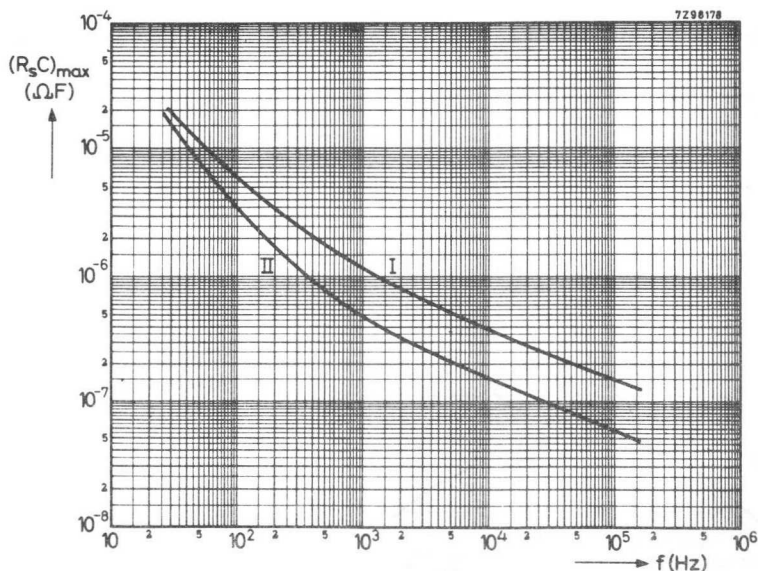
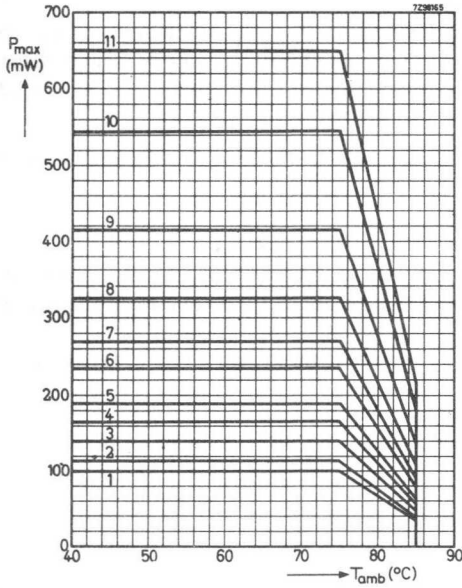

Fig.1. Maximum product of series resistance and capacitance as a function of the frequency

I = PETP versions II = polycarbonate versions



curve	dimension (mm)		
	A	B	L
1	8.7	4.7	14.5
2	9.4	5.5	14.5
3	10.4	6.5	14.5
4	10.4	6.5	18
5	11.5	7.6	18
6	11.5	7.4	23.5
7	12.8	8.7	23.5
8	14.4	10.4	23.5
9	14.6	10.4	31
10	19.5	12.4	31
11	22	15	31

Fig.2. Maximum permissible power dissipation as a function of the temperature

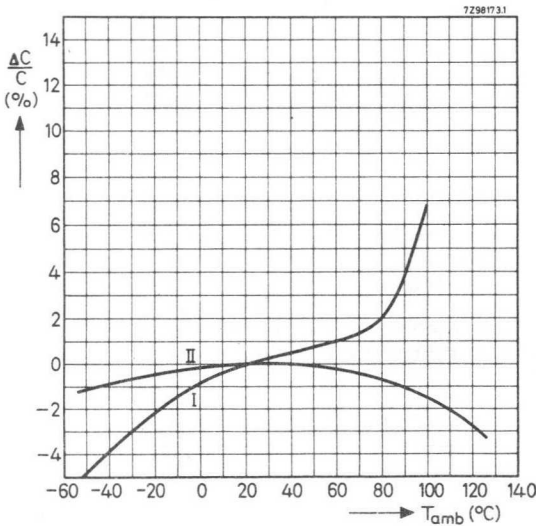

I = PETP versions
II = polycarbonate versions

Fig.3. Capacitance as a function of the temperature

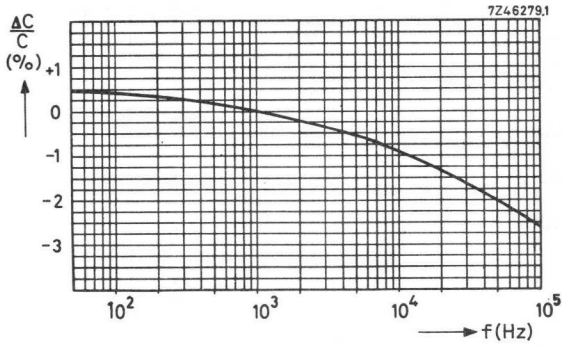

Fig. 4. Capacitance as a function of the frequency

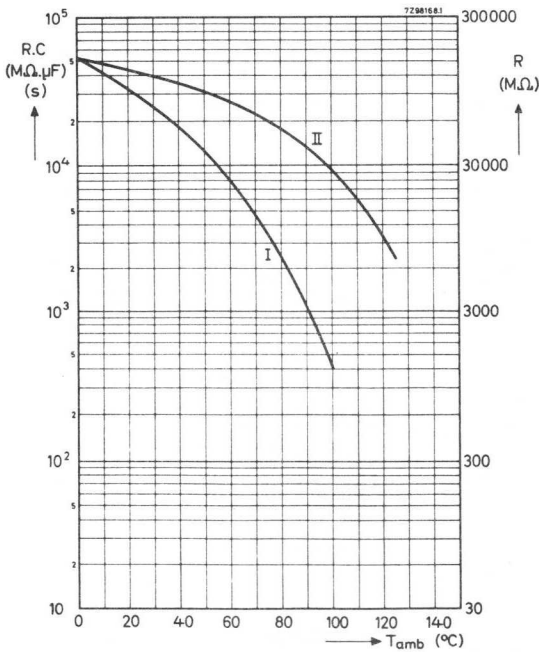

Fig. 5. Insulation resistance as a function of the temperature

I = PETP versions

II = Polycarbonate versions

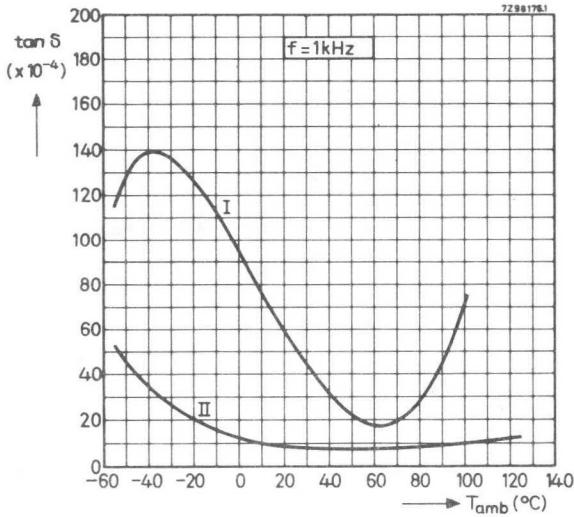

Fig. 6. Losses at 1 kHz as a function of the temperature
I = PETP versions II = polycarbonate versions

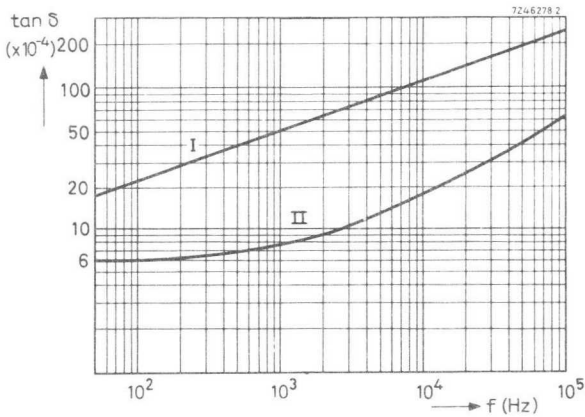

Fig. 7. Losses as a function of the frequency
I = PETP versions II = polycarbonate versions

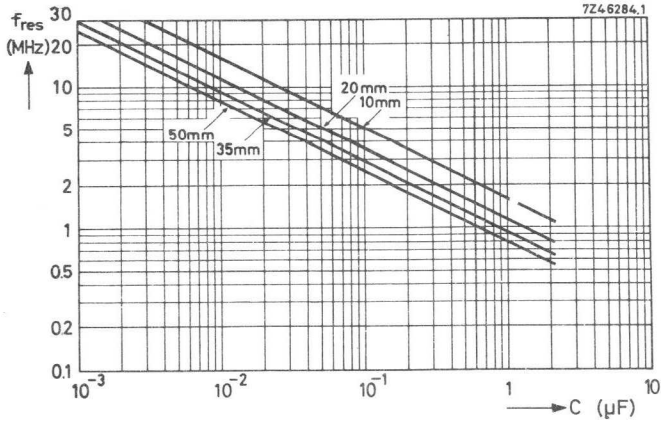
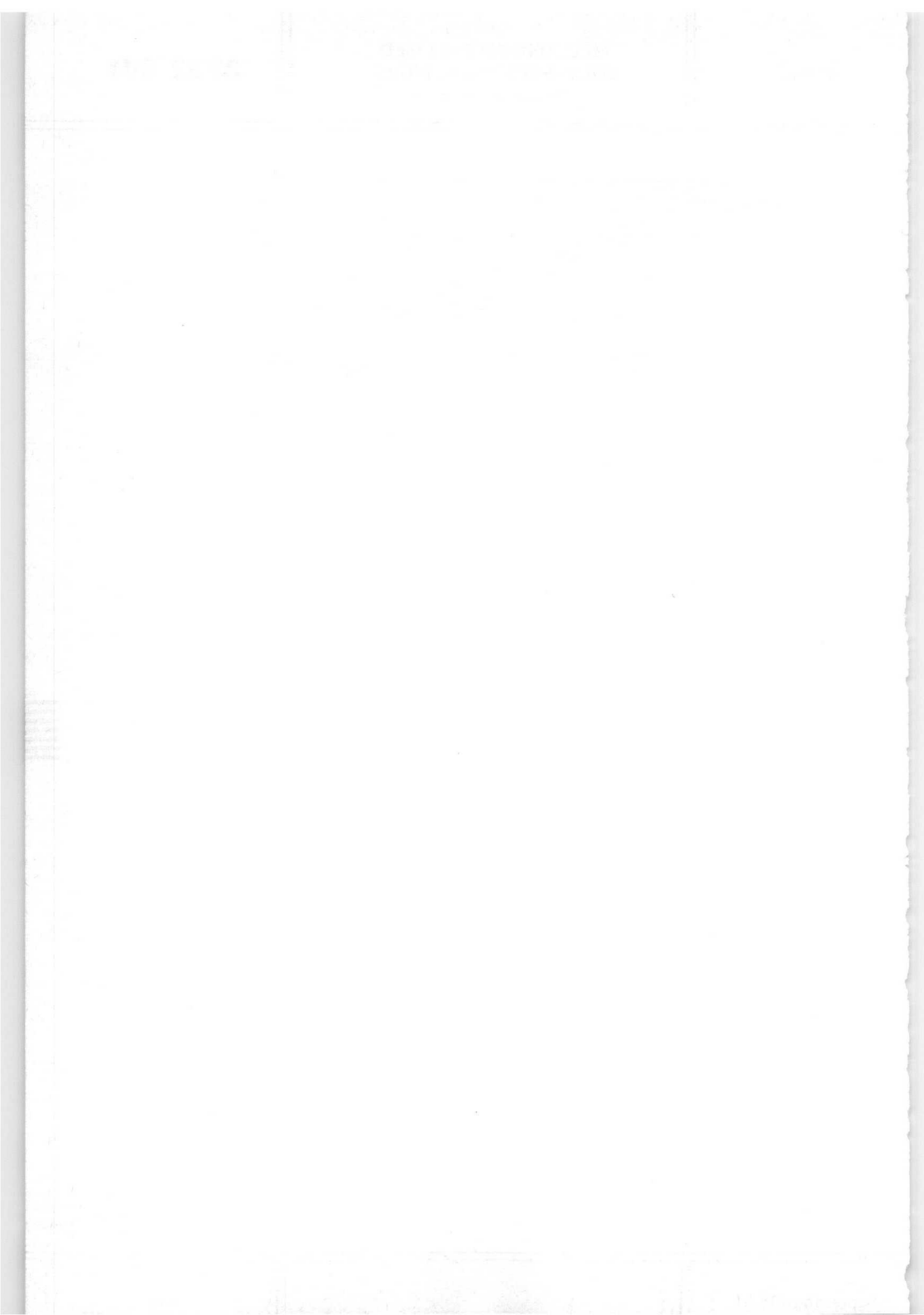
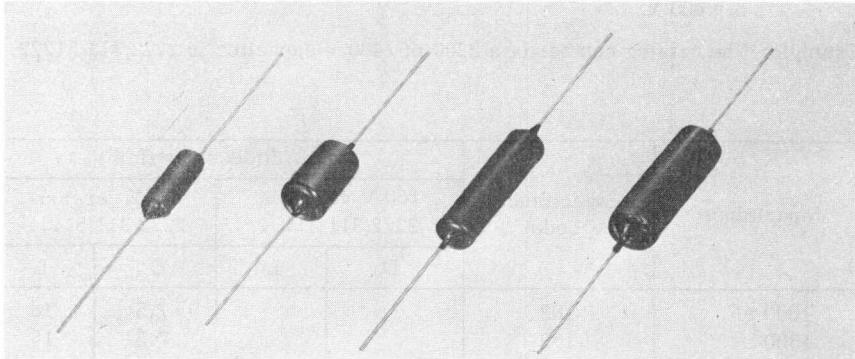

Fig.8. Resonance frequency as a function of the capacitance, at different total wire lengths



POLYESTER CAPACITORS

tubular foil type



C 60505

Nominal voltage	160 V	400 V
Capacitance range	0.01-1 μF	0.001-0.470 μF

APPLICATION

These are very reliable general purpose capacitors for electronic circuits. They have found wide-spread acceptance not only in the radio and television industry, but also in industrial electronics.

CONSTRUCTION

Dielectric material

polyethylene-terephthalate

Dimensions in mm

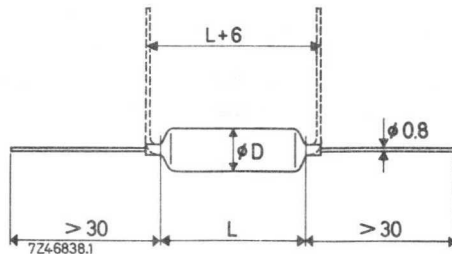

TYPES

Composition of the catalog number

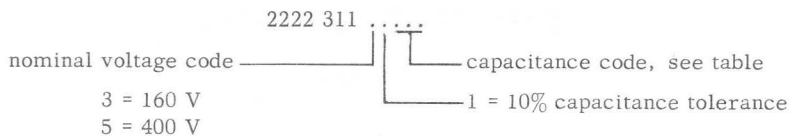

Example: The catalog number of a 2200 pF/400 V capacitor is 2222 311 51222.

capacitance	capacitance code	max. dimensions (mm)			
		160 V versions 2222 311 31...		400 V versions 2222 311 51...	
		D	L	D	L
1000 pF	102			7.5	18
1500	152			7.5	18
2200	222			7.5	18
3300	332			7.5	18
4700	472			7.5	18
6800	682			7.5	18
0.010 μ F	103	7.5	18	7.5	18
0.015	153	7.5	18	7.5	18
0.022	223	7.5	18	8.5	18
0.033	333	7.5	18	10	18
0.047	473	8	18	11.5	18
0.068	683	9	18	9.5	32
0.10	104	10.5	18	11	32
0.15	154	12	18	12.5	32
0.22	224	10	32	14.5	32
0.33	334	12	32	17	32
0.47	474	14	32	19.5	32
0.68	684	16	32		
1.0	105	18.5	32		

Intermediate values according to the E12 range are available on request. The dimensions are identical to those of the next higher value in the standard E6 range.

The standard capacitance tolerance is $\pm 10\%$.

TECHNICAL PERFORMANCE

Unless otherwise specified all electrical characteristics apply to an ambient temperature of 20 ± 5 °C, an atmospheric pressure of 930-1060 mbar and a relative humidity of 45-75 %.

Working temperature range	-40/+85 °C
Maximum d.c. working voltage up to 85 °C	nominal voltage (V_{nom})
Maximum a.c. voltage, 50-60 Hz (never to be exceeded at other frequencies)	160 V versions: 90 V 400 V versions: 150 V
Calculation of the dissipation	with the aid of Fig.1
Maximum dissipation	Fig.2
Test voltage (d.c.) for 1 minute	2 x nominal voltage
Capacitance drift during life	
d.c. loaded, at $1.5xV_{nom}$ and 85 °C	< 5%
at 25 °C	< 2%
a.c. loaded	< 5%
Capacitance as a function of temperature and frequency	Fig.3 and Fig.4
Insulation resistance (at 20 °C)	
for $C \leq 0.33 \mu F$	$R > 50\,000 M\Omega$
for $C > 0.33 \mu F$	$R_C > 16\,500 s (M\Omega \cdot \mu F)$
Insulation resistance as a function of temperature	Fig.5. Decrease of minimum values is a factor 2 per 10 deg C above 20 °C
Losses ($\tan \delta$) at 1 kHz (and 20 °C)	< 60×10^{-4}
Losses as a function of temperature and frequency	Fig.6 and Fig.7
Resonance frequency	Fig.8
Climatic robustness	category 40/085/21; 500 hours at 40 °C and 90-95 % R.H.
Solderability conforming to	I.E.C. 68-2, test T3.2 on 6 mm from the capacitor body
Axial lead strength	> 10 N (> 1 kg)

CALCULATION OF THE MAXIMUM A.C. VOLTAGE

A maximum permissible a.c. voltage has been specified for 50-60 Hz and at 20 °C. This voltage value must also never be exceeded at other frequencies. The permissible a.c. voltage may further be limited by the requirement that the power dissipation must not exceed the specified limit P_{\max} .

The power dissipated by a capacitor is a function of the voltage over the series resistance (R_S) or of the current through the series resistance and is expressed by

$$P = \frac{V_{R_S}^2}{R_S} = I^2 R_S \quad (1)$$

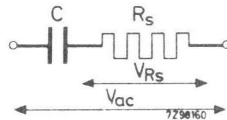

$$V_{R_S}^2 = \frac{R_S^2}{R_S^2 + 1/\omega^2 C^2} V_{ac}^2 \quad (2a)$$

As for these capacitors $\tan \delta = R_S \omega C =$ always < 0.1 , the formula (2a) can be simplified to

$$V_{R_S}^2 = \frac{R_S^2}{1/\omega^2 C^2} V_{ac}^2 = R_S^2 \omega^2 C^2 V_{ac}^2 \quad (2b)$$

Thus
$$P = R_S \omega^2 C^2 V_{ac}^2 \quad (3a)$$

or
$$P = (R_S C) C \omega^2 V_{ac}^2 \quad (3b)$$

The term $R_S C$ can be found from Fig. 1. C (in farads), $\omega = 2\pi f$ and V_{ac} are assumed to be known.

The maximum permissible value of power dissipation (P_{\max}), which depends on the dimensions of the capacitor and on the ambient temperature, can be found from Fig. 2. Thus, when the actual power has been calculated with formula (3b), Fig. 2 gives the minimum size of capacitor which can dissipate this power.

May be two or three capacitors having this size can be chosen, namely with different nominal working voltages.

Example of using Fig.1 and Fig.2

A tubular foil capacitor with a value of $0.47 \mu\text{F}$ should be used at an a.c. voltage of $V_{\text{ac}} = 80 \text{ V}$, a frequency of 1 kHz and an ambient temperature of $50 \text{ }^\circ\text{C}$. The $R_{\text{S}}C$ -product is 10^{-6} (from Fig.1), so that the power to be dissipated

$$P = (R_{\text{S}}C) C \omega^2 V_{\text{ac}}^2$$

$$= 10^{-6} \times 0.47 \times 10^{-6} \times 4\pi^2 \times 1000^2 \times 80^2 = 0.123 \text{ W}$$

Fig.2 shows that at $50 \text{ }^\circ\text{C}$ capacitors with curve numbers 3 to 27 can be used, thus a minimum size of $8.5 \times 18 \text{ mm}$. It can be seen from the table that a choice can be made between the 160 V and the 400 V capacitors of $0.47 \mu\text{F}$.

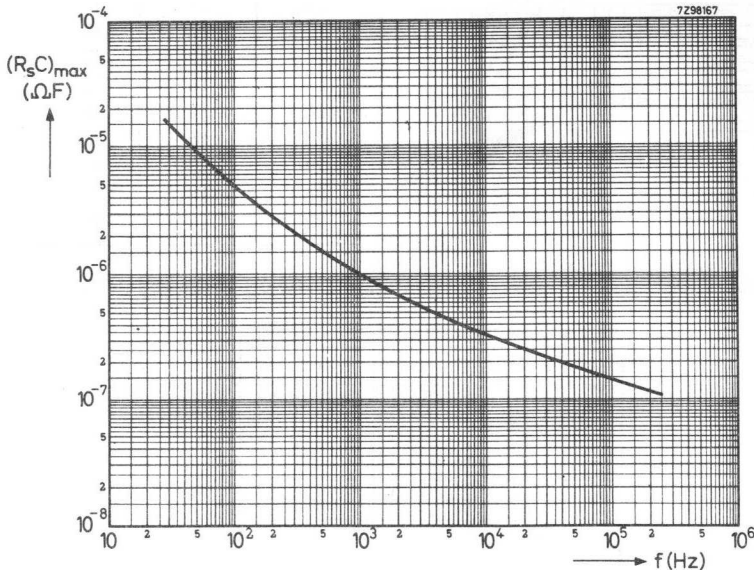
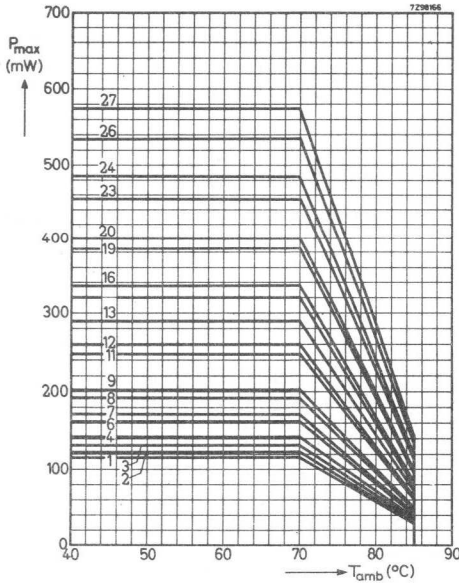

Fig.1. Maximum product of series resistance and capacitance as a function of the frequency



curve	dimensions (mm)	
	D	L
1	7.5	18
2	8	18
3	8.5	18
4	9	18
6	10	18
7	10.5	18
8	11.5	18
9	12	18
11	9.5	32
12	10	32
13	11	32
15	12	32
16	12.5	32
19	14	32
20	14.5	32
23	16	32
24	17	32
26	18.5	32
27	19.5	32

Fig. 2. Maximum permissible power dissipation as a function the temperature

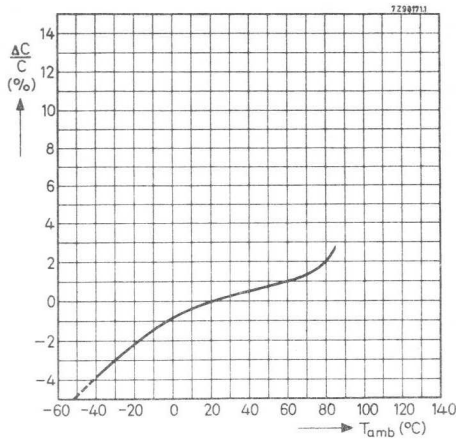

Fig. 3. Capacitance as a function of the temperature

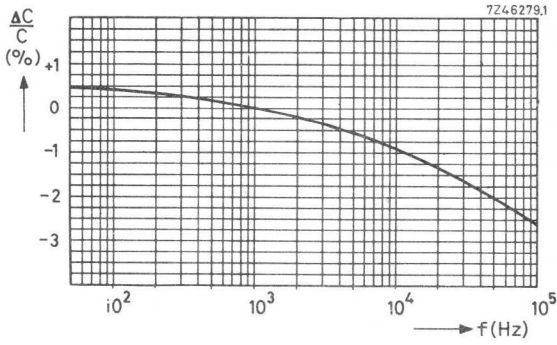

Fig. 4. Capacitance as a function of the frequency

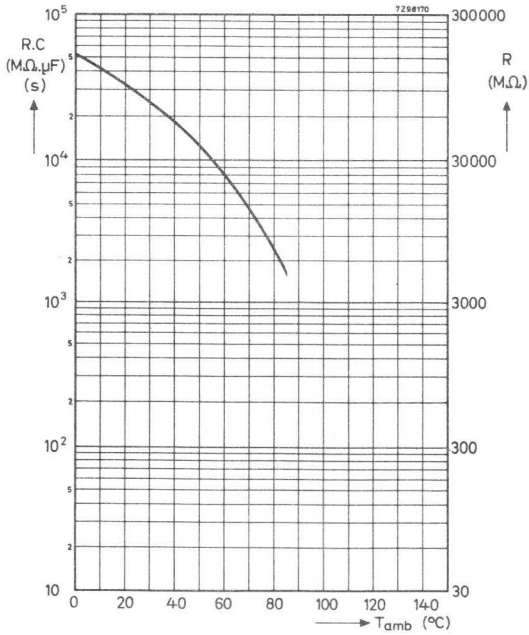

Fig. 5. Insulation resistance as a function of the temperature

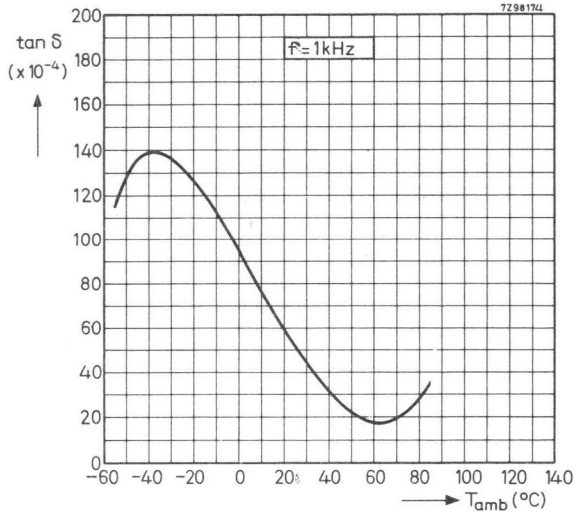

Fig.6. Losses at 1 kHz as a function of the temperature

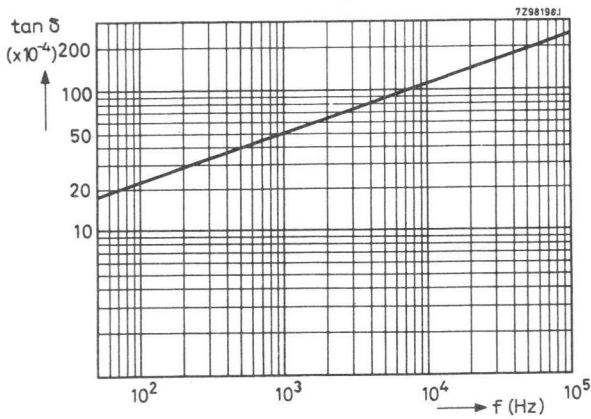

Fig.7. Losses as a function of the frequency

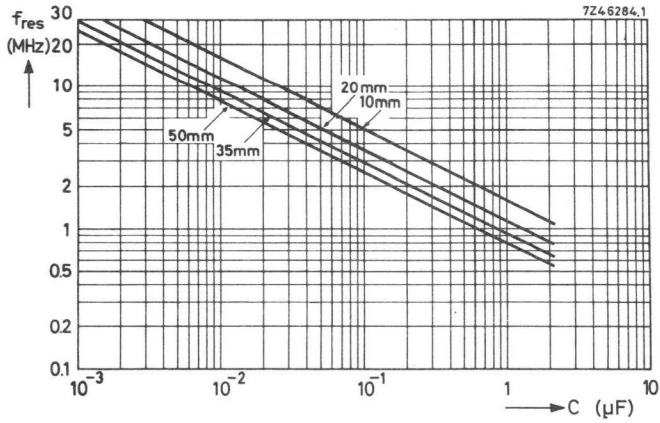
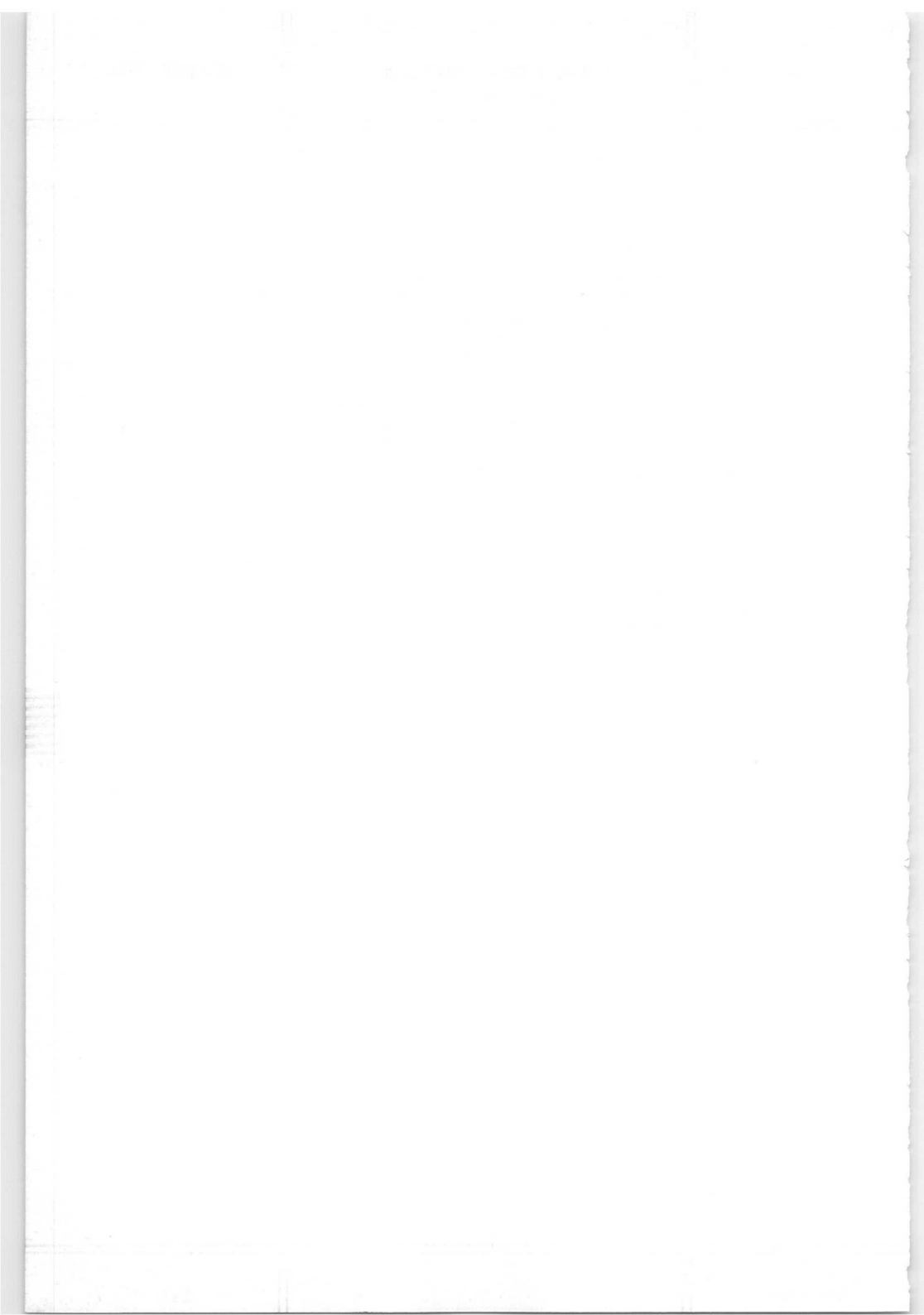

Fig. 8. Resonance frequency as a function of the capacitance, at different total wire lengths



MINIATURE POLYSTYRENE CAPACITORS

'micropoco' type

Nominal voltage
Capacitance range

63 V
820-3300 pF

125 V
100-1500 pF

APPLICATION

These capacitors are suitable for use in tuned circuits and electronic filters of all kinds, in telephony equipment etc., where high requirements are imposed as regards precision, stability and low losses at high frequencies. Because of their construction, characteristics and range of values and tolerances these capacitors can provide replacement for any other miniature polysterene capacitor. The leads have a diameter of 0.6 mm and are exactly centred, so that the capacitors can be economically handled by bending and cutting machines. The leads are long enough to be bent for vertical mounting on printed wiring boards.

CONSTRUCTION

The capacitors are of the extended-foil construction, which results in a low self-inductance, low series resistance and consequently low high-frequency losses, whereas also the working temperature range is very favourable.

Dimensions in mm

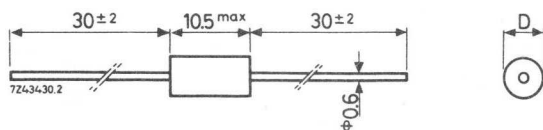

TYPES

Composition of the catalog number

Nominal voltage 63 V: 2222 424

Nominal voltage 125 V: 2222 425

code for capacitance tolerance

2 for $\pm 5\%$

3 for $\pm 2\%$

4 for $\pm 1\%$

capacitance value in code,
see tables

For available tolerances see also the note below.

63 V capacitors:

capacitance		diam. D (mm)
(pF)	code	
820	8201	≤ 3
910	9101	
1000	1002	
1100	1102	
1200	1202	
1300	1302	≤ 3.5
1500	1502	
1600	1602	
1800	1802	
2000	2002	
2200	2202	≤ 4
2400	2402	
2700	2702	
3000	3002	
3300	3302	≤ 4.5

125 V capacitors:

capacitance		diam. D (mm)
(pF)	code	
100	1001	≤ 3.5
110	1101	
120	1201	
130	1301	
150	1501	
160	1601	
180	1801	
200	2001	
220	2201	
240	2401	
270	2701	
300	3001	
330	3301	
360	3601	
390	3901	
430	4301	≤ 3
470	4701	
510	5101	
560	5601	
620	6201	
680	6801	
750	7501	≤ 3.5
820	8201	
910	9101	
1000	1002	
1100	1102	
1200	1202	≤ 4
1300	1302	
1500	1502	

Note: Intermediate capacitance values of the E96 series ($\pm 1\%$) and E48 series ($\pm 1\%$ or 2% .) are available on request. See list at the back of this book.



TECHNICAL PERFORMANCE

Unless otherwise specified all electrical characteristics apply to an ambient temperature of 20 ± 5 °C, an atmospheric pressure of 930-1060 mbar and a relative humidity of 45-75%.

Working temperature range, 63 V series	-40 to +70 °C
125 V series	-40 to +85 °C
Max. d.c. voltage up to max. temperature	nominal voltage (V_{nom})
Maximum a.c. voltage, 63 V series	25 V
125 V series	63 V
Test voltage (d.c.) for 1 minute	2 x nominal voltage
Capacitance tolerances, E24 series	± 1 , ± 2 and $\pm 5\%$
E48 series	± 1 and $\pm 2\%$
E96 series	$\pm 1\%$
Temperature coefficient at 20-70 °C	$(-140 \pm 40) 10^{-6}/\text{deg C}$
Capacitance drift after 1000 h endurance test at $1.5 \times V_{nom}$,	
63 and 125 V versions at 70 °C	< 0.3%
125 V versions at 85 °C	< 0.5%
Capacitance drift after 21 days humidity test (I.E.C.)	< 1%
Insulation resistance	
at 20 °C	> 10^5 M Ω
at higher temperature	decrease is a factor 2 per 20 deg C above 20 °C
Losses ($\tan \delta$) at 1 kHz	< 2×10^{-4}
at 100 kHz	< 3×10^{-4}
at 1 MHz	< 5×10^{-4}
Category (I.E.C. 68) 63 V series	40/070/21
125 V series	40/085/21
	(both 500 h at 40 °C and 90-95% R.H.)
Solderability conforms to	I.E.C. 68-2, test T3.2 on 6 mm from the capacitor body

2222 424
2222 425

MINIATURE POLYSTYRENE CAPACITORS
micropoco type

(C279)

Soldering conditions for p.w. boards
normal applications
vertical mounting

230 °C during 2 seconds

270 °C during 2 seconds

solder time (s)	solder temp. (°C)	ΔC max. (%)
2	260	1
3	260	2
3	240	1
5	240	2 1)

Thermal shock

350 °C during 3 seconds

Axial lead strength

> 20 N (> 2 kg)

1) In case of forced cooling of the print within 5 seconds after dipsoldering at 240 °C during 5 seconds, a capacitance change of max. 0.5% may be expected.

TUBULAR MOULDED POLYSTYRENE CAPACITORS

'minipoco' type

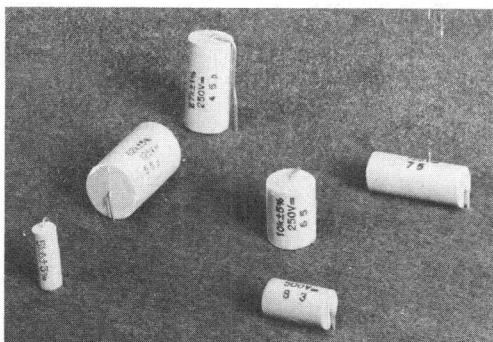

RZ 22359-1

nominal voltage	capacitance range
63 V	3.6 - 160 nF
125 V	1.5 - 82 nF
250 V	1.3 - 47 nF
500 V	0.68 - 24 nF

These capacitors are suitable for use in tuned circuits and electronic filters of all kinds, in carrier telephony equipment etc. where high requirements are imposed as regards precision, stability and low losses at high frequencies. The fairly small negative temperature coefficient is advantageous for most applications.

The leads are long enough to be bent for vertical mounting on printed-wiring boards.

CONSTRUCTION

These capacitors are of the extended-foil construction, which results in a low self-inductance, low series resistance and consequently low high-frequency losses, whereas also the working temperature range is very favourable. They are moulded in lecodite.

Dimensions in mm

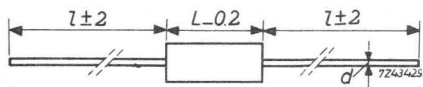

at L	l	d
15	35	0.7
25	45	0.8

TYPES

Composition of the catalog number

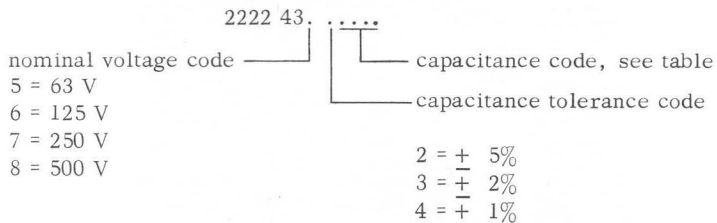

Example: The catalog No. of a 6200 pF/125 V capacitor, tolerance 5% is
2222 436 26202

The table lists the capacitance values according to the E24 series. Intermediate values of the E48 series (with 1 and 2% tolerance) and of the E96 series (with 1% tolerance) can be supplied on request. The dimensions are identical to those of the next higher value given in the table.

capacitance	capacitance code	dimensions in mm (D × L)			
		63 V	125 V	250 V	500 V
680 pF	6801				7.5 × 15
750	7501				
820	8201				
910	9101				
1 000	1002				
1 100	1102				
1 200	1202				9 × 15
1 300	1302				
1 500	1502				
1 600	1602				
1 800	1802		6 × 15	7.5 × 15	10 × 15
2 000	2002				
2 200	2202				
2 400	2402				
2 700	2702				10 × 15
3 000	3002		7.5 × 15	9 × 15	
3 300	3302				

(C295)
(2222 422)

TUBULAR MOULDED
POLYSTYRENE CAPACITORS
minipoco type

2222 435-
2222 438

capacitance	capacitance code	dimensions in mm (D x L)			
		63 V	125 V	250 V	500 V
3 600 pF	3602	6 x 15	7.5 x 15	9 x 15	12.5 x 15
3 900	3902			9 x 15	
4 300	4302		7.5 x 15		
4 700	4702			10 x 15	12.5 x 15
5 100	5102		9 x 15		
5 600	5602			10 x 15	12.5 x 25
6 200	6202	7.5 x 15	10 x 25		
6 800	6802			9 x 15	12.5 x 25
7 500	7502	10 x 15	15 x 25		
8 200	8202			12.5 x 15	12.5 x 25
9 100	9102	9 x 15	15 x 25		
0.010 μ F	1003			10 x 15	12.5 x 25
0.011	1103	12.5 x 15	15 x 25		
0.012	1203			9 x 15	12.5 x 25
0.013	1303	10 x 15	15 x 25		
0.015	1503			12.5 x 15	12.5 x 25
0.016	1603	10 x 15	15 x 25		
0.018	1803			12.5 x 15	12.5 x 25
0.020	2003	10 x 15	15 x 25		
0.022	2203			12.5 x 15	12.5 x 25
0.024	2403	10 x 15	15 x 25		
0.027	2703			12.5 x 15	12.5 x 25
0.030	3003	10 x 15	15 x 25		
0.033	3303			12.5 x 15	12.5 x 25
0.036	3603	10 x 15	15 x 25		
0.039	3903			12.5 x 15	12.5 x 25
0.043	4303	10 x 15	15 x 25		
0.047	4703			12.5 x 15	12.5 x 25
0.051	5103	10 x 15	15 x 25		
0.056	5603			12.5 x 15	12.5 x 25
0.062	6203	10 x 15	15 x 25		
0.068	6803			12.5 x 15	12.5 x 25
0.075	7503	10 x 15	15 x 25		
0.082	8203			12.5 x 15	12.5 x 25
0.091	9103	10 x 15	15 x 25		
0.10	1004			12.5 x 15	12.5 x 25
0.11	1104	10 x 15	15 x 25		
0.12	1204			12.5 x 15	12.5 x 25
0.13	1304	10 x 15	15 x 25		
0.15	1504			12.5 x 15	12.5 x 25
0.16	1604	15 x 25			

TECHNICAL PERFORMANCE

Unless otherwise specified all electrical characteristics apply to an ambient temperature of 20 ± 5 °C, an atmospheric pressure of 930-1060 mbar and a relative humidity of 45-75 %.

Working temperature range, 63 V series	-40 to +70 °C
125 to 500 V series	-40 to +85 °C
Max. d.c. voltage up to max. temperature	nominal voltage (V_{nom})
Maximum a.c. voltage, 63 V series	30 V
(up to max. temperature) 125 V series	63 V
250 V series	125 V
500 V series	250 V
Test voltage (d.c.) for 1 min.	2 x nominal voltage
Breakdown voltage of encasing	> 1000 V_{rms}
Maximum a.c. current, based on a self-heating of 10 °C and an ambient temperature of 60 °C	1 A
Capacitance tolerances, E24 series	± 1 , ± 2 and ± 5 %
E48 series	± 1 and ± 2 %
E96 series	± 1 %
Temperature coefficient	$(-100 \pm 50) 10^{-6}/deg C$
Capacitance drift during life, with respect to actual value on delivery:	
63 V versions, at ≤ 70 °C	< 0.3%
125 to 500 V versions, at ≤ 85 °C	< 1 %
Insulation resistance for $C < 0.1 \mu F$	> $10^6 M\Omega$
for $C \geq 0.1 \mu F$	> $10^5 M\Omega$
H.F. contact safety	still contact proof for voltage levels < 1 mV
Losses. (tan δ) at 1 kHz	< 2×10^{-4}
at 100 kHz	< 5×10^{-4}
at 1 MHz	< 10×10^{-4}
Climatic robustness, 63 V series	category 40/070/21 (I.E.C. 68)
125 to 500 V series	category 40/085/21 (both 500 h at 40 °C and 90-95% R.H.)
Solderability conforms to	I.E.C. 68-2, test T 3.2 on 6 mm from the capacitor body

Soldering conditions:

p.w. board thickness 1.5 mm and
horizontal mounting

250 °C, 5 seconds (1)

p.w. board thickness 1.5 mm and
vertical mounting

250 °C, 5 seconds (2)

solder iron on 5 mm from
capacitor body

350 °C, 10 seconds(3)

Capacitance change by above conditions

- (1), $C < 10 \text{ nF}$, 63 V versions
- (1), $C > 10 \text{ nF}$
- (2)
- (3)

- < 1%
- < 0.3%
- < 0.2%
- < 0.3%

Axial lead strength

> 20 N (> 2 kg)

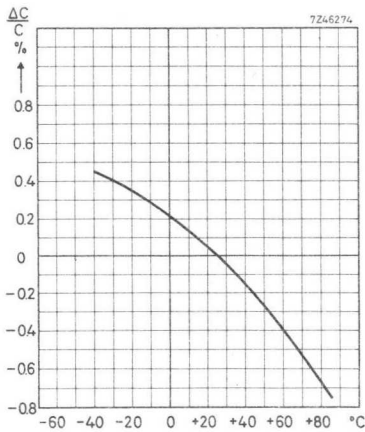

Capacitance as a function
of the temperature

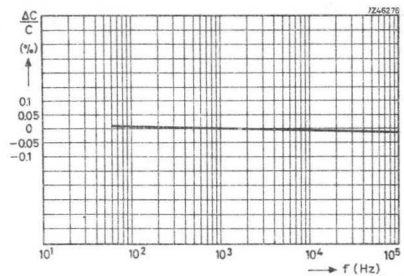

Capacitance as a function
of the frequency

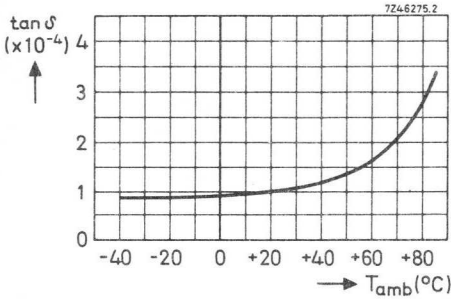

Losses at 1 kHz at a function
of the temperature

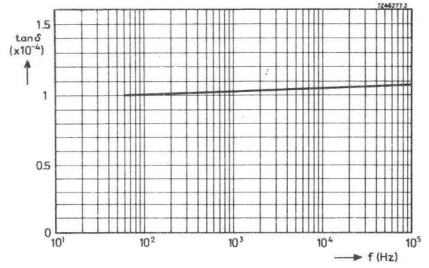

Losses as a function
of the frequency

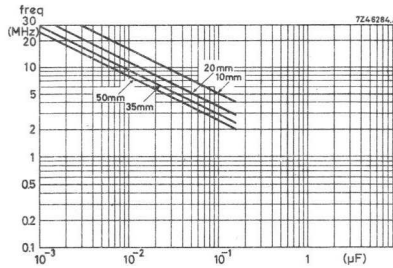

Resonance frequency as a function of the capacitance,
at different total wire lengths

PAPER D.C. CAPACITORS

rectangular box type

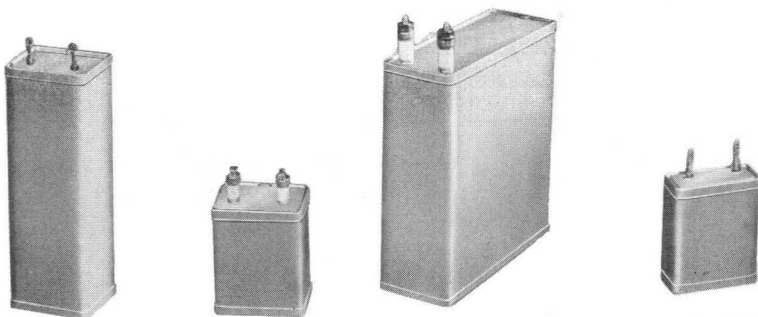

C 40188

These capacitors are suitable for apparatus and installations on which the severest demands are imposed such as stationary and mobile telecommunication installations and measuring apparatus (e.g. for coupling, decoupling and smoothing in transmitters and amplifiers, as separating capacitors in filter circuits and suchlike).

Tolerance on capacitance	$\pm 10\%$
Working temperature range	-40 to $+70$ °C
Maximum working voltage (V_{nom})	above 40 °C to be derated by $0.9\%/deg$ C
Maximum alternating voltage (50 - 60 Hz)	250 V_{dc} versions 175 V_{ac} 500 V_{dc} versions 250 V_{ac} 1000 V_{dc} versions 330 V_{ac} 2000 V_{dc} versions 484 V_{ac} 3400 V_{dc} versions 825 V_{ac}
Capacitance drift during life	$\leq 5\%$
Test voltage for 1 minute between terminals	250 V_{dc} versions 650 V_{dc} 500 V_{dc} versions 1300 V_{dc} 1000 V_{dc} versions 1940 V_{dc} 2000 V_{dc} versions 3500 V_{dc} 3400 V_{dc} versions 5400 V_{dc}
between interconnected terminals and casing	$4 \times V_{nom}$ (min. 2800 V_{dc})

Insulation resistance at 20 °C	for $C < 0.2 \mu\text{F}$ $R \geq 10\,000 \text{ M}\Omega$ for $C \geq 0.2 \mu\text{F}$ $RC \geq 2000 \text{ s}$
Losses ($\tan \delta$) at 50 Hz	$\leq 40 \times 10^{-4}$
Climatic robustness	category 40/070/56 (I.E.C. 68)

Composition of the catalog number

	2222 230
Max. working voltage code	capacitance code, see table
0 = 250 V _{dc}	1 = types according to Figs.2 or 3
2 = 500 V _{dc}	5 = types according to Fig.4
4 = 1000 V _{dc}	
5 = 2000 V _{dc}	
6 = 3400 V _{dc}	

Example: The cat. number of a 4 μF /1000 V capacitor with a height of 125 mm according to Fig.3, is 2222 230 41405.

Dimensions and available versions see next page.

Dimensions in mm

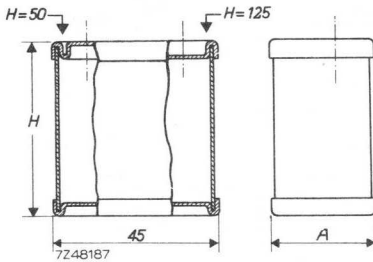

Fig. 1

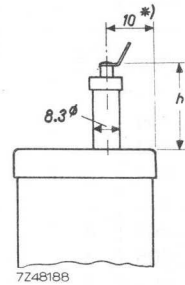

Fig. 3

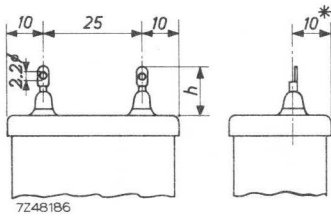

Fig. 2

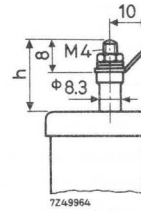

Fig. 4

Available versions

capacitance (μF)	capacitance code	construction and dimensions (mm)							
		250 V _{dc}				500 V _{dc}			
		Fig.	A	H	h	Fig.	A	H	h
1	105					2	20	50	14
2	205	2	20	50	14	2	30	50	14
4	405	2	40	50	14	2	60	50	14
6	605	2	55	50	14	2	35	125	11.5
8	805	2	30	125	11.5	2	45	125	11.5
10	106	2	35	125	11.5	2	55	125	11.5
12	126	2	45	125	11.5	4	75	125	17.5
16	166	2	55	125	11.5	4	90	125	17.5
20	206	4	75	125	17.5	4	120	125	17.5
25	256	4	90	125	17.5				

* 7.5 mm when A (Fig. 1) = 15 mm

cap. (μ F)	cap. code	construction and dimensions (mm)											
		1000 V _{dc}				2000 V _{dc}				3400 V _{dc}			
		Fig.	A	H	h	Fig.	A	H	h	Fig.	A	H	h
0.1	104					3	15	50	19	3	25	50	24
0.16	164					3	15	50	19	3	35	50	24
0.25	254					3	20	50	19	3	55	50	24
0.5	504	3	15	50	15	3	35	50	19	3	35	125	21.5
1	105	3	30	50	15	3	25	125	16.5	3	60	125	21.5
2	205	3	50	50	15	3	45	125	16.5	4	120	125	26.5
4	405	3	40	125	12.5	4	90	125	21.5				
6	605	3	55	125	12.5	4	120	125	21.5				
8	805	4	75	125	17.5								
10	106	4	90	125	17.5								
12	126	4	105	125	17.5								

If desired use can be made of mounting brackets as illustrated in Fig.5: two if A (Fig.1) is smaller than 60 mm, four if A is 60 mm or larger. The type numbers of the mounting brackets are: 4322 041 03830 for H (Fig.1) = 50 mm, 4322 041 03850 for H (Fig.1) = 125 mm. Two wires of max. 0.75 sq.mm can be connected to each soldering tag in the case of glass lead-ins, and two wires of max. 1.5 sq.mm in the case of ceramic lead-ins.

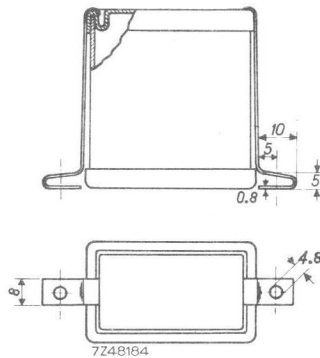
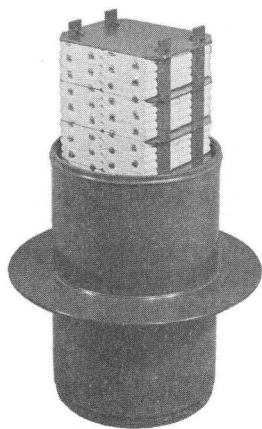
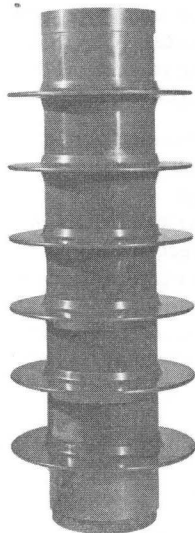

Fig.5

PAPER D.C. CAPACITORS high tension types



C 10116



C 29892

These high-tension capacitors are used e.g. in apparatus for X-ray research, nuclear research and testing of high-voltage installations. In these applications the capacitors may be charged either continuously by a direct current (e.g. in a cascade generator) or only during a short period of time and then discharged again (e.g. in a pulse generator). Various other modes of operation are possible.

Types and construction

In view of the many working conditions which have to be covered, the capacitors are classified into three groups:

- (a) for continuous d. c. operation;
- (b) for intermittent d. c. operation (30% averaged over 24 hours);
- (c) for surge operation (the maximum direct voltage is applied only for short periods, in the order of minutes or even less).

The paper dielectric has been chosen so as to combine optimum performance under the relevant operating conditions with minimum dimensions and low price. The casing is composed of a high-grade synthetic pot enlarged, if necessary, by a number of rings screwed onto this pot to obtain the total volume required. The top is closed by a cast-iron cover which is connected to one side of the capacitor element, the other connecting terminal being present in the centre of the bottom. For some types the pot and extension rings are provided with flanges of the same material so that the distance between the two terminals is increased and a higher working voltage can be applied. There are two standard diameters of the casing.

Maximum working voltage	see Table
Tolerance on capacitance	± 10%
Test voltage:	
Types for continuous operation for 1 second	2.5 x max. working voltage
Types for intermittent operation for 30 minutes	1.5 x max. working voltage
Types for surge operation for 10 minutes	1.2 x max. working voltage
Insulation resistance at 25 °C	RC ≥ 2000 s

Dimensions in mm (For H see Table)

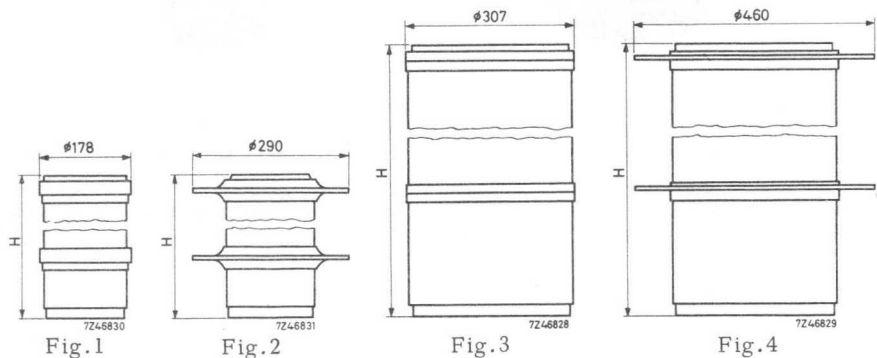

Table

In the following table the maximum working voltage and the maximum static energy content expressed in terms of joules are given for the various combinations of pot and rings either with or without flanges and for the three different modes of operation.

The static energy content is calculated in joules as:
 $\frac{1}{2}CU^2$, where C = capacitance in microfarads
 U = direct working voltage in kilovolts.

The table serves only as a guidance to illustrate the possibilities of this high-voltage capacitor programme.

max. working voltage (kV _{dc})	max. output for the different types (Wsec)			number of rings	construction Fig.	height (H) (mm)
	continuous operation	intermittent operation	surge operation			
20	15	50	65	1	1	145
30	15	50	65	1	2	145
45	40	135	200	2	1	255
60	40	135	200	2	2	255
60	155	525	760	1	3	245
75	60	220	300	3	1	365
75	155	525	760	1	4	245
100	60	220	300	3	2	365
100	80	310	400	4	1	475
120	320	1100	1850	2	3	465
150	80	310	400	4	2	475
150	100	400	500	5	1	585
150	320	1100	1850	2	4	465
180	530	1800	2800	3	3	685
200	100	400	500	5	2	585
200	120	500	600	6	1	695
225	530	1800	2800	3	4	685
250	120	500	600	6	2	695
250	140	590	700	7	1	805
300	140	590	700	7	2	805

Quotations can be made only if full details of the requirements are stated, namely:

1. capacitance;
2. maximum working voltage;
3. maximum temperature if higher than 40 °C;
4. mode of operation (unless continuous d.c. operation is required):
 - A. for intermittent d.c. operation; average number of operating hours per day;
 - B. for surge operation: a. discharge time or discharge frequency; b. repetition frequency;
5. any other information that may be of value for the design of the capacitor.

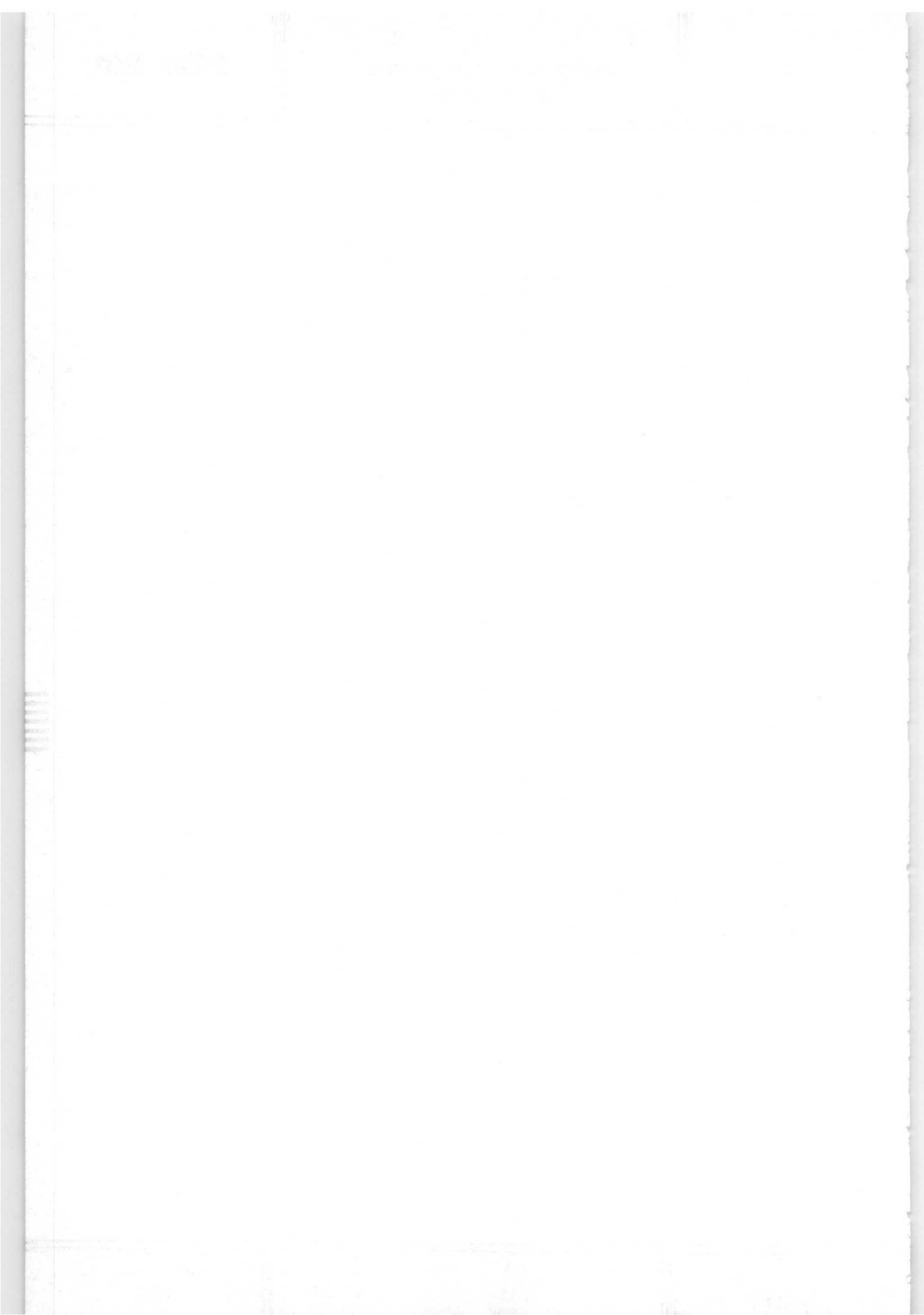

PAPER A.C. CAPACITORS

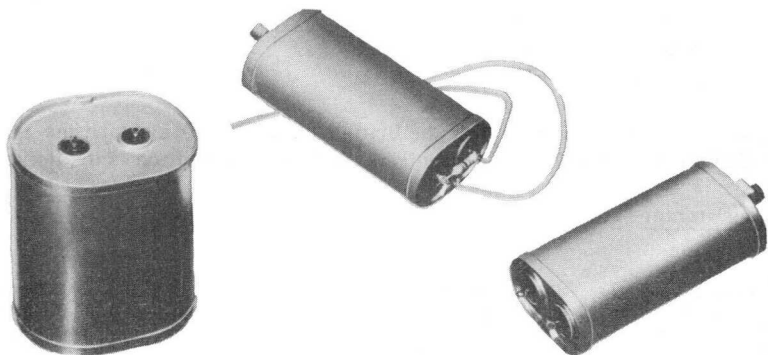

A46069

These capacitors are specially designed for ballasts of luminous-discharge lamps but are also extensively used with single-phase asynchronous motors, and for power-factor correction in low-power devices. They represent the latest stage in the development of paper capacitors in all-metal cans for low a.c. powers.

Working temperature range	-20 to +85 °C
Nominal voltage (V_{nom})	250, 300, 380, 440 and 500 V_{rms}
Working voltage	max. $1.1 \times V_{nom}$
Working frequency	40-60 Hz, beyond 50 Hz V_{nom} or working temperature should be derated by 10% or 10 °C resp.
Capacitance drift during life	max. $\pm 5\%$
Test voltage for 1 minute	
between the terminals	$2.15 V_{nom}$
between terminals and can	$2500 V_{rms}$ or $3500 V_{dc}$
Insulation resistance at 20 °C	
between terminals	$R \geq 12\,500\ M\Omega$
between terminals and can	$RC \geq 2000\ s$
Losses ($\tan \delta$) at 50 Hz	
240-series	$\leq 40 \cdot 10^{-4}$
241-series	$\leq 60 \cdot 10^{-4}$

Type Approvals

A large part of our capacitor programme has been approved by official testing institutes:

- Belgium - CEBEC
- Denmark - DEMKO
- Germany - VDE
- Norway - NEMKO
- Sweden - SEMKO
- Switzerland - SEV

Besides, our capacitors comply with the British BSI specification, and the relevant IEC and CEE recommendations. If required, detailed information is available.

Dimensions in mm

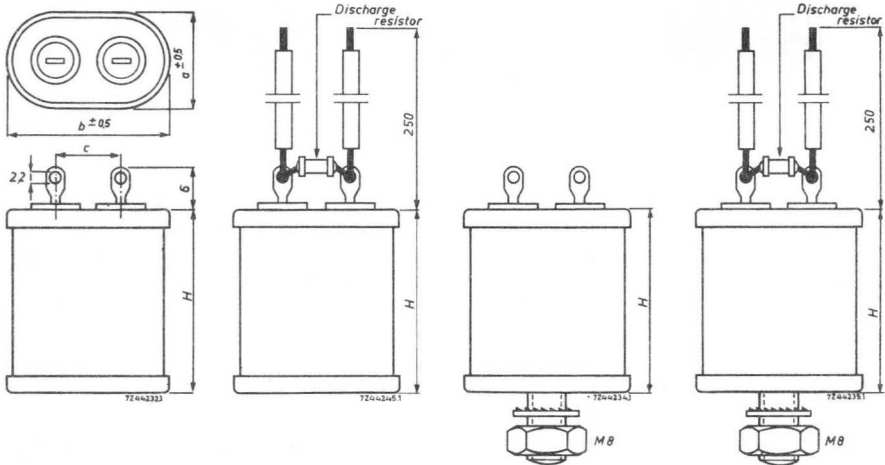
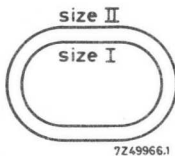

Fig. 1

Fig. 2

Fig. 3

Fig. 4



	a	b	c
size I	26	43	18
size II	38	55	22

(C120)
(C124)

PAPER A.C. CAPACITORS

2222 240
2222 241

250 V-range

size	cap. $\pm 10\%$ (μF)	H_{max} (mm)	catalog number 2222 241			
			Fig.1	Fig.2	Fig.3	Fig.4
I	3	50	04023	04223	04423	04623
	3.5	57	28	28	28	28
	4	57	34	34	34	34
	4.5	62	39	39	39	39
	5	71	45	45	45	45
	6	86	56	56	56	56
	7	86	67	67	67	67
	8	99	78	78	78	78
	9	109	89	89	89	89
	10	124	04101	04301	04501	04701
	12	148	05	05	05	05
	II	8	57	54078	54278	54478
9		62	89	89	89	89
10		71	54101	54301	54501	54701
12		86	05	05	05	05
13.5		86	08	08	08	08
15		99	12	12	12	12
18		109	18	18	18	18
20		124	23	23	23	23
25		148	34	34	34	34

Special 250 V-range

These capacitors are specially designed for power-factor correction of gas-discharge lamps for public lighting. They are painted grey.

size	cap. $\pm 10\%$ (μF)	H_{max} (mm)	catalog number 2222 241	
			Fig.2	Fig.4
II	8	57	90054	90055
	10	71	56	57
	13	86		58
	15	99		59
	18	109		61
	20	124	62	63
	25	148	64	65

2222 240
2222 241

PAPER A.C. CAPACITORS

(C120)
(C124)

300 V-range

size	cap. $\pm 5\%$ (μF)	H_{max} (mm)	catalog number 2222 240			
			Fig.1	Fig.2	Fig.3	Fig.4
I	2	50	07012	07212	07412	07612
	2.5	57	17	17	17	17
	3	62	23	23	23	23
	3.5	71	28	28	28	28
	4	86	34	34	34	34
	4.5	86	39	39	39	39
	5	99	45	45	45	45
	6	109	56	56	56	56
II	7	124	67	67	67	67
	8	148	78	78	78	78
	8	86	57078	57278	57478	57678
	9	86	89	89	89	89
	10	99	57101	57301	57501	57701
	12	109	05	05	05	05
	14	124	09	09	09	09
	16	148	14	14	14	14
18	148	18	18	18	18	

(C120)
(C124)

PAPER A.C. CAPACITORS

2222 240
2222 241

380 V-range

size	cap. $\pm 5\%$ (μF)	H _{max} (mm)	catalog number 2222 240			
			Fig. 1	Fig. 2	Fig. 3	Fig. 4
I	1.5	50	11006	11206	11406	11606
	2	57	12	12	12	12
	2.5	71	17	17	17	17
	3	86	23	23	23	23
	3.5	99	28	28	28	28
	3.6	99	29	29	29	29
	3.7	99	31	31	31	31
	3.8	99	32	32	32	32
	4	99	34	34	34	34
	5	124	45	45	45	45
	5.7	148	53	53	53	53
	5.8	148	54	54	54	54
	5.9	148	55	55	55	55
6	148	56	56	56	56	
II	7	99	61067	61267	61467	61667
	8	99	78	78	78	78
	10	124	61101	61301	61501	61701

2222 240
2222 241

PAPER A.C. CAPACITORS

(C120)
(C124)

440 V-range

size	cap. $\pm 5\%$ (μF)	H _{max} (mm)	catalog number 2222 240			
			Fig.1	Fig.2	Fig.3	Fig.4
I	1	50	15001	15201	15401	15601
	1.5	57	06	06	06	06
	2	71	12	12	12	12
	2.5	86	17	17	17	17
	3	99	23	23	23	23
	3.5	124	28	28	28	28
	4	124	34	34	34	34
II	5	86	65045	65245	65445	65645
	6	99	56	56	56	56

500 V-range

size	cap. $\pm 5\%$ (μF)	H _{max} (mm)	catalog number 2222 240			
			Fig.1	Fig.2	Fig.3	Fig.4
I	0.75	50	19192	19392	19592	19792
	1	57	19001	19201	19401	19601
	1.5	71	06	06	06	06
	2	86	12	12	12	12
	2.5	109	17	17	17	17
	3	124	23	23	23	23
	3.5	148	28	28	28	28
II	4	86	69034	69234	69434	69634
	5	109	45	45	45	45
	6	124	56	56	56	56

METALLISED POLYCARBONATE A.C. CAPACITORS

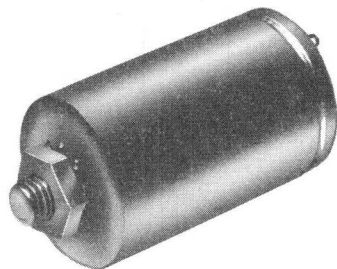

RZ 20807

Capacitance range

325-series	2 -25 μF
326-series	1.5-18 μF
327-series	1.5-10 μF

Nominal working voltage

325-series	160 V_{rms}
326-series	220 V_{rms}
327-series	280 V_{rms}

Frequency range

40 -60 Hz

APPLICATION

- As a shunt capacitor for power factor correction of fluorescent and other discharge lamps.
- As a phase shift capacitor for single phase alternating current motors.
- Due to its low losses also at higher frequencies, this capacitor is suitable to be used as a commutation capacitor in thyristor circuits.

CONSTRUCTION

The capacitors are made of metallised polycarbonate. They are housed in a cylindrical aluminium casing, which is sealed with a rubber disc (versions with soldering tags) or with synthetic resin (version with flat connections).

The capacitors are provided with a central fastening bolt at the bottom.

These capacitors offer many advantages over conventional paper capacitors for a.c. applications:

- they are self-healing
- they cannot leak (because they have no liquid impregnation)
- the dimensions are more than 40% smaller
- the dielectric losses are low, 60-75% lower than those of a.c. paper capacitors.

2222 325
2222 326
2222 327

METALLISED POLYCARBONATE
 A. C. CAPACITORS

Dimensions in mm

For D and H, see table.

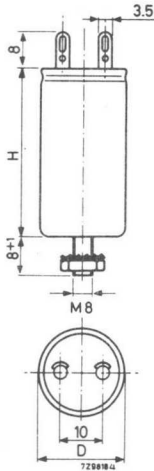

Fig. 1. Version with soldering tags.

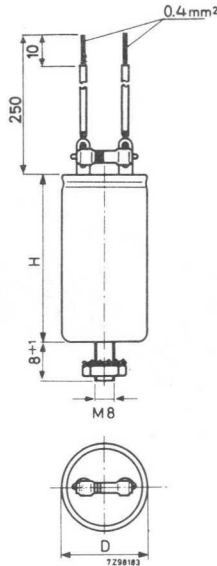

Fig. 2. Version with soldering tags, provided with leads and discharge resistor

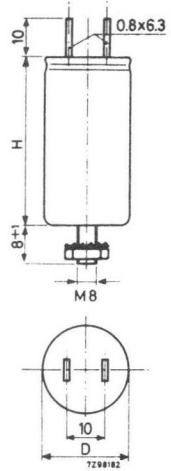

Fig. 3. Version with flat connections

TECHNICAL PERFORMANCE

Capacitance	see table
Tolerance on capacitance	+ 10%
Frequency range	40 to 60 Hz; for other frequencies information on request.
Nominal working voltage	
325-series	160 V _{rms}
326-series	220 V _{rms}
327-series	280 V _{rms}
Test voltage for 1 minute	
- between terminals	
325-series	265 V _{rms}
326-series	365 V _{rms}
327-series	480 V _{rms}
- between interconnected terminals and casing	2500 V _{rms} or 3500 V _{dc}
Working temperature range	- 40 to + 85 °C

METALLISED POLYCARBONATE
A.C. CAPACITORS

2222 325
2222 326
2222 327

Insulation resistance at 20 °C	
between terminals	$> \frac{10000}{C(\mu F)} \text{ M}\Omega$
between interconnected terminals and casing	$> 12500 \text{ M}\Omega$
Losses (tan δ) at 50 Hz and 25-85 °C	
325-series	$< 25 \times 10^{-4}$
326-series	$< 20 \times 10^{-4}$
327-series	$< 15 \times 10^{-4}$
Climatic category (I.E.C. 68)	40/085/56

TYPES

Composition of the catalog number:

2222 325
2222 326
2222 327

code for version   code for capacitance value, see table

50 = version Fig.1
52 = version Fig.2
70 = version Fig.3

capacitance (μF)	dimensions D x H (mm)			code in catalog number
	325-series	326-series	327-series	
1.5				155
2				205
2.5	30 x 40	30 x 40	30 x 40	255
3				305
3.5				355
4			30 x 52	405
4.5				455
5				505
6				605
7		30 x 52	35 x 52	705
8				805
9	30 x 52		40 x 52	905
10		35 x 52		106
12				126
14	35 x 52	40 x 52		146
16				166
18				186
20	40 x 52			206
25				256

555 5555
555 5555
555 5555

Electrolytic capacitors







SECTION GUIDE



SELECTION GUIDE

WET ALUMINIUM TYPES

type	series number	T _{max} (°C)	capacitance range (μF)	voltage range (V)	application
miniature	001, 002 (C426) 001	70 (85)	0.32- 400	64-4	general purposes transistorized equipment
		70, 60	0.64- 500	64-2.5	
small	023 (C437)	70 (85)	64- 4000	64-2.5	
large	060 (C431) 071, 073 072	70	320- 20000	64-6.4	
		85	680- 47000	63-6.3	
		85	2x1 100-2x23 500	63-6.3	
miniature and small	015-017	85/70	0.47- 4700	63-4	general purposes and long life
small	040 (C436)	70	2.5- 80	400-100	high voltages power rectifiers
large	063, 064 (C433) 080, 081 063, 067	70 (85)	200- 8000	64-6.4	
		70	8- 500	500-100	
		70	25-100 triple and quadruple	350-300	

type	series number	T _{max} (°C)	capacitance range (μF)	voltage range (V)	application
  small	101 (C428)	70	2.5 - 320	64-4	long service life and high reliability
	102, 103* (C432) 106, 107	70 85	900 - 31 500 1 500 - 150 000	100-6.4 100-6.3	
SOLID ALUMINIUM TYPES					
  small	121	85	2.7 - 390	40-4	severe requirements, long service life and high reliability
SOLID TANTALUM TYPES					
 miniature	143	125	0.33 - 330	35-6	severest requirements
 miniature	142	85 (125)	0.015 - 56	25-1.6	ultra small dimensions

NOTE: Unless otherwise specified, all electrical values given in the data sheets apply to a temperature of 20 to 25 °C, an atmospheric pressure of 930-1060 mbar and a relative humidity of ≤ 75%

* = Maintenance type



ANALYTICAL
CHEMISTRY

70 °C

ELECTROLYTIC CAPACITORS

miniature type, for general purposes (economy range)

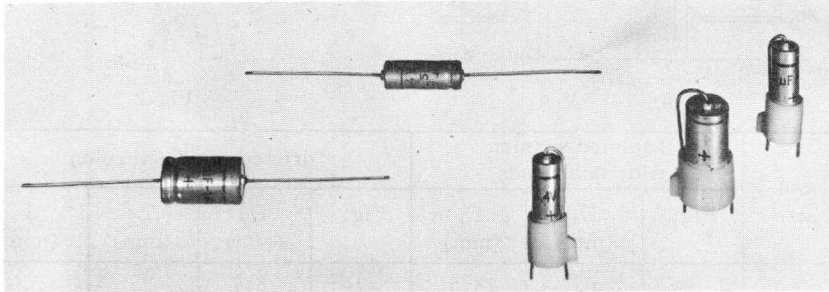

RZ 20603-2

The economy range of miniature wet aluminium capacitors covers the whole capacitance and voltage range of the standard 001-series, but in can sizes 4 and 6 only, which is obtained by using non-etched or low etched anode foil, offering the most inexpensive solution. Moreover, these capacitors offer, compared to smaller types:

- (a) better low-temperature characteristics;
- (b) lower losses and impedances;
- (c) longer service life and higher reliability.

They are therefore preferable in all cases where utmost miniaturisation is not required.

These capacitors are designed for operation between -40 to $+70$ °C. They may also operate at 85 °C for 12 hours per 24 hours.

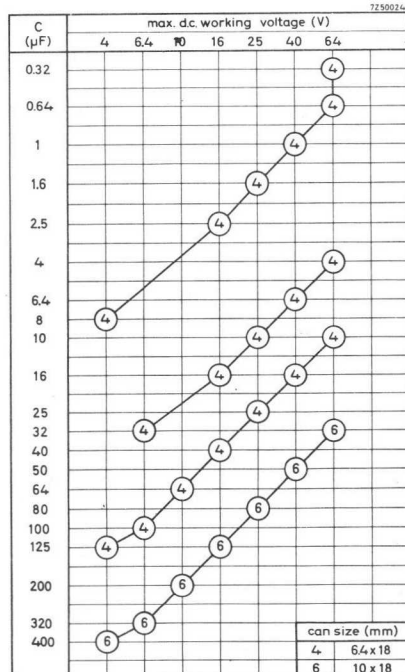

2222 001
2222 002

ELECTROLYTIC CAPACITORS
Miniature type, for general purposes
(economy range)

(C426)

Dimensions in mm

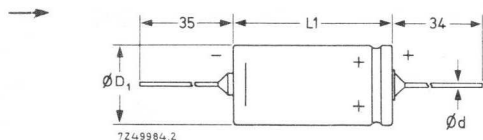

Fig. 1. $d = 0.8$

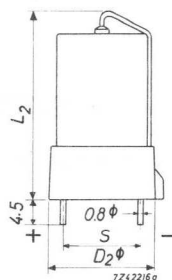

Fig. 2

can size	insulated version with axial leads			printed-wiring version			
	Fig.	D ₁ (mm)	L ₁ (mm)	Fig.	D ₂ (mm)	L ₂ (mm)	S (mm)
4	1	6.7	18.5	2	8.7	25	7.62
6	1	10.4	18.5	2	12.9	25	10.16

Tolerance on capacitance

-10/+50 %

Temperature range

-40/+70 °C

Max. temperature for 12 hours per 24 hours

85 °C

Peak voltage for 1 minute per hour:

at +70 °C
at ≤ +40 °C

1.125 x working voltage + 0.5 V
1.25 x working voltage + 0.5 V

Climatic robustness

category 40/070/56 (IEC68)

Composition of the catalog number

suffix, see table

2222 001

high etched foil type

2222 002

low and non-etched foil type

1 = insulated with axial leads

capacitance code

4 = printed-wiring version

working voltage code

can size	working voltage (V)	capacitance (μF)	leakage current 1) (μA)	ripple current 2) (mA)	dissipation factor 3)	impedance 4) (Ω)	cat. number 2222 followed by 5)
4	4	8	4.1	16	0.15	5	002 12808
4		125	30	40	0.30	6	001 12131
6		400	73	125	0.30	1.8	001 12401
4	6.4	32	15	16	0.15	6	002 13329
4		100	37	40	0.30	6	001 13101
6		320	85	125	0.30	1.8	001 13321
4	10	64	37	40	0.25	6	001 14649
6		200	85	125	0.25	1.8	001 14201
4	16	2.5	4.1	16	0.10	5	002 15258
4		16	18	16	0.20	6	002 15169
4		40	37	40	0.20	6	001 15409
6		125	85	125	0.20	1.8	001 15131
4	25	1.6	4.1	16	0.10	6	002 16168
4		10	18	16	0.15	6	002 16109
4		25	37	40	0.15	6	001 16259
6		80	85	125	0.15	1.8	001 16809
4	40	1	4.1	16	0.10	10	002 17108
4		6.4	18	16	0.10	6	002 17648
4		16	37	40	0.10	6	001 17169
6		50	85	125	0.10	1.8	001 17509
4	64	0.32	2	16	0.10	18	002 18327
4		0.64	4.1	16	0.10	12	002 18647
4		4	18	16	0.10	6	002 18408
4		10	37	40	0.10	6	001 18109
6		32	85	125	0.10	1.8	001 18329

- 1) Maximum leakage current at 20 °C after 5 minutes.
- 2) Maximum permissible ripple current at 100 Hz and 70 °C.
- 3) Maximum dissipation factor ($\tan \delta$) at 20 °C and 50 Hz.
- 4) Maximum impedance at 20 °C and 100 kHz.
- 5) For insulated version.

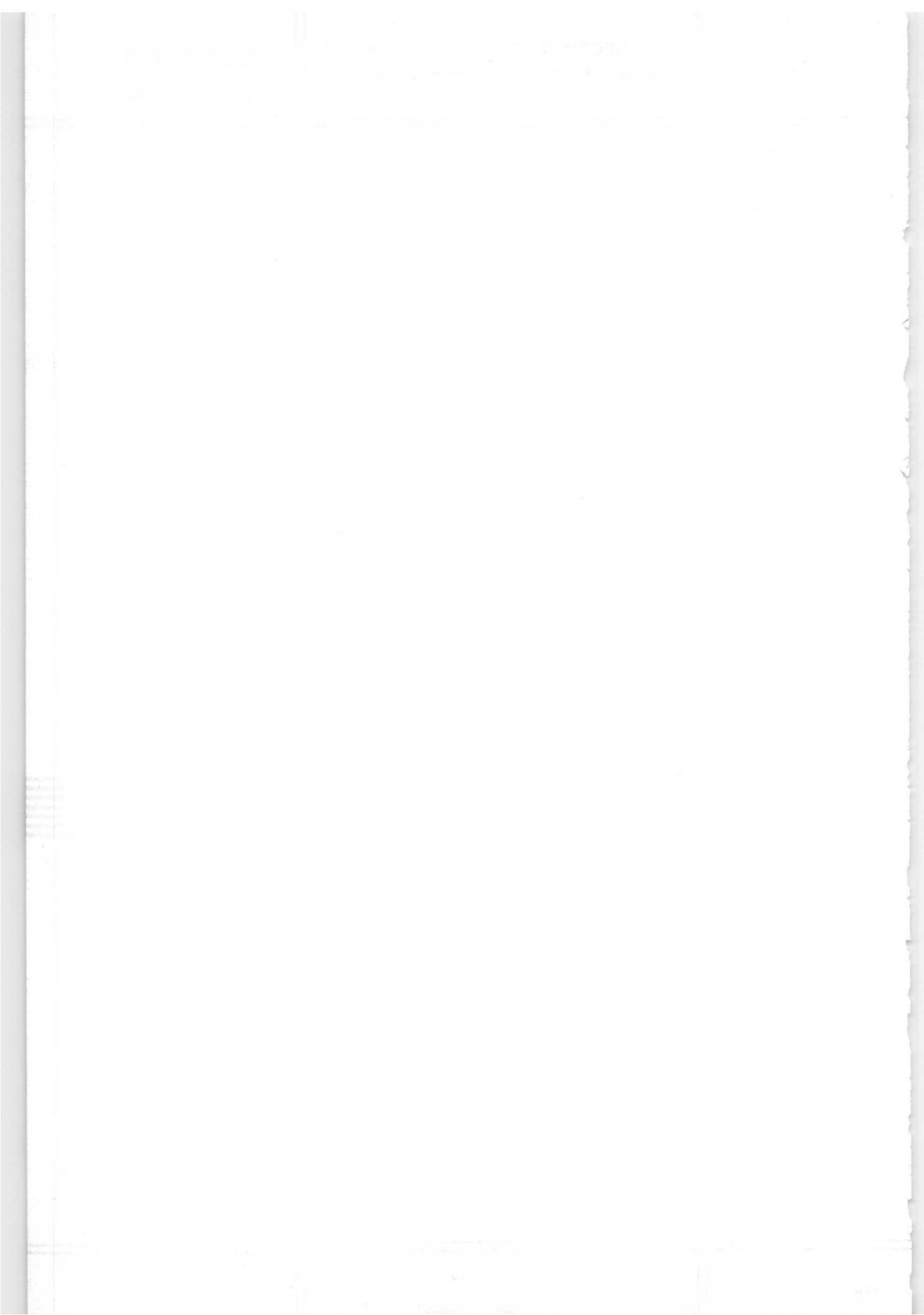

60 °C
70 °C

ELECTROLYTIC CAPACITORS miniature type, for general purposes

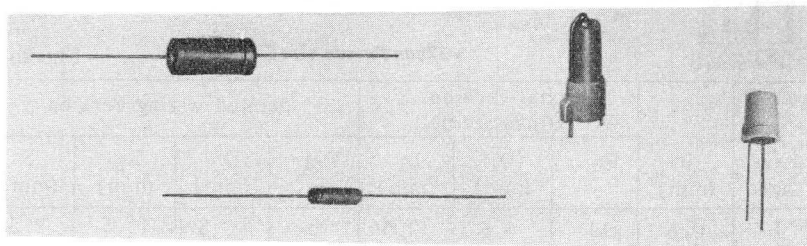

RZ 16995-3A

These capacitors are specially suitable for coupling and decoupling in miniaturised electronic equipment, such as transistorised pocket radio receivers, personal tape recorders and similar applications.

They are available in an insulated version with axial leads for conventional wiring and in a version for vertical mounting on printed wiring boards.

For applications in which utmost miniaturisation is not required refer to the economy range (see preceding pages)

7290022

C (μ F)	max. d.c. working voltage (V)							
	2.5	4	6.4	10	16	25	40	64
0.64								1
1							1	
1.6						1		
2.5					1			
4				1				
5							2	
6.4			1					3
8		1						
10	1							
12.5								
16								
20								
25								
32								
40	2							
50								
64								
80	3							
100								
125								
160	4							
200								
250								
320	5							
400								
500	6							

can size (mm)	
1	3.1 x 10
2	4.5 x 10
3	5.8 x 10
4	6.4 x 18
5	8 x 18
6	10 x 18

Dimensions in mm

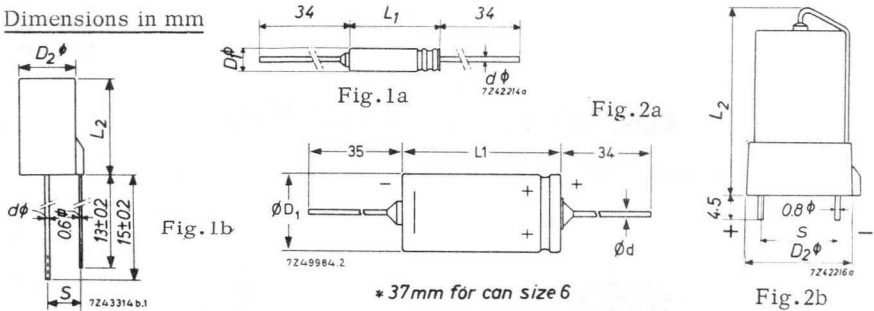

can size	d (mm)	axial version (insulated)			printed-wiring version			
		Fig.	D ₁ (mm)	L ₁ (mm)	Fig.	D ₂ (mm)	L ₂ (mm)	S (mm)
1	0.6	1a	3.5	10.5	1b	3.8	12.5	2.54
2	0.6	2a	4.8	10.5	1b	5.2	12.5	2.54
3	0.6	2a	6.1	10.5	1b	6.4	12.5	3.59
4	0.8	2a	6.7	18.5	2b	8.7	25	7.62
5	0.8	2a	8.3	18.5	2b	10.3	25	7.62
6	0.8	2a	10.4	18.5	2b	12.9	25	10.16

Tolerance on capacitance: can size 2-6
can size 1

-10/+ 50%
-10/+100%

Temperature range: can size 2-6
can size 1

-40/+ 70 °C
-40/+ 60 °C

Max. a.c. voltage, without d.c. voltage

2.5 V types: 0.25 V_{rms}
4 V types: 0.4 V_{rms}
6.4 V types: 0.6 V_{rms}
10-64 V types: 1 V_{rms}

Peak voltage for 1 minute per hour:

at +70 °C
at ≤ +40 °C

1.125 x working voltage +0.5 V
1.25 x working voltage +0.5 V
climatic robustness

Climatic robustness

Composition of the catalog number

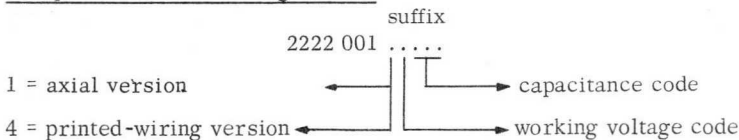

can size	working voltage (V)	capacitance (μF)	leakage current 1) (μA)	ripple current 2) (mA)	dissipation factor 3)	impedance 4) (Ω)	suffix axial version 5)
1	2.5	10	3.1	2.5	0.35	65	11109
2		40	8	10	0.35	24	11409
3		80	14	20	0.35	12	11809
4		160	25	40	0.35	6	11161
5		320	45	80	0.35	3	11321
6		500	63	125	0.35	1.8	11501
1	4	8	3.5	2.5	0.3	65	12808
2		32	10	10	0.3	24	12329
3		64	18	20	0.3	12	12649
4		125	30	40	0.3	6	12131
5		250	55	80	0.3	3	12251
6		400	73	125	0.3	1.8	12401
1	6.4	6.4	4.1	2.5	0.3	65	13648
2		25	12	10	0.3	24	13259
3		50	21	20	0.3	12	13509
4		100	37	40	0.3	6	13101
5		200	63	80	0.3	3	13201
6		320	85	125	0.3	1.8	13321
1	10	4	4.1	2.5	0.25	65	14408
2		16	12	10	0.25	24	14169
3		32	21	20	0.25	12	14329
4		64	37	40	0.25	6	14649
5		125	63	80	0.25	3	14131
6		200	85	125	0.25	1.8	14201
1	16	2.5	4.1	2.5	0.2	65	15258
2		10	12	10	0.2	24	15109
3		20	21	20	0.2	12	15209
4		40	37	40	0.2	6	15409
5		80	63	80	0.2	3	15809
6		125	85	125	0.2	1.8	15131
1	25	1.6	4.1	2.5	0.15	65	16168
2		6.4	12	10	0.15	24	16648
3		12.5	21	20	0.15	12	16139
4		25	37	40	0.15	6	16259
5		50	63	80	0.15	3	16509
6		80	85	125	0.15	1.8	16809

For notes see next page.

can size	working voltage (V)	capacitance (μF)	leakage current 1) (μA)	ripple current 2) (mA)	dissipation factor 3)	impedance 4) (Ω)	suffix axial version 5)
1	40	1	4.1	2.5	0.10	65	17108
2		4	12	10	0.10	24	17408
3		8	21	20	0.10	12	17808
4		16	37	40	0.10	6	17169
5		32	63	80	0.10	3	17329
6		50	85	85	125	0.10	1.8
1	64	0.64	4.1	2.5	0.10	65	18647
2		2.5	12	10	0.10	24	18258
3		5	21	20	0.10	12	18508
4		10	37	40	0.10	6	18109
5		20	63	80	0.10	3	18209
6		32	85	85	125	0.10	1.8

1) Maximum leakage current at 20 °C after 5 minutes

2) Maximum permissible ripple current at 100 Hz and 70 °C (60 °C for can size 1)

3) Maximum dissipation factor ($\tan \delta$) at 20 °C and 50 Hz

4) Maximum impedance at 20 °C and 100 kHz

5) See composition of the catal. No.

WET ALUMINIUM ELECTROLYTIC CAPACITORS to IEC 103, for general purposes (type 2) and for long life applications (type 1)

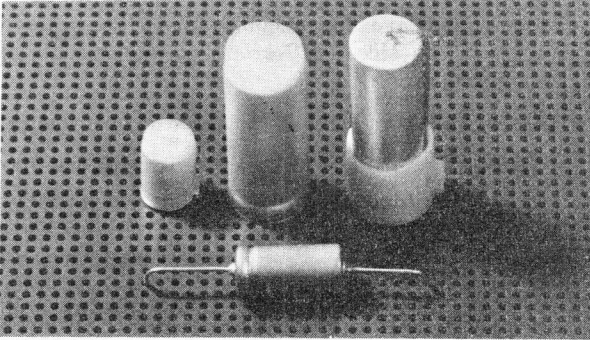

RZ 28600-2

QUICK REFERENCE DATA

Nom. capacitance range (E6 series)
0.47 to 4700 μF

Tolerance on nom. capacitance
case sizes 2 to 03 -10/ +50%
case size 1 -10/+100%

Rated voltage range (U_R) 4 to 63 V

Category (IEC 68) and type (IEC 103):

case size	category	type
1	25/070/56	2
2, 3 and 5a	25/085/56	2
4, 5 and 6	25/085/56	1
00 to 03	40/085/56	1

APPLICATION

General purposes in transistorized equipment.

In comparison to the 001/002 and 023 series higher CV-products and improved temperature ranges are obtained.

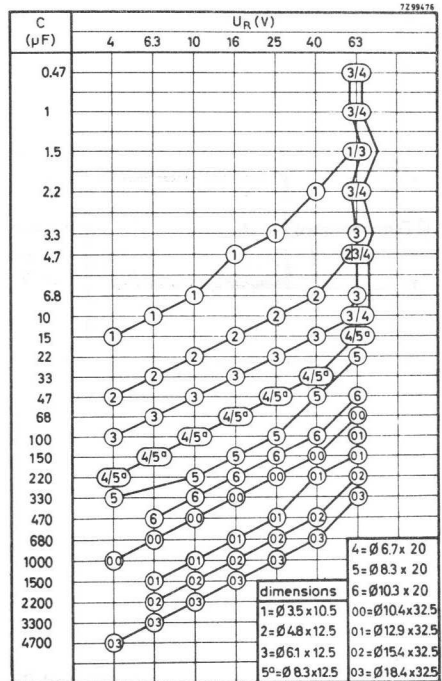

DESCRIPTION

The capacitor has etched aluminium-foil electrodes rolled up with a porous paper spacer which separates the anode and the cathode. The spacer is impregnated with an electrolyte which retains its good characteristics both at low and at high temperatures. The capacitor is housed in an aluminium case.

Case size 1 is sealed with a rubber bung, the other cases are sealed with a phenol paper laminate disc which at one side is covered with rubber and at the other side with polythene tetrafluorethene.

The capacitor is available in 4 styles, all with soldered-copper leads.

- Style 1 : Axial leads. Case insulated with a blue transparent plastic sleeve.
- Styles 2 and 3: Single ended. Case insulated with a blue transparent plastic sleeve. The sleeve of style 2 has a boss and that of style 3 has a short slot so that a greater pitch between the leads can be made, if necessary.
- Style 4 : Single ended. Case fitted in a yellow plastic foot.

MECHANICAL DATA

Dimensions in mm

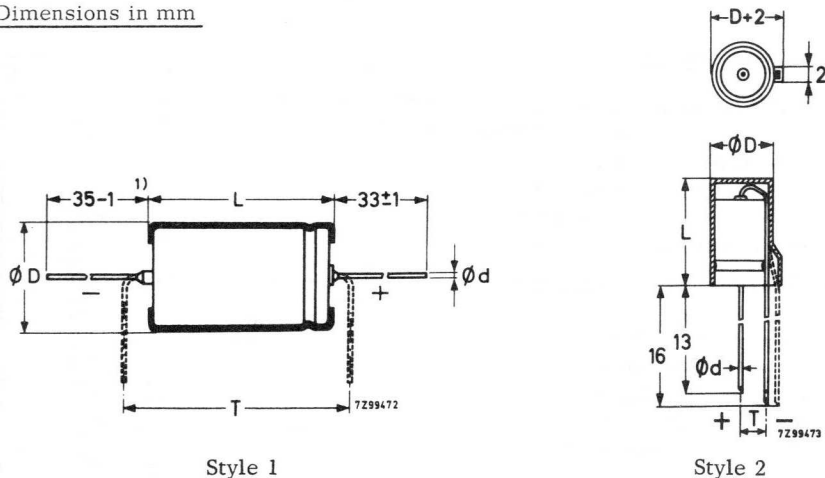

¹⁾ 55-1 for case sizes 00, 01, 02 and 03.

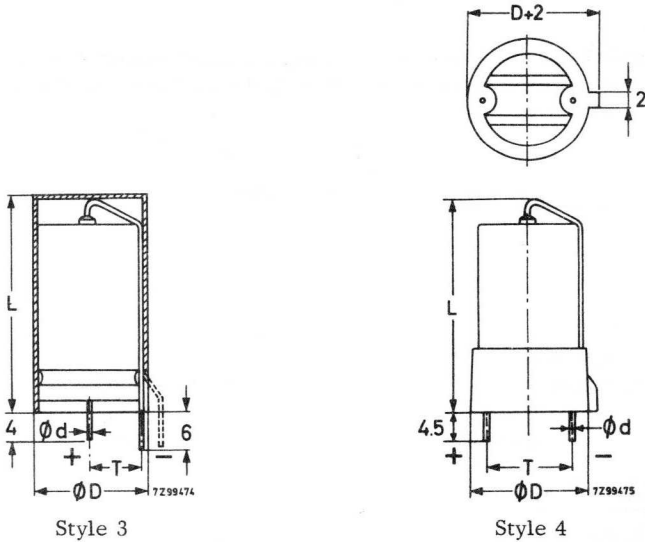

Table 1

case size	d (mm)	style 1			style 2			style 3			style 4			weight g
		D (mm) max.	L ³⁾ (mm) max.	T _{min} 2)	D (mm) max.	L ³⁾ (mm) max.	T 2)	D (mm) max.	L ³⁾ (mm) max.	T 2)	D (mm) max.	L ³⁾ (mm) max.	T 2)	
1	0.6	3.5	10.5	6E	4.1	12.5	E							0.35
2	0.6	4.8	12.5	6E	5.6	14.5	E							0.53
3	0.6	6.1	12.5	6E	6.9	14.5	E√2							0.9
5a	0.6	8.3	12.5	6E	9.1	14.5	2E							1.2
4	0.8	6.7	20	10E				8.5	24.5	2E				1.5
5	0.8	8.3	20	10E				10.2	24.5	2E				2
6	0.8	10.3	20	10E				12.1	24.5	3E				2.7
00	0.8	10.4	32.5	14E				11.2	34.5	3E	12.8	41	4E	4.0
01	0.8	12.9	32.5	14E				13.6	34.5	3E	15.2	41	4E	6.3
02	0.8	15.4	32.5	14E				16	34.5	4E	17.8	41	5E	8.2
03	0.8	18.4	32.5	14E				19	34.5	4E	20.8	41	6E	10.9

Marking

1 x group number, 2 x capacitance, 2 x rated voltage, a band to indicate negative terminal and a letter code for country of origin and year of manufacture.

2) E = 2.5 + 0.04 mm.

3) With exception of case size 1 all lengths are temporarily 2 mm shorter.

Mounting

Styles 2 and 3 are designed for mounting on single-sided printed-wiring boards, however, case sizes 4, 5 and 6 and all style 4 capacitors are also directly suitable for double-sided p.w. boards.

No special provisions are required for soldering to the leads.

Minimum atmospheric pressure 200 mbar (15 cm Hg)

ELECTRICAL DATA

Temperature

Category temperature range	
for case size 1	-25 to +70 °C
2 to 6	-25 to +85 °C
00 to 03	-40 to +85 °C

Capacitance

Nom. capacitance values (100 Hz) see Table 2

Tolerance on nom. capacitance (100 Hz)	
for case size 1	-10/+100%
for other case sizes	-10/+50%

Voltage

Rated voltage = max. (d.c. + peak a.c.) voltage at 50 °C up to upper cat. temp.	see Table 2, U _R
Max. (d.c. + peak a.c.) voltage at ≤ 50 °C	1.1 x rated voltage
Max. a.c. voltage without d.c. voltage (peak value)	0.1 x rated voltage or 1 V, whichever is less
Surge: max. voltage for 1 min per h, at 50 to 85 °C	1.125 x rated voltage + 0.5 V
at ≤ 50 °C	1.25 x rated voltage + 0.5 V

Ripple current

Max. permissible ripple current at 100 Hz, at upper cat. temp.	see Table 2
---	-------------

Leakage current

Leakage current 5 min after application of the rated voltage	see Table 2
---	-------------

Leakage current during continuous operation at UR and at room temperature at upper cat. temp. approx. 1/5 of value stated in Table 2. \leq value stated in Table 2.

If owing to prolonged storage and/or storage at an excessive temperature the leakage current is too high, application of the rated voltage for some hours will cause the leakage current to fall to a value lower than specified in Table 2.

Tan δ (tangent of the loss angle)

Tan δ at 100 Hz (nom. value) see Table 2

Tolerance on nom. value, at 100 Hz

rated voltage	case size	tolerance
4-10 V	1, 2, 3, 5a	-60/+60%
	4 to 03	-50/+50%
16-63 V	1, 2, 3, 5a	-50/+50%
	4 to 03	-40/+40%

Tan δ is measured by means of a four-terminal circuit (Thompson circuit)

Impedance

Impedance at 100 kHz (nom. value) see Table 2

Tolerance on nom. value, at 100 kHz
for case size 1, 2, 3 and 5a -40/+70%
4 to 03 -30/+60%

The impedance is measured by means of a four-terminal circuit (Thompson circuit).

Table 2

Unless otherwise specified, all electrical values in Table 2 apply at an ambient temperature of 20 to 25 °C, an atmospheric pressure of 930 to 1060 mbar, and a relative humidity of 45 to 75%.

UR (V)	nom. cap. at 100 Hz (μF)	max. ripple current at 100 Hz, upper cat. temp. (mA)	leakage current (μA) max.	tan δ at 100 Hz nom. 1)	impedance at 100 kHz, nom. (Ω) 1)		case size	catalogue number 2222 followed by	
					+20 °C	-20 °C		style 1	styles 2+3 style 4
4	15	10	5	0.25	12	145	1	015 12159	015 42159
4	47	26	10	0.25	4	50	2	015 12479	015 42479
4	100	44	20	0.25	2	25	3	015 12101	015 42101
4	220	70	44	0.25	1	12	5a	015 12221	015 42221
4	220	85	9	0.25	0.5	6	4	016 12221	016 42221
4	330	125	12	0.25	0.35	4.5	5	016 12331	016 42331
4	1000	325	28	0.25	0.2	1	00	017 12102	017 42102
4	4700	920	117	0.25	0.3	0.5	03	017 12472	017 42472
6.3	10	12	5	0.20	12	145	1	015 13109	015 43109
6.3	33	26	11	0.20	4	50	2	015 13339	015 43339
6.3	68	44	22	0.20	2	25	3	015 13689	015 43689
6.3	150	70	48	0.20	1	12	5a	015 13151	015 43151
6.3	150	85	10	0.20	0.5	6	4	016 13151	016 43151
6.3	470	190	22	0.20	0.2	2.4	6	016 13471	016 43471
6.3	680	325	30	0.20	0.2	1	00	017 13681	017 43681
6.3	1500	470	61	0.20	0.2	0.75	01	017 13152	017 43152
6.3	2200	630	88	0.20	0.25	0.6	02	017 13222	017 43222
6.3	3300	920	129	0.20	0.3	0.5	03	017 13332	017 43332

1) See also corresponding paragraph.

WET ALUMINIUM
ELECTROLYTIC CAPACITORS

2222 015-
2222 017

UR (V)	nom. cap. at 100 Hz (μ F)	max. ripple current at 100 Hz, upper cat. temp. (mA)	leakage current I) (μ A) max.	tan δ at 100 Hz nom.	impedance at 100 kHz, nom. (Ω) I)		case size	catalogue number 2222 followed by		
					+20 °C	-20 °C		style 1	styles 2+3	style 4
10	6.8	12	5	0.16	12	145	1	015 14688	015 44688	
10	22	26	11	0.16	4	50	2	015 14229	015 44229	
10	47	44	24	0.16	2	25	3	015 14479	015 44479	
10	100	70	50	0.16	1	12	5a	015 14101	015 44101	
10	100	85	10	0.16	0.5	6	4	016 14101	016 44101	
10	220	125	18	0.16	0.35	4.5	5	016 14221	016 44221	
10	330	190	24	0.16	0.2	2.4	6	016 14331	016 44331	
10	470	325	33	0.16	0.2	1	00	017 14471	017 44471	017 54471
10	1000	470	64	0.16	0.2	0.75	01	017 14102	017 44102	017 54102
10	1500	630	94	0.16	0.25	0.6	02	017 14152	017 44152	017 54152
10	2200	920	136	0.16	0.3	0.5	03	017 14222	017 44222	017 54222
16	4.7	12	5	0.12	12	145	1	015 15478	015 45478	
16	15	26	12	0.12	4	50	2	015 15159	015 45159	
16	33	44	27	0.12	2	25	3	015 15339	015 45339	
16	68	70	53	0.12	1	12	5a	015 15689	015 45689	
16	68	85	11	0.12	0.5	6	4	016 15689	016 45689	
16	150	125	19	0.12	0.35	4.5	5	016 15151	016 45151	
16	220	190	26	0.12	0.2	2.4	6	016 15221	016 45221	
16	330	325	36	0.12	0.2	1	00	017 15331	017 45331	017 55331
16	680	470	70	0.12	0.2	0.75	01	017 15681	017 45681	017 55681
16	1000	630	100	0.12	0.25	0.6	02	017 15102	017 45102	017 55102
16	1500	920	148	0.12	0.3	0.5	03	017 15152	017 45152	017 55152

1) See also corresponding paragraph.

2222 015-
2222 017

WET ALUMINIUM
ELECTROLYTIC CAPACITORS

UR (V)	nom. cap. at 100 Hz (μ F)	max. ripple current at 100 Hz, upper cat. temp. (mA)	leakage current ¹⁾ (μ A) max.	tan δ at 100 Hz nom.	impedance at 100 kHz, nom. (Ω) 1)		case size	catalogue number 2222 followed by		
					+20 °C	-20 °C		style 1	styles 2+3	style 4
25	3.3	11	5	0.10	12	145	1	015 16338	015 46338	
25	10	23	13	0.10	4	50	2	015 16109	015 46109	
25	22	37	28	0.10	2	25	3	015 16229	015 46229	
25	47	60	56	0.10	1	12	5a	015 16479	015 46479	
25	47	72	12	0.10	0.5	6	4	016 16479	016 46479	
25	100	105	19	0.10	0.35	4.5	5	016 16101	016 46101	
25	150	155	27	0.10	0.2	2.4	6	016 16151	016 46151	
25	220	270	37	0.10	0.2	1	00	017 16221	017 46221	017 56221
25	470	360	75	0.10	0.2	0.75	01	017 16471	017 46471	017 56471
25	680	500	106	0.10	0.25	0.6	02	017 16681	017 46681	017 56681
25	1000	650	154	0.10	0.3	0.5	03	017 16102	017 46102	017 56102
40	2.2	11	5	0.08	12	145	1	015 17228	015 47228	
40	6.8	23	14	0.08	4	50	2	015 17688	015 47688	
40	15	37	30	0.08	2	25	3	015 17159	015 47159	
40	33	60	60	0.08	1	12	5a	015 17339	015 47339	
40	33	72	12	0.08	0.5	6	4	016 17339	016 47339	
40	47	105	16	0.08	0.35	4.5	5	016 17479	016 47479	
40	100	155	28	0.08	0.2	2.4	6	016 17101	016 47101	
40	150	270	40	0.08	0.2	1	00	017 17151	017 47151	017 57151
40	220	360	57	0.08	0.2	0.75	01	017 17221	017 47221	017 57221
40	470	500	117	0.08	0.25	0.6	02	017 17471	017 47471	017 57471
40	680	650	167	0.08	0.3	0.5	03	017 17681	017 47681	017 57681

1) See also corresponding paragraph.

WET ALUMINIUM
ELECTROLYTIC CAPACITORS

2222 015-
2222 017

UR (V)	nom. cap. at 100 Hz (μ F)	max. ripple current at 100 Hz, upper cat. temp. (mA)	leakage current (μ A) max.	tan δ at 100 Hz (nom., l)	impedance at 100 kHz, nom. (Ω , l)		case size	catalogue number 2222 followed by		
					+20 °C	-20 °C		style 1	styles 2+3	style 4
63	0.47	7	5	0.06	5	25	3	015 18477	015 48477	
63	0.47	6	1	0.06	4	20	4	016 18477	016 48477	
63	1	10	5	0.06	3	25	3	015 18108	015 48108	
63	1	12	1	0.06	2	10	4	016 18108	016 48108	
63	1.5	9	5	0.06	12	14.5	1	015 18158	015 48158	
63	1.5	12	5	0.06	2.5	25	3	015 90001	015 90002	
63	2.2	15	7	0.06	2	25	3	015 18228	015 48228	
63	2.2	21	2	0.06	1.4	7	4	016 18228	016 48228	
63	3.3	17	11	0.06	2	25	3	015 18338	015 48338	
63	4.7	22	15	0.06	2	25	3	015 90003	015 90004	
63	4.7	18	15	0.06	4	50	2	015 18478	015 48478	
63	4.7	31	3	0.06	1.2	6	4	016 18478	016 48478	
63	6.8	25	22	0.06	2	25	3	015 18688	015 48688	
63	10	30	32	0.06	2	25	3	015 18109	015 48109	
63	10	44	7	0.06	0.6	6	4	016 18109	016 48109	
63	15	43	48	0.06	1	12	5a	015 18159	015 48159	
63	15	55	10	0.06	0.5	6	4	016 18159	016 48159	
63	22	80	13	0.06	0.35	4.5	5	016 18229	016 48229	
63	47	115	22	0.06	0.2	2.4	6	016 18479	016 48479	
63	68	195	30	0.06	0.2	1	00	017 18689	017 48689	017 58689
63	100	240	42	0.06	0.2	0.75	01	017 18101	017 48101	017 58101
63	150	280	61	0.06	0.2	0.75	01	017 18151	017 48151	017 58151
63	220	360	88	0.06	0.25	0.6	02	017 18221	017 48221	017 58221
63	330	495	129	0.06	0.3	0.5	03	017 18331	017 48331	017 58331

1) See also corresponding paragraph.



TESTS AND REQUIREMENTS

IEC 103 clause	IEC 68 test method	Name of test	Procedure (quick reference)	Requirements
13.7	-	Dielectric strength of insulating sleeve	Metal foil wrapped around body. 1000 V d.c. between foil and capacitor body for 1 min \pm 5 s, voltage increased gradually 100 V/s	No breakdown or flashover
-	-	Lead pull	Axial pull on lead till destruction occurs	\geq 40 N (4 kg)
14.1	Ua	Tensile strength of leads	Loading weight 10 N (1 kg)	No visible damage
14.2	Ub	Bending, half of the leads	Two consecutive bends	No visible damage
14.3	Uc	Torsion, other half of the leads	Two successive rotations of 180°	No visible damage

WET ALUMINIUM
ELECTROLYTIC CAPACITORS

2222 015-
2222 017

IEC 103 clause	IEC 68 test method	Name of test	Procedure (quick reference)	Requirements
15	(T3.2)	Soldering (solder bath)	Solderability: style 1 : 230 °C, 2 s other styles: 270 °C, 2 s Resistance to heat: 350 °C, 3 s Single-ended versions immersed up to 13.5 mm from emergence of lead.	Good tinning: no visible damage
15	T3.3	Soldering	Size A soldering iron, 10 s	Good tinning
15	T3.4	Soldering	Solder globule method	Wetting within 4 s
16	Na 1)	Rapid change of temperature	1 cycle of 3 h at +85 °C and 3 h at -40 °C	No visible damage
17	Fc 2)	Vibration	10-500 Hz for cat. 40/085/56 and 10-55 Hz for other categories; 0.75 mm or 10 g (whichever is the less), 6 h	No visible damage; $\Delta C \leq 5\%$

1) For category 40/085/56 only.

2) This test is not applied to style 3 capacitors in case sizes 00 to 03.

IEC 103 clause	IEC 68 test method	Name of test	Procedure (quick reference)	Requirements
19.2	Ba	Dry heat	16 h at upper cat. temp. with rated voltage applied	Leakage current at 85 °C ≤ 5 x stated limit, at 70 °C 3x, no visible damage
19.3	D	Accelerated damp heat, first cycle	24 h at 55 ± 2 °C and R.H. 95 to 100%	After recovery immediately followed by cold test.
19.4	Aa	Cold	2 h at lower cat. temp.	Ratio of impedance at -40 °C to that at +20 °C (100 Hz); 5 for 6.3 V ratings 4 for 10-16 V ratings 3 for ≥ 25 V ratings ΔC ≤ 5%; no damage. Above ratio at -25 °C; 2x all ratings
19.5	Qc	Sealing	1 min in water at 90 °C	No seepage
19.6	D	Accelerated damp heat, remaining cycles	5 cycles of 24 h at 55 °C and R.H. 90-100%	No visible damage; leakage current and tan δ ≤ stated limit; ΔC ≤ 5%
20	C	Damp heat (long term)	56 days at 55 °C and R.H. 90 to 95%	No visible damage; leakage current and tan δ ≤ stated limit; ΔC equal to or better than -20%; insulation breakdown at ≥ 1000 V

IEC 103 clause	IEC 68 test method	Name of test	Procedure (quick reference)	Requirements
21.1	Ha	Storage, high temperature (half of the lot)	96 ± 4 h at upper cat. temp. Cooling time ≥ 16 h	Leakage current ≤ 2 x stated limit; tan δ ≤ 1.2 x stated limit; ΔC ≤ 10%
21.2	Hb	Storage, low temperature (other half of the lot)	72 h at -40 °C for cat. 25/070/56 and 25/085/56 -55 °C for cat. 40/085/56 recovery time ≥ 16 h	Leakage current ≤ stated limit; tan δ ≤ stated limit; ΔC ≤ 10%
22		Endurance	Type 1 capacitors: 2000 h at 85 °C with rated voltage applied recovery time ≥ 16 h Type 2 capacitors: 1000 h at upper cat. temp. with rated voltage applied	No visible damage; leakage current ≤ stated limit; tan δ ≤ 1.3 x stated limit; ΔC ≤ 15%; ratio of Z at 20 kHz before and after test ≤ 2%; no insulation breakdown at 1000 V d.c. No visible damage; leakage current ≤ stated limit; tan δ ≤ 1.5 x stated limit or tan δ = 0, 4 whichever is greater; ΔC ≤ 15%; ratio of Z at 20 kHz before and after test ≤ 5%, no insulation breakdown at 1000 V d.c.
23		Surge	From source of p x UR, p = 1.15 for UR ≤ 315 V, RC = 100 ± 50 μs; 5000 cycles of 10 s on, 50 s off	Leakage current and tan δ ≤ stated limit; ΔC ≤ 15%

810 2050
170 0700

W. DONALD BIRD
W. DONALD BIRD

70 °C

ELECTROLYTIC CAPACITORS

small type, for general purposes

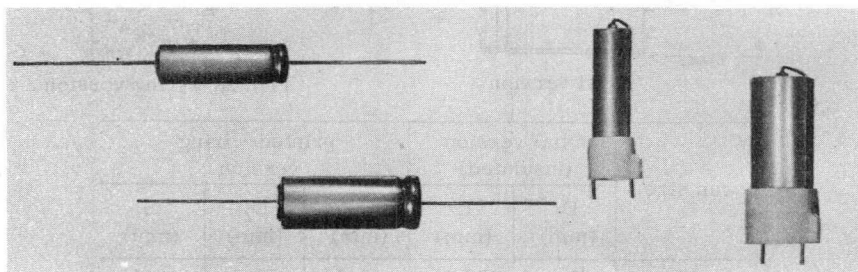

RZ 16995-3E

These capacitors are specially suitable for coupling and decoupling in small transistorised equipment, such as portable radio receivers, personal recorders, and similar applications where high capacitance values are needed.

This range of electrolytic capacitors, to be considered as an extension of the miniature 001 and 002 series, is characterised by interesting features: small size, high capacitance values and a long service life.

The sturdy mechanical construction - with welded terminals - ensures long and reliable operation. Low leakage currents could be achieved by employing highly purified material by a carefully controlled manufacturing process.

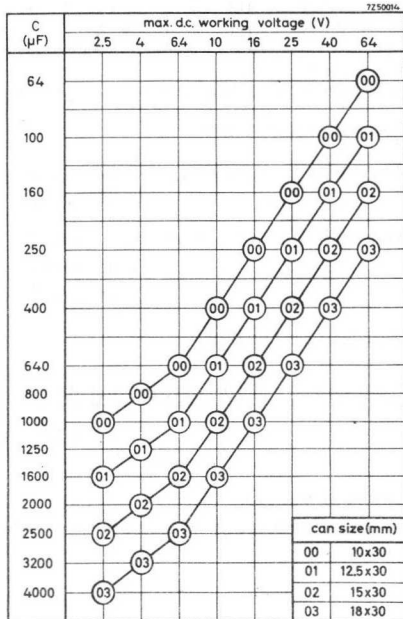

Dimensions in mm

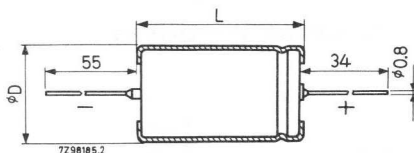

Axial version

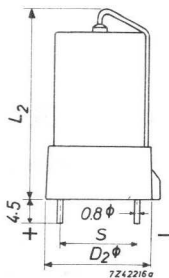

Printed-wiring version

can size	axial version (insulated)		printed-wiring version		
	D (mm)	L (mm)	D ₂ (mm)	L ₂ (mm)	S (mm)
00	10.4	30.5	12.8	39.3	10.16
01	12.9	30.5	15.2	39.3	10.16
02	15.4	30.5	17.8	39.3	12.70
03	18.5	30.5	20.8	39.3	15.24

Tolerance on capacitance

-10/+50 %

Temperature range

-40/+70 °C

Maximum temperature for 12 hours
per 24 hours

85 °C

Peak voltage for 1 minute per hour:

at +85 °C

1.125 x working voltage +0.5 V

at ≤ +40 °C

1.25 x working voltage +0.5 V

Climatic robustness

category 40/070/56 (IEC 68)

Composition of the catalog number

suffix, see table

2222 023

1 = axial version

4 = printed-wiring version

capacitance code

working voltage code

can size	working voltage (V)	capacitance (μF)	leakage current ¹⁾ (μA)	ripple current ²⁾ (mA)	dissipation factor ³⁾	impedance ⁴⁾ (Ω)	suffix axial version ⁵⁾
00	2.5	1000	100	180	0.35	1.0	11102
01		1600	145	260	0.35	0.8	11162
02		2500	215	360	0.35	0.8	11252
03		4000	325	500	0.35	0.8	11402
00	4	800	120	180	0.30	1.0	12801
01		1250	175	260	0.30	0.8	12132
02		2000	265	360	0.30	0.8	12202
03		3200	400	500	0.30	0.8	12322
00	6.4	640	145	180	0.25	1.0	13641
01		1000	215	260	0.25	0.8	13102
02		1600	325	360	0.25	0.8	13162
03		2500	500	500	0.25	0.8	13252
00	10	400	145	180	0.20	1.0	14401
01		640	215	260	0.20	0.8	14641
02		1000	325	350	0.20	0.8	14102
03		1600	500	500	0.20	0.8	14162
00	16	250	145	180	0.15	1.0	15251
01		400	215	260	0.15	0.8	15401
02		640	325	360	0.15	0.8	15641
03		1000	500	450	0.15	0.8	15102
00	25	160	145	110	0.15	1.0	16161
01		250	215	160	0.15	0.8	16251
02		400	325	220	0.15	0.8	16401
03		640	500	310	0.15	0.8	16641
00	40	100	145	110	0.1	1.2	17101
01		160	215	160	0.1	1.2	17161
02		250	325	220	0.1	0.8	17251
03		400	500	310	0.1	0.8	17401
00	64	64	145	110	0.1	1.2	18649
01		100	215	160	0.1	1.2	18101
02		160	325	220	0.1	0.8	18161
03		250	500	310	0.1	0.8	18251

- 1) Maximum leakage current at 20 °C after 5 minutes
- 2) Maximum permissible ripple current at 50 Hz and 70 °C.
- 3) Maximum dissipation factor ($\tan \delta$) at 20 °C and 50 Hz
- 4) Maximum impedance at 20 °C and 100 kHz
- 5) See composition of the catalog number.

1870

70 °C

ELECTROLYTIC CAPACITORS

small type, for high voltages

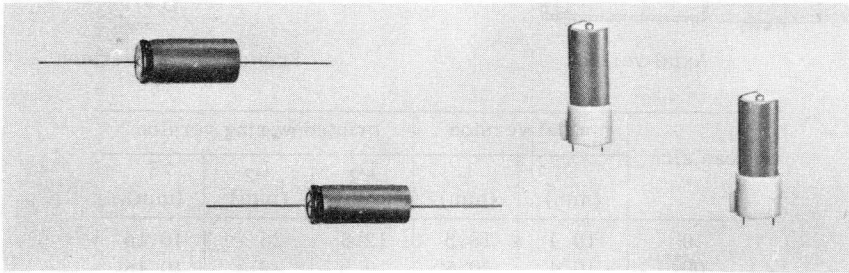

RZ 15568-2

Due to the high working voltages and permissible temperature these small size capacitors are suitable for decoupling in all kind of tube equipment such as radio and television receivers and similar applications. They have been designed for operation between -40 to +70 °C.

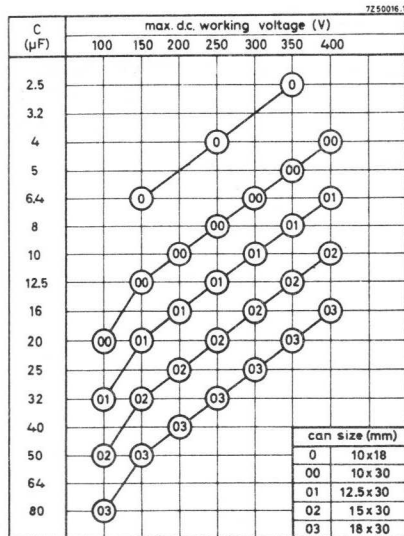

Dimensions in mm

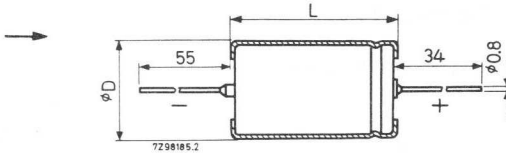

Axial version

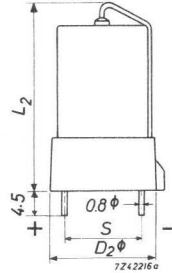

Printed-wiring version

can size	axial version		printed-wiring version		
	D (mm)	L (mm)	D_2 (mm)	L_2 (mm)	S (mm)
0	10.4	18.5	12.8	26	10.16
00	10.4	30.5	12.8	39.3	10.16
01	12.9	30.5	15.2	39.3	10.16
02	15.4	30.5	17.8	39.3	12.70
03	18.5	30.5	20.8	39.3	15.24

Tolerance on capacitance:

-10/+30%

Temperature range

-40/+70°C

Peak voltage for 1 minute per hour:

at +70 °C

1.125 x working voltage +0.5 V

at \leq +40 °C

1.25 x working voltage +0.5 V

Climatic robustness

category 40/070/56 (IEC68)

can size	working voltage (V)	capacitance (μF)	leakage current ¹⁾ (μA)	ripple current ²⁾ (mA)	dissipation factor ³⁾	impedance ⁴⁾ (Ω)	2222 040 followed by ⁵⁾
00	100	20	85	50	0.15	6.4	10209
01		32	130	75	0.15	4.0	10329
02		50	180	100	0.15	2.5	10509
03		80	270	125	0.15	1.6	10809
0	150	6.4	55	25	0.15	15.0	11648
00		12.5	85	50	0.15	8.0	11139
01		20	130	75	0.15	5.0	11209
02		32	180	100	0.15	3.0	11329
03		50	270	125	0.15	2.0	11509
00	200	10	85	25	0.15	8.0	12109
01		16	130	50	0.15	5.0	12169
02		25	180	75	0.15	3.0	12259
03		40	270	100	0.15	2.0	12409
0	250	4	55	25	0.15	20.0	13408
00		8	85	25	0.15	10.0	13808
01		12.5	130	50	0.15	6.4	13139
02		20	180	75	0.15	4.0	13209
03		32	270	100	0.15	2.5	13329
00	300	6.4	85	25	0.15	20.0	14648
01		10	130	50	0.15	15.0	14109
02		16	180	75	0.15	8.0	14169
03		25	270	100	0.15	5.0	14259
0	350	2.5	55	25	0.15	60.0	15258
00		5	85	25	0.15	30.0	15508
01		8	110	25	0.15	20.0	15808
02		12.5	160	50	0.15	15.0	15139
03		20	240	75	0.15	8.0	15209
00	400	4	85	25	0.15	45.0	16408
01		6.4	110	25	0.15	30.0	16648
02		10	160	50	0.15	20.0	16109
03		16	240	75	0.15	12.5	16169

1) Maximum leakage current at 20 °C after 5 minutes.

2) Maximum permissible ripple current at 100 Hz and 70 °C.

3) Maximum dissipation factor ($\tan \delta$) at 20 °C and 50 Hz.

4) Maximum impedance at 20 °C and 100 kHz.

5) For axial version, for printed-wiring version the first digit of the suffix is 4.

1940

ELECTROLYTIC CAPACITORS

large type, for general purposes

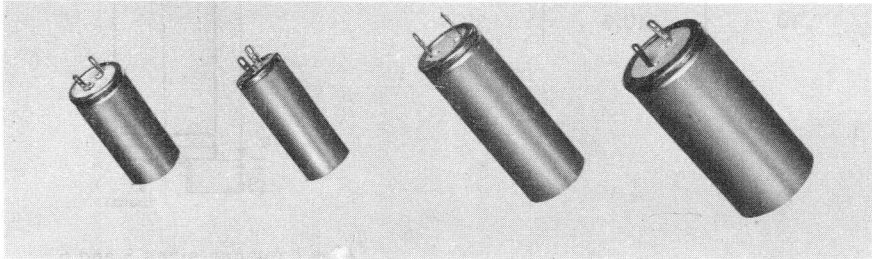

RZ 15738-8B

This range of high-capacitance electrolytic capacitors has been developed for coupling and decoupling applications in mains-operated transistorised equipment, and their design makes them particularly suitable for television receivers. In applications of this type high alternating currents are often involved; therefore, special attention has been given to the current rating of these capacitors.

A special construction guarantees a very low equivalent series resistance which makes them suitable for high ripple currents.

The capacitors are insulated. The five can sizes cover a range of capacitance of from 320 to 20000 μF with working voltages between 6.4 and 64 V_{dc} .

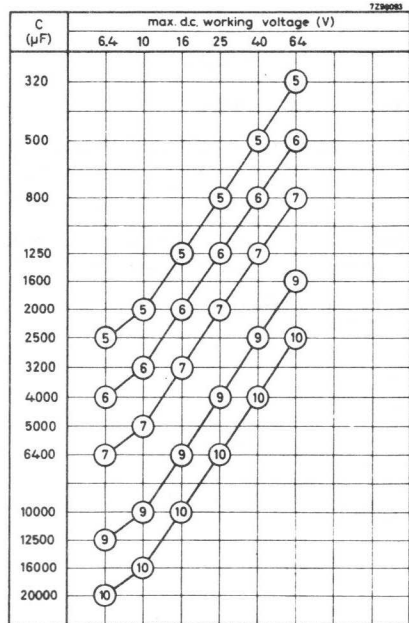

Dimensions in mm

See also "Mounting clamps":

can size	D (mm)	L (mm)
5	21.5	49.5
6	25.5	49.5
7	25.5	80.5
9	35.5	80.5
10	40.5	80.5

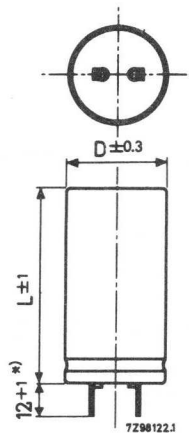

*) 8 + 1 for can sizes 5 and 6

Tolerance on capacitance

-10/+50 %

Temperature range

-40/+70 °C

Peak voltage during 1 minute per hour:

at +70 °C

1.125 x working voltage +0.5 V

at \leq +40 °C

1.25 x working voltage +0.5 V

Max. ripple current (r.m.s.) as a function of frequency and temperature

$$\sqrt{\frac{\text{max. dissipation}}{\text{series resistance}}}$$

Climatic robustness

category 40/070/56 (IEC 68)

can size	working voltage (V)	capacitance (μF)	leakage current ¹⁾ (mA)	ripple current ²⁾ (mA)	dissipation factor ³⁾	impedance ⁴⁾ (Ω)	at No. 2222 060 followed by
5	6.4	2500	0.5	650	0.45	0.40	13252
6		4000	0.8	800	0.45	0.25	13402
7		6400	1.2	1250	0.45	0.16	13642
9		12500	2.4	2100	0.45	0.16	13133
10		20000	3.8	2900	0.45	0.16	13203
5	10	2000	0.6	650	0.3	0.40	14202
6		3200	1.0	800	0.4	0.25	14322
7		5000	1.5	1250	0.4	0.16	14502
9		10000	3.0	2100	0.4	0.16	14103
10		16000	4.8	2900	0.4	0.16	14163
5	16	1250	0.6	450	0.25	0.40	15132
6		2000	1.0	650	0.25	0.25	15202
7		3200	1.5	1000	0.35	0.16	15322
9		6400	3.0	1700	0.35	0.16	15642
10		10000	4.8	2300	0.35	0.16	15103
5	25	800	0.6	450	0.2	0.40	16801
6		1250	1.0	650	0.2	0.25	16132
7		2000	1.5	1000	0.2	0.16	16202
9		4000	3.0	1700	0.25	0.16	16402
10		6400	4.8	2300	0.25	0.16	16642
5	40	500	0.6	450	0.15	0.40	17501
6		800	1.0	650	0.15	0.25	17801
7		1250	1.5	1000	0.15	0.16	17132
9		2500	3.0	1700	0.15	0.16	17252
10		4000	4.8	2300	0.15	0.16	17402
5	64	320	0.6	450	0.10	0.40	18321
6		500	1.0	650	0.10	0.25	18501
7		800	1.5	1000	0.10	0.16	18801
9		1600	3.0	1700	0.10	0.16	18162
10		2500	4.8	2300	0.10	0.16	18252

1) Maximum leakage current at 20 °C after 5 minutes

2) Maximum permissible ripple current at 50 Hz and 70 °C

3) Maximum dissipation factor ($\tan \delta$) at 20 °C and 50 Hz

4) Maximum impedance at 20 °C and 100 kHz.

Mounting clamps 4322 043 03290 to 03330

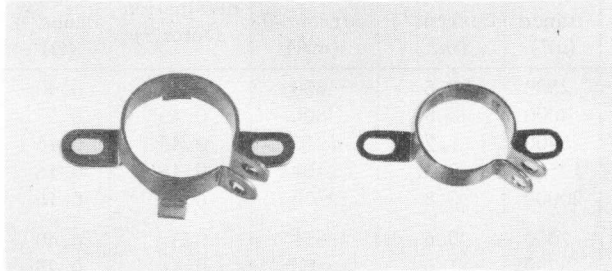

RZ 19634-1

To facilitate vertical mounting, a series of rigid clamps made of cadmium-plated steel are available. They can easily be slid over the capacitor and then fixed to it with a nut and bolt. They are provided with two mounting lugs and, except the smallest version, with two supports to give stability in the cross direction.

Four types are available, one for each can diameter of the capacitor range. They are delivered without nuts or bolts.

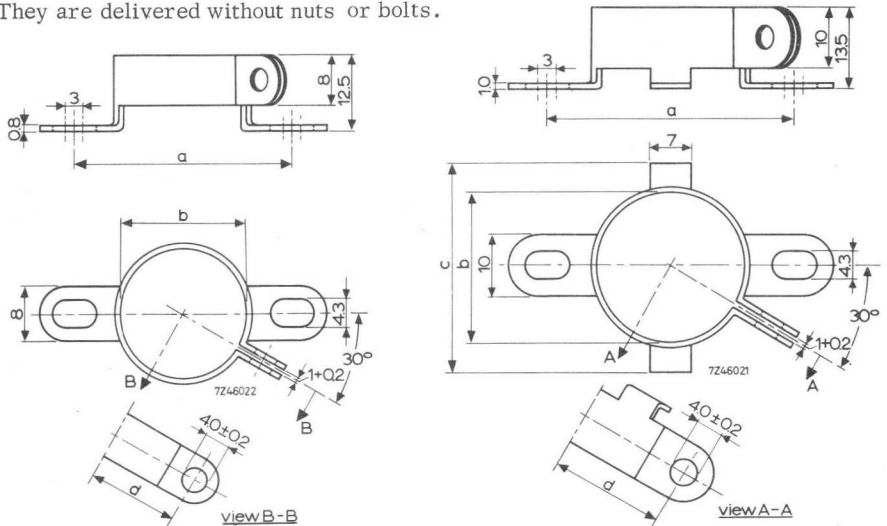

For can size 5

For can sizes 6 to 9

can size	dimensions in mm				catalog number
	a	b	c	d	
5	37.0 +0.2	21	-	15.5	4322 043 03290
6, 7	41.5 +0.2	25	35	18.5	03300
8	46.5 +0.2	30	40	21	03310
9	51.5 +0.2	35	45	23.5	03320
10	56.5 +0.2	40	50	26	03330

ELECTROLYTIC CAPACITORS

large types for high and low voltages

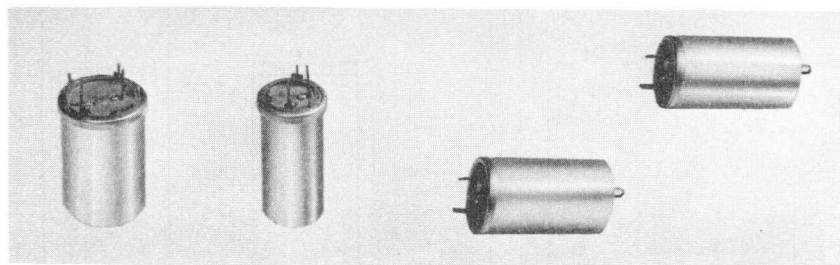

RZ 17647-1

Due to the high working voltages and high permissible temperature these capacitors are suitable for use in power supplies of tube equipment.

There are ten can sizes and three mechanical versions.

- Capacitors with soldering terminals acting as positive and negative terminals, either suspended in the wiring of the equipment or fixed by means of a bracket.
- Capacitors provided with three or four twistable mounting lugs which serve as negative terminals. One or two soldering tags on the seal serve as positive terminals.
- Capacitors for printed-wiring boards. The can has a metallic base with three or four soldering tags for mounting and for serving as negative terminals. One or two pins through the seal serve as positive terminals.

These capacitors have insulated cans.

Tolerance on capacitance: 6.4- 64 V types -10/+50 %
100-500 V types -10/+30 %

Temperature range -40/+70 °C

Peak temperature (12 hours per 24 hours) for types ≤ 64 V 85 °C

Peak voltage during 1 minute per hour:

for types ≤ 64 V, at 70 °C	1.125 x working voltage +0.5 V
at ≤ 40 °C	1.25 x working voltage +0.5 V

for types with a working voltage of:

the peak voltage is:

100	150	200	250	300	350	400	450	500 V
110	170	225	280	340	395	450	500	550 V

Climatic robustness

category 40/070/56 (IEC 68)

2222 063 - 064
2222 080 - 081

ELECTROLYTIC CAPACITORS
 Large type, for high and low voltages

(C433)

Capacitors with soldering terminals

Capacitors with twistable mounting lugs

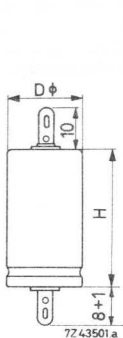

Sizes 4, 5, 6

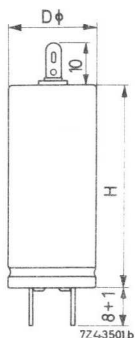

Sizes 3, 4, 5, 6

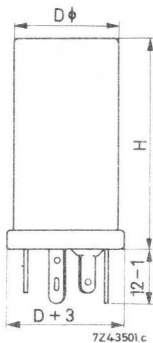

Sizes 6T, 7

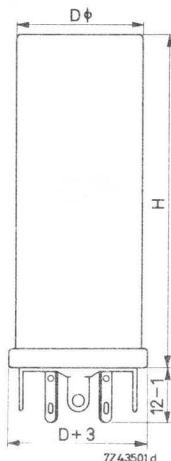

Sizes 8, 9

Capacitors for printed-wiring boards

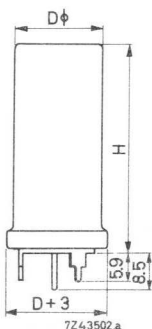
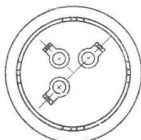
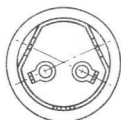
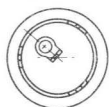

Sizes 4, 5

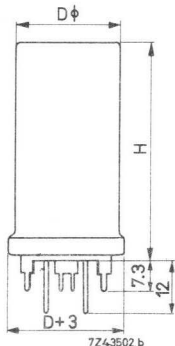

Size 6T

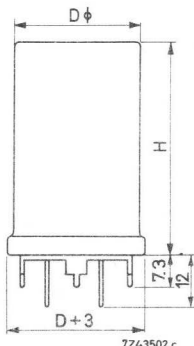

Sizes 8A, 9A

Dimensions (mm)

can size	D	H
3	19	34
4	19	50
5	22	50
6	26	50
6T	26	52
7	26	81
8	31	81
8A	31	52
9	36	81
9A	36	52

One of the mounting tags of size 9A cans is a double tag.

Hole patterns for printed-wiring boards, component side, grid pitch 2.54 mm

7Z46878

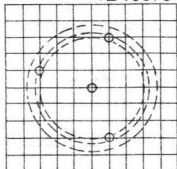

Can size 4,
single type,
3 mounting tags

7Z46875

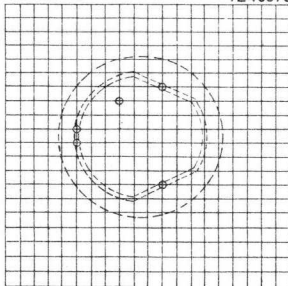

Can size 6T, single type,
3 mounting tags

7Z46876

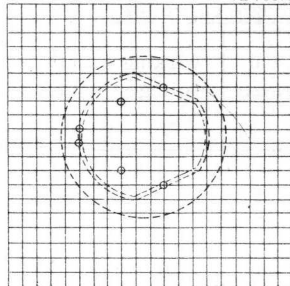

Can size 6T, double type,
3 mounting tags

7Z46877

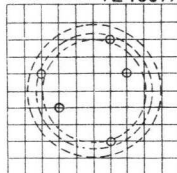

Can size 4,
double type,
3 mounting tags

7Z46880

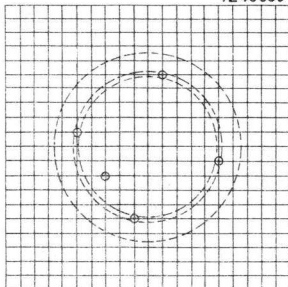

Can size 8A, single type,
4 mounting tags

7Z46881

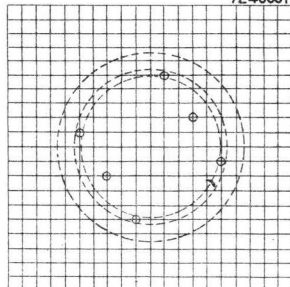

Can size 8A, double type,
4 mounting tags

7Z47035

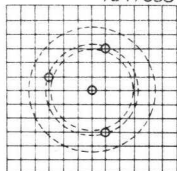

Can size 5,
single type,
3 mounting tags

7Z46882.2

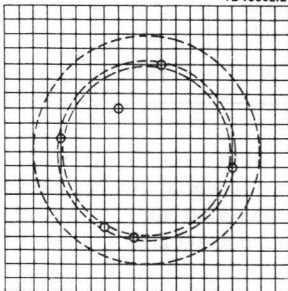

Can size 9A, single type,
4 mounting tags

7Z46883.1

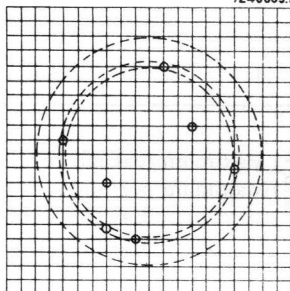

Can size 9A, double type,
4 mounting tags

7Z46879

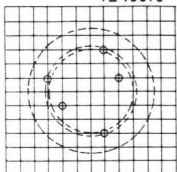

Can size 5,
double type,
3 mounting tags

2222 063-064
2222 080-081

ELECTROLYTIC CAPACITORS
 Large type, for high and low voltages

(C433)

CAPACITORS WITH SOLDERING TERMINALS (no mounting lugs)

Single capacitors

can size	working voltage (V)	capacitance (μF)	leakage current 1) (μA)	ripple current 2) (mA)	dissipation factor 3)	impedance 4) (Ω)	cat. number 2222 followed by
4	6.4	1600	220	600	0.50	0.63	063 13162
5		2500	500	850	0.45	0.40	252
6		4000	770	1000	0.45	0.25	402
4	10	1250	400	600	0.30	0.63	063 14132
5		2000	630	850	0.30	0.40	202
6		3200	1000	1000	0.40	0.25	322
4	16	800	400	500	0.25	0.63	063 15801
5		1250	600	700	0.25	0.40	132
6		2000	1000	1000	0.25	0.25	202
4	25	500	400	450	0.20	0.63	063 16501
5		800	600	650	0.20	0.40	801
6		1250	1000	850	0.20	0.25	132
4	40	320	400	450	0.15	0.63	063 17321
5		500	600	650	0.15	0.40	501
6		800	1000	800	0.15	0.25	801
4	64	200	400	400	0.10	0.63	063 18201
5		320	600	500	0.10	0.40	321
6		500	1000	800	0.10	0.25	501
4	100	100	330	250	0.15	1.25	080 10101
6		250	780	450	0.15	0.63	251
4	150	64	330	200	0.15	1.5	080 11649
5		100	500	250	0.15	1.0	101
4	250	50	400	150	0.15	1.5	080 13509

1) Maximum leakage current at 20 °C after 5 minutes.

2) Maximum permissible ripple current at 100 Hz and 70 °C.

3) Maximum dissipation factor ($\tan \delta$) at 20 °C and 50 Hz.

4) Maximum impedance at 20 °C and 100 kHz.

Single capacitors with soldering terminals (continued) ←

can size	working voltage (V)	capacitance (μ F)	leakage current ¹⁾ (μ A)	ripple current ²⁾ (mA)	dissipation factor ³⁾	impedance ⁴⁾ (Ω)	cat. number 2222 followed by
5	300	64	600	200	0.15	2	080 14649
6		100	930	250	0.15	1.25	101
4	350	32	360	100	0.15	4.5	080 15329
5		50	550	150	0.15	2.8	509
6		64	700	200	0.15	2.3	649
4	400	25	330	100	0.30	5.85	080 16259
5		32	410	150	0.30	7.3	329
6		50	630	200	0.30	4.55	509
4	500	16	270	100	0.30	19.5	080 18169
5		25	400	100	0.30	13	259
6		32	500	150	0.30	10.3	329

¹⁾ Maximum leakage current at 20 °C after 5 minutes.

²⁾ Maximum permissible ripple current at 100 Hz and 70 °C.

³⁾ Maximum dissipation factor ($\tan \delta$) at 20 °C and 50 Hz.

⁴⁾ Maximum impedance at 20 °C and 100 kHz.

Double capacitors with soldering terminals

can size	working voltage (V)	capacitance (μF)	leakage current 1) (μA)	ripple current 2) (mA)	dissipation factor 3)	impedance 4) (Ω)	cat. number 2222 followed by
4	10	640+ 640	2x200	2x300	0,30	2x1.25	064 14641
5		1000+1000	2x330	2x425	0,30	2x0.8	102
6		1600+1600	2x500	2x500	0,40	2x0.5	162
4	25	250 + 250	2x200	2x225	0,20	2x1.25	064 16251
5		400 + 400	2x300	2x325	0,20	2x0.8	401
6		640 + 640	2x500	2x425	0,20	2x0.5	641
4	64	100 + 100	2x200	2x200	0,10	2x1.25	064 18101
5		160 + 160	2x300	2x250	0,10	2x0.8	161
6		250 + 250	2x500	2x400	0,10	2x0.5	251
3	100	25 + 25	2x100	2x 50	0,15	2x5	081 10259
4		50 + 50	2x180	2x125	0,15	2x2.5	509
6		125 +125	2x400	2x225	0,15	2x1.25	131
4	150	32 + 32	2x115	2x100	0,15	2x3.0	081 11329
5		50 + 50	2x265	2x125	0,15	2x2	509
3	200	16 + 16	2x125	2x 50	0,15	2x4.5	081 12169
3	250	12.5+12.5	2x100	2x 50	0,15	2x6.3	081 13139
4		25 + 25	2x200	2x 75	0,15	2x3	259
5	300	32 + 32	2x330	2x100	0,15	2x4	081 14329
6		50 + 50	2x500	2x125	0,15	2x2.5	509

- 1) Maximum leakage current at 20 °C after 5 minutes.
- 2) Maximum permissible ripple current at 100 Hz and 70 °C.
- 3) Maximum dissipation factor ($\tan \delta$) at 20 °C and 50 Hz.
- 4) Maximum impedance at 20 °C and 100 kHz.

Double capacitors with soldering terminals (continued)

can size	working voltage (V)	capacitance (μF)	leakage current 1) (μA)	ripple current 2) (mA)	dissipation factor 3)	impedance 4) (Ω)	cat. number 2222 followed by
3	350	8 + 8	2x100	2x 25	0.15	2x18	081 15808
4		16 + 16	2x200	2x 50	0.15	2x 9	169
5		25 + 25	2x300	2x 75	0.15	2x 5.5	259
6		32 + 32	2x360	2x100	0.15	2x 4.5	329
4	400	12.5+12.5	2x165	2x 50	0.30	2x18.2	081 16139
5		16 + 16	2x200	2x 75	0.30	2x14.5	169
6		25 + 25	2x330	2x100	0.30	2x 9.1	259
3	500	4 + 4	2x 80	2x 25	0.30	2x81	081 18408
4		8 + 8	2x135	2x 50	0.30	2x39	808
5		12.5+12.5	2x200	2x 50	0.30	2x26	139
6		16 + 16	2x270	2x 75	0.30	2x20	169

- 1) Maximum leakage current at 20 °C after 5 minutes.
- 2) Maximum permissible ripple current at 100 Hz and 70 °C.
- 3) Maximum dissipation factor ($\tan \delta$) at 20 °C and 50 Hz.
- 4) Maximum impedance at 20 °C and 100 kHz.

2222 063 - 064
2222 080 - 081

ELECTROLYTIC CAPACITORS
 Large type, for high and low voltages

(C433)

CAPACITORS WITH TWISTABLE MOUNTING LUGS

→ Single capacitors

can size	working voltage (V)	capacitance (μF)	leakage current 1) (μA)	ripple current 2) (mA)	dissipation factor 3)	impedance 4) (Ω)	cat. number 2222 followed by
6T	25	1250	1000	850	0.20	0.25	063 36132
7		2000	1500	1100	0.20	0.15	202
8		2500	2000	1200	0.20	0.15	252
6T	40	800	1000	800	0.15	0.25	063 37801
7		1250	1500	1100	0.15	0.15	132
8		1600	2000	1200	0.15	0.15	162
6T	64	500	1000	800	0.10	0.25	063 38501
7		800	1500	1100	0.10	0.15	801
8		1000	2000	1200	0.10	0.15	102
6T	100	250	780	450	0.15	0.63	080 30251
7		500	1500	650	0.15	0.63	501
7	150	250	1150	450	0.15	0.63	080 31251
8		500	2300	650	0.15	0.63	501
6T	300	100	930	250	0.15	1.25	080 34101
8		250	2300	450	0.15	0.63	251
6T	350	64	700	200	0.15	2.3	080 35649
9		250	2650	500	0.15	0.63	251
6T	400	50	630	200	0.30	4.55	080 36509
7		100	1200	200	0.30	2.3	101
7	450	64	900	200	0.30	3.65	080 37649
8		100	1300	200	0.30	2.3	101
6T	500	32	500	150	0.30	10.3	080 38329
7		50	780	200	0.30	6.5	509
8		64	1000	200	0.30	5.2	649
9		100	1500	300	0.30	3.25	101

For footnotes see previous page.

Double capacitors with twistable mounting lugs

can size	working voltage (V)	capacitance (μ F)	leakage current 1) (μ A)	ripple current 2) (mA)	dissipation factor 3)	impedance 4) (Ω)	cat. number 2222 followed by
6T	25	640+ 640	2x 500	2x425	0.20	2x0.5	064 36641
7		1000+1000	2x 780	2x550	0.20	2x0.3	102
8		1250+1250	2x1000	2x600	0.50	2x0.3	132
6T	64	250 + 250	2x 500	2x400	0.10	2x0.5	064 38251
7		400 + 400	2x 750	2x550	0.10	2x0.3	401
8		500 + 500	2x1000	2x600	0.10	2x0.3	501
6T	100	125 + 125	2x 400	2x225	0.15	2x1.25	081 30131
7		250 + 250	2x 780	2x325	0.15	2x1.25	251
6T	150	125 + 125	2x 650	2x225	0.15	2x1.25	081 31131
8		250 + 250	2x1150	2x325	0.15	2x1.25	251
6T	300	50 + 50	2x 500	2x125	0.15	2x2.5	081 34509
8		125 + 125	2x1150	2x225	0.15	2x1.25	131
6T	350	32 + 32	2x 360	2x100	0.15	2x4.5	081 35329
9		125 + 125	2x1350	2x250	0.15	2x1.25	131
6T	400	25 + 25	2x 330	2x100	0.30	2x9.1	081 36259
7		50 + 50	2x 630	2x100	0.30	2x 4.55	509
7	450	32 + 32	2x 460	2x100	0.30	2x 7.2	081 37329
8		50 + 50	2x 700	2x100	0.30	2x 4.55	509
6T	500	16 + 16	2x 270	2x 75	0.30	2x20	081 38169
7		25 + 25	2x 400	2x100	0.30	2x13	259
8		32 + 32	2x 500	2x100	0.30	2x10.4	329
9		50 + 50	2x 780	2x150	0.30	2x 6.5	509

For footnotes see following pages.

2222 063 - 064
2222 080 - 081

ELECTROLYTIC CAPACITORS
 Large type, for high and low voltages

(C433)

CAPACITORS FOR PRINTED-WIRING BOARDS

Single capacitors

can size	working voltage (V)	capacitance (μ F)	leakage current 1) (μ A)	ripple current 2) (mA)	dissipation factor 3)	impedance 4) (Ω)	cat. number 2222 followed by
4	6.4	1600	220	600	0.50	0.63	063 53162
5		2500	500	850	0.45	0.40	252
6T		4000	770	1000	0.45	0.25	402
8A		6400	1220	1300	0.45	0.15	642
9A		8000	1550	1500	0.45	0.15	802
4	10	1250	400	600	0.30	0.63	063 54132
5		2000	630	850	0.30	0.40	202
6T		3200	1000	1000	0.40	0.25	322
9A		6400	2000	1500	0.40	0.15	642
4	16	800	400	500	0.25	0.63	063 55801
5		1250	600	700	0.25	0.40	132
6T		2000	1000	1000	0.25	0.25	202
8A		3200	1500	1200	0.35	0.15	322
9A		4000	2000	1300	0.35	0.15	402
4	25	500	400	450	0.20	0.63	063 56501
5		800	600	650	0.20	0.40	801
6T		1250	1000	850	0.20	0.25	132
8A		2000	1500	1100	0.20	0.15	202
9A		2500	2000	1200	0.20	0.15	252
4	40	320	400	450	0.15	0.63	063 57321
5		500	600	650	0.15	0.40	501
6T		800	1000	800	0.15	0.25	801
8A		1250	1500	1100	0.15	0.15	132
9A		1600	2000	1200	0.15	0.15	162
4	64	200	400	400	0.10	0.63	063 58201
5		320	600	500	0.10	0.40	321
6T		500	1000	800	0.10	0.25	501
8A		800	1500	1100	0.10	0.15	801
9A		1000	2000	1200	0.10	0.15	102
4	100	100	330	250	0.15	1.25	080 50101
6T		250	780	450	0.15	0.63	251
8A		500	1500	650	0.15	0.63	501

For notes see next page.

Single capacitors for printed wiring boards (continued)

can size	working voltage (V)	capacitance (μF)	leakage current 1) (μA)	ripple current 2) (mA)	dissipation factor 3)	impedance 4) (Ω)	cat. number 2222 followed by
4	150	64	330	200	0.15	1.5	080 51649
5		100	500	250	0.15	1.0	101
8A		250	1150	450	0.15	0.63	251
9A	200	250	1500	450	0.15	0.63	080 52251
5	300	64	600	200	0.15	2	080 54649
6T		100	930	250	0.15	1.25	101
4	350	32	360	100	0.15	4.5	080 55329
5		50	550	150	0.15	2.8	509
6T		64	700	200	0.15	2.3	649
4	400	25	330	100	0.30	5.85	080 56259
5		32	410	150	0.30	7.3	329
6T		50	630	200	0.30	4.55	509
8A		100	1200	200	0.30	2.3	101
8A	450	64	900	200	0.30	3.65	080 57649
4	500	16	270	100	0.30	19.5	080 58169
5		25	400	100	0.30	13	259
6T		32	500	150	0.30	10.3	329
8A		50	780	200	0.30	6.5	509
9A		64	1000	200	0.30	5.2	649

1) Maximum leakage current at 20 °C after 5 minutes.

2) Maximum permissible ripple current at 100 Hz and 70 °C.

3) Maximum dissipation factor ($\tan \delta$) at 20 °C and 50 Hz.

4) Maximum impedance at 20 °C and 100 kHz.

Double capacitors for printed-wiring boards

can size	working voltage (V)	capacitance (μF)	leakage current 1) (μA)	ripple current 2) (mA)	dissipation factor 3)	impedance 4) (Ω)	cat. number 2222 followed by
4	10	640+ 640	2x 200	2x300	0.30	2x1.25	064 54641
5		1000+1000	2x 330	2x425	0.30	2x0.8	102
6T		1600+1600	2x 500	2x500	0.40	2x0.5	162
8A		2500+2500	2x 750	2x650	0.40	2x0.3	252
9A		3200+3200	2x1000	2x750	0.40	2x0.3	322
4	25	250 + 250	2x 200	2x225	0.20	2x1.25	064 56251
5		400 + 400	2x 300	2x325	0.20	2x0.8	401
6T		640 + 640	2x 500	2x425	0.20	2x0.5	641
8A		1000+1000	2x 780	2x550	0.20	2x0.3	102
9A		1250+1250	2x1000	2x600	0.50	2x0.3	132
4	64	100 + 100	2x 200	2x200	0.10	2x1.25	064 58101
5		160 + 160	2x 300	2x250	0.10	2x0.8	161
6T		250 + 250	2x 500	2x400	0.10	2x0.5	251
8A		400 + 400	2x 750	2x550	0.10	2x0.3	401
9A		500 + 500	2x1000	2x600	0.10	2x0.3	501
4	100	50 + 50	2x180	2x125	0.15	2x2.5	081 50509
6T		125 + 125	2x400	2x225	0.15	2x1.25	131
8A		250 + 250	2x780	2x325	0.15	2x1.25	251
4	150	32 + 32	2x115	2x100	0.15	2x3.0	081 51329
5		50 + 50	2x265	2x125	0.15	2x2	509
8A		125 + 125	2x650	2x225	0.15	2x1.25	131
9A	200	125 + 125	2x750	2x225	0.15	2x1.25	081 52131
4	250	25 + 25	2x200	2x75	0.15	2x3	081 53259
5		50 + 50	2x400	2x125	0.15	2x1.5	509
5	300	32 + 32	2x330	2x100	0.15	2x4	081 54329
6T		50 + 50	2x500	2x125	0.15	2x2.5	509

- 1) Maximum leakage current at 20 °C after 5 minutes.
- 2) Maximum permissible ripple current at 100 Hz and 70 °C.
- 3) Maximum dissipation factor ($\tan \delta$) at 20 °C and 50 Hz.
- 4) Maximum impedance at 20 °C and 100 kHz.

Double capacitors for printed wiring boards (continued) ←

can size	working voltage (V)	capacitance (μF)	leakage current 1) (μA)	ripple current 2) (mA)	dissipation factor 3)	impedance 4) (Ω)	cat. number 2222 followed by
4	350	16+ 16	2x200	2x50	0.15	2x 9	081 55169
5		25+ 25	2x300	2x75	0.15	2x 5.5	259
6T		32+ 32	2x360	2x100	0.15	2x 4.5	329
4	400	12.5+12.5	2x165	2x50	0.30	2x18.2	081 56139
5		16+ 16	2x200	2x75	0.30	2x14.5	169
6T		25+ 25	2x330	2x100	0.30	2x 9.1	259
8A		50+ 50	2x630	2x100	0.30	2x 4.55	509
8A	450	32+ 32	2x460	2x100	0.30	2x 7.2	329
4		8+ 8	2x135	2x50	0.30	2x 39	081 58808
5	500	12.5+12.5	2x200	2x50	0.30	2x 26	139
6T		16+ 16	2x270	2x75	0.30	2x 20	169
8A		25+ 25	2x400	2x100	0.30	2x 13	259
9A		32+ 32	2x500	2x100	0.30	2x 10.4	329

1) Maximum leakage current at 20 °C after 5 minutes.

2) Maximum permissible ripple current at 100 Hz and 70 °C.

3) Maximum dissipation factor ($\tan \delta$) at 20 °C and 50 Hz.

4) Maximum impedance at 20 °C and 100 kHz.

IMPEDANCE GRAPHS

Typical impedance/temperature curves for the different can sizes are given below. The maximum values at 20 °C and 100 kHz are stated in the tables.

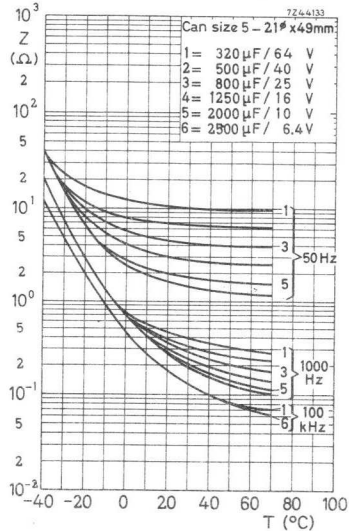
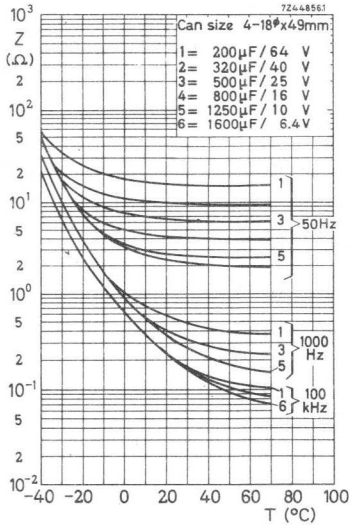

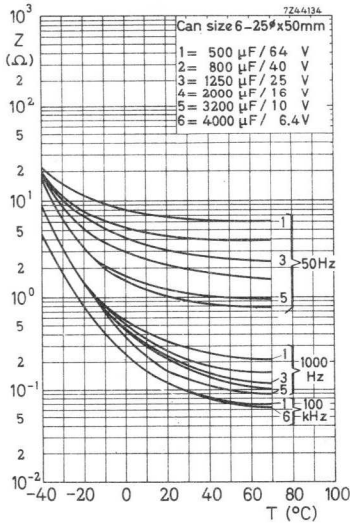

Can sizes 6, 6T

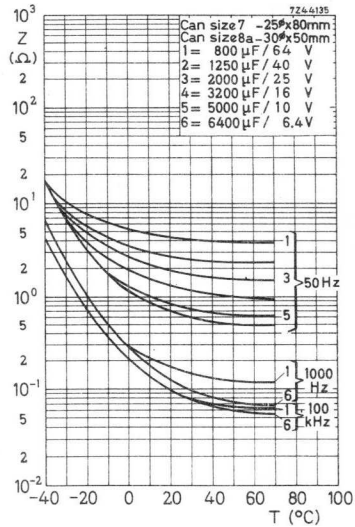

Can sizes 7, 8A

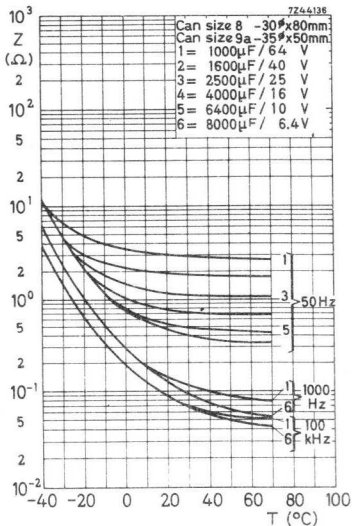

Can sizes 8, 9A

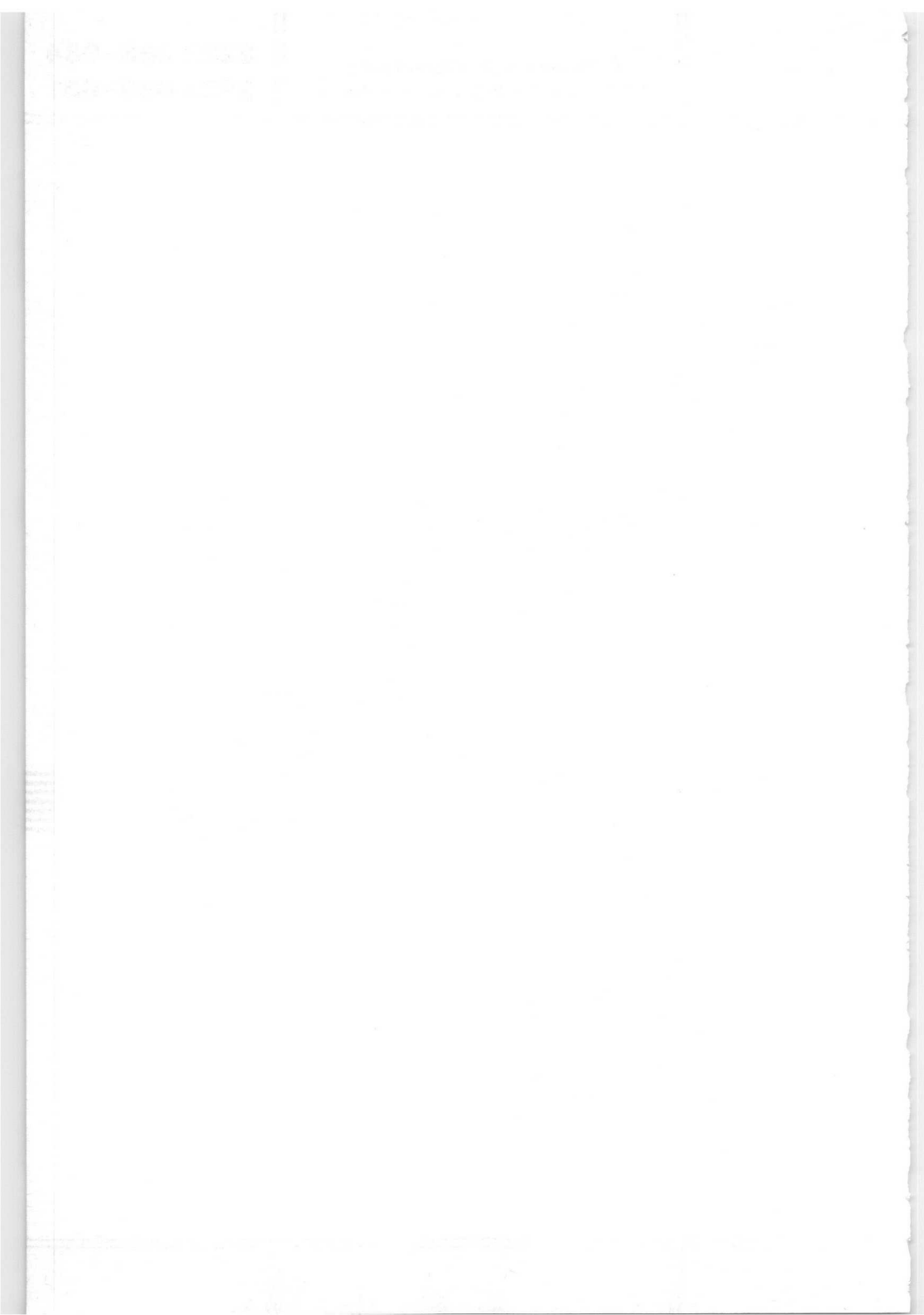

ELECTROLYTIC CAPACITORS multiple types, for high voltages

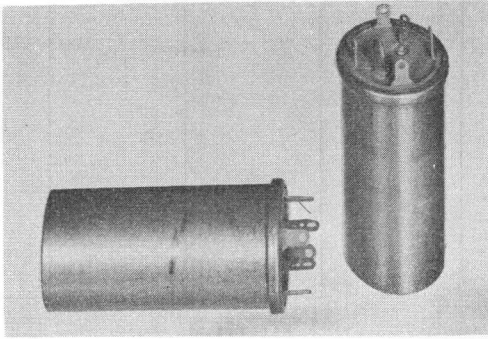

RZ 20603-1

Triple and quadruple capacitors of which one section has a separate cathode connection. ←

They are mainly used as smoothing capacitors in television receivers.

Special attention is drawn to the quadruple types which are ideal for the above application.

2222 067 9....
2222 063 9....

ELECTROLYTIC CAPACITORS
multiple types, for high voltages

Dimensions in mm

See also the
table

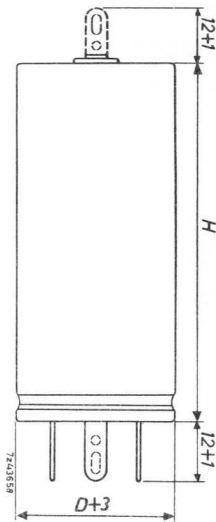

Fig. 1

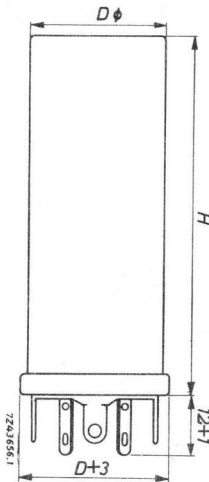

Fig. 2

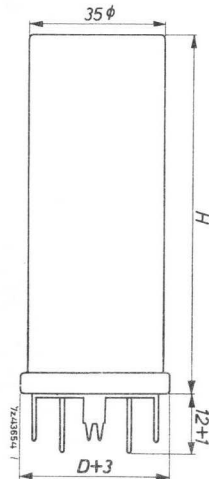

Fig. 3

capacitance (μF)	max. voltage (V)	Fig.	D (mm)	H (mm)	cat. number 2222 followed by
50 + 50 + 50	350	2	35	80	063 90027
100 + 50 + 50	300	2	35	80	063 90022
100 + 100 + 50	300	2	35	80	067 90003
200 + 100 + 50 + 50	300	1	35	80	067 90012
200 + 100 + 50 + 25	300	2	35	80	067 90013
200 + 100 + 50 + 25	300	3	35	80	067 90014

ELECTROLYTIC CAPACITORS

Large long life type (I.E.C. type 1)



A 52327

QUICK REFERENCE DATA

Capacitance range
680 to 47 000 μF , E6 series

Tolerance on capacitance -10/+50%

Rated voltages 6.3 to 63 V

Category (I. E. C. 68) 40/085/56

High ripple current ratings

APPLICATION

Being an improvement on the 2222 060 series, the capacitors are suitable for use in power supplies for transistorized equipment.

Paralleled double capacitors may be preferred over single capacitors because they are shorter.

C (μF)	rated voltage (V)					
	6.3	10	16	25	40	63
680					5	
1000				5	6	
1500					7/8a	
750+750				5	6	8
2200					7/8a	9a
1100+1100				5	6	7/8a
3300					7/8a	9
1650+1650				5	6	7/8a
4700					7/8a	8
2350+2350				6	7/8	8
6800					7/8a	9a
3400+3400				6	7/8a	8
10 000					7/8a	9a
5000+5000				6	7/8	8
15 000					7/8a	8
7500+7500				7/8a	8	9
22 000					7/8a	8
11000+11 000				8	9a	9
33 000					7/8a	8
16 500+16 500				8	9a	9
47 000					7/8a	8
23 500+23 500				9	10	10

can size (mm)	
5	= \emptyset 21 x 49
6	= \emptyset 25 x 49
7	= \emptyset 25 x 80
8a	= \emptyset 30 x 50
8	= \emptyset 30 x 80
9a	= \emptyset 35 x 50
9	= \emptyset 35 x 80
10	= \emptyset 40 x 80

DESCRIPTION

Etched aluminium foil anode and cathode separated by a paper layer which is impregnated with an electrolyte exhibiting an improved resistance/temperature curve. The capacitor core is housed in an aluminium can sealed with a rubber-faced paper laminate disc. The can has longitudinal indents to fix the core and to promote heat transfer.

The can, which has no electrical function, is covered with a blue plastic sleeve.

The negative terminal is identified by the symbol Δ ; it is the common terminal for double capacitors.

MECHANICAL DATA

Dimensions in mm

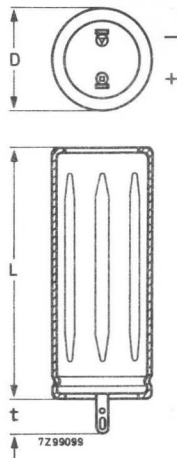

Fig. 1. Single capacitors

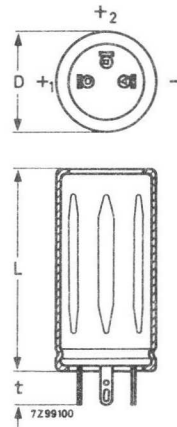

Fig. 2. Double capacitors

Table 1

Fig.	can size	D (mm)	L (mm)	t (mm)
1 (single)	5	21.3 + 0.3	49.3 ± 1	8 + 1
	6	25.3 + 0.3	49.3 ± 1	8 + 1
	7	25.3 + 0.3	80.3 ± 1	12 + 1
	8a	30.3 + 0.3	50.3 ± 1	12 + 1
	8	30.3 + 0.3	80.3 ± 1	12 + 1
2 (double)	9a	35.3 + 0.3	50.3 ± 1	12 + 1
	9	35.3 + 0.3	80.3 ± 1	12 + 1
	10	40.5 + 0.3	80.3 ± 1	12 + 1

Marking

Capacitance, tolerance on capacitance, rated voltage, temperature range, I.E.C. type, max. permissible ripple current, catalogue number and data of manufacture.

Mounting (See also "Mounting Clamps")

The capacitor may be mounted in any position with or without a mounting clamp. Where a number of capacitors are connected to form a capacitor bank, the proximity to one another must not be less than 15 mm.

The uninsulated part of the can may only touch objects with the same potential as the negative terminal.

Soldering conditions

No special soldering conditions apply.

Min. atmospheric pressure 200 mbar (15 cm Hg)

Standard packing

Pack of 100, marked with catalogue number, capacitance and rated voltage.

ELECTRICAL DATA

Unless otherwise specified, all electrical values apply at an ambient temperature of 20 to 25 °C, an air pressure of 930 to 1060 mbar, and a relative humidity of 45 to 75%.

Tolerance on capacitance	-10/+ 50%
Category (I.E.C. 68)	40/085/56
Category temperature range	-40 to + 85 °C ¹⁾
Max. storage temperature	40 °C
Rated voltage = max. (d.c. + peak a.c.) voltage at 40 to 85 °C	see Table 2
Max. (d.c. + peak a.c.) voltage at ≤ 40 °C	1.1 x rated voltage
Max. voltage for 1 min per h, at 40 to 85 °C	1.125 x rated voltage + 0.5 V
at ≤ 40 °C	1.25 x rated voltage + 0.5 V
Leakage current under continuous operation at V_R , $T_{amb} = 25 °C$ $T_{amb} = 85 °C$	approx. 1/5 of value stated in Table 2. ≤ value stated in Table 2.
Charge and discharge currents	see Additional information

¹⁾ The lower category temperature is determined with a view to the increase of the impedance only, see the impedance graphs.

2222 071-
2222 073

ELECTROLYTIC CAPACITORS
Large long life type (I. E. C. type 1)

Table 2

can size	rated voltage (V)	capacitance (μF)	max. ripple current (A) ¹⁾			leakage current ²⁾ (μA) max.	tan δ at 100 Hz ³⁾ max.	impedance at 100 kHz ³⁾ (mΩ) max.	catal. No. 2222 followed by
			50 °C	70 °C	85 °C				
6	6.3	10 000	4.0	3.1	1.8	380	0.50	60	071 13103
7		15 000	6.1	4.8	2.7	570	0.50	50	071 13153
8a		15 000	5.5	4.3	2.5	570	0.50	50	073 13153
8		22 000	8.3	6.4	3.7	835	0.50	50	071 13223
9a		11 000+11 000	7.5	5.8	3.3	420+420	0.50	60+60	072 13113
9		16 500+16 500	11	8.5	4.9	625+625	0.50	50+50	072 13173
10		23 500+23 500	14.2	11	6.3	890+890	0.50	50+50	072 13243
5	10	4 700	2.5	1.9	1.1	280	0.35	80	071 14472
6		6 800	4.0	3.1	1.8	410	0.35	60	071 14682
7		10 000	6.0	4.6	2.7	600	0.35	50	071 14103
8a		10 000	5.4	4.2	2.4	600	0.35	50	073 14103
8		15 000	8.2	6.3	3.7	900	0.35	50	071 14153
9a		7 500+7 500	7.3	5.7	3.3	450+450	0.35	60+60	072 14752
9		11 000+11 000	10.6	8.3	4.8	660+660	0.35	50+50	072 14113
10	16 500+16 500	13.4	10.4	6.0	990+990	0.35	50+50	072 14173	
5	16	3 300	2.4	1.9	1.1	320	0.25	80	071 15332
6		4 700	3.9	3.0	1.7	450	0.25	60	071 15472
7		6 800	5.8	4.5	2.6	655	0.25	50	071 15682
8a		6 800	5.3	4.1	2.4	655	0.25	50	073 15682
8		10 000	7.9	6.1	3.5	960	0.25	50	071 15103
9a		5 000+5 000	7.1	5.5	3.2	480+480	0.25	60+60	072 15502
9		7 500+7 500	10.5	7.6	4.7	720+720	0.25	50+50	072 15752
10	11 000+11 000	13.8	10.6	6.1	1 060+1 060	0.25	50+50	072 15113	
5	25	2 200	2.2	1.7	1.0	330	0.20	80	071 16222
6		3 300	3.7	2.8	1.7	495	0.20	60	071 16332
7		4 700	5.4	4.2	2.4	705	0.20	50	071 16472
8a		4 700	4.9	3.8	2.2	705	0.20	50	073 16472
8		6 800	7.3	5.6	3.3	1 020	0.20	50	071 16682
9a		3 400+3 400	6.5	5.1	2.9	510+510	0.20	60+60	072 16342
9		5 000+5 000	9.6	7.4	4.3	750+750	0.20	50+50	072 16502
10	7 500+7 500	12.6	9.8	5.7	1 125+1 125	0.20	50+50	072 16752	
5	40	1 000	2.1	1.6	1.0	240	0.15	125	071 17102
6		2 200	2.9	2.2	1.3	530	0.15	100	071 17222
7		3 300	5.2	4.1	2.4	795	0.15	80	071 17332
8a		3 300	3.8	3.0	1.7	795	0.15	80	073 17332
8		4 700	7.0	5.4	3.1	1 130	0.15	80	071 17472
9a		2 350+2 350	5.3	4.0	2.4	560+560	0.15	100+100	072 17242
9		3 400+3 400	9.1	7.1	4.1	820+820	0.15	80+80	072 17342
10	5 000+5 000	12.0	8.7	5.3	1 200+1 200	0.15	80+80	072 17502	
5	63	680	2.1	1.4	0.8	260	0.10	125	071 18681
6		1 000	2.9	2.2	1.3	380	0.10	100	071 18102
7		1 500	4.3	3.4	2.0	570	0.10	80	071 18152
8a		1 500	3.8	3.0	1.7	570	0.10	80	073 18152
8		2 200	5.8	4.5	2.6	835	0.10	80	071 18222
9a		1 100+1 100	5.3	4.0	2.4	415+415	0.10	100+100	072 18112
9		1 650+1 650	7.8	6.0	3.5	625+625	0.10	80+80	072 18172
10	2 350+2 350	10	7.8	4.5	890+890	0.10	80+80	072 18242	

1) 2) 3) See next page.

ADDITIONAL INFORMATION

Charge and discharge current

The capacitors may be charged from a source without internal resistance and they may be discharged by a short-circuit.

If the capacitors are charged and discharged continuously at a rate of several times per minute, the charge and discharge currents have to be considered as ripple currents flowing through the capacitor. The r.m.s. value of these currents should be determined and the value thus found must not exceed the limit specified in Table 2.

Re-formation

After storage the capacitors may need re-formation at the working voltage for some hours, to meet the specified leakage current requirements.

Impedance graphs

The impedance/temperature curves represent typical values.

¹) Max. permissible r.m.s. values of ripple current, of any frequency and with the rated voltage applied, for single capacitors and for paralleled double capacitors. When both sections of a double capacitor carry ripple current, $\frac{1}{2}$ x stated limit applies to each section; when only one section carries ripple current, $\frac{1}{2} \sqrt{2}$ x stated limit applies (70%). ←

²) Leakage current 5 min after application of the rated voltage.

³) Measured using a 4-pole circuit (Thompson bridge), which eliminates the resistance and the self-inductance of the test cables.

TESTS AND REQUIREMENTS TO I.E.C. 68

I.E.C. 103 ¹⁾ clause	Tests	Conditions (quick reference)	Requirements
23	Surge	5000 cycles, each consisting of a 10 s charge and 50 s no load	Leakage current and $\tan \delta \leq$ stated limit; $\Delta C \leq 10\%$
22	Endurance	2000 h at 85 °C with 85% rated voltage and 5% ripple applied	Leakage current \leq stated limit; $\tan \delta \leq 1.3 \times$ stated limit; $\Delta C \leq 15\%$
21.1	Storage, high temperature	96 \pm 4 h at +85 °C with no voltage applied	Leakage current $\leq 2 \times$ stated limit; $\tan \delta \leq 1.2 \times$ stated limit; $\Delta C \leq 10\%$
21.2	Storage, low temperature	72 h at -55 °C with no voltage applied	Leakage current \leq stated limit; $\tan \delta \leq$ stated limit; $\Delta C \leq 10\%$
20	Damp heat long term	56 days at 40 °C and R.H. 90-95% with no voltage applied	No visual damage
19.2	Dry heat	16 h at 85 \pm 2 °C with rated voltage applied	Leakage current at 85 °C $< 5 \times$ stated limit; no damage, no leakage
19.3	Accelerated damp heat	24 h at 55 \pm 2 °C with no voltage applied	Immediately followed by cold test
19.4	Cold	2 h at -40 \pm 3 °C with no voltage applied	Ratio of impedance found at -40 °C to that found at +20 °C to be: < 5 for 6.3 V ratings; < 4 for 6.3-16 V ratings; < 3 for ≥ 25 V ratings; $\Delta C \leq 5\%$ No damage
19.5	Seal	1 min in water at 90 °C	No leakage
19.6	Accelerated damp heat	5 cycles of 24 h at 55 \pm 2 °C and R.H. 90-100% with no voltage applied	Leakage current and $\tan \delta \leq$ stated limit; $\Delta C \leq 10\%$
17	Shock Vibration	40 g, 2 directions, 2000 shocks per direction. 10-500-10 Hz, 1 octave per min; max. 10g, 2 directions, 3 h per direction	No visual damage, no leakage $\Delta C \leq 5\%$
16	Change of temperature	1 cycle of 3 h at +85 °C with no voltage applied and 3 h at -40 °C	No damage
15	Solderability		Proper solder coating and no damage
14.1	Pull	destructive	≥ 40 N (4 kgf)
13.7	Dielectric strength of insulation	Metal foil wrapped around body. 1000 V _{DC} for 1 min \pm 5 s, voltage rise 100 V/s	No breakdown

¹⁾ Second edition (1969)

ELECTROLYTIC CAPACITORS
Large long life type (I.E.C. type 1)

2222 071-
2222 073

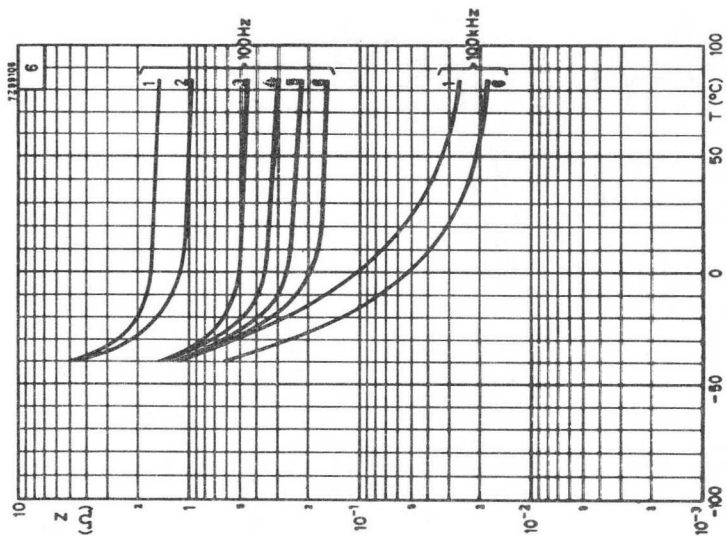

Can 6
Curve 1 = $1\,000\ \mu\text{F}$, 63 V
Curve 2 = $2\,200\ \mu\text{F}$, 40 V
Curve 3 = $3\,300\ \mu\text{F}$, 25 V
Curve 4 = $4\,700\ \mu\text{F}$, 16 V
Curve 5 = $6\,800\ \mu\text{F}$, 10 V
Curve 6 = $10\,000\ \mu\text{F}$, 6.3 V

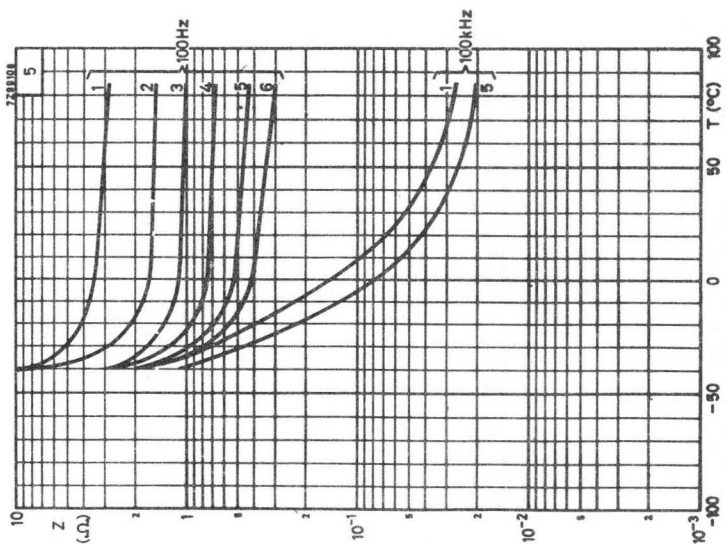

Can 5
Curve 1 = $680\ \mu\text{F}$, 63 V
Curve 2 = $1\,000\ \mu\text{F}$, 40 V
Curve 3 = $2\,200\ \mu\text{F}$, 25 V
Curve 4 = $3\,300\ \mu\text{F}$, 16 V
Curve 5 = $4\,700\ \mu\text{F}$, 10 V

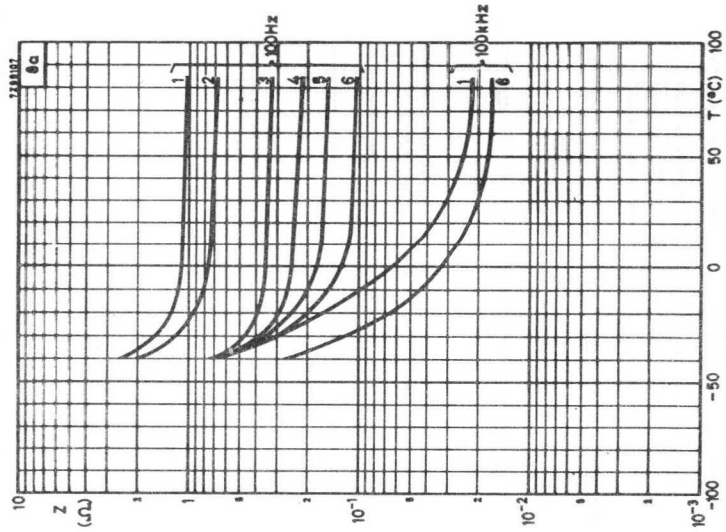

Can 8a

- Curve 1 = 1500 μF , 63 V
 2 = 3300 μF , 40 V
 3 = 4700 μF , 25 V
 4 = 6800 μF , 16 V
 5 = 10000 μF , 10 V
 6 = 15000 μF , 6.3 V

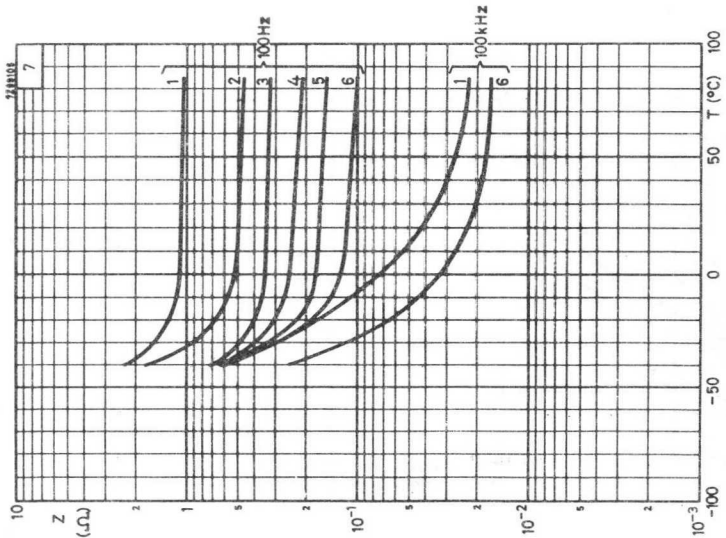

Can 7

- Curve 1 = 1500 μF , 63 V
 2 = 3300 μF , 40 V
 3 = 4700 μF , 25 V
 4 = 6800 μF , 16 V
 5 = 10000 μF , 10 V
 6 = 15000 μF , 6.3 V

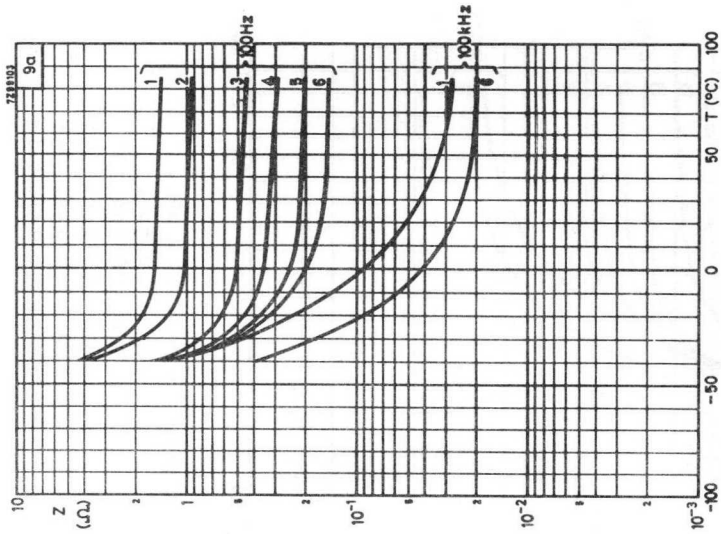

Can 9a

- Curve 1 = 1 100 + 1 100 μ F, 63 V
 2 = 2 350 + 2 350 μ F, 40 V
 3 = 3 400 + 3 400 μ F, 25 V
 4 = 5 000 + 5 000 μ F, 16 V
 5 = 7 500 + 7 500 μ F, 10 V
 6 = 11 000 + 11 000 μ F, 6.3 V

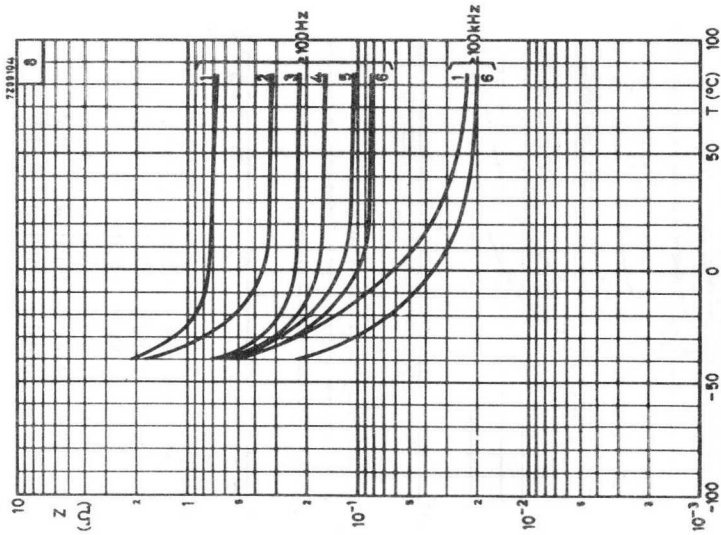

Can 8

- Curve 1 = 2 200 μ F, 63 V
 2 = 4 700 μ F, 40 V
 3 = 6 800 μ F, 25 V
 4 = 10 000 μ F, 16 V
 5 = 15 000 μ F, 10 V
 6 = 22 000 μ F, 6.3 V

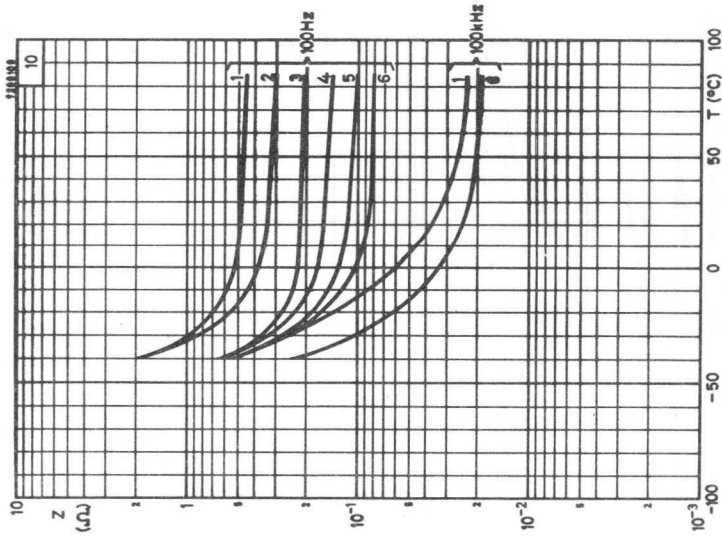

Can 10

- Curve 1 = 2 350 + 2 350 μ F, 63 V
 2 = 5 000 + 5 000 μ F, 40 V
 3 = 7 500 + 7 500 μ F, 25 V
 4 = 11 000 + 11 000 μ F, 16 V
 5 = 16 500 + 16 500 μ F, 10 V
 6 = 23 500 + 23 500 μ F, 6.3 V

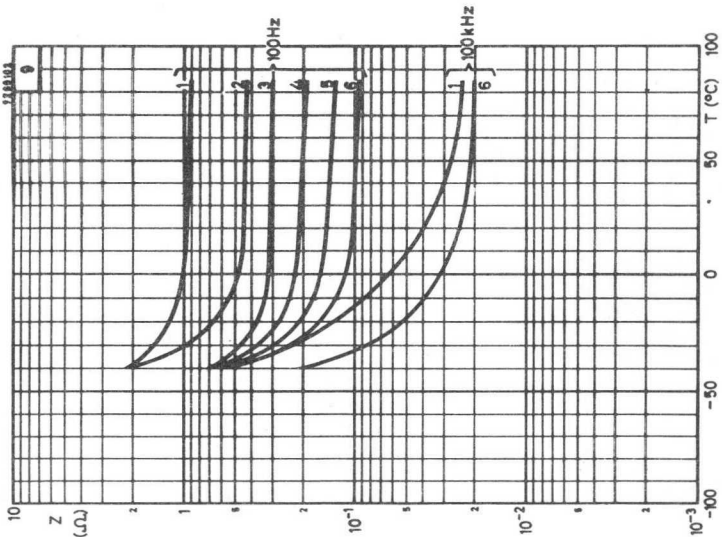

Can 9

- Curve 1 = 1 650 + 1 650 μ F, 63 V
 2 = 3 400 + 3 400 μ F, 40 V
 3 = 5 000 + 5 000 μ F, 25 V
 4 = 7 500 + 7 500 μ F, 16 V
 5 = 11 000 + 11 000 μ F, 10 V
 6 = 16 500 + 16 500 μ F, 6.3 V

Mounting clamps 4322 043 03290 to 03330

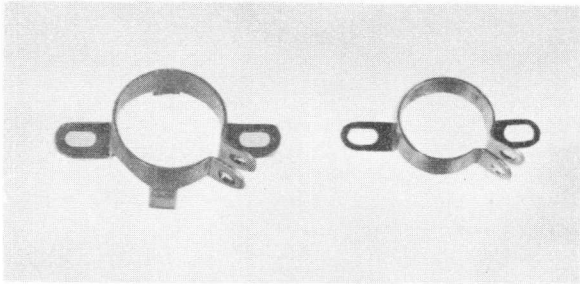

To facilitate vertical mounting, a series of rigid clamps made of cadmium plated steel are available. They can easily be slid over the capacitor and then fixed to it with a nut and bolt. They are provided with two mounting lugs and, except the smallest version, with two supports to give stability in the cross direction. Four types are available, one for each can diameter of the capacitor range. They are delivered without nuts or bolts.

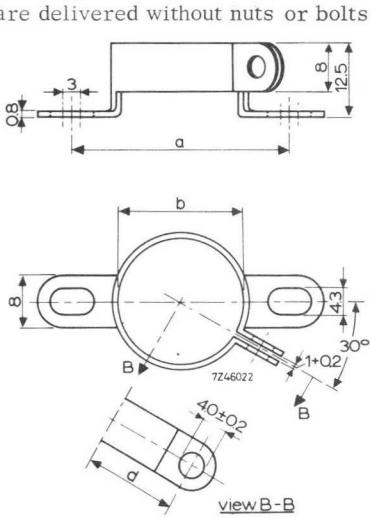

For can size 5

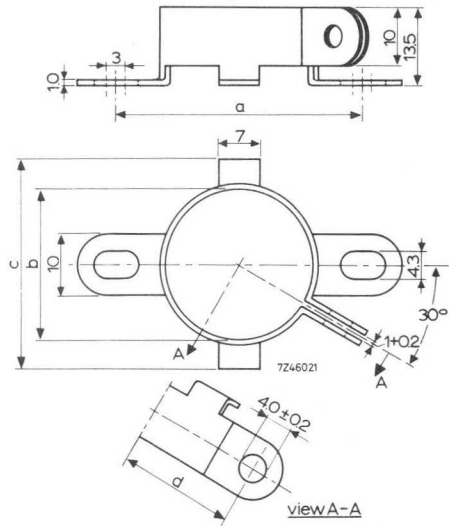

For can sizes 6 to 9

can size	dimensions in mm				catalog number
	a	b	c	d	
5	37.0 ± 0.2	21	-	15.5	4322 043 03290
6, 7	41.5 ± 0.2	25	35	18.5	03300
8	46.5 ± 0.2	30	40	21	03310
9	51.5 ± 0.2	35	45	23.5	03320
10	56.5 ± 0.2	40	50	26	03330

1870
1871

1872
1873

1874
1875

1876
1877

1878
1879

1880

1881

1882

1883

1884

ELECTROLYTIC CAPACITORS

small long life type

RZ 13317-1

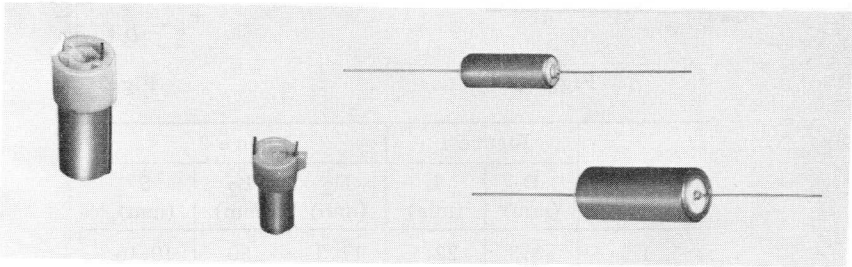

This range of electrolytic capacitors has been specially developed for industrial apparatus where long service life and high reliability are essential, e.g. computers, telecommunication and telephone equipment.

High grade materials, an extra reserve of electrolyte and close quality control during manufacture ensure that these capacitors have a life expectancy far superior to normal grade electrolytic capacitors.

The cans of the capacitors are completely cold-welded.

This range supersedes the C427 series

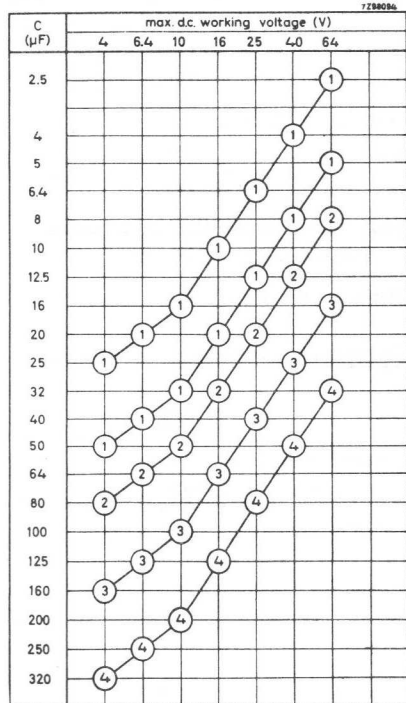

Dimensions in mm

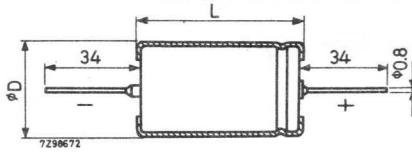

Fig.1

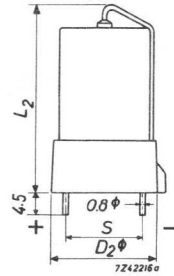

Fig.2

can size	Figure 1		Figure 2		
	D (mm)	L (mm)	D ₂ (mm)	L ₂ (mm)	S (mm)
1	8.3	22.5	11.3	30	10.16
2	10.5	22.5	12.9	31	10.16
3	10.5	30.5	12.9	39	10.16
4	13	30.5	15.3	39	10.16

Tolerance on capacitance

-10/+50 %

Temperature range

-40/+70 °C

Peak voltage: for several hours
for several days

1.2 x working voltage
1.1 x working voltage

Maximum permissible alternating
voltage at 50 and 100 Hz

1.5 V_{rms}

Climatic robustness

category 40/070/56 (IEC 68)

Composition of the catalog number

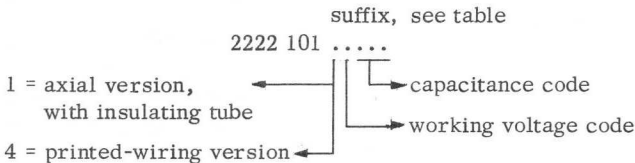

can size	working voltage (V)	capacitance (μF)	leakage current ¹⁾ (μA)	ripple current (mA) ²⁾		tan δ ³⁾	impedance ⁴⁾ (Ω)	catalog number suffix ⁵⁾
				50 °C	70 °C			
1	4	25	6	60	20	0.20	6	12259
1		50	7	75	40	0.30	6	12509
2		80	8	120	55	0.30	4	12809
3		160	11.5	195	90	0.30	2	12161
4		320	18	315	145	0.30	1	12321
1	6.4	20	6.5	60	25	0.20	6	13209
1		40	7.5	75	40	0.25	6	13409
2		64	9	120	55	0.25	4	13649
3		125	13	195	90	0.25	2	13131
4		250	21	315	145	0.25	1	13251
1	10	16	6.5	60	25	0.15	6	14169
1		32	8	75	40	0.20	6	14329
2		50	10	120	55	0.20	4	14509
3		100	15	195	90	0.20	2	14101
4		200	25	315	145	0.20	1	14201
1	16	10	6.5	60	25	0.15	6	15109
1		20	8	75	40	0.15	6	15209
2		32	10	120	55	0.15	4	15329
3		64	15.5	195	90	0.15	2	15649
4		125	25	315	145	0.15	1	15131
1	25	6.4	6.5	60	25	0.10	6	16648
1		12.5	8	75	40	0.10	6	16139
2		20	10	120	55	0.10	4	16209
3		40	15	195	90	0.10	2	16409
4		80	25	315	145	0.10	1	16809
1	40	4	6.5	40	15	0.10	6	17408
1		8	8	55	25	0.10	6	17808
2		12.5	10	80	35	0.10	4	17139
3		25	15	125	55	0.10	2	17259
4		50	25	210	90	0.10	1	17509
1	64	2.5	6.5	40	15	0.10	6	18258
1		5	8	55	25	0.10	6	18508
2		8	10	80	35	0.10	4	18808
3		16	15.5	125	55	0.10	2	18169
4		32	25.5	210	90	0.10	1	18329

1) Maximum leakage current at 20 °C after 5 minutes

2) Maximum permissible ripple current at 100 Hz and 70 °C

3) Maximum dissipation factor at 20 °C and 100 Hz

4) Maximum impedance at 20 °C and 100 kHz.

5) For axial version.

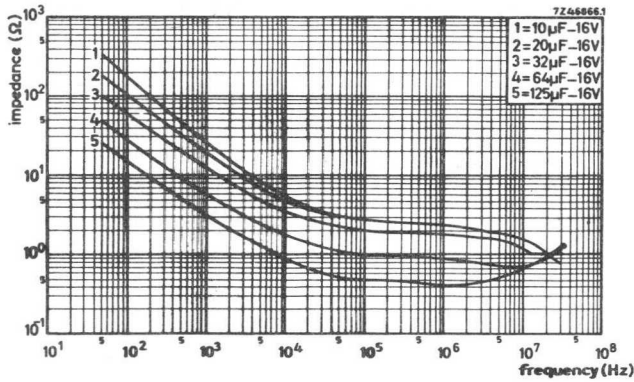

Typical curves of impedance, measured at 20 °C, against frequency.

Impedance graphs

Typical impedance/temperature curves for the different can sizes are given below. The maximum values at 20 °C and 100 kHz are stated in the table.

Can size 1

Can size 1

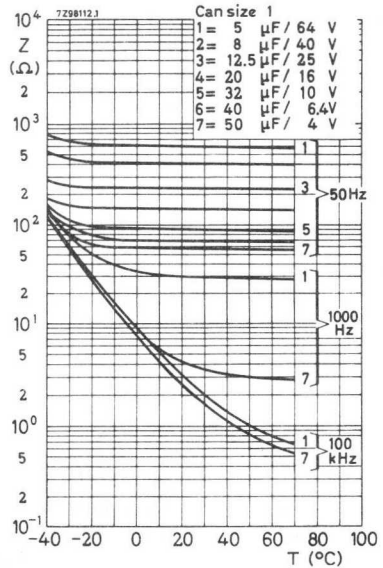
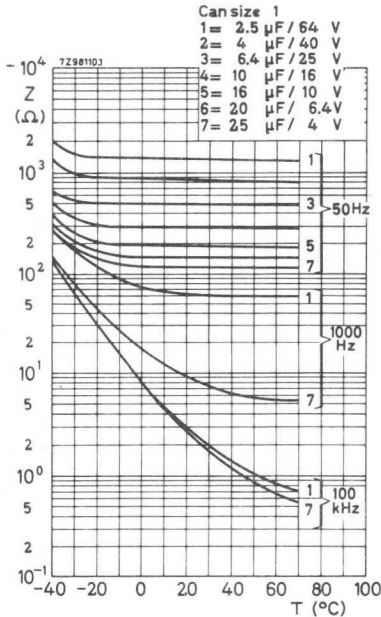

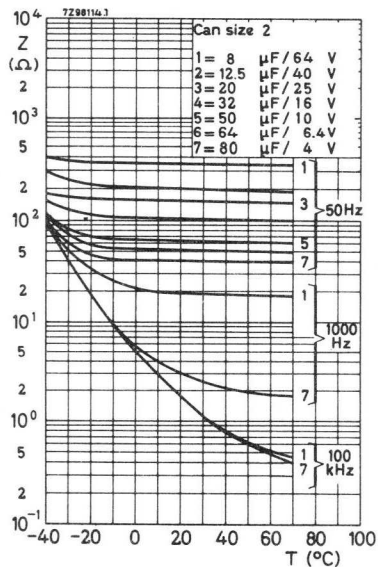

Can size 2

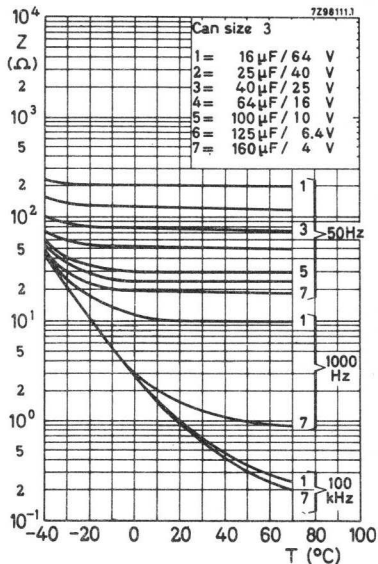

Can size 3

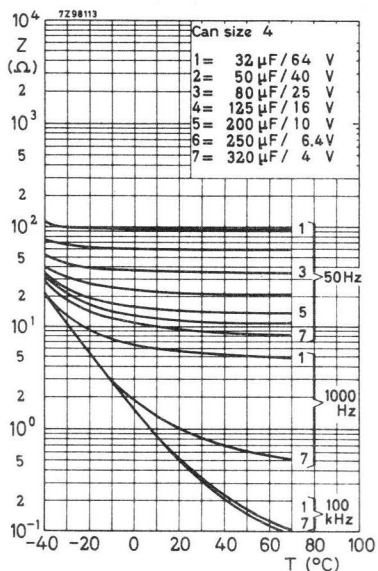

Can size 4

101 2222

RECEIVED

1912

ELECTROLYTIC CAPACITORS

large long life type

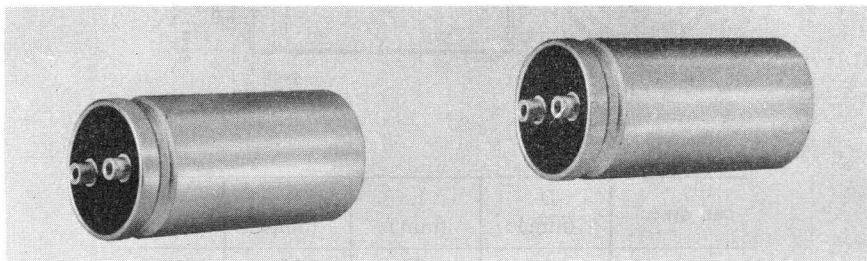

RZ 15738-8A

These high-capacitance, low-voltage capacitors, having a high quality, a long service life and an extreme reliability, are suitable for use as filter and energy-storage capacitors for the power supplies of professional equipment, as for instance computers. The cans are provided with an insulating sleeve.

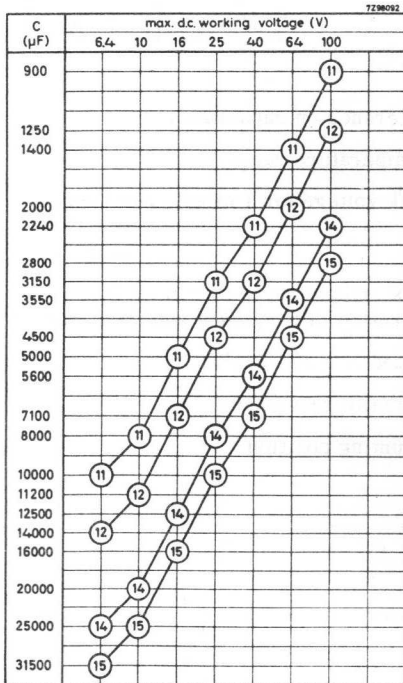

2222 102
2222 103

ELECTROLYTIC CAPACITORS
 Large long life type

(C432)

Dimensions in mm

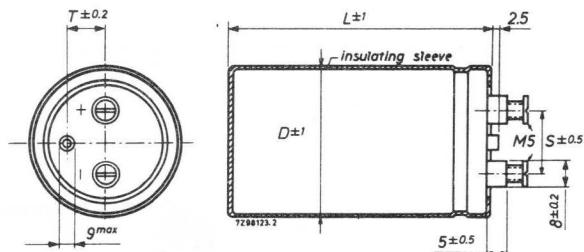

can size	D (mm)	L (mm)	S (mm)	T (mm)
11	36.5	88	15	9.3
12	36.5	108	15	9.3
14	51.5	88	22	14.3
15	51.5	108	22	14.3

Tolerance on capacitance

-10/+50%

Temperature range

-40/+70 °C

Peak voltage for 1 minute per hour:

at 70 °C

1.15 x working voltage

at ≤ 40 °C

1.25 x working voltage

Max. ripple current (r.m.s.) as a function of frequency and temperature

$$\sqrt{\frac{\text{max. dissipation}}{\text{series resistance}}}$$

Impedance at 100 kHz

max. 0.1 Ω, average 0.05 Ω

Climatic robustness

category 40/070/56 (IEC68)

Mounting position

not with terminals down

can size	working voltage (V)	capacitance (μF)	leakage current ¹⁾ (mA)	ripple current ²⁾ (A)	dissipation factor ³⁾	cat. number 2222 followed by
11	6.4	10 000	1.9	2.1	0.45	102 13103
12		14 000	2.7	2.8	0.45	143
14		25 000	4.8	3.2	0.45	253
15		31 500	6.1	4.9	0.45	323
11		10	8 000	2.4	2.1	0.35
12	11 200		3.4	2.8	0.35	113
14	20 000		6.0	3.2	0.35	203
15	25 000		7.5	4.9	0.35	253
11	16		5 000	2.4	2.1	0.25
12		7 100	3.4	2.8	0.25	712
14		12 500	6.0	3.2	0.25	133
15		16 000	7.7	4.9	0.25	163
11		25	3 150	2.4	2.1	0.15
12	4 500		3.4	2.8	0.15	452
14	8 000		6.0	3.2	0.15	802
15	10 000		7.5	4.9	0.15	103
11	40		2 240	2.7	2.1	0.10
12		3 150	3.8	2.8	0.10	322
14		5 600	6.7	3.2	0.10	562
15		7 100	8.4	4.9	0.10	712
11		64	1 400	2.7	1.1	0.10
12	2 000		3.8	1.5	0.10	202
14	3 550		6.7	2.2	0.10	362
15	4 500		8.4	2.6	0.10	452
11	100		900	2.7	1.1	0.10
12		1 250	3.8	1.5	0.10	132
14		2 240	6.7	2.2	0.10	222
15		2 800	8.4	2.6	0.10	282

1) Maximum leakage current at 20 °C after 5 minutes.

2) Maximum permissible ripple current at 50 Hz, first value for 70 °C.

3) Maximum dissipation factor ($\tan \delta$) at 20 °C and 50 Hz; average values are approximately 50% lower.

1933

1933

1933

1933

1933

1933

1933

ELECTROLYTIC CAPACITORS large long life type (I.E.C. type 1)

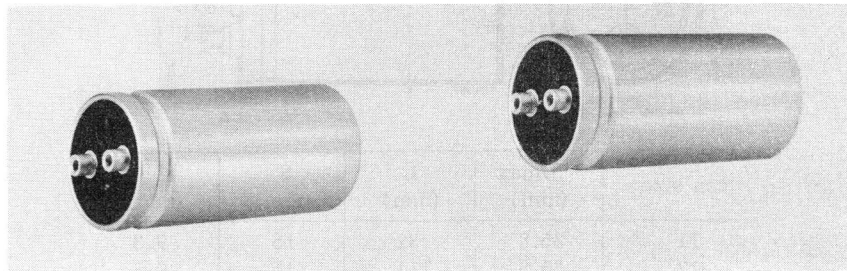

RZ 15738-8A

Applicable specification	I.E.C. 40 (C.O. 176), Type 1, style B4; C.C.T.U. 02-10
Climatic category	40/085/56 (I.E.C. 68)
Capacitance range	1500 to 150 000 μ F
Rated voltages	6.3 to 100 V _{dc}

APPLICATION

Because of their high reliability and long service life these capacitors are recommended not only for industrial but also for military applications. Their extremely low impedance and inductance values render them very suitable for applications such as:

- power supplies in digital equipment,
- energy storage in pulse systems,
- filters in measuring and control apparatus.

DESCRIPTION

The low values of impedance and inductance are achieved by a special construction with several internal anode and cathode connections.

The capacitors are completely cold-welded and charge/discharge proof.

By the introduction of aluminium foil with the highest etching factor and new electrolytes, very high CV-products are obtained combined with outstanding electrical characteristics.

The aluminium cans are fully insulated and sealed by a synthetic resin disc with a vent. In the case of overpressure the vent releases this pressure and closes again; the proper operation of the capacitor remains guaranteed.

The capacitors are delivered with two screws and two washers.

MECHANICAL DATA (See also "Mounting clamps" further on)

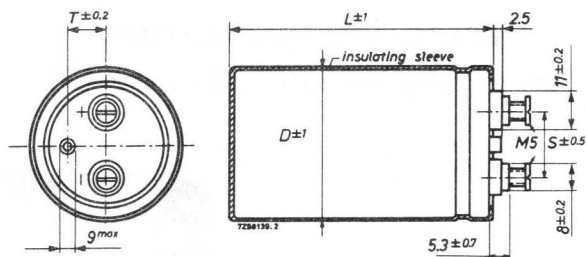

can size	Dmax ¹ (mm)	L (mm)	S (mm)	T (mm)
11	35.8	82	15	9.3
12	35.8	114	15	9.3
14	50.8	82	22	14.3
15	50.8	114	22	14.3
16	65.8	114	31	19.0

ELECTRICAL DATA

Unless otherwise specified, all electrical values apply at an ambient temperature of 20 to 25 °C, an air pressure of 930 to 1060 mbar, and a R.H. of 45 to 75%.

Tolerance on capacitance	-10/+50%
Category (I. E. C. 68)	40/085/56
Category temperature range ¹⁾	
6.3 to 63 V types	-40 to +85 °C
100 V types	-25 to +85 °C
Max. storage temperature	40 °C
Rated voltage = max. (d. c. + peak a. c.) voltage at 40 to 85 °C	see table
Max. (d. c. + peak a. c.) voltage at ≤ 40 °C	1.1 x rated voltage
Max. voltage for 1 min per h, at 40 to 85 °C	1.125 x rated voltage + 0.5 V
at ≤ 40 °C	1.25 x rated voltage + 0.5 V
Leakage current under continuous operation at the rated voltage	approx. 1/5 of value stated in table
T _{amb} = 25 °C	
T _{amb} = 85 °C	≤ value stated in table

¹⁾ The lower category temperature is determined with a view to the increase of the impedance only, see the impedance graphs.

ELECTROLYTIC CAPACITORS
Large long life type (I. E. C. type 1)

2222 106
2222 107

can size	rated voltage (V)	capacitance (μ F)	leakage current ¹⁾ (mA)	ripple current (A) ²⁾			tan δ at 100 Hz max.	impedance ³⁾ (Ω)	cat. number 2222 followed by
				50°C	70°C	85°C			
11	6.3	22 000	0.9	7	6.3	3.1	0.45	0.04	106 13223
12		33 000	1.3	10	9	4.5	0.55	0.04	106 13333
14		47 000	1.8	12	11	5.4	0.6	0.04	106 13473
15		68 000	2.6	17	15	7.7	0.7	0.04	106 13683
16		150 000	5.7	28	25	12.6	1.0	0.04	106 13154
11		10	15 000	0.9	7	6.3	3.1	0.3	0.04
12	22 000		1.4	10	9	4.5	0.35	0.04	106 14223
14	33 000		2.0	12	11	5.4	0.4	0.04	106 14333
15	47 000		2.9	17	15	7.7	0.45	0.04	106 14473
16	100 000		6.0	28	25	12.6	0.7	0.04	106 14104
11	16		10 000	1.0	7	6.3	3.1	0.2	0.04
12		15 000	1.5	10	9	4.5	0.25	0.04	106 15153
14		22 000	2.2	12	11	5.4	0.25	0.04	106 15223
15		33 000	3.2	17	15	7.7	0.30	0.04	106 15333
16		68 000	6.6	28	25	12.6	0.45	0.04	106 15683
11		25	6 800	1.1	7	6.3	3.1	0.15	0.04
12	10 000		1.5	10	9	4.5	0.16	0.04	106 16103
14	15 000		2.3	12	11	5.4	0.19	0.04	106 16153
15	22 000		3.3	17	15	7.7	0.20	0.04	106 16223
16	47 000		7.1	28	25	12.6	0.32	0.04	106 16473
11	40		4 700	1.2	7	6.3	3.1	0.1	0.04
12		6 800	1.7	10	9	4.5	0.11	0.04	106 17682
14		10 000	2.4	12	11	5.4	0.12	0.04	106 17103
15		15 000	3.6	17	15	7.7	0.14	0.04	106 17153
16		33 000	8.0	28	25	12.6	0.2	0.04	106 17333
11		63	2 200	0.9	7	6.3	3.1	0.05	0.04
12	3 300		1.3	10	9	4.5	0.055	0.04	106 18332
14	4 700		1.8	12	11	5.4	0.055	0.04	106 18472
15	6 800		2.6	17	15	7.7	0.06	0.04	106 18682
16	15 000		5.7	28	25	12.6	0.1	0.04	106 18153
11	100		1 500	0.9	7	6.3	3.1	0.4	0.2
12		2 200	1.4	10	9	4.5	0.4	0.2	107 10222
14		3 300	2.0	12	11	5.4	0.4	0.1	107 10332
15		4 700	2.9	17	15	7.7	0.4	0.1	107 10472
16		10 000	6.0	28	25	12.6	0.4	0.08	107 10103

1) Maximum leakage current 5 min after application of the rated voltage.

2) Maximum permissible ripple current at 100 Hz.

3) Maximum impedance at 100 kHz.

Impedance graphs

The impedance/temperature curves represent typical values.

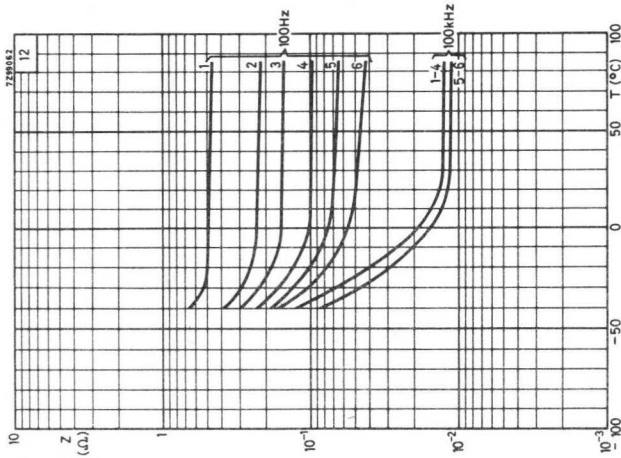

Can 12:

- Curve 1 = 3 300 μ F, 63 V
- 2 = 6 800 μ F, 40 V
- 3 = 10 000 μ F, 25 V
- 4 = 15 000 μ F, 16 V
- 5 = 22 000 μ F, 10 V
- 6 = 33 000 μ F, 6.3 V

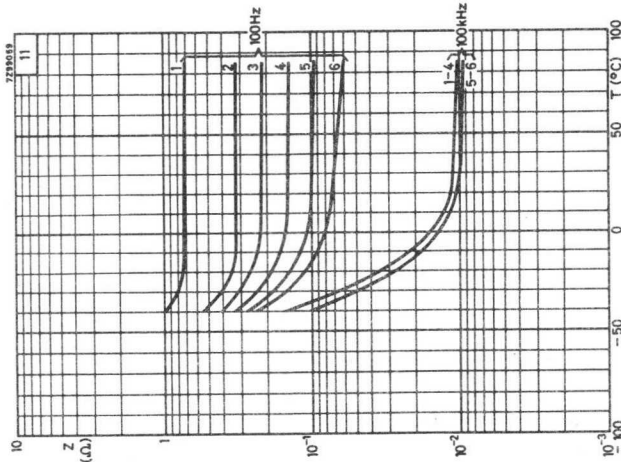

Can 11:

- Curve 1 = 2 200 μ F, 63 V
- 2 = 4 700 μ F, 40 V
- 3 = 6 800 μ F, 25 V
- 4 = 10 000 μ F, 16 V
- 5 = 15 000 μ F, 10 V
- 6 = 22 000 μ F, 6.3 V

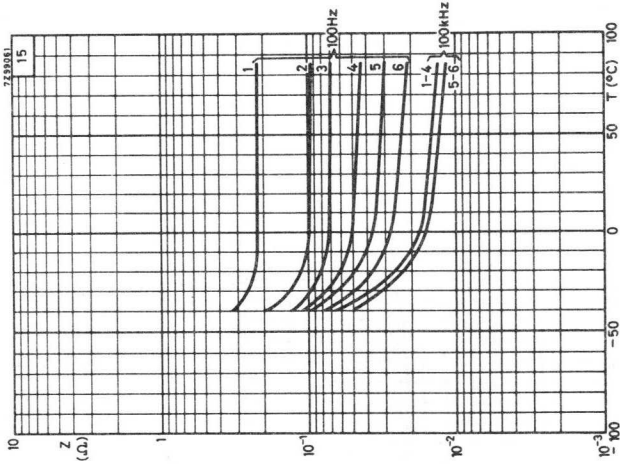

Can 15:

- Curve 1 = 6 800 μ F, 63 V
- 2 = 15 000 μ F, 40 V
- 3 = 22 000 μ F, 25 V
- 4 = 33 000 μ F, 16 V
- 5 = 47 000 μ F, 10 V
- 6 = 68 000 μ F, 6.3 V

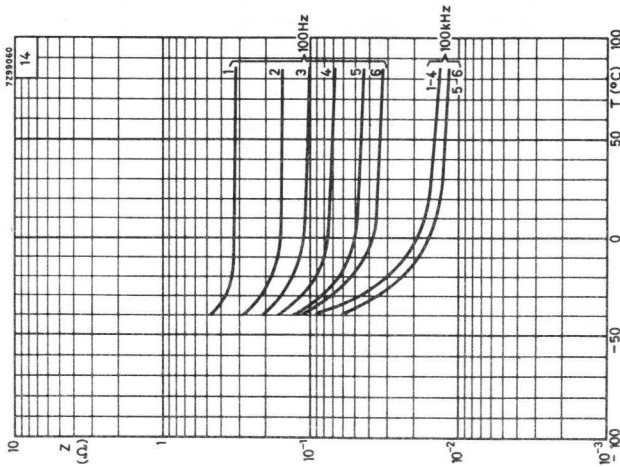

Can 14:

- Curve 1 = 4 700 μ F, 63 V
- 2 = 10 000 μ F, 40 V
- 3 = 15 000 μ F, 25 V
- 4 = 22 000 μ F, 16 V
- 5 = 39 000 μ F, 10 V
- 6 = 47 000 μ F, 6.3 V

2222 106
2222 107

ELECTROLYTIC CAPACITORS
Large long life type (I. E. C. type 1)

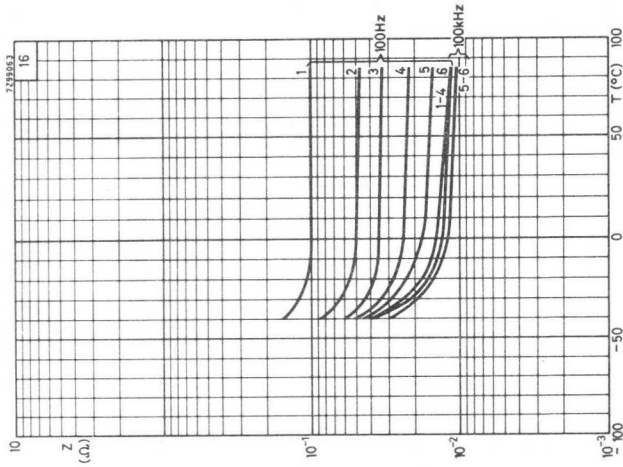

Chan 16:

- Curve 1 = 15000 μF , 63 V
2 = 33000 μF , 40 V
3 = 47000 μF , 25 V
4 = 68000 μF , 16 V
5 = 100000 μF , 10 V
6 = 150000 μF , 6.3 V

Mounting clamps 4322 043 04270 to 04290

Material: cadmium plated steel, passivated

Mounting clamp 4322 043 04270
for cans with 35 mm diameter

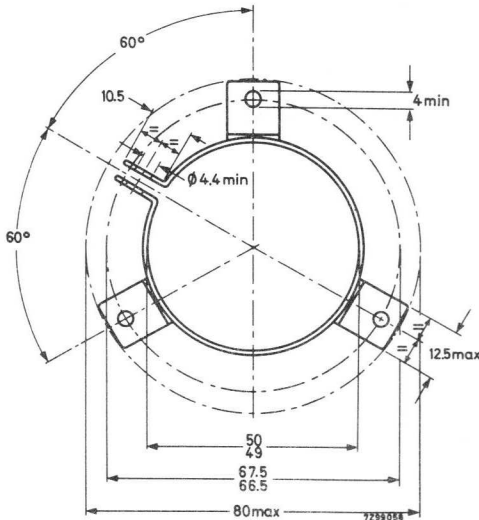
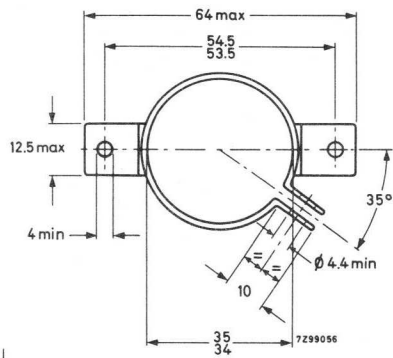
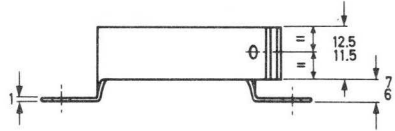
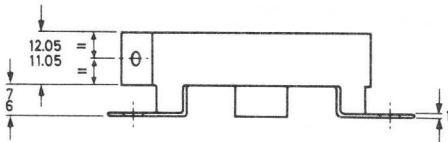

Mounting clamp
4322 043 04280
for cans with 50 mm
diameter

ELECTROLYTIC CAPACITORS

small solid aluminium type

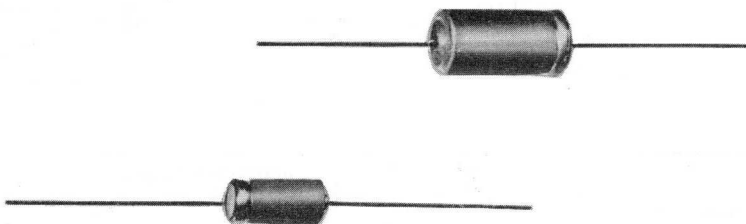

RZ 16462-3

These capacitors are an extension of the preceding 120-series in two ways: by the application of ultra highly etched foils and by the addition of two larger can sizes. They have a symmetrical tolerance on the capacitance of $\pm 20\%$.

Because of their high stability, low-temperature characteristics and reliability they can be used in professional equipment.

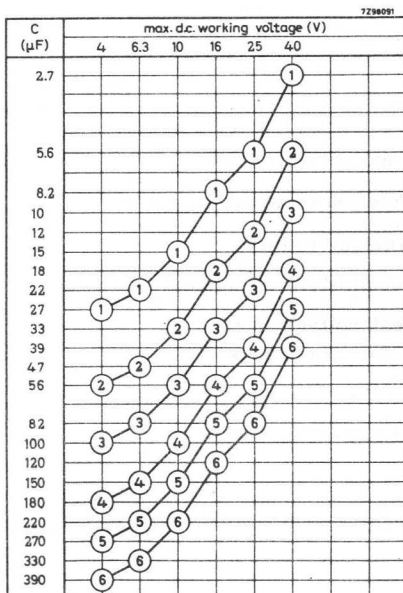

→ Dimensions in mm

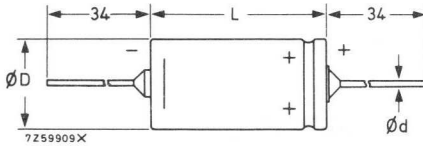

d = 0.8

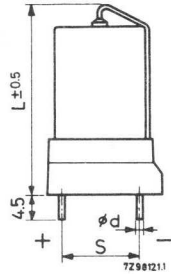

can size	axial version *		printed-wiring version	
	D (mm)	L _{max} (mm)	S (mm)	L (mm)
1	6.6	17.5	7.62	24.5
2	6.6	24	7.62	30.5
3	8.3	24	7.62	30.5
4	10.4	24	10.16	30.5
5	10.4	32	10.16	39.3
6	12.9	32	10.16	39.3

Capacitance values	see table
Tolerances on the capacitance	±20 %
Working voltage	see table
Permissible voltage at ≤50 °C	1.1 x working voltage
Peak voltage at ≤50 °C, for 1 min/hour	1.25 x working voltage
Average leakage current	40 % of maximum value, see table
Temperature range	-80 °C up to 85 °C (without derating)

Composition of the catalog number

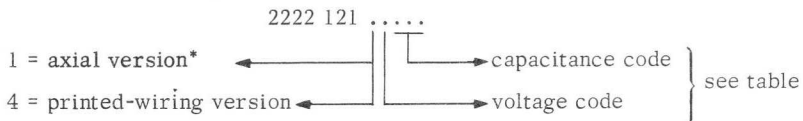

* insulated

can size	working voltage (V)	capacitance (μF)	leakage current ¹⁾ (μA)	ripple current ²⁾		$\tan \delta^3)$	impedance ⁴⁾ (Ω)	voltage and capac. code
				100 Hz (mA)	100 kHz (mA)			
1	4	27	9	100	220	0.20	2.5	2279
2		56	32	155	325	0.20	1.25	2569
3		100	57	235	485	0.20	0.75	2101
4		180	80	350	655	0.20	0.5	2181
5		270	105	505	865	0.20	0.4	2271
6		390	120	685	980	0.20	0.4	2391
1	6.3	22	12	90	220	0.18	2.5	3229
2		47	43	150	325	0.18	1.25	3479
3		82	73	225	485	0.18	0.75	3829
4		150	107	340	655	0.18	0.5	3151
5		220	140	480	865	0.18	0.4	3221
6		330	160	670	980	0.18	0.4	3331
1	10	15	15	80	220	0.16	2.5	4159
2		33	53	135	325	0.16	1.25	4339
3		56	90	195	485	0.16	0.75	4569
4		100	133	290	655	0.16	0.5	4101
5		150	175	420	865	0.16	0.4	4151
6		220	200	575	980	0.16	0.4	4221
1	16	8.2	18	65	220	0.14	2.5	5828
2		18	57	157	325	0.14	1.25	5189
3		33	105	105	485	0.14	0.75	5339
4		56	160	240	655	0.14	0.5	5569
5		82	210	335	865	0.14	0.4	5829
6		120	240	465	980	0.14	0.4	5121
1	25	5.6	21	55	150	0.14	5	6568
2		12	60	95	235	0.14	2.5	6129
3		22	110	140	340	0.14	1.5	6229
4		39	185	210	470	0.14	1	6399
5		56	245	295	610	0.14	0.8	6569
6		82	280	405	880	0.14	0.5	6829
1	40	2.7	24	45	150	0.10	5	7278
2		5.6	84	70	235	0.10	2.5	7568
3		10	145	105	340	0.10	1.5	7109
4		18	212	160	470	0.10	1	7189
5		27	280	230	610	0.10	0.8	7279
6		39	320	305	880	0.10	0.5	7399

1) Max. value at 20 °C after 5 min; the average values are 40% of the max. values.

2) Maximum permissible ripple current up to 70 °C.

3) Maximum dissipation factor at 20 °C and 100 Hz, the average values are approximately 50% lower.

4) Maximum impedance at 20 °C and 100 kHz.

The leakage currents of solid aluminium capacitors can be considerably reduced by derating the voltage:

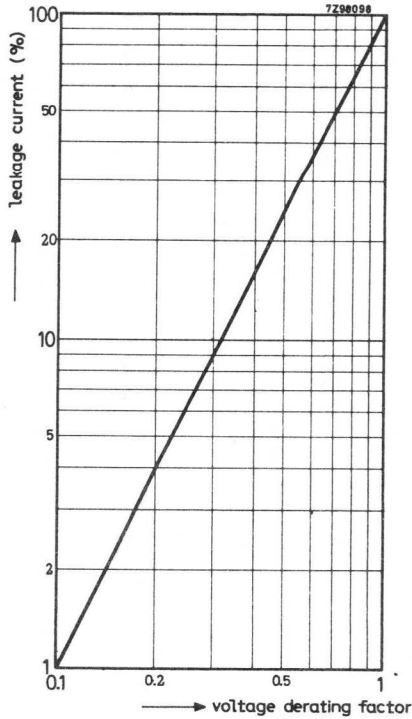

Leakage current (in % of the leakage current at the working voltage) as a function of the derating factor (applied voltage/nominal working voltage), applicable to both average and maximum values of leakage current.

Impedance graphs

Typical impedance/temperature curves for the different can sizes are given below.
The maximum values at 20 °C and 100 kHz are stated in the table.

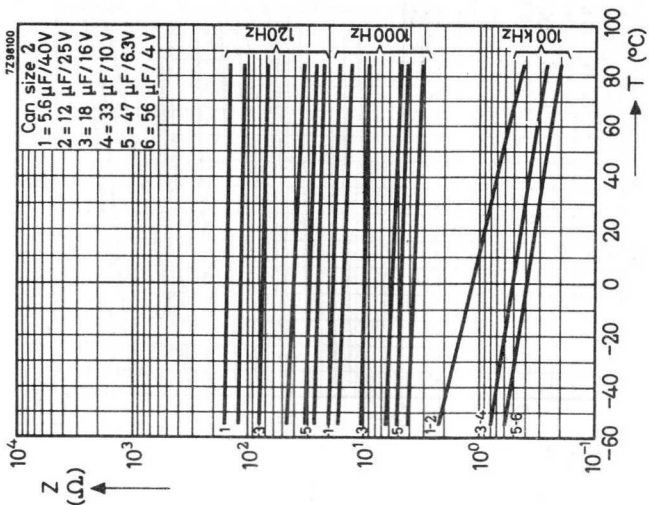
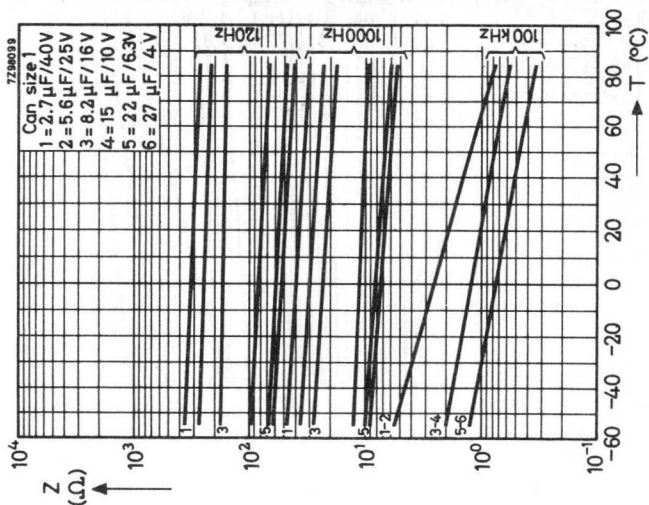

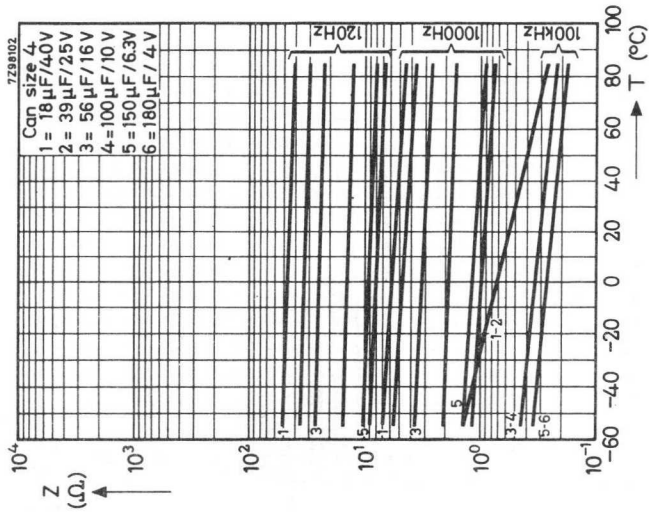
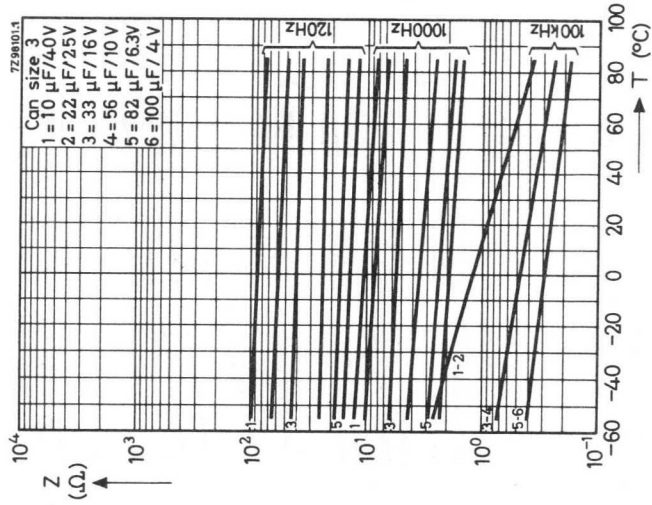

ELECTROLYTIC CAPACITORS
Small solid aluminium type

2222 121

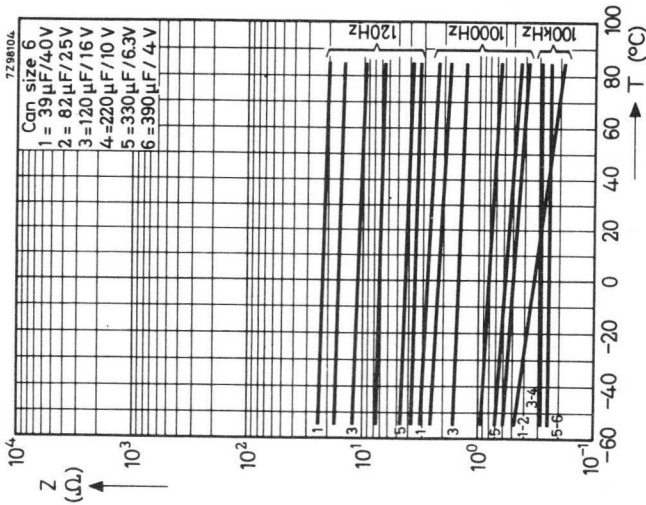
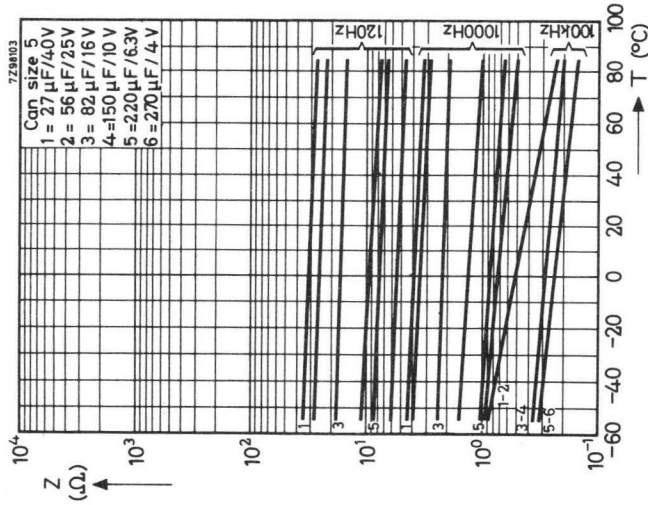

ELECTROLYTIC CAPACITORS miniature solid tantalum type

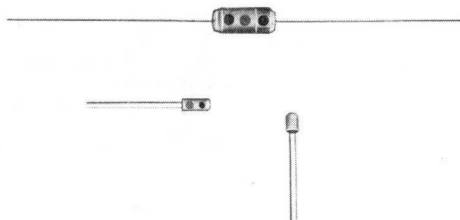

RZ24124-1

Capacitance range	0.015 - 56 μ F
Maximum d. c. working voltages	1.6-25 V

APPLICATION

Miniature solid tantalum capacitors are designed especially for those applications where ultra small dimensions are a must and yet a high stability and reliability are required.

Typical applications are hearing-aids, electronic watches and paging-systems.

CONSTRUCTION

The capacitor is of the solid type with a sintered anode and is built into a metal can. Two versions are available, a single-ended version and an axial-lead version.

Dimensions in mm

can size	Fig.	D	L
1	1	1.9	2.5
2		1.9	3.8
3	2	1.9	4.7
4		2.4	5.2
5		3.4	7.2

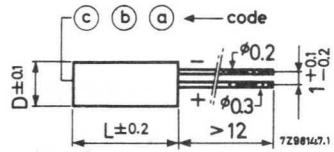

Fig. 1. Single-ended version

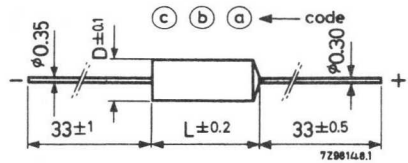

Fig. 2. Axial-lead version

Colour code

The colour code should be read starting from the leads for the single-ended versions or from the anode side for the axial-lead versions. The third dot (c) is on the top of the single-ended version.

colour	capacitance = a x b μ F		nominal voltage c (V)
	a (μ F)	b multiplier	
black	1	1	2.5
brown	1.2	10	4
red	1.5	10^2	6.3
orange	1.8	10^3	10
yellow	2.2		16
green	2.7		25
blue	3.3		40
violet	3.9		63
grey	4.7		1
white	5.6		1.6
silver	6.8	10^{-2}	
gold	8.2	10^{-1}	

Example: dot a = yellow
dot b = gold
dot c = red
} 0.22 μ F - 6.3 V

AXIAL-LEAD VERSION

can size	working voltage (V)	capacitance (μF)	leakage current ¹⁾ (μA)	ripple current ²⁾ (mA)	$\tan \delta$ 3)	impedance 4) (Ω)	cat.No. 2222 142 followed by
3	1.6	10	1	1	0.15	10	20109
4		22	1.5	2.5	0.15	7.5	20229
5		56	2.5	7	0.15	3.5	20569
3	2.5	6.8	1	1	0.10	10	21688
4		15	1.5	2.5	0.10	7.5	21159
5		39	2.5	7	0.10	3.5	21399
3	4	3.9	1	1	0.10	10	22398
4		10	1.5	2.5	0.10	7.5	22109
5		22	2.5	7	0.10	3.5	22229
3	6.3	2.7	1	1	0.08	10	23278
4		6.8	1.5	2.5	0.08	7.5	23688
5		15	2.5	7	0.08	3.5	23159
3	10	1.5	1	1	0.08	10	24158
4		3.9	1.5	2.5	0.08	7.5	24398
5		10	2.5	7	0.08	3.5	24109
3	16	1	1	1	0.08	10	25108
4		2.7	1.5	2.5	0.08	7.5	25278
5		6.8	2.5	7	0.08	3.5	25688
3	25	0.68	1	1	0.08	10	26687
4		1.5	1.5	2.5	0.08	7.5	26158
5		4.7	2.5	7	0.08	3.5	26478

1) Maximum leakage current after 5 minutes.

2) Maximum permissible ripple current at 100 Hz and 85 °C.

3) Maximum dissipation factor at 100 Hz.

4) Maximum impedance at 100 kHz.

ELECTROLYTIC CAPACITORS

solid tantalum type

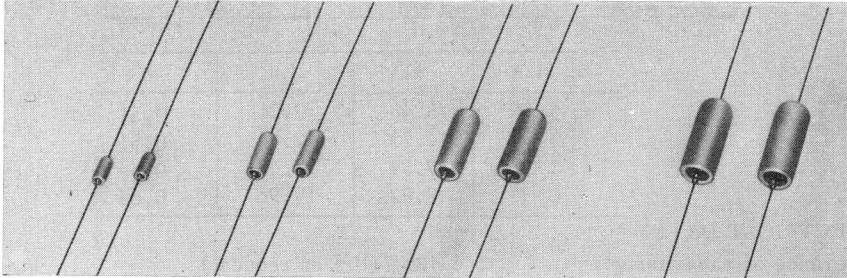

RZ 18570

Solid electrolytic tantalum capacitors offer great advantages over wet types as regards service life, reliability, stability during life, temperature range etc. Apart from this, very small dimensions are achieved. They are therefore preferable for all kinds of miniaturised professional equipment.

72080981

C (μ F)	d.c. rated voltage (V)				
	6	10	15	20	35
0.33				1	
0.39				1	
0.47				1	
0.56				1	
0.68				1	
0.82				1	
1				1	
1.2			1	2	
1.5			1	2	
1.8			1	2	
2.2			1	2	
2.7			1	2	
3.3			1	2	
3.9		1		2	
4.7		1		2	
5.6	1			2	
6.8	1			2	
8.2				2	3
10				2	3

7298097

C (μ F)	d.c. rated voltage (V)				
	6	10	15	20	35
12				2	3
15				2	3
18				2	3
22				2	3
27		2		3	4
33		2		3	4
39		2		3	4
47	2			3	4
56	2		3	4	
68			3	4	
82			3	4	
100			3	4	
120			3	4	
150		3		4	
180		3	4		
220			4		
270				4	
330				4	

DIMENSIONS in mm

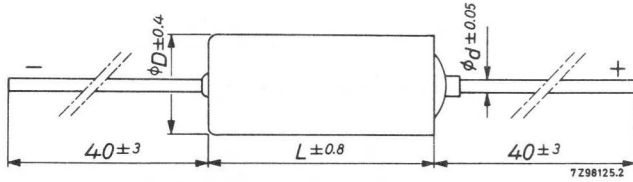

can size	D	L	d
1	3.43	7.26	0.51
2	4.75	12.04	0.51
3	7.34	17.42	0.64
4	8.92	19.96	0.64

ELECTRICAL DATA

Tolerance on capacitance $\pm 20\%$ (10% on request)
 Temperature with rated voltage $-55/+85\text{ }^{\circ}\text{C}$
 with derated voltage up to $+125\text{ }^{\circ}\text{C}$

D. C. rated and surge voltages

d. c. rated voltage (V)		d. c. surge voltage (V)	
+ 85 °C	+ 125 °C	+ 85 °C	+ 125 °C
6	4	8	5
10	7	12	9
15	10	16	12
20	13	21	16
35	20	35	24

Ripple current

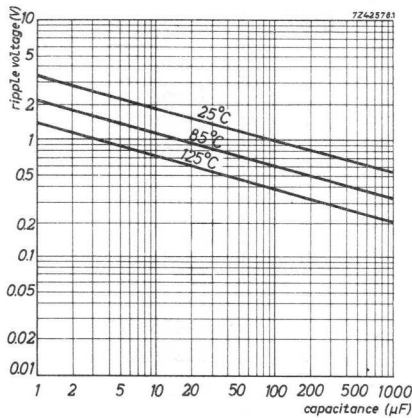

Graph 1

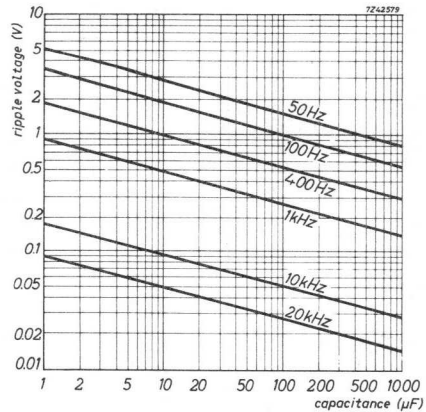

Graph 2

The capacitors may be operated at a superimposed a.c. ripple voltage, provided this does not cause the limit of the heat dissipation to be exceeded. This limit depends on the ripple frequency, ambient temperature and capacitance.

The ripple current I_R , permissible at 25 °C and 100 Hz, is calculated from the equation $I_R = 2 \pi f E_T C$, where f = the ripple frequency in Hz; E_T = the ripple voltage (see Graph 1); C = the capacitance in F.

The ripple voltage E_T , permissible at any temperature T and frequency f , is calculated by means of the two graphs and the equation $E_T = E_{100} \times E_{25} / R_T$, where

E_T = the maximum ripple voltage at 25 °C and 120 Hz, see Graph 1

E_{100} = the maximum ripple voltage at T °C and 120 Hz, see Graph 1

E_{25} = the maximum ripple voltage at 25 °C and f Hz, see Graph 2.

can size	d.c. rated voltage 85 °C (V)	capacitance (μ F)	leakage current 1) (μ A)	catal. No. 2222 143 followed by 2)
1	6	5.6	1	13568
1	6	6.8	1	13688
2	6	47	6	13479
2	6	56	7	13569
3	6	150	18	13151
3	6	180	21	13181
4	6	270	32	13271
4	6	330	40	13331
1	10	3.9	1	14398
1	10	4.7	1	14478
2	10	27	5	14279
2	10	33	7	14339
2	10	39	8	14399
3	10	82	16	14829
3	10	100	20	14101
3	10	120	24	14121
4	10	180	36	14181
4	10	220	44	14221
1	15	2.7	1	15278
1	15	3.3	1	15338
2	15	18	5	15189
2	15	22	7	15229
3	15	56	17	15569
3	15	68	20	15689
4	15	120	36	15121
4	15	150	45	15151
1	20	1.2	1	16128
1	20	1.5	1	16158
1	20	1.8	1	16188
1	20	2.2	1	16228
2	20	8.2	3	16828
2	20	10	4	16109
2	20	12	5	16129
2	20	15	6	16159
3	20	27	11	16279
3	20	33	13	16339
3	20	39	16	16399
3	20	47	19	16479

1) Maximum leakage current at 25 °C after 5 minutes.

2) For 10% tolerance the first digit of the suffix is 8 instead of 1.

can size	d.c. rated voltage 85 °C (V)	capacitance (μ F)	leakage current 1) (μ A)	catalog No. 2222 143 followed by 2)
4	20	56	22	16569
4	20	68	27	16689
4	20	82	33	16829
4	20	100	40	16101
1	35	0.33	1	17337
1	35	0.39	1	17397
1	35	0.47	1	17477
1	35	0.56	1	17567
1	35	0.68	1	17687
1	35	0.82	1	17827
1	35	1	1	17108
2	35	1.2	1	17128
2	35	1.5	1	17158
2	35	1.8	1	17188
2	35	2.2	2	17228
2	35	2.7	2	17278
2	35	3.3	2	17338
2	35	3.9	3	17398
2	35	4.7	3	17478
2	35	5.6	4	17568
2	35	6.8	5	17688
3	35	8.2	6	17828
3	35	10	7	17109
3	35	12	8	17129
3	35	15	11	17159
3	35	18	13	17189
3	35	22	15	17229
4	35	27	19	17279
4	35	33	23	17339
4	35	39	27	17399
4	35	47	33	17479

1) Maximum leakage current at 25 °C after 5 minutes.

2) For 10% tolerance the first digit of the suffix is 8 instead of 1.

Variable capacitors

Tubular ceramic trimmers	page G3
Air dielectric trimmers	page G23
Concentric air dielectric trimmers	page G39
Film dielectric trimmers	page G59
Air dielectric correcting capacitors	page G35
Precision tuning capacitors	page G43



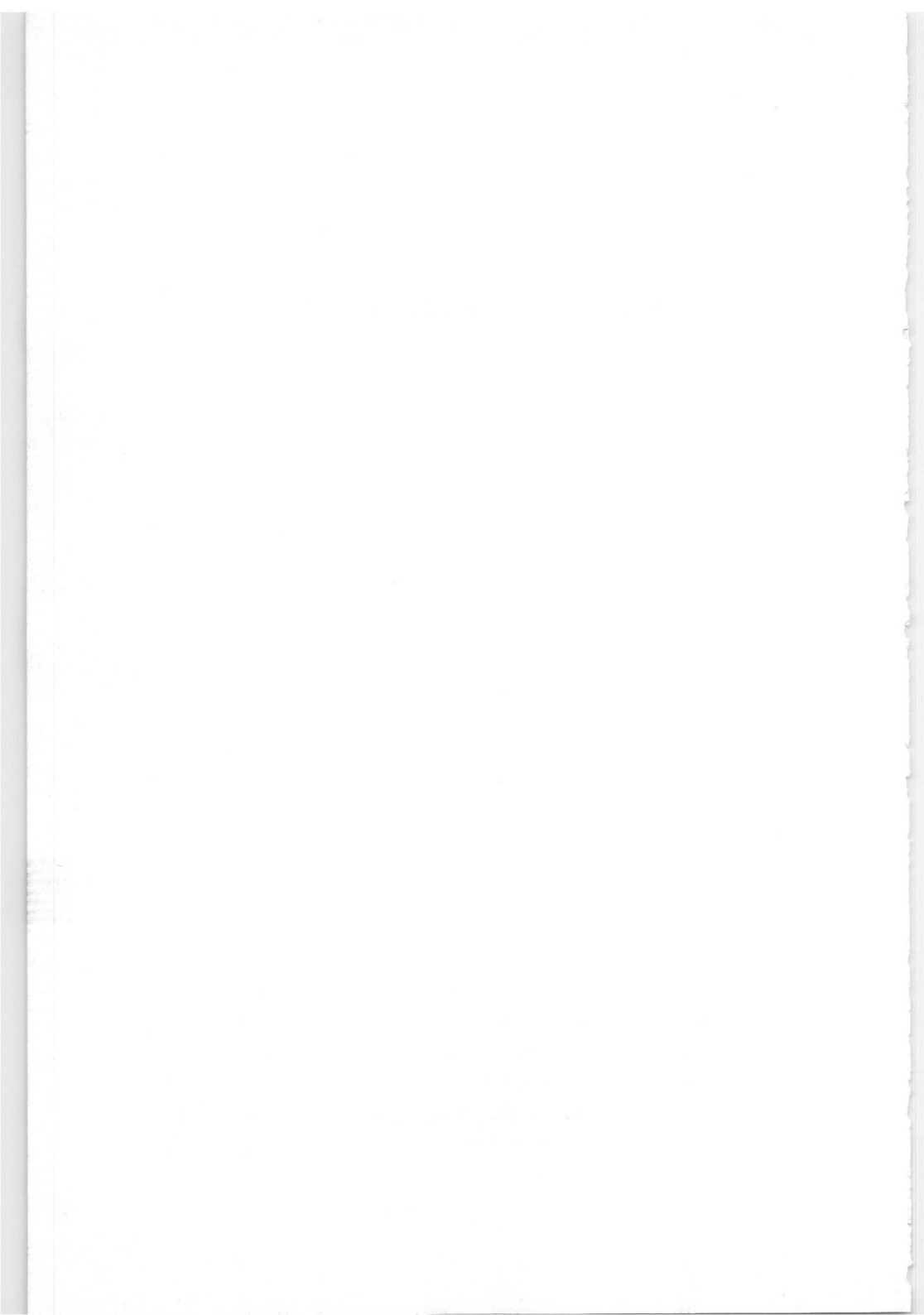

TUBULAR CERAMIC TRIMMERS

screw-driver slot at both ends

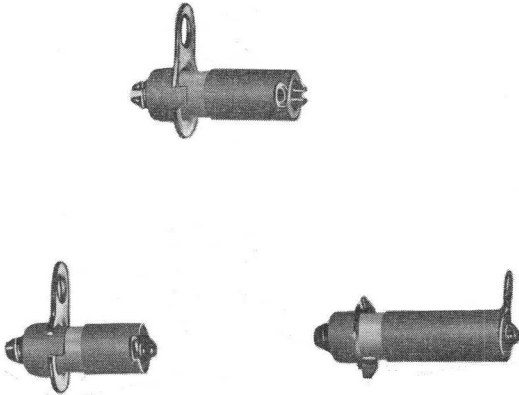

A 46055

Capacitance swing
Connections

3, 6, 9, 12 pF
soldering tags

APPLICATION

The trimmers have been designed for v.h.f. applications in radio and television receivers. For many applications the negative temperature coefficient results in a favourable compensation at varying temperatures. The two modes of mounting increase the universal applicability.

CONSTRUCTION

The trimmers consist of an internally ground ceramic tube in which a helical rotor of invar metal can be screwed up and down. Both rotor ends are slotted for screw-driver operation.

The rotor is guided by means of a wire spring which is interposed between the tube and a silver-plated brass fixture. This fixture is pressed on to the top of the tube (2 versions are available). The external bottom part of the tube acts as a stator and is provided with a soldering tag.

TECHNICAL PERFORMANCE

Minimum capacitance swing	3; 6; 9; 12 pF
Maximum zero capacitance	0.8; 0.8; 0.9; 1 pF
Effective angle of rotation	3x360°; 5x360°; 7x360°; 9x360°
Temperature coefficient	-200 ± 200 ppm/deg C
Maximum permissible working voltage	500 V _{dc}
Test voltage for 1 minute	1000 V _{dc}
Permissible temperature range	-50 to +100 °C
Minimum insulation resistance	10 000 MΩ
Maximum contact resistance	10 mΩ
Minimum parallel damping at 1.0 MHz and maximum capacitance	3 MΩ
Operating torque	0.4-5 Ncm
Maximum axial load on the rotor during operation	2 N
Weight	approximately 2 g
Soldering	260 °C, 4 s
Category (I.E.C. 68)	50/100/21

MECHANICAL DATA

Dimensions (mm) and catalogue numbers

Version A - the fixture is provided with a tag (hole 3.2 mm)
for mounting screw (M3). ¹⁾

Version C - the fixture is intended to be soldered directly to the mounting panel.

¹⁾ can also be soldered directly to the panel

capacitance swing (pF)	dimensions (mm)		catalogue number	
	l	a	version A	version C
3	5.5	13.5	2222 801 20001	2222 801 20005
6	8.5	16.5	20002	20006
9	11.5	19.5	20003	20007
12	14.5	22.5	20004	20008

Mounting

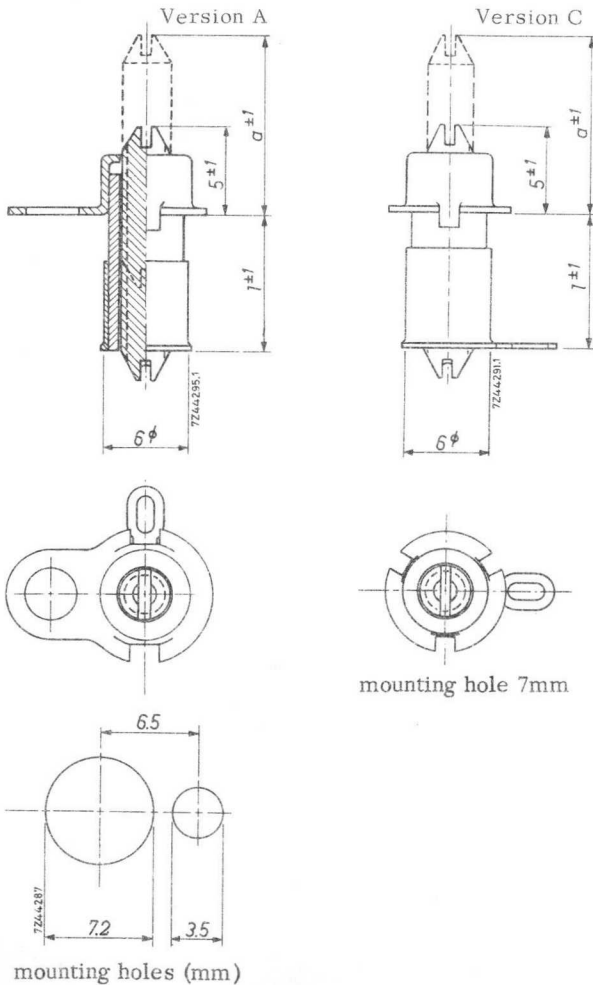

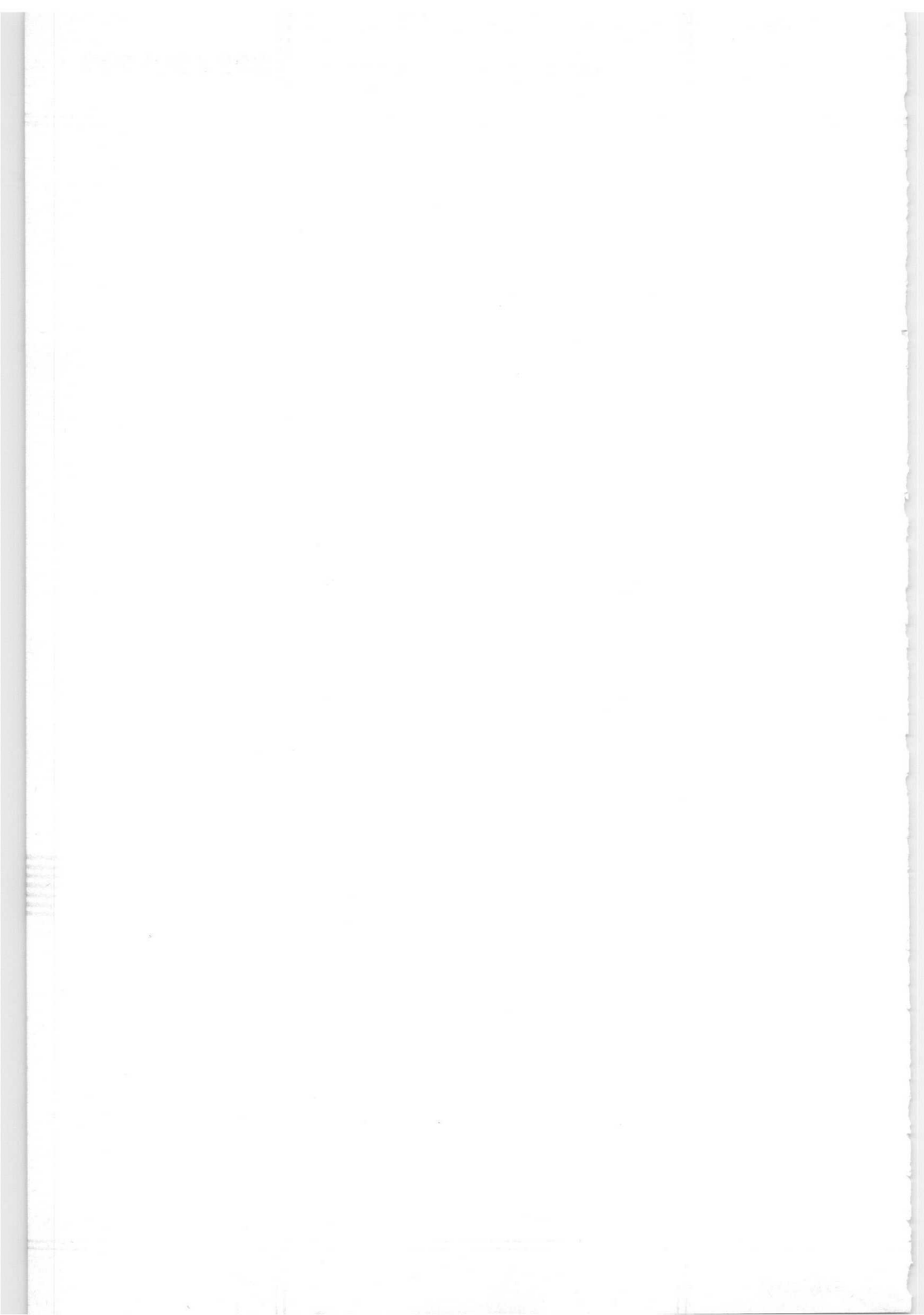

MIDGET TUBULAR CERAMIC TRIMMERS

screw-driver slot at both ends

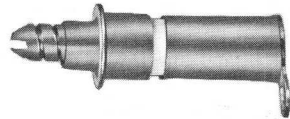
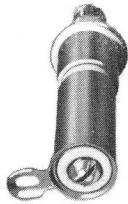

RZ 21046-1

Capacitance swing
Connections

3 and 6 pF
soldering tags

APPLICATION

These trimmers have been developed for v.h.f. application in radio and television sets, especially in miniaturised equipment.

CONSTRUCTION

A thin ceramic tube, internally ground, fits closely a threaded invar spindle (rotor). This spindle is guided by a U-shaped spring, which is kept in place by a silverplated brass cap. Both ends of the spindle are provided with a screwdriver slot to facilitate adjustment. The stator is a silverplated brass tube; it makes a tight fit with the ceramic tube. The cap, which must be soldered to the chassis, and a soldering tag on the stator enable a reliable connection with the circuit.



2222 801 20051
2222 801 20052

MIDGET TUBULAR CERAMIC TRIMMERS
 screw-driver slot at both ends

TECHNICAL PERFORMANCE

	2222 801 20051	2222 801 20052	
Minimum capacitance swing	3	6	pF
Maximum zero capacitance	0.8	0.8	pF
Temperature coefficient	-200 ± 200	-300 ± 200	ppm/deg C
Maximum permissible working voltage	400 V _{dc}		
Test voltage for 1 minute	800 V _{dc}		
Permissible temperature range	-50 to $+100$ °C		
Minimum insulation resistance	10 000 MΩ		
Maximum contact resistance	10 mΩ		
Minimum parallel damping at 1.0 MHz and maximum capacitance	3 MΩ		
Operating torque	0.1-2 Ncm		
Category (I.E.C. 68)	50/100/21		
Soldering	stator tag: in conformity with I. E. C. 68, test T		
	cap : the soldering temperature must lie between 240 °C and 260 °C, maximum soldering time is 10 s.		
Maximum axial load on the rotor during operation	2 N		

MECHANICAL DATA

Dimensions in mm

L (mm)	A at C _{min} (mm)	catalog number
7.8+0.5	10.5+1	2222 801 20051
10.8+0.5	13.5+1	20052

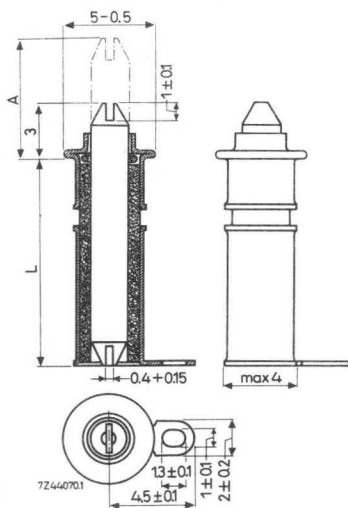

Mounting

The trimmers can be fixed by soldering the cap to the chassis. The diameter of the required circular mounting hole is 4.2 mm.

TUBULAR CERAMIC TRIMMERS

screw-driver slot at both ends

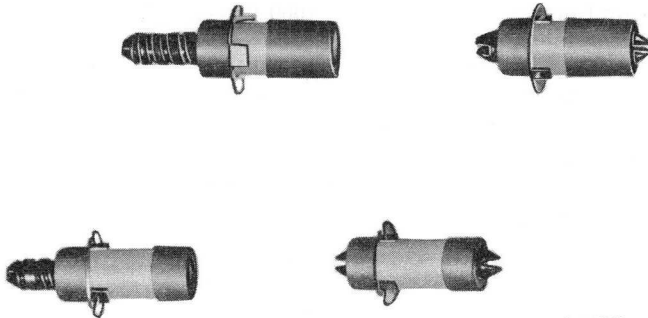

A 46050

Capacitance swing

3 and 6 pF

APPLICATION

These trimmers have been designed for v.h.f. applications and are particularly suitable for u.h.f. tuners and other electronic circuits operating in the higher frequency ranges.

CONSTRUCTION

Since a brass rotor is used, the series resistance of the trimmers is low and the Q value quite acceptable, even at very high frequencies; see the graph in which Q has been plotted as a function of working frequency.

Because, rather than wire leads, connecting strips being an integral part of the circuit are appropriate at high frequencies, the stator is not provided with a soldering tag and it is silver-plated to ensure good solderability.

The fixture on the top of the ceramic tube is likewise intended for being soldered on directly to the mounting panel. In order to obtain items of equal lengths, the fixture is attached at the same height of the tube irrespective of the capacitance rating.

TECHNICAL PERFORMANCE

	2222 801 96003	2222 801 96002
Minimum capacitance swing	3	6 pF
Maximum zero capacitance	0.5	0.7 pF
Temperature coefficient	+150 ± 150	+150 ± 100 ppm/deg C
Maximum permissible working voltage	500 V _{dc}	
Test voltage for 1 minute	1000 V _{dc}	
Permissible temperature range	-50 to +100 °C	
Minimum insulation resistance	10 000 MΩ	
Maximum contact resistance	3 mΩ	
Minimum parallel damping at 1.0 MHz and maximum capacitance	10 MΩ	
Operating torque	0.4-5 Ncm	
Maximum axial load on the rotor during operation	2 N	
Weight	approx. 1.8 g	
Category (I.E.C. 68)	50/100/21	

Soldering:

The soldering temperature, which should not exceed 250 °C, can be achieved either in a uniformly heated furnace (max. 4 s) or by means of h.f. heating (max. 7 s). In both cases, adequate solder connections will be obtained without impairment of the characteristics, provided that low-melting tin foil is used in conjunction with an appropriate flux.

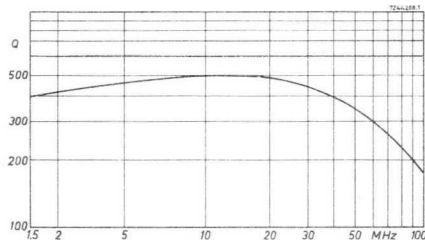

MECHANICAL DATA

Dimensions (mm)

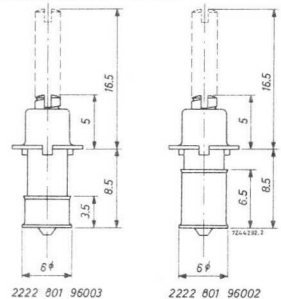

Mounting

The mounting hole should have a diameter of 6.5 mm

TUBULAR CERAMIC TRIMMERS

screw-driver slot at both ends

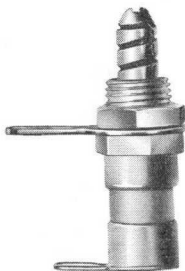

RZ 23557/10

Capacitance swing
Connections

3, 6, 9, 12, 18 pF
soldering tags

APPLICATION

These capacitors have been designed for the precision trimming of industrial equipment which operate at the higher frequencies.

Their simple form of construction guarantees high reliability and facilitates, moreover, a high breakdown voltage, good stability and high adjustment accuracy.

For many applications the negative temperature coefficient characteristic results in adequate compensation of various temperatures.

The small dimensions contribute to the miniaturisation of electronic equipment.

CONSTRUCTION

The trimmers consist of an internally ground ceramic tube, in which an invar rotor is guided by a silverplated steel wire spring.

Both ends of the rotor are provided with a slot for screw-driver operation.



2222 802 20001-
2222 802 20005

TUBULAR CERAMIC TRIMMERS
 screw-driver slot at both ends

Dimensions in mm

For A and L see table on next page.

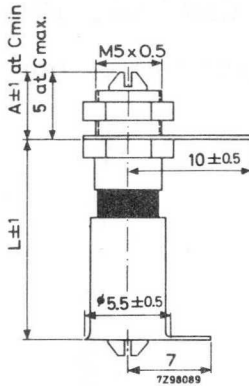

Mounting

The trimmers can be fixed to panels up to 2 mm thick by means of the nut supplied. The diameter of the required circular mounting hole is 5.2 mm.

→ TECHNICAL PERFORMANCE

Permissible working voltage	≤ 500 V _{dc}
Test voltage	1000 V _{dc}
Permissible temperature range	-50 to +100 °C
Temperature coefficient	-200 ± 200 ppm/deg C
Contact resistance (between tag and rotor)	≤ 10 mΩ
Parallel damping at 1.0 MHz	> 3 MΩ
Insulation resistance	> 10 000 MΩ
Operating torque	0.4-5 Ncm
Capacitance change with an axial load of 2 N	
for trimmer 2222 802 20001	≤ 0.03 pF
20002	≤ 0.04 pF
20003	≤ 0.06 pF
20004	≤ 0.08 pF
20005	≤ 0.2 pF
Category (I.E.C. 68)	50/100/21

Also in accordance with equivalent MIL requirements.

TUBULAR CERAMIC TRIMMERS
screw-driver slot at both ends

2222 802 20001-
2222 802 20005

capaci- tance swing (pF)	zero capaci- tance (pF)	angle of rotation a° (approx.)	maximum dimensions (mm)		catalog number
			L	A	
≥ 3	≤ 0.8	7 x 360	11	14.5	2222 802 20001
≥ 6	≤ 0.8	7 x 360	14	17.5	20002
≥ 9	≤ 0.9	9 x 360	17	20.5	20003
≥ 12	≤ 1.0	11 x 360	20	23.5	20004
≥ 18	≤ 1.7	11 x 360	20	23.5	20005

1906-1907
1908-1909

HIGH STABILITY TUBULAR CERAMIC TRIMMERS with locking device

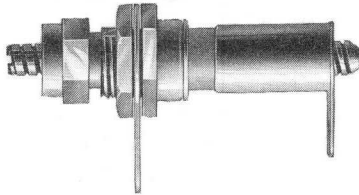

24341/5

Capacitance swing
Connéctions

3, 4.5, 6, 9, 12 pF
soldering tags

APPLICATION

These capacitors have been designed for the precision trimming of industrial equipment which operate at the v.h.f. frequencies.

Their simple form of construction guarantees high reliability and facilitates, moreover, a high breakdown voltage, good stability and high adjustment accuracy.

For many applications the negative temperature coefficient characteristic results in adequate compensation at various temperatures.

The small dimensions contribute to the miniaturisation of electronic equipment.

CONSTRUCTION

The trimmers consist of a low-k ceramic tube (for the values 3, 4.5, 6 pF and a higher-k ceramic tube for 9 and 12 pF), internally ground, in which an invar rotor is guided by a threaded cap. This invar rotor has a copper coating which is nickel-plated*), one end is provided with a slot for screw-driver operation. By means of a locking nut the rotor can be locked after adjustment.

*) Silverplated rotor can be delivered on request.

2222 802 20011-
2222 802 20015

HIGH STABILITY TUBULAR CERAMIC
 TRIMMERS
 with locking device

Dimensions in mm

For A and L see table.

Mounting in specially
 shaped hole

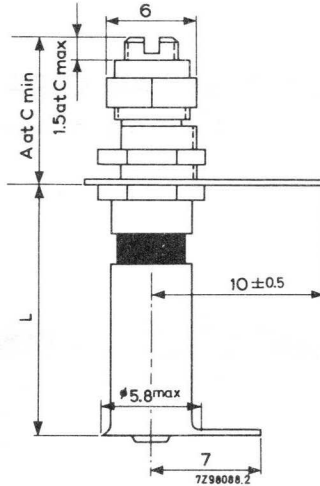
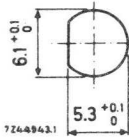

TECHNICAL PERFORMANCE

Permissible working voltage	≤ 500 V _{dc}
Test voltage	1000 V _{dc}
Permissible temperature range	-50 to +100 °C
Contact resistance (between tag and rotor)	≤ 3 mΩ
Parallel damping at 1.0 MHz	> 10 MΩ
at 100 MHz	> 3 MΩ
Insulation resistance	> 10 000 MΩ
Operating torque	0.4-4 Ncm; 10 Ncm if locked with 42 Ncm
Capacitance change with an axial load of 2 N	< 0.005 pF
Category (I.E.C. 68)	50/100/21

Also in accordance with equivalent MIL requirements.

capacitance swing (pF)	zero capacitance (pF)	temp. coeff (ppm)	angle of rotation α ⁰ (approx.)	maximum dimensions (mm)		catalogue number
				L	A	
≥ 3	≤ 0.5	- 10 ± 60	8 x 360	12.4	22.5	2222 802 20011
≥ 4.5	≤ 0.6	- 10 ± 60	10 x 360	15.4	25.5	20012
≥ 6	≤ 0.7	- 10 ± 60	11 x 360	17.9	28.0	20013
≥ 9	≤ 0.9	- 250 ± 250	10 x 360	15.4	25.5	20014
≥ 12	≤ 1.0	- 250 ± 250	11 x 360	18.4	28.0	20015

MIDGET TUBULAR CERAMIC TRIMMERS

screw-driver slot at both ends

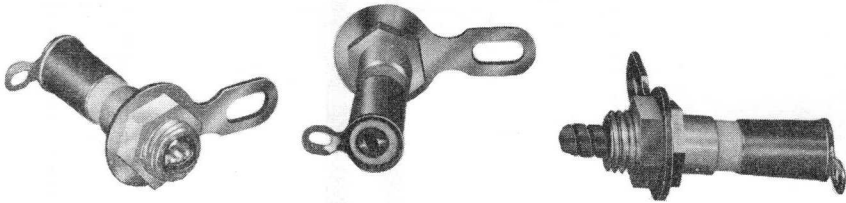

RZ 21111-1

Capacitance swing
Connections

3 and 6 pF
soldering tags

APPLICATION

These trimmers have been designed for professional electronic applications, particularly in the domain of miniaturised industrial equipment. Reliability is ensured by the simple construction and good stability.

CONSTRUCTION

A thin ceramic tube, internally ground, fits closely a threaded invar spindle (rotor). This spindle is guided by a U-shaped spring, which is kept in place by a silverplated brass cap. Both ends of the spindle are provided with a screw-driver slot to facilitate adjustment. The stator is a silverplated brass tube; it makes a tight fit with the ceramic tube. A soldering tag on the cap and a soldering tag on the stator enable a reliable connection with the circuit.

Dimensions in mm (see figure on next page)

L	l	A at C_{min}	catalog number
8.3 ± 1	7.3 ± 0.5	9 + 1	2222 802 96035
11.3 ± 1	10.3 ± 0.5	12 + 1	96036

Mounting

The trimmers can be fixed to chassis up to 1 mm thick by means of the nut supplied. The diameter of the required circular mounting hole is 4.2 mm.

2222 802 96035
2222 802 96036

MIDGET TUBULAR CERAMIC TRIMMERS
 screw-driver slot at both ends

For A, l and L see table on preceding page.

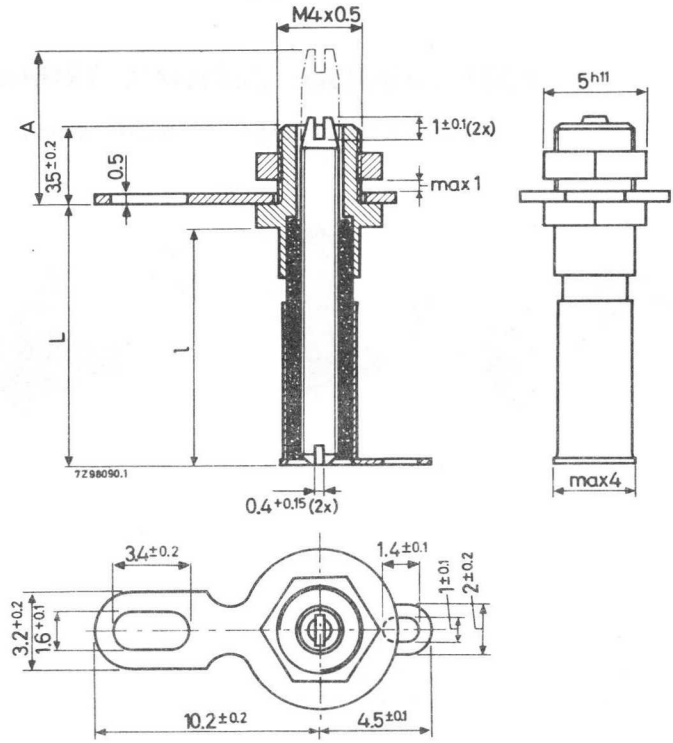

TECHNICAL PERFORMANCE

Minimum capacitance swing	
trimmer 2222 802 96035	3 pF
trimmer 2222 802 96036	6 pF
Maximum zero capacitance	0.8 pF
Maximum permissible working voltage	400 V _{dc}
Test voltage for 1 minute	800 V _{dc}
Permissible temperature range	-50 to +100 °C
Temperature coefficient	
trimmer 2222 802 96035	-200 ± 200 ppm/deg C
trimmer 2222 802 96036	-300 ± 200 ppm/deg C
Minimum insulation resistance	10 ⁴ MΩ
Maximum contact resistance	10 mΩ
Minimum parallel damping at 1.0 MHz	10 MΩ
Operating torque	0.1-2 Ncm
Category (I.E.C. 68)	50/100/21
Solderability	in conformity with I.E.C. 68, test T
Maximum capacitance change with an axial load of 2 N	0.03 pF

HIGH STABILITY TUBULAR CERAMIC TRIMMERS with friction locking device

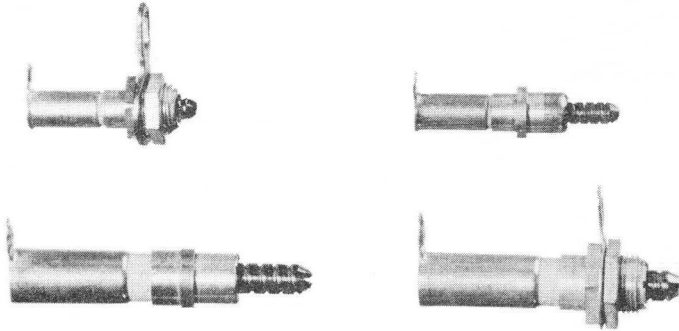

RZ 24124-4

Capacitance swing
Connections
Gold-plated rotor

3, 4.5, 6, 9, 12 pF
soldering tags

APPLICATION

These trimmers have been designed for u.h.f. applications, where high stability has to be maintained even under severe mechanical conditions, e.g. television aerial amplifiers.

CONSTRUCTION

The dielectric of the trimmers is formed by a ceramic tube, in which a gold-plated-copperclad invar rotor is guided by an U-shaped spring. This spring is clamped between the ceramic tube and the fixing cap. A P.T.F.E. locking ring, which is pressed into the fixing cap, guarantees a high stability. The trimmers are available with a ceramic tube with low dielectric constant (k6 material, class A) and with a high dielectric constant (k20 material, class B). Trimmers of both classes are delivered in a screw mounting type as well as in a solder mounting type. For mounting the last mentioned type, the cap has to be soldered to the chassis.

Dimensions in mm

For A and L see tables on next page.

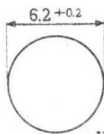
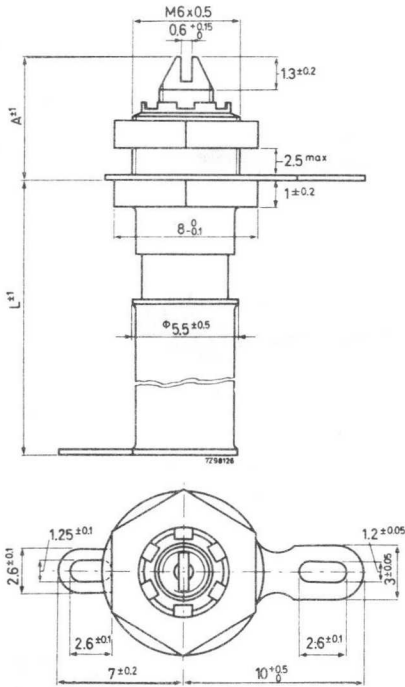

mounting hole

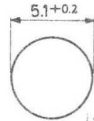
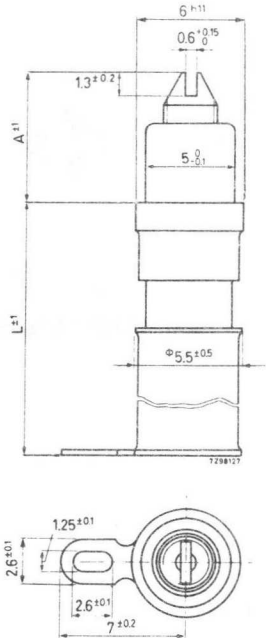

mounting hole

Fig. 1. Screw mounting type

Fig. 2. Solder mounting type

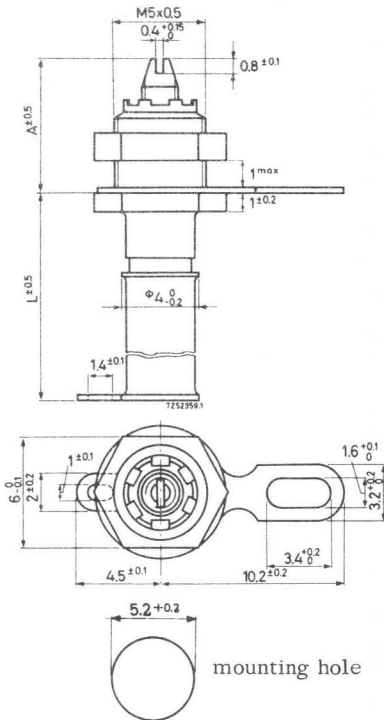

Fig. 3. Screw mounting type

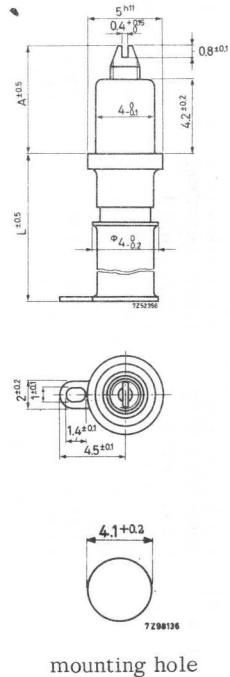

Fig. 4. Solder mounting type

cap. swing (pF)	zero cap. (pF)	class	dimensions (mm), see Figs. 1 and 2 L A at C _{min}		catalogue number 2222 802 960..	
					screw mounting type (Fig.1)	solder mounting type (Fig.2)
≥ 3	≤ 0.8	B	11	14.5	44	51
≥ 6	≤ 0.8		14	17.5	45	52
≥ 9	≤ 0.9		17	20.5	46	53
≥ 12	≤ 1.0		20	23.5	47	54
≥ 3	≤ 0.5	A	14	14	66	69
≥ 4.5	≤ 0.6		17	17	67	71
≥ 6	≤ 0.7		19	20	68	72

cap. swing (pF)	zero cap. (pF)	class	dimensions (mm), see Figs. 3 and 4 L A at C _{min}		catalogue number 2222 802 960..	
					screw mounting type (Fig.3)	solder mounting type (Fig.4)
≥ 3	≤ 0.8	B	8.8	7.8	55	57
≥ 6	≤ 0.8		11.8	10.8	56	58

TECHNICAL PERFORMANCE

	class A		class B	
	types according Figs. 1 and 2	types according Figs. 1 and 2	types according Figs. 1 and 2	types according Figs. 3 and 4
Maximum permissible working voltage	500	500	400	V_{dc}
Test voltage	1000	1000	800	V_{dc}
Temperature coefficient	-10 ± 60	-200 ± 150	-200 ± 150	ppm/deg C
Minimum insulation resistance	10 000	10 000	10 000	MΩ
Permissible temperature range	-50 to +100	-50 to +100	-50 to +100	°C
Maximum contact resistance between tag and rotor	3	3	3	mΩ
Minimum parallel damping at 1.0 MHz and maximum capacitance	10	3	3	MΩ
Maximum capacitance change with an axial load of 2 N	0.006	0.01	0.006	pF

Category (I.E.C. 68)
50/100/21. Also in accordance with equivalent MIL requirements.

AIR DIELECTRIC TRIMMERS (14 x 17 mm)

screw-driver adjustment

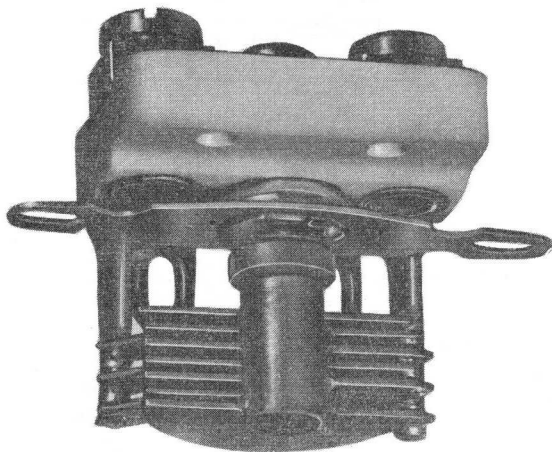

RZ 16105-3

Capacitance swing	
single-stator type	2.5, 4, 6.4, 10, 16 pF
split-stator type	1.6, 2.5, 4 pF
differential type	10, 16 pF
Connections	soldering tags

APPLICATION

For accurate adjustments where long-term operating stability is required. Three types are available: single-stator, split-stator and differential trimmers. Split-stator trimmers are suitable for symmetrically built h.f. circuits; differential types can be used for h.f. capacitive volume or voltage control.

CONSTRUCTION

Base : high-quality siliconised ceramic material.

Rotor : silver-plated brass vanes, soldered on a shaft which is slotted for screw-driver operation; without locking device; slide bearing.

Stator : silver-plated brass vanes, supported by sturdy bars, which are soldered onto the ceramic base.

2222 804 00001-
2222 804 00011

AIR DIELECTRIC TRIMMERS (14 x 17mm)
screw-driver adjustment

Dimensions in mm

For L see table on next page.

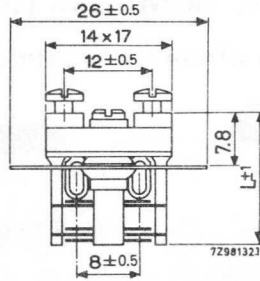

Mounting

By two M2.6 screws at a distance of 12mm in a maximum 3mm thick panel.

TECHNICAL PERFORMANCE

Tolerance on capacitance swing	+ 20% with a minimum of 1 pF
Effective angle of rotation	180° for single-stator and differential trimmers, 90° for split-stator items
Temperature range	-40 to + 85 °C
Temperature coefficient	150 ± 150 ppm/deg C
Contact resistance between rotor tags and rotor	< 3 m Ω
Insulation resistance	$> 10\,000$ M Ω
Parallel damping	> 10 M Ω
Torque	2-6 Ncm
Maximum working voltage	75% of test voltage (see table)
Category (I.E.C. 68)	40/085/21

Also in accordance with equivalent MIL requirements.

type	capacitance swing (pF)	max. zero capacitance (pF)	test voltage (V _{dc})	L (mm)	catalog number
single-stator	2.5	3	1250	17.5	2222 804 00001
	4	3	1000	17.5	02
	6.4	3 } 1)	800 } 1)	17.5	03
	10	3	800	21	04
	16	3	800	21	05
split-stator	1.6	2 } 2)	1600 } 2)	17.5	06
	2.5	2	1600	21	07
	4	2.5 } 2)	1600 } 2)	21	08
differential	10	3.5 } 3)	800 } 3)	21	09
	16	3.5 } 3)	800 } 3)	21	11

- 1) Measured between stator and rotor
- 2) Measured between the two stators
- 3) Measured between stators and rotor

PACKING

The trimmers are packed in transparant plastic boxes (5 trimmers per box).

3217 001 00001

3217 001 00001

000000
000000
000000
000000
000000
000000

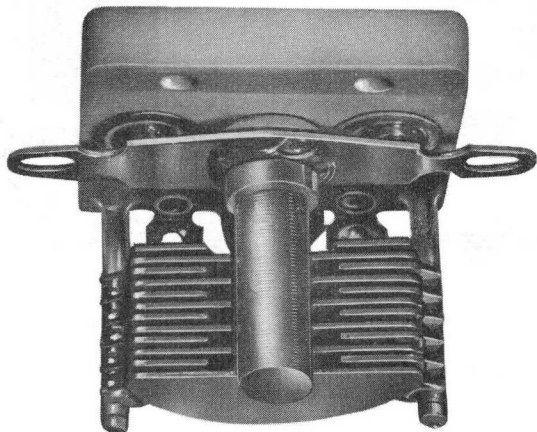
AIR DIELECTRIC TRIMMERS (17×20 mm)**screw-driver adjustment**

RZ 16105-2

Capacitance swing	
single-stator type	6.4, 10, 16, 25, 40 pF
split-stator type	2.5, 4, 6.4 pF
differential type	6.4, 10, 16, 25 pF
Connections	soldering tags

APPLICATION

For accurate adjustments where long-term operating stability is required. Three types are available: single-stator, split-stator and differential trimmers. Split-stator trimmers are suitable for symmetrically built h.f. circuits; differential types can be used for h.f. capacitive volume or voltage control.

CONSTRUCTION

Base: : high-quality siliconised ceramic material.

Rotor: silver-plated brass vanes, soldered on a shaft which is slotted for screw-driver operation; with or without locking device; slide bearing.

Stator: silver-plated brass vanes, supported by sturdy bars, which are soldered onto the ceramic base.

2222 804 01001-
2222 804 01026

AIR DIELECTRIC TRIMMERS (17 x 20 mm)
screw-driver adjustment

Dimensions in mm

For L see table on next page.

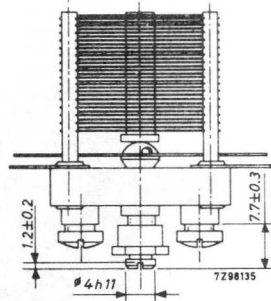
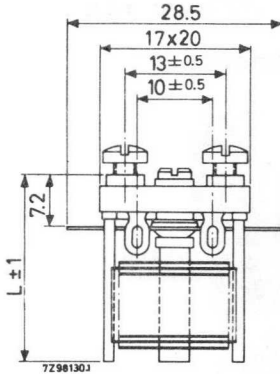

Mounting

By two M3 screws at a distance of 13 mm in a maximum 3 mm thick panel.

TECHNICAL PERFORMANCE

Tolerance on capacitance swing
Effective angle of rotation

+20% with a minimum of 1 pF
180° for single-stator and differential trimmers, 90° for split-stator items

Temperature range
Temperature coefficient
Contact resistance between rotor tags and rotor

-40 to +85 °C
150 ± 150 ppm/deg C

Insulation resistance
Parallel damping
Torque

≤ 3 mΩ
> 10 000 MΩ
> 10 MΩ
2-6 Ncm when unlocked, 10 Ncm when locked at 42 Ncm

Maximum working voltage
Category (I.E.C. 68)

75% of test voltage (see table)
40/085/21
Also in accordance with equivalent MIL requirements.

AIR DIELECTRIC TRIMMERS (17 x 20 mm)
screw-driver adjustment

2222 804 01001-
2222 804 01026

type	capacitance swing (pF)	maximum zero capacitance (pF)	test voltage (V _{dc})	L (mm)	catalog number 2222 804	
					without locking device	with locking device
single-stator	6.4	3	1000	16	01001	01006
	10	3	800	16	01002	01007
	16	3.5 } 1)	800 } 1)	19.5	01003	01008
	25	3.5	800	19.5	01004	01009
	40	4	650	19.5	01005	01011
split-stator	2.5	2	1600	16	01012	01015
	4	2.5 } 2)	1600 } 2)	19.5	01013	01016
	6.4	2.5	1600	19.5	01014	01017
differential	6.4	3	1000	16	01018	01023
	10	3	800	16	01019	01024
	16	3.5 } 3)	800 } 3)	19.5	01021	01025
	25	3.5	800	19.5	01022	01026

1) Measured between stator and rotor.

2) Measured between the two stators.

3) Measured between stators and rotor.

The single-stator and split-stator types can generally be supplied from stock.

PACKING

The trimmers are packed in transparent plastic boxes (5 trimmers per box).



10018 NEW YORK

1875

AIR DIELECTRIC TRIMMERS (20x24 mm)

screw-driver adjustment

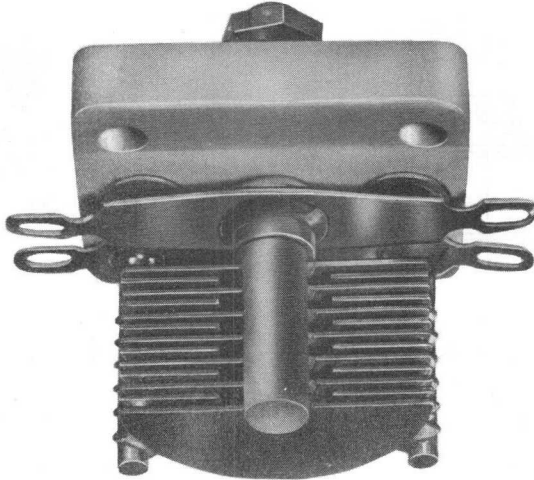

RZ 16105-1

Capacitance swing	
single-stator type	10, 16, 25, 40, 64, 100 pF
split-stator type	2.5, 4, 6.4, 10, 16, 25 pF
Connections	soldering tags

APPLICATION

For accurate adjustments where long-term operating stability is required. Two types are available: single-stator and split-stator trimmers. Split-stator trimmers are suitable for symmetrically built h.f. circuits.

CONSTRUCTION

Base : high-quality siliconised ceramic material.
 Rotor : silver-plated brass vanes, soldered on a shaft which is slotted for screw-driver operation; with or without locking device.
 Stator : silver-plated brass vanes, supported by sturdy bars, which are soldered onto the ceramic base.

2222 804 02001-
2222 804 02026

AIR DIELECTRIC TRIMMERS (20 x 24 mm)
screw-driver adjustment

Dimensions in mm

For L see table on next page.

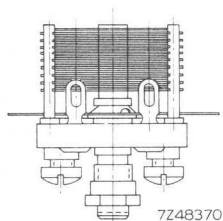
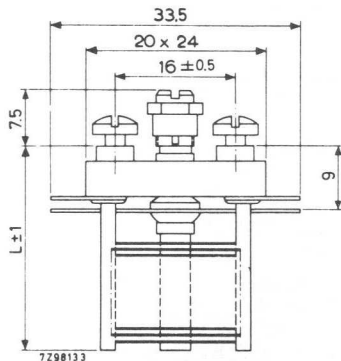

Mounting

By two M3 screws at a distance of 16 mm in a maximum 3 mm thick panel.

TECHNICAL PERFORMANCE

Tolerance on capacitance swing
Effective angle of rotation

Temperature range
Temperature coefficient
Contact resistance between rotor
tags and rotor
Insulation resistance
Parallel damping
Torque

Maximum working voltage
Category (I.E.C. 68)

+20% with a minimum of 1 pF
180° for single-stator trimmers,
90° for split-stator items

-40 to +85 °C
150 ± 150 ppm/degC

≤ 3 mΩ
> 10 000 MΩ
> 10 MΩ

2-6 Ncm when unlocked, 10 Ncm when
locked at 42 Ncm

75% of test voltage (see table)
40/085/21

Also in accordance with equivalent MIL
requirements.

type	capacitance swing (pF)	maximum zero capacitance (pF)	test voltage (V _{dc})	L (mm)	catalog number 2222 804	
					without locking device	with locking device
single-stator	10	3.5	1500	23	02001	02007
	16	3.5	1000	23	02002	02008
	25	4	1000	23	02003	02009
	40	4.5	1000	26.5	02004	02011
	64	5	800	26.5	02005	02012
	100	5.5	800	36.5	02006	02013
split-stator	2.5	2	2500	23	02014	02021
	4	2	2500	26.5	02015	02022
	6.4	2	2000	26.5	02016	02023
	10	2.5	1600	26.5	02017	02024
	16	3	1600	36.5	02018	02025
	25	3	1600	36.5	02019	02026

1) Measured between stator and rotor

2) Measured between the two stators

The types with locking device are preferred and can generally be supplied from stock.

PACKING

The trimmers are packed in transparent plastic boxes (5 trimmers per box).



10050 406 5555

25050 406 5555

AIR DIELECTRIC CORRECTING CAPACITORS (ϕ 25 mm)

screw-driver and knob adjustment

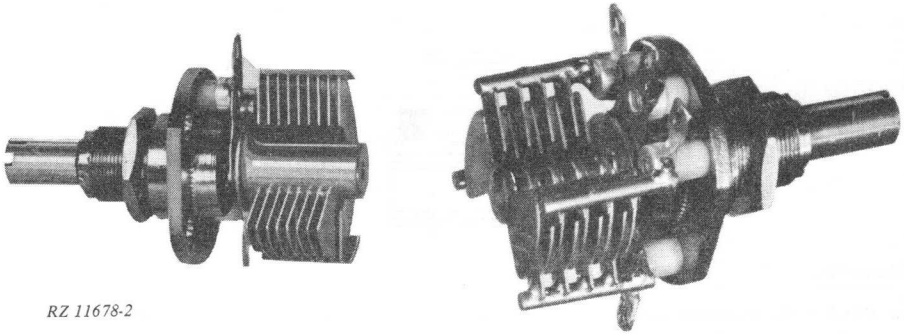

RZ 11678-2

Capacitance swing	
single-stator type	2.5, 4, 6.4, 10, 16, 25, 40, 64, 100 pF
split-stator type	1.6, 4, 10 pF
differential type	2.5, 10, 40 pF
Connections	soldering tags

APPLICATION

For fine adjustment of capacitance. Three types are available: single-stator, split-stator and differential capacitors.

Single-stator capacitors are suitable for capacitance adjustment in tuned circuits, split-stator capacitors for capacitance adjustment in symmetrically built tuned circuits and differential types for capacitive volume or voltage control.

CONSTRUCTION

- Base** : nickel-plated brass with pressed-in siliconised ceramic stator supports.
- Rotor** : brass vanes soldered on a shaft, which has a double-race ball-bearing and is slotted for screw-driver operation (0.8 mm width, 1.2 mm depth). Friction springs assure a stable torque. The 6 mm ϕ shaft can also be fitted with a control knob. The single-stator and the differential types are available with an insulated or a non-insulated rotor.
- By rotation of the rotor of the split-stator types, the capacitance of either pack of each pair increases or decreases to the same degree.
- By rotation of the rotor of the differential types, the capacitance of one pack increases to the same degree as that of the other decreases.
- Stator** : brass vanes soldered to brass studs which are fixed to the ceramic supports of the base.

Dimensions in mm

For L see table on next page.

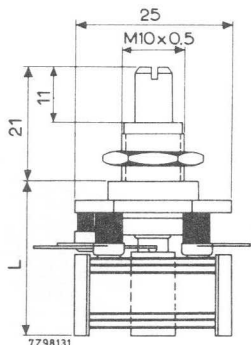
Mounting

In a hole with a diameter of 10.5 mm, in a maximum 4 mm thick panel, by means of a nut supplied with each capacitor.

TECHNICAL PERFORMANCE

Tolerance on capacitance swing

+ 10% with a minimum of 1 pF

Accuracy of adjustment

better than 0.01% of the capacitance swing
with a minimum of 0.003 pF

Test voltage

2000 V_{dc}

(stator and rotor insulated)

Maximum working voltage

75% of test voltage (see table)

Insulation resistance

> 10 000 M Ω

(insulated version)

Contact resistance

< 3 m Ω

(between soldering tag and rotor)

Permissible temperature range

-40 to + 85 °C

Temperature coefficient

25 ppm/deg C

at 2/3 of the maximum capacitance

approximately 180°

Effective angle of rotation

1.5-4 Ncm

Torque

40/085/21

Category (I.E.C. 68)

Also in accordance with equivalent MIL
requirements.

type	capacitance swing (pF)	zero capacitance (pF)	test voltage (V _{dc})	L (mm)	catalog number 2222 804	
					non- insulated rotor	insulated rotor
single- stator	2.5	≤ 2.5	1500	23	15001	15017
	4	≤ 2.5	1500	23	15002	15018
	6.4	≤ 3	1500	23	15003	15019
	10	≤ 3	1000	23	15004	15021
	16	≤ 3 } 1)	1000 } 1)	23	15005	15022
	25	≤ 4	1000	28	15006	15023
	40	≤ 4	800	28	15007	15024
	64	≤ 4	800	28	15008	15025
	100	≤ 4	650	28	15009	15026
split- stator	1.6	≤ 1.5	2000	23		15027
	4	≤ 2.0 } 2)	1250 } 2)	28		15028
	10	≤ 2.5	800	28		15029
diffe- rential	2.5	≤ 2.5	1500	23	15014	15031
	10	≤ 3 } 3)	800 } 3)	23	15015	15032
	40	≤ 4	800	28	15016	15033

1) Measured between stator and rotor.

2) Measured between the two stators.

3) Measured between stators and rotor.

Versions for other voltages, with different capacitance values and with different shaft lengths are available on request.

PACKING

The capacitors are packed in transparent plastic boxes (5 capacitors per box).

180 100 100

CONCENTRIC AIR DIELECTRIC TRIMMERS (ϕ 1/2")

screw-driver or trim-key adjustment

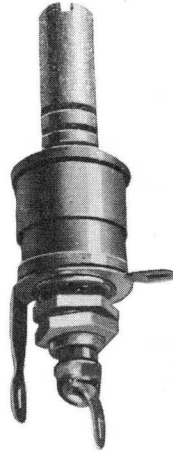
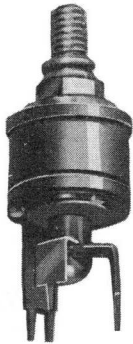
Capacitance swing
Connections6.4, 10, 16, 25 pF
soldering tags and printed-wiring pins

APPLICATION

For adjusting h.f. tuned circuits if very small changes in capacitance and a high degree of stability are required.

CONSTRUCTION

Rotor and stator: extruded aluminium, consisting of concentric rings separated by air gaps. Rotor provided with hexagonal or slotted shaft for trim-key or screw-driver adjustment.

Types with soldering tags and types with pins for mounting on printed-wiring boards are available.

Dimensions in mm

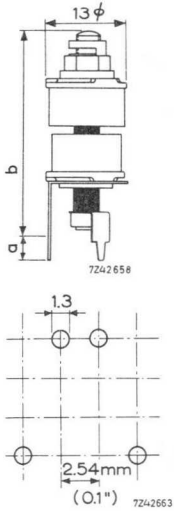

Type with printed-wiring pins; trim-key adjustment.

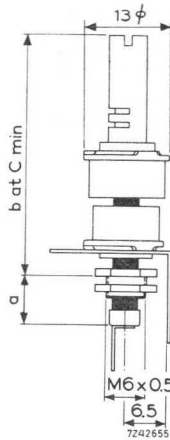

Type with soldering tags and insulated rotor; screw-driver adjustment.

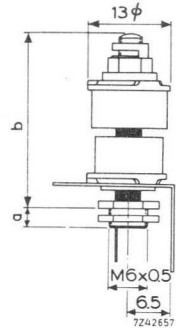

Type with soldering tags and non-insulated rotor; trim-key adjustment.

type		max. dimensions (mm)		cat. number 2222 804			
		below chassis (a)	above chassis (b)	6.4 pF	10 pF	16 pF	25 pF
with tags, trim-key adjustment	non-insulated rotor	3.5	27	20021	20022	20023	20024
	insulated rotor	7.5	27	20001	20002	20003	20004
with tags, screw-driver adjustment	non-insulated rotor	3.5	41.5	20031	20032	20033	20034
	insulated rotor	7.5	41.5	20011	20012	20013	20014
with p.w. pins, trim-key adjustment	non-insulated rotor	3.5	29	20041	20042	20043	20044
with p.w. pins, screw-driver adjustment	non-insulated rotor	3.5	43.5	20051	20052	20053	20054

Mounting

- a. By means of an M6 nut and a fixture which is insulated or non-insulated from the spindle end.
- b. For insertion mounting on printed-wiring boards the types with a sturdy 4-point fixation are used, which prevents wrong insertion and permits automatic dip soldering. The double rotor connection allows "jumping" of the earth conductor, and so a more efficient use of the board area.

TECHNICAL PERFORMANCE

Minimum capacitance swing	6.4	10	16	25	pF
Maximum zero capacitance	3.5	3.5	3.5	3.5	pF
Temperature coefficient	40 \pm 100	30 \pm 75	20 \pm 75	10 \pm 50	ppm/deg C
Maximum permissible working voltage	500	325	250	250	V _{dc}
Test voltage for 1 min	1000	650	500	500	V _{dc}
Permissible temperature range	-40 to + 85 °C				
Minimum insulation resistance	10 000 M Ω				
Maximum contact resistance	3 m Ω				
Minimum parallel damping at 1.5 MHz and max. capacitance	10 M Ω				
Operating torque	0.5 - 6.5 Ncm				
Maximum axial load on the rotor during operation	5 N				
Weight	5.5 - 8.5 g				
Solderability	in conformity with I.E.C.68, test T				
Effective angle of rotation	4 x 360°				
Accuracy of adjustment	better than 0.02 pF				
Tolerance on capacitance swing	+ 20%				
Category (I.E.C. 68)	40/085/21				
	Also in accordance with equivalent MIL requirements.				

PACKING

The trimmers are packed in "blisterpacking" (50 trimmers per packing).

PRECISION TUNING CAPACITORS

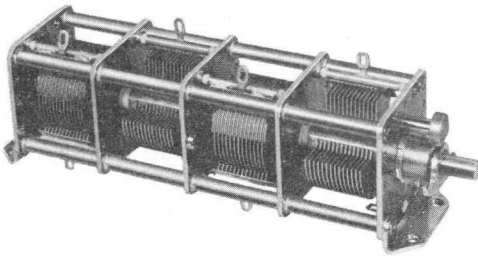

37482-57

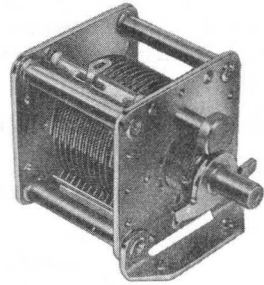

6486/19

APPLICATION

These air dielectric capacitors are applicable where a high accuracy of adjustment and a high degree of stability are required. They are available with one to four gangs.

TYPES		40 x 40 mm linear law		60 x 60 mm	
		standard torque	heavy torque* spindle end slotted	linear law	logarithmic law
single stator	non insulated	16 - 250 pF		100-640 pF	100-500 pF
1-4 gangs	insulated	16 - 250 pF		100-640 pF	100-500 pF
split stator	non insulated	6.4 - 64 pF		25-125 pF	
1-4 gangs	insulated	6.4 - 64 pF		25-125 pF	
differen- tial	non insulated	16 - 160 pF			
1 gang	insulated	16 - 160 pF			

* for 1 gang capacitor only

Law and ganging tolerances $\pm 0.7\%$

CONSTRUCTION

Frame

Nickel-plated brass plates and bars, assembled by riveting and soldering.

Shaft

Ball bearings on both ends.

- a. Non-insulated version: one piece brass shaft.
- b. Insulated version: brass sections separated by ceramic bars.

Rotor

Clean brass vanes soldered to the shaft.

Stator

Clean brass vanes supported and insulated by siliconized ceramic balls.

Protruding shaft end

Diameter 6 mm, standard free length 10 and 14.5 mm for (40x40 mm) version and (60x60 mm) version respectively.

Direction of rotation

Clockwise for increasing capacitance.

Angle of rotation

180° or 360° at choice.

Owing to the eccentric rotor vanes, the versions with logarithmic laws have 180° as maximum angle of rotation.

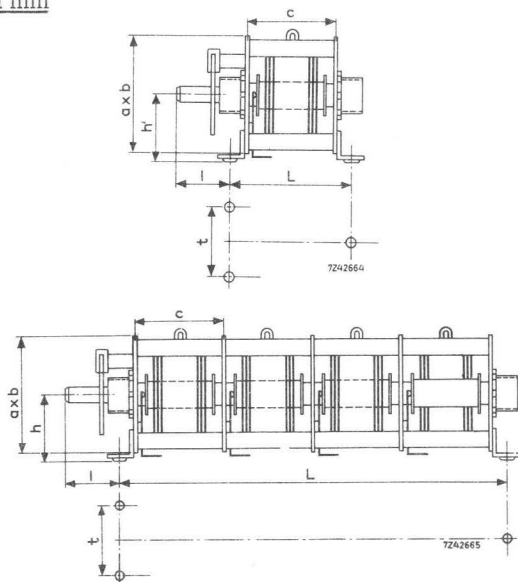
Dimensions in mm

dimensions in mm		a x b	number of gangs					
			normal gap				wide gap	
			1	2	3	4	1	2
distance between mounting holes (± 0.5)	L	40 x 40 60 x 60	45 67	76.5 117.5	108 168	139.5 218.5	65 103	116.5 189.5
	t	40 x 40 60 x 60	22 35					
compartment length (± 0.2)	c	40 x 40 60 x 60	31.5 50.5				51.5 86.5	
shaft length (± 0.5)	l	40 x 40 60 x 60	16 18					
shaft height (± 0.5)	h	40 x 40 60 x 60	22.5 32.5					

High stability and freedom from noise are obtained by soldering all the metal parts together. Low contact resistance is ensured by silver contact points on the rotor drag spring.

Silicone treated ceramics are used exclusively for insulation ensuring that the insulation resistance is high and the losses are low, even in humid conditions. The resistance to shock and vibration is high as the stator is insulated with ceramic ball-bearings. Ceramic spindles, included in versions with insulated rotors, are able to withstand severe impact and vibration.

The standard spindle end is provided with a detent which, together with a removable stop on the front plate, permits the accurate setting of a rotation angle of 15° as a reference for checking the capacitance and its variation as a function of rotation. For rotation angles of 165° and above, the stop should be removed.

Single capacitors of the (40x40 mm) version for direct drive operation have the spindle end slotted for screwdriver adjustment.

The capacitors are built entirely of basic parts with symmetrically placed stator and rotor packs. Non-listed combinations having non-standard capacitances, extra compartments, thicker and/or longer spindle ends (protruding up to 50 mm from both faces) and different connections, can be obtained if required.

TECHNICAL PERFORMANCE

Nominal capacitance swing	see C_{var} in table I
Maximum capacitance at 0°	see C_0 in table I
Test voltage	see V_{test} in table I
Permissible peak voltage	$\leq \frac{1}{2} V_{test}$

TABLE I

size a x b = 40 x 40 mm, linear capacitance law

single-stator or differen- tial type ¹⁾	C_{var}		16	25	40	64	100	160	250	pF
	$C_0 \pm 1$ pF ²⁾	normal gap	8	8.5	9	9	10	11	11.5	pF
		wide gap			14	15	15.5	16	18.5	pF
V_{test} ³⁾	normal gap	2500	2000	1500	1000	1000	800	650	V_{dc}	
	wide gap			2500	2000	1250	1000	800	V_{dc}	
split-stator type	C_{var}		6.4	10	16	25	40	64		pF
	$C_0 \pm 1$ pF	normal gap	3	3	3.6	4	4	4		pF
		wide gap		4	4.5	4.5	5	5		pF
V_{test} ⁴⁾	normal gap	4000	3000	2000	2000	1600	1300		V_{dc}	
	wide gap		4000	3000	2500	2000	1600		V_{dc}	

size a x b = 60 x 60 mm, linear capacitance law

single-stator type	C_{var}		100	125	160	200	250	320	400	500	640	pF
	$C_0 \pm 1$ pF	normal gap	14.5	15	15.5	16	16	17.5	19	20.5	21.5	pF
		wide gap				26	26.5	27.5	28	29.5	30.5	pF
V_{test} ³⁾	normal gap	2000	2000	1500	1250	1250	1000	1000	1000	800	V_{dc}	
	wide gap				2000	2000	1500	1250	1250	1000	V_{dc}	
split-stator type	C_{var}		25	32	40	50	64	80	100	125		pF
	$C_0 \pm 1$ pF	normal gap	5	5	5	5	5.5	5.5	5.5	6		pF
		wide gap				7	8.5	8	8	8		pF
V_{test} ⁴⁾	normal gap	4000	3000	3000	2500	2000	2000	2000	1600		V_{dc}	
	wide gap				4000	4000	3000	2500	2500		V_{dc}	

¹⁾ Differential type only up to and including $C_{var} = 160$ pF.

²⁾ For the differential version the C_0 values are 1 pF less than the tabulated values.

³⁾ Between rotor and stator.

⁴⁾ Between the two stators.

size a x b = 60 x 60 mm, logarithmic capacitance law

single-stator type	C_{var}		100	125	160	200	250	320	400	500	pF	
	$C_0 \pm 1$ pF	normal gap	13	13	14.5	14.5	14	14	14	14	14	pF
		wide gap				23	22.5	22.5	22.5	21.5	21.5	pF
V_{test} 3)	normal gap	1500	1250	1000	1000	1000	800	800	650	650	V _{dc}	
	wide gap				1500	1250	1000	1000	1000	800	V _{dc}	
split-stator type	C_{var}		25	32	40	50	64	80	100	125	pF	
	$C_0 \pm 1$ pF	normal gap	5	5	5.5	5.5	5.5	5.5	5.5	5.5	5.5	pF
		wide gap				6.5	6.5	6.5	7	6.5	6.5	pF
V_{test} 4)	normal gap	2500	2500	2000	2000	1600	1600	1600	1300	1300	V _{dc}	
	wide gap				2500	2500	2000	2000	2000	1600	V _{dc}	

3) Between rotor and stator.

4) Between the two stators.

Coupling capacitance

between stator packs	≤ 0.02 pF
between rotor packs (if insulated)	≤ 0.05 pF

Insulation resistance between
stator and rotor and between
frame and stator and rotor $> 10\,000$ M Ω

Contact resistance

between any soldering tag and the relative rotor pack	≤ 5 m Ω
--	---------------------

Parallel damping at 1.5 MHz

with 50 pF (or max. capacitance if < 50 pF)	> 10 M Ω
--	-------------------

Temperature coefficient of capacitance for the first compartment, (at $C = 1/3$
cap. swing + capacitance at 15°) in ppm/deg C.

version	40 x 40 mm	60 x 60 mm
single	20 ± 20	30 ± 30
double	20 ± 20	30 ± 30
triple	30 ± 30	50 ± 50
quadruple	50 ± 50	50 ± 50

Capacitance law

angle of rotation	capacitance increase (% of capacitance swing)	
	linear law	logarithmic law
15°	0	0
20°	3.12	0.83
30°	9.38	2.68
40°	15.62	4.81
50°	21.88	7.28
70°	34.38	13.41
90°	46.88	21.58
110°	59.38	32.49
130°	71.88	47.03
150°	84.38	66.42
175°	100	100

Capacitance tolerance

For angles of rotation between 15° and 175°, the capacitance tolerance in the first compartment is given by the expression:

$$\pm 0.7 (0.11 C + C')/100$$

where

C = capacitance swing (minimum 25 pF)

C' = capacitance increase calculated from the capacitance law.

Ganging tolerance (rotation angles between 15° and 175°)

The capacitance in the second, third, and fourth compartments will not differ from the actual capacitance in the first compartment by more than $\pm 0.7\%$.

Backlash

(for indirect drive capacitors)

Better than 150×10^{-6} pF/pF

Temperature range

-40 to +85 °C

MECHANICAL DATA

Operating torque	single		double	triple	quadruple	
	direct drive	indirect drive				
Minimum	2					Ncm
Maximum	5	2	2.5	3	3.5	Ncm
Maximum axial thrust					50	N
Direction of rotation for increase in capacitance					Clockwise	
Effective angle of rotation, linear capacitor					360	deg
					logarithmic capacitor	180 deg

Mounting

The capacitors can be mounted by means of screws passed through the three holes in the mounting brackets.

In many applications it may be advantageous to use a vernier control knob.

Connecting leads

Two wires of 1.5 mm² maximum diameter can be connected to each soldering tag.

Weight

version		number of gangs	weight in g	
			normal gap	wide gap
40 x 40 mm	single stator split stator	1	120	170
		2	200	300
		3	300	-
		4	400	-
	differential	1	140	190
60 x 60 mm	single stator split stator	1	400	550
		2	700	1000
		3	1000	-
		4	1300	-

CATALOG NUMBERS (40 x 40 mm) VERSION

Single stator, 1 gang

Catalog number 2222 805 00...

C _{var} (pF)	catalog number suffix			
	direct drive		indirect drive	
	non insulated	insulated	non insulated	insulated
16	043	173	001	131
25	044	178	002	132
40	045	174	003	133
40 (wide gap)	051	181	032	162
64	046	175	004	134
64 (wide gap)	052	182	033	163
100	047	176	005	135
100 (wide gap)	053	183	034	164
160	048	177	006	136
160 (wide gap)	054	184	035	165
250	049	179	007	137
250 (wide gap)	055	185	036	166

Single stator, 2 gangs

Catalog number 2222 805 00...

C _{var} (pF)	catalog number suffix	
	non insulated	insulated
2 x 16	008	138
2 x 25	009	139
2 x 40	011	141
2 x 40 (wide gap)	037	167
2 x 64	012	142
2 x 64 (wide gap)	038	168
2 x 100	013	143
2 x 100 (wide gap)	039	169
2 x 160	014	144
2 x 160 (wide gap)	041	171
2 x 250	015	145
2 x 250 (wide gap)	042	172

CATALOG NUMBERS (40 x 40 mm) VERSION

Single stator, 3 gangs

Catalog number 2222 805 00...

C _{var} (pF)	catalog number suffix	
	non insulated	insulated
3 x 16	016	146
3 x 25	017	147
3 x 40	018	148
3 x 64	019	149
3 x 100	021	151
3 x 160	022	152
3 x 250	023	153

Single stator, 4 gangs

Catalog number 2222 805 00...

C _{var} (pF)	catalog number suffix	
	non insulated	insulated
4 x 16	024	154
4 x 25	025	155
4 x 40	026	156
4 x 64	027	157
4 x 100	028	158
4 x 160	029	159
4 x 250	031	161

CATALOG NUMBERS (40 x 40 mm) VERSION

Split stator, 1 gang

Catalog number 2222 805 00...

C _{var} (pF)	catalog number suffix			
	direct drive		indirect drive	
	non insulated	insulated	non insulated	insulated
6.4	094	224	056	186
10	095	225	057	187
10 (wide gap)	101	231	083	213
16	096	226	058	188
16 (wide gap)	102	232	084	214
25	097	227	059	189
25 (wide gap)	103	233	085	215
40	098	228	061	191
40 (wide gap)	104	234	086	216
64	099	229	062	192
64 (wide gap)	105	235	087	217

Split stator, 2 gangs

Catalog number 2222 805 00...

C _{var} (pF)	catalog number suffix	
	non insulated	insulated
2 x 6.4	063	193
2 x 10	064	194
2 x 10 (wide gap)	088	218
2 x 16	065	195
2 x 16 (wide gap)	089	219
2 x 25	066	196
2 x 25 (wide gap)	091	221
2 x 40	067	197
2 x 40 (wide gap)	092	222
2 x 64	068	198
2 x 64 (wide gap)	093	223

CATALOG NUMBERS (40 x 40 mm) VERSION

Split stator, 3 gangs

Catalog number 2222 805 00...

C_{var} (pF)	catalog number suffix	
	non insulated	insulated
3 x 6.4	069	199
3 x 10	071	201
3 x 16	072	202
3 x 25	073	203
3 x 40	074	204
3 x 64	075	205

Split stator, 4 gangs

Catalog number 2222 805 00...

C_{var} (pF)	catalog number suffix	
	non insulated	insulated
4 x 6.4	076	206
4 x 10	077	207
4 x 16	078	208
4 x 25	079	209
4 x 40	081	211
4 x 64	082	212

Differential type, 1 gang

Catalog number 2222 805 00...

C_{var} (pF)	catalog number suffix			
	direct drive		indirect drive	
	non insulated	insulated	non insulated	insulated
16	118	248	106	236
25	119	249	107	237
40	121	251	108	238
40 (wide gap)	125	255	113	243
64	122	252	109	239
64 (wide gap)	126	256	114	244
100	123	253	111	241
100 (wide gap)	127	257	115	245
160	124	254	112	242
160 (wide gap)	128	258	116	246
250 (wide gap)	129	259	117	247

CATALOG NUMBERS (60 x 60 mm) VERSION

Single stator, 1 gang

Catalog number 2222 805 02...

C_{var} (pF)	catalog number suffix			
	linear law		logarithmic law	
	non insulated rotor	insulated rotor	non insulated rotor	insulated rotor
100	001	196	054	249
125	002	197	055	251
160	003	198	056	252
200	004	199	057	253
200 (wide gap)	041	236	089	285
250	005	201	058	254
250 (wide gap)	042	237	091	286
320	006	202	059	255
320 (wide gap)	043	238	092	287
400	007	203	061	256
400 (wide gap)	044	239	093	288
500	008	204	062	257
500 (wide gap)	045	241	094	289
640	009	205		
640 (wide gap)	046	242	095	291

CATALOG NUMBERS (60 x 60 mm) VERSION

Single stator, 2 gangs

Catalog number 2222 805 02...

C _{var} (pF)	catalog number suffix			
	linear law		logarithmic law	
	non insulated rotor	insulated rotor	non insulated rotor	insulated rotor
2 x 100	011	206	063	258
2 x 125	012	207	064	259
2 x 160	013	208	065	261
2 x 200	014	209	066	262
2 x 200 (wide gap)	047	243	096	292
2 x 250	015	211	067	263
2 x 250 (wide gap)	048	244	097	293
2 x 320	016	212	068	264
2 x 320 (wide gap)	049	245	098	294
2 x 400	017	213	069	265
2 x 400 (wide gap)	051	246	099	295
2 x 500	018	214	071	266
2 x 500 (wide gap)	052	247	101	296
2 x 640	019	215	-	-
2 x 640 (wide gap)	053	248	102	297

Single stator, 3 gangs

Catalog number 2222 805 02...

C _{var} (pF)	catalog number suffix			
	linear law		logarithmic law	
	non insulated rotor	insulated rotor	non insulated rotor	insulated rotor
3 x 100	021	216	072	267
3 x 125	022	217	073	268
3 x 160	023	218	074	269
3 x 200	024	219	075	271
3 x 250	025	221	076	272
3 x 320	026	222	077	273
3 x 400	027	223	078	274
3 x 500	028	224	079	275
3 x 640	029	225		

CATALOG NUMBERS (60 x 60 mm) VERSION

Single stator, 4 gangs

Catalog number 2222 805 02...

C _{var} (pF)	catalog number suffix			
	linear law		logarithmic law	
	non insulated rotor	insulated rotor	non insulated rotor	insulated rotor
4 x 100	031	226	081	276
4 x 125	032	227	082	277
4 x 160	033	228	083	278
4 x 200	034	229	084	279
4 x 250	035	231	085	281
4 x 320	036	232	086	282
4 x 400	037	233	087	283
4 x 500	038	234	088	284
4 x 640	039	235		

Split stator, 1 gang

Catalog number 2222 805 02...

C _{var} (pF)	catalog number suffix			
	linear law		logarithmic law	
	non insulated rotor	insulated rotor	non insulated rotor	insulated rotor
25	103	298	149	345
32	104	299	151	346
40	105	301	152	347
50	106	302	153	348
50 (wide gap)	138	334	185	381
64	107	303	154	349
64 (wide gap)	139	335	186	382
80	108	304	155	351
80 (wide gap)	141	336	187	383
100	109	305	156	352
100 (wide gap)	142	337	188	384
125	111	306	157	353
125 (wide gap)	143	338	189	385

CATALOG NUMBERS (60 x 60 mm) VERSION

Split stator, 2 gangs

Catalog number 2222 805 02...

C _{var} (pF)	catalog number suffix			
	linear law		logarithmic law	
	non insulated rotor	insulated rotor	non insulated rotor	insulated rotor
2 x 25	112	307	158	354
2 x 32	113	308	159	355
2 x 40	114	309	161	356
2 x 50	115	311	162	357
2 x 50 (wide gap)	144	339	191	386
2 x 64	116	312	163	358
2 x 64 (wide gap)	145	341	192	387
2 x 80	117	313	164	359
2 x 80 (wide gap)	146	342	193	388
2 x 100	118	314	165	361
2 x 100 (wide gap)	147	343	194	389
2 x 125	119	315	166	362
2 x 125 (wide gap)	148	344	195	391

Split stator, 3 gangs

Catalog number 2222 805 02...

C _{var} (pF)	catalog number suffix			
	linear law		logarithmic law	
	non insulated rotor	insulated rotor	non insulated rotor	insulated rotor
3 x 25	121	316	167	363
3 x 32	122	317	168	364
3 x 40	123	318	169	365
3 x 50	124	319	171	366
3 x 64	125	321	172	367
3 x 80	126	322	173	368
3 x 100	127	323	174	369
3 x 125	128	324	175	371

CATALOG NUMBERS (60 x 60 mm) VERSION

Split stator, 4 gangs

Catalog number 2222 805 02...

C _{var} (pF)	catalog number suffix			
	linear law		logarithmic law	
	non insulated rotor	insulated rotor	non insulated rotor	insulated rotor
4 x 25	129	325	176	372
4 x 32	131	326	177	373
4 x 40	132	327	178	374
4 x 50	133	328	179	375
4 x 64	134	329	181	376
4 x 80	135	331	182	377
4 x 100	136	332	183	378
4 x 125	137	333	184	379

FILM DIELECTRIC TRIMMERS

screw-driver adjustment

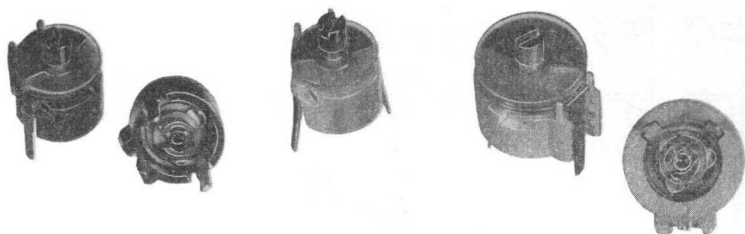

RZ 20532-1

Maximum capacitance
Mounting

$\geq 3.5, 5.5, 10, 22, 40, 65$ pF
on printed-wiring board

APPLICATION

These film dielectric trimmers have been designed to be used on printed-wiring boards in e.g. radio sets. Moreover, thanks to their good stability, these trimmers have proved their value in miniaturised industrial equipment.

CONSTRUCTION

The vanes are stacked on a sturdy plastic base. As a dielectric plastic is used which support the vanes in such a way that a very good stability has been obtained*). The plastic materials used are resistant against all standard cleaning agents. Types with a screw-driver slot at the top of the rotor as well as types with a screw-driver slot at both ends of the rotor are available. The connection pins are arranged so as to fit a grid of 0.1 inch.

*) For temperatures up to 125 °C capacitors with a polysulphone base and P.T.F.E. film as a dielectric can be supplied on request.

2222 808 000..
 2222 808 010..
 2222 808 91503

FILM DIELECTRIC TRIMMERS
 screw-driver adjustment

Dimensions in mm

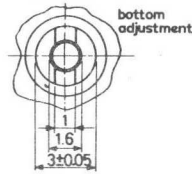
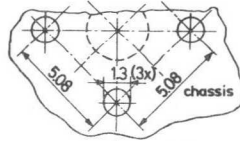
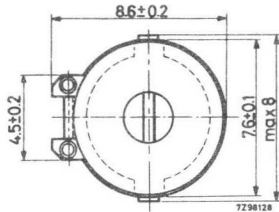
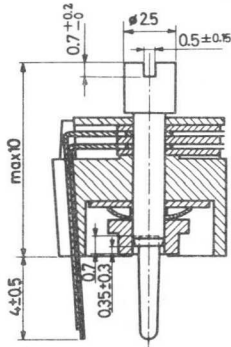

2222 808 00004 }
 00005 } top adjustment
 00006 }
 00014 }

2222 808 00011 }
 00012 } top and
 00013 } bottom adjustment

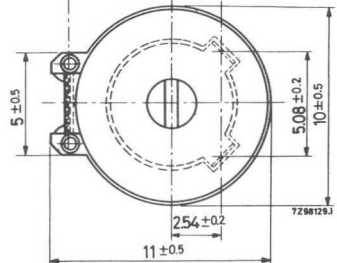
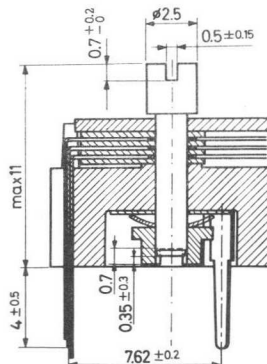

2222 808 01001 }
 91503 } top adjustment

2222 808 01004 }
 91504 } top and bottom
 adjustment

3325 808 6001
3325 808 610
3325 808 615

FILM DIELECTRIC TRIMMERS

high temperature type

QUICK REFERENCE DATA		
Max. C_{\min} /min. C_{\max}	1 / 3.5	pF
	1.8 / 10	pF
	2 / 18	pF
Overall dimensions	6 x 8 x 9 mm	
Rated voltage	300 V d. c.	
Temperature range	- 40 to + 125 °C	

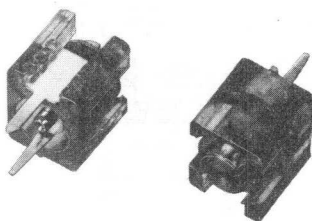

RZ 24851-6

APPLICATION

For use in miniaturised measuring and telecommunication equipment, specially where high temperatures occur and a low temperature coefficient is important, e.g. for fine adjustment of h. f. tuned circuits.

DESCRIPTION

The trimmers consist of a polysulphone housing, brass rotor and silver-plated brass stator with either a P. T. F. E., or a polyimide/F. E. P. sandwich film as the dielectric. The stator plates with their tag are heat sealed to the housing. The rotor contact surfaces are gold plated to ensure a long life and a stable contact even under severe climatic conditions.

The capacitors can be supplied with top adjustment, and with top and bottom adjustment. Top adjustment should be done by means of a screwdriver, bottom adjustment by means of the key, catalogue number 8122 088 23660.

MECHANICAL DATA

Dimensions in mm

type with
top adjustment

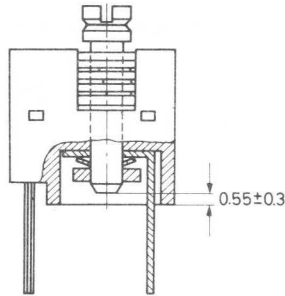

type with
top and
bottom adjustment

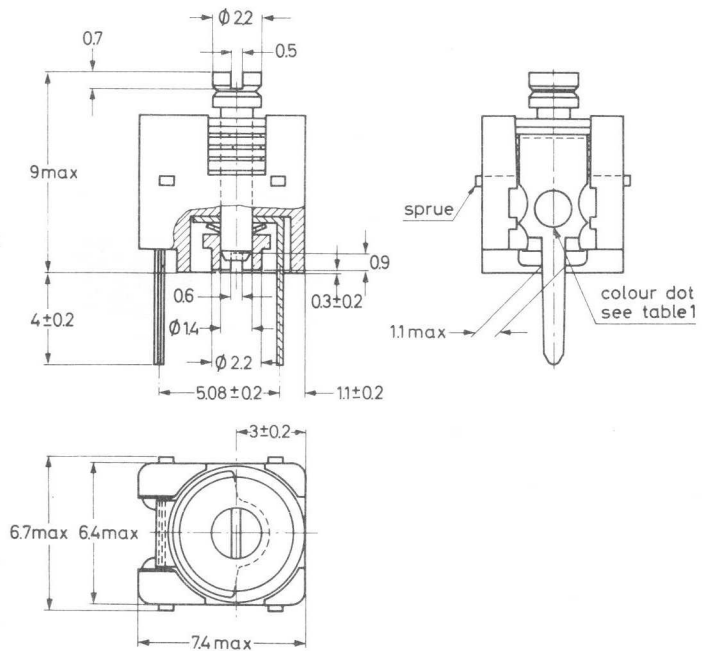

Table 1

max. capacitance	3.5 pF	10 pF	18 pF
effective angle of rotation	180°	180°	180°
operating torque	0.1 to 1.5 Ncm	0.25 to 2.0 Ncm	0.25 to 2.0 Ncm
maximum axial load	2 N	2 N	2 N
weight approx.	0.7 g	0.7 g	0.7 g
colour dot	orange	white	red

Marking

The capacitors are marked with a colour dot, see Table 1.

Mounting

The trimmers can be mounted on printed-wiring boards having holes with a minimum diameter of 1.25 mm. The hole patterns are given in the figures below.

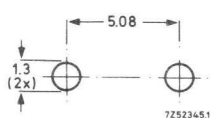

Hole pattern for
type with top ad-
justment

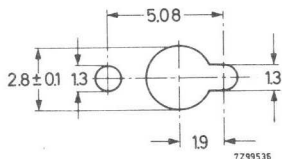

Hole pattern for
type with top and
bottom adjustment

Soldering conditions

max. 240 °C, max. 5 s

Bending the tags by 90 degrees is permitted

ELECTRICAL DATA

C _{max} (pF)	C _{min} (pF)	max. tan δ at 1 MHz	max. tan δ at 100 MHz	temperature coefficient *) (ppm/degC)	catalogue number	
					top adjustment	top + bottom adjustment
≥ 3,5	≤ 1	10 · 10 ⁻⁴	20 · 10 ⁻⁴	-250 ± 150	2222 809 05001	2222 809 05004
≥ 10	≤ 1.8	10 · 10 ⁻⁴	20 · 10 ⁻⁴	-250 ± 75	2222 809 05002	2222 809 05005
≥ 18	≤ 2	25 · 10 ⁻⁴	40 · 10 ⁻⁴	-250 ± 75	2222 809 05003	2222 809 05006

Rated voltage

300 V d. c.

Test voltage

600 V d. c.

Contact resistance

max. 5 mΩ

Insulation resistance

between stator and rotor

min. 10000 MΩ

Category temperature range

-40 to +125 °C

Climatic category (IEC 68)

40/125/21

PACKAGING

In blisters containing 100 capacitors, 9 blisters per box.

*) between +20 and +70 °C at C_{max}

1880 1881 1882

1880
1881
1882
1883
1884
1885

FILM DIELECTRIC TRIMMERS

high temperature type

QUICK REFERENCE DATA	
Max. C_{\min} /min. C_{\max} , single stator type	2.5/20 pF to 7/100 pF
split stator type	1.5/5 pF to 3/25 pF
differential type	2.5/20 pF to 7/100 pF
Overall dimensions	11 x 14 x 9 mm
Rated voltage	200 to 375 V d. c.
Temperature range	-40 to +150 °C

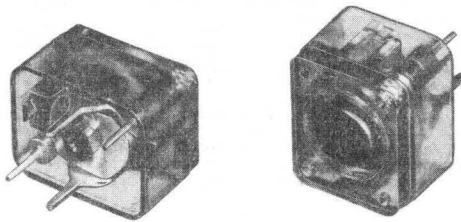

RZ 24762-1

APPLICATION

For use in miniaturised measuring and telecommunication equipment, specially where high temperatures occur and a low temperature coefficient is important, e.g. single-stator trimmers are suitable for fine adjustment of h. f. tuned circuits, split-stator trimmers for symmetrically built h. f. circuits and differential types for capacitive volume or voltage control.

DESCRIPTION

The trimmers consist of a polysulphone housing, brass rotor and stator with P. T. F. E. film as the dielectric. The stator plates are stacked on pins and separated by rings, so that it is possible to produce a single-stator, a split-stator or a differential type. The rotor contact surfaces are silver plated to ensure a long life and a stable contact even under severe climatic conditions.

The capacitors can be adjusted from the top by means of a screwdriver.

MECHANICAL DATA

Dimensions in mm

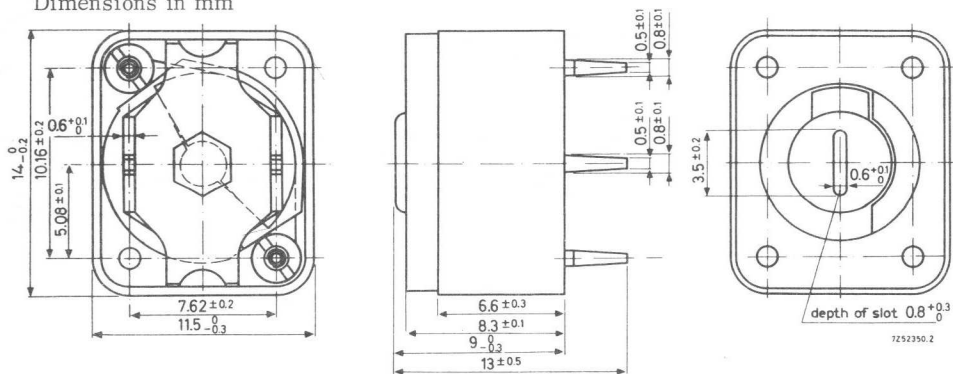

	single stator type	differential type	split stator type
effective angle of rotation	180°	180°	90°
operating torque	1 to 3.5 Ncm	1 to 3.5 Ncm	1 to 3.5 Ncm
max. axial load	2N	2N	2N
weight approx.	2.3 g	2.9 g	2.8 g

Marking

Capacitance value in pF plus letter E, in the case of a differential capacitor followed by the letter D, in the case of a split-stator type by the letter S.

Mounting

The trimmers can be mounted on printed-wiring boards having holes with a minimum diameter of 1.25 mm. The hole pattern is given in the figure below.

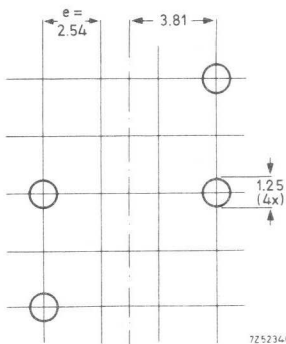

Soldering conditions
max. 240 °C, max. 5 s

Bending the tags by 90 degrees is not permitted.

ELECTRICAL DATA

type	max. cap. (pF)	min. cap. (pF)	max. tan δ at 100 MHz	test voltage (V _{dc})	catalogue number 2222 809
single-stator	≥ 20	≤ 2.5	$17 \cdot 10^{-4}$	700	07004
	≥ 40 *)	≤ 4	$17 \cdot 10^{-4}$	700	07008
	≥ 60 *)	≤ 5	$25 \cdot 10^{-4}$	400	07011
	≥ 80	≤ 6	$25 \cdot 10^{-4}$	400	07013
	≥ 100 *)	≤ 7	$25 \cdot 10^{-4}$	400	07015
split-stator	≥ 5	≤ 1.5	$17 \cdot 10^{-4}$	700	07001
	≥ 10	≤ 2	$17 \cdot 10^{-4}$	700	07002
	≥ 15	≤ 3	$25 \cdot 10^{-4}$	400	07003
	≥ 20	≤ 3	$25 \cdot 10^{-4}$	400	07005
	≥ 25	≤ 3	$25 \cdot 10^{-4}$	400	07007
differential	≥ 20	≤ 2.5	$17 \cdot 10^{-4}$	700	07006
	≥ 40	≤ 4	$17 \cdot 10^{-4}$	700	07009
	≥ 60	≤ 5	$25 \cdot 10^{-4}$	400	07012
	≥ 80	≤ 6	$25 \cdot 10^{-4}$	400	07014
	≥ 100	≤ 7	$25 \cdot 10^{-4}$	400	07016

Rated voltage	50% of test voltage (see Table)
Tan δ at 1 MHz	max. $10 \cdot 10^{-4}$
Contact resistance	max. 5 m Ω
Insulation resistance between stator and rotor	min. 10000 M Ω
Temperature coefficient (**)	(-200 \pm 200) ppm/degC
Ambient temperature range	-40 to +150 $^{\circ}$ C
Climatic category (IEC 68)	40/150/21

PACKAGING

In blisters containing 50 capacitors. 4 blisters per box.

*) Preferred versions.

***) Between +20 and +70 $^{\circ}$ C at C_{max}

STANDARD FORM NO. 101 (REV. 1-25-60)

UNITED STATES GOVERNMENT

FORM NO. 101

REV. 1-25-60

5010-108-01

GSA GEN. REG. NO. 27

STANDARD SERIES OF VALUES IN A DECADE for resistances and capacitances

according to I.E.C. publication 63

E192	E96	E48	E192	E96	E48	E192	E96	E48	E192	E96	E48	E192	E96	E48
100	100	100	169	169	169	284			481			816		
101			172			287	287	287	487	487	487	825	825	825
102	102		174	174		291			493			835		
104			176			294	294		499	499		845	845	
105	105	105	178	178	178	298			505			856		
106			180			301	301	301	511	511	511	866	866	866
107	107		182	182		305			517			876		
109			184			309	309		523	523		887	887	
110	110	110	187	187	187	312			530			898		
111			189			316	316	316	536	536	536	909	909	909
113	113		191	191		320			542			920		
114			193			324	324		549	549		931	931	
115	115	115	196	196	196	328			556			942		
117			198			332	332	332	562	562	562	953	953	953
118	118		200	200		336			569			965		
120			203			340	340		576	576		976	976	
121	121	121	205	205	205	344			583			988		
123			208			348	348	348	590	590	590			
124	124		210	210		352			597					
126			213			357	357		604	604				
127	127	127	215	215	215	361			612			10	10	10
129			218			365	365	365	619	619	619	11		
130	130					370			626			12	12	
132			221	221		374	374		634	634		13		
133	133	133	223			379			642			15	15	15
135			226	226	226	383	383	383	649	649	649	16		
137	137		229			388			657			18	18	
138			232	232		392	392		665	665		20		
140	140	140	234			397			673			22	22	22
142			237	237	237	402	402	402	681	681	681	24		
143	143		240			407			690			27	27	
145			243	243		412	412		698	698		30		
147	147	147	246			417			706			33	33	33
149			249	249	249	422	422	422	715	715	715	36		
150	150		252			427			723			39	39	
152			255	255		432	432		732	732		43		
154	154	154	258			437			741			47	47	47
156			261	261	261	442	442	442	750	750	750	51		
158	158		264			448			759			56	56	
160			267	267		453	453		768	768		62		
162	162	162	271			459			777			68	68	68
164			274	274	274	464	464	464	787	787	787	75		
165	165		277			470			796			82	82	
167			280	280		475	475		806	806		91		

Contents

	page
DATA HANDBOOK SYSTEM	2
FIXED RESISTORS	
Film resistors, Introduction	A3
Carbon film resistors CR16 CR25 CR37	
CR52 CR68 CR93	A7
Metal film resistors MR25 MR31 MR58	
MR30 MR39 MR81	A19
Insulated pin-head carbon resistors	2322 120 A33
Precision wire-wound resistors	2322 260-
	2322 264 A37
Low-ohmic glass-sealed wire resistors	2322 327 A41
Low-ohmic wire-wound resistors	2322 326 A43
Cemented wire-wound resistors	WR0617 WR0842
	WR0825 WR0865 A45
Enamelled wire-wound resistors	2322 320 A53
Wire-wound resistors with side terminations	2322 321
	2322 323 A57
Adjustable wire-wound resistors	2322 322
	2322 324 A61
VARIABLE RESISTORS	
<u>Wire-wound potentiometers</u>	
Wire-wound trimming potentiometers	2322 000 B3
Wire-wound potentiometers	2322 003
	2322 010 B7
Wire-wound potentiometers	2322 004 B13
Wire-wound trimming potentiometers	2322 011 B19
Wire-wound potentiometers	2322 012
	2322 013 B23
Load potentiometers	2322 095-
	2322 097 B29

Carbon potentiometers

Circuit and connections of the switches		B37
23 mm single carbon potentiometers	2322 350	
	2322 352-	
	2322 357	B39
23 mm tandem carbon potentiometers	2322 36.	B49
16 mm single carbon potentiometers	2322 380	
	2322 387-	
	2322 389	B59
Tandem carbon potentiometers	2322 390	B67
Miniature carbon trimming potentiometers	2322 410	B73
Carbon trimming potentiometers	2322 411	B77
Multiturn carbon pre-set potentiometers	2322 412	
	2322 413	B83
Miniature carbon potentiometers	2322 440	B95
Single carbon potentiometers	2322 450	B99
23 mm single carbon potentiometers	2322 460	B105
23 mm twin carbon potentiometers	2322 470	
	2322 476	B111

NON-LINEAR RESISTORS

NTC thermistors

Introduction		C5
Electrical properties		C7
How to measure NTC thermistors		C15
Choice of type		C17
Soldering disc NTC thermistors		C19
Applications		C21
NTC thermistors, standard disc types	2322 610	C27
NTC thermistors, for radio and television	2322 610	
	2322 619-622	C31
NTC thermistors, for motor cars	2322 611	C41
NTC thermistors, miniature types	2322 627	
	2322 634	C43
NTC thermistors, indirectly heated	2322 628	C49
NTC thermistors, standard rod types	2322 635	
	2322 636	
	2322 637	C59
NTC thermistors, standard disc types	2322 642 1....	C63
	2322 642 2....	C71
	2322 643	
	2322 644	C75
NTC thermistors, disc types	2322 644 90004	
	2322 644 90005	C79

	page
<u>PTC thermistors</u>	
Introduction	C89
Electrical properties	C91
Explanation of terms	C99
How to measure PTC thermistors	C103
Applications	C105
PTC thermistors,	2322 660 91006-
standard disc type	2322 660 91009 C111
PTC thermistors,	2322 661 91002-
standard disc type	2322 661 91005 C123
PTC thermistor	2322 662 91001 C131
PTC thermistor	2322 662 93036 C137
PTC thermistor	2322 662 93066 C143
PTC thermistors, for motor protection	2322 672 92046-
	2322 672 92053 C149
<u>Voltage dependent resistors (VDR)</u>	
Introduction	C161
Electrical properties	C163
How to measure VDR resistors	C177
Choice of type	C179
Asymmetric VDR resistors	C181
Applications	C183
Voltage dependent resistors,	
standard disc types with leads	2322 552 0 C187
	2322 553 0 C193
	2322 554 0 C199
	2322 555 0 C205
standard rod types	2322 564 C211
	2322 564 92003 C213
small disc types for special purposes	2322 565 C219
asymmetric types	2322 574 C221
disc types for contact protection	2322 575
	2322 576
	2322 577 C223
<u>Light dependent resistors (LDR)</u>	
Introduction	C227
Electrical properties	C229
How to measure LDR resistors	C231
Photometric concepts, definitions and units	C233
Applications	C239
Light dependent resistors	2322 600 C245

CERAMIC CAPACITORS

Ceramic capacitors, survey		D3
Tubular ceramic capacitors, class II	2222 552	
	2222 561	D5
Midget tubular ceramic capacitors, class 1C	2222 553	D9
Tubular ceramic capacitors, class 1B	2222 555	D13
Tubular ceramic capacitors, safety	2222 562	D17
Upright-mounting ceramic capacitors, class II	2222 563	
	2222 565	D21
Disc type ceramic capacitors, class 1B	2222 625	
	2222 626	D27
Disc type ceramic capacitors, class II	2222 627	D31
Miniature ceramic plate capacitors, class II	2222 629	
	2222 630	D33
Miniature ceramic plate capacitors, class 1B	2222 631-632	
	2222 638	
	2222 641-642	D41
Ceramic barrier layer capacitors	2222 675	D55
Ceramic feed-through capacitors	2222 700	
class I, class II	2222 702	D59

POLYESTER, POLYCARBONATE, POLYSTYRENE,
PAPER D.C., PAPER A.C., CAPACITORS

Metallised polyester capacitors, "flat film" type	2222 342	E3
Moulded metallised polyester capacitors, "nugget" type	2222 344	E13
Moulded metallised polyester capacitors, "mepolesco" type	2222 341	E25
Polyester capacitors, tubular foil type	2222 311	E37
Miniature polystyrene capacitors, "micropoco" type	2222 424	
	2222 425	E47
Tubular moulded polystyrene capacitors, "minipoco" type	2222 435-	
	2222 438	E51
Paper d.c. capacitors, rectangular box type	2222 230	E57
Paper d.c. capacitors, high tension types	2222 201	E61
Paper a.c. capacitors	2222 240	
	2222 241	E65
Metallised polycarbonate a.c. capacitors	2222 325	
	2222 326	
	2222 327	E71

ELECTROLYTIC CAPACITORS

Selection guide		F2
Miniature type, for general purposes (economy range)	2222 001 2222 002	F5
Miniature type, for general purposes	2222 001	F9
Wet aluminium types		
for general purposes (type 2)	2222 015-	
and for long life applications (type 1)	2222 017	F13
Small type, for general purposes	2222 023	F27
Small type, for high voltages	2222 040	F31
Large type, for general purposes	2222 060	F35
Mounting clamps 4322 043 03290 to 03330		F38
Large type, for high and low voltages	2222 065 - 2222 064 2222 080 - 2222 081	F39
Multiple types, for high voltages	2222 067 9.... 2222 063 9....	F55
Large long life type (I.E.C. type 1)	2222 071 - 2222 073	F57
Small long life type	2222 101	F69
Large long life type	2222 102 2222 103	F75
Large long life type (I.E.C. type 1)	2222 106 2222 107	F79
Mounting clamps 4322 043 04270 to 04290		F85
Small solid aluminium type	2222 121	F87
Miniature solid tantalum type	2222 142	F95
Solid tantalum type	2222 143	F99

VARIABLE CAPACITORS

Tubular ceramic trimmers		
screw-driver slot at both ends	2222 801 200..	G3
Midget tubular ceramic trimmers	2222 801 20051	
screw-driver slot at both ends	2222 801 20052	G7
Tubular ceramic trimmers	2222 801 96002	
screw-driver slot at both ends	2222 801 96003	G9
Tubular ceramic trimmers	2222 802 20001-	
screw-driver slot at both ends	2222 802 20005	G11
Tubular ceramic trimmers	2222 802 20011-	
with locking device	2222 802 20015	G15
Midget tubular ceramic trimmers	2222 802 96035	
screw-driver slot at both ends	2222 802 96036	G17
High stability tubular ceramic trimmers		
with friction locking device	2222 802 960..	G19

		page
VARIABLE CAPACITORS		
Air dielectric trimmers (14 x 17 mm)	2222 804 00001-	
screw-driver adjustment	2222 804 00011	G23
Air dielectric trimmers (17 x 20 mm)	2222 804 01001-	
screw-driver adjustment	2222 804 01026	G27
Air dielectric trimmers (20 x 24 mm)	2222 804 02001-	
screw-driver adjustment	2222 804 02026	G31
Air dielectric correcting capacitors (ϕ 25 mm)		
screw-driver and knob adjustment	2222 804 150..	G35
Concentric air dielectric trimmers (ϕ $\frac{1}{2}$ ")		
screw-driver or trim-key adjustment	2222 804 200..	G39
Precision tuning capacitors	2222 805	G43
Film dielectric trimmers	2222 808 000..	
screw-driver adjustment	2222 808 010..	
	2222 808 91503	G59
Film dielectric trimmers		
screw-driver adjustment	2222 809 050..	G63
Film dielectric trimmers		
screw-driver adjustment	2222 809 070	G67

STANDARD SERIES OF VALUES IN A DECADE FOR
RESISTANCES AND CAPACITANCES

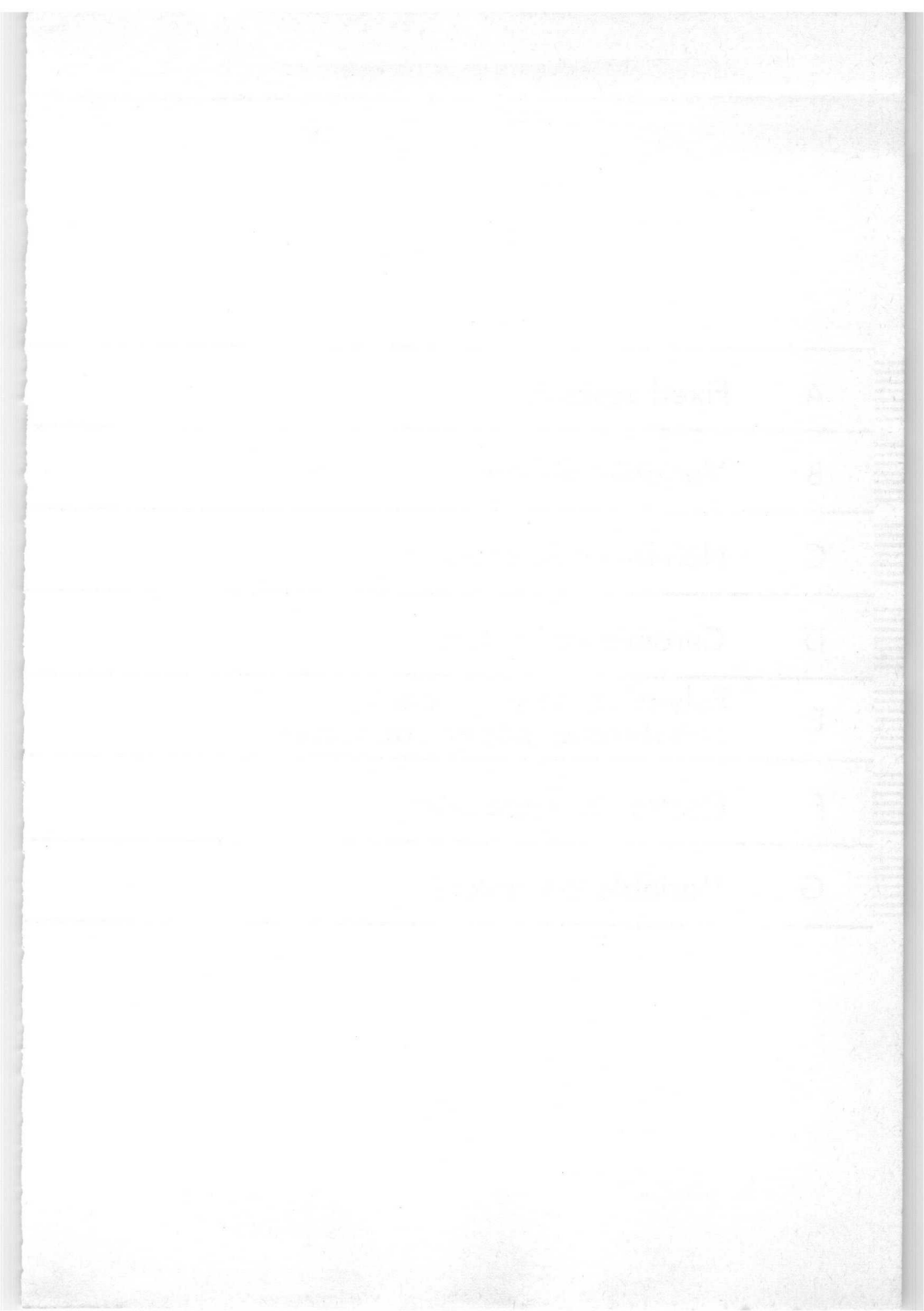



A Fixed resistors

B Variable resistors

C Non-linear resistors

D Ceramic capacitors

E Polyester, polycarbonate,
polystyrene, paper capacitors

F Electrolytic capacitors

G Variable capacitors

