

PHILIPS

Data handbook



Electronic
components
and materials

Electron tubes

Part 4 June 1972

Receiving tubes

Receiving tubes

1972

4

ELECTRON TUBES

Part 4

June 1972

General section

Receiving tubes

DATA HANDBOOK SYSTEM

To provide you with a comprehensive source of information on electronic components, subassemblies and materials, our Data Handbook System is made up of three series of handbooks, each comprising several parts.

The three series, identified by the colours noted, are:

ELECTRON TUBES (9 parts)	BLUE
SEMICONDUCTORS AND INTEGRATED CIRCUITS (6 parts)	RED
COMPONENTS AND MATERIALS (7 parts)	GREEN

The several parts contain all pertinent data available at the time of publication, and each is revised and reissued annually; the contents of each series are summarized on the following pages.

We have made every effort to ensure that each series is as accurate, comprehensive and up-to-date as possible, and we hope you will find it to be a valuable source of reference. Where ratings or specifications quoted differ from those published in the preceding edition they will be pointed out by arrows. You will understand that we can not guarantee that all products listed in any one edition of the handbook will remain available, or that their specifications will not be changed, before the next edition is published. If you need confirmation that the published data about any of our products are the latest available, may we ask that you contact our representative. He is at your service and will be glad to answer your inquiries.

ELECTRON TUBES (BLUE SERIES)

This series consists of the following parts, issued on the dates indicated.

- | | | |
|---------------|----------------------------------------------------------------------------------|-----------------------------------|
| Part 1 | Transmitting tubes (Tetrodes, Pentodes);
Amplifier circuit assemblies | January 1972 |
| Part 2 | Tubes for microwave equipment | February 1972 |
| Part 3 | Special Quality tubes;
Miscellaneous devices | March 1972 |
| Part 4 | Receiving tubes | June 1972 |
| Part 5 | Cathode-ray tubes; Photo tubes; Camera tubes | May 1971 |
| Part 6 | Devices for nuclear equipment | June 1971 |
| | Photomultiplier tubes | Radiation counter tubes |
| | Channel electron multipliers | Semiconductor radiation detectors |
| | Scintillators | Neutron generator tubes |
| | Photoscintillators | Photo diodes |
| Part 7 | Gas-filled tubes | July 1971 |
| | Voltage stabilizing and reference tubes | Thyratrons |
| | Counter, selector, and indicator tubes | Ignitrons |
| | Trigger tubes | Industrial rectifying tubes |
| | Switching diodes | High-voltage rectifying tubes |
| Part 8 | T.V. Picture tubes | August 1971 |
| Part 9 | Transmitting tubes (Triodes) ;
Tubes for r.f. heating (Triodes) | December 1971 |

SEMICONDUCTORS AND INTEGRATED CIRCUITS (RED SERIES)

This series consists of the following parts, issued on the dates indicated.

Part 1 Diodes and Thyristors

September 1971

General
Signal diodes
Variable capacitance diodes
Voltage regulator diodes
Rectifier diodes

Thyristors, diacs, triacs
Rectifier stacks
Accessories
Heatsinks

Part 2 Low frequency; Deflection

October 1971

General
Low frequency transistors (low power)
Low frequency power transistors

Deflection transistors
Accessories

Part 3 High frequency; Switching

November 1971

General
High frequency transistors

Switching transistors
Accessories

Part 4 Special types

December 1971

General
Transmitting transistors
Microwave devices
Field effect transistors
Dual transistors
Microminiature devices for
thick- and thin-film circuits

Photoconductive devices
Photodiodes
Phototransistors
Light emitting diodes
Infra-red sensitive devices
Accessories

Part 5 Linear Integrated Circuits

February 1972

General

Linear integrated circuits

Part 6 Digital integrated circuits

March 1972

General
DTL (FC family)
DTL/HNLL (FZ family)
TTL (FJ family)

TTL (GJ family)
CML (GH family)
MOS (FD family)

COMPONENTS AND MATERIALS (GREEN SERIES)

This series consists of the following parts, issued on the dates indicated.

Part 1 Circuit Blocks, Input/Output Devices, October 1971 Electro-mechanical Components *), Peripheral Devices

Circuit blocks 40-Series	Input/output devices
Counter modules 50-Series	Electro-mechanical components *)
Norbits 60-Series, 61-Series	Peripheral devices
Circuit blocks 90-Series	

Part 2 Resistors, Capacitors December 1971

Fixed resistors	Paper capacitors and film capacitors
Variable resistors	Electrolytic capacitors
Non-linear resistors	Variable capacitors
Ceramic capacitors	

Part 3 Radio, Audio, Television February 1972

FM tuners	Audio and mains transformers
Coil assemblies	Television tuners, aerial input assemblies
Piezoelectric ceramic resonators and filters	Components for black and white television
Loudspeakers	Components for colour television
	Deflection assemblies for camera tubes

Part 4 Magnetic Materials, Piezoelectric Ceramics, Ni Cd cells May 1972

Ferrites for radio, audio and television	Ferroxcube transformer cores
Small coils and assembling parts	Piezoelectric ceramics
Ferroxcube potcores and square cores	Permanent magnet materials
	Cylindrical nickel cadmium cells

Part 5 Memory Products, Magnetic Heads, Quartz Crystals, June 1971 Microwave Devices, Variable Transformers

Ferrite memory cores	Quartz crystal units, crystal filters
Matrix planes, matrix stacks	Isolators, circulators
Complete memories	Variable mains transformers
Magnetic heads	

Part 6 Electric Motors and Accessories, August 1971 Timing and Control Devices

Stepper motors	Small d. c. motors
Small synchronous motors	Tachogenerators and servomotors
Asynchronous motors	Indicators for built-in test equipment

Part 7 Circuit Blocks September 1971

Circuit blocks 100kHz Series	Circuit blocks for ferrite core memory drive
Circuit blocks 1-Series	
Circuit blocks 10-Series	

*) From October 1971 published in Part 1 instead of Part 5.

May 1972

Argentina

FAPESA I.y.C.
Melincué 2594
Tel. 50-9941/8155
BUENOS AIRES

Australia

Philips Industries Ltd.
Elcoma Division
95-99 York Street
Tel. 20223
SYDNEY, N.S.W. 2000

Austria

WIVEG
Zieglergasse 6
Tel. 93 26 22
A1072 VIENNA

Belgium

M.B.L.E.
80, rue des Deux Gares
Tel. 23 00 00
1070 BRUSSELS

Brazil

IBRAPE S.A.
Av. Paulista 2073-S/Loja
Tel. 278-1111
SAO PAULO, SP

Canada

Philips Electron Devices
116, Vanderhoof Ave.
Tel. 425-5161
TORONTO 17, Ontario

Chile

Philips Chilena S.A.
Av. Santa Maria 0760
Tel. 39-40 01
SANTIAGO

Colombia

SADAPE S.A.
Calle 19, No. 5-51
Tel. 422-175
BOGOTA D.E. 1

Denmark

Miniwatt A/S
Emdrupvej 115A
Tel. (01) 69 16 22
DK-2400 KØBENHAVN NV

Finland

Oy Philips Ab
Elcoma Division
Kaiwokatu 8
Tel. 65 80 33
SF-00100 HELSINKI 10

France

R.T.C.
La Radiotechnique-Complexe
Avenue Ledru Rollin 130
Tel. 357-69-30
PARIS 11

Germany

Valvo G.m.b.H.
Valvo Haus
Burchardstrasse 19,
Tel. (0411) 3296-1
2 HAMBURG 1

Greece

Philips S.A. Hellénique
Elcoma Division
52, Av. Syngrou
Tel. 915 311
ATHENS

Hong Kong

Philips Hong Kong Ltd.
Components Dept.
St. George's Building, 21st Fl.
Tel. K-42 82 05
HONG KONG

India

IMBELEC Div. of
Philips India Ltd.
Band Box House
254-D, Dr. Annie Besant Road
Tel. 475 311 to 15
Worli, BOMBAY 18 (WB)

Indonesia

P.T. Philips-Ralin Electronics
Elcoma Division
Djalan Gadjah Mada 18
Tel. 44 163
DJAKARTA

Ireland

Philips Electrical (Ireland) Ltd.
Newstead, Clonskeagh
Tel. 69 33 55
DUBLIN 14

Italy

Philips S.p.A.
Sezione Elcoma
Piazza IV Novembre 3
Tel. 69 94
MILANO

Japan

NIHON PHILIPS
32nd Fl. World Trade Center Bldg.
5, 3-chome, Shiba Hamamatsu-cho
Minato-ku
Tel. (435) 5204-5
TOKYO

Mexico

Electrónica S.A. de C.V.
Varsovia No. 36
Tel. 5-33-11-80
MEXICO 6, D.F.

Netherlands

Philips Nederland N.V.
Afd. Elonco
Boschdijk, VB
Tel. (040) 43 33 33
EINDHOVEN

New Zealand

EDAC Ltd.
70-72 Kingsford Smith Street
Tel. 873 159
WELLINGTON

Norway

Electronica A/S
Middelthunsgate 27
Tel. 46 39 70
OSLO 3

Peru

CADESA
Jr. Ilo, No. 216
Appartado 10132
Tel. 27 7317
LIMA

Portugal

Philips Portuguesa S.A.R.L.
Rua Joaquim Antonio de Aguiar 66
Tel. 68 31 21/9
LISBOA

South Africa

EDAC (Pty.) Ltd.
South Park Lane
New Doornfontein
Tel. 24/6701-2
JOHANNESBURG

Spain

COPRESA S.A.
Balmes 22
Tel. 232 66 80
BARCELONA 7

Sweden

ELCOMA A.B.
Lidingövägen 50
Tel. 08/67 97 80
10250 STOCKHOLM 27

Switzerland

Philips A.G.
Edenstrasse 20
Tel. 051/44 22 11
CH-8027 ZUERICH

Taiwan

Philips Taiwan Ltd.
San Min Building, 3rd Fl.
57-1, Chung Shan N. Road
Section 2
Tel. 553101-5
TAIPEI

Turkey

Turk Philips Ticaret A.S.
EMET Department
Gümüssuyu Cad. 78-80
Tel. 45.32.50
Beyoğlu, ISTANBUL

United Kingdom

Mullard Ltd.
Mullard House
Torrington Place
Tel. 01-580 6633
LONDON WC1E 7HD

United States

North American Philips
Electronic Component Corp.
230, Duffy Avenue
Tel. (516) 931-6200
HICKSVILLE, N.Y. 11802

Uruguay

Luzilectron S.A.
Rondeau 1567, piso 5
Tel. 9 43 21
MONTEVIDEO

Venezuela

C.A. Philips Venezolana
Elcoma Department
Colinas de Bello Monte
Tel. 72.01.51
CARACAS

LIST OF SYMBOLS

Symbols denoting electrodes and electrode/element connections

Heater or filament	f
Heater or filament tap	f _c
Cathode	k
Input cathode lead	k _i
Output cathode lead	k _o
Grid	g
Electrostatic deflection plate or rod	D
Fluorescent screen	l
Anode	a
Anode of a detection diode	d
Tube pin which must not be connected externally	i. c.
Tube pin which may be connected externally	n. c.
External conductive coating	m
Internal shield	s

Remarks

Equivalent electrodes of a multiple unit tube are distinguished by means of accents; e.g. the anodes of a double-anode rectifying tube are indicated by a and a'.

Similar electrodes of the same electrode system are distinguished by means of an additional numeral; the electrode nearest to the cathode has the lowest number.

The electrodes of multiple-unit tubes, in which the units are different, are distinguished by means of the following indices:

diode	D
triode	T
tetrode	Q
pentode	P
hexode or heptode	H

Symbols denoting voltages (average values unless otherwise stated)

Symbol for voltage, followed by an index denoting the relevant electrode/element	V
Heater or filament voltage	V_f
Peak value of a voltage	V_p
Peak to peak value of a voltage	V_{pp}
Supply voltage of tube electrodes	V_b
Anode voltage of a detection diode	V_d
RMS value of a voltage	V_{RMS}
Heater starting voltage	V_{fo}
Grid voltage	V_g
A.C. input voltage	V_i
Voltage between cathode and heater	V_{kf}
D.C. voltage supplied by a rectifying tube	V_o
A.C. output voltage	V_o
Voltage for gain control	V_R
Transformer voltage (secondary)	V_{tr}
Anode voltage under cold condition or cut-off condition (I_k approx.0)	V_{a_0}
Screen grid voltage under cold condition or cut-off condition (I_k approx.0)	$V_{g_{20}}$

Remarks

In the case of indirectly heated tubes the electrode voltages are specified with respect to the cathode.

In the case of directly heated tubes the electrode voltages are specified with respect to the negative terminal of the filament, unless otherwise stated.

Symbols denoting currents

Remarks

The positive electrical current is directed opposite to the direction of the electron current.

The symbols quoted represent average values unless otherwise stated.

Symbol for current followed by an index
denoting the relevant electrode

I

Heater or filament current

I_f

Anode current

I_a

Current of a detection diode

I_d

RMS value of a current

I_{RMS}

Grid current

I_g

Cathode current

I_k

Current to fluorescent screen

I_ℓ

D.C. current supplied by a rectifying tube

I_o

Peak value of a current

I_p

Symbols denoting powers

Symbol for power followed by an index
denoting the relevant electrode

W

Anode dissipation

W_a

Grid dissipation

W_g

Input power

W_i

Anode supply D.C. power

W_{i_a}

Dissipation of a fluorescent screen

W_ℓ

Output power

W_o

Symbols denoting capacitances

See IEC Publication 100

Symbols denoting resistance and impedance

When for one of the following symbols Z is used instead of an R the word "resistance" should read "impedance"

External resistance in an anode lead	R_a
External A.C. resistance or load resistance in an anode lead	$R_{a\sim}$
Load resistance of a push-pull amplifier (anode to anode)	$R_{aa\sim}$
Equivalent noise resistance	R_{eq}
External resistor in a grid lead or grid circuit resistance	R_g
Input resistance	r_g
Internal resistance	R_i
Resistor in a cathode lead	R_k
External resistance between cathode and heater	R_{kf}
Protecting resistance in the anode lead of a rectifying tube	R_t

Symbols denoting various quantities

Brightness	B
Bandwidth	B
Distortion factor	d
n-th harmonic distortion	d_n
Noise factor	F
Frequency	f
Pulse repetition rate	f_{imp}
Power gain	G
Voltage gain	$V_o/V_{i,g}$
Height above sea level	h
Magnetic field strength	H
Cross modulation factor	K
Hum modulation factor	m_b
Transformer ratio	n
Transconductance	S
Conversion conductance	S_c
Effective transconductance of an oscillator	S_{eff}
Temperature	t
Ambient temperature	t_{amb}
Time	T
Averaging time of current or voltages	T_{av}
Cathode heating time	T_h
Pulse duration	T_{imp}
Shadow section on a fluorescent screen	α
Light sector on a fluorescent screen	β
Duty factor	δ
Phase angle	φ
Efficiency	η
Wavelength	λ
Amplification factor	μ
Amplification factor of grid No. 2 with respect to grid No. 1	$\mu_{g_2g_1}$

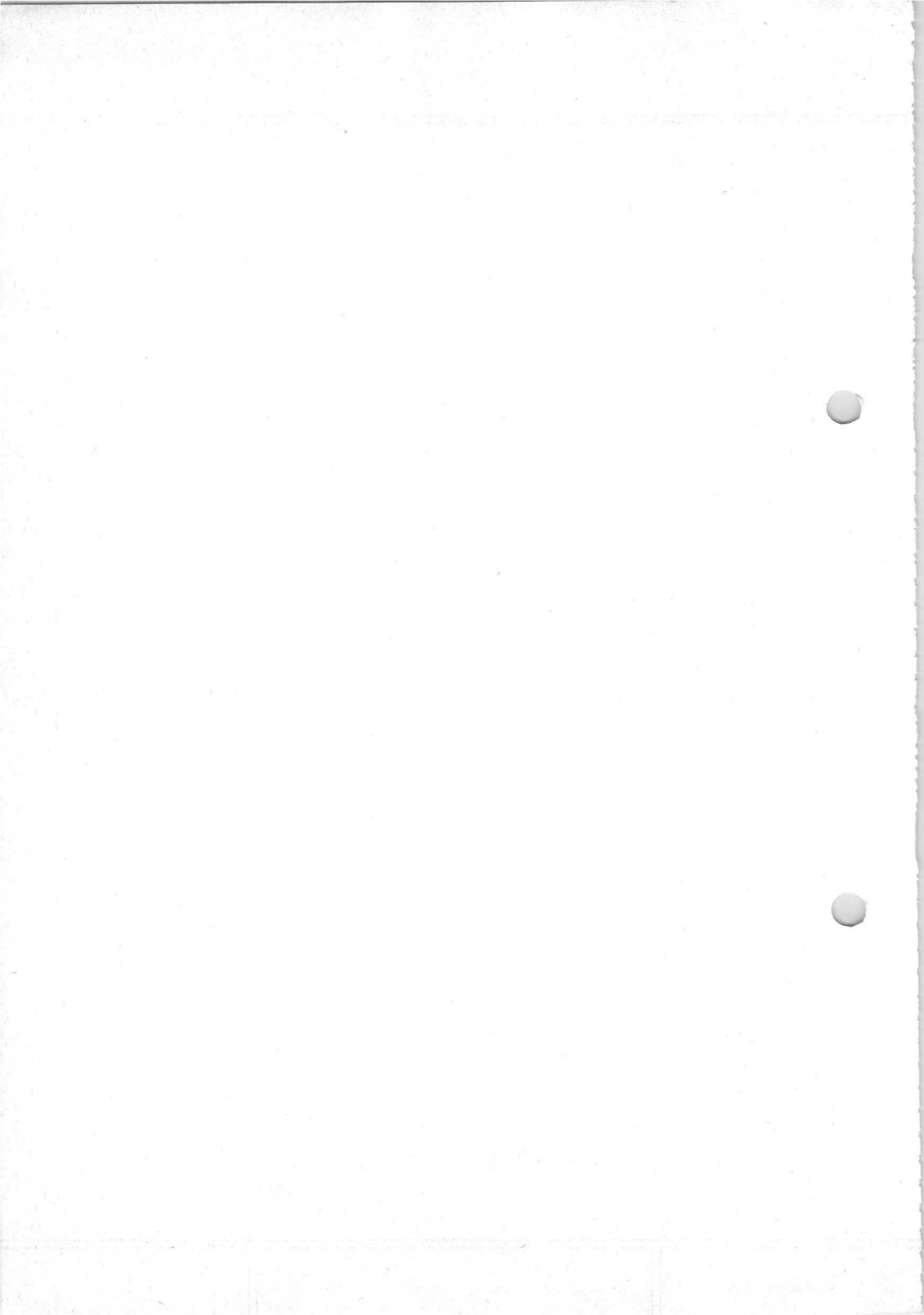

GENERAL OPERATIONAL RECOMMENDATIONS RECEIVING TUBES

CONTENTS

1. General
2. Spread in tube characteristics
3. Spread and variation in operating conditions
4. Limiting values
5. Electrode voltages
6. Electrode current
7. Electrode dissipation
8. Heater circuit
9. Heater-to-cathode circuit
10. Suppressor grid circuit
11. Control grid circuit
12. Capacitances
13. Protective resistors for mains rectifying tubes
14. Life
15. Hum
16. Microphony
17. Environmental conditions
18. Mounting and wiring.

GENERAL OPERATIONAL RECOMMENDATIONS RECEIVING TUBES

1. GENERAL

Where deviations from these directives are permissible or necessary, statements to that effect will be made on the relevant data sheets. If applications are considered not referred to in the data sheet of the relevant tube type extra care should be taken with circuit design to avoid that the tube is overloaded due to unfavourable operating conditions.

Users are warned for applying a tube in circuits where use is made of tube characteristics not controlled by the manufacturer. When at a later date batches of tubes are delivered which show different values for these characteristics this may result in unsatisfactory performance of the equipment.

2. SPREAD IN TUBE CHARACTERISTICS

Equipment design should be based on the characteristics as stated in the data sheets.

Tube data not stated as maximum or minimum values apply to a nominal tube. When measurements are carried out on a small number of tubes, and in particular on new tube types it should be taken into account that average values and the spread figures may differ from those obtained for larger quantities.

No guarantee is given for values of characteristics in settings substantially differing from those specified in the data sheets.

3. SPREAD AND VARIATION IN OPERATING CONDITIONS

The operating conditions of the tube in the equipment are expressed as a number of parameter values each of which is subject to spread and/or variation.

3.1 Spread. Spread in a parameter value will result in individual values deviating permanently from the average value; spread is due to e.g. component value deviations. The average value is the average of such a number of individual values taken at random that an increase of the number will have a negligible influence on the average value.

3.2 Variation. Variation of a parameter value is the change of value occurring as a function of time, e.g. due to supply voltage fluctuations. The average value is calculated over a period such that a prolongation of that period will have a negligible influence on the average value.

4. LIMITING VALUES

4.1 Limiting values are in accordance with the applicable rating system as defined by I.E.C. publication 134.

Reference may be made to one of the following 3 rating systems.

4.1.1 Absolute maximum rating system. Absolute maximum ratings are limiting values of operating and environmental conditions applicable to any electronic device of a specified type as defined by its published data, and should not be exceeded under the worst probable conditions.

These values are chosen by the device manufacturer to provide acceptable serviceability of the device, taking no responsibility for equipment variations, environmental variations, and the effects of changes in operating conditions due to variations in the characteristics of the device under consideration and of all other electronic devices in the equipment.

The equipment manufacturer should design so that, initially and throughout life, no absolute maximum value for the intended service is exceeded with any device under the worst probable operating conditions with respect to supply voltage variation, equipment components spread and variation, equipment control adjustment, load variations, signal variation, environmental conditions, and spread or variations in characteristics of the device under consideration and of all other electronic devices in the equipment.

4.1.2 Design-maximum rating system. Design-maximum ratings are limiting values of operating and environmental conditions applicable to a bogey electronic device* of a specified type as defined by its published data, and should not be exceeded under the worst probable conditions.

These values are chosen by the device manufacturer to provide acceptable serviceability of the device, taking responsibility for the effects of changes in operating conditions due to variations in the characteristics of the electronic device under consideration.

The equipment manufacturer should design so that, initially and throughout life, no design-maximum value for the intended service is exceeded with a bogey device under the worst probable operating conditions with respect to supply-voltage variation, equipment component variation, variation in characteristics of all other devices in the equipment, equipment control adjustment, load variation, signal variation and environmental conditions.

4.1.3 Design-centre rating system. Design-centre ratings are limiting values of operating and environmental conditions applicable to a bogey electronic device* of a specified type as defined by its published data, and should not be exceeded under average conditions.

Note *. A bogey tube is a tube whose characteristics have the published nominal values for the type. A bogey tube for any particular application can be obtained by considering only those characteristics which are directly related to the application.

These values are chosen by the device manufacturer to provide acceptable serviceability of the device in average applications, taking responsibility for normal changes in operating conditions due to rated supply-voltage variation, equipment component spread and variation, equipment control adjustment, load variation, signal variation, environmental conditions, and variations or spread in the characteristics of all electronic devices.

The equipment manufacturer should design so that, initially, no design-centre value for the intended service is exceeded with a bogey electronic device * in equipment operating at the stated normal supply-voltage.

- 4.2 If the tube data specify limiting values according to more than one rating system the circuit has to be designed so that none of these limiting values is exceeded under the relevant conditions.
- 4.3 In addition to the limiting values given in the individual data sheets the directives in the following paragraphs should be observed.

5. ELECTRODE VOLTAGES

5.1 All electrode voltages are given with respect to cathode.

5.2 Two limiting values of electrode voltage are given

a) V_{a0} , V_{g20} etc.

These values are continuously permitted with cold cathode. They are also permitted as peak voltage during operation when a D.C. voltage in combination with a superimposed A.C. voltage is present at the electrode provided that the peak value coincides with approx. zero electrode current.

b) V_a , V_{g2} etc.

These values are D.C. components of the electrode voltages and are continuously permitted.

In circuits with automatic gain control the D.C. component may exceed the published limiting value with 20% provided that the increase of voltage results solely from the a.g.c. action and that maximum voltage coincides with approximately zero electrode current.

Proper functioning of the tubes at supply voltages lower than 50 volts cannot be guaranteed if these values are not quoted under the operating characteristics. Unless otherwise stated all values refer to positive voltages.

Floating electrodes. All tube electrodes should have a D.C. connection to the cathode (no floating electrodes).

6. ELECTRODE CURRENT

The limiting values I_a , I_{g2} , I_k etc. are the D.C. components of the electrode currents averaged over any 50 ms period.

If no specific pulse ratings apply, a peak value of three times I_a , I_{g2} , I_k etc. is permitted for maximum 25 ms.

See note on previous page.

Spread and variation in electrode currents should be restricted so that with nominal tubes the specified design centre limiting values are not exceeded by more than 10% under the worst probable conditions.

7. ELECTRODE DISSIPATION

The limiting values W_a , W_{g2} etc. are the average values, obtained by averaging over any 1 s period.

- 7.1 If not otherwise indicated the quoted operating conditions for audio output tubes are permitted only with speech and music signals.

When for power output tubes a limiting value W_{g2p} is stated this value applies only in the case of speech and music drive and it should not be exceeded when measured with a sinusoidal signal and at maximum output.

With class B operation and speech and music excitation the quoted limiting value of anode dissipation is allowed to be exceeded by max. 10% if measured with a sinusoidal signal at 2/3 of maximum drive.

When the operating conditions differ from those stated a non-decoupled series resistor of 0.5 to 1 k Ω may be required to avoid exceeding the limiting values of screen grid dissipation.

When load values vary during operation care should be taken that the limiting values of W_a or W_{g2} are not exceeded.

Spread and variation in the electrode dissipation of audio output tubes should be restricted so that with bogey tubes the specified design centre limiting values are not exceeded by more than 20% under the worst probable conditions.

- 7.2 For all other types the quoted design centre limits for the electrode dissipations should not be exceeded by more than 15% with bogey tubes under the worst probable conditions unless otherwise stated in the relevant data sheets.

8. HEATER CIRCUIT

Any deviation from the nominal heater voltage (in case of parallel connection) or from the nominal heater current (in case of series connection) has a detrimental effect on tube performance and life, and should therefore be kept at a minimum. Such deviations may be caused by:

- a) Mains voltage fluctuations.
- b) Spread in the characteristics of components such as transformers, resistors, capacitors etc.

Designers of heater circuits are strongly recommended to bear this in mind when dealing with equipment to be used in areas where the actual mains voltage is likely to differ from the nominal value.

8.1 Parallel connection

The maximum deviation of the heater voltage should not exceed $\pm 15\%$ (design max. value).

This condition will be fulfilled when the mains voltage fluctuates by $\pm 10\%$ and a ordinary transformer (see below) is used.

8.2 Series connection

The maximum deviation of the heater current should not exceed $\pm 8\%$ (design max. value).

When a small number of tubes with large differences in the heater voltage is used in series connection combined with a series resistor or a series capacitor, the maximum permitted deviation of the heater current may be exceeded.

To avoid this, certain restrictions must be imposed on the composition of the heater chain; the maximum part of the supply voltage that can be eliminated, and the tolerances of the voltage dropper in series with the heaters.

A number of circuits for $I_f = 300 \text{ mA}$ will be described in detail below.

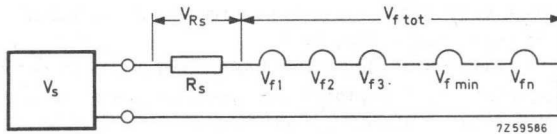

V_s = source voltage (mains voltage or mains voltage stepped down via a transformer)

V_{R_s} = voltage drop over series resistor

$V_{f \text{ tot.}}$ = $V_{f1} + V_{f2} + V_{f3} + \dots + V_{f \text{ min.}} + \dots + V_{fn}$.

$V_{f \text{ min.}}$ = lowest individual heater voltage of all tubes in the chain

R_s = series resistor

Voltage source

The following spreads have been taken into account for the source voltage:

- Mains voltage spread $\pm 10\%$ either or not combined with the voltage spread caused by a transformer with a permanent deviation from the nominal value of $\pm 1\%$ and with a spread of $\pm 2\%$ (ordinary, well made transformer).

The following circuits are allowed:

8.2.1 Supply directly from a voltage source ($V_s = V_{ftot.}$)

- No restrictions.

8.2.2 Supply from a voltage source via a 5% series resistor ($V_s = V_{R_s} + V_{ftot.}$)

a. One single tube: permitted if $\frac{V_{R_s}}{V_{ftot.}} \leq 2$

b. Heater chain consisting of 2 or more tubes:

the maximum permitted ratio $\frac{V_{R_s}}{V_{ftot.}}$ can be read from diagram number 1 as follows:

Determine $\frac{V_{fmin.}}{V_{ftot.}}$ of the heater chain. Draw a vertical line through the corresponding point in the diagram. Draw a horizontal line through the point of intersection of this vertical line with the line which indicates the total number of tubes in the chain. The point of intersection of this horizontal line with the vertical axis gives the maximum permitted ratio between the series resistor and the sum of the heater voltages of all tubes in the chain.

8.2.3 Supply from a voltage source via a series diode ($\frac{V_s}{\sqrt{2}} = V_{ftot.}$)

- No restrictions.

8.2.4 Supply from a voltage source via a series diode and a series resistor

$$\left(\frac{V_s}{\sqrt{2}} = V_{ftot.} + V_{R_s}\right)$$

In the above formula $V_{ftot.}$ and V_{R_s} are RMS values and the maximum permitted ratio $\frac{V_{R_s}}{V_{ftot.}}$ can be read from diagram number 1 (see 8.2.2).

For calculation of R_s divide the required V_{R_s} (RMS) by the nominal heater current: $R_s = \frac{V_{R_s}}{0.3}$

Remark to 8.2.3 and 8.2.4:

When series diodes are applied, the D.C. component of the resulting heater voltage should preferably be negative with respect to the cathodes of the tubes.

8.2.5 Supply from a voltage source via a series capacitor

a. One single 300 mA tube; permitted if

$$\frac{V_{f \text{ tot.}}}{V_S} \geq 0.50 \quad \text{when 5\% paper capacitors are applied.}$$

b. $\frac{V_{f \text{ tot.}}}{V_S} \geq 0.70$ when 10% metalized polycarbonate capacitors are applied.

c. Heater chain consisting of 2 tubes or more; permitted if $\frac{V_{f \text{ tot.}}}{V_S}$

$$\frac{V_{f \text{ tot.}}}{V_S} \geq 0.6 \quad \text{when 5\% paper capacitors are applied.}$$

$$\frac{V_{f \text{ tot.}}}{V_S} \geq 0.8 \quad \text{when 10\% metallized polycarbonate capacitors are applied.}$$

8.3 Stand-by (instant-on circuits)

In order to maintain reliability during life, it is recommended to reduce the heater voltage of the tubes during stand-by operation to 75% of the nominal value.

Note

If other designs for the heater supply circuit are wanted than the configurations described above it is strongly recommended to contact the tube manufacturer.

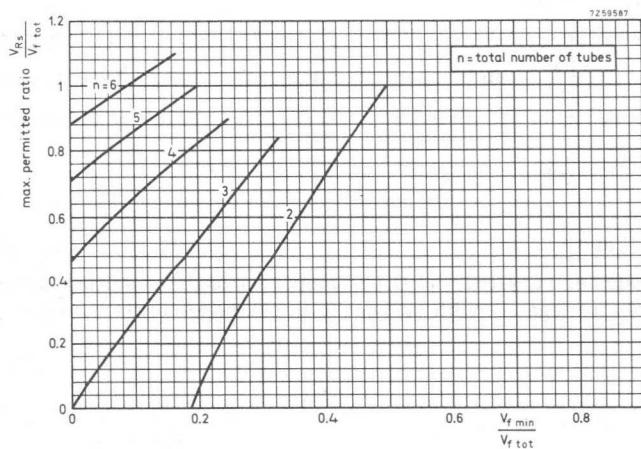

Diagram No. 1

9. HEATER-TO-CATHODE CIRCUIT

The published limiting values of V_{kf} apply to the positive and negative D.C. component of the voltage between the cathode and any of the heater terminals. The limiting peak value is twice the rated D.C. value with a maximum of 315 V.

In stating these values figures only the risk of breakdown has been considered. No conclusions with respect to hum should be drawn from them.

To minimize the influence of variation and spread in the leakage current between heater and cathode the resistance of the external heater to cathode circuit should not exceed 20 k Ω .

However, when the D.C. value of V_{kf} never drops below three times the RMS value of the heater voltage a resistor of maximum 220 k Ω may be connected between heater and cathode provided that the hum voltage which may develop across the cathode resistor is acceptable for the application considered.

An interruption of the D.C. connection between cathode and earth or heater and earth may introduce heater-cathode breakdown and should be avoided.

10. SUPPRESSOR GRID CIRCUIT

The suppressor grid should normally be connected to the cathode; any series resistance in the suppressor grid lead should not exceed a value of 50 k Ω . The suppressor grid should not be used as a control grid unless specific recommendations are made in the data sheets. Where the suppressor grid is so used, care should be taken not to exceed the maximum screen-grid dissipation. When a tube is connected as a triode, the suppressor grid should be connected directly to the cathode, except where other recommendations are given in the data sheets. If the circuit is such that the suppressor grid is liable to be driven positive, it is recommended to consult the tube manufacturer.

11. CONTROL GRID CIRCUIT

In the interest of low hum and noise the resistance in the control grid circuit should be as low as possible.

The limiting value of the grid resistance given in the data sheets is so chosen that during the tube life the negative grid current which may occur will not result in unacceptable tube operation.

If only the limiting value of the resistance for fixed bias operation is given and stabilizing elements are used in the circuit, this limiting value may be multiplied by the D.C. feedback factor obtained by these stabilizing elements; the maximum limiting value should not exceed 20 M Ω .

12. CAPACITANCES

All data have been measured according to I.E.C. Publication 100

13. PROTECTIVE RESISTORS FOR MAINS RECTIFYING TUBES

To restrict the peak value of cathode current in a mains rectifying tube the ohmic resistance (R_t) in series with the anode should not be less than that specified in the data sheet.

When the anode supply voltage is obtained from a transformer the value of the resistance to be added in each anode lead should be calculated from the following formula:

$$R_t = R_s + n^2 R_p + R_1.$$

In case of half-wave rectification

R_t = the required protective resistance

R_s = the ohmic resistance of the secondary coil

n = the transformer ratio

R_p = the ohmic resistance of the primary coil

R_1 = resistance that must be added

In case of full-wave rectification

R_t = the required protective resistance per anode

R_s = ohmic resistance of half the secondary coil

n = transformer ratio between primary and half the secondary coil

R_p = ohmic resistance of the primary coil

R_1 = resistance to be added in each anode lead.

When an auto transformer is applied it should be taken into account that the transformer winding is partly short-circuited by the mains.

When a filter input capacitor is applied the power dissipation in R_t is supplemented by the contribution of the ripple current up to three times the value produced by the D.C. component of current.

14. LIFE

Optimum life performance is ensured if the tube is operated according to the published "Operating conditions". Spread and variation of operating conditions should be limited as much as possible.

15. HUM

15.1 When the heater supply is obtained from the mains voltage the cathode current may be modulated by the A.C. mains frequency.

This modulation, resulting in hum, may be caused by capacitive or leakage currents between the heater and the tube electrodes, by the magnetic field of the heater or by external fields.

15.2 The following measures can be taken to reduce hum.

Cathode hum

Keep the A.C. voltage between cathode and heater as small as possible; with series operation insert the most critical tube at the earthed side of the heater chain and with parallel operation connect the electrical centre of the heater to earth.

Do not include the impedance between cathode and heater in an R.F. circuit. If this cannot be avoided and the cathode must be connected to a tapping of a tuned circuit, choose the highest practicable tuning capacitance in order to reduce the influence of possible variations in circuit capacitance. This applies especially to oscillator circuits where variations in the capacitance between cathode and heater may lead to modulation hum.

Decouple the cathode resistance as far as possible.

Where negative feedback is applied, take the non-decoupled part as small as possible.

Control grid hum

Keep the A.C. voltage between cathode and heater as small as possible. Do not use idle socket contacts in the proximity of the control grid contact as anchoring points for joints connected to 50 Hz as this may cause hum due to leakage or capacitance in the tube socket.

Keep the impedance at the mains frequency in the control grid lead as small as possible.

- 15.3 For tubes mainly intended for use in broadcast receivers the value of Z_{g1} at mains frequency is so chosen that the hum voltage will be -60 dB (design centre value) with respect to the input voltage for 50 mW output power.

The hum voltage in this case is measured behind a filter, the characteristic, of which agrees with the C.C.I.R. aural sensitivity curve (see graph on next page).

For tubes mainly intended for use in audio equipment the value of Z_{g1} is so chosen that the level of hum voltage, measured with a filter linear up to 500 Hz, is -60 dB with respect to the input voltage for maximum output power. To obtain these values the centre of parallel-connected heaters should be earthed whereas with series-connected heaters the value of V_{kf} , permitted in connection with hum, should not be exceeded; when a cathode resistor is used, it should be decoupled by a capacitor of at least 100 μ F.

It should be realized that, although the tubes may meet the requirement of a -60 dB hum level, the total hum level of the circuitry stage under consideration may be higher owing to imperfect circuitry (magnetic hum induced by transformers and smoothing chokes; unsatisfactory smoothing of the rectified voltage, etc.).

For several R.F. and I.F. types a curve has been published which shows, as a function of the transconductance, the hum voltage (V_i) on the control-grid which causes a modulation hum of 1%.

The published limiting value of V_{kf} is the maximum permissible value up to which there will be no danger of breakdown between cathode and heater, and it does not give information about the resulting hum level.

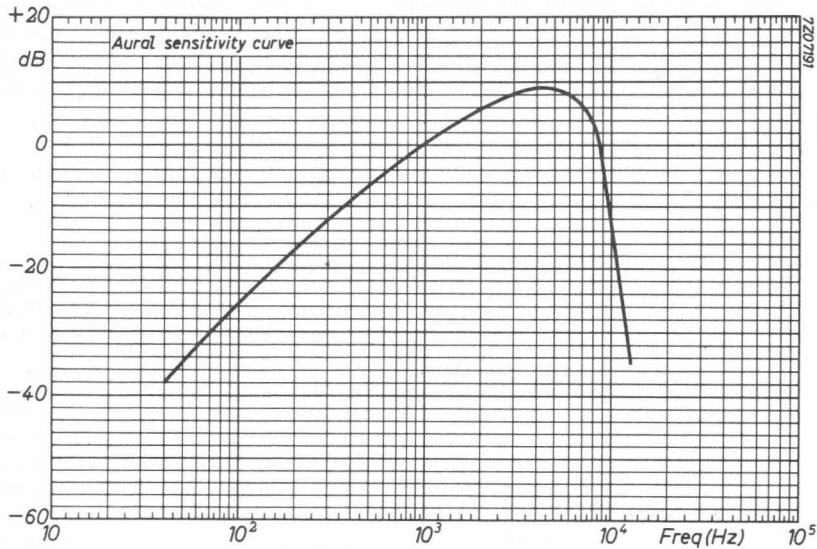

16. MICROPHONY

Whenever a tube is subjected to vibration, caused by e.g. a loudspeaker, motor, switch etc., some disturbance in the output of the tube occurs. The effect of this disturbance will depend on the individual application. The published data of various tube types make reference to the microphonic sensitivity and this should be noted when a tube is chosen for a specific application.

Where the effects of microphony are found to be objectionable, special steps may have to be taken to reduce the vibration reaching the tube. The chassis itself may show wide variations in amplitude of vibration over its area, due to resonances; therefore favourable location of the tube, or local strengthening of the chassis, may appreciably reduce microphony.

The maximum peak acceleration to which the tube may be subjected under the most unfavourable conditions is 1.5 g at frequencies < 600 Hz and 0.2 g at frequencies > 600 Hz. However, tubes should not be subjected to the maximum acceleration at a given frequency for a long period of time. In case the actual acceleration is higher than these values, difficulties with regard to microphony may be expected.

Warning: It should be noted that excessive mechanical vibration may result in the destruction of the internal tube structure.

17. ENVIRONMENTAL CONDITIONS

1. Atmospheric pressure. Ratings apply to operation at normal atmospheric pressure at altitudes below 3000 m.

It is advised to consult the tube manufacturer if tubes have to be operated at lower pressures.

2. Thermal considerations. The bulb and the base temperature are defined as the highest temperature at any place on the bulb or the base. The base temperature should not exceed 165 °C.

Used in practical circuits and under design centre conditions the bulb temperature of a tube should not exceed by more than 30 °C that temperature which would be attained if the tube were operated at its maximum ratings in free air at a room temperature of 20 °C.

If, for instance, the bulb temperature of a certain type of tube operating in free air at maximum ratings is shown to be 200 °C, it is permissible to use this tube in equipment where the bulb attains a temperature of 230 °C (thus at an excess of 30 °C). In practice this means that the "ambient" temperature in the equipment may rise above room temperature by about twice 30 °C and thus may attain a value of 80 °C.

When a tube runs particularly hot this increase of 30 °C is not permissible; the design maximum should then be 250 °C unless otherwise stated in the relevant data sheets.

When the maximum permitted base or bulb temperature is exceeded, the tube reliability during life may deteriorate. Cooling should therefore always be adequate; it may be obtained by convection, radiation or conduction. To make it most efficient a free circulation of air should be assured around the tube and the temperature of neighbouring bodies should be low. These neighbouring bodies should preferably approach a perfect black body.

The design of screening or retaining devices should also be such that the reflection of heat back to the bulb must be minimized. In some cases it may be necessary to reduce the electrode dissipation.

Heat dissipating shields have the property to reduce the hot-spot temperature at the tube envelope. However, this is generally accompanied by a rise in base temperature whereas also the normal sublimation pattern inside the tube may be drastically disturbed. For this reason extreme care should be exercised when applying these devices.

3. High Voltage insulation. To avoid insulation breakdown due to ionization or tracking at high electrode voltages adequate ventilation is required.

High voltage terminals should not have sharp or pointed edges.

18. MOUNTING AND WIRING

1. Mounting position. Unless otherwise specified, a tube may be mounted in any position.
2. Pins and sockets. Many tube types employ semi-rigid pins.

To ensure that these pins are straight before insertion into the tube socket use may be made of a pin straightening tool. It is recommended both in wired and in printed circuits to use sockets in which the contact springs are reasonably flexible. Too stiff wiring may hold the contacts out of position in such a way that the tube base is damaged upon insertion. To avoid this the use of a wiring jig is recommended. The dimensions of the wiring jig shall be in conformity with the nominal base dimensions specified in this Handbook.

No connections should be made to a pin marked i.c.

The sockets used shall comply with the following:

The insertion and withdrawal forces of sockets shall be checked before any previous gauging or sizing. The sockets shall be capable of accepting and having withdrawn from them the insertion and withdrawal force gauge* within the force limits specified below. These tests shall be made with a test jig.

Socket compatible with small button miniature 7 pin base (IEC 67-I-10a)
max. insertion force 72 N (7.2 kgf)
min. withdrawal force 12 N (1.2 kgf)

Socket compatible with small button noval 9 pin base (IEC 67-I-12a)
max. insertion force 91 N (9.1 kgf)
min. withdrawal force 13.5 N (1.35 kgf)

Socket compatible with small button decal 10 pin base (IEC 67-I-41a)
max. insertion force 91 N (9.1 kgf)
min. withdrawal force 13.5 N (1.35 kgf)

Socket compatible with magnoval base (IEC 67-I-36a)
max. insertion force 91 N (9.1 kgf)
min. withdrawal force 13.5 N (1.35 kgf)

3. Retaining devices. When measures are required to prevent a tube from being shaken out of the socket a retaining device may be used. Care should then be taken to avoid the maximum permitted bulb temperature being exceeded.

* Described in I.E.C. Publication 149.

DIMENSIONS OF BASES

In the outline drawings of bases given below, some main dimensions (in mm) only have been given.

For further details is referred to IEC publication 67.

The page number on which the outline drawing can be found in this publication is therefore given for each base type.

MINIATURE 7-PIN BASE
(IEC 67-I-10a)

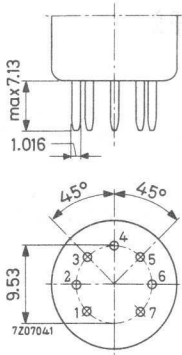

RIMLOCK BASE
(IEC 67-I-11b)

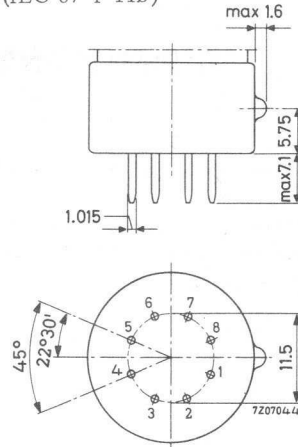

OCTAL BASE
(IEC 67-I-5a)

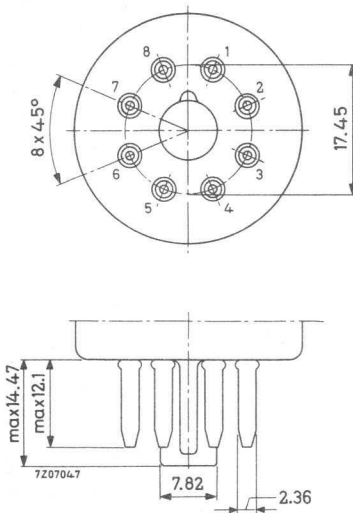

NEO EIGHTAR BASE
(IEC 67-I-31a)

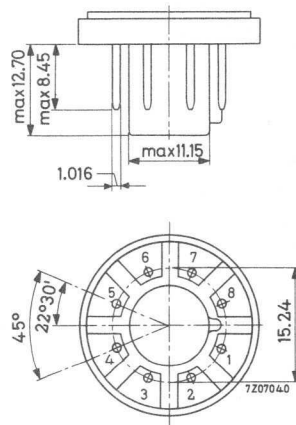

NOVAL BASE
(IEC 67-I-12a)

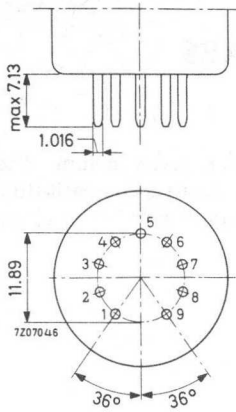

MAGNOVAL BASE
(IEC 67-I-36a)

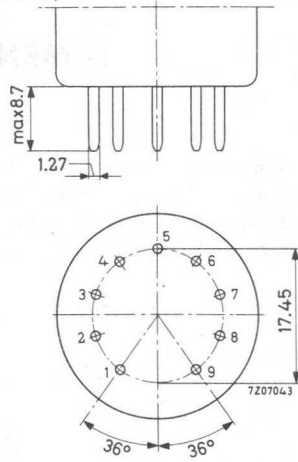

DECAL BASE
(IEC 67-I-41a)

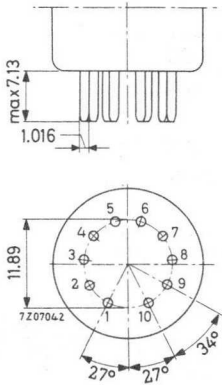

DUODECAL BASE
(IEC 67-I-17a)

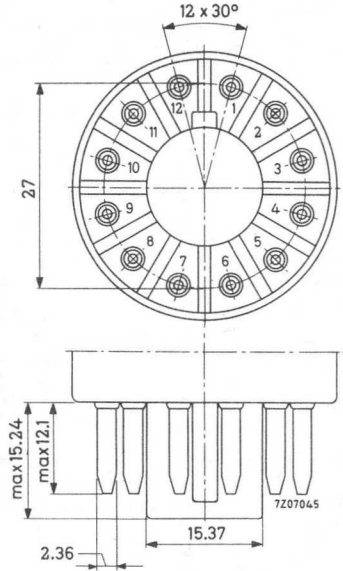

DIMENSIONS OF CAPS

The dimensions for the drawings of top caps have been given in mm. The dimensions A, B and C, which are those necessary to ensure compatibility between cap and corresponding connector are in accordance with IEC publication 67, page 67-III-1 a.

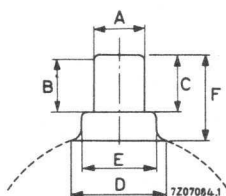

Type 1

ref.	min.	nom.	max.
A	6.23	6.35	6.47
B	5.1		
C		7.14	8.89 ¹⁾
D			11.5
E		9.15	
F		10.31	11.43 ¹⁾

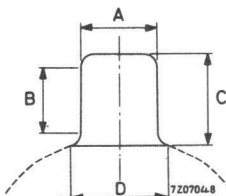

Type 2

A	9.02	9.14	9.27
B	7.7		
C		10.31	11.43 ¹⁾
D			11.5

¹⁾ Without solder. On finished article an increase of 0,5 mm is allowed on this dimension for solder.

Receiving Tubes

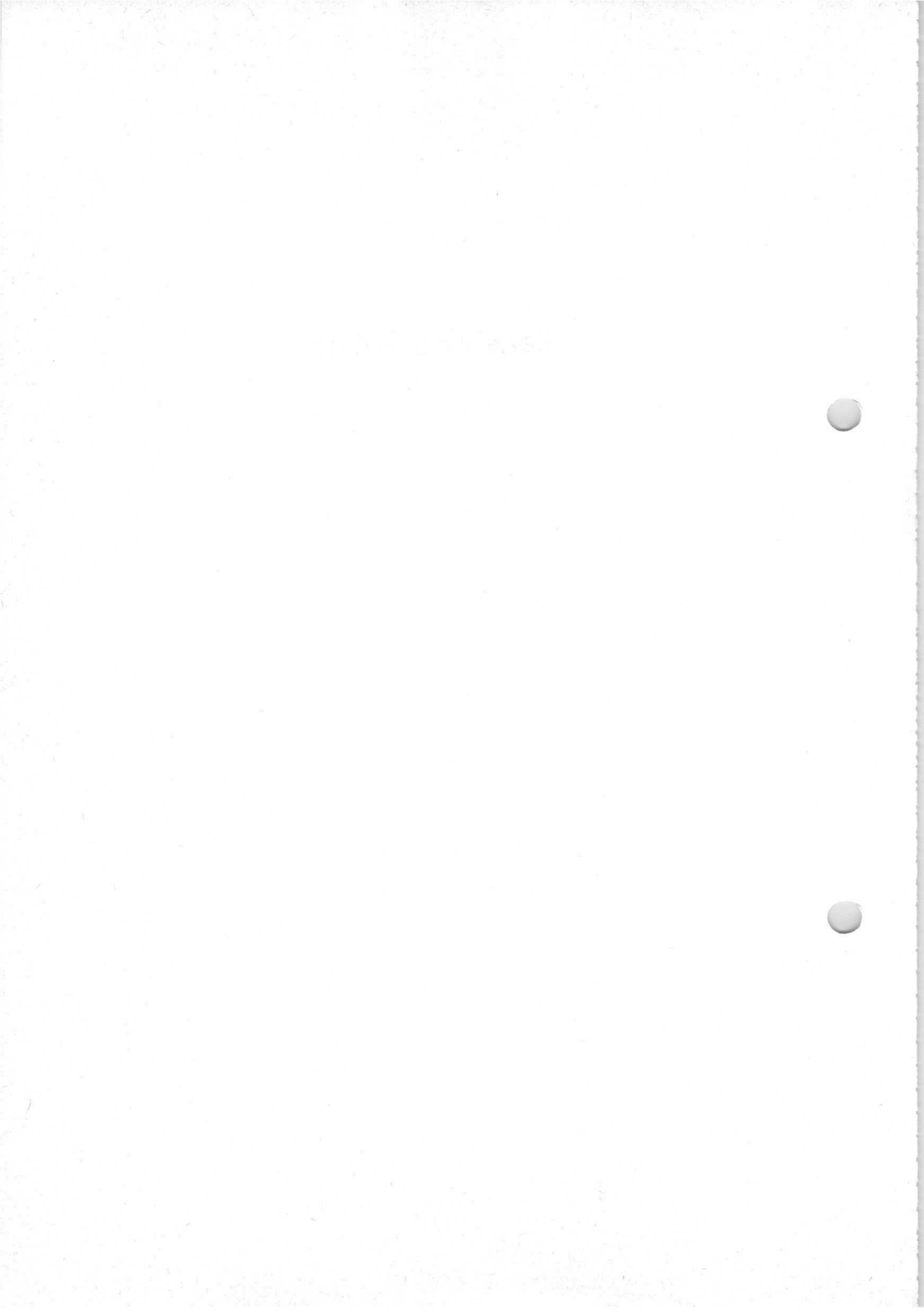

SINGLE ANODE E.H.T. RECTIFYING TUBE

Single anode high vacuum rectifying tube intended for use in portable T.V. receivers.

HEATING: Indirect; parallel supply

Heater voltage

$$\frac{V_f}{I_f} = \frac{1.4}{550} \frac{V}{mA}$$

Heater current

$$I_f = 550 \text{ mA}$$

DIMENSIONS AND CONNECTIONS

Dimensions in mm

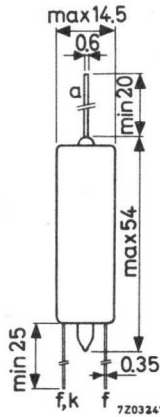
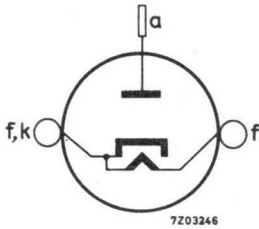

The tube has flexible leads, which must not be bent nearer than 10 mm to the tube bottom.

The leads should not be soldered nearer than 1.5 mm to the seal.

CAPACITANCE

Anode to all

$$C_a = 0.8 \text{ pF}$$

TYPICAL CHARACTERISTICS

Anode voltage

$$V_a = 100 \text{ V}$$

Anode current

$$I_a = 13 \text{ mA}$$

LIMITING VALUES (Design centre rating system, unless otherwise specified)

Anode voltage, negative peak	$-V_{ap}$	max.	15	kV
Anode voltage, negative peak (abs. max.)	$-V_{ap}$	max.	18	kV
Anode current, average	I_a	max.	350	μA
Anode current, peak	I_{ap}	max.	40	mA ¹⁾
Filter input capacitance	C_{filt}	max.	2000	pF
Heater voltage ($I_a < 200 \mu A$) (abs. max.)	V_f	max.	1.6	V
Heater voltage ($I_a > 200 \mu A$) (abs. max.)	V_f	min.	1.3	V

1) Max. duration is 10 % of a line-scanning cycle, but max. 10 μ sec.

SINGLE ANODE E.H.T. RECTIFYING TUBES

High-vacuum single-anode rectifying tubes for high tension in television receivers (E.H.T. supply from the line time base).

The DY86 and DY87 are equivalent except for the DY87 having a chemically treated envelope which avoids flash-over under conditions of high humidity and low atmospheric pressure (45 cm Hg).

HEATING: Indirect by A.C. or D.C.; parallel supply

Heater voltage	V_f	1.4 V
Heater current	I_f	550 mA

When the heater is to be operated on R.F. or flyback pulses, the heater voltage can be adjusted to 1.4 V e.g. by measurement with a thermocouple.

Tolerances of V_f

a. As E.H.T. rectifier in television receivers

The heater voltage should be adjusted to its nominal value at a D.C. output current of $200\mu\text{A}$. At an increase of the D.C. output current to 400 to $600\mu\text{A}$ which can incidentally occur during operation the decrease of the heater voltage may amount to max. 15 %. These requirements hold for nominal mains voltage and full horizontal scanning of the picture tube. If the picture width control is such that also the heater voltage of the E.H.T. diode is influenced, the influence of this control must be kept within the 15 % limit indicated above.

b. For all other applications the limits for the heater voltage are as given in the application directions in front of this section.

DIMENSIONS AND CONNECTIONS

Dimensions in mm

Base: NOVAL

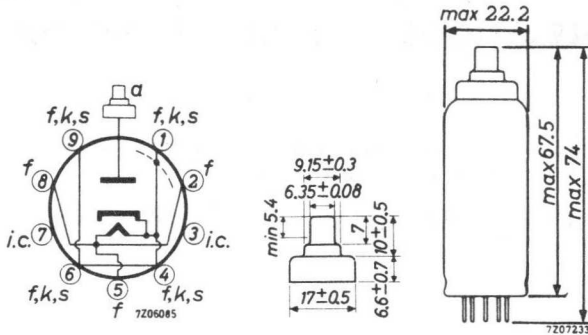

REMARKS

- Pins 1, 4, 6 and 9 can be used for fixing an anti-corona ring.
- Circuit elements having the same potential as the heater (e.g. a series resistor) may be connected to pins 3 and 7. These pins must never be earthed.
- If the tube operates at high values of $V_{a\ in\ v\ p}$ and/or under conditions of high relative humidity or low pressure the metal top-cap should get an insulating cover to avoid corona phenomena.

CAPACITANCES (without external shield)

Anode to all C_a 1.55 pF

OPERATING CHARACTERISTICS

Output current I_o 0.15 mA
 Output voltage V_o 18 kV

LIMITING VALUES (Design centre rating system unless otherwise stated)

Output voltage	V_o	max.	18 kV
Peak inverse voltage	$V_{a\text{ inv}p}$	max.	22 kV ¹⁾
Peak inverse voltage (Absolute max.)	$V_{a\text{ inv}p}$	max.	27 kV ¹⁾
Peak inverse voltage without current	$V_{a\text{ inv}p}(I_o = 0)$	max.	24 kV ¹⁾
Output current	I_o	max.	0.5 mA ²⁾
Peak output current	I_{ap}	max.	40 mA ³⁾
Filter input capacitance	C_{filt}	max.	2000 pF

1) Maximum pulse duration 22 % of a line scanning cycle with a maximum of 18 μsec .

The negative peak anode voltage due to ringing in the line-output transformer must be taken into account. The ratio between this negative peak value and the positive D.C. voltage can be about 1:4.5.

2) During short periods as in television service $I_o = \text{max. } 0.8 \text{ mA}$.

3) Maximum pulse duration 10 % of a line scanning cycle with a maximum of 10 μsec .

DY86
DY87

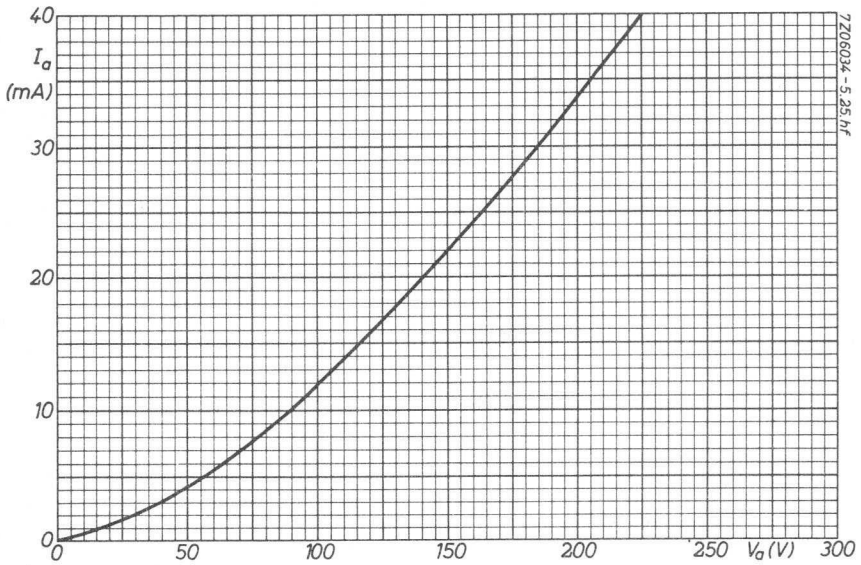

E.H.T. RECTIFYING TUBE

High-vacuum single-anode rectifying tube for high-tension in television receivers (E.H.T. supply from the line time base)

The DY802 has a chemically treated envelope which avoids flash-over under conditions of high humidity and low atmospheric pressure (45 cm Hg).

HEATING: Indirect by A.C. or D.C.; parallel supply

Heater voltage	V_f	1.4 V
Heater current	I_f	600 mA

Tolerances of V_f

a. As E.H.T. rectifier in television receivers

The heater voltage should be adjusted to its nominal value at a D.C. output current of 200 μ A. At an increase of the D.C. output current to 400-800 μ A which can incidentally occur during operation the decrease of the heater voltage may amount to max. 15%. These requirements hold for nominal mains voltage and full horizontal scanning of the picture tube. If the picture width control is such that also the heater voltage of the E.H.T. diode is influenced, the influence of this control must be kept within the 15% limit indicated above.

b. For all other applications the limits for the heater voltage are as given in the application directions.

DIMENSIONS AND CONNECTIONS

Dimensions in mm

Base: Noval

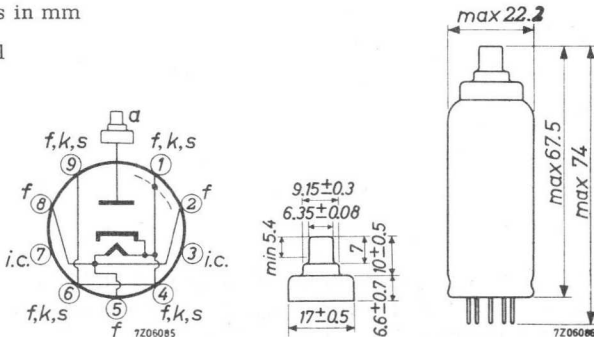

REMARKS

- a. Pins 1, 4, 6 and 9 can be used for fixing an anti-corona ring.
- b. Circuit elements having the same potential as the heater (e.g. a series resistor) may be connected to pins 3 and 7. These pins must never be earthed.
- c. If the tube operates a high values of $V_{a\text{invp}}$ and/or under conditions of high relative humidity or low pressure the metal top-cap should get an insulating cover to avoid corona phenomena.

CAPACITANCE

Anode to all C_a 1.0 pF

OPERATING CHARACTERISTICS

Output current I_o 200 μA
 Output voltage V_o 20 kV

LIMITING VALUES (Design centre rating system unless otherwise stated)

Output voltage	V_o	max.	20 kV
Peak inverse voltage	$V_{a\text{invp}}$	max.	25 kV ¹⁾
Peak inverse voltage (Abs. max.)	$V_{a\text{invp}}$	max.	30 kV ¹⁾
Output current, average	I_o	max.	500 μA ²⁾
peak	I_{op}	max.	50 mA
Filter input capacitance	C_{filt}	max.	3000 pF

¹⁾ Max. duration 22% of a line scanning cycle and maximum 18 μs .
 The negative peak anode voltage due to ringing in the line-output transformer must be taken into account.

²⁾ During short periods as in TV operation $I_o = \text{max. } 800 \mu A$.

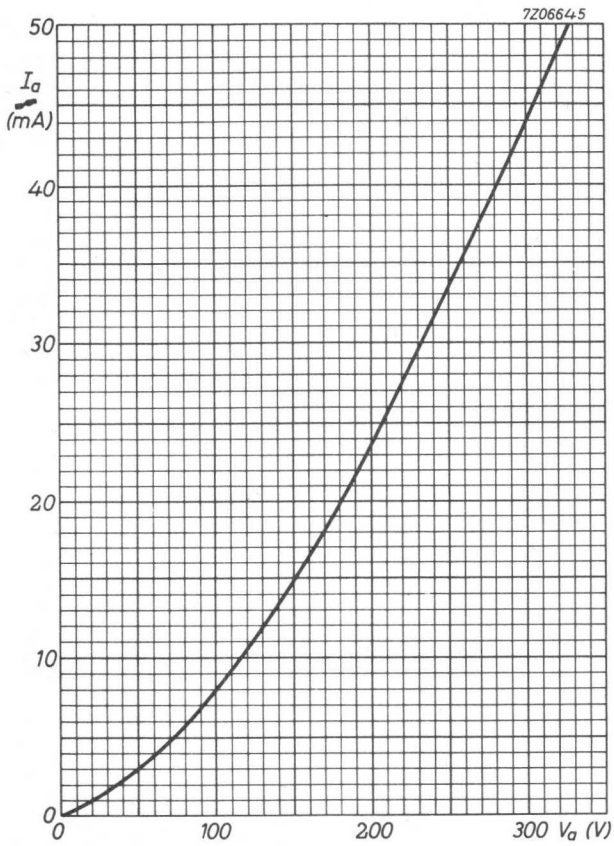

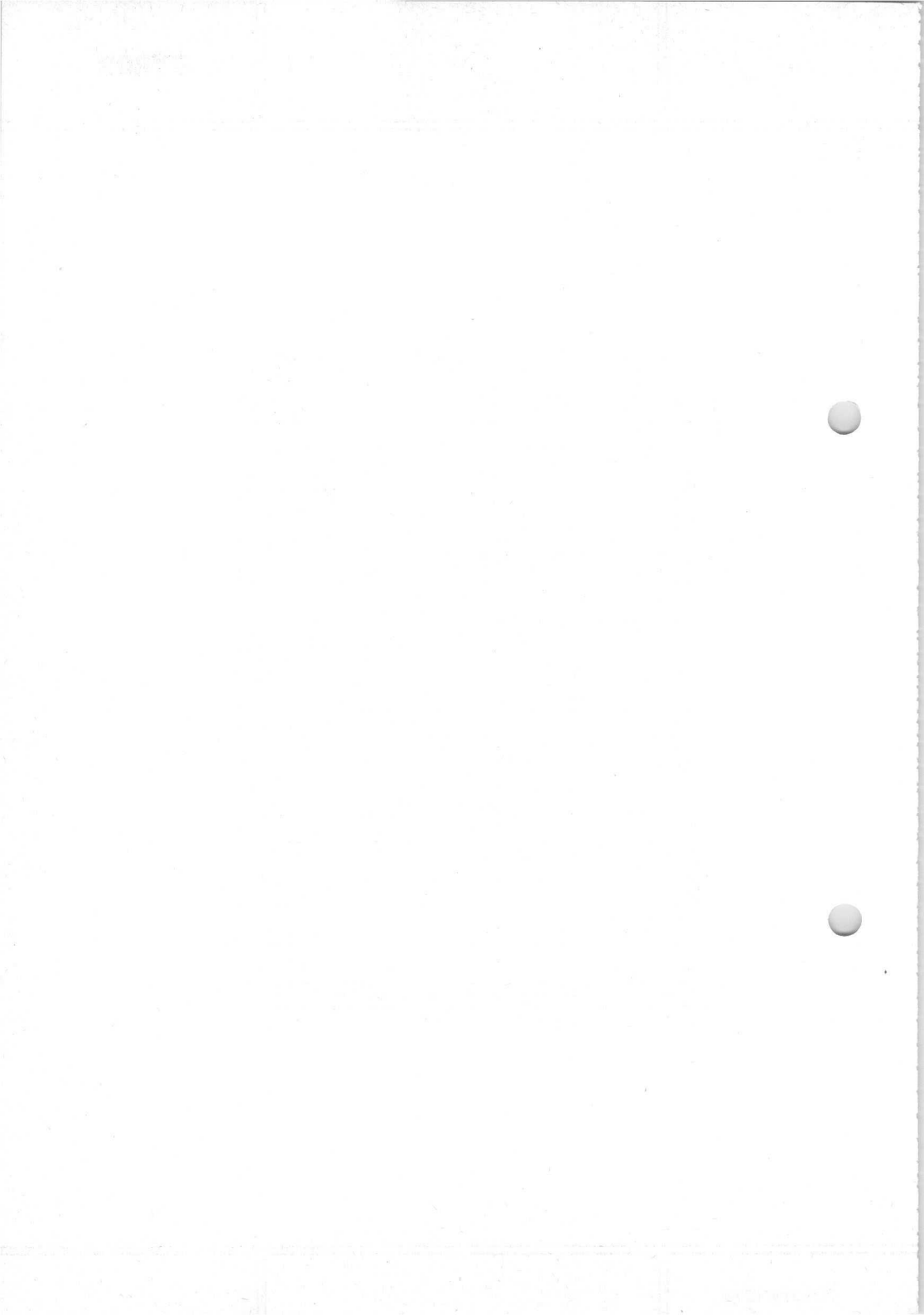

DOUBLE DIODE

Double diode with separate cathodes.

QUICK REFERENCE DATA		
A.C. supply voltage	V_{tr}	150 V_{RMS}
D.C. current per system	I_o	9 mA

HEATING: Indirect by A.C. or D.C.; series or parallel supply

Heater voltage	V_f	6.3 V
Heater current	I_f	300 mA

DIMENSIONS AND CONNECTIONS

Dimensions in mm

Base: Miniature

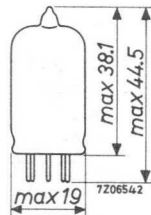
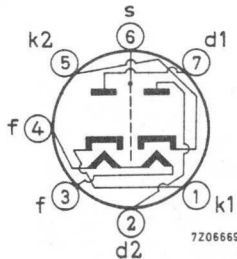

CAPACITANCES

	With external shield	Without external shield
Diode No. 1 to all	C_{d1} 3.0	2.5 pF
Diode No. 2 to all	C_{d2} 3.0	2.5 pF
Diode No. 1 to diode No. 2	C_{d1d2} max. 0.026	max. 0.068 pF
Cathode No. 1 to all	C_{k1} 3.4	3.4 pF
Cathode No. 2 to all	C_{k2} 3.4	3.4 pF

LIMITING VALUES Design centre rating system. (Each system)

Diode voltage, negative peak	$-V_{d_p}$	max. 420 V
Diode current	I_d	max. 9 mA
Diode current, peak	I_{d_p}	max. 54 mA
Cathode to heater voltage peak (k neg)	V_{kf_p} (k neg)	max. 150 V
Cathode to heater voltage, peak (k pos)	V_{kf_p} (k pos)	max. 330 V
	D.C. component	max. 200 V
	A.C. component	max. 165 V _{RMS}

As half wave rectifier

A.C. supply voltage	V_{tr}	max. 150 V _{RMS}
D.C. current	I_o	max. 9 mA
Input capacitor of smoothing filter	C_{filt}	max. 8 μF
Protecting resistance	R_t	min. 300 Ω
Cathode to heater voltage, peak (k pos)	V_{kf_p} (k pos)	max. 330 V
	D.C. component	max. 200 V
	A.C. component	max. 165 V _{RMS}

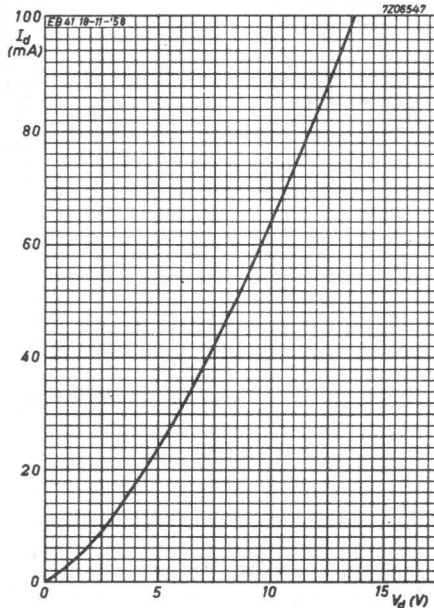

TRIPLE DIODE-TRIODE

Triple diode-triode intended for F.M. and A.M. signal detection and A.F. signal amplification.

QUICK REFERENCE DATA

<u>Triode section</u>			
Anode current	I_a	0.8	mA
Transconductance	S	1.45	mA/V
Amplification factor	μ	70	-

HEATING: Indirect by A.C. or D.C.; parallel supply

Heater voltage

V_f 6.3 V

Heater current

I_f 480 mA

DIMENSIONS AND CONNECTIONS

Dimensions in mm

Base: Noval

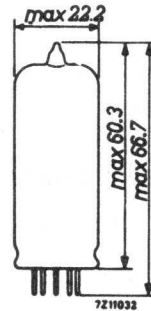
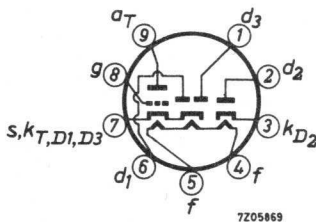

CAPACITANCES

Triode section

Grid to all except anode	$C_{g(a)}$	1.9	pF
Anode to all except grid	$C_{a(g)}$	1.4	pF
Anode to grid	C_{ag}	2.0	pF
Grid to heater	C_{gf}	max. 0.04	pF

Diode sections

Diode No.1 to all	C_{d1}	0.8	pF
Diode No.2 to all	C_{d2}	4.8	pF
Diode No.3 to all	C_{d3}	4.8	pF
Cathode (D ₂) to all	C_{kD_2}	4.9	pF
Diode No.1 to heater	C_{d1f}	max. 0.25	pF
Diode No.3 to heater	C_{d3f}	max. 0.2	pF
Cathode (D ₂) to heater	C_{kD_2f}	2.5	pF

Between triode and diode sections

Anode to diode No.1	C_{ad1}	max. 0.12	pF
Anode to diode No.3	C_{ad3}	max. 0.1	pF
Anode to cathode (D ₂)	C_{akD_2}	max. 0.01	pF
Grid to diode No.1	C_{gd1}	max. 0.07	pF
Grid to diode No.3	C_{gd3}	max. 0.02	pF
Grid to cathode (D ₂)	C_{gkD_2}	max. 0.005	pF

TYPICAL CHARACTERISTICS Triode section

Anode voltage	V_a	100	250	V
Grid voltage	V_g	-1	-3	V
Anode current	I_a	0.8	1.0	mA
Transconductance	S	1.45	1.4	mA/V
Amplification factor	μ	70	70	-
Internal resistance	R_i	48	50	k Ω

OPERATING CHARACTERISTICS

Triode section as RC coupled A.F. amplifier

Grid resistor $R_g = 10 \text{ M}\Omega$

Supply voltage	V_b	250	250	250	200	200	200	V
Anode resistor	R_a	220	100	47	220	100	47	$\text{k}\Omega$
Grid resistor next stage	$R_{g'}$	0.68	0.33	0.15	0.68	0.33	0.15	$\text{M}\Omega$
Anode current	I_a	0.76	1.40	2.20	0.56	1.00	1.60	mA
Voltage gain	V_o/V_i	54	47	36	53	44	34	-

Distortion:

at output voltage $V_o = 3 \text{ V}_{\text{RMS}}$	d_{tot}	0.2	0.25	0.3	0.3	0.4	0.5	%
at output voltage $V_o = 5 \text{ V}_{\text{RMS}}$	d_{tot}	0.25	0.5	0.6	0.4	0.6	0.9	%
at output voltage $V_o = 8 \text{ V}_{\text{RMS}}$	d_{tot}	0.6	0.8	1.0	0.9	1.0	1.5	%

Supply voltage	V_b	170	170	170	100	100	100	V
Anode resistor	R_a	220	100	47	220	100	47	$\text{k}\Omega$
Grid resistor next stage	$R_{g'}$	0.68	0.33	0.15	0.68	0.33	0.15	$\text{M}\Omega$
Anode current	I_a	0.46	0.82	1.25	0.21	0.35	0.52	mA
Voltage gain	V_o/V_i	51	42	32	44	35	26	-

Distortion:

at output voltage $V_o = 3 \text{ V}_{\text{RMS}}$	d_{tot}	0.4	0.5	0.6	1.0	1.3	2.0	%
at output voltage $V_o = 5 \text{ V}_{\text{RMS}}$	d_{tot}	0.5	0.8	1.1	1.7	2.3	4.3	%
at output voltage $V_o = 8 \text{ V}_{\text{RMS}}$	d_{tot}	1.1	1.3	2.0	-	-	-	%

TYPICAL CHARACTERISTICS Diode sections

Internal resistance diode No.1 Diode voltage $V_{d1} = +10$ V	R_{iD1}	5 k Ω
Internal resistance diode No.2 Diode voltage $V_{d2} = +5$ V	R_{iD2}	200 Ω
Internal resistance diode No.3 Diode voltage $V_{d3} = +5$ V	R_{iD3}	200 Ω
Ratio between R_{iD2} and R_{iD3}	R_{iD2}/R_{iD3}	min. 0.67 max. 1.5

MICROPHONY Triode section

No special precautions against microphony are required in circuits where the input voltage is min. 10 mV for 50 mW output of the output tube at frequencies higher than 800 Hz. At lower frequencies the sensitivity may be increased according to figure 1.

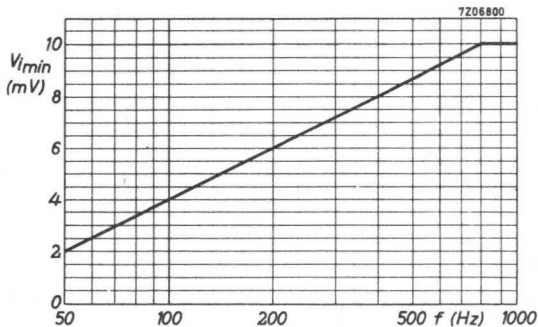

fig. 1

LIMITING VALUES (Design centre rating system)Triode section

Anode voltage	V_{a0}	max. 550 V
	V_a	max. 300 V
Anode dissipation	W_a	max. 1 W
Cathode current	I_k	max. 5 mA
Grid resistor	R_g	max. 3 M Ω
Grid resistor (grid current bias)	R_g	max. 22 M Ω
Cathode to heater voltage	V_{kf}	max. 150 V

Diode sections

Diode No.1 voltage, peak negative	$-V_{d1p}$	max. 350 V
Diode No.2 voltage, peak negative	$-V_{d2p}$	max. 350 V
Diode No.3 voltage, peak negative	$-V_{d3p}$	max. 350 V
Diode No.1 current:		
D.C. component	I_{d1}	max. 1 mA
peak	I_{d1p}	max. 6 mA
Diode No.2 current:		
D.C. component	I_{d2}	max. 10 mA
peak	I_{d2p}	max. 75 mA
Diode No.3 current:		
D.C. component	I_{d3}	max. 10 mA
peak	I_{d3p}	max. 75 mA
Cathode (D ₂) to heater voltage	$V_{kD2/f}$	max. 150 V

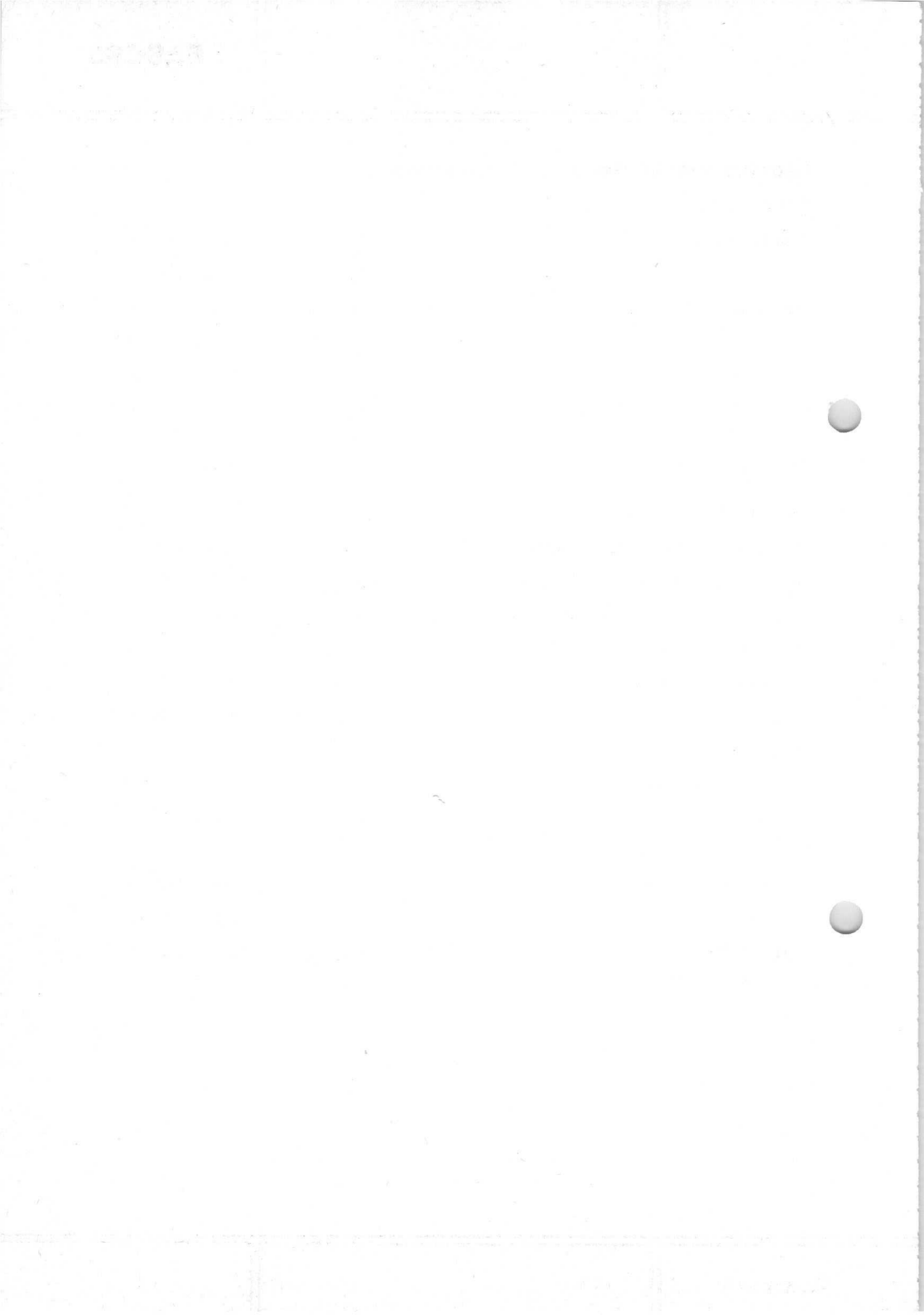

DOUBLE DIODE

Double diode with separate cathodes.

HEATING: Indirect by A. C. or D. C. ; series or parallel supply

Heater voltage

V_f 6.3 V

Heater current

I_f 300 mA

DIMENSIONS AND CONNECTIONS

Dimensions in mm

Base: Miniature

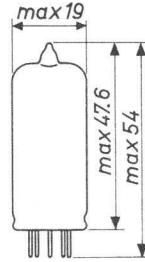
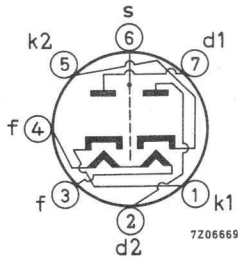

 For further data
 please refer to type EAA91

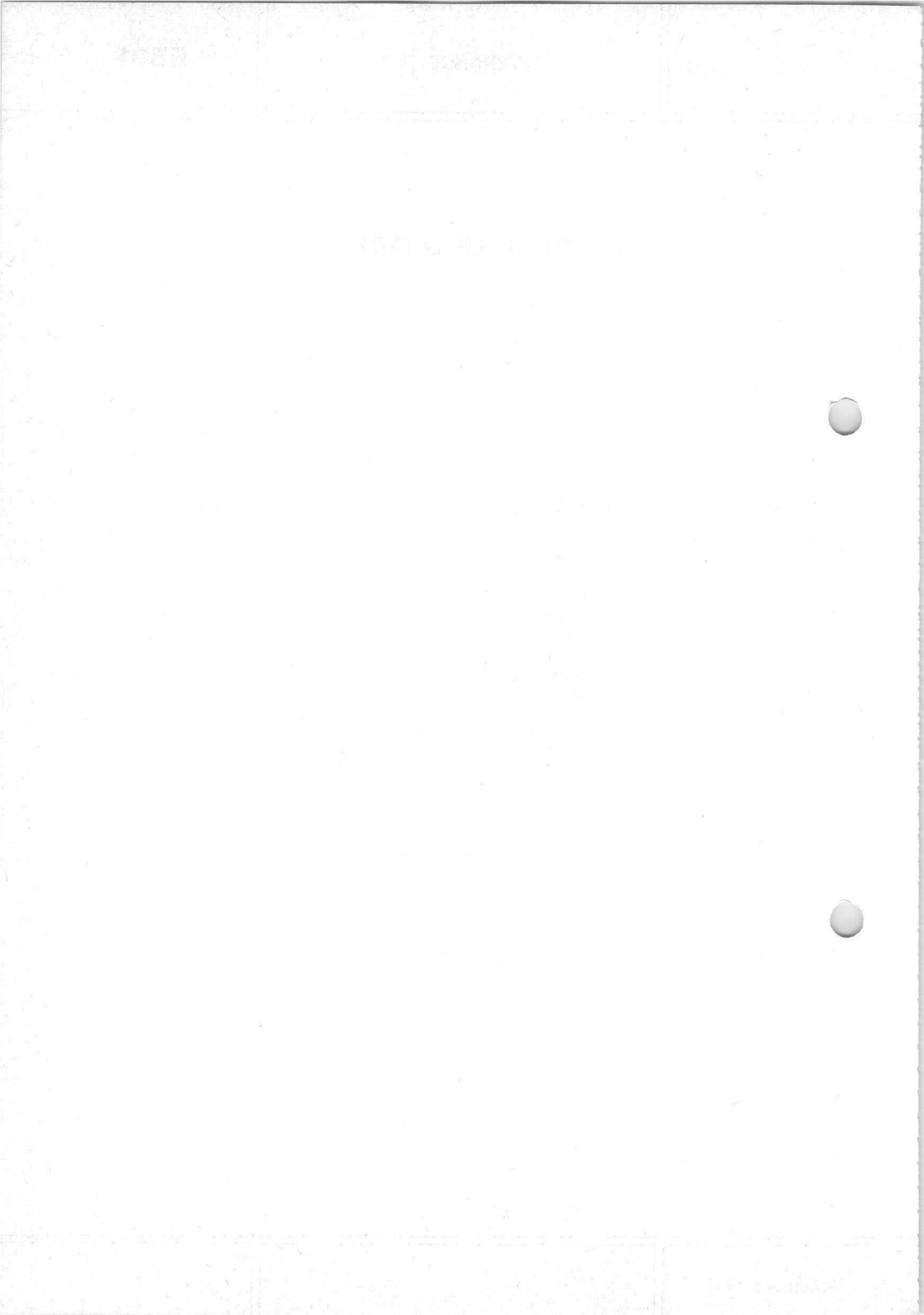

DOUBLE DIODE-TRIODE

Double diode-triode. Triode intended for use as A.F. amplifier.

QUICK REFERENCE DATA

<u>Triode section</u>			
Anode current	I_a	1.0	mA
Transconductance	S	1.2	mA/V
Amplification factor	μ	70	-

HEATING: Indirect by A.C. or D.C.; parallel supply

Heater voltage

V_f 6.3 V

Heater current

I_f 230 mA

DIMENSIONS AND CONNECTIONS

Dimensions in mm

Base: Noval

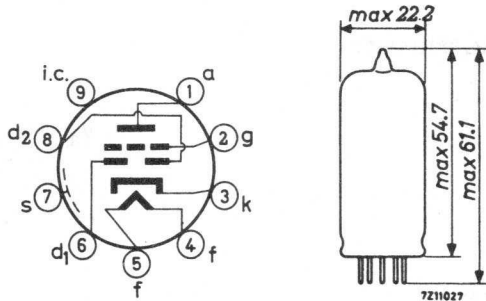

CAPACITANCES

Triode section

Grid to all except anode	$C_{g(a)}$	2.3 pF
Anode to all except grid	$C_{a(g)}$	2.3 pF
Anode to grid	C_{ag}	1.2 pF
Grid to heater	C_{gf}	max. 0.05 pF

Diode sections

Diode No. 1 to all	C_{d1}	0.9 pF
Diode No. 2 to all	C_{d2}	0.9 pF
Diode No. 1 to diode No. 2	C_{d1d2}	max. 0.2 pF
Diode No. 1 to heater	C_{d1f}	max. 0.25 pF
Diode No. 2 to heater	C_{d2f}	max. 0.05 pF

Between diode and triode sections

Diode No. 1 to grid	C_{d1g}	max. 0.007 pF
Diode No. 2 to grid	C_{d2g}	max. 0.007 pF
Diode No. 1 to anode	C_{d1a}	max. 0.005 pF
Diode No. 2 to anode	C_{d2a}	max. 0.010 pF

TYPICAL CHARACTERISTICS

Triode section

Anode voltage	V_a	250 V
Grid voltage	V_g	-3 V
Anode current	I_a	1.0 mA
Transconductance	S	1.2 mA/V
Amplification factor	μ	70 -
Internal resistance	R_i	58 k Ω
Equivalent noise resistance (A.F.)	R_{eq}	max. 150 k Ω

OPERATING CHARACTERISTICS

Triode section as A.F. amplifier, circuit Fig.1

Supply voltage	V_b	250	250	250	250	V
Anode resistor	R_a	0.22	0.1	0.22	0.1	$M\Omega$
Cathode resistor	R_k	1.8	1.2	0	0	$k\Omega$
Grid resistor	R_g	1	1	22	22	$M\Omega$
Grid resistor next stage	$R_{g'}$	0.68	0.33	0.68	0.33	$M\Omega$
Anode current	I_a	0.70	1.15	0.76	1.40	mA
Voltage gain	V_o/V_i	51	43	52	44	-
Distortion:						
at output voltage $V_o = 5 V_{RMS}$	d_{tot}	0.55	0.6	0.5	0.7	%
at output voltage $V_o = 10 V_{RMS}$	d_{tot}	0.9	1.1	0.8	0.9	%

Microphony

No special precautions against microphony are required in circuits where the input voltage is min. 10 mV for 50 mW output of the output tube.

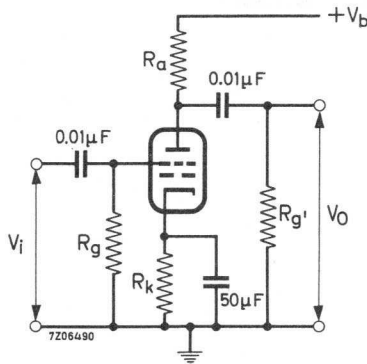

fig.1

LIMITING VALUES (Design centre rating system)

Triode section

Anode voltage	V_{a0}	max. 550 V
	V_a	max. 300 V
Anode dissipation	W_a	max. 0.5 W
Cathode current	I_k	max. 5 mA
Grid resistor	R_g	max. 3 $M\Omega$
Cathode to heater voltage	V_{kf}	max. 100 V

Diode sections (each diode)

Diode voltage, negative peak	$-V_{dp}$	max. 350 V
Diode current, average	I_d	max. 0.8 mA
peak	I_{dp}	max. 5 mA
Cathode to heater voltage	V_{kf}	max. 100 V

Note

The use of a socket with skirt is advisable to reduce the capacitances between tube elements and external conductors.

DOUBLE DIODE-PENTODE

Double diode-pentode. Pentode intended for use as R.F., I.F., or A.F. amplifier.

QUICK REFERENCE DATA

<u>Pentode section</u>			
Variable transconductance			
Anode current	I_a	5	mA
Transconductance	S	2.2	mA/V
Amplification	$\mu_{g_2g_1}$	18	-

HEATING: Indirect by A.C. or D.C.; parallel or series supply.

Heater voltage	V_f	6.3	V
Heater current	I_f	300	mA

DIMENSIONS AND CONNECTIONS

Dimensions in mm

Base: Noval

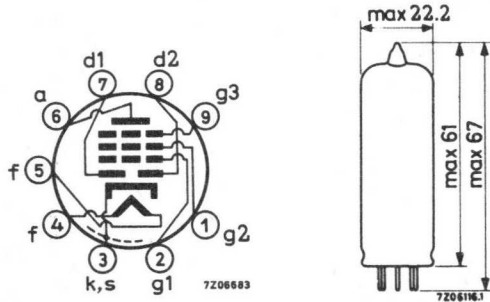

CAPACITANCES

Pentode section

Anode to all except grid No.1	$C_{a(g_1)}$	4.9 pF
Grid No.1 to all except anode	$C_{g_1(a)}$	4.2 pF
Anode to grid No.1	C_{ag_1}	max. 0.0025 pF
Grid No.1 to heater	C_{g_1f}	max. 0.07 pF

Diode section

Diode No.1 to all	C_{d_1}	2.2 pF
Diode No.2 to all	C_{d_2}	2.35 pF
Diode No.1 to diode No.2	$C_{d_1d_2}$	max. 0.35 pF
Diode No.1 to heater	C_{d_1f}	max. 0.02 pF
Diode No.2 to heater	C_{d_2f}	max. 0.005 pF

Between diode and pentode sections

Diode No.1 to grid No.1	$C_{d_1g_1}$	max. 0.0008 pF
Diode No.2 to grid No.1	$C_{d_2d_1}$	max. 0.001 pF
Diode No.1 to anode	C_{d_1a}	max. 0.2 pF
Diode No.2 to anode	C_{d_2a}	max. 0.05 pF

OPERATING CHARACTERISTICS

Pentode section as R.F. or I.F. amplifier

Supply voltage	V_b	250	V
Anode resistor	R_a	0	Ω
Grid No.3 voltage	V_{g_3}	0	V
Grid No.2 resistor	R_{g_2}	95	$k\Omega$
Cathode resistor	R_k	300	Ω
Grid No.1 voltage	V_g	-2	-41.5 V
Grid No.2 voltage	V_{g_2}	85	250 V
Anode current	I_a	5	- mA
Grid No.2 current	I_{g_2}	1.75	- mA
Transconductance	S	2200	22 $\mu A/V$
Internal resistance	R_i	1.4	min.10 $M\Omega$
Amplification factor	$\mu_{g_2g_1}$	18	- -
Equivalent noise resistance	R_{eq}	6.8	- $k\Omega$

Pentode section as resistance coupled A.F. amplifier, circuit fig.1.

Supply voltage	V_b	250	250	250	250	V
Anode resistor	R_a	0.22	0.1	0.22	0.1	$M\Omega$
Grid No.2 resistor	R_{g_2}	0.82	0.39	1.0	0.47	$M\Omega$
Grid No.1 resistor	R_{g_1}	1	1	10	10	$M\Omega$
Cathode resistor	R_k	1800	1000	0	0	Ω
Grid No.1 resistor next stage	$R_{g'}$	0.68	0.33	0.68	0.33	$M\Omega$
Anode current	I_a	0.75	1.5	0.75	1.5	mA
Grid No.2 current	I_{g_2}	0.30	0.53	0.25	0.50	mA
Voltage gain	V_o/V_i	110	80	160	110	-

Distortion:

at output voltage $V_o = 3 V_{RMS}$	d_{tot}	0.8	0.9	0.8	0.8	%
at output voltage $V_o = 5 V_{RMS}$	d_{tot}	1.3	1.5	1.4	1.4	%
at output voltage $V_o = 8 V_{RMS}$	d_{tot}	2.0	2.2	2.1	2.1	%

OPERATING CHARACTERISTICS (continued)

Pentode section, triode connected (g_2 connected to anode) as resistance coupled A.F. amplifier.

Supply voltage	V_b	250	250	250	250	V
Anode resistor	R_a	0.1	0.047	0.1	0.047	$M\Omega$
Grid No.1 resistor	R_{g1}	1	1	10	10	$M\Omega$
Cathode resistor	R_k	820	560	0	0	Ω
Grid No.1 resistor next stage	$R_{g'}$	0.33	0.15	0.33	0.15	$M\Omega$
Anode current	I_a	2.08	4.10	2.16	4.50	mA
Voltage gain	V_o/V_i	14	13	15	15	-
Distortion:						
at output voltage $V_o = 3 V_{RMS}$	d_{tot}	1.6	1.3	2.0	1.7	%
at output voltage $V_o = 5 V_{RMS}$	d_{tot}	2.5	2.0	3.1	2.7	%
at output voltage $V_o = 8 V_{RMS}$	d_{tot}	4.3	2.9	4.8	4.1	%

LIMITING VALUES (Design centre rating system)

Pentode section

Anode voltage	V_{a0}	max.	550	V
	V_a	max.	300	V
Anode dissipation	W_a	max.	1.5	W
Grid No.2 voltage	V_{g20}	max.	550	V
at anode current $I_a = \text{max. } 2.5 \text{ mA}$	V_{g2}	max.	300	V
at anode current $I_a = 5 \text{ mA}$	V_{g2}	max.	125	V
Grid No.2 dissipation	W_{g2}	max.	0.3	W
Cathode current	I_k	max.	10	mA
Grid resistor, automatic bias	R_{g1}	max.	3	$M\Omega$
Grid resistor, grid current bias	R_{g1}	max.	22	$M\Omega$
Cathode to heater voltage	V_{kf}	max.	100	V

Microphony

No special precautions against microphony are required in circuits where the input voltage is min. 25 mV for an output of 50 mW of the output tube.

LIMITING VALUES (continued)

Diode section

Diode No.1 voltage, negative peak	$-V_{d_p}$	max. 350 V
Diode No.2 voltage, negative peak	$-V_{d_p}$	max. 350 V
Diode No.1 current	I_{d_1}	max. 0.8 mA
Diode No.2 current	I_{d_2}	max. 0.8 mA
Diode No.1 current, peak	$I_{d_{1p}}$	max. 5 mA
Diode No.2 current, peak	$I_{d_{2p}}$	max. 5 mA
Cathode to heater voltage	V_{kf}	max. 100 V

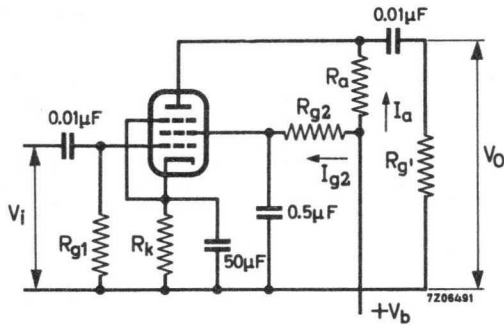
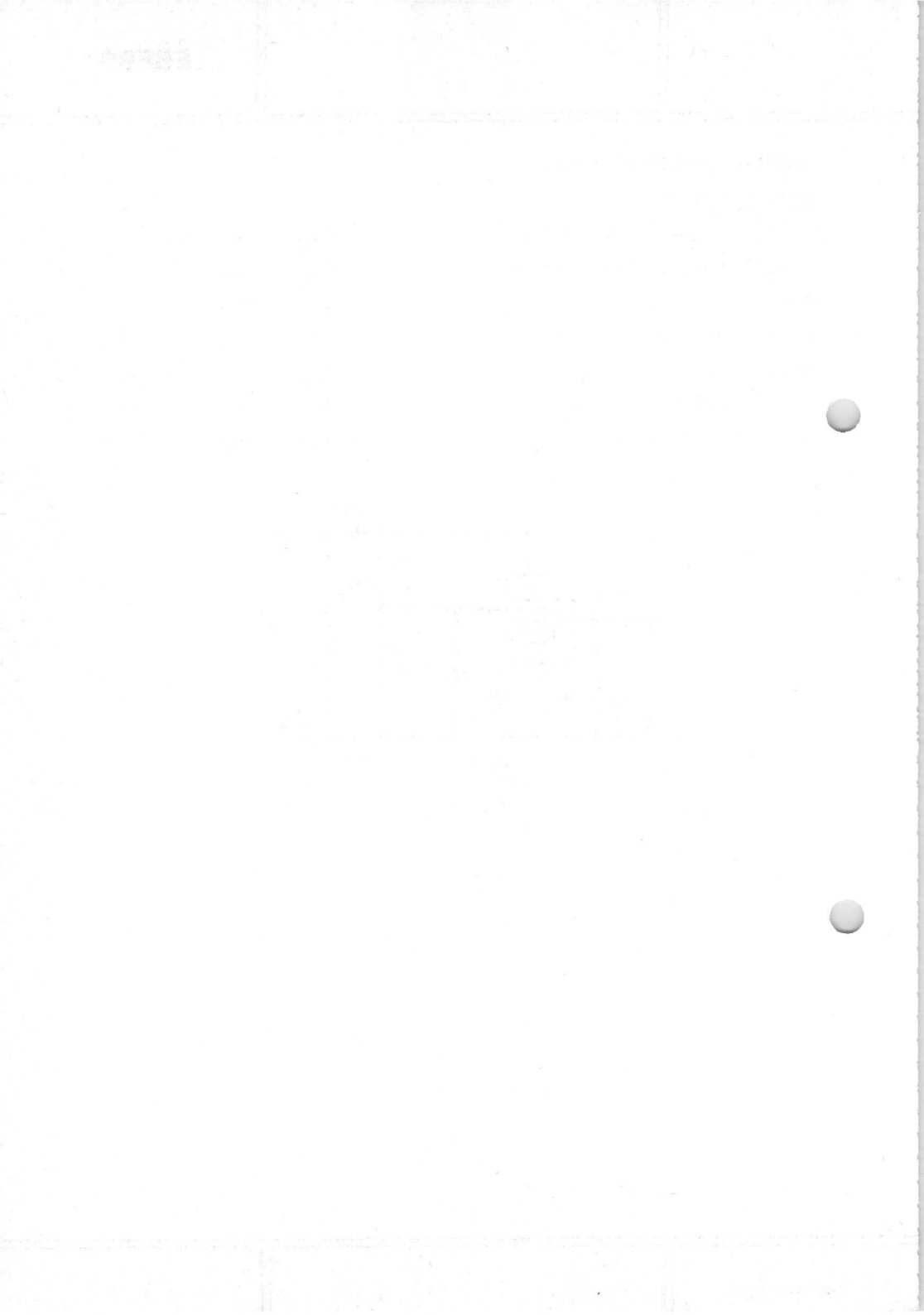

fig. 1



DOUBLE DIODE - PENTODE

Double diode-pentode. Pentode intended for use as R.F. or I.F. amplifier.

QUICK REFERENCE DATA			
<u>Pentode section</u>			
Variable transconductance			
Anode current	I_a	9	mA
Transconductance	S	4.5	mA/V
Amplification factor	$\mu_{g_2g_1}$	20	--

HEATING: Indirect by A.C. or D.C.; parallel or series supply

Heater voltage	V_f	6.3	V
Heater current	I_f	300	mA

DIMENSIONS AND CONNECTIONS

Dimensions in mm

Base: Noval

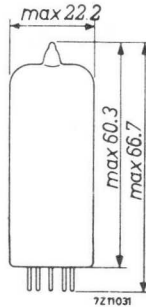
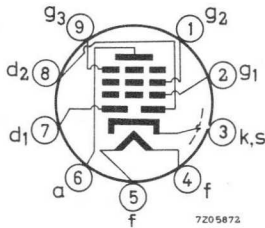

CAPACITANCESPentode section

Anode to all except grid No. 1	$C_{a(g_1)}$	5.2 pF
Grid No. 1 to all except anode	$C_{g_1(a)}$	5.0 pF
Anode to grid No. 1	C_{ag_1}	max. 0.0025 pF
Grid No. 1 to heater	C_{g_1f}	max. 0.05 pF

Diode sections

Diode No. 1 to all	C_{d_1}	2.5 pF
Diode No. 2 to all	C_{d_2}	2.5 pF
Diode No. 1 to diode No. 2	$C_{d_1d_2}$	max. 0.25 pF
Diode No. 1 to heater	C_{d_1f}	max. 0.015 pF
Diode No. 2 to heater	C_{d_2f}	max. 0.003 pF

Between diode and pentode sections

Diode No. 1 to grid No. 1	$C_{d_1g_1}$	max. 0.0008 pF
Diode No. 2 to grid No. 1	$C_{d_2g_1}$	max. 0.001 pF
Diode No. 1 to anode	C_{d_1a}	max. 0.15 pF
Diode No. 2 to anode	C_{d_2a}	max. 0.025 pF

TYPICAL CHARACTERISTICS

Pentode section

Anode voltage	V_a	250	250	200	170	V
Grid No. 2 voltage	V_{g_2}	100	80	100	100	V
Grid No. 3 voltage	V_{g_3}	0	0	0	0	V
Grid No. 1 voltage	V_{g_1}	-2	-1 1)	-1.5	-1 1)	V
Anode current	I_a	9	9	11	12	mA
Grid No. 2 current	I_{g_2}	2.7	2.7	3.3	4	mA
Transconductance	S	3.8	4.5	4.5	5	mA/V
Amplification factor	$\mu_{g_2g_1}$	20	20	20	20	-
Internal resistance	R_i	1.0	0.9	0.6	0.4	M Ω

OPERATING CHARACTERISTICS

Pentode section as R.F. or I.F. amplifier

Supply voltage	V_b	250	200	250	V			
Anode resistor	R_a	0	0	0	Ω			
Grid No. 3 voltage	V_{g_3}	0	0	0	V			
Grid No. 2 resistor	R_{g_2}	56	30	62	k Ω			
Grid No. 1 voltage	V_{g_1}	-2.0	-20	-1.5	-20	-1 1)	-20	V
Anode current	I_a	9	-	11	-	9	-	mA
Grid No. 2 current	I_{g_2}	2.7	-	3.3	-	2.7	-	mA
Transconductance	S	3.8	0.2	4.5	0.12	4.5	0.2	mA/V
Internal resistance	R_i	1.0	-	0.6	-	0.9	-	M Ω

1) To avoid grid No. 1 current the negative grid No. 1 voltage should be min. 1.5 V.

LIMITING VALUES (Design centre rating system)

Pentode section

Anode voltage	V_{a0}	max. 550 V
	V_a	max. 300 V ¹⁾
Anode dissipation	W_a	max. 2.25 W
Grid No. 2 voltage	V_{g20}	max. 550 V
Grid No. 2 voltage		
at anode current I_a max. 4 mA	V_{g2}	max. 300 V ¹⁾
at anode current I_a min. 8 mA	V_{g2}	max. 125 V
Grid No. 2 dissipation	W_{g2}	max. 0.45 W
Cathode current	I_k	max. 16.5 mA
Grid No. 1 resistor	R_{g1}	max. 3 M Ω
Grid No. 3 resistor	R_{g3}	max. 10 k Ω
Cathode to heater voltage	V_{kf}	max. 100 V

Diode sections (each diode)

Diode voltage, negative peak	$-V_{dp}$	max. 200 V
Diode current, average	I_d	max. 0.8 mA
peak	I_{dp}	max. 5 mA
Cathode to heater voltage	V_{kf}	max. 100 V

¹⁾ With supply from a storage battery and vibrator the max. voltage is 250 V.

U.H.F. TRIODE

Triode intended for use as grounded grid U.H.F. amplifier, oscillator or mixer for bands IV and V.

HEATING: Indirect by A.C. or D.C.; parallel supply

Heater voltage	V_f	6.3 V
Heater current	I_f	200 mA

LIMITING VALUES (Design centre rating system)

Cathode to heater voltage, (k pos)	V_{kf} (k pos)	max. 100 V
(k neg)	V_{kf} (k neg)	max. 50 V

 For further data and curves of this type
 please refer to PC86

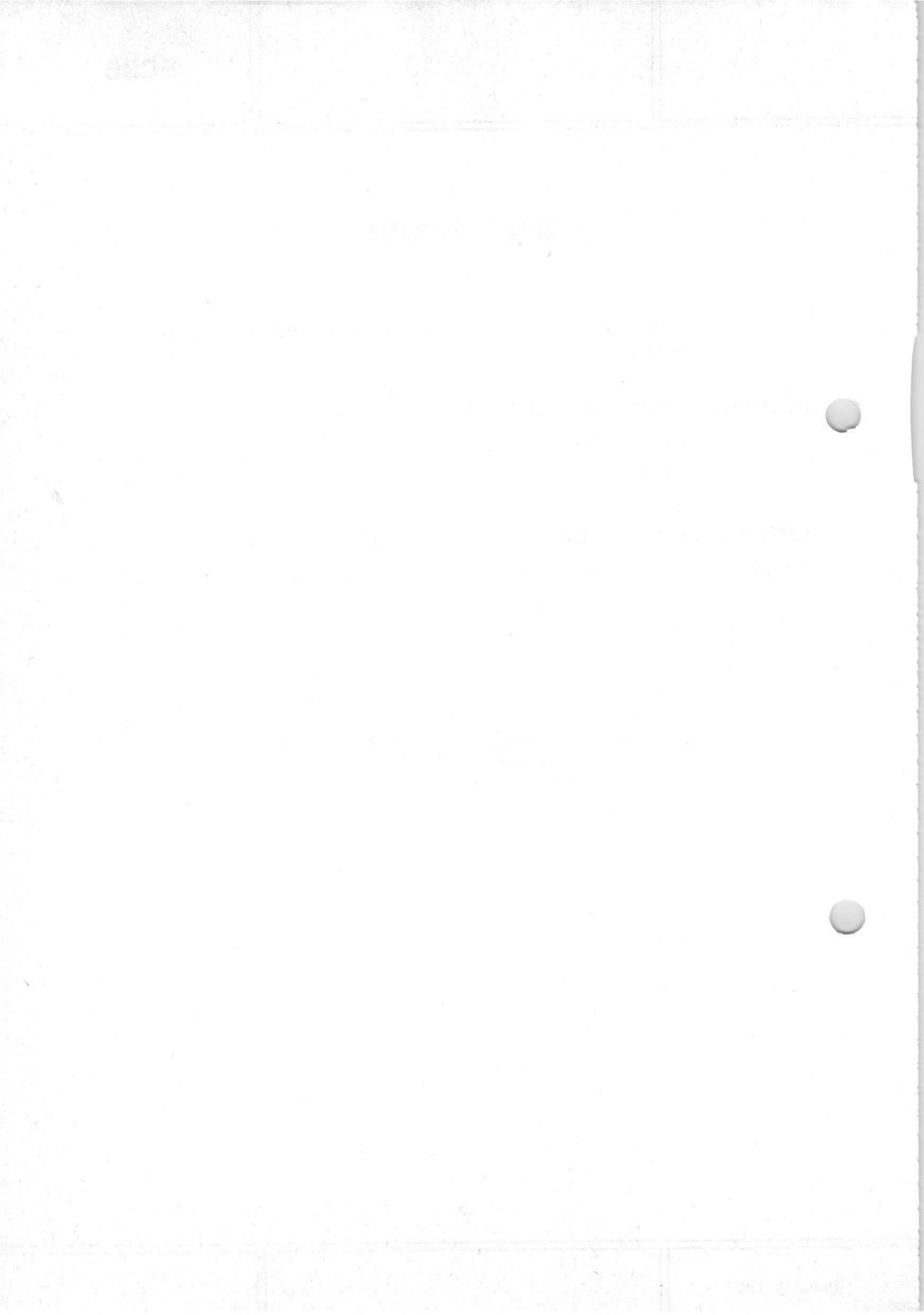

U.H.F. TRIODE

Triode intended for use as grounded grid U.H.F. amplifier for bands IV and V.

HEATING: Indirect by A.C. or D.C.; parallel supply

Heater voltage

$\frac{V_f}{\quad}$ 6.3 V

Heater current

I_f 165 mA

For further data and curves of this type
please refer to PC88

U. S. F. TRIDGE

THE UNITED STATES OF AMERICA

OFFICE OF THE SECRETARY OF THE ARMY

WASHINGTON, D. C.

1917

THE SECRETARY OF THE ARMY
WASHINGTON, D. C.

R.F. TRIODE

Triode intended for use as oscillator, mixer or amplifier in F.M. - and television receivers.

QUICK REFERENCE DATA			
Anode current	I_a	10	mA
Transconductance	S	5.5	mA/V
Amplification factor	μ	60	

HEATING: Indirect by A.C. or D.C.; series or parallel supply

Heater voltage	V_f	6.3	V
Heater current	I_f	150	mA

DIMENSIONS AND CONNECTIONS

Dimensions in mm

Base: Miniature

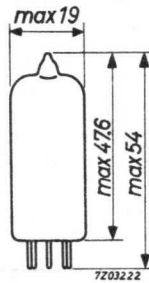
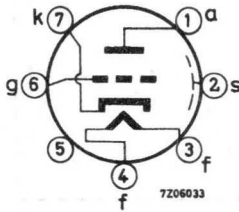

CAPACITANCES

Grid to all except anode	$C_{g(a)}$	2.6	pF
Anode to all except grid	$C_{a(g)}$	0.55	pF
Anode to grid	C_{ag}	1.6	pF
Anode to cathode	C_{ak}	0.24	pF
Cathode to heater	C_{kf}	2.2	pF
Grid to heater	C_{gf}	max. 0.15	pF
Anode to grid + heater	$C_{a/gf}$	1.8	pF
Cathode to grid + heater	$C_{k/gf}$	4.5	pF

TYPICAL CHARACTERISTICS AND OPERATING CONDITIONS

Anode voltage	V_a	100	170	200	250	V
Grid voltage	V_g	-1.0	-1.0	-1.0	-2.0	V
Anode current	I_a	3.0	8.5	11.5	10	mA
Transconductance	S	3.75	5.9	6.7	5.5	mA/V
Amplification factor	μ	62	66	70	60	
Internal resistance	R_i	16.5	11	10.5	11	k Ω

LIMITING VALUES (Design centre rating system)

Anode voltage	V_{a0}	max.	550	V
	V_a	max.	300	V
Anode dissipation	W_a	max.	2.5	W
Cathode current	I_k	max.	15	mA
Grid voltage	$-V_g$	max.	50	V
Grid resistor (automatic bias)	R_g	max.	1	M Ω
Cathode to heater voltage	V_{kf}	max.	100	V

 For curves please refer to type ECC81

V.H.F. TRIODE

Triode intended for use as R.F. amplifier in V.H.F. television tuners.

HEATING: Indirect by A.C. or D.C.; parallel supply

Heater voltage

V_f 6.3 V

Heater current

I_f 180 mA

For further data and curves of this type
please refer to type PC900

W. P. FRIDE

...

...

R.F. DOUBLE TRIODE

Double triode intended for use as oscillator, mixer or amplifier in television receivers.

QUICK REFERENCE DATA (each unit)

Anode current	I_a	10 mA
Transconductance	S	5.5 mA/V
Amplification factor	μ	60 -

HEATING: Indirect by A.C. or D.C.; series or parallel supply

Heater voltage	V_f	6.3	12.6	V
Heater current	I_f	300 ¹⁾	150 ¹⁾	mA
		pins 9-(4+5)	pins 4-5	

DIMENSIONS AND CONNECTIONS

Dimensions in mm

Base: Noval

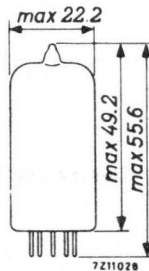
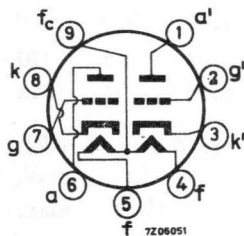

¹⁾ In case of series supply a current limiting device must be inserted in the heater circuit for limiting the current when switching on.

CAPACITANCES

Grid to all except anode	$C_{g(a)}$	2.3	pF
	$C_{g'(a')}$	2.3	pF
Anode to all except grid	$C_{a(g)}$	0.45	pF
	$C_{a'(g')}$	0.35	pF
Anode to grid	C_{ag}	1.6	pF
	$C_{a'g'}$	1.6	pF
Anode to cathode	C_{ak}	0.20	pF
	$C_{a'k'}$	0.20	pF
Cathode to heater	C_{kf}	2.5	pF
	$C_{k'f}$	2.5	pF
Cathode to grid + heater	$C_{k/g+f}$	4.7	pF
	$C_{k'/g'+f}$	4.7	pF
Anode to grid + heater	$C_{a/g+f}$	1.9	pF
	$C_{a'/g'+f}$	1.8	pF
Grid to heater	C_{gf}	max.	0.17 pF
	$C_{g'f}$	max.	0.17 pF
Anode to anode	$C_{aa'}$	max.	0.4 pF
Grid to grid	$C_{gg'}$	max.	0.005 pF
Anode to grid other unit	$C_{ag'}$	max.	0.07 pF
Grid to anode other unit	$C_{ga'}$	max.	0.04 pF

TYPICAL CHARACTERISTICS AND OPERATING CONDITIONS (each unit)

Anode voltage	V_a	100	170	200	250	V
Grid voltage	V_g	-1.0	-1.0	-1.0	-2.0	V
Anode current	I_a	3.0	8.5	11.5	10	mA
Transconductance	S	3.75	5.9	6.7	5.5	mA/V
Amplification factor	μ	62	66	70	60	
Internal resistance	R_i	16.5	11	10.5	11	k Ω

LIMITING VALUES (Design centre rating system) (each unit)

Anode voltage	V_{a0}	max.	550	V
	V_a	max.	300	V
Anode dissipation	W_a	max.	2.5	W
Cathode current	I_k	max.	15	mA
Grid voltage	$-V_g$	max.	50	V
Grid resistor (automatic bias)	R_g	max.	1	M Ω
Cathode to heater voltage	V_{kf}	max.	90	V

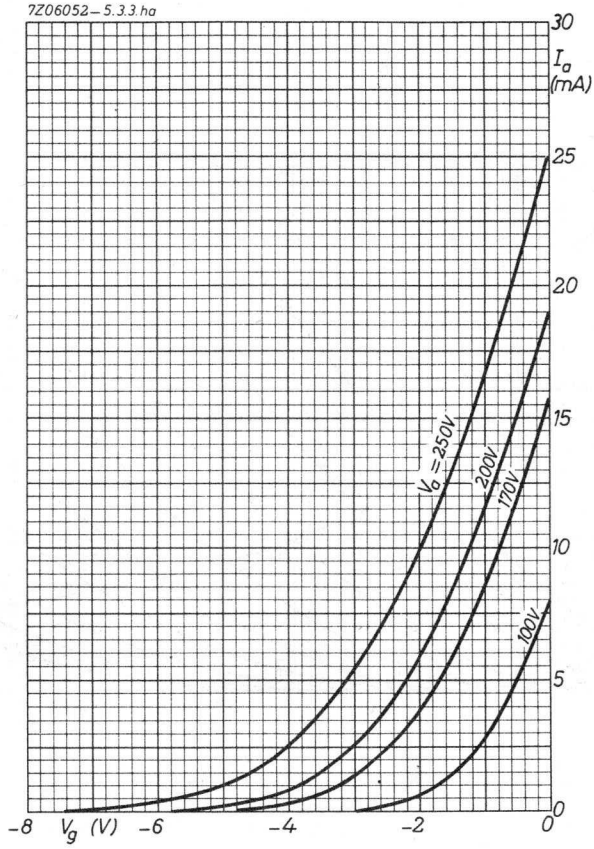

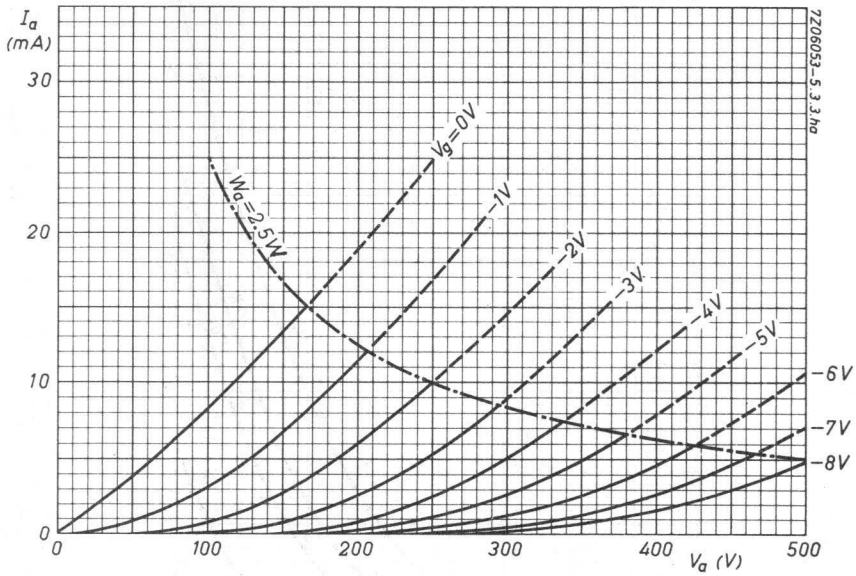

A.F. DOUBLE TRIODE

Double triode intended for use as A.F. amplifier.

QUICK REFERENCE DATA (each unit)			
Anode current	I_a	10.5	mA
Transconductance	S	2.2	mA/V
Amplification factor	μ	17	-

HEATING: Indirect by A.C. or D.C.; series or parallel supply

Heater voltage	V_f	6.3	12.6	V
Heater current	I_f	300	150	mA
		pins 9-(4+5)		pins 4-5

DIMENSIONS AND CONNECTIONS

Dimensions in mm

Base: Noval

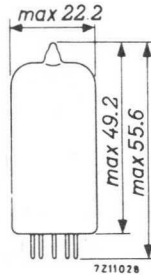
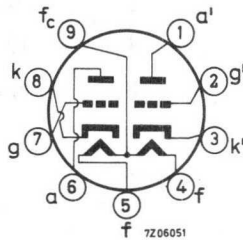

REMARK

With V_f applied to pins 4+5 and 9 and the centre tap of the heater transformer connected to earth, the more favourable triode section of the tube with regard to hum is the section connected to pins 6, 7 and 8.

CAPACITANCES

Grid to all except anode	$C_{g(a)}$	1.8	pF
	$C_{g'(a')}$	1.8	pF
Anode to all except grid	$C_{a(g)}$	0.37	pF
	$C_{a'(g')}$	0.25	pF
Anode to grid	C_{ag}	1.5	pF
	$C_{a'g'}$	1.5	pF
Grid to heater	C_{gf}	max. 0.135	pF
	$C_{g'f}$	max. 0.135	pF
Anode to anode	$C_{aa'}$	max. 1.1	pF
Anode to grid other unit	$C_{ag'}$	max. 0.11	pF
Grid to anode other unit	$C_{ga'}$	max. 0.06	pF
Grid to grid	$C_{gg'}$	max. 0.010	pF

TYPICAL CHARACTERISTICS

Anode voltage	V_a	100	250	V
Grid voltage	V_g	0	-8.5	V
Anode current	I_a	11.8	10.5	mA
Transconductance	S	3.1	2.2	mA/V
Amplification factor	μ	19.5	17	-
Internal resistance	R_i	6.25	7.7	k Ω

OPERATING CHARACTERISTICS

As A.F. amplifier, one unit

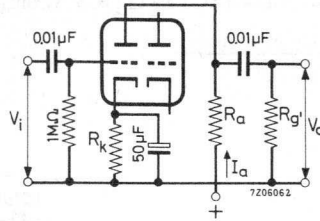

Supply voltage	V_b	100	150	200	250	300	350	400	V
Anode resistor	R_a	47	47	47	47	47	47	47	k Ω
Grid resistor next stage	$R_{g'}$	150	150	150	150	150	150	150	k Ω
Cathode resistor	R_k	1.2	1.2	1.2	1.2	1.2	1.2	1.2	k Ω
Anode current	I_a	1.20	1.82	2.41	3.02	3.65	4.30	5.00	mA
Voltage gain	V_o/V_i	13.5	13.5	13.5	13.5	13.5	13.5	13.5	-
Output voltage ($I_g = 0.3 \mu A$)	V_o	11	18	26	34	43	51	59	V_{RMS}
Total distortion	d_{tot}	5.6	6.1	6.3	6.4	6.5	6.6	6.7	%

Supply voltage	V_b	100	150	200	250	300	350	400	V
Anode resistor	R_a	100	100	100	100	100	100	100	k Ω
Grid resistor next stage	$R_{g'}$	330	330	330	330	330	330	330	k Ω
Cathode resistor	R_k	2.2	2.2	2.2	2.2	2.2	2.2	2.2	k Ω
Anode current	I_a	0.66	0.98	1.30	1.63	1.97	2.30	2.62	mA
Voltage gain	V_o/V_i	14	14	14	14	14	14	14	-
Output voltage ($I_g = 0.3 \mu A$)	V_o	10	17	25	32	41	49	57	V_{RMS}
Total distortion	d_{tot}	4.8	5.6	5.8	5.9	6.0	6.1	6.2	%

Supply voltage	V_b	100	150	200	250	300	350	400	V
Anode resistor	R_a	220	220	220	220	220	220	220	k Ω
Grid resistor next stage	$R_{g'}$	680	680	680	680	680	680	680	k Ω
Cathode resistor	R_k	3.9	3.9	3.9	3.9	3.9	3.9	3.9	k Ω
Anode current	I_a	0.33	0.50	0.66	0.82	0.98	1.16	1.31	mA
Voltage gain	V_o/V_i	14.5	14.5	14.5	14.5	14.5	14.5	14.5	-
Output voltage ($I_g = 0.3 \mu A$)	V_o	8	15	22	28	36	43	50	V_{RMS}
Total distortion	d_{tot}	4.0	4.4	4.7	4.8	4.9	5.0	5.1	%

OPERATING CHARACTERISTICS (continued)

Two sections in cascade

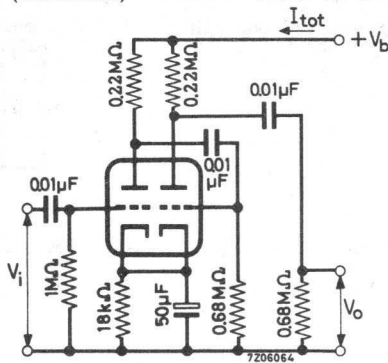

Supply voltage	V_b	250	350	V
Total current	I_{tot}	1.66	2.33	mA
Voltage gain	V_o/V_i	178	178	-
Output voltage ($I_g = 0.3 \mu A$)	V_o	15	25	V_{RMS}
Total distortion	d_{tot}	2	2	%

As phase inverter

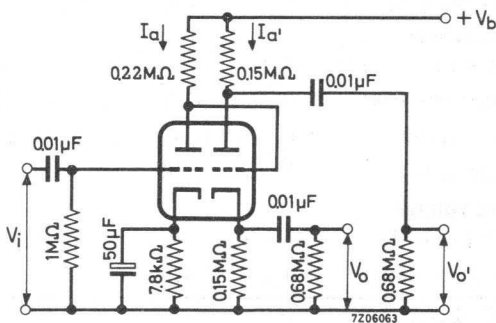

Supply voltage	V_b	250	350	V
Anode current	I_a	0.70	1.00	mA
Anode current	$I_{a'}$	0.68	0.93	mA
Voltage gain	V_o/V_i	11	11	-
Output voltage ($I_g = 0.3 \mu A$)	V_o	15	24	V_{RMS}
Total distortion	d_{tot}	1	1	%

OPERATING CHARACTERISTICS (continued)

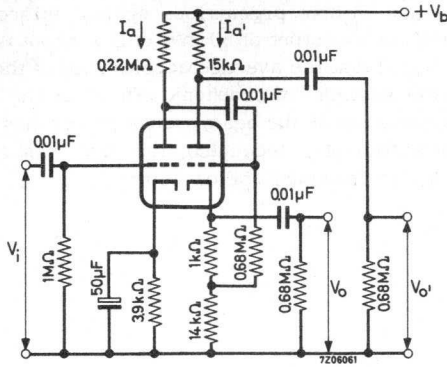

Supply voltage	V_b	250	350	V
Anode current	I_a	0.82	1.16	mA
Anode current	I_a'	4.5	6.3	mA
Voltage gain	V_o/V_i	11	11	-
Output voltage ($I_g = 0.3 \mu A$)	V_o	13	20	V_{RMS}
Total distortion	d_{tot}	1.5	1.5	%

LIMITING VALUES (Design centre rating system) (each unit)

Anode voltage	V_{a0}	max.	550	V
	V_a	max.	300	V
Anode dissipation	W_a	max.	2.75	W
Cathode current	I_k	max.	20	mA
Grid voltage	$-V_g$	max.	100	V
, peak	$-V_{gp}$	max.	250	V
Grid resistor (automatic bias)	R_g	max.	1	$M\Omega$
Cathode to heater voltage	V_{kf}	max.	180	V
Cathode to heater circuit resistance in phase splitting circuits	R_{kf}	max.	150	$k\Omega$

REMARK

This tube can be used without precautions against microphony in equipment in which $V_i \geq 10$ mV for an output of 50 mW of the output tube (or $V_i \geq 100$ mV for 5 W output) provided that the average acceleration of the tube is not greater than indicated in the section "Microphonic effect" of the "Application Directions". When the centre tap of the heater transformer has been earthed, $R_g \leq 0.3 \text{ M}\Omega$ and R_k is sufficiently decoupled, the disturbance level for hum and noise will then be better than 60 dB below 100 mV.

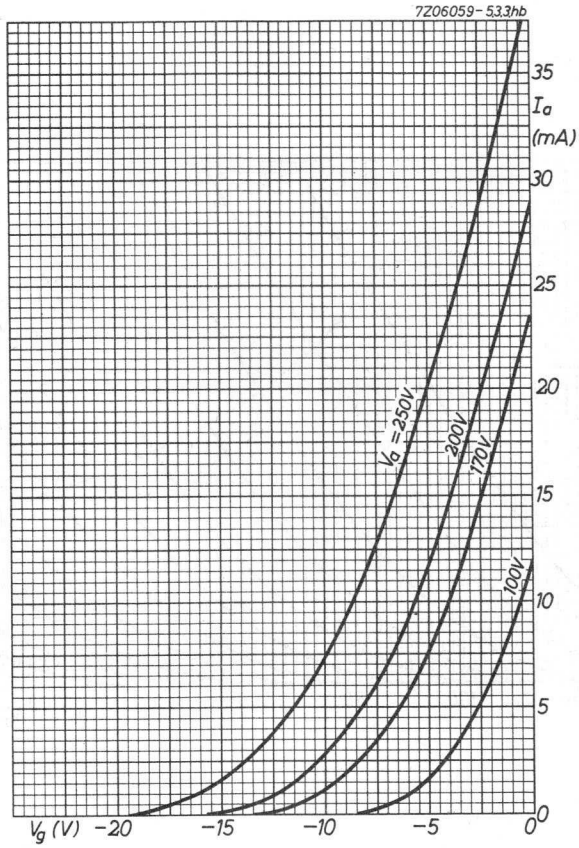

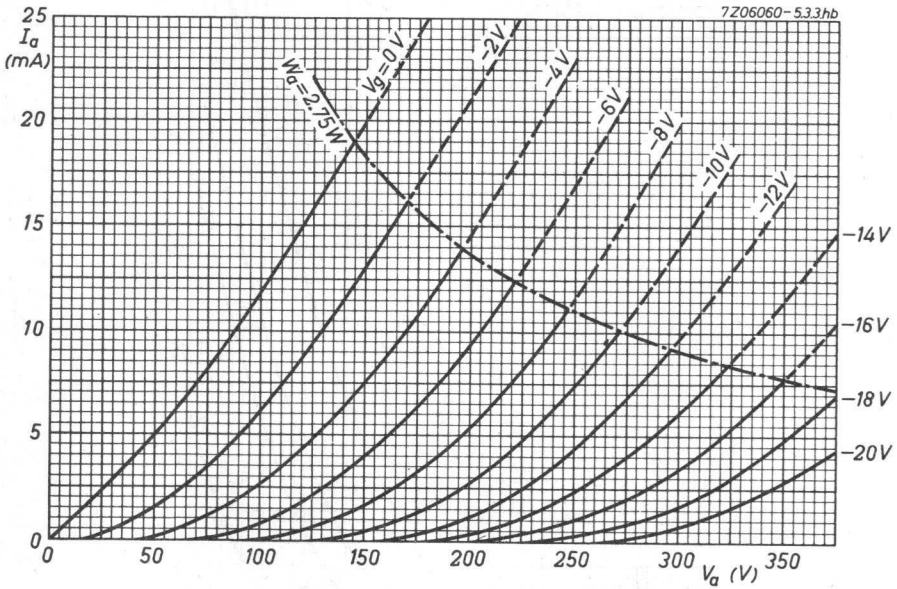

A.F. DOUBLE TRIODE

Double triode intended for use as A.F. amplifier.

QUICK REFERENCE DATA (each unit)		
Anode current	I_a	1.2 mA
Transconductance	S	1.6 mA/V
Amplification factor	μ	100 -

HEATING: Indirect by A.C. or D.C.; series or parallel supply

Heater voltage	V_f	6.3	12.6 V
Heater current	I_f	300	150 mA
		pins 9-(4+5)	pins 4-5

DIMENSIONS AND CONNECTIONS

Dimensions in mm

Base: Noval

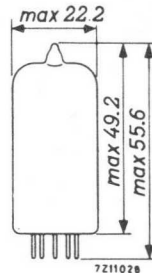
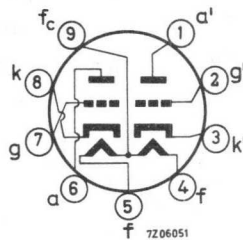

REMARK

With V_f applied to pins 9 and 4+5 and the centre tap of the heater transformer connected to earth, the triode section connected to pins 6, 7 and 8 is the more favourable section of the tube with respect to hum.

CAPACITANCES

Grid to all except anode	$C_{g(a)}$	1.6 pF
	$C_{g'(a')}$	1.6 pF
Anode to all except grid	$C_{a(g)}$	0.33 pF
	$C_{a'(g')}$	0.23 pF
Anode to grid	C_{ag}	1.6 pF
	$C_{a'g'}$	1.6 pF
Grid to heater	C_{gf}	max. 0.15 pF
	$C_{g'f}$	max. 0.15 pF
Anode to anode	$C_{aa'}$	max. 1.2 pF
Anode to grid other unit	$C_{ag'}$	max. 0.11 pF
Grid to anode other unit	$C_{ga'}$	max. 0.1 pF
Grid to grid	$C_{gg'}$	max. 0.01 pF

TYPICAL CHARACTERISTICS

Anode voltage	V_a	100	250 V
Grid voltage	V_g	-1.0	-2.0 V
Anode current	I_a	0.5	1.2 mA
Transconductance	S	1.25	1.6 mA/V
Amplification factor	μ	100	100 -
Internal resistance	R_i	80	62.5 k Ω

OPERATING CHARACTERISTICS

As A.F. amplifier, one unit

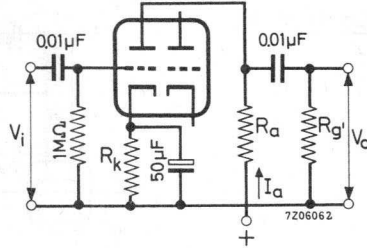

Supply voltage	V_b	200	250	300	350	400	V
Anode resistor	R_a	47	47	47	47	47	k Ω
Grid resistor next stage	$R_{g'}$	150	150	150	150	150	k Ω
Cathode resistor	R_k	1500	1200	1000	820	680	Ω
Anode current	I_a	0.86	1.18	1.55	1.98	2.45	mA
Voltage gain	V_o/V_i	34	37.5	40	42.5	44	-
Output voltage ($I_g = 0.3 \mu A$)	V_o	18	23	26	33	37	V_{RMS}
Total distortion	d_{tot}	8.5	7.0	5.0	4.4	3.6	%

Supply voltage	V_b	200	250	300	350	400	V
Anode resistor	R_a	100	100	100	100	100	k Ω
Grid resistor next stage	$R_{g'}$	330	330	330	330	330	k Ω
Cathode resistor	R_k	1800	1500	1200	1000	820	Ω
Anode current	I_a	0.65	0.86	1.11	1.40	1.72	mA
Voltage gain	V_o/V_i	50	54.5	57	61	63	-
Output voltage ($I_g = 0.3 \mu A$)	V_o	20	26	30	36	38	V_{RMS}
Total distortion	d_{tot}	4.8	3.9	2.7	2.2	1.7	%

Supply voltage	V_b	200	250	300	350	400	V
Anode resistor	R_a	220	220	220	220	220	k Ω
Grid resistor next stage	$R_{g'}$	680	680	680	680	680	k Ω
Cathode resistor	R_k	3.3	2.7	2.2	1.5	1.2	k Ω
Anode current	I_a	0.36	0.48	0.63	0.85	1.02	mA
Voltage gain	V_o/V_i	56	66.5	72	75.5	76.5	-
Output voltage ($I_g = 0.3 \mu A$)	V_o	24	28	36	37	38	V_{RMS}
Total distortion	d_{tot}	4.6	3.4	2.6	1.6	1.1	%

As phase inverter

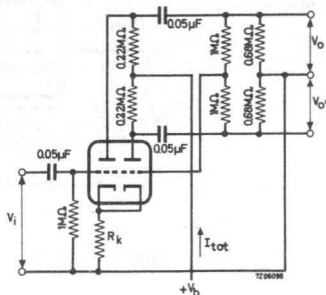

Supply voltage	V_b	250	350	V
Cathode resistor	R_k	1200	820	Ω
Total current	I_{tot}	1.08	1.70	mA
Voltage gain	V_o/V_i	58	62	-
Output voltage ($I_g = 0.3 \mu A$)	V_o	35	45	V_{RMS}
Total distortion	d_{tot}	5.5	3.5	%

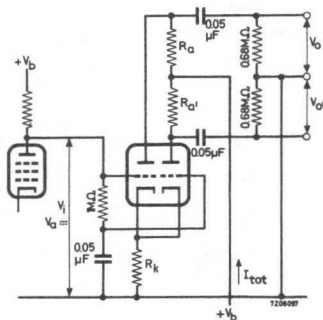

Supply voltage	V_b	250	350	V
Anode voltage	V_a	65	90	V
Total current	I_{tot}	1	1.2	mA
Cathode resistor	R_k	68	82	$k\Omega$
Anode resistor	R_a	100	150	$k\Omega$
Anode resistor	$R_{a'}$	100	150	$k\Omega$
Voltage gain	V_o/V_i	25	27	-
Output voltage ($I_g = 0.3 \mu A$)	V_o	20	35	V_{RMS}
Total distortion	d_{tot}	1.8	1.8	%

LIMITING VALUES (Design centre rating system)

Anode voltage	V_{a0}	max. 550 V
	V_a	max. 300 V
Anode dissipation	W_a	max. 1 W
Cathode current	I_k	max. 8 mA
Grid voltage	$-V_g$	max. 50 V
Grid resistor (automatic bias)	R_g	max. 2 M Ω
Cathode to heater voltage	V_{kf}	max. 180 V
Cathode to heater circuit resistance in phase splitting circuits	R_{kf}	max. 150 k Ω

REMARK

Microphony and hum

This tube can be used without special precautions against microphony in equipment in which the input voltage $V_i \geq 5$ mV for an output of 50 mW (or 50 mV for an output of 5 W) provided the average acceleration of the tube is not greater than indicated in the section "Microphonic effect" of the "Application directions". In this case the disturbance level for hum and noise will be better than -60 dB when the centre tap of the heater has been earthed, $R_g \leq 0.5$ M Ω and the cathode resistor is sufficiently decoupled.

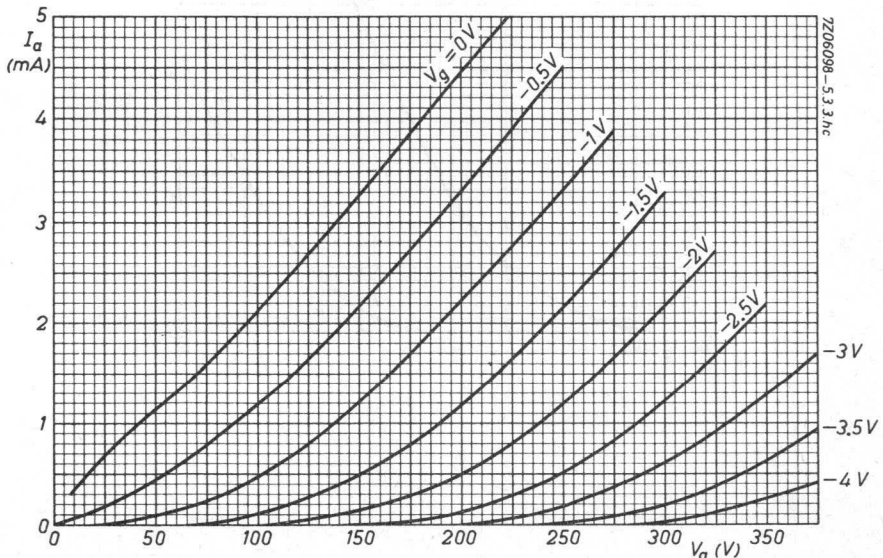

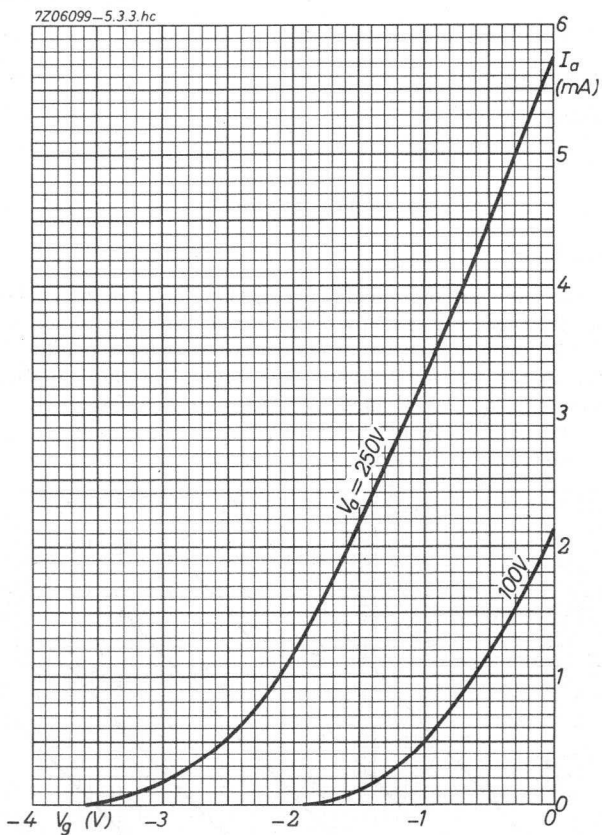

R.F. DOUBLE TRIODE

Double triode intended for use as R.F. and A.F. amplifier and self oscillating mixer.

QUICK REFERENCE DATA (each unit)

Anode current	I_a	10 mA
Transconductance	S	6.1 mA/V
Amplification factor	μ	55 -

HEATING: Indirect by A.C. or D.C.; parallel supply

Heater voltage

V_f 6.3 V

Heater current

I_f 435 mA

DIMENSIONS AND CONNECTIONS

Dimensions in mm

Base: Noval

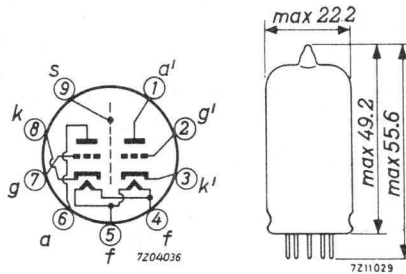

CAPACITANCES

Anode to grid	C_{ag}	1.5	pF
	$C_{a'g'}$	1.5	pF
Anode to cathode	C_{ak}	0.17	pF
	$C_{a'k'}$	0.18	pF
Anode to cathode + heater + screen	$C_{a/kfs}$	1.2	pF
	$C_{a'/k'fs}$	1.2	pF
Grid to cathode + heater + screen	$C_{g/kfs}$	3.1	pF
	$C_{g'/k'fs}$	3.1	pF
Anode to cathode + heater + screen with external screen of 22.5 mm diam.	$C_{a/kfs}$	1.8	pF
	$C_{a'/k'fs}$	1.8	pF
Anode to anode	$C_{aa'}$	max. 0.04	pF
Grid to grid	$C_{gg'}$	max. 0.003	pF
Anode to grid other unit	$C_{ag'}$	max. 0.008	pF
Grid to anode other unit	$C_{ga'}$	max. 0.008	pF
Anode to anode with external screen of 22.5 mm diam.	$C_{aa'}$	max. 0.008	pF
Anode to cathode other unit	$C_{ak'}$	max. 0.008	pF
Grid to cathode other unit	$C_{gk'}$	max. 0.003	pF
Cathode to anode other unit	$C_{ka'}$	max. 0.008	pF
Cathode to grid other unit	$C_{kg'}$	max. 0.003	pF

TYPICAL CHARACTERISTICS

Anode voltage	V_a	250	V
Grid voltage	V_g	-2.7	V
Anode current	I_a	10	mA
Transconductance	S	6.1	mA/V
Amplification factor	μ	55	-

REMARK

Microphony

This tube can be used without special precautions against microphony in A.F. applications in which the input voltage $V_i \geq 5$ mV for an output of 50 mW (or 50 mV for an output of 5 W) provided the peak acceleration of the tube is not greater than indicated in the section "Microphony" of the "General Operational Recommendations".

OPERATING CHARACTERISTICS

As R.F. amplifier

Supply voltage	V_b	250 V
Anode resistor	R_a	1.8 k Ω
Anode voltage	V_a	230 V
Cathode resistor	R_k	200 Ω
Grid voltage	V_g	-2.2 V
Anode current	I_a	10.8 mA
Transconductance	S	6.8 mA/V
Internal resistance	R_i	8.3 k Ω
Grid input resistance (f = 100 MHz)	r_g	4.7 k Ω
Equivalent noise resistance	R_{eq}	580 Ω

As self-oscillating mixer

Supply voltage	V_b	250 V
Anode resistor	R_a	12 k Ω
Grid resistor	R_g	1 M Ω
Oscillator voltage	V_{osc}	3.0 V _{RMS}
Anode current	I_a	6 mA
Conversion conductance	S_c	3 mA/V
Internal resistance	R_i	18 k Ω
Grid input resistance (f = 100 MHz)	r_g	15 k Ω

LIMITING VALUES (Design centre rating system) (Each unit unless otherwise stated)

Anode voltage	V_{a0}	max. 550 V
	V_a	max. 300 V
Anode dissipation	W_a	max. 2.5 W
Anode dissipation, total for both units	$W_a + W_{a'}$	max. 4.5 W
Cathode current	I_k	max. 15 mA
Grid voltage	$-V_g$	max. 100 V
Grid resistor	R_g	max. 1 M Ω
Cathode to heater voltage	V_{kf}	max. 90 V

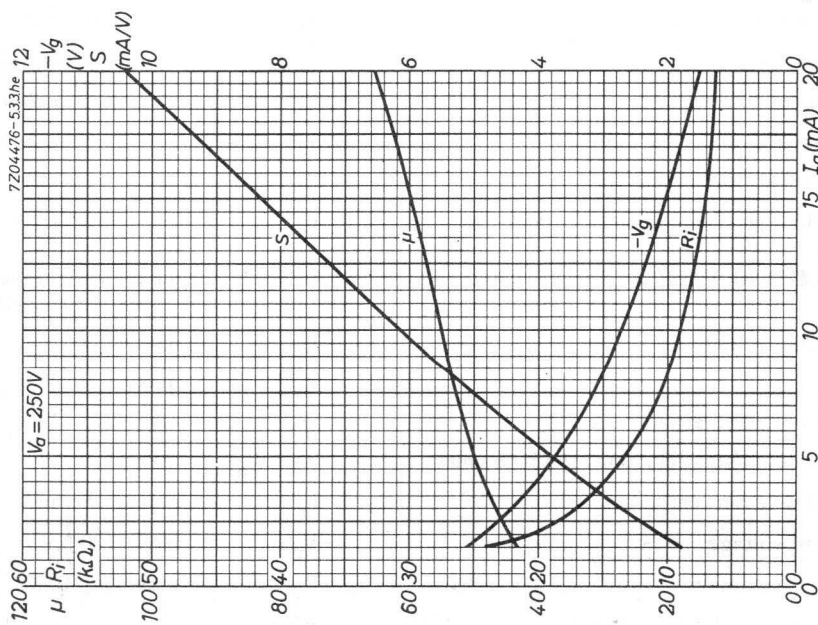
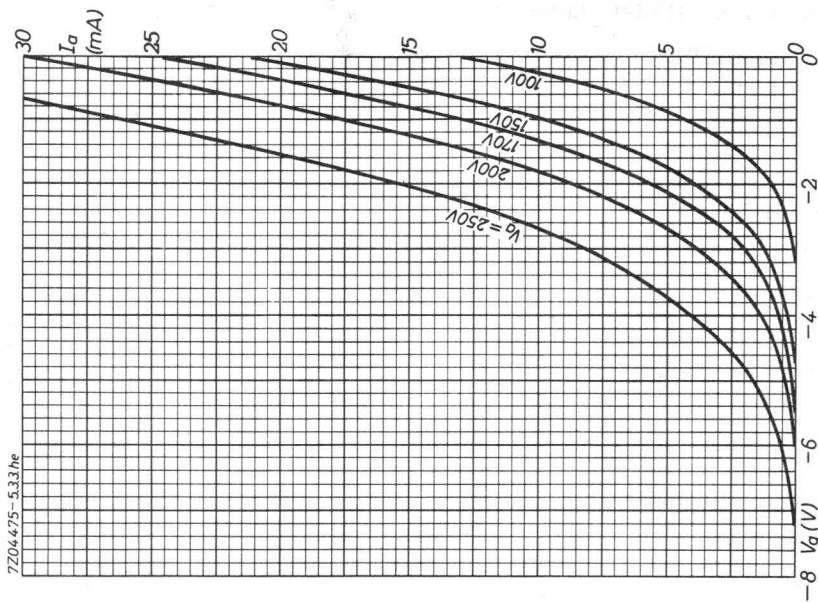

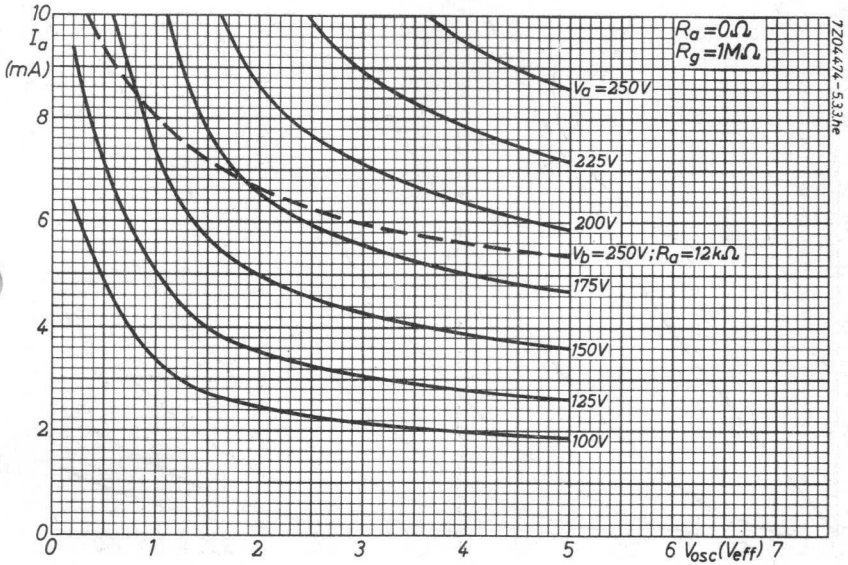

7204473-5331e

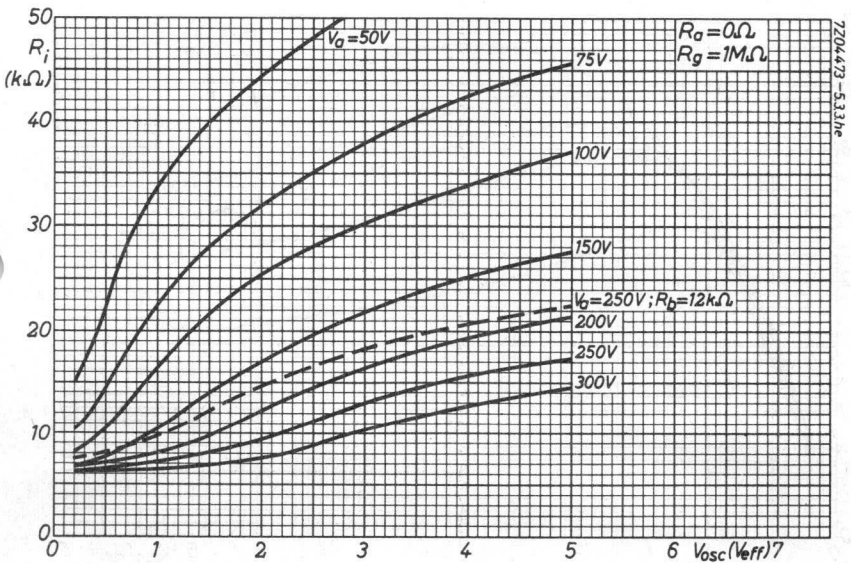

7204473-5331e

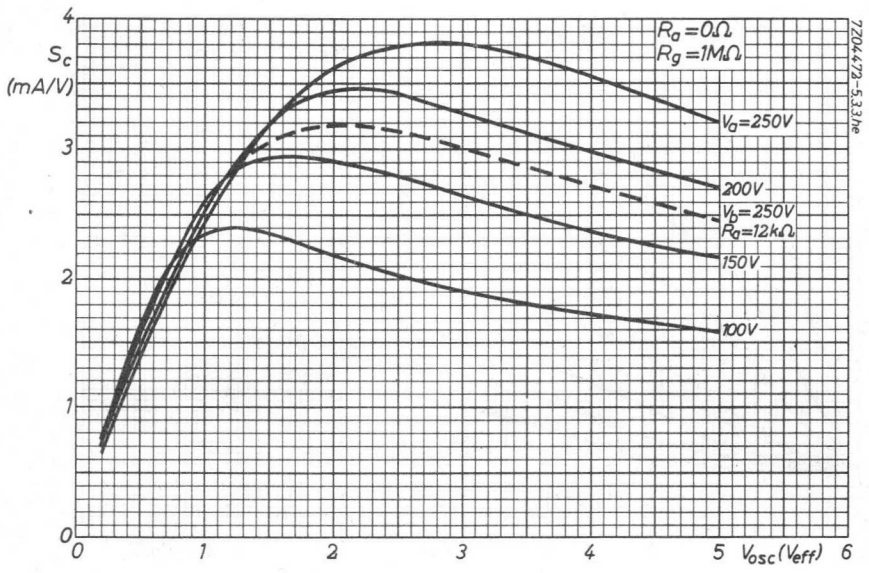
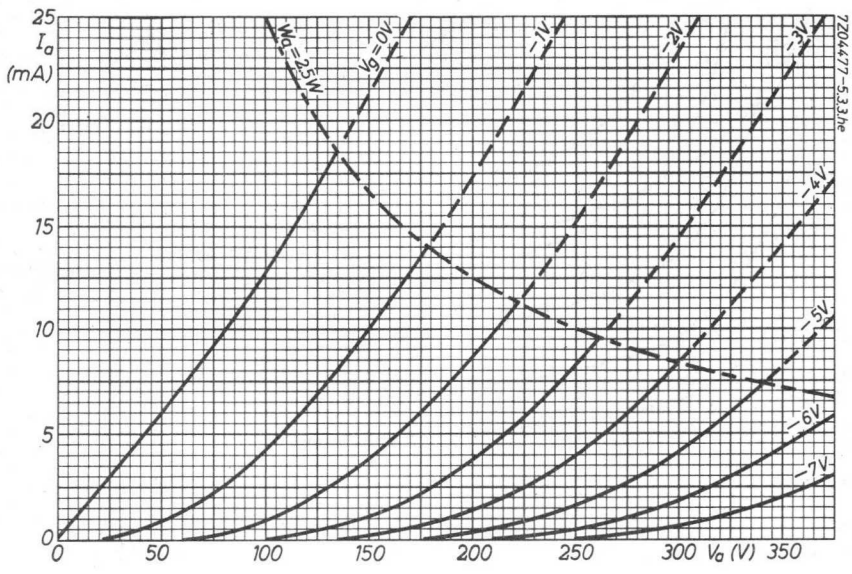

R.F. DOUBLE TRIODE

Double triode intended for use as cascode amplifier in tuners for television receivers.

HEATING: Indirect by A.C. or D.C.; parallel supply

Heater voltage

$\frac{V_f}{I_f}$ 6.3 V

Heater current

365 mA

For further data and curves please refer to PCC88

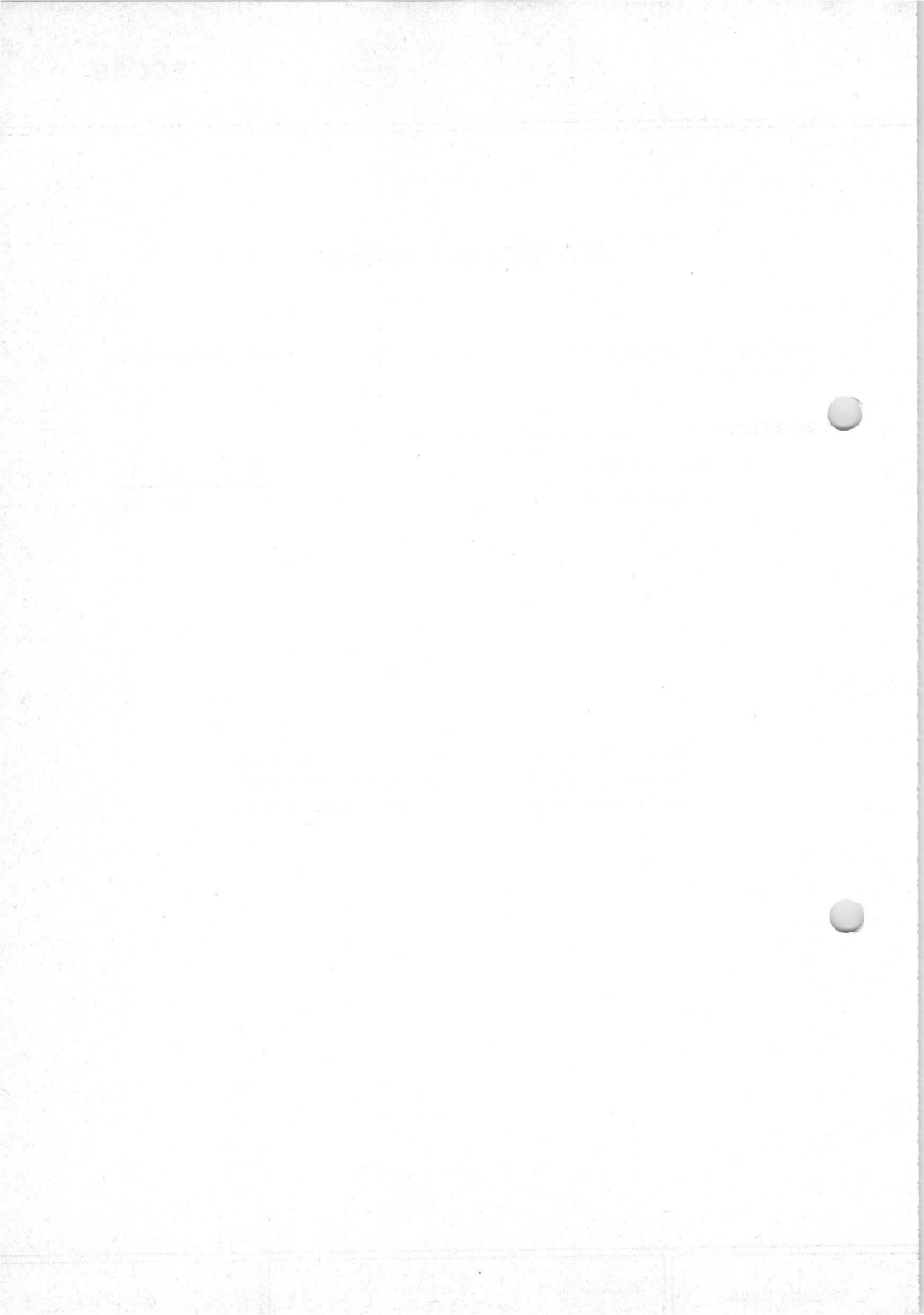

R.F. DOUBLE TRIODE

Double triode with variable transconductance intended for use as V.H.F. cascade amplifier in television receivers.

HEATING: Indirect by A.C. or D.C.; parallel supply

Heater voltage

V_f 6.3 V

Heater current

I_f 365 mA

LIMITING VALUES (Design centre rating system)

Cathode to heater voltage

V_{kf} max. 50 V

$V_{k'f}$ (k pos) max. 150 V ¹⁾

 For further data and curves of this type
 please refer to type PCC189

¹⁾ D.C. component max. 130 V.

100000

100000



TRIODE-PENTODE

Triode-pentode with separate cathodes intended for use as frequency changer in television receivers.

HEATING: Indirect by A.C. or D.C.; parallel supply

Heater voltage	V_f	6.3 V
Heater current	I_f	430 mA

LIMITING VALUES (Design centre rating system)

Triode section

Cathode to heater voltage V_{kf} max. 100 V

Pentode section

Cathode to heater voltage V_{kf} max. 100 V

 For further data and curves
 please refer to PCF80

TRICIDE-PENTODE

TRICIDE-PENTODE is a broad-spectrum insecticide and acaricide. It is effective against a wide range of insects and mites, including houseflies, mosquitoes, and ticks. The active ingredients are trichlorfon and pentachlorophenol.

100 ml	100
200 ml	200
300 ml	300
400 ml	400
500 ml	500
600 ml	600
700 ml	700
800 ml	800
900 ml	900
1000 ml	1000

TRICIDE-PENTODE is a broad-spectrum insecticide and acaricide. It is effective against a wide range of insects and mites, including houseflies, mosquitoes, and ticks. The active ingredients are trichlorfon and pentachlorophenol.

TRICIDE-PENTODE is a broad-spectrum insecticide and acaricide. It is effective against a wide range of insects and mites, including houseflies, mosquitoes, and ticks. The active ingredients are trichlorfon and pentachlorophenol.

TRICIDE-PENTODE is a broad-spectrum insecticide and acaricide. It is effective against a wide range of insects and mites, including houseflies, mosquitoes, and ticks. The active ingredients are trichlorfon and pentachlorophenol.

TRICIDE-PENTODE is a broad-spectrum insecticide and acaricide. It is effective against a wide range of insects and mites, including houseflies, mosquitoes, and ticks. The active ingredients are trichlorfon and pentachlorophenol.

TRICIDE-PENTODE is a broad-spectrum insecticide and acaricide. It is effective against a wide range of insects and mites, including houseflies, mosquitoes, and ticks. The active ingredients are trichlorfon and pentachlorophenol.

TRICIDE-PENTODE is a broad-spectrum insecticide and acaricide. It is effective against a wide range of insects and mites, including houseflies, mosquitoes, and ticks. The active ingredients are trichlorfon and pentachlorophenol.

TRICIDE-PENTODE is a broad-spectrum insecticide and acaricide. It is effective against a wide range of insects and mites, including houseflies, mosquitoes, and ticks. The active ingredients are trichlorfon and pentachlorophenol.

TRICIDE-PENTODE is a broad-spectrum insecticide and acaricide. It is effective against a wide range of insects and mites, including houseflies, mosquitoes, and ticks. The active ingredients are trichlorfon and pentachlorophenol.

TRICIDE-PENTODE is a broad-spectrum insecticide and acaricide. It is effective against a wide range of insects and mites, including houseflies, mosquitoes, and ticks. The active ingredients are trichlorfon and pentachlorophenol.

TRICIDE-PENTODE is a broad-spectrum insecticide and acaricide. It is effective against a wide range of insects and mites, including houseflies, mosquitoes, and ticks. The active ingredients are trichlorfon and pentachlorophenol.

TRIODE-PENTODE

Triode-pentode intended for use as frequency changer in V.H.F. television tuners.

HEATING: Indirect by A.C. or D.C.; parallel supply

Heater voltage

V_f 6.3 V

Heater current

I_f 390 mA

LIMITING VALUES (Design centre rating system)

Triode section

Cathode to heater voltage

V_{kf} max. 100 V

Pentode section

Cathode to heater voltage

V_{kf} max. 100 V

 For further data and curves
 please refer to PCF86

1948

3001:75 FRONT



TRIODE-PENTODE

Triode-pentode intended for use in television receivers; triode section as limiter, noise detector, A.G.C. amplifier, sync. separator and pulse-amplifier; pentode section as sound I.F. amplifier and video I.F. amplifier.

HEATING: Indirect by A.C. or D.C.; parallel supply

Heater voltage

V_f 6.3 V

Heater current

I_f 410 mA

For further data and curves
please refer to type PCF200

1900-1901

...

...

...

TRIODE-PENTODE

Triode-pentode intended for use in T.V. receivers; triode section as line-blocking oscillator, part of a multivibrator, sync separator, pulse amplifier or A.G.C. delay diode; pentode section with remote cut-off as video I.F. amplifier.

HEATING: Indirect by A.C. or D.C.; parallel supply

Heater voltage

V_f 6.3 V

Heater current

I_f 410 mA

For further data and curves of this type
please refer to type PCF201

07-03

1977-1981



TRIODE-PENTODE

High transconductance triode and R.F. pentode intended for use as frequency changer in V.H.F. T.V. tuners.

HEATING: Indirect by A.C. or D.C.; parallel supply

Heater voltage

V_f 6.3 V

Heater current

I_f 0.41 A

For further data and curves of this type
please refer to type PCF801

109723

109723



TRIODE-PENTODE

Triode-pentode; triode section intended for use as reactance tube, pentode section intended for use as sine wave oscillator or pulse shaper in television receivers.

HEATING: Indirect by A.C. or D.C.; parallel supply

Heater voltage	V_f	6.3 V
Heater current	I_f	430 mA

LIMITING VALUES

Pentode section

Cathode to heater voltage V_{kf} max. 100 V

Triode section

Cathode to heater voltage V_{kf} max. 100 V

For further data and curves
please refer to type PCF802

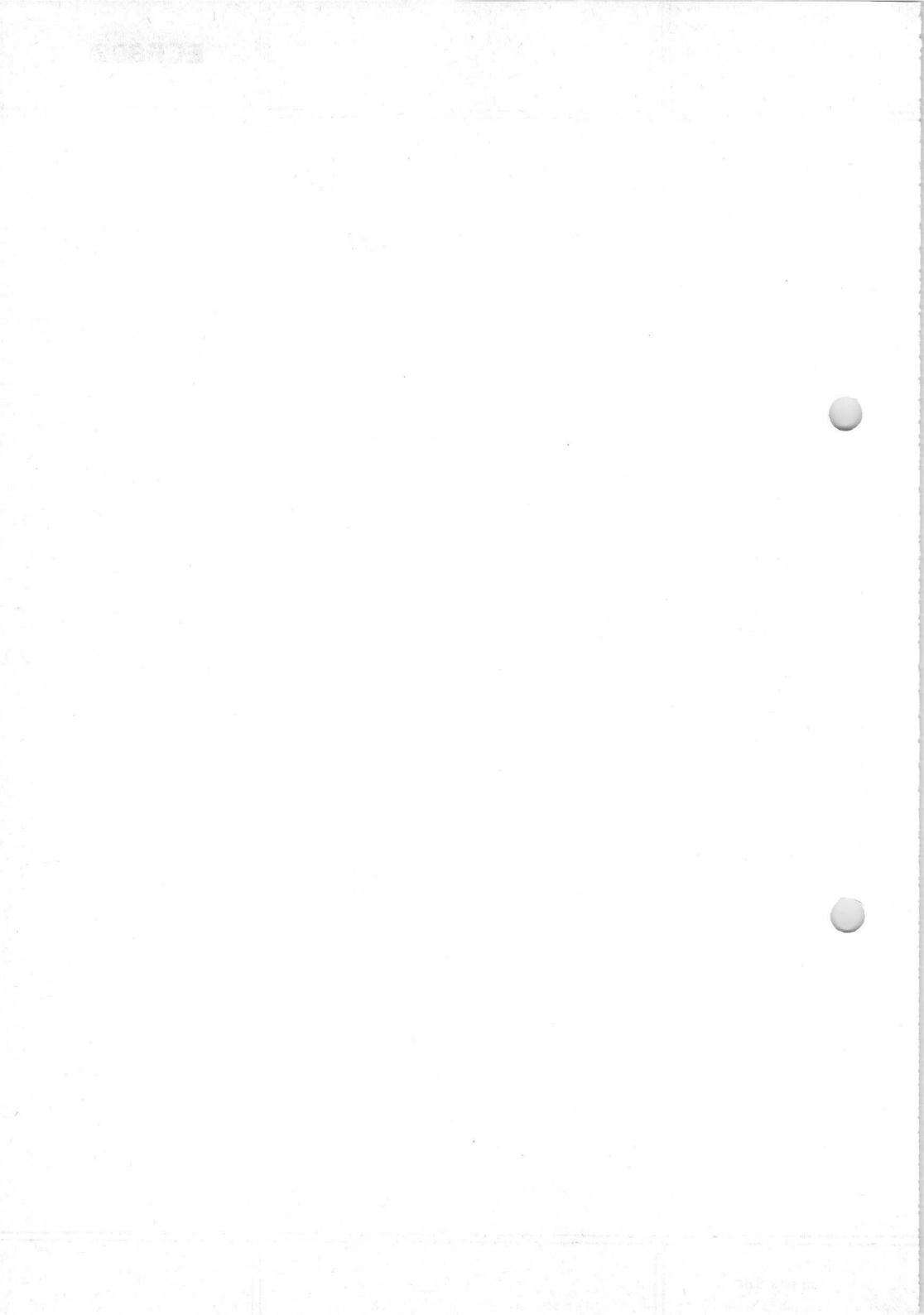

TRIODE-HEPTODE

Triode-heptode. Heptode section intended for use as mixer, R.F. - or I.F. amplifier. Triode section intended for use as oscillator in A.M./F.M. receivers.

QUICK REFERENCE DATA

<u>Triode section</u>		
Anode current	I_a	13.5 mA
Transconductance	S	3.7 mA/V
Amplification factor	μ	22 -
<u>Heptode section</u>		
Anode current	I_a	11 mA
Transconductance	S	4.5 mA/V
Amplification factor	$\mu_{g_2g_1}$	25 -

HEATING: Indirect by A.C. or D.C.; series or parallel supply

Heater voltage	V_f	6.3 V
Heater current	I_f	300 mA

DIMENSIONS AND CONNECTIONS

Dimensions in mm

Base: Noval

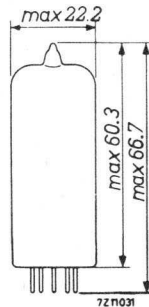
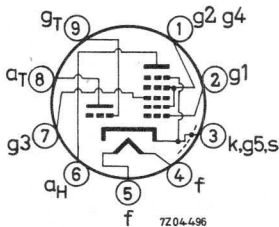

CAPACITANCES

Triode section

Grid to all except anode	$C_{g(a)}$	2.6 pF
Anode to all except grid	$C_{a(g)}$	2.1 pF
Anode to grid	C_{ag}	1.0 pF
Grid to heater	C_{gf}	max. 0.02 pF

Heptode section

Grid No.1 to all except anode	$C_{g_1(a)}$	4.8 pF
Anode to all except grid No.1	$C_{a(g_1)}$	7.9 pF
Anode to grid No.1	C_{ag_1}	max.0.006 pF
Grid No.1 to heater	C_{g_1f}	max. 0.17 pF
Grid No.3 to all	C_{g_3}	6 pF
Grid No.1 to grid No.3	$C_{g_1g_3}$	max. 0.3 pF
Grid No.3 to heater	C_{g_3f}	max. 0.06 pF

Between heptode and triode sections

Anode heptode to anode triode	C_{aH^aT}	0.20 pF
Anode heptode to grid triode	C_{aHgT}	max. 0.09 pF
Grid No.1 heptode to anode triode	$C_{g_1H^aT}$	max. 0.06 pF
Grid No.1 heptode to grid triode	C_{g_1HgT}	max. 0.17 pF
Grid No.1 heptode to grid triode + grid No.3	C_{g_1H/gTg_3}	max. 0.45 pF
Anode heptode to grid triode + grid No.3	C_{aH/gTg_3}	max. 0.35 pF

TYPICAL CHARACTERISTICS

Triode section

Anode voltage	V_a	100 V
Grid voltage	V_g	0 V
Anode current	I_a	13.5 mA
Transconductance	S	3.7 mA/V
Amplification factor	μ	22 -

Heptode section

Anode voltage	V_a	160 V
Grid No.3 voltage	V_{g3}	0 V
Grids No.2 and 4 voltage	V_{g2+4}	100 V
Grid No.1 current	I_{g1}	0.5 μ A
Grid No.1 voltage	V_{g1}	-0.5 V
Anode current	I_a	11 mA
Grids No.2 and 4 current	I_{g2+4}	7 mA
Transconductance	S	4.5 mA/V
Amplification factor	μ_{g2g1}	25 -

OPERATING CHARACTERISTICS

Heptode section as mixer ¹⁾

Supply voltage	V_b	250	V
Anode resistor	R_a	8.2	$k\Omega$
Grids No.2 and 4 resistor	R_{g_2+4}	22	$k\Omega$
Grid triode + grid No.3 resistor	$R_{g_T+g_3}$	47	$k\Omega$
Grid triode + grid No.3 current	$I_{g_T+g_3}$	200	μA
Grid No.1 current	I_{g_1}	0.5	μA ²⁾
Grid No.1 voltage	V_{g_1}	-	-28 V
Anode voltage	V_a	225	240 V
Grids No.2 and 4 voltage	V_{g_2+4}	78	235 V
Anode current	I_a	3.3	- mA
Grids No.2 and 4 current	I_{g_2+4}	7.8	- mA
Conversion conductance	S_c	1100	11 $\mu A/V$
Internal resistance	R_i	0.8	min. 3 $M\Omega$
Equivalent noise resistance	R_{eq}	30	- $k\Omega$

1) Triode operating with $V_b = 250$ V, $R_a = 33$ $k\Omega$, $V_{osc} = 8$ V_{RMS} .

2) Grid current bias obtained with $R_{g_1} = 1$ $M\Omega$ and with zero volts a.g.c. voltage; resulting grid one voltage: -0.5 V.

OPERATING CHARACTERISTICS (continued)

Heptode section as R.F. or I.F. amplifier

Supply voltage	V_b	250	V
Anode resistor	R_a	8.2	$k\Omega$
Grid No.3 voltage	V_{g_3}	0	V
Grids No.2 and 4 resistor	$R_{g_{2+4}}$	22	$k\Omega$
Grid No.1 current	I_{g_1}	0.5	μA
Grid No.1 voltage	V_{g_1}	-	-35 V ¹⁾
Anode voltage	V_a	160	248 V
Grids No.2 and 4 voltage	$V_{g_{2+4}}$	96	245 V
Anode current	I_a	11	- mA
Grids No.2 and 4 current	$I_{g_{2+4}}$	7	- mA
Transconductance	S	4500	45 $\mu A/V$
Internal resistance	R_i	0.24	min. 10 $M\Omega$
Amplification factor	$\mu_{g_2g_1}$	25	- -
Equivalent noise resistance	R_{eq}	4.5	- $k\Omega$

Triode section as oscillator

Supply voltage	V_b	250	V
Anode resistor	R_a	33	$k\Omega$
Grid triode + grid No.3 resistor	R_{gT+g_3}	47	$k\Omega$
Grid triode + grid No.3 current	I_{gT+g_3}	200	μA
Anode current	I_a	4.5	mA
Effective transconductance	S_{eff}	0.65	mA/V

¹⁾ Grid current bias obtained with $R_{g_1} = 1 M\Omega$ and with zero volts a.g.c. voltage; resulting grid No.1 voltage: -0.5 V.

LIMITING VALUES (Design centre rating system)

Heptode section

Anode voltage	V_{a_0}	max. 550 V
	V_a	max. 300 V
Anode dissipation	W_a	max. 2.0 W
Grids No.2 and 4 voltage	$V_{g_{2+4_0}}$	max. 550 V
	$V_{g_{2+4}}$	max. 125 V
Grids No.2 and 4 voltage (I_a max. 1 mA)	$V_{g_{2+4}}$	max. 300 V
Grids No.2 and 4 dissipation	$W_{g_{2+4}}$	max. 0.8 W
Cathode current	I_k	max. 18 mA
Grid No.1 resistor	R_{g_1}	max. 3 M Ω
Grid No.3 resistor	R_{g_3}	max. 20 k Ω
Grid No.3 resistor grid No.3 directly connected to grid triode	R_{g_3}	max. 3 M Ω
Cathode to heater voltage	V_{kf}	max. 100 V

Triode section

Anode voltage	V_{a_0}	max. 550 V
	V_a	max. 250 V
Anode dissipation	W_a	max. 0.8 W
Cathode current	I_k	max. 6.5 mA
Grid resistor	R_g	max. 3 M Ω
Cathode to heater voltage	V_{kf}	max. 100 V

TRIODE-HEPTODE

Triode-heptode intended for use as mixer in car radio sets and as sync separator in TV receivers.

QUICK REFERENCE DATA					
<u>Triode</u>					
Anode voltage	V_a	25	12.6	6.3	V
Anode current	I_a	2	0.75	0.3	mA
Transconductance	S	2.2	1.4	0.8	mA/V
Amplification factor	μ	20	18.3	14.6	-
<u>Heptode as mixer</u>					
Anode voltage	V_a	25	12.6	6.3	V
Grids No.2 and 4 voltage	$V_{g_{2+4}}$	25	12.6	6.3	V
Conversion conductance	S_c	450	220	90	$\mu A/V$
<u>Heptode as R.F. or I.F. amplifier</u>					
Anode voltage	V_a	25	12.6	6.3	V
Grids No.2 and 4 voltage	$V_{g_{2+4}}$	25	12.6	6.3	V
Transconductance	S	1.5	0.75	0.35	mA/V

HEATING: Indirect by A.C. or D.C.; parallel or series supply

Heater voltage	V_f	6.3	V
Heater current	I_f	300	mA

DIMENSIONS AND CONNECTIONS

Dimensions in mm

Base: Noval

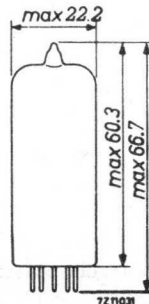
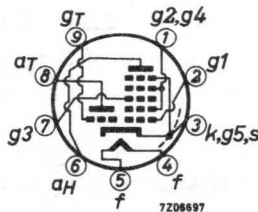

CAPACITANCES

Triode section

Anode to all except grid	$C_{a(g)}$	2.1 pF
Grid to all except anode	$C_{g(a)}$	2.6 pF
Anode to grid	C_{ag}	1.0 pF

Heptode section

Anode to all	C_a	7.9 pF
Grid No.1 to all	C_{g_1}	4.8 pF
Anode to grid No.1	C_{ag_1}	max. 0.012 pF
Grid No.3 to all	C_{g_3}	6.0 pF
Grid No.1 to grid No.3	$C_{g_1g_3}$	max. 0.3 pF

Between heptode and triode sections

Anode heptode to anode triode	C_{aHaT}	0.20 pF
Anode heptode to grid triode	C_{aHgT}	max. 0.09 pF
Grid No.1 heptode to anode triode	C_{g_1HaT}	max. 0.06 pF
Grid No.1 heptode to grid triode	C_{g_1HgT}	max. 0.17 pF
Grid No.1 heptode to grid triode and grid No.3	C_{g_1H/gTg_3}	max. 0.45 pF
Anode heptode to grid triode and grid No.3	C_{aH/gTg_3}	max. 0.35 pF

TYPICAL CHARACTERISTICS

Triode section

Anode voltage	V_a	25	12.6	6.3	V
Grid voltage	V_g	1)	1)	1)	-
Anode current	I_a	2	0.75	0.3	mA
Transconductance	S	2.2	1.4	0.8	mA/V
Amplification factor	μ	20	18.3	14.6	-

1) Obtained by grid current biasing: $R_g = 47 \text{ k}\Omega$.

OPERATING CHARACTERISTICS

Heptode as mixer, circuit fig.1.

Anode voltage	V_a	25	12.6	6.3	V
Grids No.2 and 4 voltage	$V_{g_{2+4}}$	25	12.6	6.3	V
Grid No.1 voltage	V_{g_1}	1)	1)	1)	
Oscillator voltage	V_{osc}	3.5	1.7	1.1	V_{RMS}
Grid No.3 resistor	R_{g_3}	47	47	47	$k\Omega$
Grid No.3 current	I_{g_3}	40	18	7	μA
Anode current	I_a	550	170	50	μA
Grids No.2 and 4 current	$I_{g_{2+4}}$	1000	300	80	μA
Conversion conductance	S_c	450	220	90	$\mu A/V$
Internal resistance	R_i	0.5	1.5	1.3	$M\Omega$

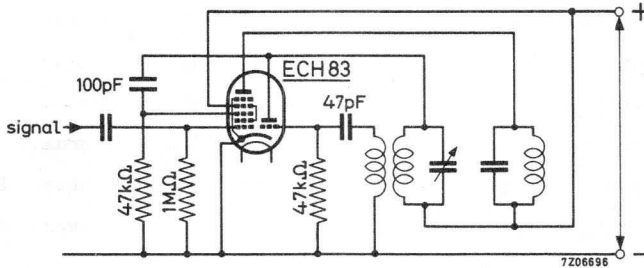

fig. 1

Heptode as R.F. or I.F. amplifier

Anode voltage	V_a	25	12.6	6.3	V
Grids No.2, No.3 and No.4 voltage	$V_{g_{2+3+4}}$	25	12.6	6.3	V
Grid No.1 voltage	V_{g_1}	1)	1)	1)	
Anode current	I_a	1.25	0.4	0.11	mA
Grids No.2, No.3 and 4 current	$I_{g_{2+3+4}}$	0.85	0.25	0.08	mA
Transconductance	S	1.5	0.75	0.35	mA/V
Internal resistance	R_i	0.2	0.85	0.6	$M\Omega$
Equivalent noise resistance	R_{eq}	5	6.5	8.5	$k\Omega$

1) Obtained by grid current biasing: $R_{g_1} = 1 M\Omega$.

LIMITING VALUES (Design centre rating system)

Triode section

Anode voltage	V_{a_0}	max. 550 V
	V_a	max. 250 V
Anode dissipation	W_a	max. 0.8 W
Cathode current	I_k	max. 6.5 mA
Grid resistor	R_g	max. 3 MΩ
Cathode to heater voltage	V_{kf}	max. 150 V
D.C. component		max. 100 V

Heptode section

Anode voltage	V_{a_0}	max. 550 V
	V_a	max. 50 V
Grids No.2 and 4 voltage	$V_{g_{2+4}}$	max. 50 V
Cathode current	I_k	max. 5 mA
Grid No.1 resistor	R_{g_1}	max. 3 MΩ
Grid No.3 resistor	R_{g_3}	max. 50 kΩ
Cathode to heater voltage	V_{kf}	max. 150 V
D.C. component		max. 100 V

TRIODE-HEPTODE

Triode-heptode intended for use as pulse separator, noise inverter and sync. amplifier.

QUICK REFERENCE DATA

<u>Triode section</u>		
Anode voltage	V_a	50 V
Anode current	I_a	3 mA
Transconductance	S	3.7 mA/V
Amplification factor	μ	50 -
<u>Heptode section</u>		
Anode voltage	V_a	135 V
Grids No.2 and 4 voltage	$V_{g_{2+4}}$	14 V
Anode current	I_a	1.7 mA
Grids No.2 and 4 current	$I_{g_{2+4}}$	0.9 mA
Transconductance	S	2.2 mA/V

HEATING: Indirect by A.C. or D.C.; series or parallel supply

Heater voltage

V_f 6.3 V

Heater current

I_f 300 mA

DIMENSIONS AND CONNECTIONS

Dimensions in mm

Base: Noval

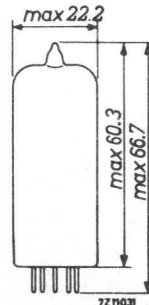
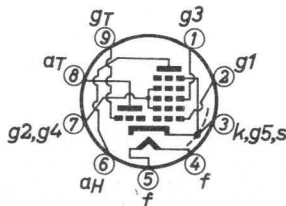

CAPACITANCES

Triode section

Grid to all except anode	$C_{g(a)}$	3.0 pF
Anode to grid	C_{ag}	1.1 pF

Heptode section

Anode to grid No. 1	C_{ag_1}	max. 0.009 pF
---------------------	------------	---------------

Between triode and heptode sections

Grid triode to grid No. 1 heptode	C_{gTg_1H}	max. 0.10 pF
Anode triode to grid No. 1 heptode	C_{aTg_1H}	max. 0.08 pF
Anode triode to grid No. 3 heptode	C_{aTg_3H}	max. 0.13 pF
Grid triode to anode heptode	C_{gT^aH}	max. 0.09 pF
Anode triode to anode heptode	C_{aT^aH}	max. 0.25 pF

TYPICAL CHARACTERISTICS

Triode section

Anode voltage	V_a	50 V
Grid voltage	V_g	0 V
Anode current	I_a	3 mA
Transconductance	S	3.7 mA/V
Amplification factor	μ	50 -
Anode voltage	V_a	200 V
Grid voltage	V_g	-11 V
Anode current	I_a	max. 0.1 mA

TYPICAL CHARACTERISTICS (continued)Heptode section

Anode voltage	V_a	135 V
Grid No. 3 voltage	V_{g3}	0 V
Grids No. 2 and 4 voltage	V_{g2+4}	14 V
Grid No. 1 voltage	V_{g1}	0 V
Anode current	I_a	1.7 mA
Grids No. 2 and 4 current	I_{g2+4}	0.9 mA
Transconductance	S	2.2 mA/V
Grid No. 3 voltage	V_{g3}	-2 V
Grid No. 1 voltage	V_{g1}	0 V
Anode current	I_a	20 μ A
Grid No. 1 voltage	V_{g1}	-1.9 V
Grid No. 3 voltage	V_{g3}	0 V
Anode current	I_a	20 μ A

LIMITING VALUES (Design centre rating system)Heptode section

Anode voltage	V_{a0}	max. 550 V
	V_a	max. 250 V
Anode dissipation	W_a	max. 1.7 W
Grids No. 2 + 4 voltage	V_{g2+4_0}	max. 550 V
	V_{g2+4}	max. 250 V min. 10 V ¹⁾
Grids No. 2 + 4 dissipation	W_{g2+4}	max. 0.8 W
Grid No. 3 voltage, negative peak	$-V_{g3p}$	max. 150 V
Grid No. 3 resistor	R_{g3}	max. 3 M Ω
Grid No. 1 voltage, negative peak	$-V_{g1p}$	max. 150 V
Grid No. 1 resistor	R_{g1}	max. 3 M Ω
Cathode current	I_k	max. 12.5 mA
Cathode to heater voltage	V_{kf}	max. 100 V

¹⁾ This value applies to an average tube operated under the worst probable conditions.

LIMITING VALUES (continued)

Triode section

Anode voltage	V_{a0}	max.	550 V
	V_a	max.	250 V
Anode dissipation	W_a	max.	1.3 W
Grid voltage, negative peak	$-V_{gp}$	max.	200 V
Grid resistor	R_g	max.	3 M Ω
Cathode current	I_k	max.	10 mA
Cathode to heater voltage	V_{kf}	max.	100 V

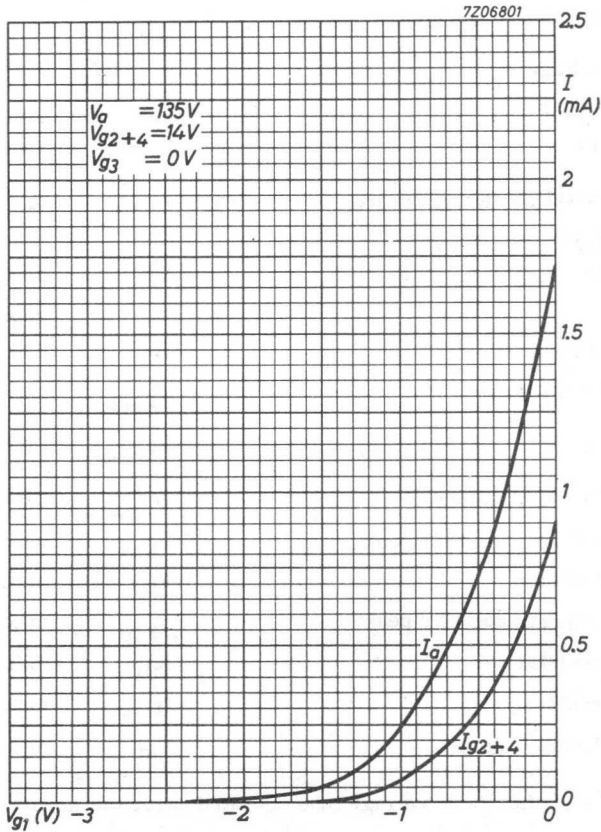

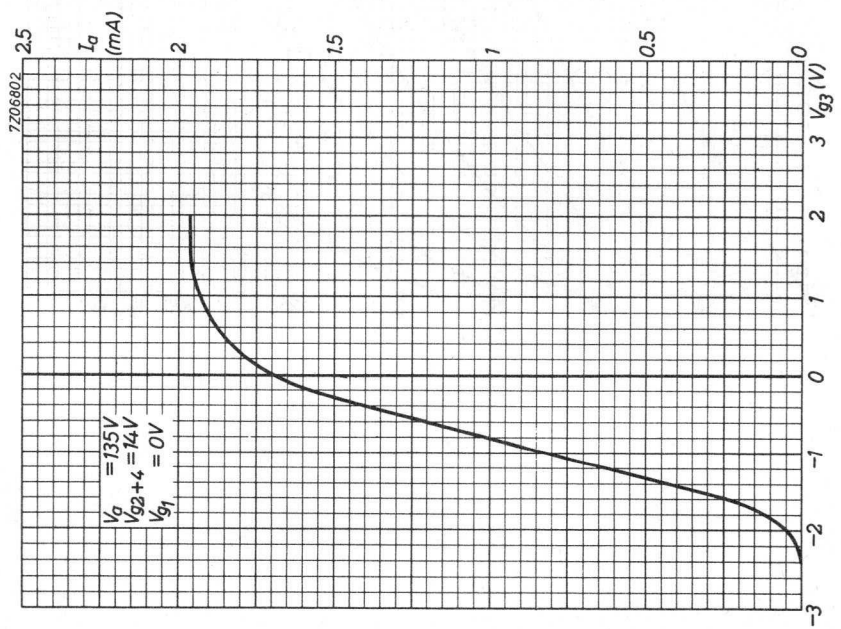
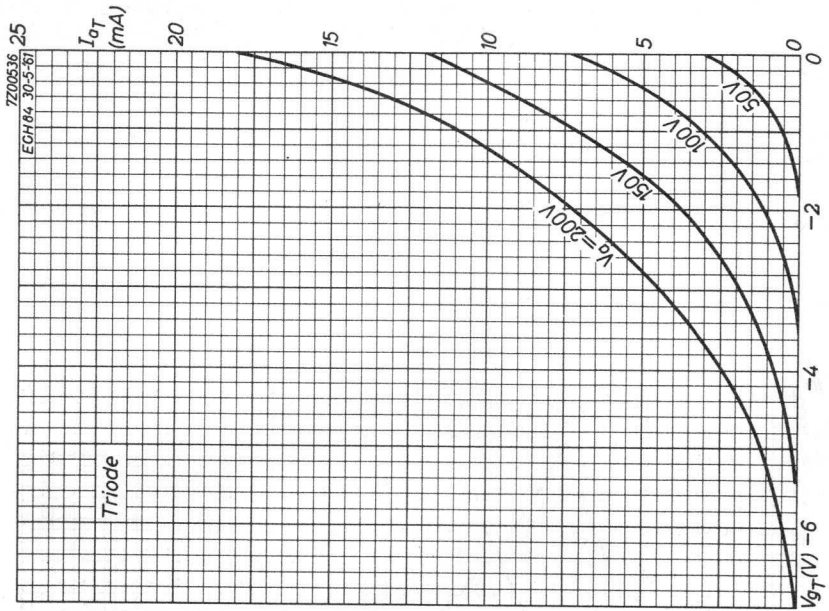

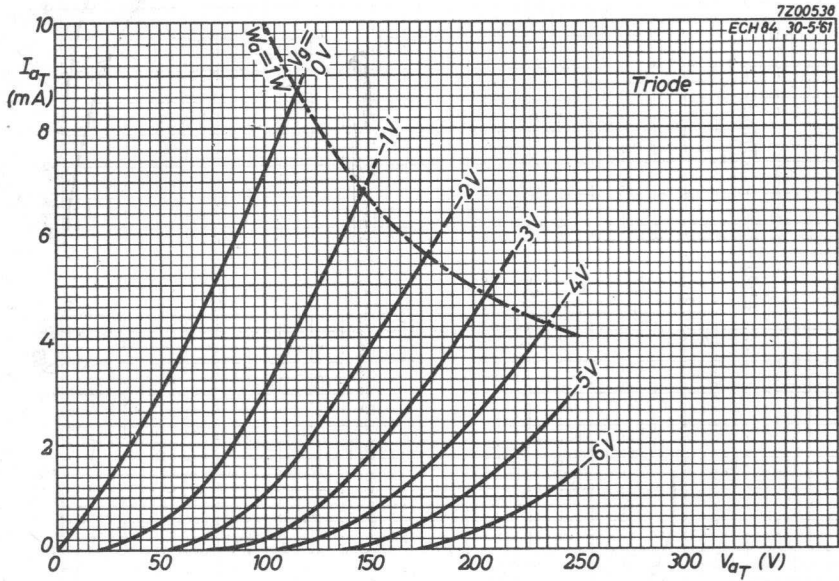

TRIODE-HEPTODE

Triode-heptode; triode section intended for use as pulse amplifier and heptode section for use as noise gated sync. separator.

HEATING: Indirect by A.C. or D.C.; parallel supply

Heater voltage	V_f	6.3 V
Heater current	I_f	435 mA

LIMITING VALUES (Design centre rating system)

Triode section

Cathode to heater voltage V_{kf} max. 100 V

Heptode section

Cathode to heater voltage V_{kf} max. 100 V

 For further data and curves of this type
 please refer to type PCH200

001-107

1977-1978



TRIODE-OUTPUT PENTODE

The triode section is intended for use as frame oscillator and A.F. amplifier. The pentode section is intended for use as frame output tube and A.F. power amplifier.

QUICK REFERENCE DATA			
<u>Triode section</u>			
Anode current	I_a	3.5	mA
Transconductance	S	2.2	mA/V
Amplification factor	μ	70	-
<u>Pentode section</u>			
Anode peak voltage	V_{ap}	max. 2.5	kV
Anode current	I_a	41	mA
Transconductance	S	7.5	mA/V
Amplification factor	$\mu_{g_2g_1}$	9.5	-
Output power	W_o	3.5	W

HEATING: Indirect by A.C. or D.C.; parallel supply

Heater voltage
Heater current

V_f 6.3 V
 I_f 780 mA

DIMENSIONS AND CONNECTIONS

Base: Noval

Dimensions in mm

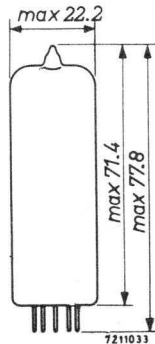
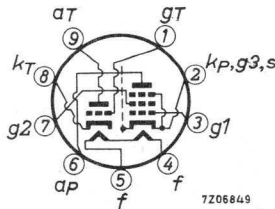

CAPACITANCESTriode section

Anode to all except grid	$C_{a(g)}$	4.3	pF
Grid to all except anode	$C_{g(a)}$	2.7	pF
Anode to grid	C_{ag}	4.4	pF
Grid to heater	C_{gf}	max. 0.1	pF

Pentode section

Anode to all except grid No.1	$C_{a(g_1)}$	8.0	pF
Grid No.1 to all except anode	$C_{g_1(a)}$	9.3	pF
Anode to grid No.1	C_{ag_1}	max. 0.3	pF
Grid No.1 to heater	C_{g_1f}	max. 0.3	pF

Between triode and pentode sections

Anode triode to grid No.1 pentode	C_{aTg_1P}	max. 0.02	pF
Grid triode to anode pentode	C_{gTaP}	max. 0.02	pF
Grid triode to grid No.1 pentode	C_{gTg_1P}	max. 0.025	pF
Anode triode to anode pentode	C_{aTaP}	max. 0.25	pF

TYPICAL CHARACTERISTICSTriode section

Anode voltage	V_a	100	V
Grid voltage	V_g	0	V
Anode current	I_a	3.5	mA
Transconductance	S	2.2	mA/V
Amplification factor	μ	70	-

Pentode section

Anode voltage	V_a	170	V
Grid No.2 voltage	V_{g_2}	170	V
Grid No.1 voltage	V_{g_1}	-11.5	V
Anode current	I_a	41	mA
Grid No.2 current	I_{g_2}	9	mA
Transconductance	S	7.5	mA/V
Amplification factor	$\mu_{g_2g_1}$	9.5	-
Internal resistance	R_i	16	k Ω

OPERATING CHARACTERISTICS

Triode section as A.F. amplifier

A. Signal source resistance	R_s	0.22	$M\Omega$
Grid resistor	R_g	3	$M\Omega$
Grid resistor of next stage	R_g	0.68	$M\Omega$
Supply voltage	V_b	200	170 V
Cathode resistor	R_k	2.2	2.7 $k\Omega$
Anode resistor	R_a	220	220 $k\Omega$
Anode current	I_a	0.52	0.43 mA
Voltage gain	V_o/V_i ¹⁾	52	51 -
Max. output voltage	V_o max	26	25 V_{RMS}
Distortion	d_{tot} ²⁾	1.6	2.3 %

B. Signal source resistance	R_s	0.22	$M\Omega$			
Grid resistor	R_g	22	$M\Omega$			
Grid resistor of next stage	R_g'	0.68	$M\Omega$			
Supply voltage	V_b	200	200	170	170	V
Cathode resistor	R_k	0	0	0	0	Ω
Anode resistor	R_a	100	220	100	220	$k\Omega$
Anode current	I_a	1.05	0.61	0.86	0.50	$M\Omega$
Voltage gain	V_o/V_i ¹⁾	50	55	49	53	-
Max. output voltage	V_o max	24	25	19	20	V_{RMS}
Distortion	d_{tot} ³⁾	1.5	1.4	1.4	1.4	%

MICROPHONY AND HUM

The triode section can be used without special precautions against microphony and hum in circuits in which an input voltage of minimum 10 mVRMS is required for an output of 50 mW of the output stage. $Z_g(50 \text{ Hz}) = 0.25 M\Omega$.

1) Measured at small input voltage.

2) At lower output voltages the distortion is proportionally lower.

3) At lower output voltages down to 5 VRMS the distortion is approximately constant. At values below 5 VRMS the distortion is approximately proportional to V_o .

OPERATING CHARACTERISTICS

Pentode section

A.F. power amplifier, class A (measured with V_k constant)

Supply voltage	$V_{ba} = V_{bg_2}$	200	272	V
Grid No.2 series resistor (non-decoupled)	R_{g_2}	470	2200	Ω
Cathode resistor	R_k	330	650	Ω
Load resistance	$R_{a\sim}$	4.5	8	k Ω
Grid No.1 driving voltage	V_i	0 0.66 6.7	0 0.9 9.5	V_{RMS}
Anode current	I_a	35 37	28 27	mA
Grid No.2 current	I_{g_2}	7.8 13.3	6.5 10.8	mA
Output power	W_o	0 0.05 3.3	0 0.05 3.5	W
Distortion	d_{tot}	- - 10	- - 10	%

A.F. power amplifier, class AB, two tubes in push-pull

Anode supply voltage	V_{ba}	200	250	V
Grid No.2 supply voltage	V_{bg_2}	200	200	V
Common cathode resistor	R_k	170	220	Ω
Load resistance	$R_{aa'\sim}$	4.5	10	k Ω
Grid No.1 driving voltage	V_i	0 14.2	0 12.5	V_{RMS}
Anode current	I_a	2x35 2x42.5	2x28 2x31	mA
Grid No.2 current	I_{g_2}	2x8 2x16.5	2x5.8 2x13	mA
Output power	W_o	0 9.3	0 10.5	W
Distortion	d_{tot}	- 6.3	- 4.8	%

Frame output application

The circuit should operate satisfactorily with a peak anode current $I_{ap} = 85$ mA at $V_a = 50$ V, $V_{g_2} = 170$ V, $V_f = 6.3$ V. The minimum available I_{ap} at end of life is;

- 70 mA at $V_a = 50$ V, $V_{g_2} = 170$ V, $V_f = 5.5$ V
- 80 mA at $V_a = 50$ V, $V_{g_2} = 190$ V, $V_f = 5.5$ V.

LIMITING VALUES (Design centre rating system)

Triode section

Anode voltage	V_{a0}	max. 550 V
	V_a	max. 300 V
Anode peak voltage	V_{ap}	max. 600 V ¹⁾
Anode dissipation	W_a	max. 1 W
Cathode current, average	I_k	max. 15 mA
	I_{kp}	max. 100 mA ¹⁾
Grid resistor for fixed bias	R_g	max. 1 M Ω
	R_g	max. 3 M Ω
Grid impedance at 50 Hz	Z_g	max. 0.5 M Ω
Cathode to heater voltage	V_{kf}	max. 100 V

Pentode section

Anode voltage	V_{a0}	max. 550 V
	V_a	max. 300 V
Anode peak voltage, positive	V_{ap}	max. 2.5 kV ¹⁾
	$-V_{ap}$	max. 500 V
Anode dissipation for frame output application	W_a	max. 5 W
	W_a	max. 7 W
Grid No.2 voltage	V_{g20}	max. 550 V
	V_{g2}	max. 300 V
Grid No.2 dissipation, average	W_{g2}	max. 2 W
	W_{g2p}	max. 3.2 W
Cathode current	I_k	max. 50 mA
Grid No.1 resistor for fixed bias	R_{g1}	max. 1 M Ω
	R_{g1}	max. 2 M Ω
Cathode to heater voltage	V_{kf}	max. 150 V

For curves of the ECL82 please refer to PCL82

¹⁾ Max. pulse duration 4% of a cycle with a maximum of 0.8 msec.

THE UNIVERSITY OF CHICAGO LIBRARY

1950

1950

1950

1950

1950

1950

1950

1950

1950

1950

1950

1950

TRIODE-OUTPUT PENTODE

Triode-pentode with separate cathodes

The triode section is intended for use in circuits for keyed AGC, sync separation, sync amplification and noise suppression.

The pentode section is intended for use as video output tube.

HEATING: Indirect by A. C. or D. C. ; parallel supply

Heater voltage

V_f 6.3 V

Heater current

I_f 720 mA

LIMITING VALUES (Design centre rating system)

Triode section

Cathode to heater voltage

V_{kf} max. 200 V

 For further data and curves
 please refer to PCL84

THE UNIVERSITY OF CHICAGO



TRIODE-OUTPUT PENTODE

Triode pentode with separate cathodes.
Triode intended for use as frame oscillator or pulse amplifier.
Pentode intended for use as frame output tube.

HEATING: Indirect by A. C. or D. C.; parallel supply

Heater voltage	V_f	6.3 V
Heater current	I_f	875 mA

OPERATING CHARACTERISTICS OF THE PENTODE SECTION

Hum

The equivalent pentode grid hum voltage without negative feedback and without A. C. voltage between heater and cathode is max. 10 mV_{RMS} when Z_{g_1} (at $f = 50$ Hz) ≤ 0.5 M Ω and $C_{g_1-f} = 0.2$ pF.

LIMITING VALUES (Design centre rating system)

Triode section

Cathode to heater voltage	V_{kf}	max. 100 V
D. C. component during warming up	V_{kf} (k pos)	max. 315 V

Pentode section

Cathode to heater voltage	V_{kf}	max. 100 V
---------------------------	----------	------------

For further data and curves
please refer to PCL85/PCL805

SECTION 10 - 10000

1. The contractor shall provide all materials and labor necessary for the completion of the work.

2. The contractor shall be responsible for obtaining all necessary permits and licenses.

3. The contractor shall maintain access to all adjacent properties at all times.

4. The contractor shall be responsible for the safety of all workers and the public.

5. The contractor shall provide a clean and safe work environment at all times.

6. The contractor shall be responsible for the disposal of all waste materials.

7. The contractor shall be responsible for the protection of all existing utilities.

8. The contractor shall be responsible for the protection of all existing structures.

9. The contractor shall be responsible for the protection of all existing trees.

10. The contractor shall be responsible for the protection of all existing landscaping.

11. The contractor shall be responsible for the protection of all existing fences.

12. The contractor shall be responsible for the protection of all existing signs.

13. The contractor shall be responsible for the protection of all existing monuments.

14. The contractor shall be responsible for the protection of all existing markers.

15. The contractor shall be responsible for the protection of all existing monuments.

16. The contractor shall be responsible for the protection of all existing markers.

17. The contractor shall be responsible for the protection of all existing monuments.

18. The contractor shall be responsible for the protection of all existing markers.

19. The contractor shall be responsible for the protection of all existing monuments.

20. The contractor shall be responsible for the protection of all existing markers.

TRIODE-OUTPUT PENTODE

Triode pentode with separate cathodes.

The triode section is intended for use as A.F. amplifier.

The pentode section is intended for use as A.F. power amplifier.

QUICK REFERENCE DATA

<u>Triode section</u>		
Anode current	I_a	1.2 mA
Transconductance	S	1.6 mA/V
Amplification factor	μ	100 -
<u>Pentode section</u>		
Anode current	I_a	36 mA
Transconductance	S	10 mA/V
Amplification factor	$\mu_{g_2g_1}$	21 -
Output power	W_o	4.0 W

HEATING: Indirect by A.C. or D.C.; parallel supply

Heater voltage	V_f	6.3 V
Heater current	I_f	660 mA

DIMENSIONS AND CONNECTIONS

Dimensions in mm

Base: Noval

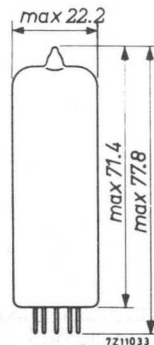
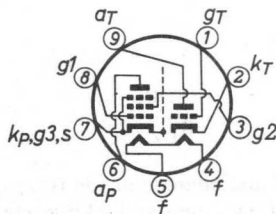

CAPACITANCES

Triode section

Anode to all except grid	$C_{a(g)}$	2.5 pF
Grid to all except anode	$C_{g(a)}$	2.3 pF
Anode to grid	C_{ag}	1.4 pF
Grid to heater	C_{gf}	max. 0.006 pF

Pentode section

Grid No.1 to all except anode	$C_{g_1(a)}$	10 pF
Anode to grid No.1	C_{ag_1}	max. 0.4 pF
Grid No.1 to heater	C_{g_1f}	max. 0.24 pF

Between triode and pentode sections

Anode triode to grid No.1 pentode	C_{aTg_1P}	max. 0.2 pF
Grid triode to grid No.1 pentode	C_{gTg_1P}	max. 0.02 pF
Anode triode to anode pentode	C_{aTaP}	max. 0.15 pF
Grid triode to anode pentode	C_{gTaP}	max. 0.006 pF ¹⁾

TYPICAL CHARACTERISTICS

Triode section

Anode voltage	V_a	250 V
Grid voltage	V_g	-1.9 V
Anode current	I_a	1.2 mA
Transconductance	S	1.6 mA/V
Amplification factor	μ	100 -

Pentode section

Anode voltage	V_a	250 V
Grid No.2 voltage	V_{g_2}	250 V
Grid No.1 voltage	V_{g_1}	-7 V
Anode current	I_a	36 mA
Grid No.2 current	I_{g_2}	6 mA
Transconductance	S	10 mA/V
Amplification factor	$\mu_{g_2g_1}$	21 -
Internal resistance	R_i	48 k Ω

¹⁾ The capacitance between triode grid and pentode anode (C_{gT-aP}) can be reduced to a value of less than 0.002 pF by using a shielding ring with a diameter of 22.5 mm and a height of 15 mm with respect to the tube base.

OPERATING CHARACTERISTICS

Triode section

as A.F. amplifier

Supply voltage	V_b	200	250	250	300	V
Cathode resistor	R_k	2.6	1.75	1.75	1.2	$k\Omega$
Anode resistor	R_a	220	220	220	220	$k\Omega$
Grid resistor of following stage	$R_{g'}$	0.68	0.68	10	10	$M\Omega$
Anode current	I_a	0.42	0.6	0.6	0.8	mA
Output voltage	V_o	3.2	3.2	5	9	V_{RMS}
Voltage gain	V_o/V_i	66	70	75	80	-
Distortion	d_{tot}	0.6	0.4	0.4	0.4	%

A.F. amplifier with grid current biasing

Supply voltage	V_b	200	250	250	300	V
Cathode resistor	R_k	0	0	0	0	Ω
Anode resistor	R_a	220	220	220	220	$k\Omega$
Grid resistor	R_g	10	10	10	10	$M\Omega$
Grid resistor of following stage	$R_{g'}$	0.68	0.68	10	10	$M\Omega$
Signal source resistance	R_s	47	47	47	47	$k\Omega$
Anode current	I_a	0.42	0.6	0.6	0.8	mA
Output voltage	V_o	3.2	3.2	5	9	V_{RMS}
Voltage gain	V_o/V_i	66	70	75	80	-
Distortion	d_{tot}	0.6	0.4	0.4	0.4	%

MICROPHONY

The triode section can be used without special precautions against microphonic effect in circuits in which an output of 50 mW is obtained at an input voltage of not less than 4 mV_{RMS}.

HUM

The hum level will be better than 60 dB under the following conditions:

Input voltage minimum 10 mV_{RMS} for 50 mW output.

Grid circuit impedance max. 0.5 M Ω at 50 Hz.

Cathode decoupling capacitor minimum 100 μ F.

Pin 4 connected to earth.

OPERATING CHARACTERISTICS (continued)

Pentode section

Class A (Measured with V_k constant)

Anode voltage	V_a	250		250		V	
Grid No.2 voltage	V_{g2}	250		250		V	
Cathode resistor	R_k	170		270		Ω	
Load resistance	$R_{a\sim}$	7		10		k Ω	
Grid No.1 driving voltage	V_i	0 0.3 3.2		0 0.28 2.7		V _{RMS}	
Anode current	I_a	36	-	37	26	-	27 mA
Grid No.2 current	I_{g2}	6	-	10.2	4.4	-	8.0 mA
Output power	W_o	0	0.05	4.0	0	0.05	2.8 W
Distortion	d_{tot}	-	0.95	10	-	1.1	10 %

Class AB, two tubes in push-pull

Supply voltage	V_b	250		300		V	
Common cathode resistor	R_k	90		130		Ω	
Load resistance	$R_{aa\sim}$	8.2		9.1		k Ω	
Grid No.1 driving voltage	V_i	0 0.24 5.5		0 0.26 8.4		V _{RMS}	
Anode current	I_a	2x32.5	-	2x35.5	2x31	-	2x36.5 mA
Grid No.2 current	I_{g2}	2x5.6	-	2x8.9	2x5.5	-	2x11 mA
Output power	W_o	0	0.05	10	0	0.05	13.6 W
Distortion	d_{tot}	-	<0.4	5.0	-	<0.4	4.0 %

LIMITING VALUES (Design centre rating system)Triode section

Anode voltage	V_{a0}	max.	550 V
	V_a	max.	300 V
Anode dissipation	W_a	max.	0.5 W
Cathode current	I_k	max.	4 mA
Grid resistor	R_g	max.	1 M Ω ¹⁾
Cathode to heater voltage	V_{kf}	max.	100 V

Pentode section

Anode voltage	V_{a0}	max.	550 V
	V_a	max.	300 V
Grid No.2 voltage	V_{g20}	max.	550 V
	V_{g2}	max.	300 V
Anode dissipation	W_a	max.	9 W
Grid No.2 dissipation			
average	W_{g2}	max.	1.8 W
peak	W_{g2p}	max.	3.25 W
Cathode current	I_k	max.	55 mA
Grid No.1 resistor	R_{g1}	max.	0.5 M Ω ¹⁾
Cathode to heater voltage	V_{kf}	max.	100 V

¹⁾ This value applies to operation with fixed bias. It may be multiplied by the D.C. inverse feedback factor resulting from e.g. cathode, screen grid or anode resistors, to a maximum of 10 M Ω .

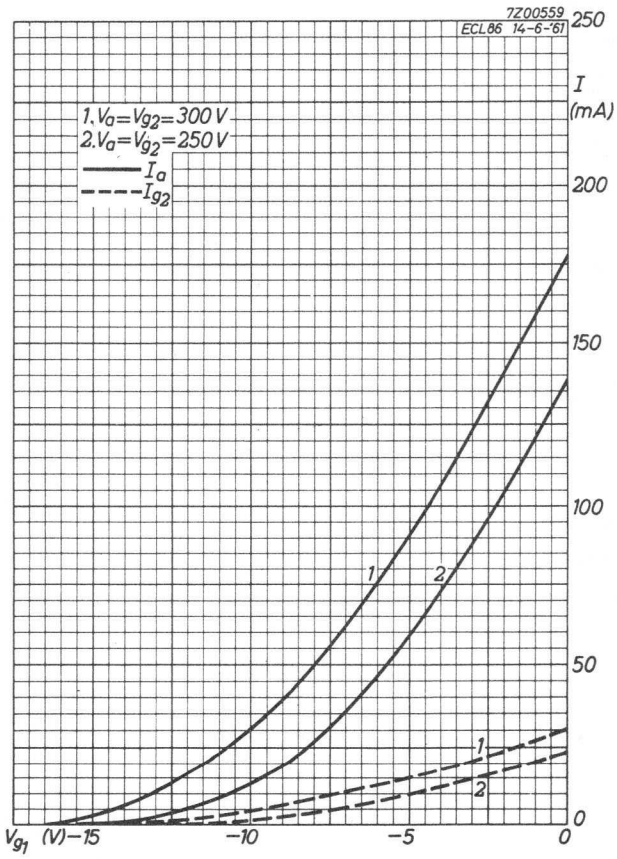

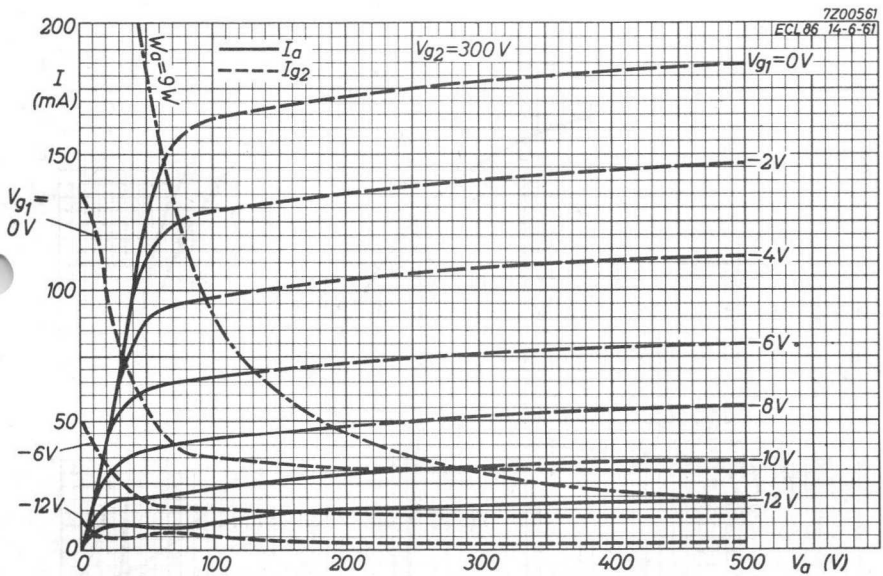
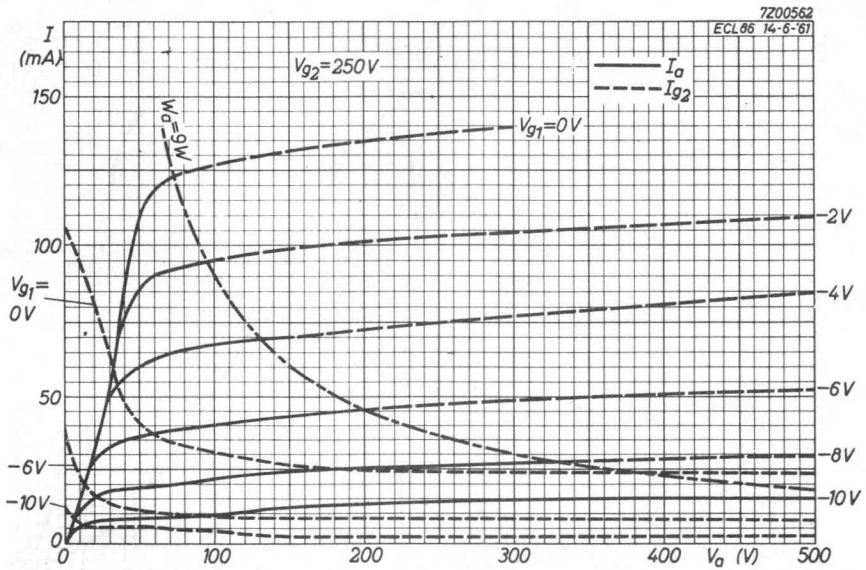

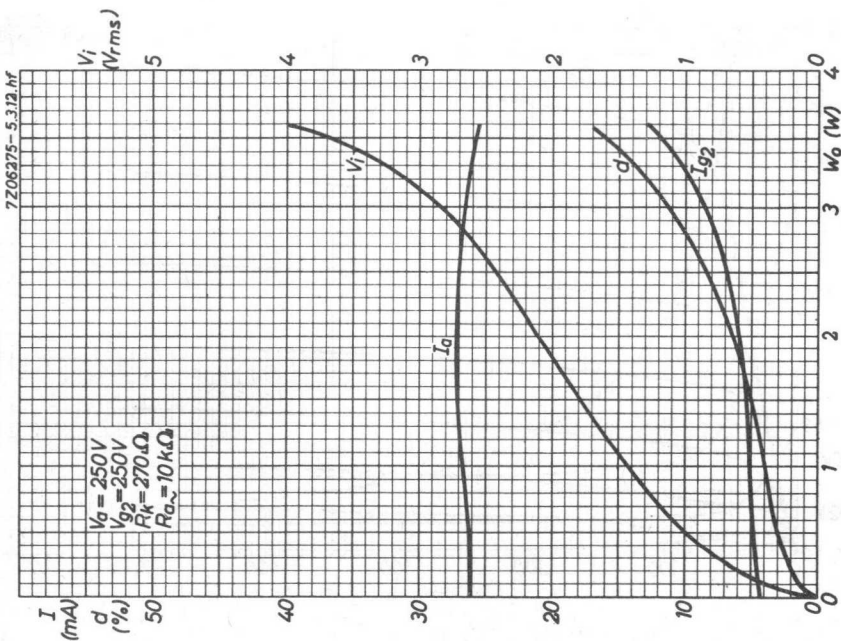
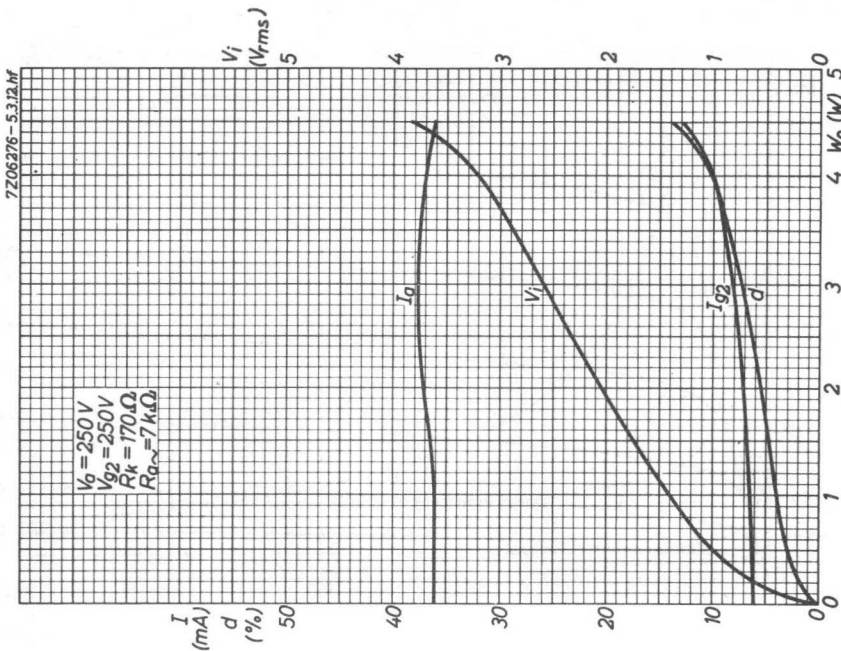

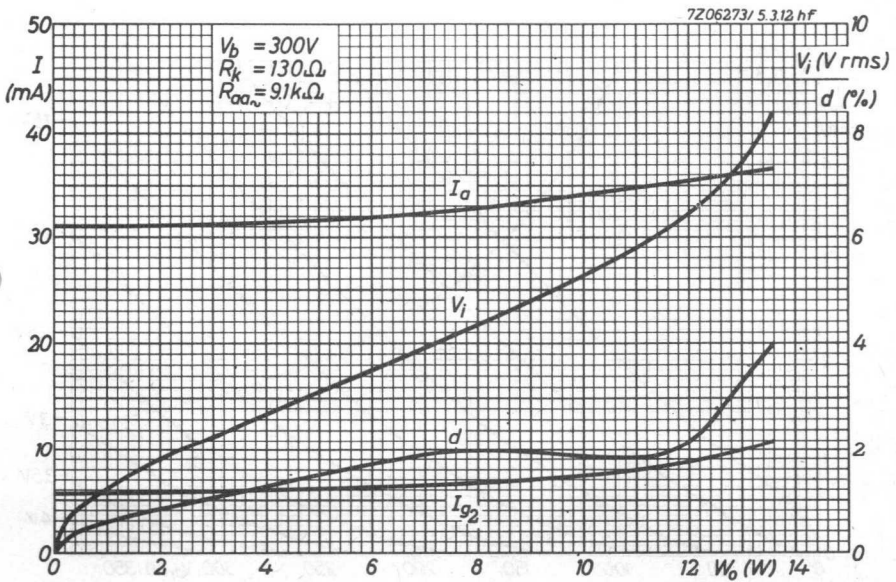
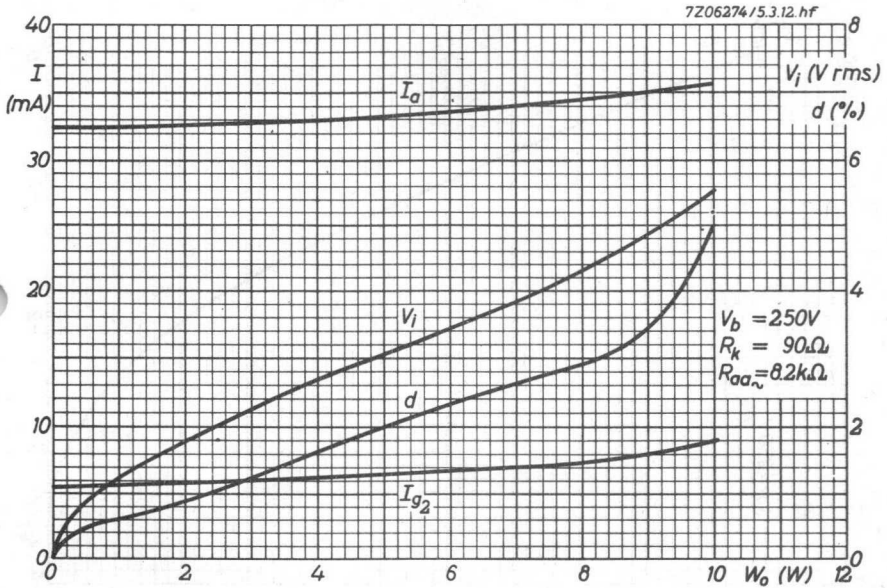

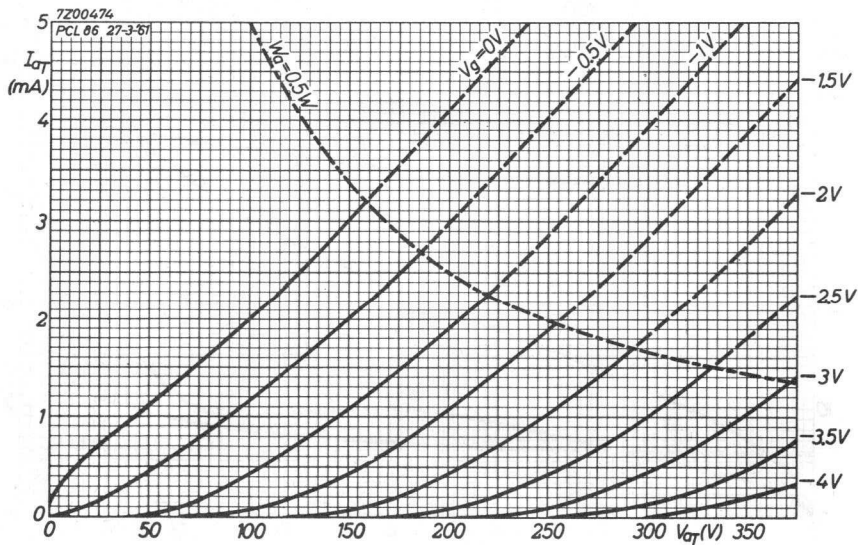
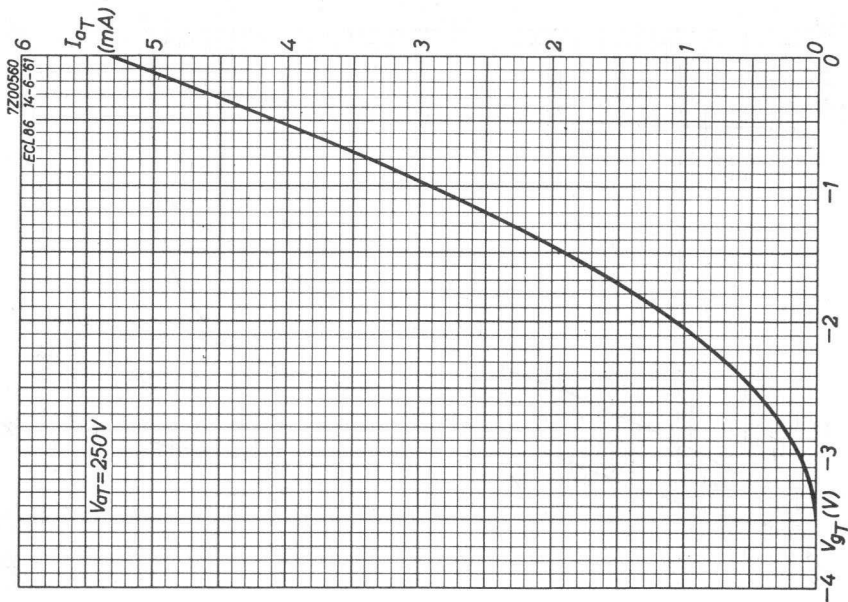

SHUNT STABILIZER TRIODE

Shunt stabilizer triode intended for use as in colour TV receivers.

HEATING: Indirect by A.C. or D.C.; parallel supply

Heater voltage

V_f 6.3 V

Heater current

I_f 350 mA

For further data and curve of this type
please refer to type PD500

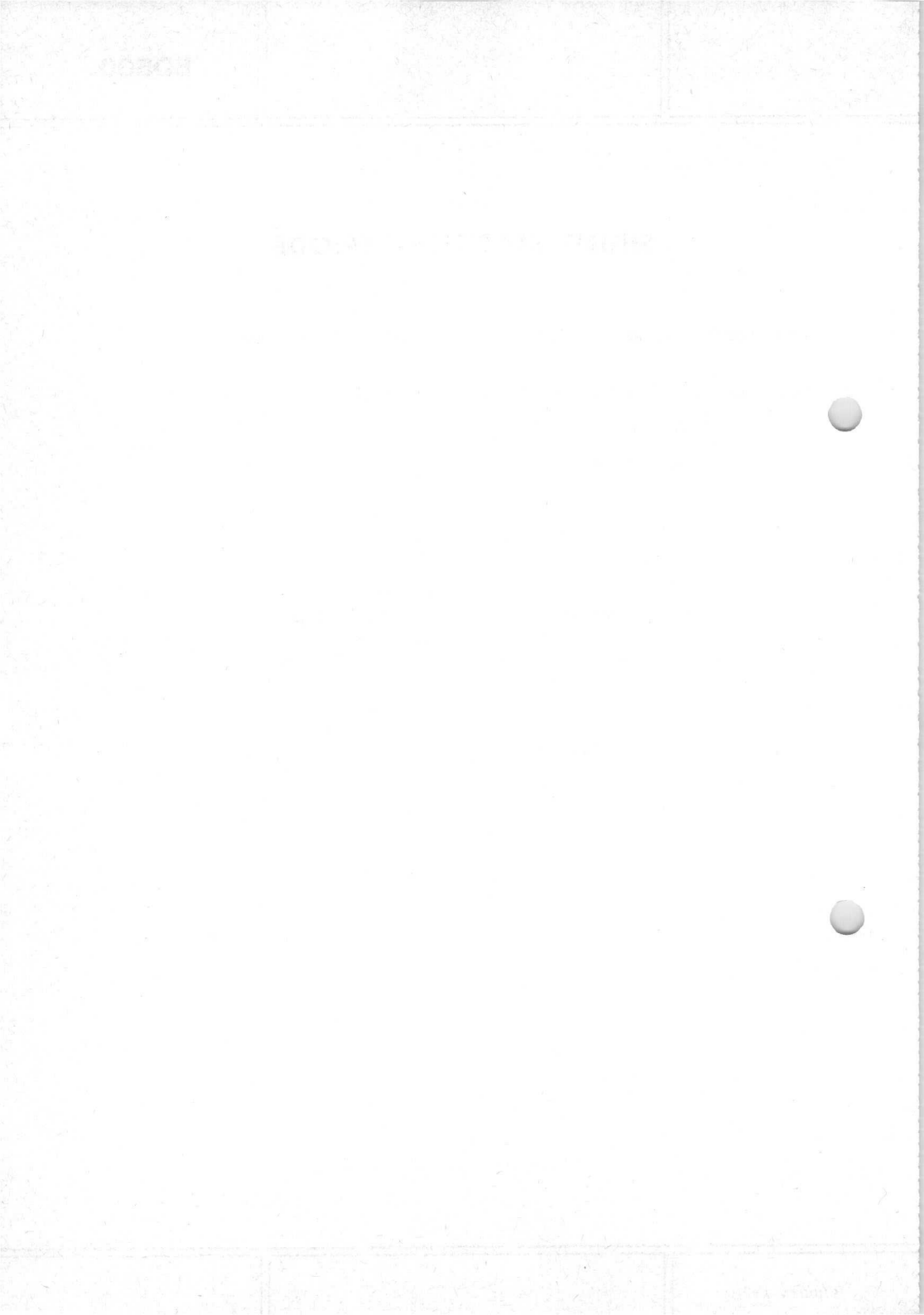

R.F. PENTODE

Pentode intended for use as R.F., I.F. or video amplifying tube or as mixing tube in television receivers.

QUICK REFERENCE DATA

Anode current	I_a	10 mA
Transconductance	S	7.4 mA/V
Amplification factor	$\mu_{g_2g_1}$	50 -
Internal resistance	R_i	500 k Ω

HEATING: Indirect by A.C. or D.C.; series or parallel supply

Heater voltage V_f 6.3 V

Heater current I_f 300 mA

DIMENSIONS AND CONNECTIONS

Dimensions in mm

Base: Noval

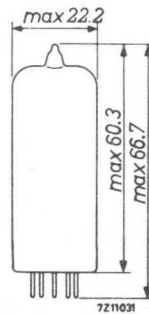
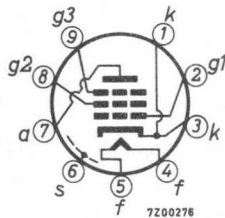

CAPACITANCES

Grid No.1 to all except anode	$C_{g_1(a)}$	6.9 pF
Anode to all except grid No.1	$C_{a(g_1)}$	3.1 pF
Anode to grid No.1	C_{ag_1}	max. 0.007 pF
Anode to cathode	C_{ak}	max. 0.012 pF
Grid No.2 to all	C_{g_2}	5.4 pF
Grid No.1 to grid No.2	$C_{g_1g_2}$	2.6 pF
Grid No.1 to heater	C_{g_1f}	max. 0.15 pF
Cathode to heater	C_{kf}	5.0 pF

REMARK

When using the EF80 as video amplifier the amplification between the input grid of the EF80 and the input of the cathode ray tube should not exceed a value of 25, in order to prevent microphonic effect.

TYPICAL CHARACTERISTICS AND OPERATING CHARACTERISTICS

Anode voltage	V_a	170	200	250	V
Grid No.3 voltage	V_{g_3}	0	0	0	V
Grid No.2 voltage	V_{g_2}	170	200	250	V
Grid No.1 voltage	V_{g_1}	-2.0	-2.55	-3.5	V
Anode current	I_a	10	10	10	mA
Grid No.2 current	I_{g_2}	2.5	2.6	2.8	mA
Transconductance	S	7.4	7.1	6.8	mA/V
Internal resistance	R_i	0.5	0.55	0.65	M Ω
Amplification factor	$\mu_{g_2g_1}$	50	50	50	-
Equivalent noise resistance	R_{eq}	1000	1100	1200	Ω
Grid No.1 input resistance					
f = 50 MHz, pin 1 connected to pin 3	r_{g_1}	10	12	15	k Ω

LIMITING VALUES (Design centre rating system)

Anode voltage	V_{a0}	max. 550 V
	V_a	max. 300 V
Anode dissipation	W_a	max. 2.5 W
Grid No.2 voltage	V_{g20}	max. 550 V
	V_{g2}	max. 300 V
Grid No.2 dissipation	W_{g2}	max. 0.7 W
Grid No.2 dissipation ($W_a < 1.8$ W)	W_{g2}	max. 0.9 W
Grid No.1 resistor	R_{g1}	max. 1 M Ω
Cathode current	I_k	max. 15 mA
Heater to cathode voltage	V_{kf}	max. 150 V

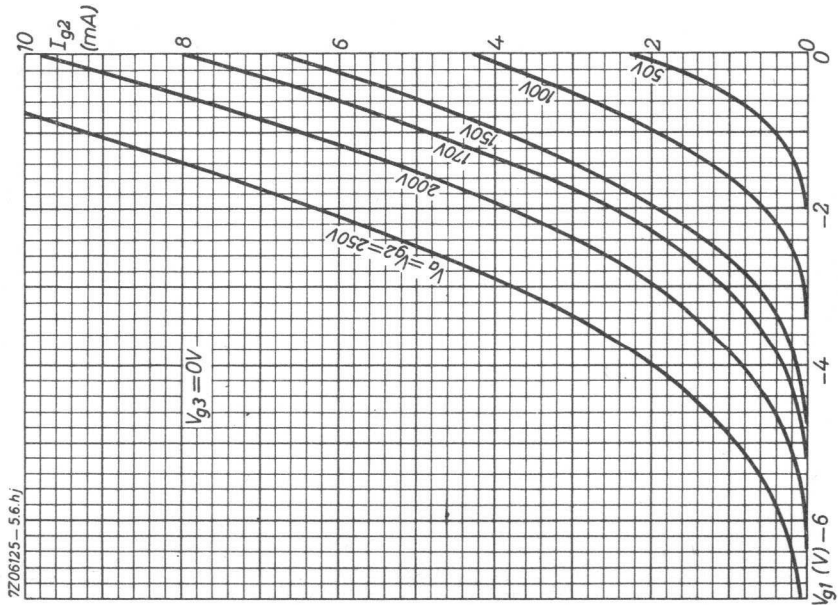
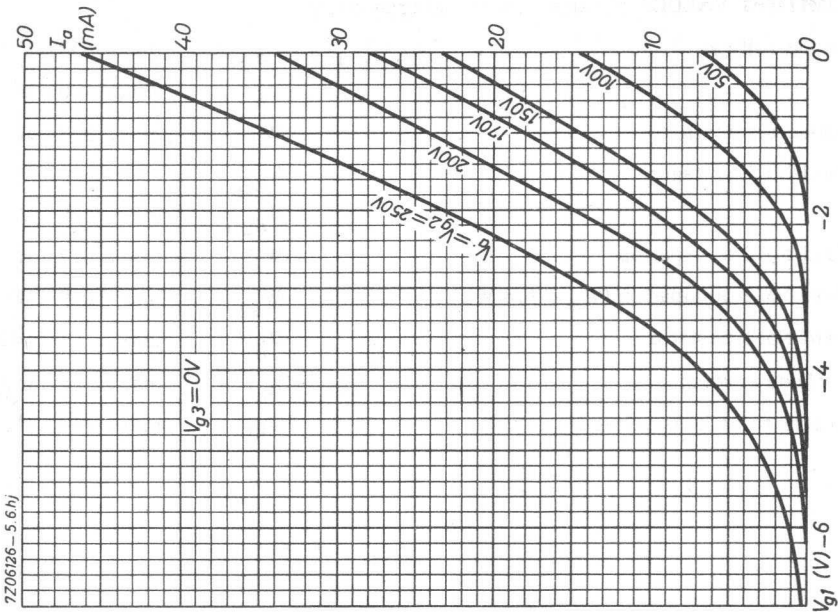

R.F. PENTODE

R.F. pentode with variable transconductance intended for use as wide-band amplifier.

QUICK REFERENCE DATA			
Anode current	I_a	10	mA
Transconductance	S	6.0	mA/V
Amplification factor	$\mu_{g_2g_1}$	26	-
Internal resistance	R_i	600	k Ω

HEATING : Indirect by A. C. or D. C. ; series or parallel supply

Heater voltage V_f 6.3 V

Heater current I_f 300 mA

DIMENSIONS AND CONNECTIONS

Dimensions in mm

Base: Noval

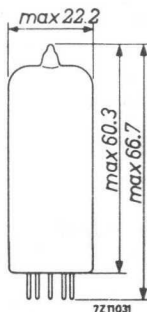
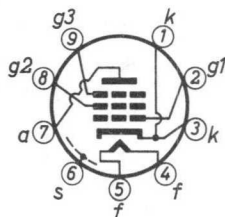

CAPACITANCES

Anode to all except grid No. 1	$C_a(g_1)$	3.2	pF
Grid No. 1 to all except anode	$C_{g_1(a)}$	6.9	pF
Anode to grid No. 1	C_{ag_1}	max. 0.007	pF
Grid No. 1 to heater	C_{g_1f}	max. 0.15	pF

TYPICAL CHARACTERISTICS AND OPERATING CHARACTERISTICS

Anode and supply voltage	$V_a = V_b$	250	V
Grid No.3 voltage	V_{g3}	0	V
Grid No.2 resistor	R_{g2}	60	k Ω
Grid No.1 voltage	V_{g1}	-2	-35 V
Grid No.2 voltage	V_{g2}	100	- V
Anode current	I_a	10	- mA
Grid No.2 current	I_{g2}	2.5	- mA
Transconductance	S	6.0	0.06 mA/V
Internal resistance	R_i	0.6	>5 M Ω
Amplification factor	μ_{g2g1}	26	-
Equivalent noise resistance	R_{eq}	1.4	- k Ω
Grid No.1 input resistance, f = 50 MHz	r_{g1}	9	- k Ω

LIMITING VALUES (Design centre rating system)

Anode voltage	V_{a0}	max.	550 V
	V_a	max.	250 V
Anode dissipation	W_a	max.	2.5 W
	V_{g20}	max.	550 V
Grid No.2 voltage	V_{g2}	max.	250 V
	W_{g2}	max.	0.65 W
Grid No.2 dissipation	R_{g1}	max.	3 M Ω
Grid No.1 resistor	I_k	max.	15 mA
Cathode current	V_{kf}	max.	150 V
Heater to cathode voltage			

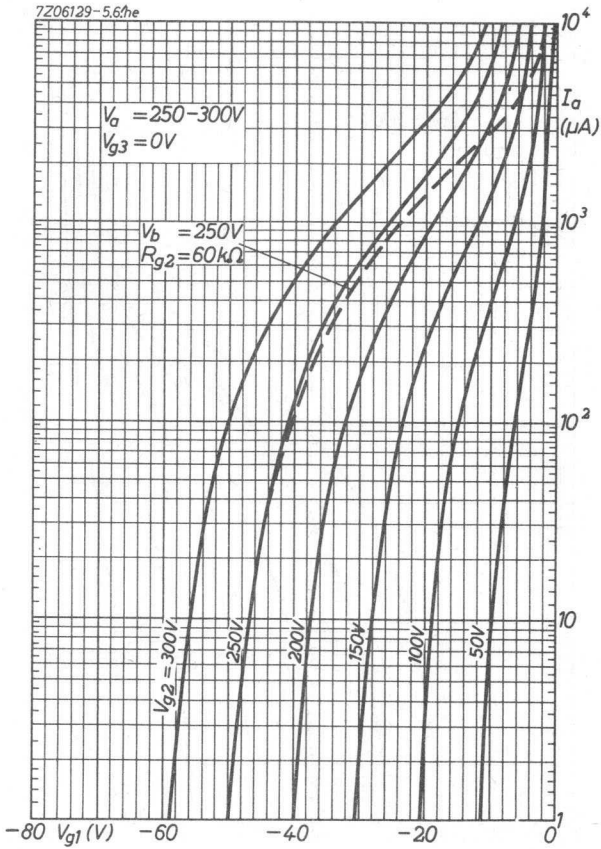

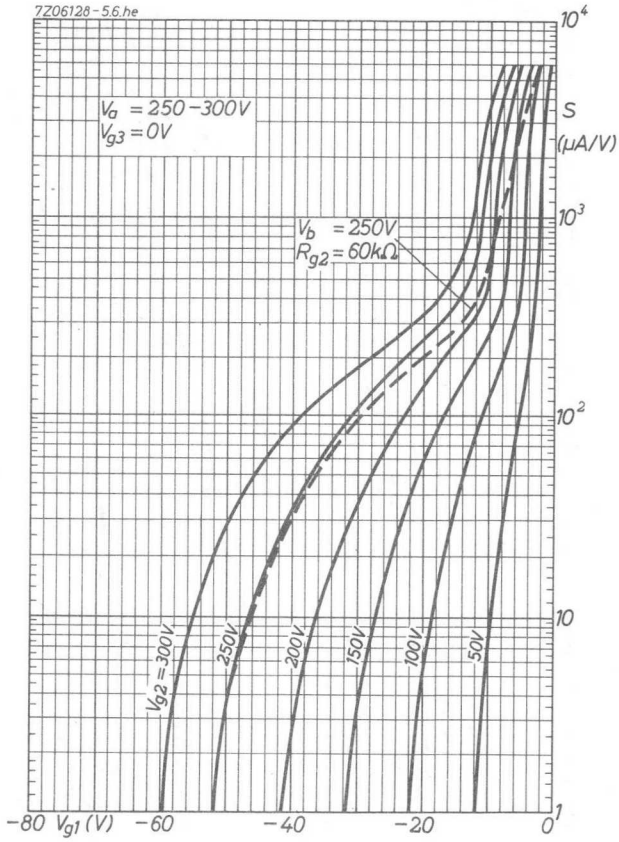

A.F. PENTODE

Pentode intended for use as A.F. amplifier

QUICK REFERENCE DATA			
Anode current	I_a	3.0	mA
Transconductance	S	2.2	mA/V
Amplification factor	$\mu_{g_2g_1}$	38	-
Internal resistance	R_i	2.5	MΩ

HEATING: Indirect by A.C. or D.C.; series or parallel supply

Heater voltage	V_f	6.3	V
Heater current	I_f	200	mA

DIMENSIONS AND CONNECTIONS

Dimensions in mm

Base: Noval

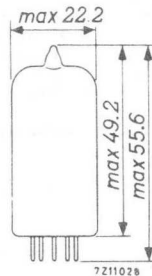
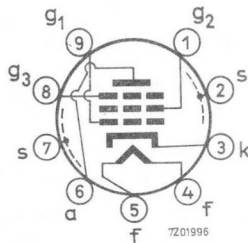

CAPACITANCES

Grid No.1 to all except anode	$C_{g_1(a)}$	3.8	pF
Anode to all except grid No.1	$C_{a(g_1)}$	5.1	pF
Anode to grid No.1	C_{ag_1}	max. 0.05	pF
Grid No.1 to heater	C_{g_1f}	max. 0.0025	pF

TYPICAL CHARACTERISTICS

Anode voltage	V_a	250 V
Grid No.3 voltage	V_{g3}	0 V
Grid No.2 voltage	V_{g2}	140 V
Grid No.1 voltage	V_{g1}	-2.2 V
Anode current	I_a	3.0 mA
Grid No.2 current	I_{g2}	0.6 mA
Transconductance	S	2.2 mA/V
Amplification factor	μ_{g2g1}	38 -
Internal resistance	R_i	2.5 M Ω

OPERATING CHARACTERISTICS as A.F. amplifier

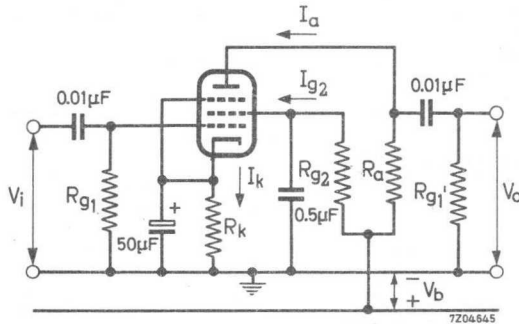

Supply voltage	V_b	400	350	300	250	200	150	V
Anode resistor	R_a	100	100	100	100	100	100	k Ω
Grid No.2 resistor	R_{g2}	390	390	390	390	390	390	k Ω
Cathode resistor	R_k	1000	1000	1000	1000	1000	1000	Ω
Grid resistor next stage	R_{g1}'	330	330	330	330	330	330	k Ω
Cathode current	I_k	3.2	2.75	2.4	2.0	1.55	1.05	mA
Voltage gain 1)	V_o/V_i	140	134	129	123	117	110	-
Output voltage	V_o	85	74	62	50	38	27	V_{RMS}
Total distortion	d_{tot}	5	5	5	5	5	5	%

1) Measured at small input voltages

OPERATING CHARACTERISTICS (continued)

Supply voltage	V_b	400	350	300	250	200	150	V
Anode resistor	R_a	220	220	220	220	220	220	$k\Omega$
Grid No.2 resistor	R_{g_2}	1	1	1	1	1	1	$M\Omega$
Cathode resistor	R_k	2200	2200	2200	2200	2200	2200	Ω
Grid resistor next stage	R_{g_1}'	680	680	680	680	680	680	$k\Omega$
Cathode current	I_k	1.45	1.3	1.1	0.9	0.75	0.5	mA
Voltage gain 1)	V_o/V_i	210	205	194	185	173	147	-
Output voltage	V_o	72	62	53	44	35	22	V_{RMS}
Total distortion	d_{tot}	5	5	5	5	5	5	%

As triode connected A.F. amplifier (g_2 connected to anode, g_3 to cathode)

Supply voltage	V_b	400	350	300	250	200	V
Anode resistor	R_a	47	47	47	47	47	$k\Omega$
Cathode resistor	R_k	1200	1200	1200	1200	1200	Ω
Grid resistor next stage	R_{g_1}'	150	150	150	150	150	$k\Omega$
Anode current	I_a	3.6	3.15	2.7	2.25	1.8	mA
Voltage gain	V_o/V_i	26	25	25	25	24	-
Output voltage ($I_g = 0.3\mu A$)	V_o	68	58	46	36	24	V_{RMS}
Total distortion	d_{tot}	5	5	5	5	5	%

Supply voltage	V_b	400	350	300	250	200	V
Anode resistor	R_a	100	100	100	100	100	$k\Omega$
Cathode resistor	R_k	2200	2200	2200	2200	2200	Ω
Grid resistor next stage	R_{g_1}'	330	330	330	330	330	$k\Omega$
Anode current	I_a	2.0	1.8	1.5	1.25	1.0	mA
Voltage gain	V_o/V_i	28	28	27.5	27.5	27	-
Output voltage ($I_g = 0.3\mu A$)	V_o	75	63	51	42	30	V_{RMS}
Total distortion	d_{tot}	5	5	5	5	5	%

Supply voltage	V_b	400	350	300	250	200	V
Anode resistor	R_a	220	220	220	220	220	$k\Omega$
Cathode resistor	R_k	3900	3900	3900	3900	3900	Ω
Grid resistor next stage	R_{g_1}'	680	680	680	680	680	$k\Omega$
Anode current	I_a	1.1	0.95	0.8	0.7	0.55	mA
Voltage gain	V_o/V_i	29	29	29	28	28	-
Output voltage ($I_g = 0.3\mu A$)	V_o	71	60	52	42	30	V_{RMS}
Total distortion	d_{tot}	5	5	5	5	5	%

OPERATING CHARACTERISTICS (continued)

Microphonic effect

A sensitivity of 0.5 mV for an output of 50 mW (or 5 mV for an output of 5 W) is permissible in those equipments where an output of 50 mW in the loudspeaker does not produce an average acceleration on the tube higher than 0.015 g at any frequency higher than 500 Hz or higher than 0.06 g at any frequency lower than 500 Hz.

Hum level

The hum disturbance level will be 3 μ V (max. 5 μ V) when Z_{g_1} is smaller than 0.5 M Ω at $f = 50$ Hz, the cathode resistor is decoupled by a capacitor of at least 100 μ F and pin 4 is earthed. With the centre tap of the heater supply earthed this value will be 1 μ V (max. 2 μ V).

Noise voltage

The equivalent noise voltage on g_1 is approximately 2 μ V for the frequency range from 25 to 10 000 Hz at $V_b = 250$ V and $R_a = 100$ k Ω .

LIMITING VALUES (Design centre rating system)

Anode voltage	V_{a_0}	max. 550 V
	V_a	max. 300 V
Anode dissipation	W_a	max. 1.0 W
Grid No.2 voltage	$V_{g_{20}}$	max. 550 V
	V_{g_2}	max. 200 V
Grid No.2 dissipation	W_{g_2}	max. 0.2 W
Grid No.1 circuit resistor		
if $W_a < 0.2$ W	R_{g_1}	max. 10 M Ω
if $W_a > 0.2$ W	R_{g_1}	max. 3 M Ω
with grid current biasing	R_{g_1}	max. 22 M Ω
Cathode current	I_k	max. 6 mA
Cathode to heater voltage		
cathode positive	V_{kf}	max. 100 V
cathode negative	V_{kf}	max. 50 V

R.F. PENTODE

Pentode with variable transconductance intended for use as R.F. or I.F. amplifier.

QUICK REFERENCE DATA			
Anode current	I_a	9	mA
Transconductance	S	4.0	mA/V
Amplification factor	$\mu_{g_2g_1}$	21	-
Internal resistance	R_i	750	k Ω

HEATING : Indirect by A. C. or D. C. ; parallel supply

Heater voltage	V_f	6.3	V
Heater current	I_f	200	mA

DIMENSIONS AND CONNECTIONS

Dimensions in mm

Base: Noval

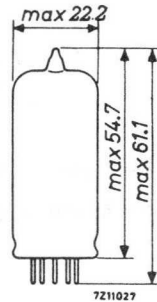
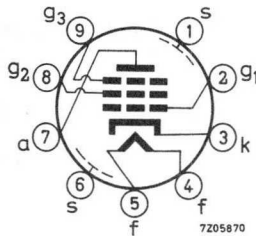

CAPACITANCES

Anode to all except grid No. 1	$C_a(g_1)$	5.1	pF
Grid No. 1 to all except anode	$C_{g_1(a)}$	5.5	pF
Anode to grid No. 1	C_{ag_1}	max. 0.002	pF
Grid No. 1 to heater	C_{g_1f}	0.05	pF

TYPICAL CHARACTERISTICS

Anode voltage	V_a	250	250	170	V
Grid No.2 voltage	V_{g2}	100	85	100	V
Grid No.3 voltage	V_{g3}	0	0	0	V
Anode current	I_a	9	9	12	mA
Grid No.1 voltage	V_{g1}	-2	-1.2 ¹⁾	-1.2 ¹⁾	V
Grid No.2 current	I_{g2}	3	3.2	4.4	mA
Transconductance	S	3.6	4.0	4.4	mA/V
Internal resistance	R_i	0.9	0.75	0.4	MΩ
Amplification factor	μ_{g2g1}	-	21	-	-

OPERATING CHARACTERISTICS

Anode voltage, supply voltage	$V_a = V_b$	250		200	V	
Grid No.3 voltage	V_{g3}	0		0	V	
Grid No.2 resistor	R_{g2}	51		24	kΩ	
Cathode resistor	R_k	160		130	Ω	
Grid No.1 voltage	V_{g1}	-1.95	-20	-1.95	-20	V
Anode current	I_a	9	-	11.1	-	mA
Grid No.2 current	I_{g2}	3	-	3.8	-	mA
Transconductance	S	3.5	0.24	3.85	0.16	mA/V
Internal resistance	R_i	0.9	-	0.55	-	MΩ
Equivalent noise resistance	R_{eq}	4.2	-	4.2	-	kΩ
Input conductance (f = 50 MHz)	g	95	-	102	-	μA/V

¹⁾ In this case control grid current may occur. If this is not permissible, the negative grid bias should be increased to a value of 1.5 V at least.

OPERATING CHARACTERISTICS (continued)

Anode voltage, supply voltage	$V_a = V_b$	250 ¹⁾	200 ¹⁾	V		
Grid No. 3 voltage	V_{g3}	0	0	V		
Grid No. 2 resistor	R_{g2}	62	33	k Ω		
Cathode resistor	R_k	0	0	Ω		
Grid No. 1 resistor	R_{g1}	10	10	M Ω		
Control voltage	$V_{R(g1)}$	0	-20	0	-20	V
Anode current	I_a	9	-	11.25	-	mA
Grid No. 2 current	I_{g2}	2.9	-	3.9	-	mA
Transconductance	S	4.7	0.22	5.15	0.15	mA/V
Internal resistance	R_i	825	-	550	-	k Ω
Equivalent noise resistance	R_{eq}	2.4	-	2.5	-	k Ω

LIMITING VALUES (Design centre rating system)

Anode voltage	V_{a0}	max.	550	V
	V_a	max.	300	V
Anode dissipation	W_a	max.	2.25	W
Grid No. 2 voltage	V_{g20}	max.	550	V
	V_{g2}	max.	300	V
Grid No. 2 dissipation	W_{g2}	max.	0.45	W
Cathode current	I_k	max.	16.5	mA
Grid No. 1 resistor	R_{g1}	max.	3	M Ω
Grid No. 3 resistor	R_{g3}	max.	10	k Ω
Cathode to heater voltage	V_{kf}	max.	100	V

¹⁾ In this case control grid current may occur. If this is not permissible, the negative grid bias should be increased to a value of 1.5 V at least.

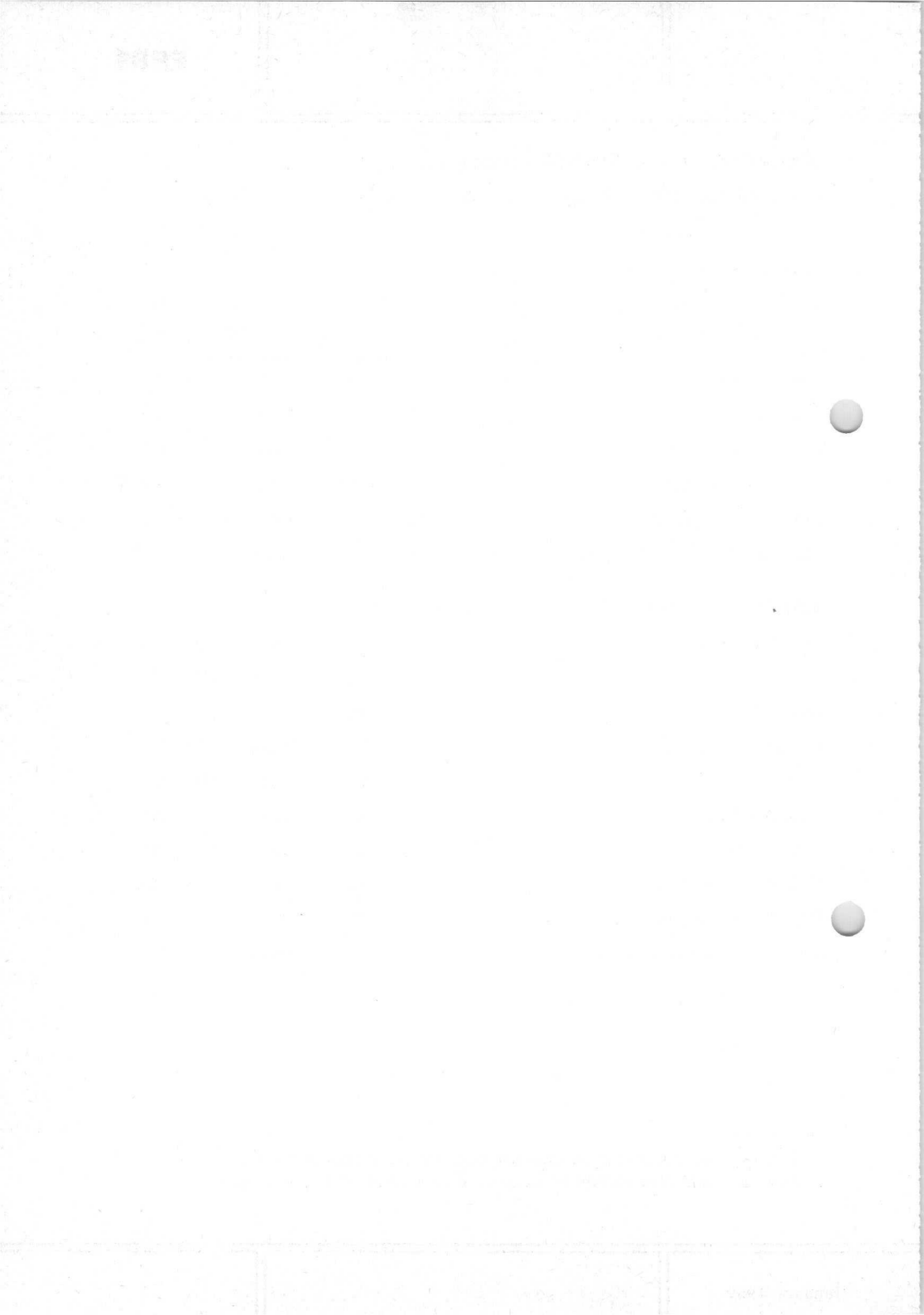

I.F. PENTODE

Pentode with variable transconductance intended for use as I.F. amplifier in television receivers.

QUICK REFERENCE DATA			
Anode current	I_a	12	mA
Transconductance	S	12.5	mA/V
Internal resistance	R_i	500	$k\Omega$

HEATING: Indirect by A.C. or D.C.; parallel or series supply

Heater voltage	V_f	6.3	V
Heater current	I_f	300	mA

DIMENSIONS AND CONNECTIONS

Dimensions in mm

Base: Noval

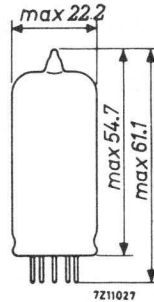
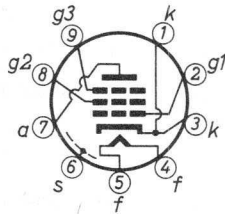

CAPACITANCES

Anode to all except grid No. 1
 Grid No. 1 to all except anode
 Anode to grid No. 1
 Grid No. 1 to grid No. 2

$C_a(g_1)$	3	pF
$C_{g_1(a)}$	9.5	pF
C_{ag_1}	max. 0.005	pF
$C_{g_1g_2}$	2.8	pF

TYPICAL CHARACTERISTICS

Anode voltage	V_a	200 V
Grid No.3 voltage	V_{g3}	0 V
Grid No.2 voltage	V_{g2}	90 V
Grid No.1 voltage	V_{g1}	-2 V
Anode current	I_a	12 mA
Grid No.2 current	I_{g2}	4.5 mA
Transconductance	S	12.5 mA/V
Internal resistance	R_i	500 k Ω
Input resistance grid No.1 (f = 40 MHz)	r_{g1}	13 k Ω
Equivalent noise resistance (f = 40 MHz)	R_{eq}	490 Ω

OPERATING CHARACTERISTICS

Anode voltage	V_a	170	200	230	V			
Grid No.3 voltage	V_{g3}	0	0	0	V			
Grid No.2 supply voltage	V_{bg2}	170	200	230	V			
Grid No.2 resistor	R_{g2}	15	24	39	k Ω			
Grid No.1 voltage	V_{g1}	-1.8	-7.5	-2.0	-9.5	-2.1	-12	V
Anode current	I_a	14	2.7	12	2.7	10.5	2.4	mA
Transconductance	S	14	0.7	12.5	0.62	10.6	0.5	mA/V

REMARK

Operation with cathode bias resistor and/or screen grid resistor is recommended.

LIMITING VALUES (Design centre rating system)

Anode voltage	V_{a0}	max.	550 V
	V_a	max.	250 V
Anode dissipation	W_a	max.	2.5 W
Grid No.2 voltage	V_{g20}	max.	550 V
	V_{g2}	max.	250 V
Grid No.2 dissipation	W_{g2}	max.	0.65 W
Grid No.1 voltage, negative peak	$-V_{g1p}$	max.	50 V
Cathode current	I_k	max.	20 mA
Cathode to heater voltage	V_{kf}	max.	150 V
Grid No.3 resistor	R_{g3}	max.	50 k Ω
Grid No.1 resistor	R_{g1}	max.	1 M Ω

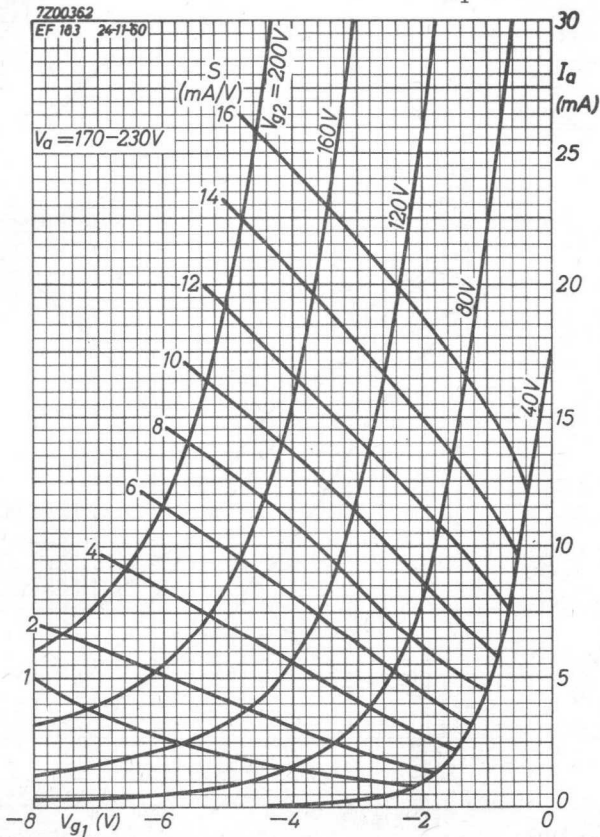

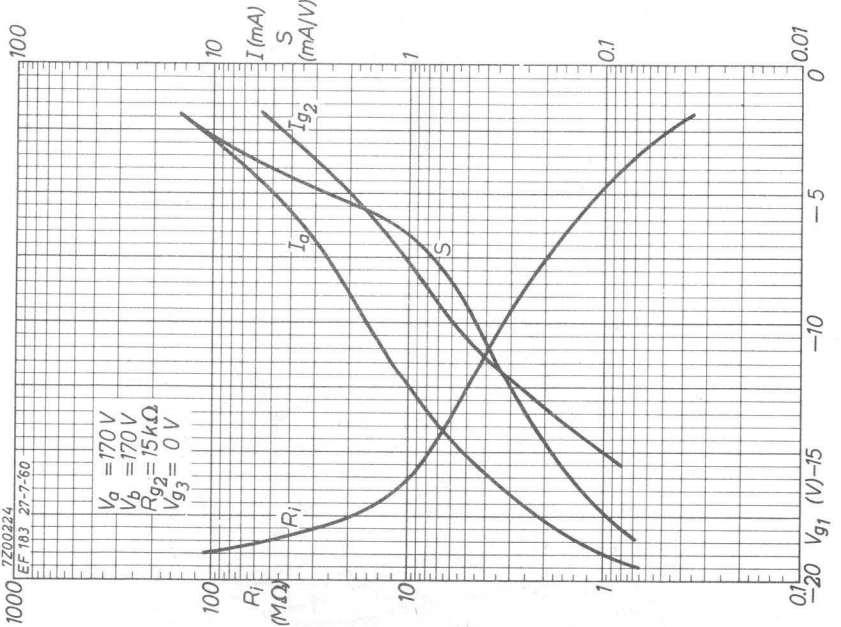
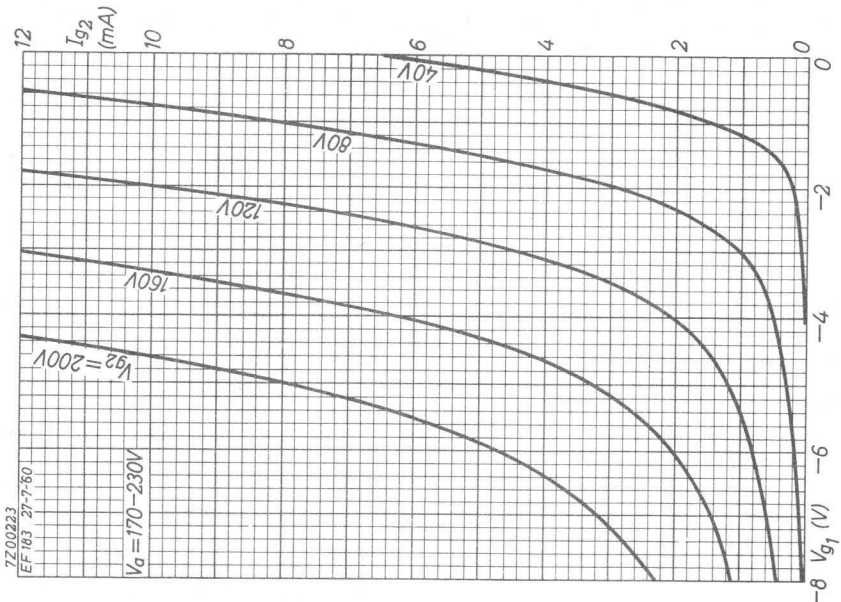

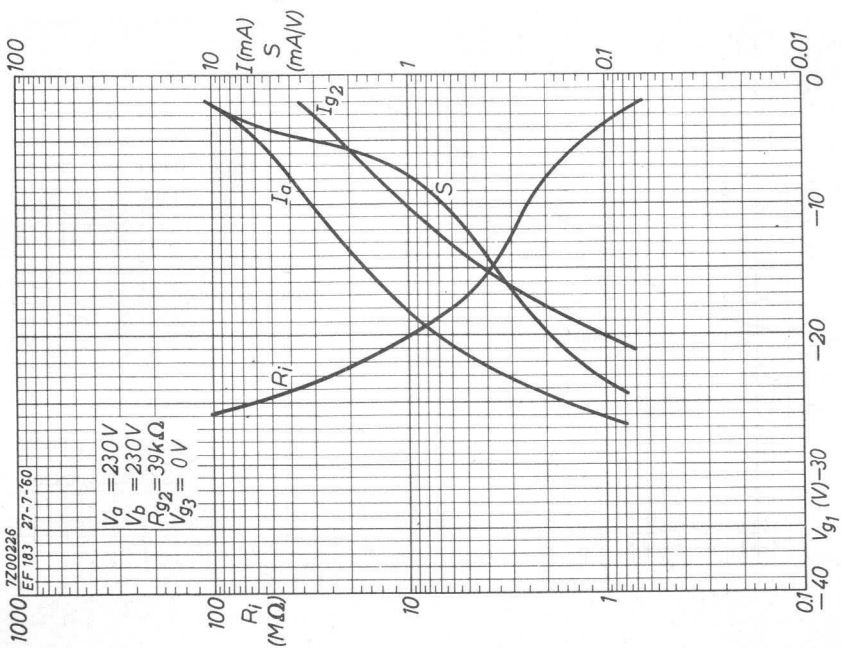
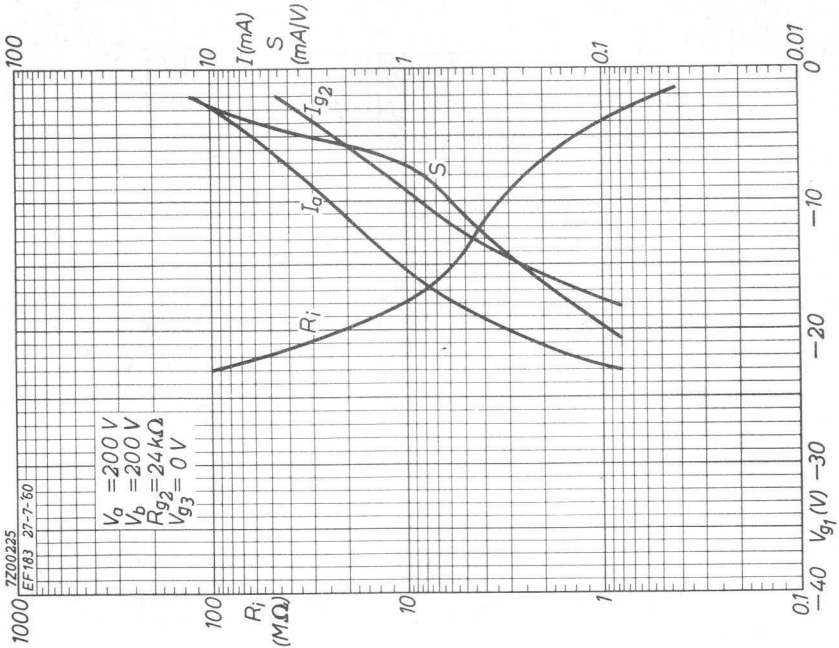

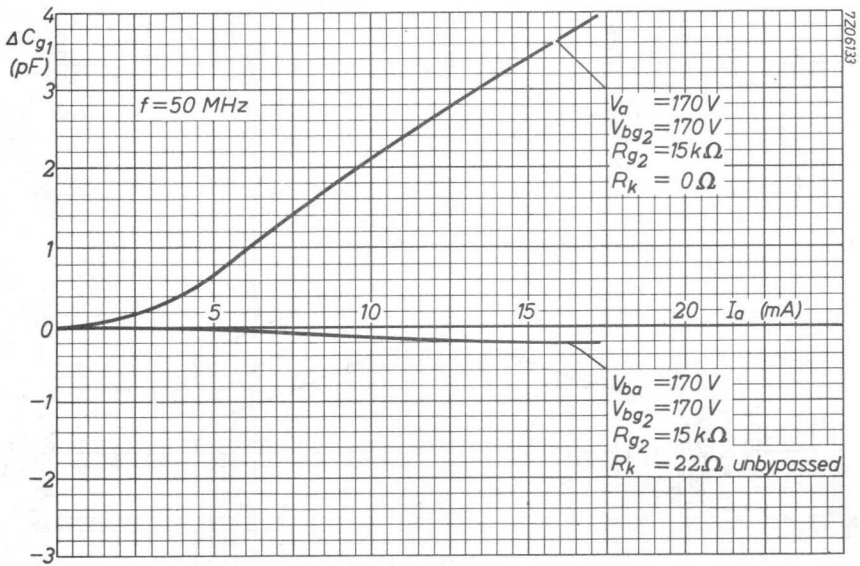
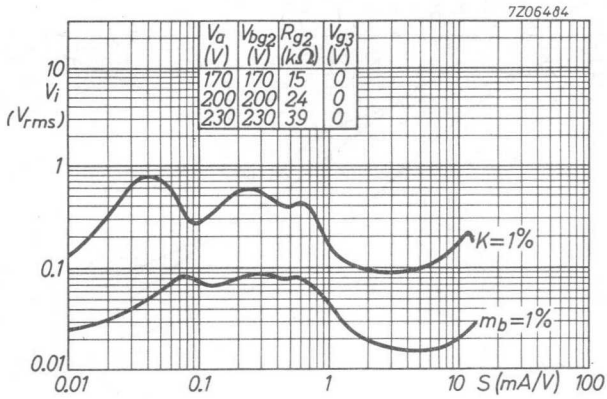

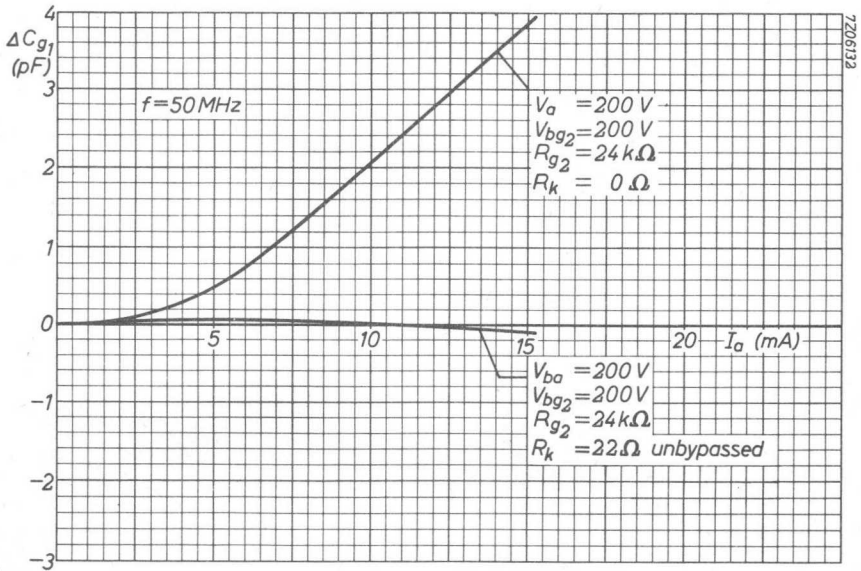

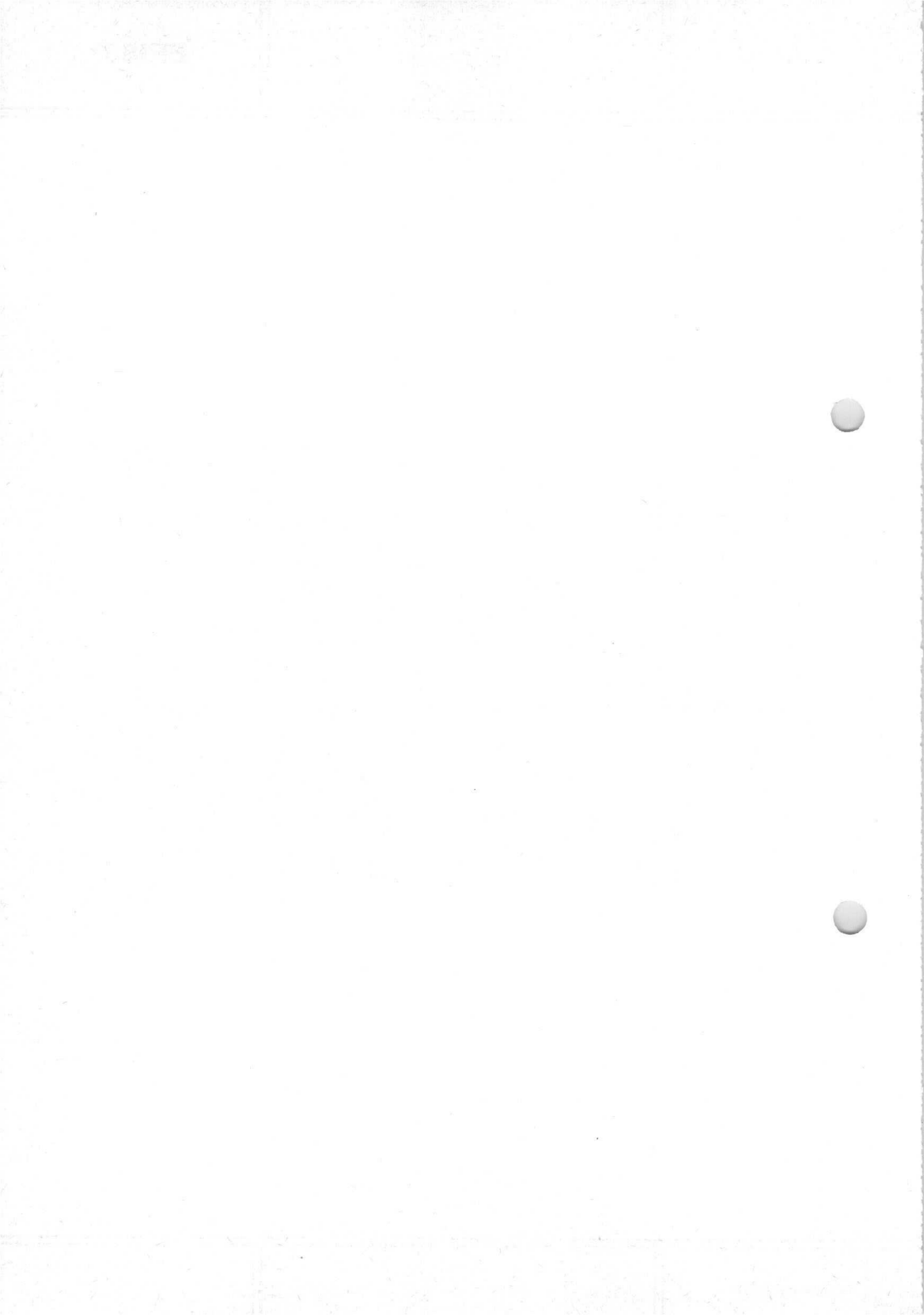

I.F. PENTODE

Pentode intended for use as I.F. amplifier in television receivers.

QUICK REFERENCE DATA		
Anode current	I_a	10 mA
Transconductance	S	15 mA/V
Amplification factor	$\mu_{g_2g_1}$	60 -
Internal resistance	R_i	380 k Ω

HEATING: Indirect by A.C. or D.C.; parallel or series supply

Heater voltage	V_f	6.3 V
Heater current	I_f	300 mA

DIMENSIONS AND CONNECTIONS

Dimensions in mm

Base: Noval

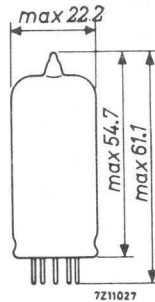
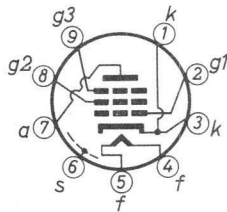

CAPACITANCES

Anode to all except grid No.1	$C_{a(g_1)}$	3 pF
Grid No.1 to all except anode	$C_{g_1(a)}$	10 pF
Anode to grid No.1	C_{ag_1}	max. 0.0055 pF
Grid No.1 to grid No.2	$C_{g_1g_2}$	2.8 pF

TYPICAL CHARACTERISTICS

Anode voltage	V_a	200	V
Grid No.3 voltage	V_{g3}	0	V
Grid No.2 voltage	V_{g2}	200	V
Grid No.1 voltage	V_{g1}	-2.5	V
Anode current	I_a	10	mA
Grid No.2 current	I_{g2}	4.1	mA
Transconductance	S	15	mA/V
Internal resistance	R_i	380	k Ω
Amplification factor	μ_{g2g1}	60	-
Input resistance grid No.1 (f = 40 MHz)	r_{g1}	11	k Ω
Equivalent noise resistance (f = 40 MHz)	R_{eq}	330	Ω

OPERATING CHARACTERISTICS

Anode supply coltage	V_{ba}	170	200	230	V
Grid No.3 voltage	V_{g3}	0	0	0	V
Grid No.2 supply voltage	V_{bg2}	170	200	230	V
Grid No.2 resistor	R_{g2}	0	7.5	15	k Ω
Cathode resistor	R_k	140	140	140	Ω
Anode current	I_a	10	10	10	mA
Grid No.2 current	I_{g2}	4.1	4.1	4.1	mA
Transconductance	S	15.6	15.6	15.6	mA/V
Internal resistance	R_i	330	510	680	k Ω
Input resistance grid No.1 f = 40 MHz	r_{g1}	10	10	10	k Ω
Equivalent noise resistance f = 40 MHz	R_{eq}	300	300	300	Ω

REMARKS

1. Operation with cathode bias resistor is recommended.
2. In order to ensure a good performance with respect to cross-modulation and microphony this tube should not be used in circuits with automatic gain control. For such applications a tube with variable transconductance is recommended.

LIMITING VALUES (Design centre rating system)

Anode voltage	V_{a0}	max. 550 V
	V_a	max. 250 V
Anode dissipation	W_a	max. 2.5 W
Grid No.2 voltage	V_{g20}	max. 550 V
	V_{g2}	max. 250 V
Grid No.2 dissipation	W_{g2}	max. 0.9 W ¹⁾
Grid No.1 voltage, negative peak	$-V_{g1p}$	max. 50 V
Cathode current	I_k	max. 25 mA
Cathode to heater voltage	V_{kf}	max. 150 V
Grid No.1 resistor	R_{g1}	max. 1 M Ω

¹⁾ During a heating-up period not exceeding 15 seconds this value may be max. 1.5 W. At the values of R_{g2} specified under "Operating characteristics" there will be no risk of exceeding the maximum permissible value of W_{g2} .

7Z00363
EF 184 24-11-60

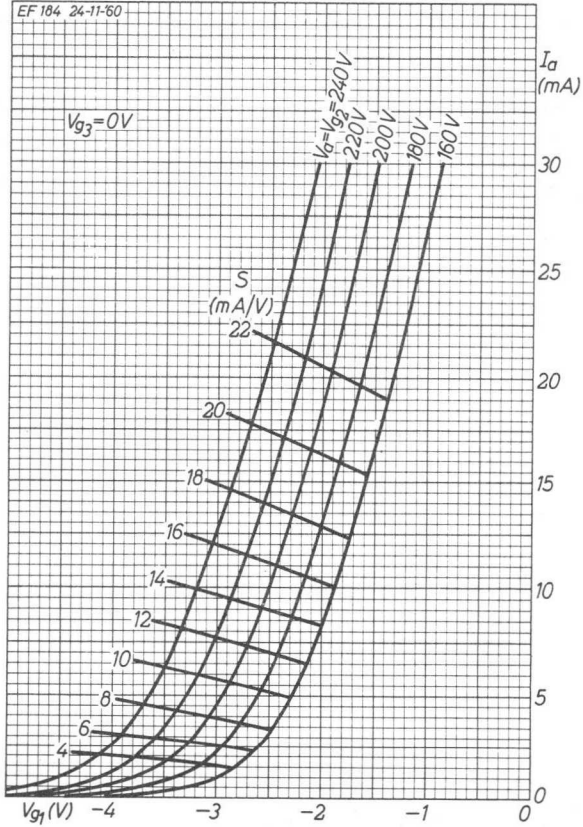

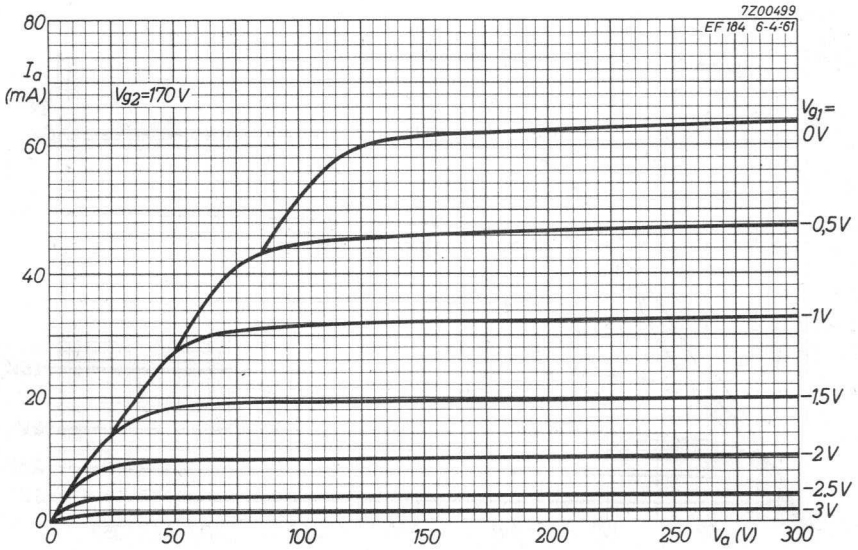
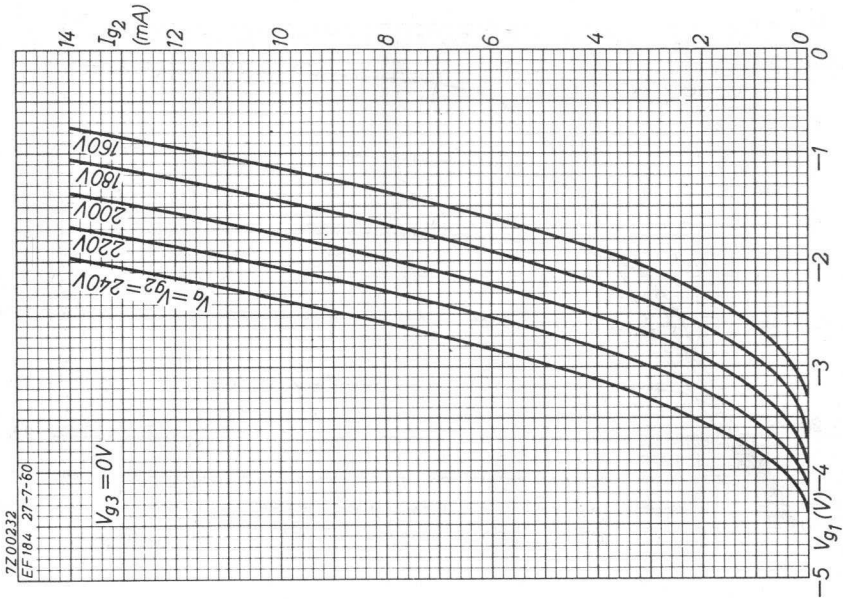

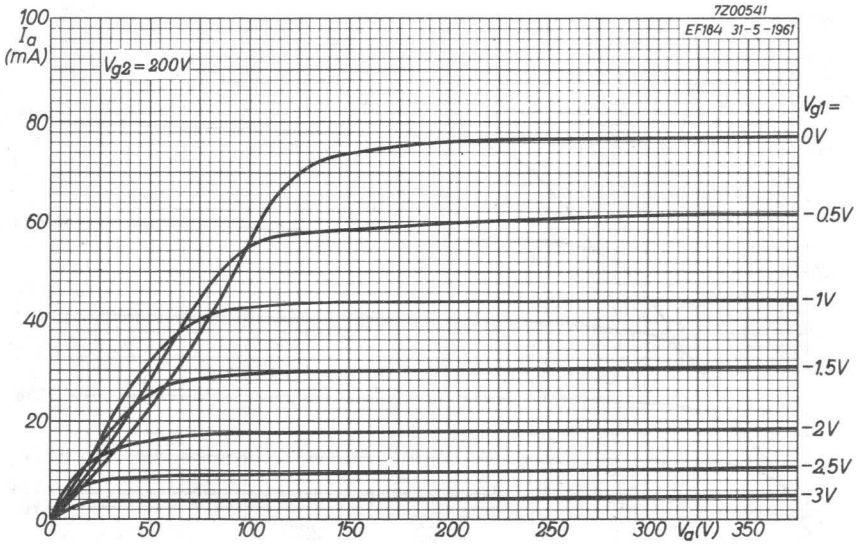
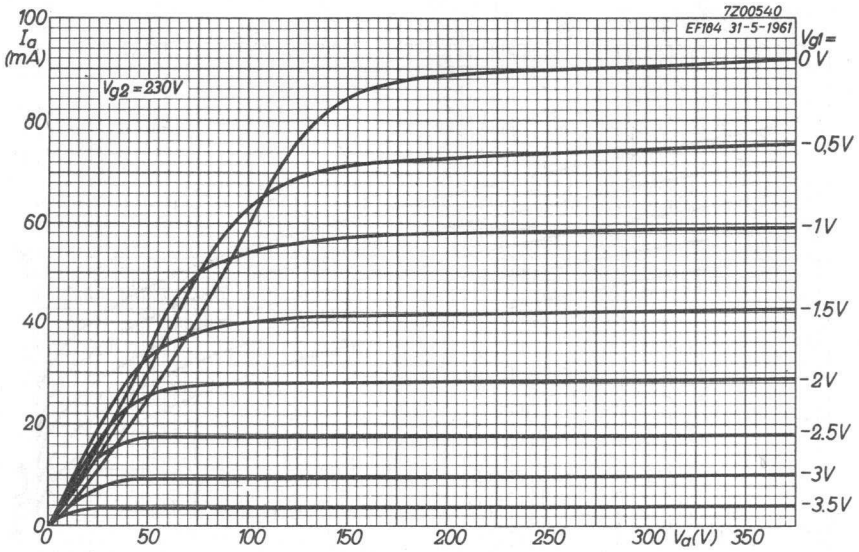

DOUBLE PENTODE

Double pentode intended for use as video output tube and as sync separator, A.G.C. amplifier or I.F. sound amplifier.

HEATING: Indirect by A.C. or D.C.; parallel supply

Heater voltage

V_f 6.3 V

Heater current

I_f 810 mA

For further data and curves of this type
please refer to type PFL200

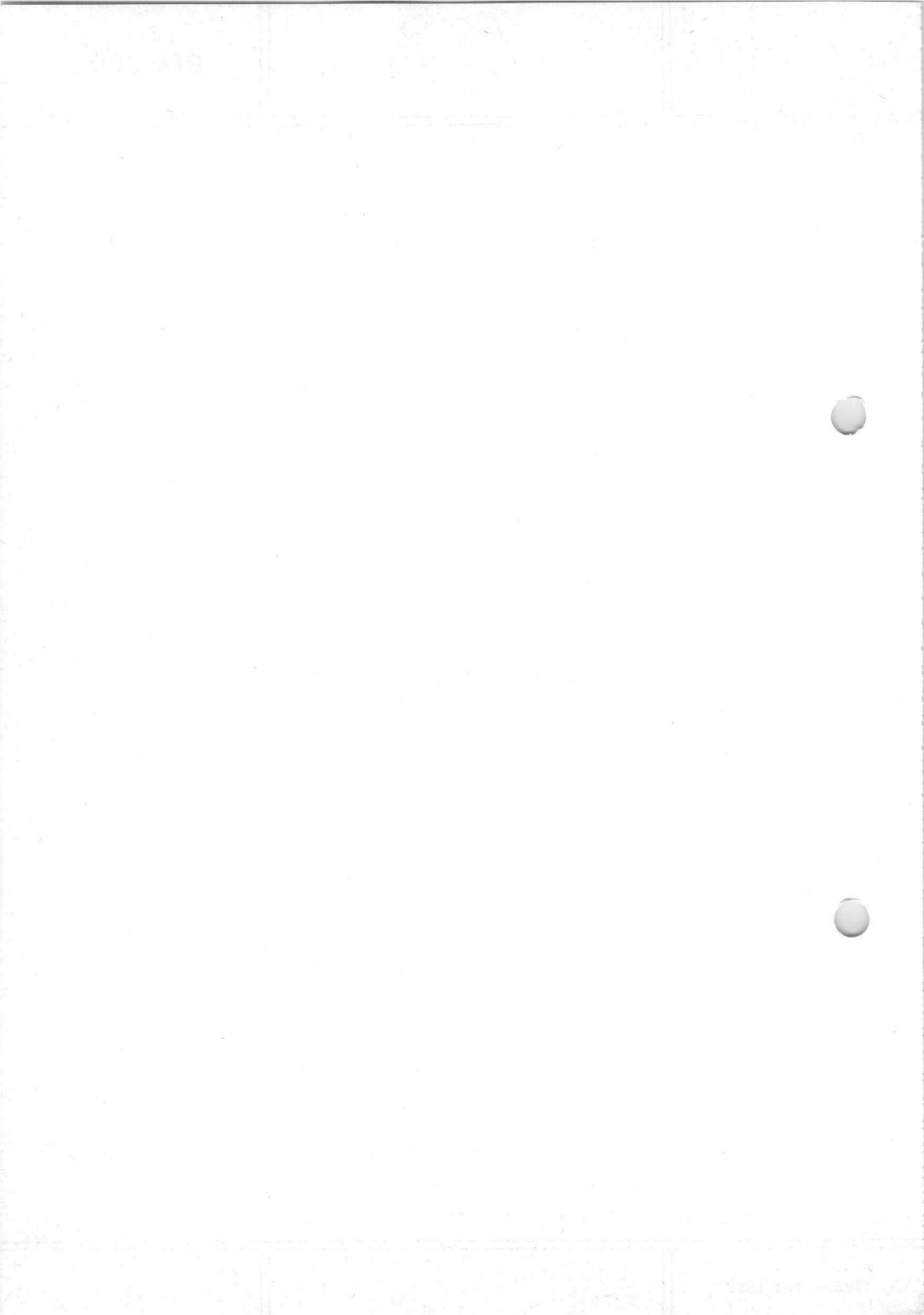

A.F. OUTPUT PENTODE

Pentode intended for use as A.F. power amplifier.

QUICK REFERENCE DATA

Anode current	I_a	100 mA
Transconductance	S	12.5 mA/V
Amplification factor	$\mu_{g_2g_1}$	11
Output power, class B		100 W

HEATING: Indirect by A.C. or D.C.; parallel supply

Heater voltage	V_f	6.3 V
Heater current	I_f	1.5 A

DIMENSIONS AND CONNECTIONS

Dimensions in mm

Base: Octal

Socket: 5903/13

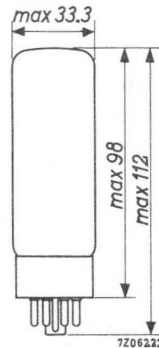
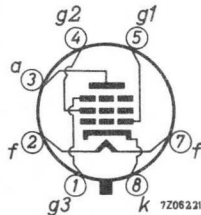

CAPACITANCES

Anode to all except grid No.1	$C_{a(g_1)}$	8.4	pF
Grid No.1 to all except anode	$C_{g_1(a)}$	15.2	pF
Anode to grid No.1	C_{ag_1}	max. 1.1	pF
Grid No.1 to heater	C_{g_1f}	max. 1.0	pF
Cathode to heater	C_{kf}	10	pF

OPERATING CHARACTERISTICS

Class A

Supply voltage	V_b	265	265	V
Anode voltage	V_a	250	250	V
Grid No.2 series resistor	R_{g_2}	2	0	k Ω
Grid No.3 voltage	V_{g_3}	0	0	V
Grid No.1 voltage	V_{g_1}	-14.5	-13.5	V
Anode current	I_a	70	100	mA
Grid No.2 current	I_{g_2}	10	14.9	mA
Transconductance	S	11	12.5	mA/V
Amplification factor	$\mu_{g_2g_1}$	11	11	
Internal resistance	R_i	20	17	k Ω
Load resistance	$R_{a\sim}$	3.0	2.0	k Ω
Grid No.1 driving voltage	V_i	9.3	8.7	V _{RMS}
Output power	W_o	8	11	W
Distortion	d_{tot}	10	10	%
Grid No.1 driving voltage for $W_o = 50$ mW	V_i	0.65	0.5	V _{RMS}

OPERATING CHARACTERISTICS

Class B, two tubes in push-pull

Common grid No.2 series resistor (non decoupled)	R_{g2}	1000			470			Ω
Grid No.1 voltage	V_{g1}	-38			-32			V
Grid No.3 voltage	V_{g3}	0			0			V
Grid No.1 driving voltage	V_i	0 27 27			0 22.7 22.7			V_{RMS}
Load resistance	$R_{aa\sim}$	-	3.4	4.0	-	2.8	3.8	$k\Omega$
Supply voltage	V_b	425	425	400	375	375	350	V
Anode voltage	V_a	420	400	375	370	350	325	V
Anode current	I_a	2x30	2x120	2x100	2x35	2x120	2x93	mA
Grid No.2 current	I_{g2}	2x4.4	2x25	2x25	2x4.7	2x25	2x25	mA
Output power	W_o	0	55	45	0	44	36	W
Distortion	d_{tot}	-	5	6	-	5	6	%

Common grid No.2 series resistor (non decoupled)	R_{g2}	750			750			Ω
Grid No.1 voltage	V_{g1}	-36			-39			V
Grid No.3 voltage	V_{g3}	0			0			V
Grid No.1 driving voltage	V_i	0 25.8 25.8			0 23.4 23.4			V_{RMS}
Load resistance	$R_{aa\sim}$	-	4	5	-	11	11	$k\Omega$
Anode supply voltage	V_{ba}	500	500	475	800	800	750	V
Anode voltage	V_a	495	475	450	795	775	725	V
Grid No.2 supply voltage	V_{bg2}	400	400	375	400	400	375	V
Anode current	I_a	2x30	2x125	2x102	2x25	2x91	2x84	mA
Grid No.2 current	I_{g2}	2x4	2x25	2x25	2x3	2x19	2x19	mA
Output power	W_o	0	70	58	0	100	90	W
Distortion	d_{tot}	-	5	6	-	5	6	%

OPERATING CHARACTERISTICS

Class AB, two tubes in push-pull

Load resistance	$R_{aa\sim}$	3.4	$k\Omega$
Common grid No.2 series resistor (non decoupled)	R_{g2}	470	Ω
Common cathode resistor	R_k	130	Ω
Grid No.3 voltage	V_{g3}	0 V	
Grid No.1 driving voltage	V_i	0	21 V_{RMS}
Supply voltage	V_b	375	375 V
Anode to earth voltage	$V_a + V_{Rk}$	355	350 V
Anode current	I_a	2x75	2x95 mA
Grid No.2 current	I_{g2}	2x11.5	2x22.5 mA
Output power	W_o	0	35 W
Distortion	d_{tot}	-	5 %

LIMITING VALUES (Design centre rating system)

Anode voltage	V_{a0}	max.	2000 V
	V_a	max.	800 V
Grid No.2 voltage	V_{g20}	max.	800 V
	V_{g2}	max.	500 V
Anode dissipation			
	at $V_i = 0$	W_a	max. 25 W
	at $V_i > 0$	W_a	max. 27.5 W
Grid No.2 dissipation	W_{g2}	max.	8 W
Cathode current	I_k	max.	150 mA
Grid No.1 resistor			
	for class A and AB	R_{g1}	max. 0.7 $M\Omega$
	for class B	R_{g1}	max. 0.5 $M\Omega$
Cathode to heater voltage	V_{kf}	max.	100 V

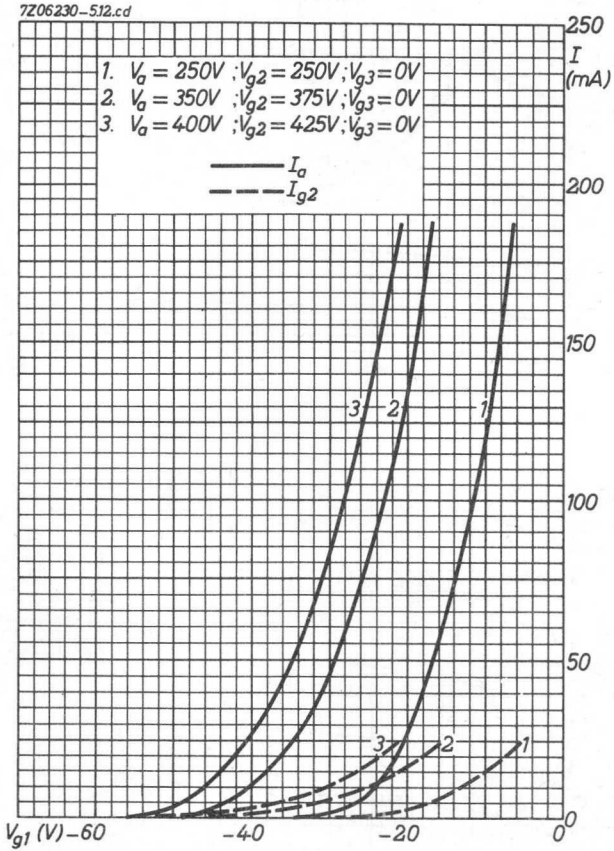

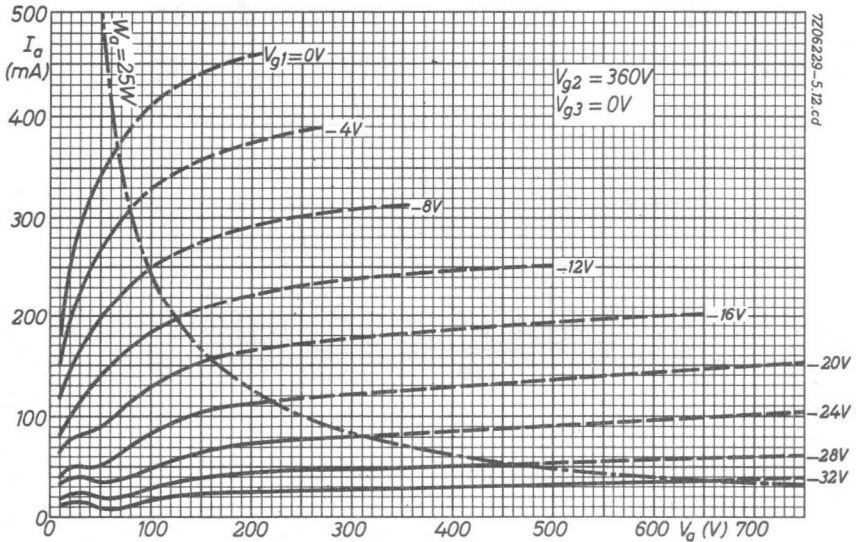
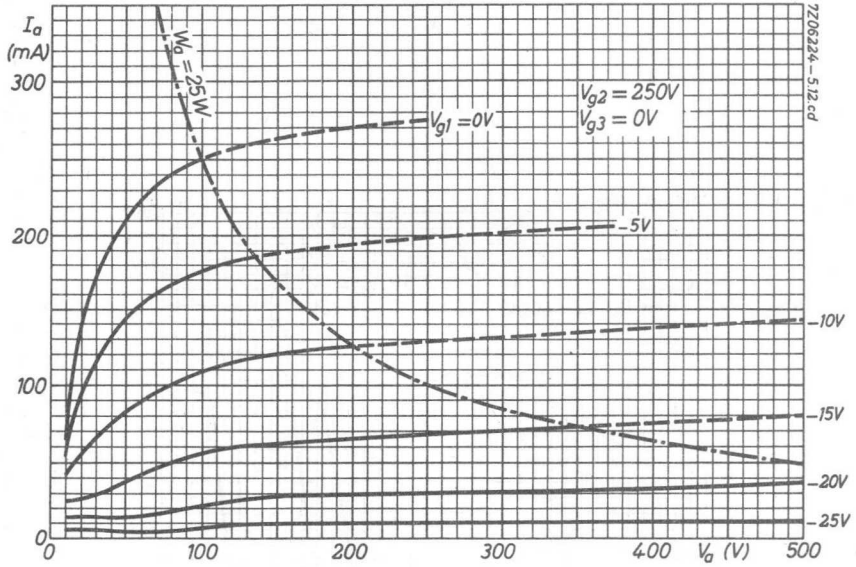

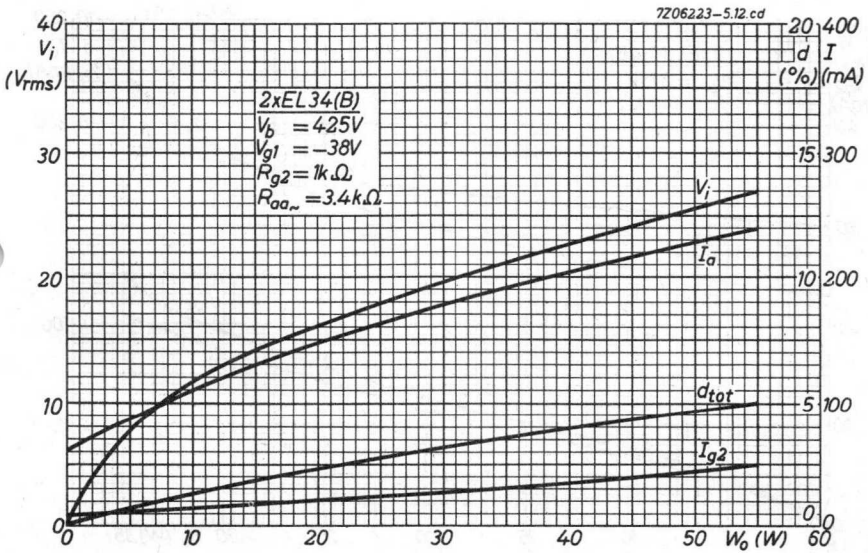
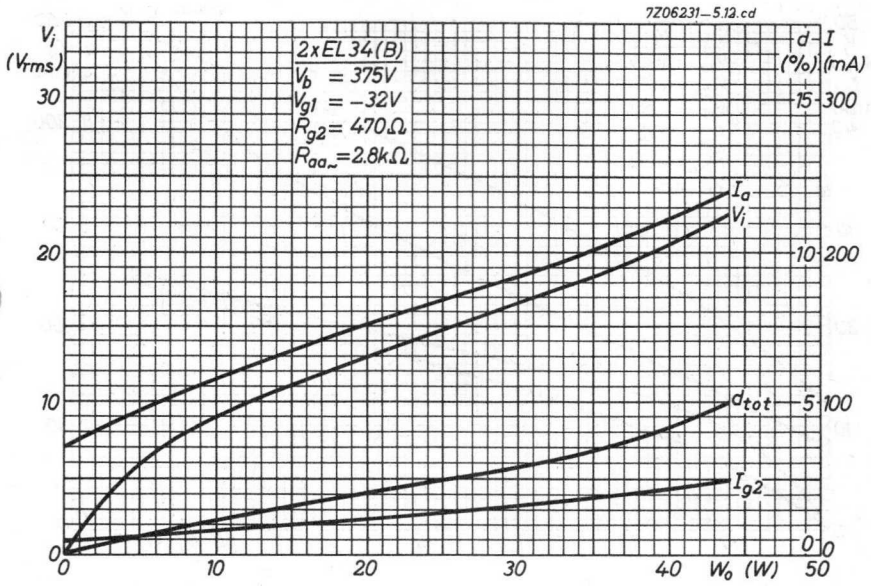

EL34

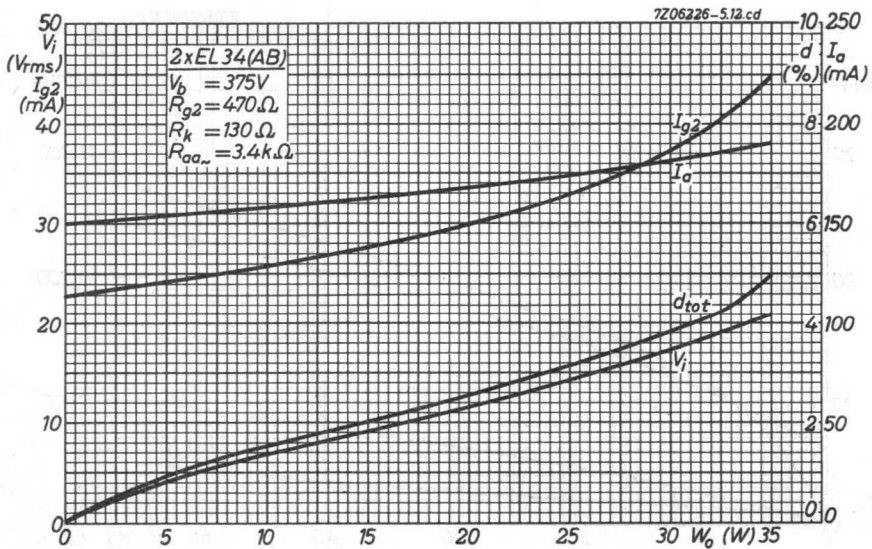
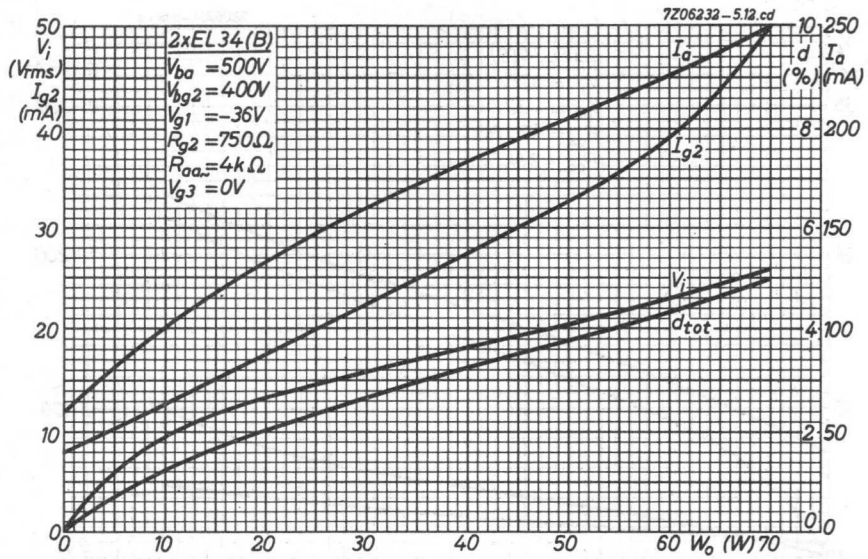

LINE AND A.F. OUTPUT PENTODE

Pentode intended for use as line output tube in television receivers and as A.F. power amplifier.

HEATING: Indirectly by A.C. or D.C.; parallel supply

Heater voltage	V_f	6.3	V
Heater current	I_f	1.25	A

OPERATING CHARACTERISTICS

A.F. amplifier. Class B, two tubes in push pull

Anode voltage	V_a	300	V
Grid No.2 voltage	V_{g2}	150	V
Grid No.1 voltage	V_{g1}	-29	V
Load resistance	$R_{aa\sim}$	3.5	$k\Omega$
Grid No.1 driving voltage	V_i	0	20 V _{RMS}
Anode current	I_a	2x18	2x100 mA
Grid No.2 current	I_{g2}	2x0.5	2x19 mA
Output power	W_o	0	44.5 W
Distortion	d_{tot}	-	7.2 %

LIMITING VALUES (Design centre rating system)

Anode voltage	V_a	max. 250	V
Anode voltage for class B operation	V_a	max. 300	V
Cathode to heater voltage	V_{kf}	max. 100	V

 For further data and curves of this type
 please refer to PL36

UNITED STATES DEPARTMENT OF JUSTICE

MEMORANDUM FOR THE ATTORNEY GENERAL

DATE: [Illegible]

RE: [Illegible]

BY: [Illegible]

TITLE: [Illegible]

SUBJECT: [Illegible]

REFERENCE: [Illegible]

DATE: [Illegible]

BY: [Illegible]

TITLE: [Illegible]

SUBJECT: [Illegible]

REFERENCE: [Illegible]

DATE: [Illegible]

BY: [Illegible]

OUTPUT PENTODE FOR LINE DEFLECTION AND A.F. OUTPUT PENTODE

Output pentode intended for use as horizontal deflection amplifier in small screen television receivers and as A. F. power amplifier.

QUICK REFERENCE DATA

Anode peak voltage	V_{ap}	max.	7	kV
Cathode current	I_k	max.	180	mA
Output power, class B two tubes	W_o		20	W

HEATING : Indirect by A. C. or D. C. ; parallel supply

Heater voltage	V_f	6.3	V
Heater current	I_f	1.05	A

DIMENSIONS AND CONNECTIONS

Dimensions in mm

Base: Noval

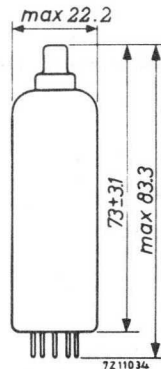
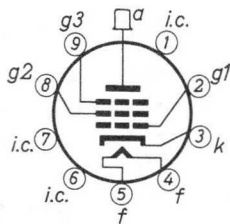

CAPACITANCES

Anode to all except grid No. 1	$C_{a(g_1)}$	6	pF
Grid No. 1 to all except anode	$C_{g_1(a)}$	14	pF
Anode to grid No. 1	C_{ag_1}	max. 0.8	pF
Anode to cathode	C_{ak}	max. 0.1	pF
Grid No. 1 to heater	C_{g_1f}	max. 0.2	pF

TYPICAL CHARACTERISTICS

A)

Anode voltage	V_a	170	V
Grid No. 3 voltage	V_{g_3}	0	V
Grid No. 2 voltage	V_{g_2}	170	V
Grid No. 1 voltage	V_{g_1}	-24	V
Anode current	I_a	45	mA
Grid No. 2 current	I_{g_2}	2.4	mA
Transconductance	S	6.3	mA/V
Internal resistance	R_i	11	k Ω
Amplification factor	$\mu_{g_2g_1}$	5.0	

B) (Measured under pulse conditions)

Anode voltage	V_a	40	V
Grid No. 3 voltage	V_{g_3}	0	V
Grid No. 2 supply voltage	V_{bg_2}	190	V
Grid No. 2 series resistor	R_{g_2}	4.7	k Ω
Grid No. 1 voltage	V_{g_1}	0	V
Anode current	I_a	180	mA
Grid No. 2 current	I_{g_2}	18	mA

OPERATING CONDITIONS

Stabilized circuits (D. C. feedback)

Cut-off voltage

The minimum required cut-off voltage ($-V_{g1}$) during flyback is 120 V at $V_a = 6000$ V, $V_{g2} = 190$ V, and $Z_{g1} = 1$ k Ω at line-frequency.

Supply-voltage: See page 5

Minimum required value of the screengrid voltage and of the anode voltage, when the tube is used in a line output stage.

The graphs refer to nominal mains voltage provided the specified values of I_a at V_a min, will be available throughout life of the tube at supply voltage values 10% below nominal.

In order to prevent Barkhausen interferences and less of stabilisation, care should be taken that the anode voltage never drops below the specified V_a min. during the scanning period.

OPERATING CHARACTERISTICS as class B push-pull A. F. power amplifier,
two tubes.

Anode voltage	V_a	170	200	V
Grid No. 3 voltage	V_{g3}	0	0	V
Grid No. 2 supply voltage	V_{bg2}	170	200	V
Common Grid No. 2 series resistor	R_{g2}	1	1	k Ω
Grid No. 1 voltage	V_{g1}	-27	-31.5	V
Load resistance	$R_{aa\sim}$	2.5	2.5	k Ω
Grid No. 1 driving voltage	V_i	0 16.5	0 21.5	V_{RMS}
Anode current	I_a	2x25 2x72	2x27 2x84	mA
Grid No. 2 current	I_{g2}	2x1.5 2x10	2x2.0 2x11.0	mA
Output power	W_o	0 13.0	0 20	W
Distortion	d_{tot}	- 5.2	- 6.5	%

LIMITING VALUES (Design centre rating system)

Anode voltage	V_{a0}	max. 550	V
	V_a	max. 250	V
Anode voltage, peak	V_{ap}	max. 7	kV ¹⁾
negative peak	$-V_{ap}$	max. 7	kV ¹⁾
Anode dissipation	W_a	} See figure below	
Grid No.2 dissipation	W_{g2} ²⁾		
Anode + grid No.2 dissipation	$W_a + W_{g2}$		
Grid No.2 voltage	V_{g2o}	max. 550	V
	V_{g2}	max. 250	V
Cathode current	I_k	max. 180	mA
Cathode to heater voltage	V_{kf}	max. 100	V
Grid No.1 resistor	R_{g1}	max. 0.5	MΩ

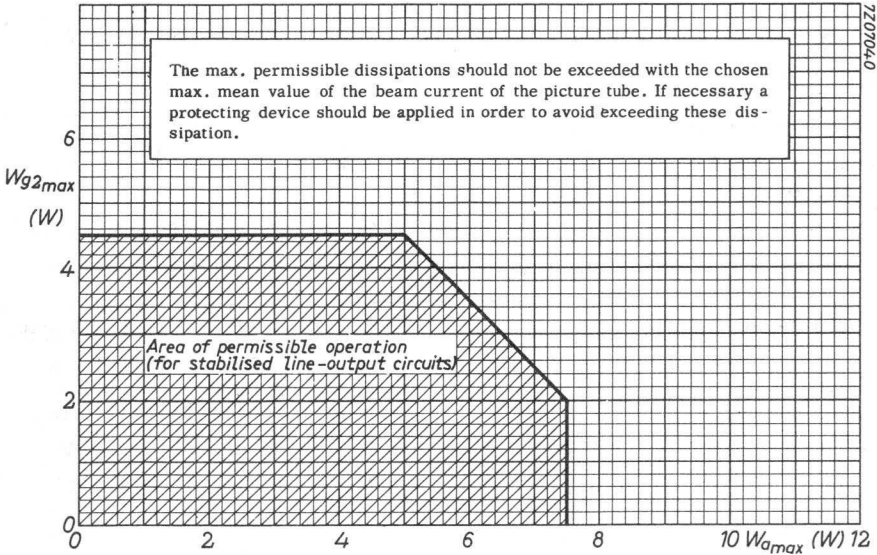

1) Maximum pulse duration 22 % of a cycle but maximum 18 μs.

2) During the heating-up of the cathode $W_{g2} = \text{max. } 6 \text{ W}$.

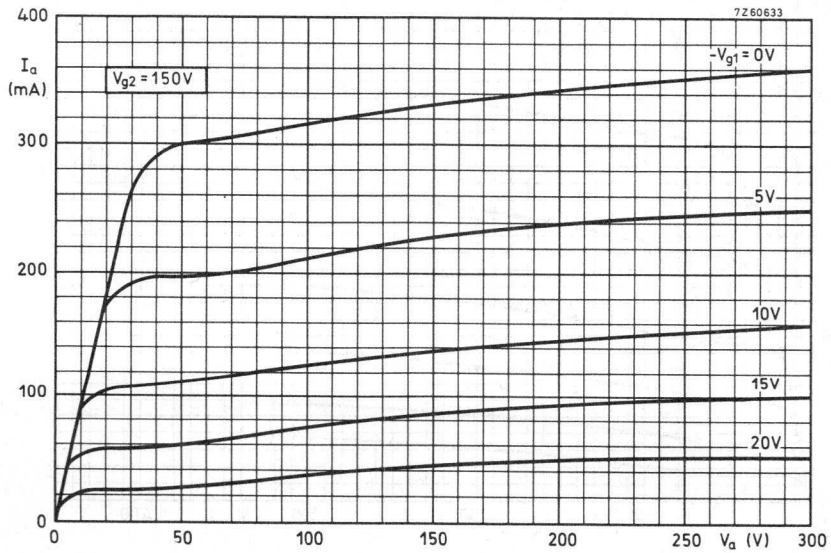
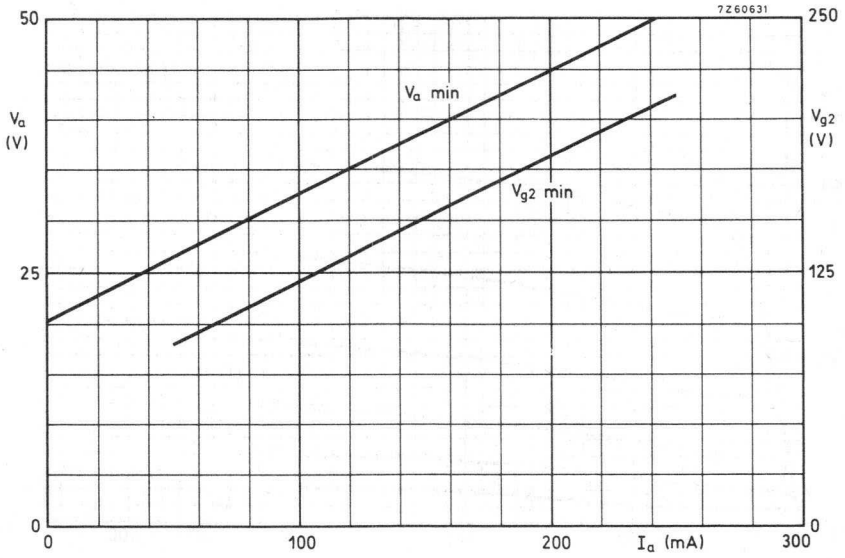

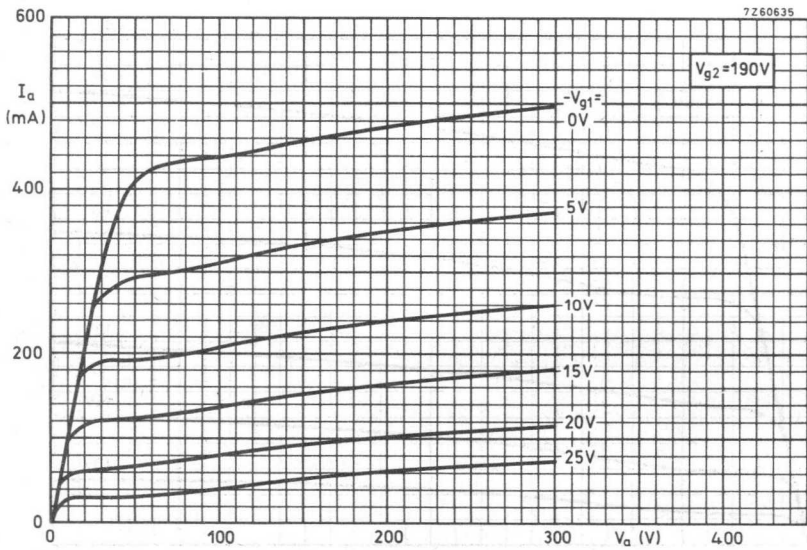
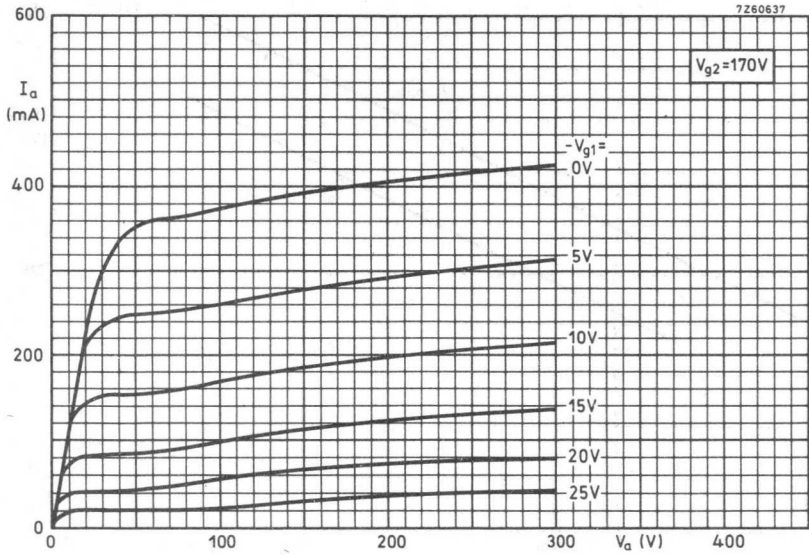

A.F. OUTPUT PENTODE

Pentode intended for use as A.F. power amplifier.

QUICK REFERENCE DATA			
Anode current	I_a	48	mA
Transconductance	S	11.3	mA/V
Amplification factor	$\mu_{g_2g_1}$	19	
Output power	W_o	6.0	W

HEATING: Indirect by A.C. or D.C.; parallel supply

Heater voltage	V_f	6.3	V
Heater current	I_f	760	mA

DIMENSIONS AND CONNECTIONS

Dimensions in mm

Base: Noval

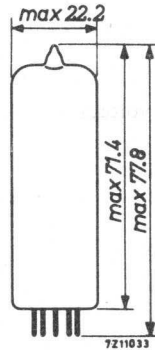
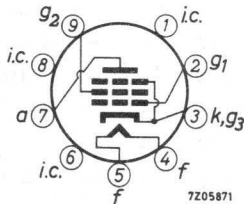

CAPACITANCES

Anode to all except grid No.1	$C_a(g_1)$	6.5	pF
Grid No.1 to all except anode	$C_{g_1(a)}$	10.8	pF
Anode to grid No.1	C_{ag_1}	max. 0.5	pF
Grid No.1 to heater	C_{g_1f}	max. 0.25	pF

OPERATING CHARACTERISTICS

Class A

Anode voltage	V_a		250		V		
Grid No.2 voltage	V_{g2}		250		V		
Grid No.1 voltage	V_{g1}		-7.3		V		
Cathode resistor	R_k		135		Ω		
Load resistance	$R_{a\sim}$		5.2		$k\Omega$		
Grid No.1 driving voltage	V_i	0	0.3	3.4	4.3	4.7 ²⁾	V_{RMS}
Anode current	I_a	48	-	-	49.5	49.2	mA
Grid No.2 current	I_{g2}	5.5	-	-	10.8	11.6	mA
Transconductance	S	11.3	-	-	-	-	mA/V
Amplification factor	μ_{g2g1}	19	-	-	-	-	
Internal resistance	R_i	38	-	-	-	-	$k\Omega$
Output power	W_o ¹⁾	0	0.05	4.5	5.7	6.0	W
Distortion, total	d_{tot} ¹⁾	-	-	6.8	10	-	%
second harmonic	d_2 ¹⁾	-	-	3.0	2.0	-	%
third harmonic	d_3 ¹⁾	-	-	5.8	9.5	-	%
Anode voltage	V_a		250		V		
Grid No.2 voltage	V_{g2}		250		V		
Grid No.1 voltage	V_{g1}		-7.3		V		
Cathode resistor	R_k		135		Ω		
Load resistance	$R_{a\sim}$		4.5		$k\Omega$		
Grid No.1 driving voltage	V_i	0	0.3	3.5	4.4	4.8 ²⁾	V_{RMS}
Anode current	I_a	48	-	-	50.6	50.5	mA
Grid No.2 current	I_{g2}	5.5	-	-	10	11	mA
Transconductance	S	11.3	-	-	-	-	mA/V
Amplification factor	μ_{g2g1}	19	-	-	-	-	
Internal resistance	R_i	38	-	-	-	-	$k\Omega$
Output power	W_o ¹⁾	0	0.05	4.5	5.7	6.0	W
Distortion, total	d_{tot} ¹⁾	-	-	7.5	10	-	%
second harmonic	d_2 ¹⁾	-	-	5.7	5.0	-	%
third harmonic	d_3 ¹⁾	-	-	4.5	8	-	%

1) Measured with fixed bias

2) At $I_{g1} = +0.3 \mu A$

OPERATING CHARACTERISTICS (continued)

Class A (continued)

Anode voltage	V_a	250			V
Grid No.2 voltage	V_{g2}	250			V
Grid No.1 voltage	V_{g1}	-8.4			V
Cathode resistor	R_k	210			Ω
Load resistance	$R_{a\sim}$	7			$k\Omega$
Grid No.1 driving voltage	V_i	0	0.3	3.5	5.5 ²⁾ V_{RMS}
Anode current	I_a	36	-	36.8	36 mA
Grid No.2 current	I_{g2}	4.1	-	8.5	14.6 mA
Transconductance	S	10	-	-	- mA/V
Amplification factor	μ_{g2g1}	19	-	-	-
Internal resistance	R_i	40	-	-	- $k\Omega$
Output power	W_o ¹⁾	0	0.05	4.2	5.6 W
Distortion, total	d_{tot} ¹⁾	-	-	10	- %
second harmonic	d_2 ¹⁾	-	-	1.7	- %
third harmonic	d_3 ¹⁾	-	-	8.7	- %
<hr/>					
Anode voltage	V_a	250			V
Grid No.2 voltage	V_{g2}	210			V
Grid No.1 voltage	V_{g1}	-6.4			V
Cathode resistor	R_k	160			Ω
Load resistance	$R_{a\sim}$	7			$k\Omega$
Grid No.1 driving voltage	V_i	0	0.3	3.4	3.8 ²⁾ V_{RMS}
Anode current	I_a	36	-	36.6	36.5 mA
Grid No.2 current	I_{g2}	3.9	-	7.3	8.0 mA
Transconductance	S	10.4	-	-	- mA/V
Amplification factor	μ_{g2g1}	19	-	-	-
Internal resistance	R_i	40	-	-	- $k\Omega$
Output power	W_o ¹⁾	0	0.05	4.3	4.7 W
Distortion, total	d_{tot} ¹⁾	-	-	10	- %
second harmonic	d_2 ¹⁾	-	-	1.8	- %
third harmonic	d_3 ¹⁾	-	-	9.3	- %

1) Measured with fixed bias

2) At $I_{g1} = +0.3 \mu A$

OPERATING CHARACTERISTICS (continued)

Class B, two tubes in push-pull

Anode voltage	V_a	250	300	V		
Grid No.2 voltage	V_{g_2}	250	300	V		
Grid No.1 voltage	V_{g_1}	-11.6	-14.7	V		
Load resistance	$R_{aa\sim}$	8	8	$k\Omega$		
Grid No.1 driving voltage	V_i	0	8	0	10	V_{RMS}
Anode current	I_a	2x10	2x37.5	2x7.5	2x46	mA
Grid No.2 current	I_{g_2}	2x1.1	2x7.5	2x0.8	2x11	mA
Output power	W_o	0	11	0	17	W
Distortion	d_{tot}	-	3	-	4	%

Class AB, two tubes in push-pull

Anode voltage	V_a	250	300	V		
Grid No.2 voltage	V_{g_2}	250	300	V		
Common cathode resistor	R_k	130	130	Ω		
Load resistance	$R_{aa\sim}$	8	8	$k\Omega$		
Grid No.1 driving voltage	V_i	0	8	0	10	V_{RMS}
Anode current	I_a	2x31	2x37.5	2x36	2x46	mA
Grid No.2 current	I_{g_2}	2x3.5	2x7.5	2x4	2x11	mA
Output power	W_o	0	11	0	17	W
Distortion	d_{tot}	-	3	-	4	%

OPERATING CHARACTERISTICS IN TRIODE CONNECTION

(g₂ connected to a)Class A

Anode voltage	V_a	250			V
Cathode resistor	R_k	270			Ω
Load resistance	$R_{a\sim}$	3.5			k Ω
Grid No.1 driving voltage	V_i	0	1.0	6.7	V _{RMS}
Anode current	I_a	34	-	36	mA
Output power	W_o	-	0.05	1.95	W
Distortion	d_{tot}	-	-	9	%

Class AB, two tubes in push-pull

Anode voltage	V_a	250	300		V	
Common cathode resistor	R_k	270	270		Ω	
Load resistance	$R_{aa\sim}$	10	10		k Ω	
Grid No.1 driving voltage	V_i	0	8.3	0	10	V _{RMS}
Anode current	I_a	2x20	2x21.7	2x24	2x26	mA
Output power	W_o	0	3.4	0	5.2	W
Distortion	d_{tot}	-	2.5	-	2.5	%
Grid No.1 driving voltage for $W_o = 50$ mW	V_i	0.95		0.9	V _{RMS}	

LIMITING VALUES (Design centre rating system)

Anode voltage	V_{a_0}	max.	550 V
	V_a	max.	300 V ¹⁾
Anode dissipation	W_a	max.	12 W ¹⁾
Grid No.2 voltage	$V_{g_{2o}}$	max.	550 V
	V_{g_2}	max.	300 V ¹⁾
Grid No.2 dissipation	W_{g_2}	max.	2 W
	$W_{g_{2p}}$	max.	4 W
Grid No.1 voltage	$-V_{g_1}$	max.	100 V
Cathode current	I_k	max.	65 mA
Grid No.1 resistor			
for automatic bias	R_{g_1}	max.	1 M Ω
for fixed bias	R_{g_1}	max.	0.3 M Ω
Cathode to heater voltage	V_{kf}	max.	100 V

¹⁾ When the heater and positive voltages are obtained from a storage battery by means of a vibrator, the max. values of V_a and V_{g_2} are 250 V and that of W_a is 9 W.

7Z06277-5.12.hd

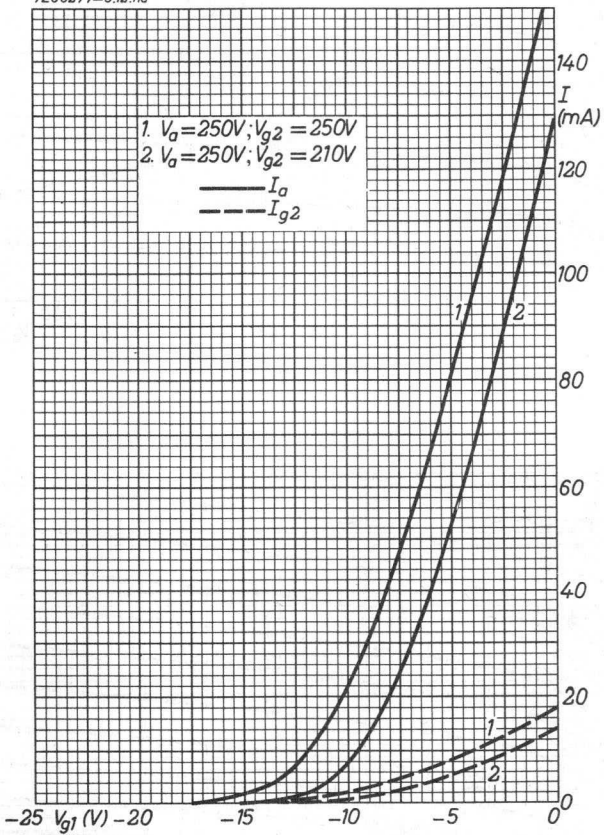

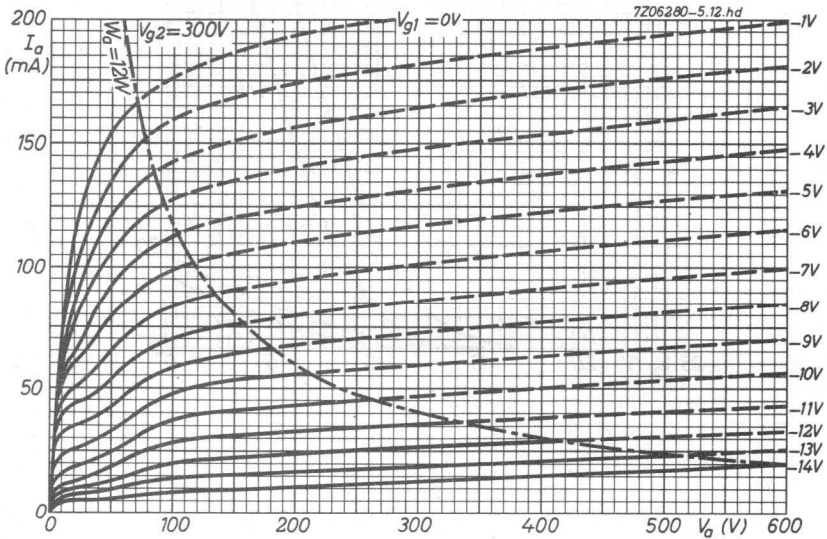
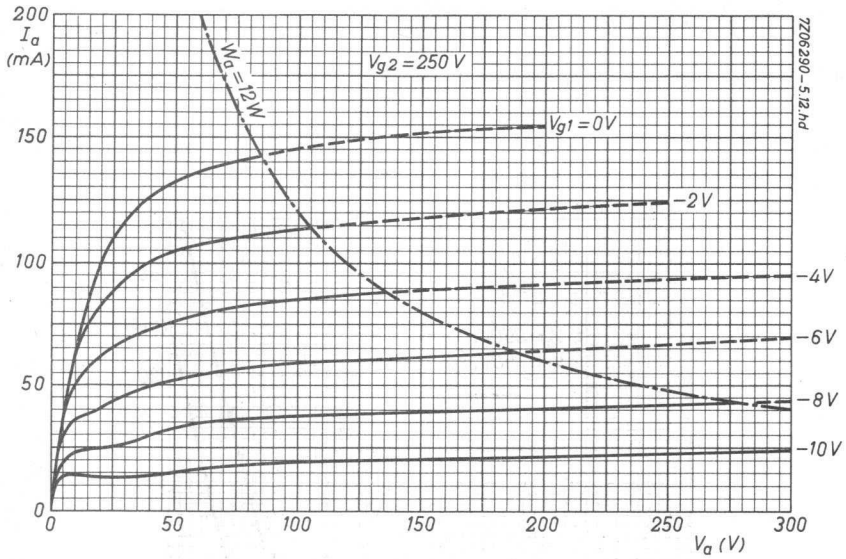

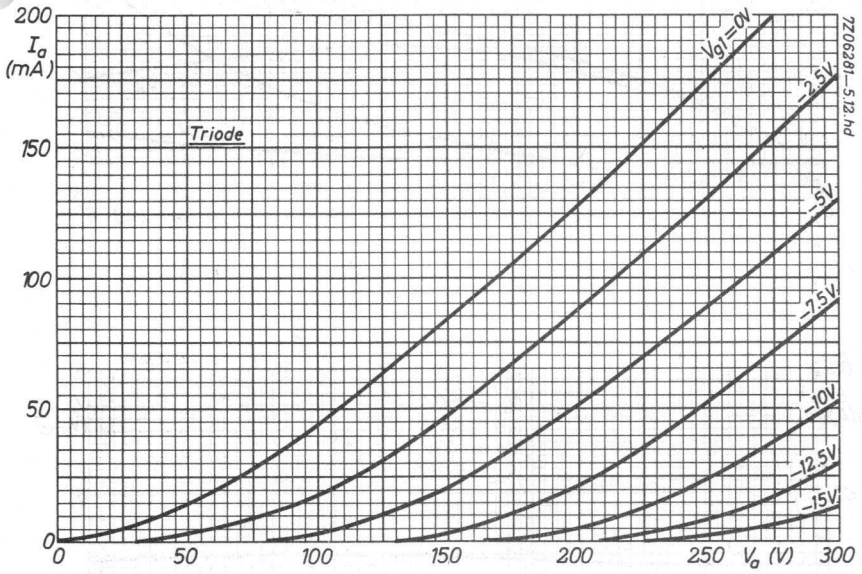

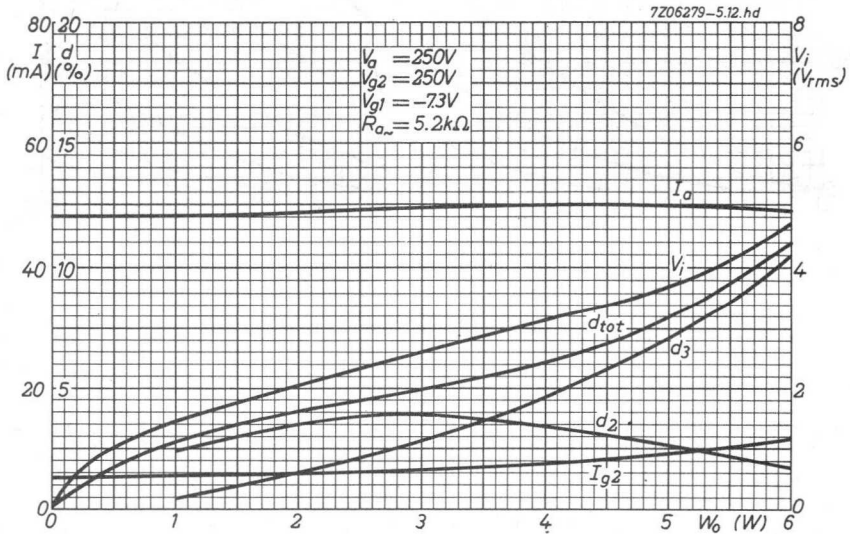
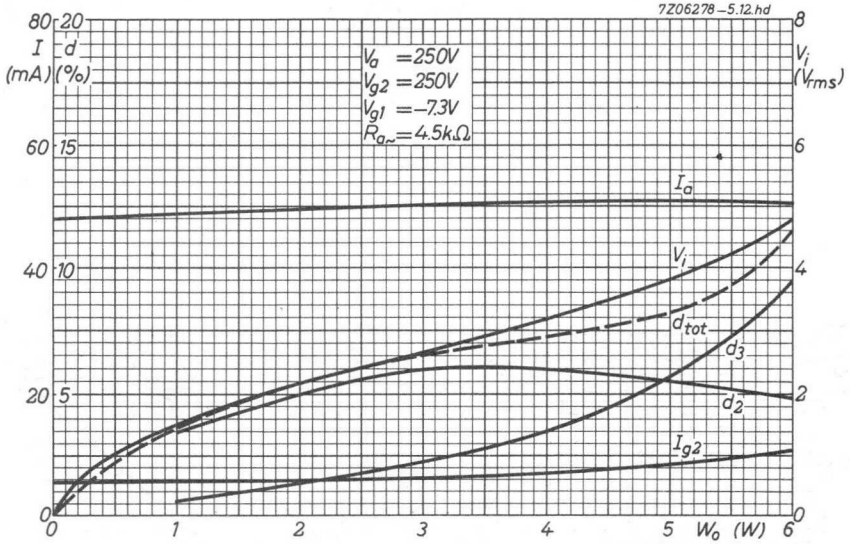

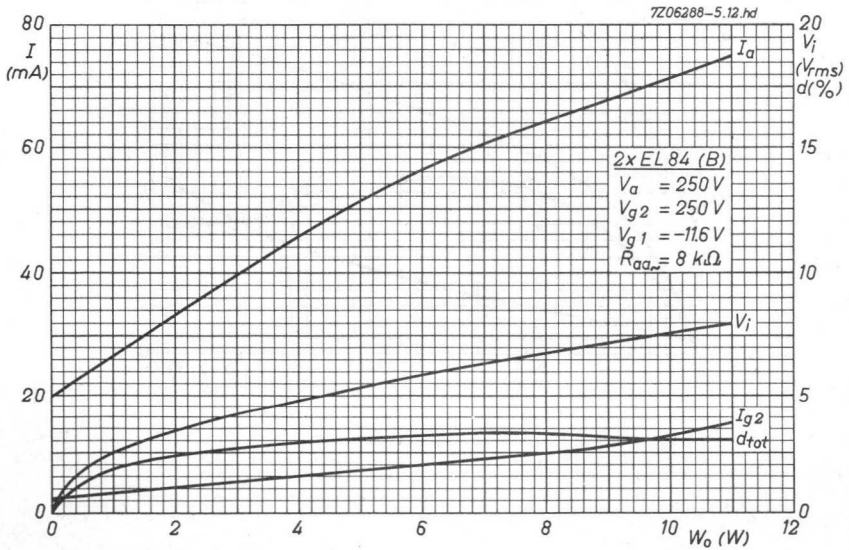
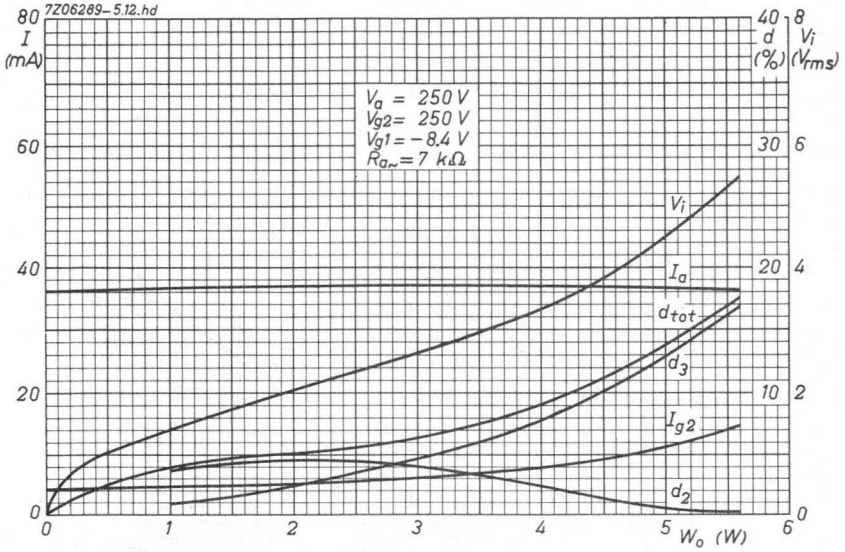

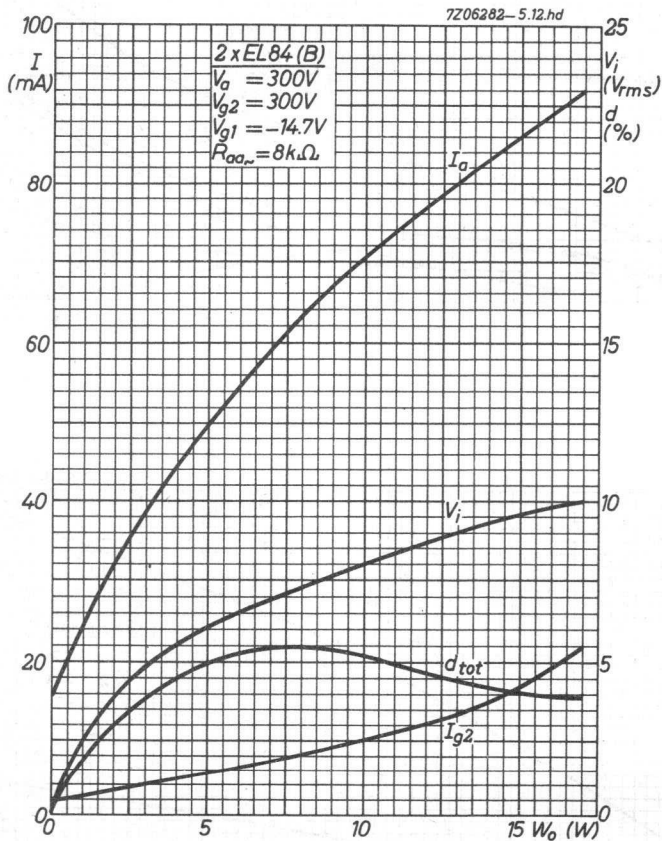

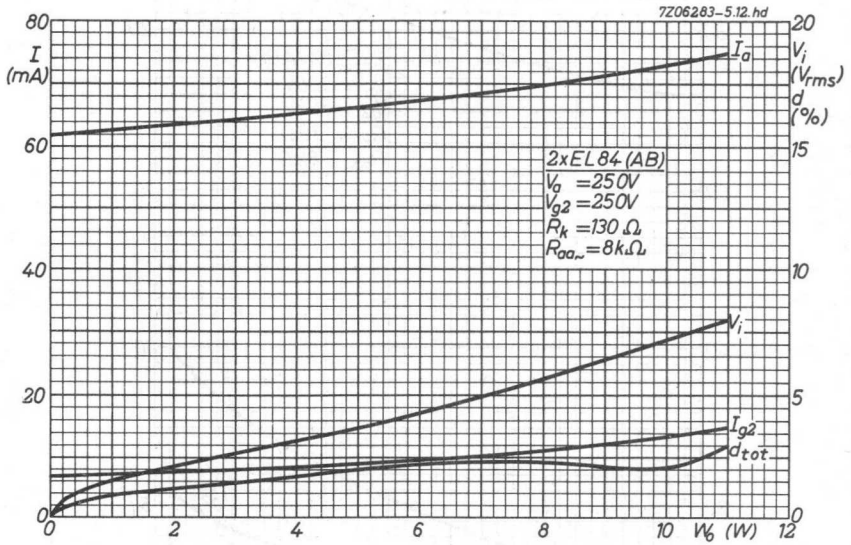

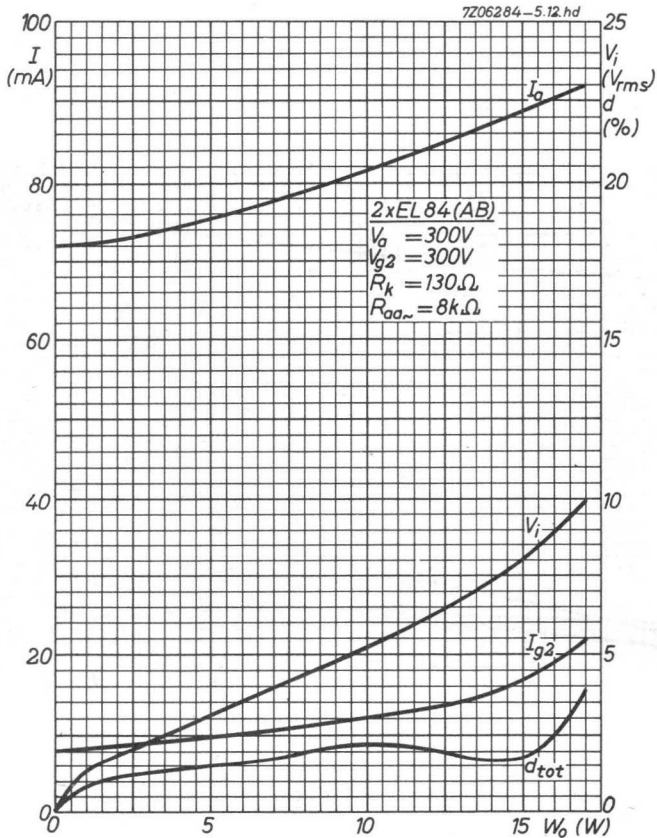

FRAME AND A.F. OUTPUT PENTODE

Pentode intended for use as frame output tube in television receivers and as A.F. power amplifier.

QUICK REFERENCE DATA			
Anode peak voltage	V_{ap}	max.	2 kV
Cathode current	I_k	max.	100 mA
Output power	W_o		5.3 W

HEATING: Indirect by A.C. or D.C.; parallel supply

Heater voltage

V_f 6.3 V

Heater current

I_f 760 mA

DIMENSIONS AND CONNECTIONS

Base: Noval

Dimensions in mm

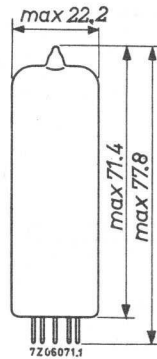
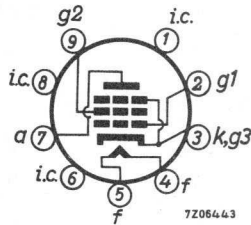

CAPACITANCES

Anode to all except grid No.1

$C_{a(g_1)}$ 6.8 pF

Grid No.1 to all except anode

$C_{g_1(a)}$ 13 pF

Anode to grid No.1

C_{ag_1} max. 0.6 pF

Grid No.1 to heater

C_{g_1f} max. 0.25 pF

OPTIMUM PEAK ANODE CURRENT IN FRAME OUTPUT OPERATION

The circuit should be designed so that the peak anode current does not exceed:

- 145 mA at $V_a = 60$ V, $V_{g2} = 170$ V, $V_f = 6.3$ V
- 190 mA at $V_a = 70$ V, $V_{g2} = 200$ V, $V_f = 6.3$ V
- 220 mA at $V_a = 80$ V, $V_{g2} = 220$ V, $V_f = 6.3$ V

The minimum available value of the peak anode current at end of life and $V_f = 5.7$ V is:

- 125 mA at $V_a = 60$ V, $V_{g2} = 170$ V
- 160 mA at $V_a = 70$ V, $V_{g2} = 200$ V
- 185 mA at $V_a = 80$ V, $V_{g2} = 220$ V

OPERATING CHARACTERISTICS

A.F. power amplifier, class A (Measured with V_k constant)

Supply voltage	V_b	200	V
Grid No.2 series resistor (non decoupled)	R_{g2}	470	Ω
Cathode resistor	R_k	215	Ω
Load resistance	$R_a \sim$	2.5	k Ω
Grid No.1 driving voltage	V_i	0 0.52 7.0	V_{RMS}
Anode current	I_a	65 - 64	mA
Grid No.2 current	I_{g2}	3.2 - 11.4	mA
Output power	W_o	0 0.05 5.3	W
Distortion	d_{tot}	- - 10	%

A.F. power amplifier, class AB, two tubes in push-pull

Anode supply voltage	V_{ba}	250	V
Grid No.2 supply voltage	V_{bg2}	200	V
Common cathode resistor	R_k	150	Ω
Load resistance	$R_{aa} \sim$	5.5	k Ω
Grid No.1 driving voltage	V_i	0 0.37 13.0	V_{RMS}
Anode current	I_a	2x50 - 2x55	mA
Grid No.2 current	I_{g2}	2x2.0 - 2x13	mA
Output power	W_o	0 0.05 18.5	W
Distortion	d_{tot}	- - 4.5	%

OPERATING CHARACTERISTICS (continued)

A.F. power amplifier, single ended push-pull

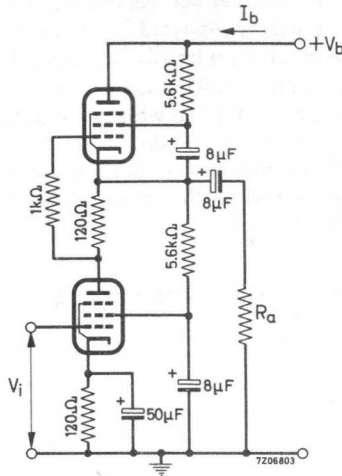

a) Single tone input signal

Supply voltage	V_b	300	V
Load resistance	$R_{a\sim}$	1	k Ω
Grid No.1 driving voltage	V_i	0 0.41 5.4	V_{RMS}
Supply current	I_b	66 - 64	mA
Output power	W_o	0 0.05 4.5	W
Distortion	d_{tot}	- - 9.3	%

b) Double tone input signal

Supply voltage	V_b	300	V
Load resistance	$R_{a\sim}$	1	k Ω
Grid No.1 driving voltage	V_i	0 2.7	$V_{RMS}^1)$
Supply current	I_b	66 64	mA
Output power	W_o	0 5.5	W
Distortion	d_{tot}	- 8.5	%

¹⁾ Value of each tone separately.

REMARK

Single tone data are obtained with a pure sinusoidal input voltage. However such an input voltage is in general not representative for the reproduction of music and speech, since a purely sinusoidal tone seldom occurs.

The double tone data are obtained with two sinusoidal signals of different frequencies but of the same amplitude. This appears to be far better in agreement with practice. In the case of full drive with two sinusoidal signals different in frequency but having the same amplitude, the output power is half the value obtained at full drive with a single sinusoidal input voltage of twice this amplitude. To make comparison possible the obtained output power with double tone has therefore been multiplied by 2.

LIMITING VALUES (Design centre rating system)

Anode voltage	V_{a0}	max.	550 V
	V_a	max.	250 V
Anode peak voltage	V_{ap}	max.	2 kV ¹⁾
Grid No.2 voltage	V_{g20}	max.	550 V
	V_{g2}	max.	250 V
Anode dissipation	W_a	max.	12 W ²⁾
Grid No.2 dissipation:			
average	W_{g2}	max.	1.75 W
peak	W_{g2p}	max.	6 W
Cathode current	I_k	max.	100 mA
Grid No.1 resistor:			
automatic bias	R_{g1}	max.	1 M Ω
frame output application with automatic bias	R_{g1}	max.	2 M Ω
Cathode to heater voltage	V_{kf}	max.	200 V

¹⁾ Valid for application in frame output circuits where the max. pulse duration is 4% of a cycle with a max. of 0.8 ms.

²⁾ For frame output application $W_a = \text{max. } 10 \text{ W}$.

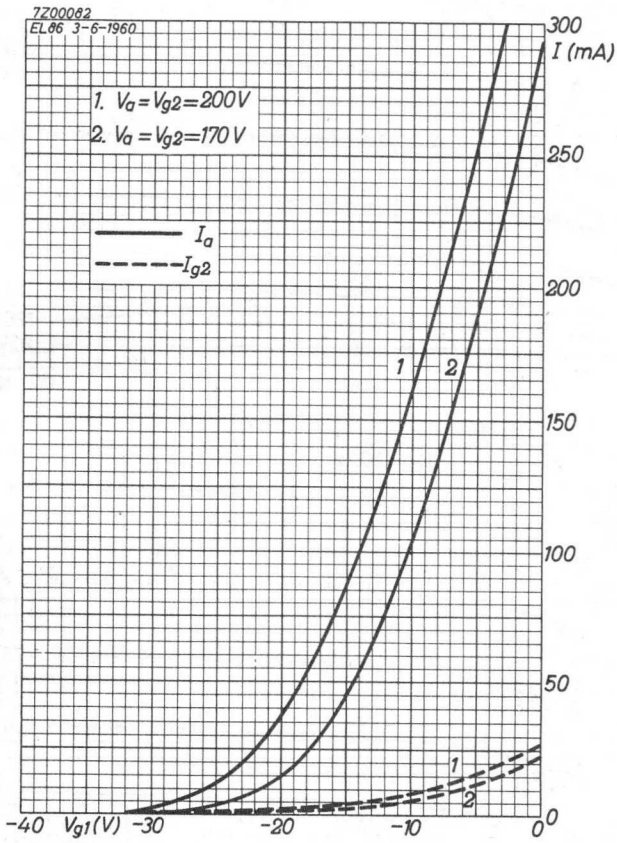

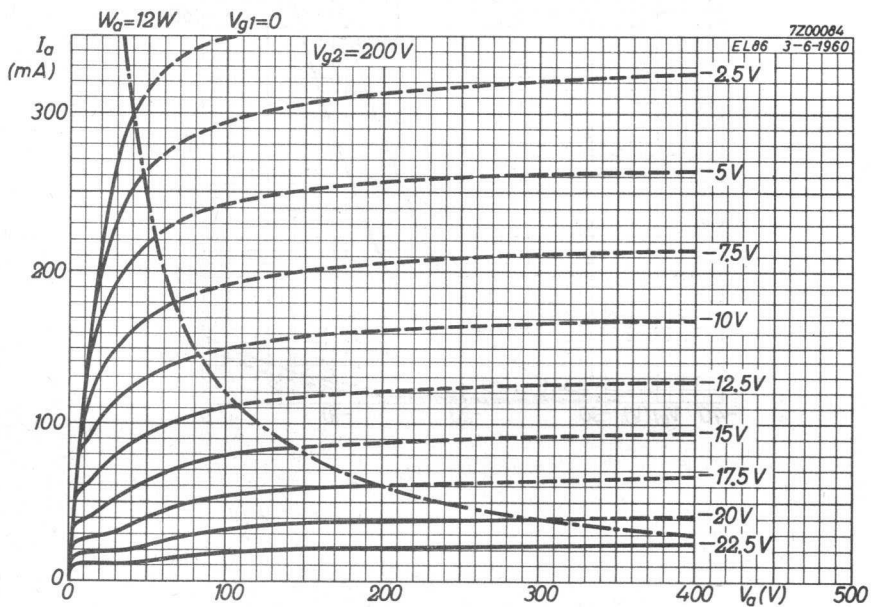
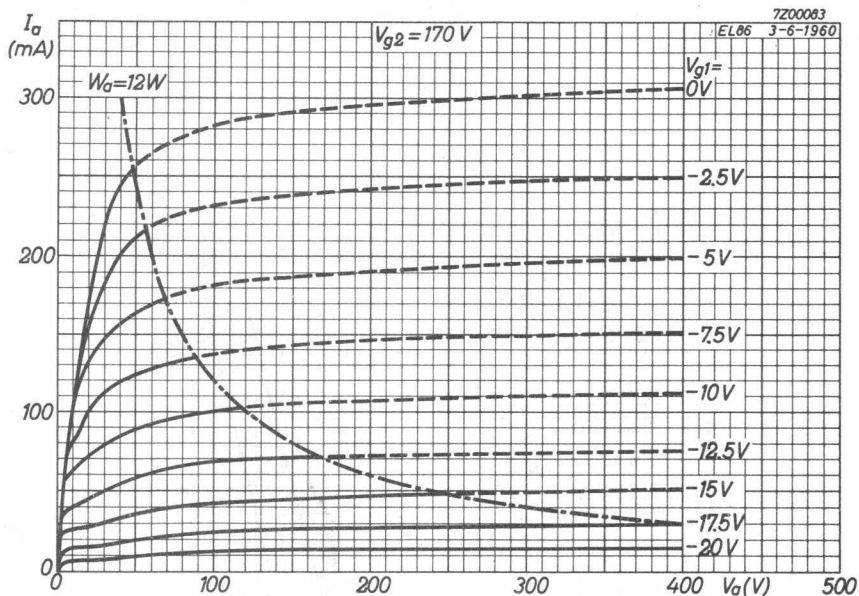

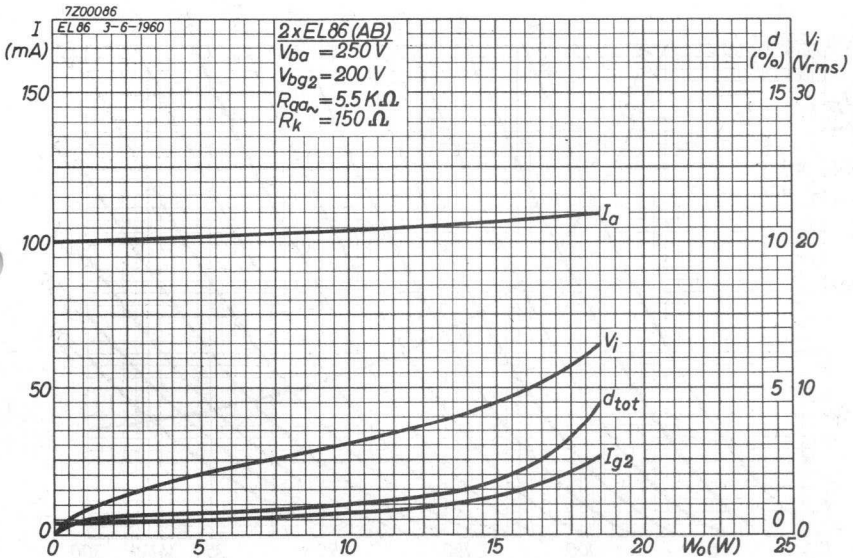
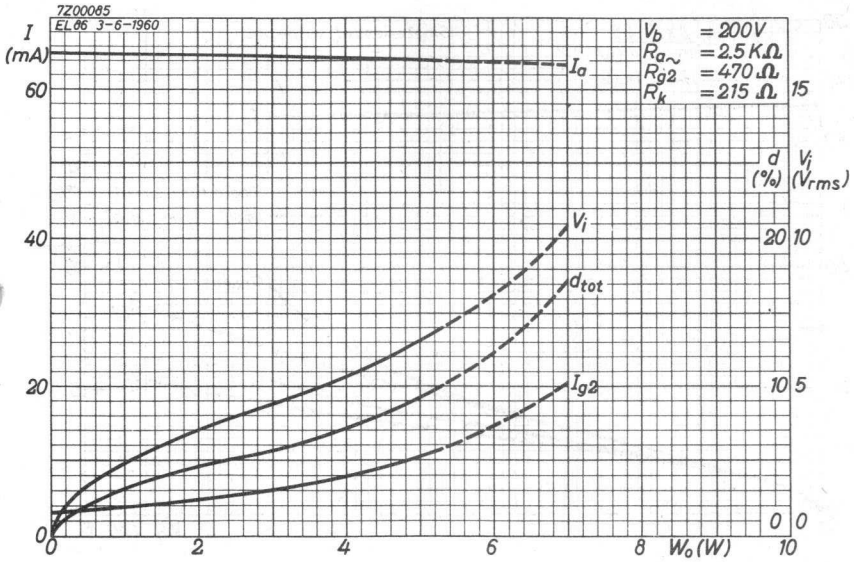

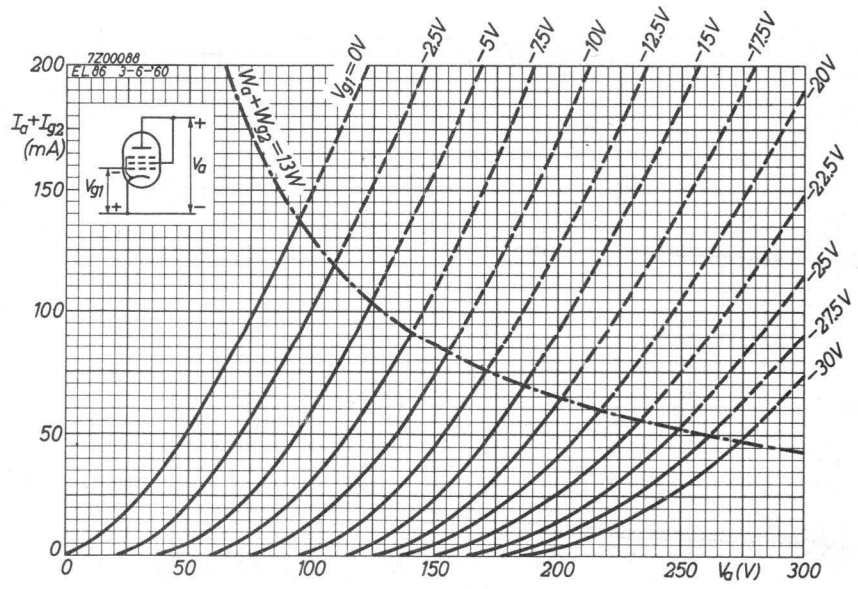
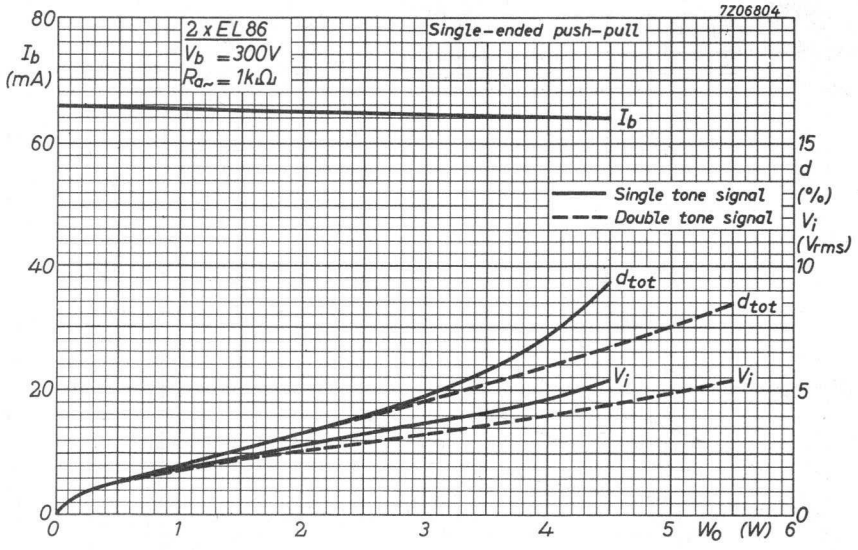

A.F. OUTPUT PENTODE

Pentode intended for use as A. F. power amplifier:

HEATING : Indirect by A. C. or D. C. ; parallel supply

Heater voltage	V_f	6.3 V
Heater current	I_f	200 mA

LIMITING VALUES (Design centre rating system)

Cathode to heater voltage	V_{kf}	max.	100 V
---------------------------	----------	------	-------

For further data and curves of this type
please refer to type PL95

RECEIVED

THE UNIVERSITY OF CHICAGO

LIBRARY

CHICAGO, ILL.

1912

RECEIVED

1912

THE UNIVERSITY OF CHICAGO

LIBRARY

CHICAGO, ILL.

1912

LINE OUTPUT PENTODE

Beam pentode intended for use as line output tube in television receivers.

HEATING: Indirect by A.C. or D.C.; parallel supply

Heater voltage	V_f	6.3 V
Heater current	I_f	1.38 A

LIMITING VALUES (Design centre rating system)

Cathode to heater voltage

DC + peak, k positive	V_{kf}	max. 200 V
k negative	$-V_{kf}$	max. 200 V ³⁾

Anode dissipation

See graph below

Grid No.2 dissipation

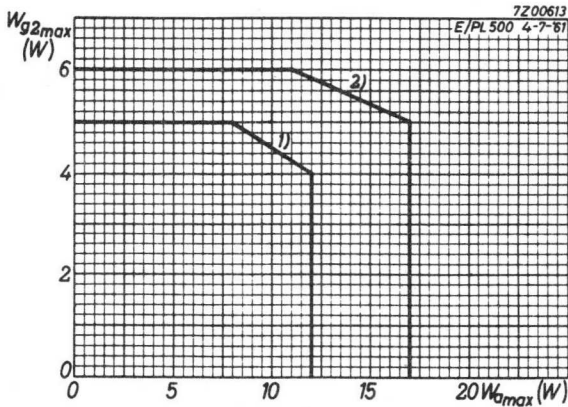

- 1) Design centre limits for W_a and W_{g2} .
- 2) These limits for W_a and W_{g2} should not be exceeded with a nominal tube operating in a normal line deflection circuit under the worst probable conditions.
- 3) D.C. component max. 100 V.

 For further data and curves of this type
 please refer to type PL 504

REPORT OF THE

Faint, illegible text in the upper section of the page, possibly a title or introductory paragraph.

A large block of very faint, illegible text in the middle of the page, possibly a main body of a report.

Faint, illegible text in the lower section of the page, possibly a conclusion or footer.

A.F. OUTPUT PENTODE

Beam pentode intended for use as A.F. power amplifier.

QUICK REFERENCE DATA			
Anode current	I_a	110	mA
Transconductance	S	23	mA/V
Amplification factor	$\mu_{g_2g_1}$	13	
Output power (class AB)	W_o	40	W

HEATING: Indirect by A.C. or D.C.; parallel supply

Heater voltage

V_f 6.3 V

Heater current

I_f 1.05 A

DIMENSIONS AND CONNECTIONS

Base: Magnoval

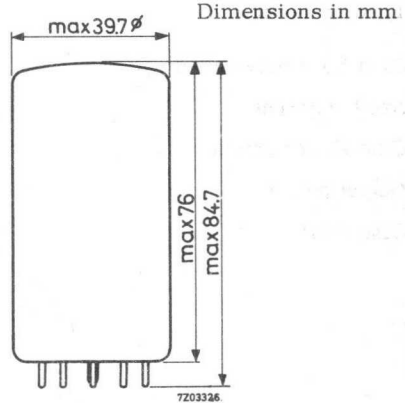
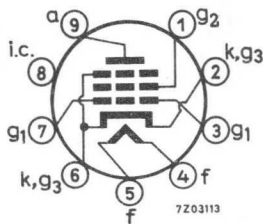

CAPACITANCES

Anode to all except grid No. 1

$C_a(g_1)$ 13.5 pF

Grid No. 1 to all except anode

$C_{g_1(a)}$ 22.5 pF

Anode to grid No. 1

C_{ag_1} 1.7 pF

Grid No. 1 to heater

C_{g_1f} 0.325 pF

TYPICAL CHARACTERISTICS

Anode voltage	V_a	250	V
Grid No.2 voltage	V_{g_2}	250	V
Grid No.1 voltage	V_{g_1}	14.0	V
Anode current	I_a	110	mA
Grid No.2 current	I_{g_2}	7.0	mA
Transconductance	S	23	mA/V
Amplification factor	$\mu_{g_2g_1}$	13	
Internal resistance	R_i	5.4	k Ω

OPERATING CHARACTERISTICS

Class AB, two tubes in push-pull

Anode supply voltage	V_{ba}	265	V
Grid No.2 supply voltage	V_{bg_2}	265	V
Common cathode resistor	R_k	56	Ω
Load resistance	$R_{aa\sim}$	2.4	k Ω
Grid No.1 driving voltage	V_i	0 12.2	V_{RMS}
Anode current	I_a	2x115 2x125	mA
Grid No.2 current	I_{g_2}	2x7.5 2x35.0	mA
Output power	W_o	0 40	W
Distortion	d_{tot}	- 5	%

LIMITING VALUES (Design centre rating system)

Anode voltage	V_{a0}	max. 550 V
	V_a	max. 300 V
Grid No. 2 voltage	V_{g20}	max. 550 V
	V_{g2}	max. 300 V
Anode dissipation	W_a	see below
Grid No. 2 dissipation		
average	W_{g2}	see below
peak	W_{g2p}	see below
Cathode current	I_k	max. 200 mA
Grid No.1 resistor, automatic bias	R_{g1}	max. 0.5 M Ω
Cathode to heater voltage	V_{kf}	max. 100 V

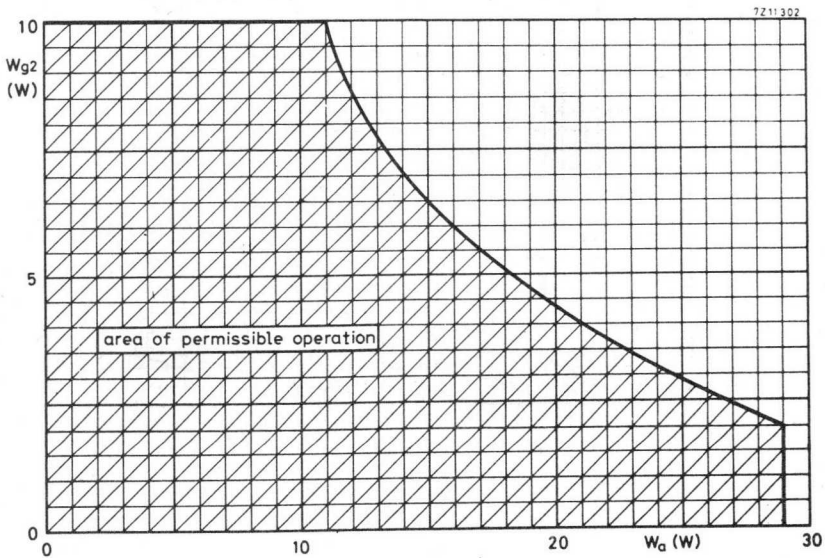

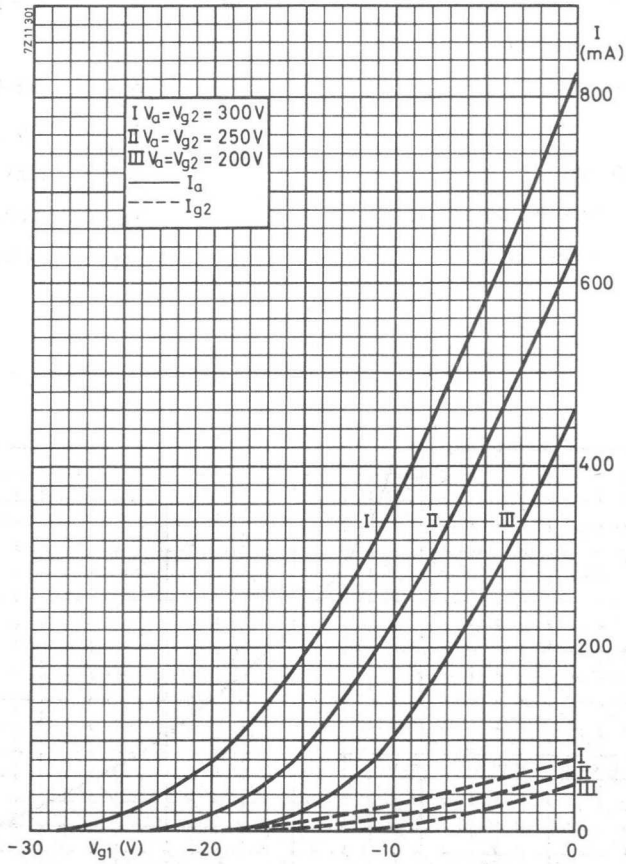

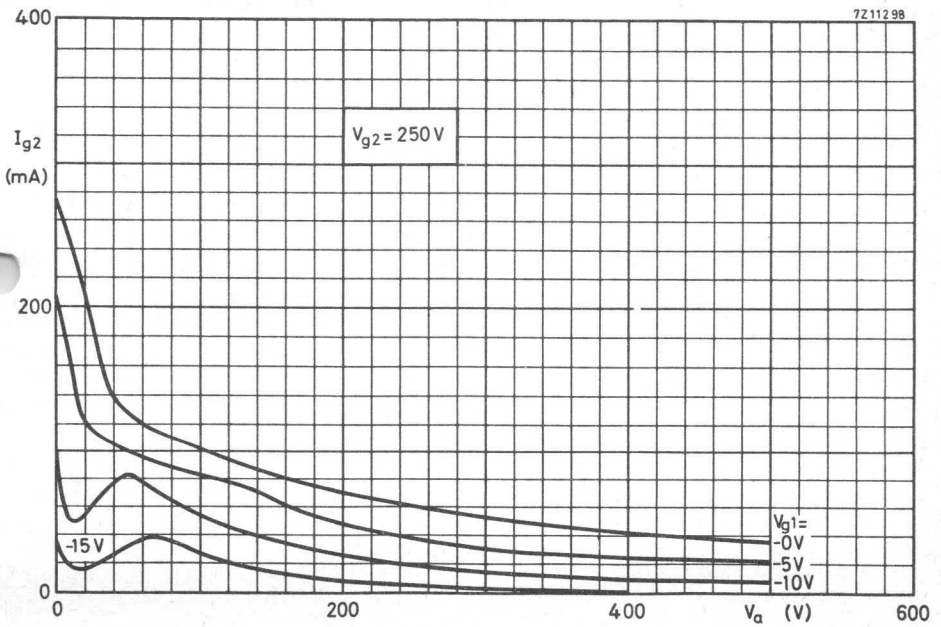
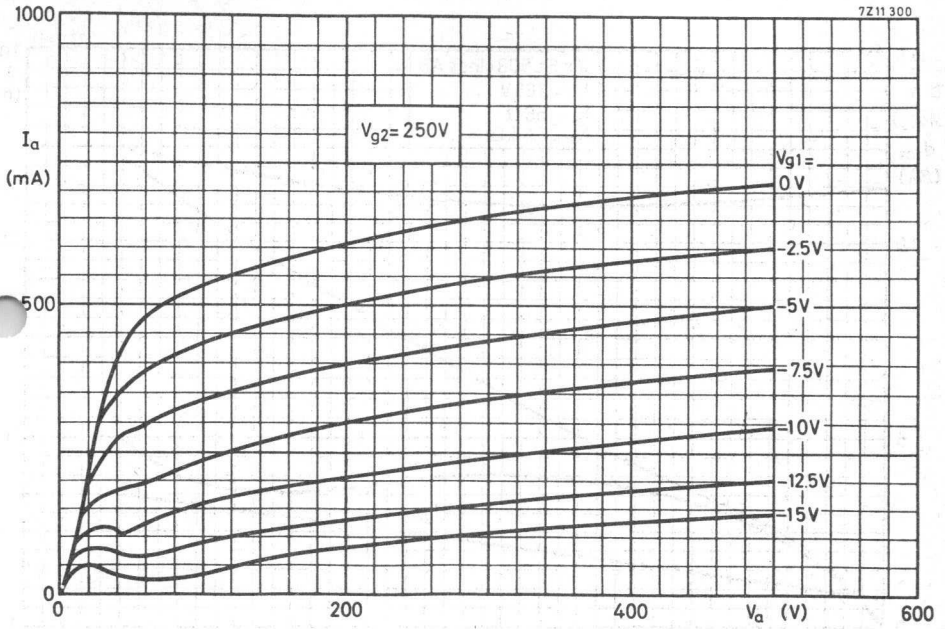

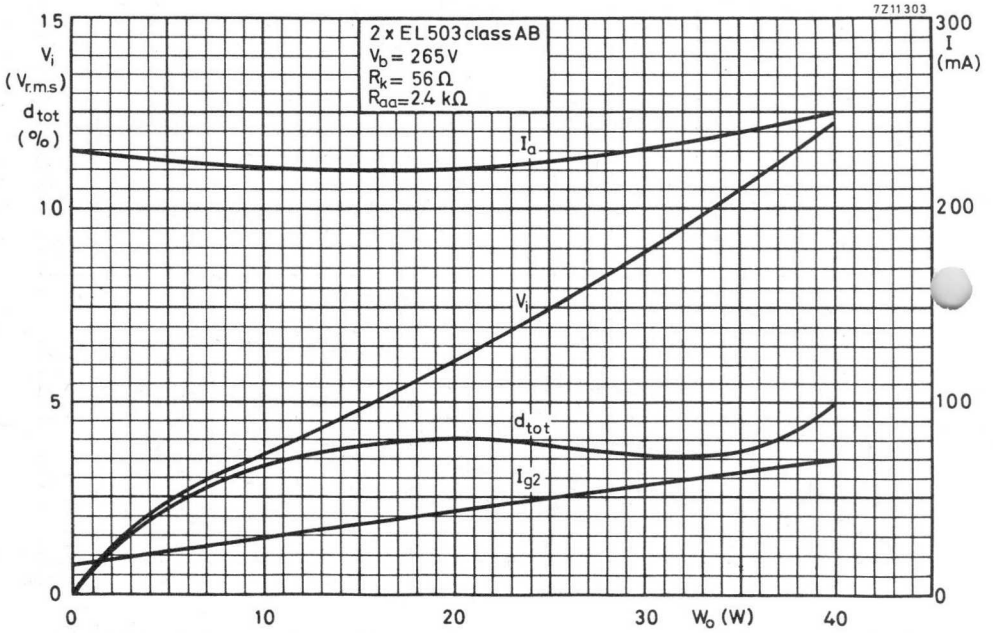

LINE OUTPUT PENTODE

Beam pentode intended for use as line output tube in television receivers.

HEATING: Indirect by A. C. or D. C.; parallel supply

Heater voltage

V_f 6.3 V

Heater current

I_f 1.38 A

LIMITING VALUES (Design centre rating system)

Cathode to heater voltage,

DC + peak, k positive

V_{kf} max. 200 V

k negative

$-V_{kf}$ 200 V¹⁾

 For further data and curves of this type
 please refer to type PL 504

¹⁾ DC component max. 100 V.

100-25 71110 101

... ..
... ..
... ..

... ..
... ..
... ..

... ..
... ..
... ..

FRAME OUTPUT PENTODE

Pentode intended for use as frame output amplifier in colour television receivers.

HEATING: Indirect by A.C. or D.C.; parallel supply

Heater voltage

V_f 6.3 V

Heater current

I_f 825 mA

LIMITING VALUES (Design centre rating system)

Cathode to heater voltage

V_{kf} max. 100 V

For further data of this type please
refer to type PL508

FRAME OUTPUT PERIOD

... ..
... ..
... ..

... ..
... ..
... ..
... ..
... ..



LINE OUTPUT PENTODE

Output pentode intended for colour TV line deflection circuits.

HEATING: Indirect by A. C. or D. C.; parallel supply

Heater voltage

V_f 6.3 V

Heater voltage

I_f 2 A

LIMITING VALUES (Design centre rating system)

Cathode to heater voltage,

DC + peak, k positive

V_{kf}

max. 200 V

k negative

$-V_{kf}$

max. 200 V¹⁾

 For further data and curves of this type
 please refer to type PL 509

¹⁾ DC component max. 100 V.

1951-1952

...

...

...

...

...

...

...

...

...

...

LINE OUTPUT PENTODE

Output pentode intended for colour TV line deflection circuits.

HEATING: Indirect by A.C. or D.C. ; parallel supply

Heater voltage	V_f	6.3	V
Heater current	I_f	2	A

LIMITING VALUES (Design centre rating system)

Cathode to heater voltage,

DC + peak, k positive	V_{kf}	max. 200	V
k negative	$-V_{kf}$	max. 200	V ¹⁾

 For further data and curves of this type
 please refer to type PL519

¹⁾ DC component max. 100 V.

THE UNITED STATES

Department of the Interior

Bureau of Land Management

Washington, D.C. 20250

Attention: Director

Enclosed for the Bureau are

two copies of the report

entitled "Study of the

Public Lands in the

State of California

prepared by the

California State Lands

Commission.

Very truly yours,

Director

Bureau of Land Management

Department of the Interior

Washington, D.C. 20250

Enclosed for the Bureau are

two copies of the report

entitled "Study of the

Public Lands in the

State of California

prepared by the

California State Lands

Commission.

Very truly yours,

Director

VIDEO OUTPUT PENTODE

Luminance output tube in colour TV receivers

HEATING: Indirect by A.C. or D.C.; parallel supply

Heater voltage
Heater current

$$\frac{V_f}{I_f} \quad \frac{6.3 \text{ V}}{800 \text{ mA}}$$

LIMITING VALUES (Design centre rating system)

Cathode to heater voltage

V_{kf} max. 100 V

For further data of this type please refer
to type PL802

VIDEO OUTPUT FORMAT

The video output format is defined by the following parameters:
 Resolution: 720 lines
 Frame rate: 30 frames per second
 Aspect ratio: 4:3
 Color: Composite color

The video output is generated by the video processor
 and is available at the video output connector.
 The video output is a standard video signal.

TUNING INDICATOR

Indicator tube with triode amplifier intended for use as tuning indicator or for modulation control.

HEATING: Indirect by A.C. or D.C.; parallel supply

Heater voltage

V_f 6.3 V

Heater current

I_f 210 mA

DIMENSIONS AND CONNECTIONS

Dimensions in mm

Base: Noval

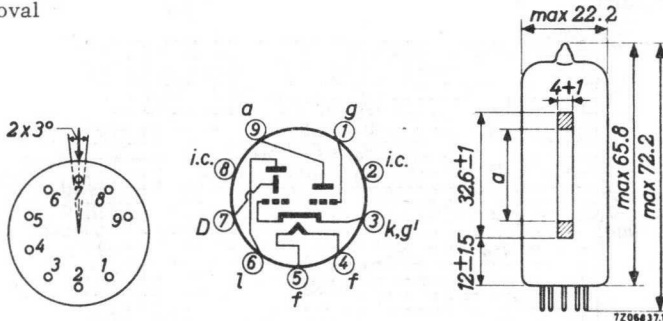

The arrow near pin 7 indicates the viewing direction.

OPERATING CHARACTERISTICS (D connected to a)

Supply voltage	V_b	250	V
Luminescent screen voltage	V_l	250	V
Anode and deflection electrode resistor	$R_{a,D}$	470	$k\Omega$
Grid resistor	R_g	3	$M\Omega$
Grid supply voltage	V_{bg}	0	-22 V
Anode and deflection electrode current	I_{a+D}	0.45	0.06 mA
Luminescent screen current	I_l	1.0	1.8 mA
Shadow length	a	21 ± 5	0 mm

LIMITING VALUES (Design centre rating system)

Anode voltage	V_{a0}	max. 550 V
	V_a	max. 300 V
Anode dissipation	W_a	max. 0.5 W
Deflection electrode voltage	V_{D0}	max. 550 V
	V_D	max. 300 V
Luminescent screen voltage	V_{l0}	max. 550 V
	V_l	max. 300 V
	V_l	min. 170 V
Cathode current	I_k	max. 3 mA
Grid resistor	R_g	max. 3 M Ω
Cathode to heater voltage	V_{kf}	max. 100 V
Bulb temperature	t_{bulb}	max. 120 °C

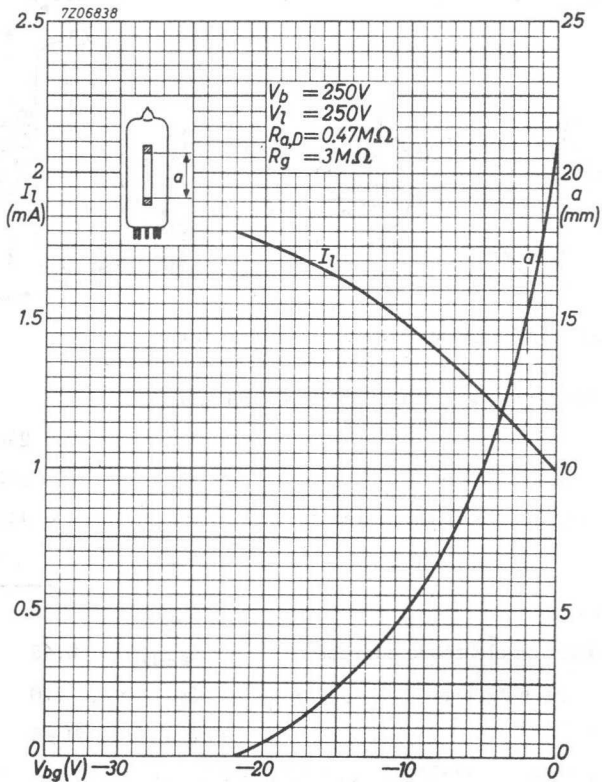

TUNING INDICATOR

Tuning indicator tube.

HEATING: Indirect by A.C. or D.C.; series or parallel supply

Heater voltage

V_f 6.3 V

Heater current

I_f 300 mA

DIMENSIONS AND CONNECTIONS

Dimensions in mm

Base: Noval

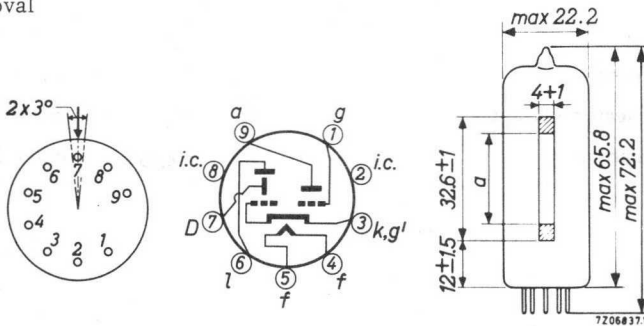

The arrow near pin 7 indicates the viewing direction.

OPERATING CHARACTERISTICS (D connected to a)

Supply voltage	V_b	250	V
Luminescent screen voltage	V_l	250	V
Anode and deflection electrode resistor	$R_{a,D}$	100	k Ω
Grid resistor	R_g	3	M Ω
Grid supply voltage	V_{bg}	0 -10 -15	V
Anode and deflection electrode current	I_{a+D}	2.0 0.5 0.2	mA
Luminescent screen current	I_l	1.0 1.8 2.0	mA
Shadow length	a	21 0 -1.5	mm ¹⁾

1) A negative value of "a" means overlapping:

The grid bias for a = 0 is reduced by decreasing V_l .

The measure of overlapping at $V_g = -15$ V will then increase (see page 4).

LIMITING VALUES (Design centre rating system)

Anode voltage	V_{a0}	max. 550 V
	V_a	max. 300 V
Anode dissipation	W_a	max. 0.6 W
Deflection electrode voltage	V_{D0}	max. 550 V
	V_D	max. 300 V
Luminescent screen voltage	$V_{\ell 0}$	max. 550 V
	V_{ℓ}	max. 300 V
	V_{ℓ}	min. 170 V
Grid resistor	R_g	max. 3 $M\Omega$
Cathode current	I_k	max. 5 mA
Cathode to heater voltage	V_{kf}	max. 250 V
Bulb temperature	t_{bulb}	max. 120 $^{\circ}C$

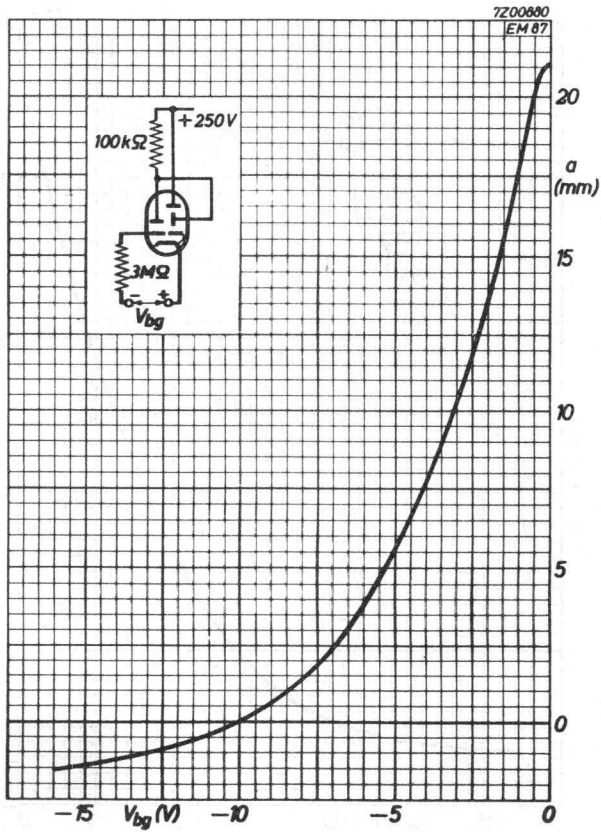

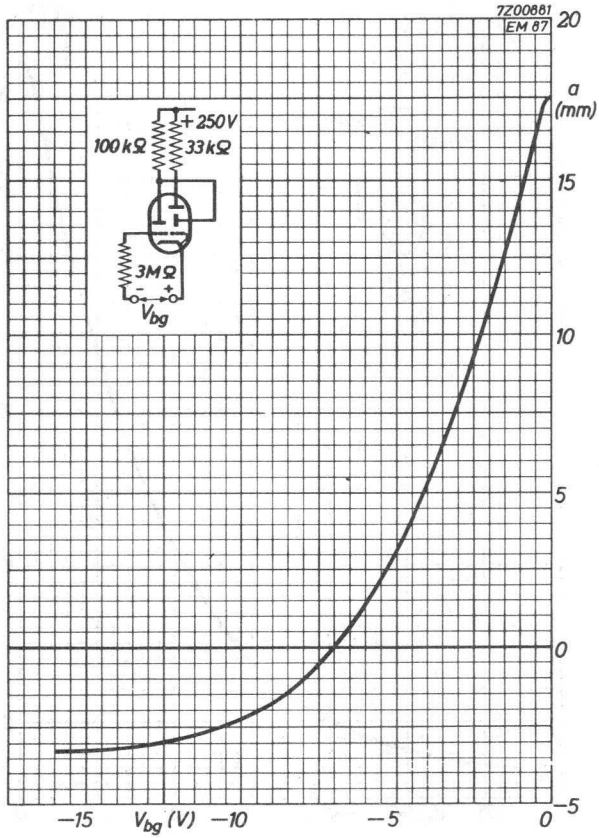

BOOSTER DIODE

Booster diode intended for use in line time-base circuits of television receivers.

HEATING: Indirect by A. C. or D. C.; parallel supply

Heater current

$\frac{V_f}{I_f}$ 6.3 V

Heater voltage

810 mA

For further data and curves
please refer to type PY81

1877

RECEIVED

RECEIVED



BOOSTER DIODE

Booster diode intended for use in line time base circuits of television receivers.

HEATING: Indirect by A.C. or D.C.; parallel supply

Heater voltage

V_f 6.3 V

Heater current

I_f 1.55 A

For further data and curves of this type
please refer to type PY88

8873

10018 877008

10018 877008

10018 877008

10018 877008

BOOSTER DIODE

Booster diode intended for use in time base circuits of colour television receivers.

HEATING: Indirect by A.C. or D.C.; parallel supply

Heater voltage

$\frac{V_f}{\quad}$ 6.3 V

Heater current

I_f 2.1 A

For further data and curves of this type
please refer to type PY500

ROBBER DICK

On 10/10/71, the following items were noted during the inspection of the vehicle:

- 1. Front suspension - normal
- 2. Rear suspension - normal
- 3. Brakes - normal
- 4. Tires - normal
- 5. Steering - normal
- 6. Lights - normal
- 7. Horn - normal
- 8. Windshield wipers - normal
- 9. Oil level - normal
- 10. Water level - normal

Vehicle condition is satisfactory for service.

BOOSTER DIODE

Booster diode intended for use in time base circuits of colour television receivers.

HEATING: Indirect by A.C. or D.C.; parallel supply

Heater voltage

$\frac{V_f}{\quad}$ 6.3 V

Heater current

I_f 2.1 A

For further data and curves of this type
please refer to type PY500A

000000

000000

000000

000000

000000

000000

DOUBLE ANODE RECTIFYING TUBE

Double anode high vacuum rectifying tube

QUICK REFERENCE DATA

Transformer voltage	V_{tr}	2x350	V_{RMS}
D.C. current	I_o	90	mA

HEATING: Indirect by A.C.; parallel supply

Heater voltage	V_f	6.3	V
Heater current	I_f	600	mA

DIMENSIONS AND CONNECTIONS

Dimensions in mm

Base: Noval

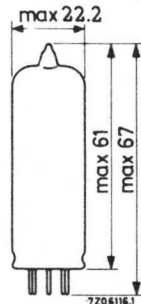
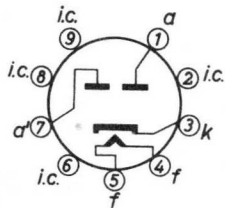

OPERATING CHARACTERISTICS as two-phase half-wave rectifier

Transformer voltage	V_{tr}	2x250	2x275	2x300	2x350	V_{RMS}
D.C. output voltage	V_o	260	285	310	360	V
D.C. current	I_o	90	90	90	90	mA
Protecting resistance	R_t	2x125	2x175	2x215	2x300	Ω
Input capacitor of smoothing filter	C_{filt}	50	50	50	50	μF

LIMITING VALUES (Design centre rating system)

Transformer voltage	V_{tr}	max.	2x350	V_{RMS}		
D.C. current	I_o	max.	90	mA		
Cathode to heater voltage, peak, k pos	V_{kf_p}	max.	500	V		
Input capacitor of smoothing filter	C_{filt}	max.	50	μF		
Protecting resistance at transformer voltage	R_t min.	2x125	2x175	2x215	2x300	Ω
	V_{tr}	2x250	2x275	2x300	2x350	V_{RMS}

DOUBLE ANODE RECTIFYING TUBE

Double anode high vacuum rectifying tube.

QUICK REFERENCE DATA			
Transformer voltage	V_{tr}	2x450	V_{RMS}
D.C. current	I_o	100	mA

HEATING: Indirect by A.C.; parallel supply

Heater voltage

V_f 6.3 V

Heater current

I_f 1 A

DIMENSIONS AND CONNECTIONS

Dimensions in mm

Base: Noval

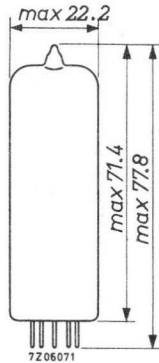
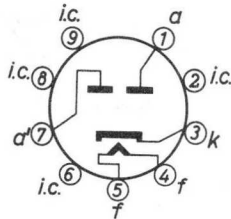

OPERATING CHARACTERISTICS

As two-phase half-wave rectifier with capacitor input filter See page 4 upper fig.

Transformer voltage	V_{tr}	2x250	2x350	2x450	V_{RMS}
D.C. output voltage	V_o	245	352	497	V
D.C. current	I_o	160	150	100	mA
Protecting resistance	R_t	2x150	2x230	2x310	Ω
Input capacitor of smoothing filter	C_{filt}	50	50	50	μF

As two-phase half-wave rectifier with choke input filter See page 4 lower fig.

Transformer voltage	V_{tr}	2x250	2x350	2x450	V_{RMS}
D.C. output voltage	V_o	199	288	378	V
D.C. current	I_o	180	180	150	mA
Choke	L	10	10	10	H

LIMITING VALUES (Design centre rating system)

Anode voltage, peak inverse	V_{ainvp}	max.	1300	V
D.C. current	I_o	See page 3		
Transformer voltage	V_{tr}	lower figure		
Anode current, peak	I_{ap}	max.	500	mA
surge	I_{asurge}	max.	1.8	A
Cathode to heater voltage, k pos	V_{kf}	max.	500	V
Input capacitor of smoothing filter	C_{filt}	max.	50	μF
Protecting resistance	R_t min.	See page 5		
Choke	L min.	See page 4 lower fig.		

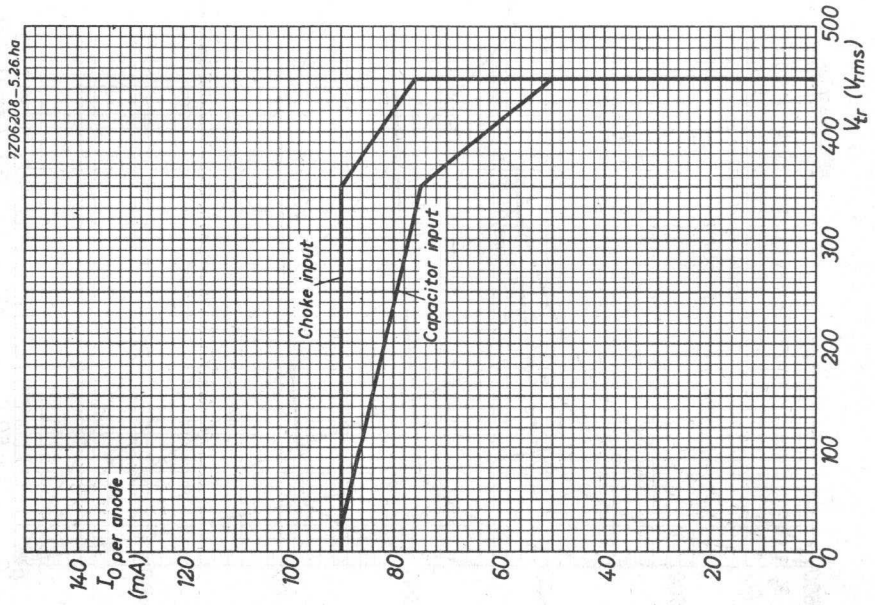
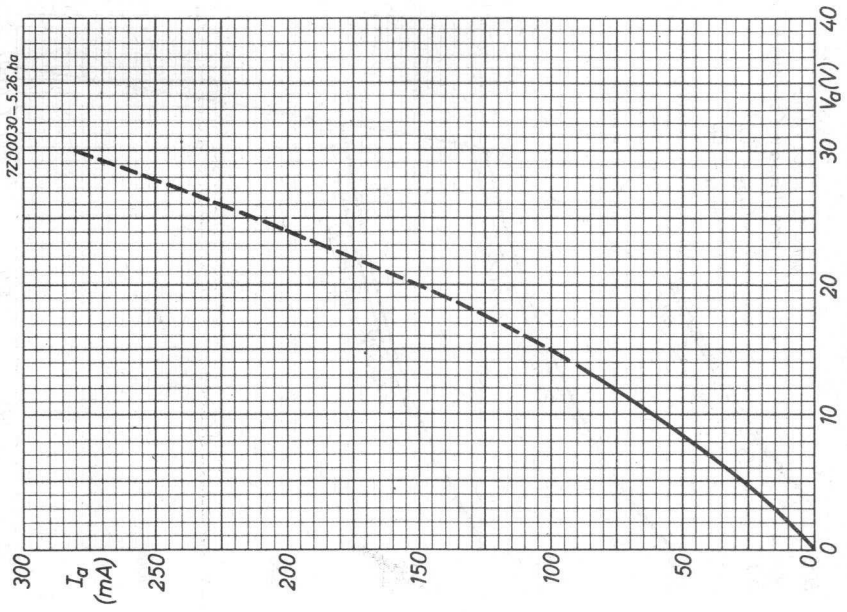

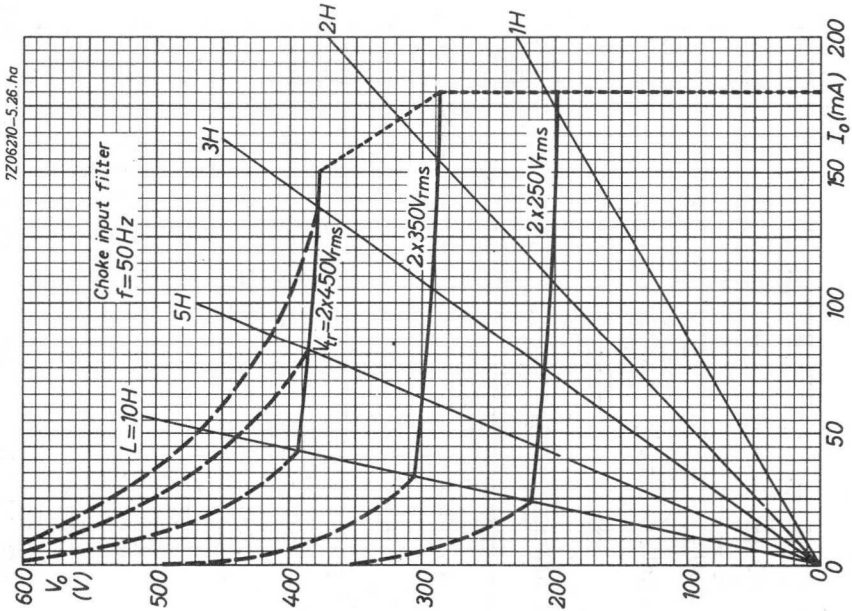
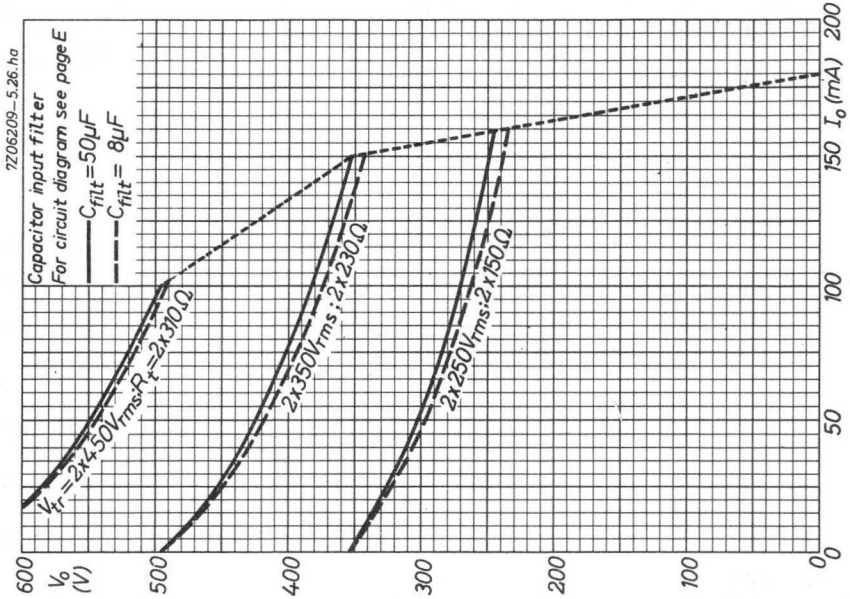

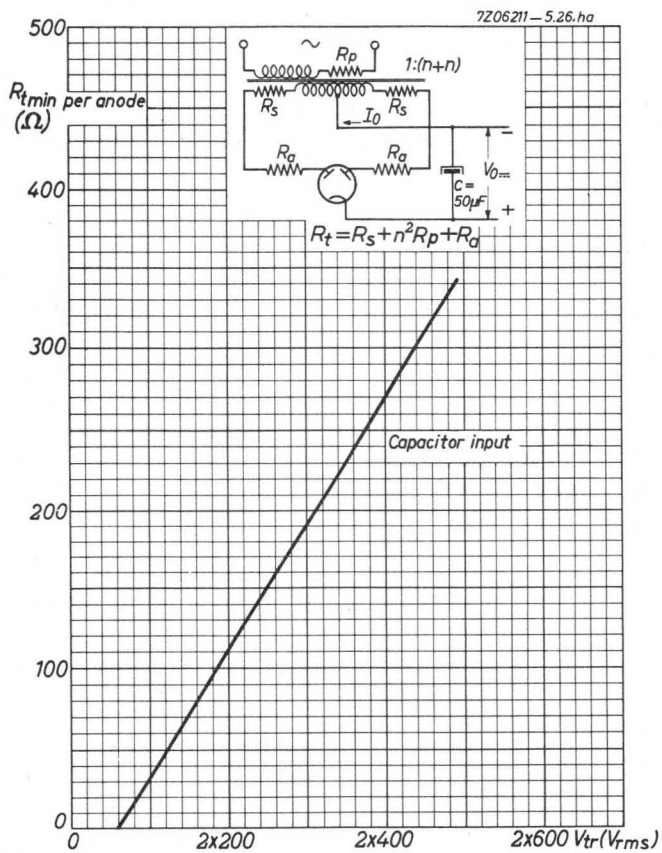

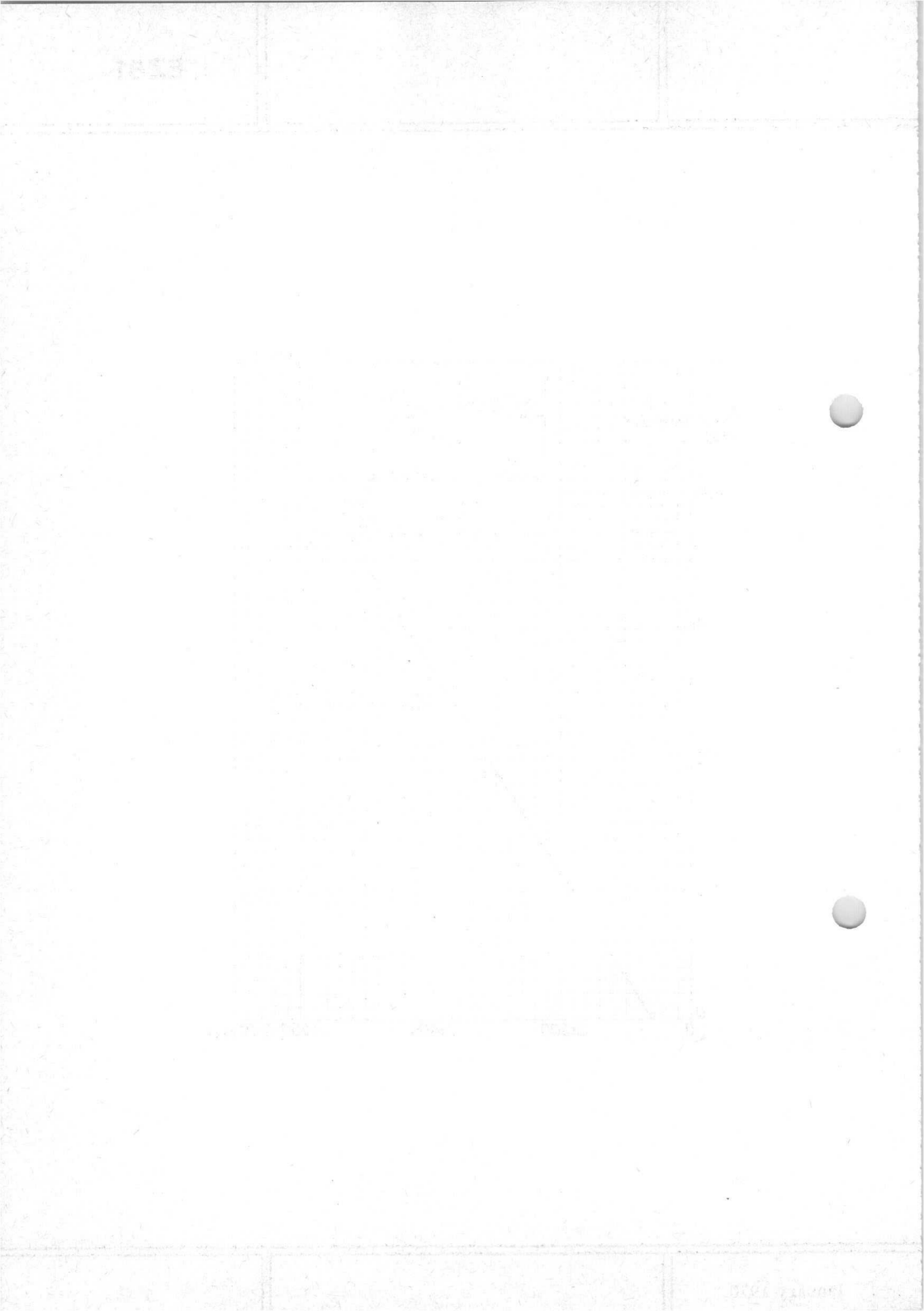

SINGLE ANODE E.H.T. RECTIFYING TUBE

Single anode E.H.T. rectifying tube intended for use in colour television receivers.

The GY501 has a chemically treated envelope to avoid flash-over under conditions of high humidity and low atmospheric pressure (45 cm Hg).

QUICK REFERENCE DATA		
D.C. output voltage	V_o	25 kV
Anode current	I_a	1.5 mA

HEATING: Indirect by A.C. or D.C.; parallel supply

Heater voltage	V_f	3.15 V ¹⁾
Heater current	I_f	400 mA

DIMENSIONS AND CONNECTIONS

Base: Magnoval

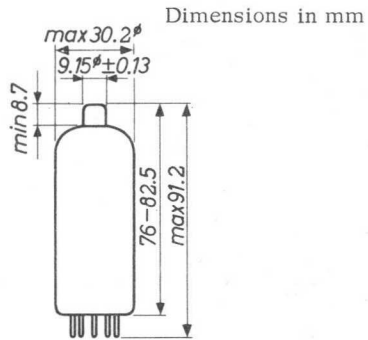
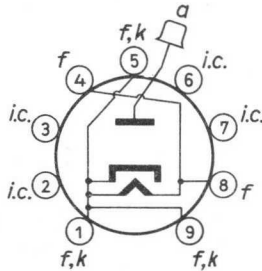

Pins 1, 5 and 9 may be used to connect an anti-corona ring.

Circuit elements having the same potential as the heater (e.g. a series resistor) may be connected to pins 3 and 7. These pins must never be earthed.

Precaution: X-ray shielding may be required to give protection against excessive radiation.

¹⁾ Under nominal operating conditions and with the longterm average value of I_a to be expected in practice, V_{fRMS} should be 3.15 V.

The heater voltage deviation resulting from spread or variation of operating conditions should be limited to the values indicated by the diagram in fig. A.

CAPACITANCES

Anode to cathode	C_{ak}	1.2 pF
------------------	----------	--------

OPERATING CHARACTERISTICS

Output voltage	V_o	25 kV
Anode current	I_a	1.5 mA

LIMITING VALUES (Design centre rating system)

Peak inverse voltage (absolute max.)	V_{ainvp}	max.	35 kV ¹⁾
Output voltage (absolute max.)	V_o	max.	27.5 kV
Output current, average	I_o	max.	1.7 mA
peak	I_{op}	max.	100 mA ²⁾

¹⁾ The negative peak due to ringing in the line output transformer should be taken into account.

Max. pulse duration 22% of a cycle and 18 μ s.

²⁾ Design max. rating system

Max. pulse duration 10% of a line scanning cycle with a max. of 10 μ s.

7Z04489-714.eja

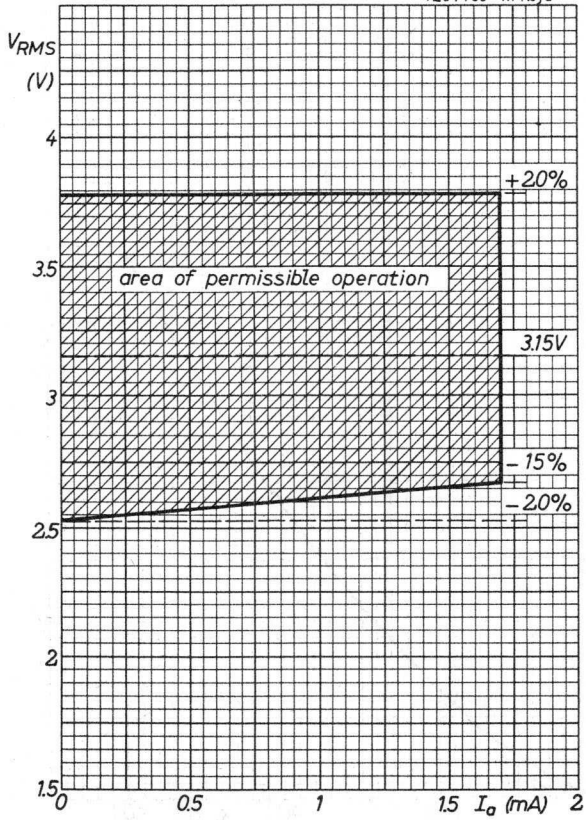

7203064-7.25.eja

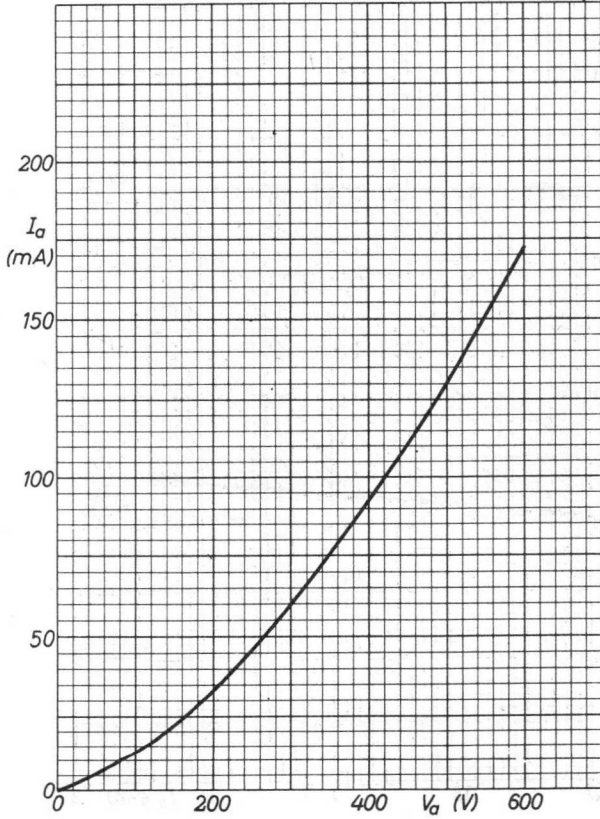

DOUBLE ANODE RECTIFYING TUBE

Double anode high vacuum rectifying tube.

QUICK REFERENCE DATA		
Transformer voltage	V_{tr}	2x450 V_{RMS}
D.C. current	I_o	250 mA

HEATING: Indirect by A.C.; parallel supply

Heater voltage	V_f	5 V
Heater current	I_f	1.9 A

DIMENSIONS AND CONNECTIONS

Dimensions in mm

Base: Octal

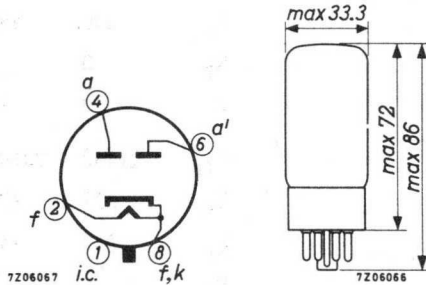

OPERATING CHARACTERISTICS

As two-phase half-wave rectifier with capacitor input

Transformer voltage	V_{tr}	2x300	2x350	2x400	V_{RMS}
D.C. output voltage	V_o	330	380	430	V
D.C. current	I_o	250	250	250	mA
Protecting resistance	R_t	2x75	2x100	2x125	Ω
Input capacitor of smoothing filter	C_{filt}	60	60	60	μF
Transformer voltage	V_{tr}	2x450	2x500	2x550	V_{RMS}
D.C. output voltage	V_o	480	560	640	V
D.C. current	I_o	250	200	160	mA
Protecting resistance	R_t	2x150	2x175	2x200	Ω
Input capacitor of smoothing filter	C_{filt}	60	60	60	μF

As two-phase half-wave rectifier with choke input

Transformer voltage	V_{tr}	2x300	2x350	2x400	V_{RMS}
D.C. output voltage	V_o	250	290	330	V
D.C. current	I_o	250	250	250	mA
Protecting resistor	R_t	0	0	0	Ω
Choke	L	10	10	10	H
Transformer voltage	V_{tr}	2x450	2x500	2x550	V_{RMS}
D.C. output voltage	V_o	375	420	465	V
D.C. current	I_o	250	250	225	mA
Protecting resistor	R_t	0	0	0	Ω
Choke	L	10	10	10	H

LIMITING VALUES (Design centre rating system)

See also page 4

Capacitor input

Anode voltage, peak inverse	$V_{a\ invp}$	max. 1500 V
D.C. current	I_o	max. See page 4
Anode peak current	I_{ap}	max. 750 mA
Input capacitor of smoothing filter	C_{filt}	max. 60 μF
Protecting resistance at transformer voltage	$R_{t\ min.}$	2x50 2x75 2x100 2x125 2x150 2x175 Ω 2x300 2x350 2x400 2x450 2x500 2x550 V_{RMS}

Choke input

Anode voltage, peak inverse	$V_{a\ invp}$	max. 1500 V
D.C. current	I_o	max. See page 4
Anode peak current	I_{ap}	max. 750 mA

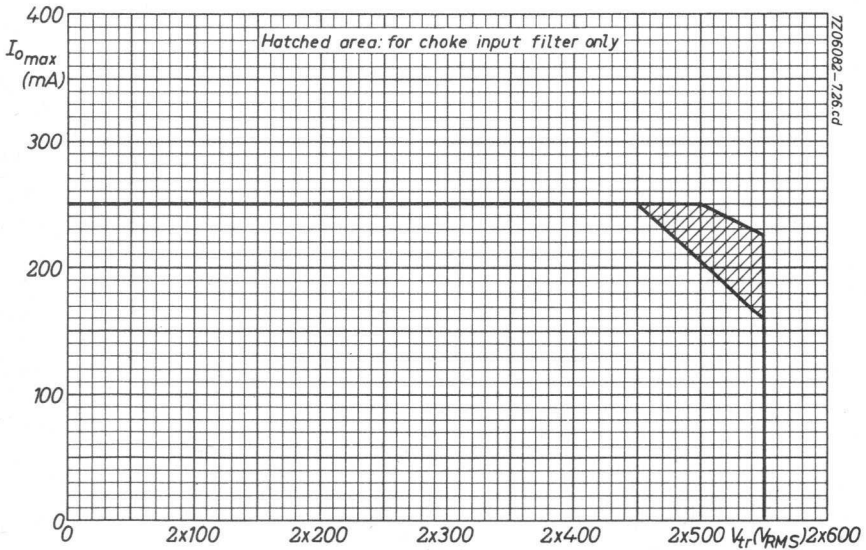
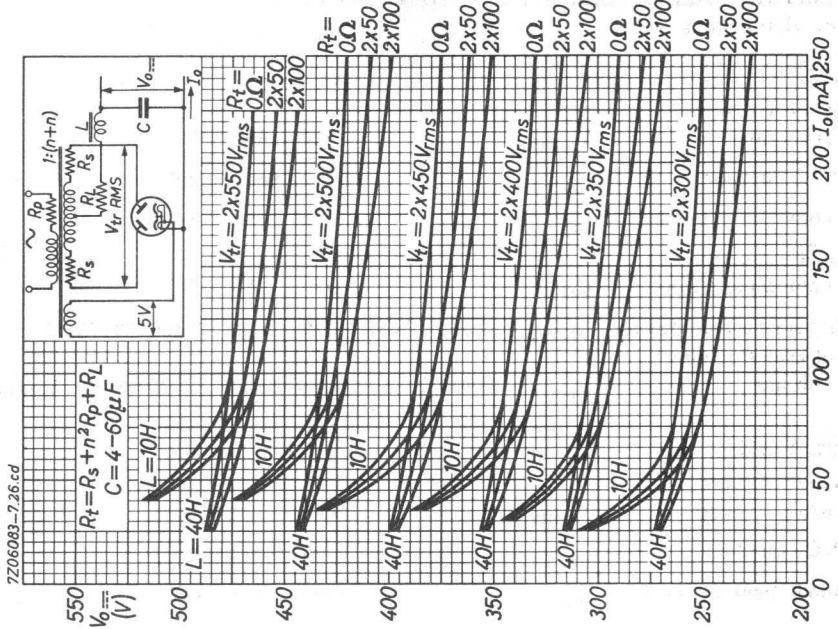

TRIPLE DIODE-TRIODE

Triple diode-triode, intended for video and FM and AM audio signal detection and A.F. signal amplification.

HEATING: Indirect by A.C. or D.C.; series supply

Heater current	I_f	<u>300</u>	mA
Heater voltage	V_f	9.5	V

For further data and curves
please refer to UABC80



U.H.F. TRIODE

Triode intended for use as grounded grid U.H.F. amplifier, oscillator or mixer for bands IV and V.

QUICK REFERENCE DATA

Anode current	I_a	12 mA
Transconductance	S	14 mA/V
Amplification factor	μ	68 -

HEATING: Indirect by A.C. or D.C.; series supply

Heater current	I_f	300 mA
Heater voltage	V_f	3.8 V

DIMENSIONS AND CONNECTIONS

Dimensions in mm

Base: Noval

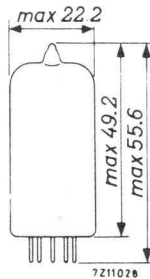
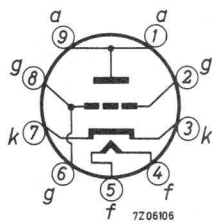

OPERATING CHARACTERISTICS

As grounded grid amplifier

Anode voltage	V_a	175 V
Cathode resistor	R_k	125 Ω
Anode current	I_a	12 mA
Transconductance	S	14 mA/V

As self-oscillating mixer

Supply voltage	V_{ba}	220 V
Anode resistor	R_a	5.6 k Ω
Grid resistor	R_g	47 k Ω
Anode current	I_a	12 mA
Grid current	I_g	50 μ A

LIMITING VALUES (Design centre rating system)

Anode voltage	V_{a0}	max. 550 V
	V_a	max. 220 V
Anode dissipation	W_a	max. 2.2 W
Cathode current	I_k	max. 20 mA
Grid voltage	$-V_g$	max. 50 V
Grid resistor	R_g	max. 1 M Ω
Cathode to heater voltage	$V_{kf(k \text{ pos})}$	max. 100 V ¹⁾

¹⁾ A.C. component max. 50 V_{RMS}.

CAPACITANCESWithout external shield

Anode to grid	C_{ag}	2.2 pF
Anode to cathode	C_{ak}	0.24 pF
Grid to cathode	C_{gk}	3.5 pF
Grid to heater	C_{gf}	0.27 pF
Cathode to grid + heater	$C_{k/gf}$	6.3 pF
Grid to cathode + heater	$C_{g/kf}$	3.8 pF
Anode to cathode + heater	$C_{a/kf}$	0.35 pF
Anode to grid + heater	$C_{a/gf}$	2.3 pF

With external shield

Anode to grid + screen	$C_{a/gs}$	3.3 pF
Cathode + heater to grid + screen	$C_{kf/gs}$	4.1 pF
Anode to cathode + heater	$C_{a/kf}$	0.3 pF

TYPICAL CHARACTERISTICS

Anode voltage	V_a	175 V
Grid voltage	V_g	-1.5 V
Anode current	I_a	12 mA
Transconductance	S	14 mA/V
Amplification factor	μ	68 -
Equivalent noise resistance	R_{eq}	230 Ω
Increase C_g	ΔC_g	2 pF ¹⁾

¹⁾ Difference between C_g of cold and hot tube.

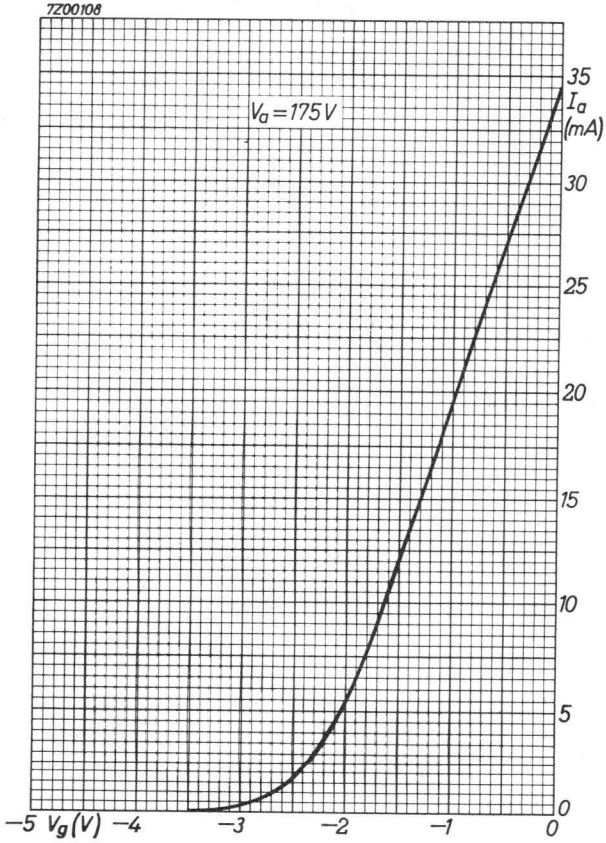

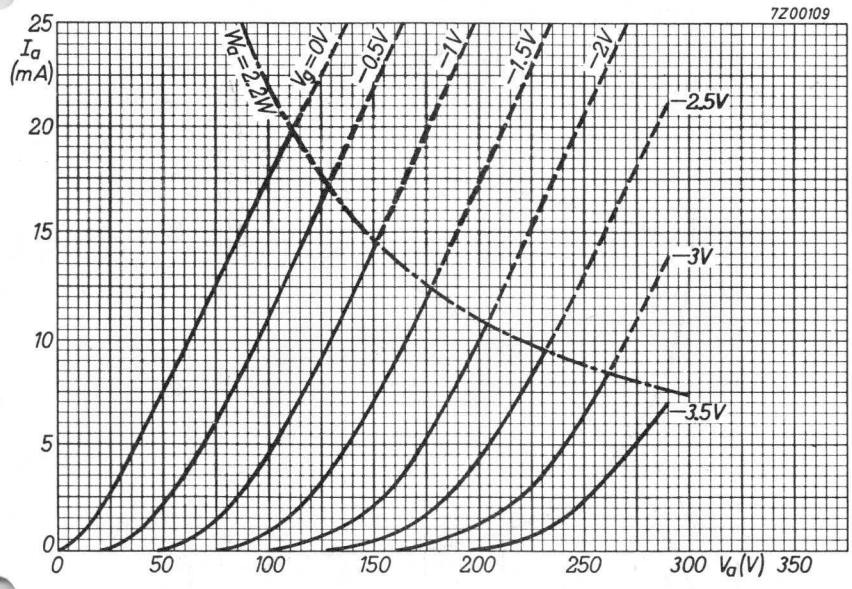

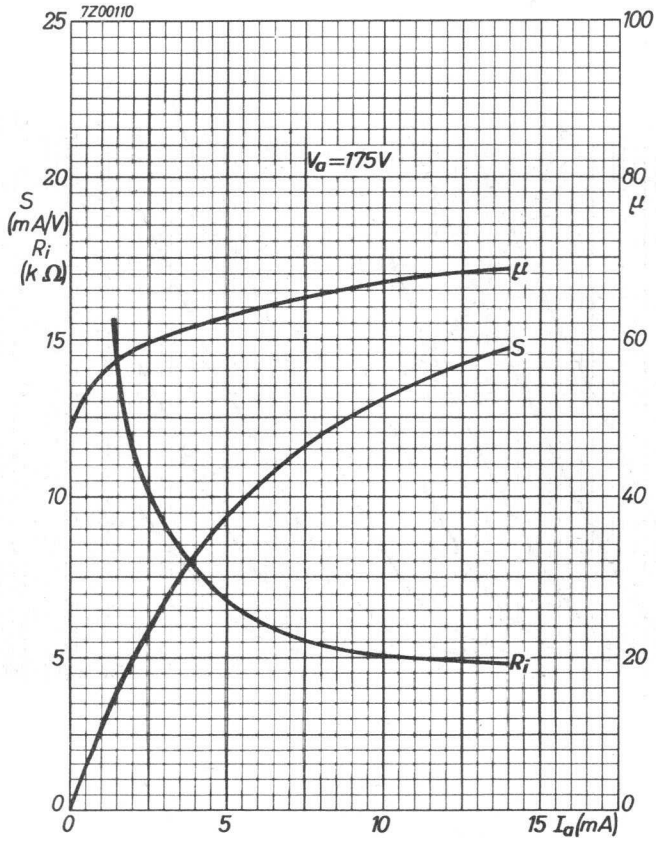

U.H.F. TRIODE

Triode intended for use as grounded grid U.H.F. amplifier for bands IV and V.

QUICK REFERENCE DATA		
Anode current	I_a	12.5 mA
Transconductance	S	13.5 mA/V
Amplification factor	μ	65

HEATING: Indirect by A.C. or D.C.; series supply

Heater current	I_f	300 mA
Heater voltage	V_f	3.8 V

DIMENSIONS AND CONNECTIONS

Dimensions in mm

Base: Noval

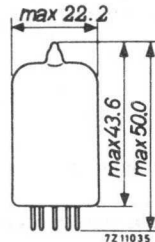
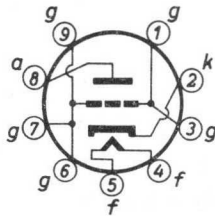

CAPACITANCES

Without external screen

Anode to grid	C_{ag}	1.2 pF
---------------	----------	--------

With external screen (inside diameter 22.2 mm)

Anode to grid	C_{ag}	1.7 pF
Grid to anode + cathode	$C_{g/kf}$	3.8 pF
Anode to heater + cathode	$C_{a/kf}$	0.055 pF

TYPICAL CHARACTERISTICS

Anode voltage	V_a	160 V	1)
Cathode resistor	R_k	100 Ω	1)
Anode current	I_a	12.5 mA	
Transconductance	S	13.5 mA/V	
Amplification factor	μ	65	
Equivalent noise resistance	R_{eq}	240 Ω	
Noise figure at $f = 850$ MHz	F	10 dB	
Anode voltage	V_a	0 V	
Grid current, positive	I_g	0.3 μ A	
Grid voltage	$-V_g$	max. 1.3 V	

Series resonance frequencies

Measured between a point on the relevant tube pin close to the tube bottom and a point close to the relevant pin on a metal reference plane, placed against the tube bottom.

All the pins, except the relevant one, are connected to the reference plane with a negligible impedance.

The tube is screened by a metal screen with an inside diameter of 22.2 mm placed upon the metal reference plane.

Heater voltage	V_f	0 V
Anode voltage	V_a	0 V
Anode resonance frequency	f_{0a}	1700 MHz
Cathode resonance frequency	f_{0k}	1000 MHz

LIMITING VALUES (Design centre rating system)

Anode voltage	V_{a0}	max. 550 V	
	V_a	max. 175 V	
Anode dissipation	W_a	max. 2 W	
Cathode current	I_k	max. 13 mA	
Grid voltage	$-V_g$	max. 50 V	
Grid resistor ($R_k = 100 \Omega$)	R_g	max. 1 $M\Omega$	
Cathode to heater voltage	V_{kf}	max. 100 V	1)

1) To fulfil the modulation hum requirements, the A.C. component should not exceed 50 V_{RMS} .

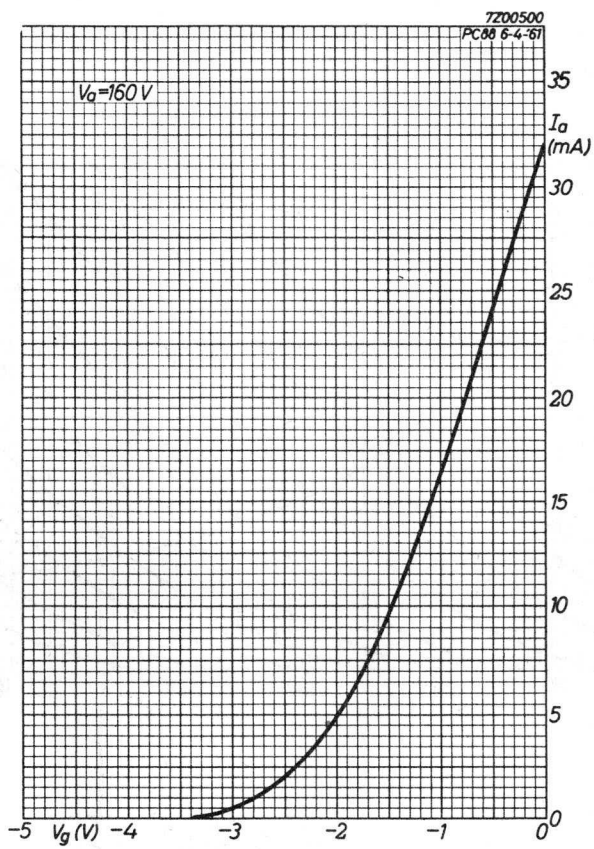

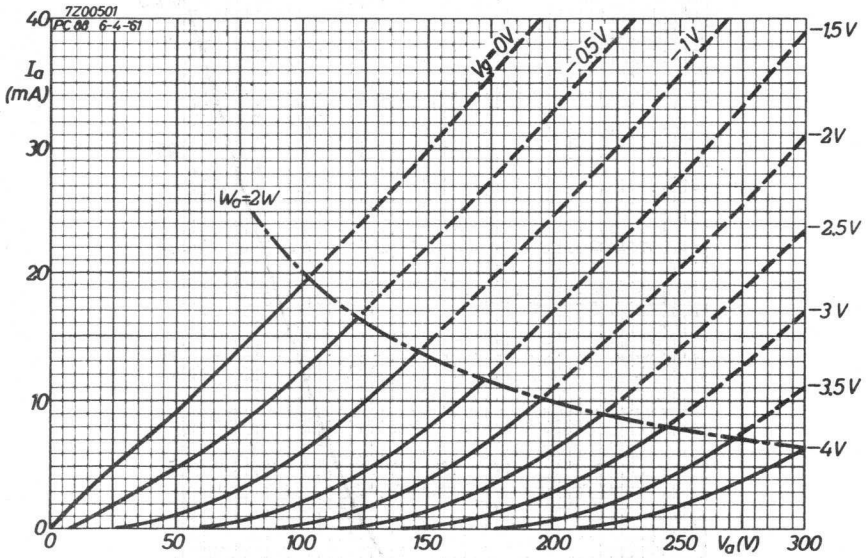

H.F. TRIODE

Triode intended for use as H.F. amplifier, oscillator, mixer and in frame deflection circuits and line deflection circuits of TV receivers.

QUICK REFERENCE DATA			
Anode current	I_a	12	mA
Transconductance	S	7.2	mA/V
Amplification factor	μ	67	-

HEATING: Indirect by A.C. or D.C.; series supply

Heater current	I_f	300	mA
Heater voltage	V_f	3.1	V

DIMENSIONS AND CONNECTIONS

Dimensions in mm

Base: 7 pin miniature

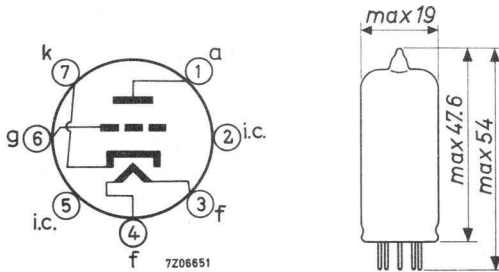

LIMITING VALUES (Design centre rating system)

Anode voltage	V_{a0}	max.	550 V
	V_a	max.	250 V
Anode dissipation	W_a	max.	2.5 W
Grid voltage	$-V_g$	max.	50 V
Cathode current, average	I_k	max.	15 mA
peak	I_{kp}	max.	150 mA ³⁾
Cathode to heater voltage (k pos.)	V_{kf}	max.	250 V ¹⁾
(k neg.)	V_{kf}	max.	250 V
		(D.C. component max.)	100 V
Grid resistor (automatic bias)	R_g	max.	1 MΩ

OPERATING CONDITIONS AS BLOCKING OSCILLATOR

To take into account the tube tolerances, the decrease of the characteristics during life and the decrease of the emission at underheating, the circuit should be designed so that acceptable performance is obtained with a cathode peak current of 100 mA ²⁾ (150 mA ³⁾). It is recommended to limit the peak current of new tubes by an automatic amplitude limiting circuit e.g. by the use of non by-passed grid and anode resistors.

¹⁾ During the warm-up period of the tubes V_{kf} (k pos.) (D.C. component) max. 315 V.

²⁾ Pulse duration 4% of a cycle and max. 0.8 ms.

³⁾ Pulse duration 1% of a cycle and max. 0.2 ms.

CAPACITANCESGrounded cathode circuitwithout external shield

Input	C_i	2.8 pF
Output	C_o	0.55 pF
Anode to grid	C_{ag}	1.8 pF

With external shield 19.5 mm diameter

Anode to cathode, heater and shield	$C_{a/kfs}$	1.4 pF
Cathode to grid, heater and shield	$C_{k/gfs}$	4.7 pF
Anode to grid, heater and shield	$C_{a/gfs}$	2.9 pF

Grounded grid circuitwithout external shield

Input	C_i	4.6 pF
Output	C_o	2.0 pF
Anode to cathode	C_{ak}	0.24 pF
Cathode to heater	C_{kf}	2.0 pF
Grid to heater	C_{gf}	max. 0.15 pF

TYPICAL CHARACTERISTICS

Anode voltage	V_a	100	170	200	230	V
Grid voltage	V_g	-0.9	-1.0	-0.9	-1.6	V
Anode current	I_a	3.0	8.5	12.0	10.5	mA
Transconductance	S	3.8	6.0	7.2	6.0	mA/V
Amplification factor	μ	58	65	67	62	-
Equivalent noise resistance	R_{eq}		0.5	0.4	0.5	k Ω

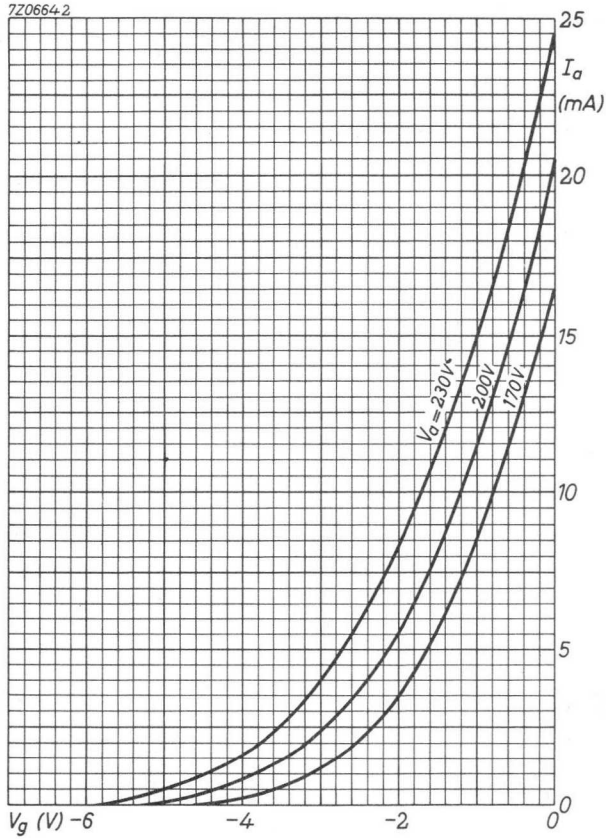

V.H.F. TRIODE

Triode intended for use as R.F. amplifier in V.H.F. television receivers.

QUICK REFERENCE DATA

Cathode current	I_k max.	20 mA
Transconductance	S	20 mA/V
Amplification factor	μ	84

HEATING: Indirect by A.C. or D.C.; series supply

Heater current	I_f	300 mA
Heater voltage	V_f	3.9 V

DIMENSIONS AND CONNECTIONS

Dimensions in mm

Base: Miniature 7p

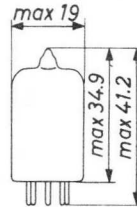
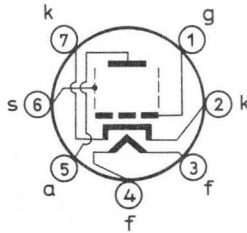

CAPACITANCES (with external shield, internal diameter 19.1 mm, connected to cathode)

Anode to all except grid	$C_{a(g)}$	3.0 pF
Grid to all except anode	$C_{g(a)}$	4.5 pF
Anode to grid	C_{ag}	0.365 pF
Anode to cathode	C_{ak}	0.08 pF
Grid to cathode	C_{gk}	3.3 pF
Grid to heater	C_{gf}	max. 0.07 pF
Cathode to heater	C_{kf}	2.3 pF

TYPICAL CHARACTERISTICS

Anode voltage	V_a	135			V
Shield voltage	V_s	0			V
Grid voltage	V_g	-1	-2.8	-5.9	V
Anode current	I_a	11.5	-	-	mA
Transconductance	S	14.5	1.45	0.145	mA/V
Amplification factor	μ	76	-	-	

OPERATING CHARACTERISTICS

Anode supply voltage	V_{ba}	135	200	200	V
Anode resistor	R_a	1.5	5.6	5.6	k Ω
Shield voltage	V_s	0	0	0	V
Cathode resistor	R_k	0	0	87	Ω
Anode current	I_a	16.5	16.5	11.5	mA
Grid current	I_g	20	20	-	μ A
Transconductance	S	20	20	14.5	mA/V
Amplification factor	μ	84	84	76	
{ Transconductance { Grid voltage	S	2	2	1.45	mA/V
	V_g	-2.3	-3.2	-3.8	V
{ Transconductance { Grid voltage	S	0.2	0.2	0.145	mA/V
	V_g	-5.3	-7.7	-8.3	V

LIMITING VALUES (Design centre rating system)

Anode voltage	V_{a0}	max. 550 V
	V_a	max. 200 V
Anode dissipation	W_a	max. 2.2 W
Cathode current	I_k	max. 20 mA
Negative grid voltage	$-V_g$	max. 50 V
Grid resistor	R_g	max. 1 $M\Omega$
Grid resistor in A.G.C. circuits	R_g	max. 3 $M\Omega$
Cathode to heater voltage	V_{kf}	max. 100 V ¹⁾

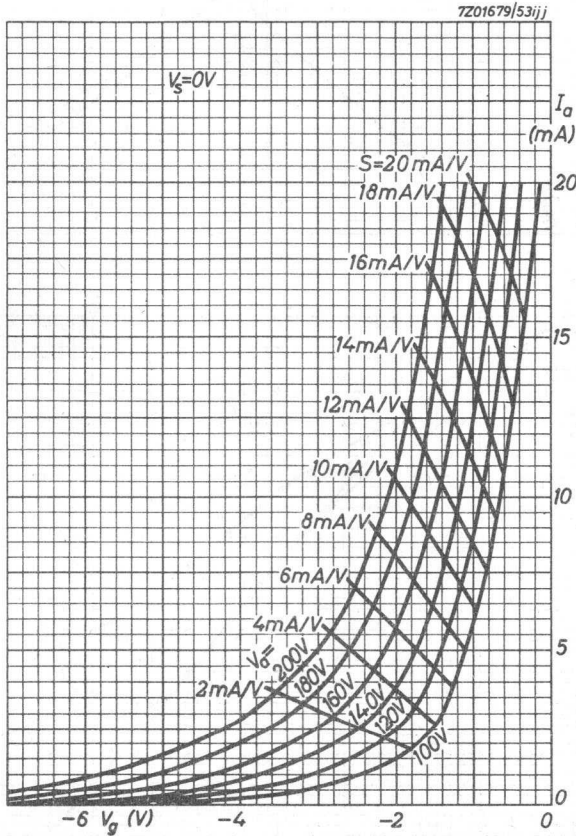

¹⁾ To fulfil the modulation hum requirements, V_{kf} should not exceed 55 VRMS.

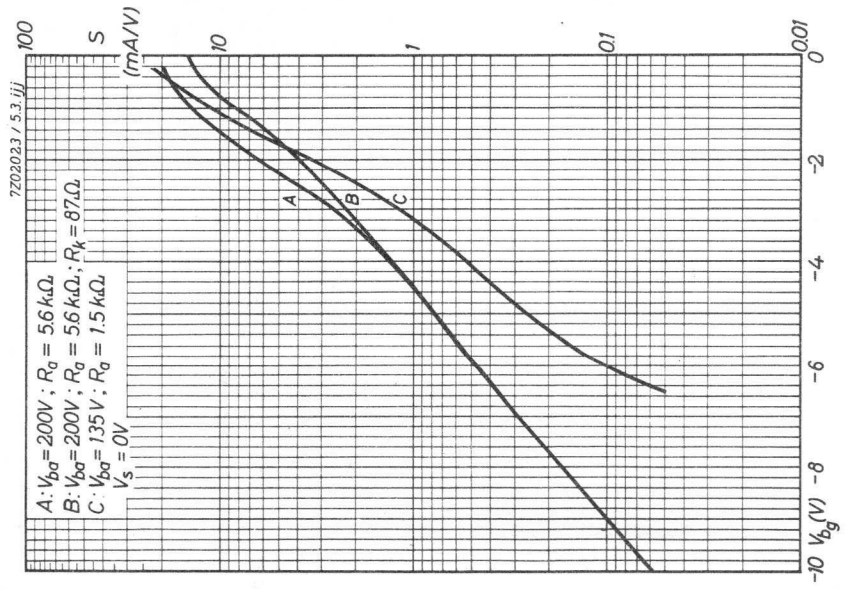
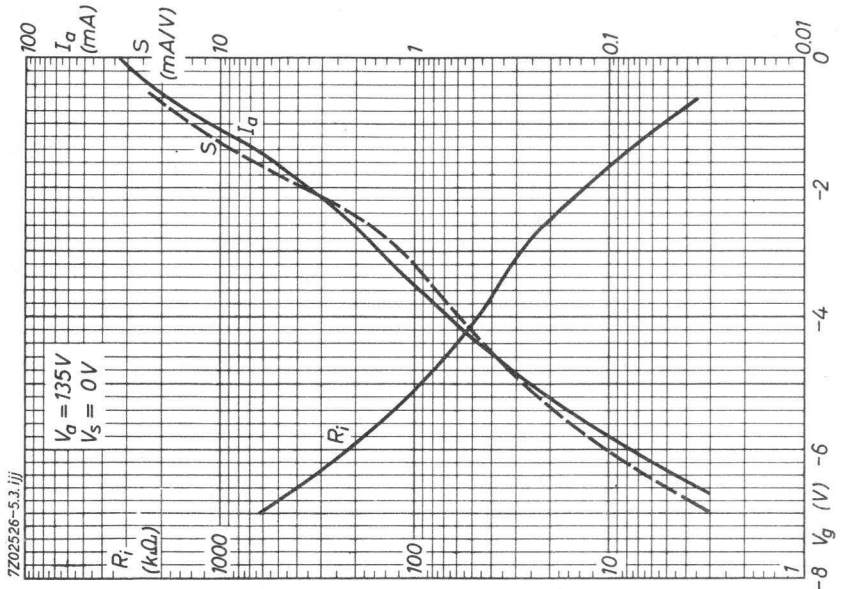

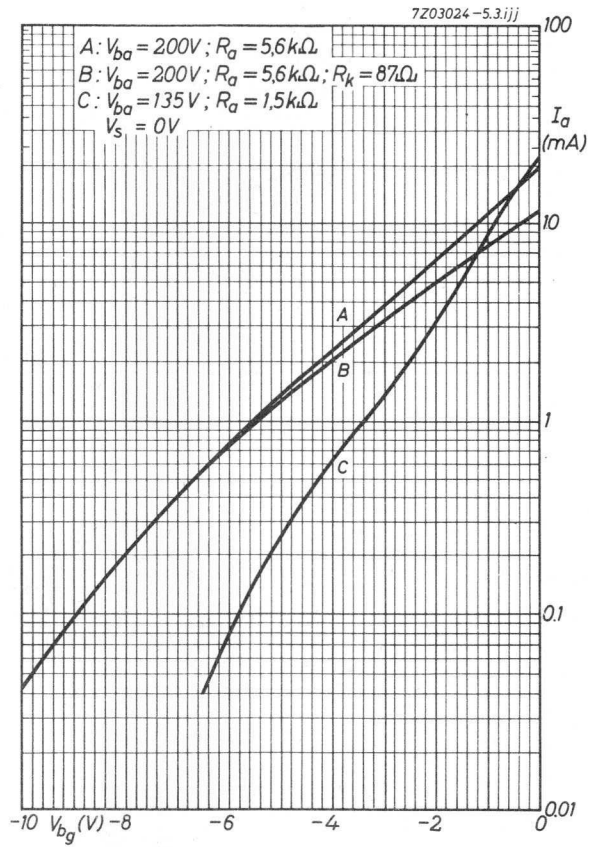

7Z02525-5.3.ijj

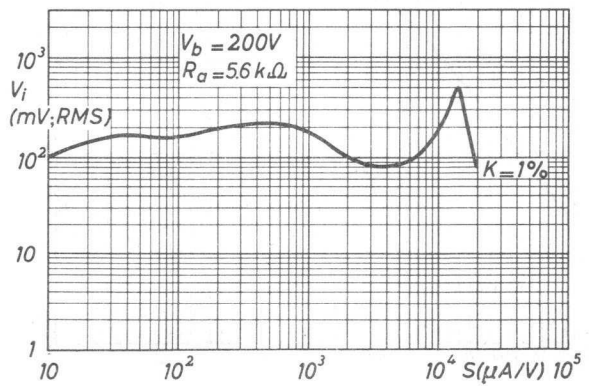
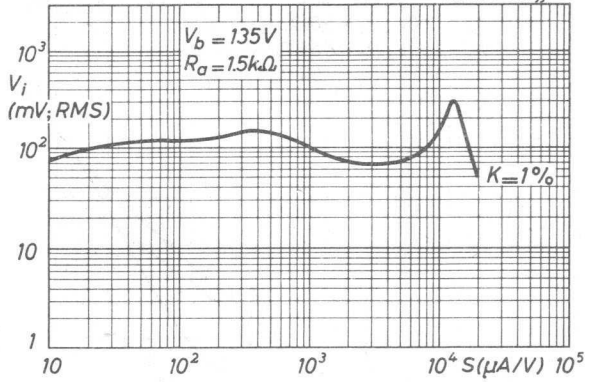

R.F. DOUBLE TRIODE

Double triode intended for various applications in television receivers.

QUICK REFERENCE DATA			
Anode current	I_a	10	mA
Transconductance	S	6.7	mA/V
Amplification factor	μ	48	-

HEATING: Indirect by A.C. or D.C.; series supply

Heater current	I_f	300	mA
Heater voltage	V_f	9.0	V

DIMENSIONS AND CONNECTIONS

Dimensions in mm

Base: Noval

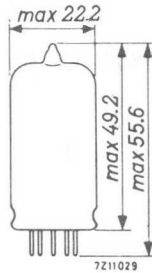
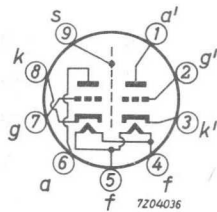

CAPACITANCES (each unit unless otherwise specified)

Anode to grid	C_{ag}	1.5	pF
Anode to cathode	C_{ak}	0.18	pF
Anode to cathode + heater + screen	$C_{a/kfs}$	1.2	pF
Grid to cathode + heater + screen	$C_{g/kfs}$	3.1	pF
Anode to cathode + heater + screen (measured with external screen of 22.5 mm diam.)	$C_{a/kfs}$	1.8	pF
Anode to anode other unit	$C_{aa'}$	max. 0.04	pF
Anode to anode other unit (measured with external screen of 22.5 mm diam.)	$C_{aa'}$	max. 0.008	pF
Grid to grid other unit	$C_{gg'}$	max. 0.003	pF
Anode to grid other unit	$C_{ag'}$	max. 0.008	pF
Anode to grid other unit	$C_{a'g}$	max. 0.008	pF
Anode to cathode other unit	$C_{ak'}$	max. 0.008	pF
Anode to cathode other unit	$C_{a'k}$	max. 0.008	pF
Grid to cathode other unit	$C_{gk'}$	max. 0.003	pF
Grid to cathode other unit	$C_{g'k}$	max. 0.003	pF

TYPICAL CHARACTERISTICS (each unit)

Anode voltage	V_a	100	170	200	V
Grid voltage	V_g	-1.2 ¹⁾	-1.75	-2.4	V
Anode current	I_a	4.5	10	10	mA
Transconductance	S	4.8	6.7	6	mA/V
Amplification factor	μ	46	48	46	

REMARK

Microphony

This tube can be used without special precautions against microphony in A.F. applications in which the input voltage $V_i \geq 5$ mV for an output of 50 mW (or 50 mV for an output 5 W) provided the peak acceleration of the tube is not greater than indicated in the section "Microphony" of the "General Operational Recommendations".

¹⁾ In this case grid current may occur. If this is not permissible, a condition with a bias of -1.5 V should be chosen.

OPERATING CHARACTERISTICS (each unit)

As self-oscillating additive mixer

Anode supply voltage	V_b	100	170	200	V
Anode resistor	R_a	4.7	4.7	8.2	$k\Omega$
Grid resistor	R_g	1	1	1	$M\Omega$
Oscillator voltage	$V_{osc.}$	1.8	2.8	2.8	V_{RMS}
Anode current	I_a	2.7	5.5	6	mA
Conversion conductance	S_c	2.2	2.8	2.9	mA/V
Internal resistance	R_i	19	15	14	$k\Omega$
Grid input resistance (f = 100 MHz)	r_g		15		$k\Omega$

As oscillator in television receivers

Anode supply voltage	V_b		180	V
Anode resistor	R_a		4.4	$k\Omega$
Grid resistor	R_g		22	$k\Omega$
Oscillator voltage	$V_{osc.}$		9	V_{RMS}
Anode current	I_a		7.4	mA
Anode dissipation	W_a		1.2	W

LIMITING VALUES (each unit) (Design centre rating system)

Anode voltage	V_{a0}	max.	550	V
	V_a	max.	250	V
Anode dissipation	W_a	max.	2.5	W
Anode dissipation, total	$W_{a+} W_{a'}$	max.	4.5	W
Cathode current	I_k	max.	15	mA
Cathode to heater voltage	V_{kf}	max.	90	V
Grid voltage, negative	$-V_g$	max.	100	V
Grid resistor	R_g	max.	1	$M\Omega$

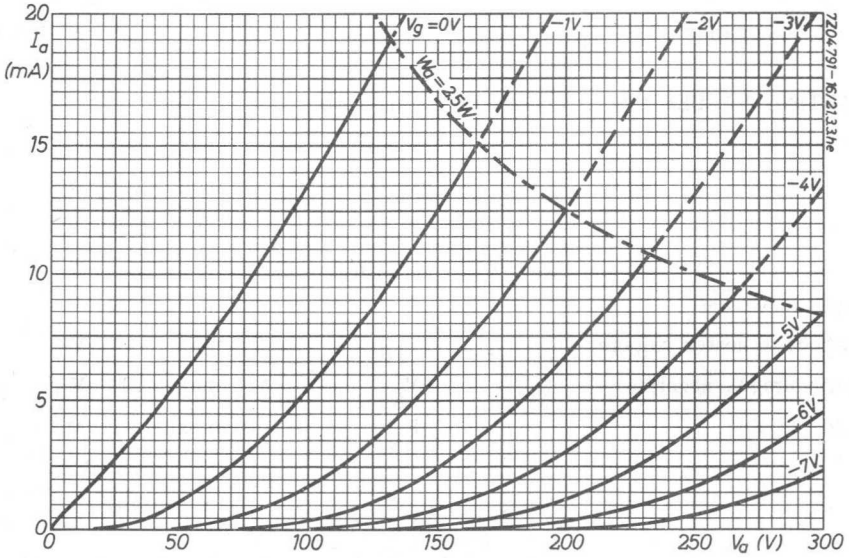
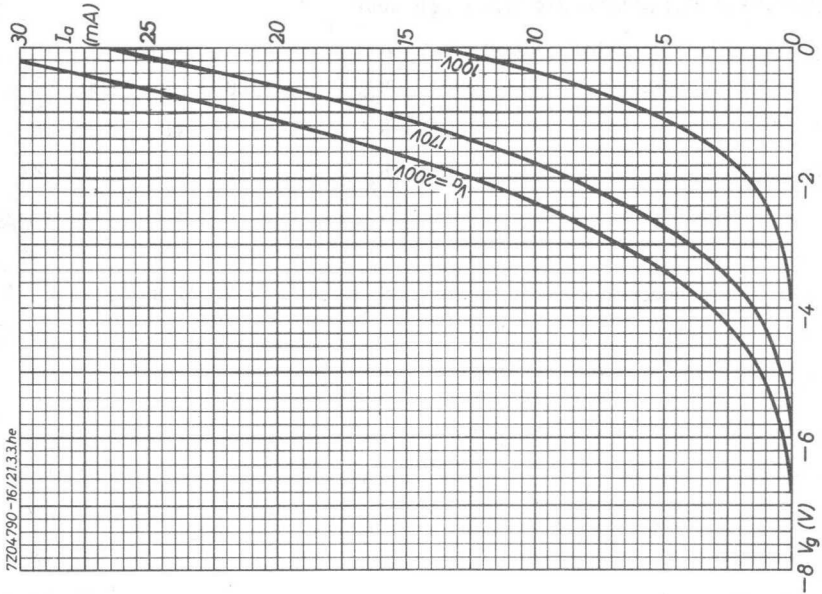

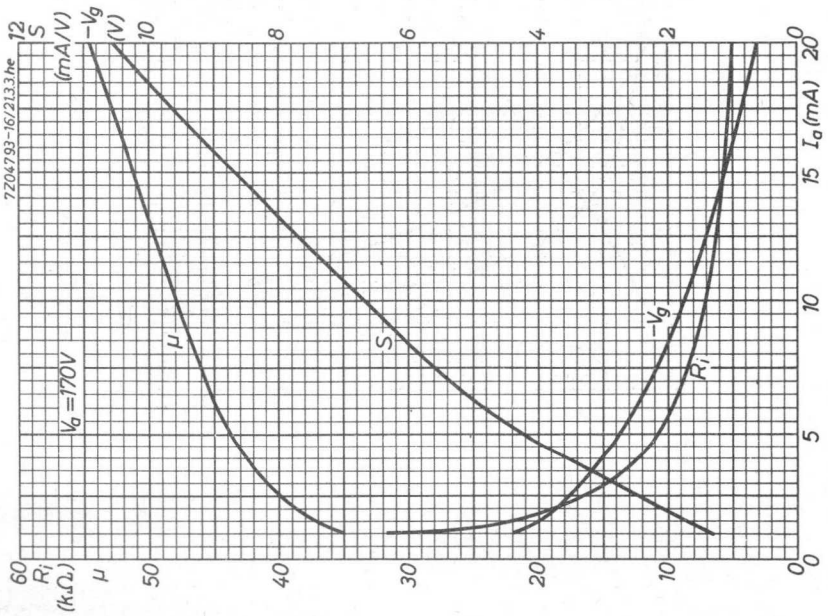
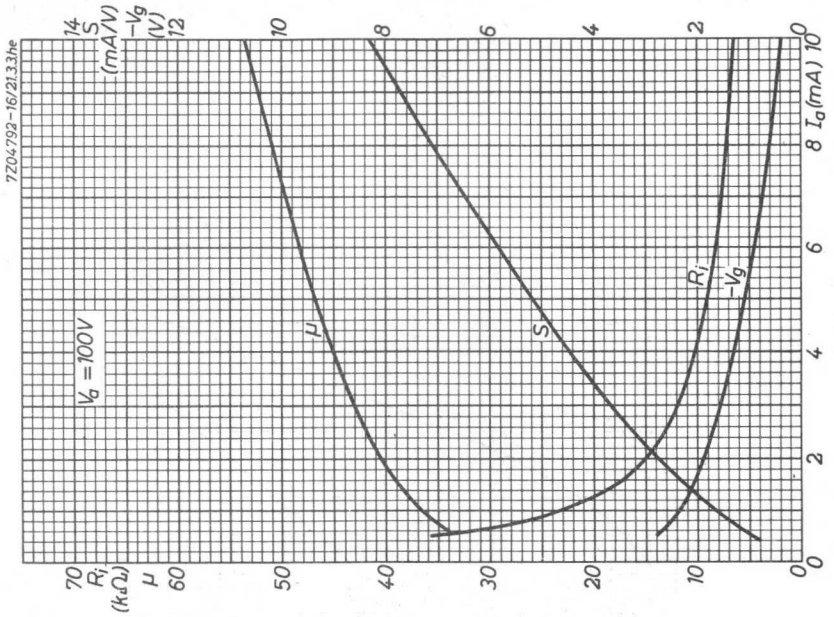

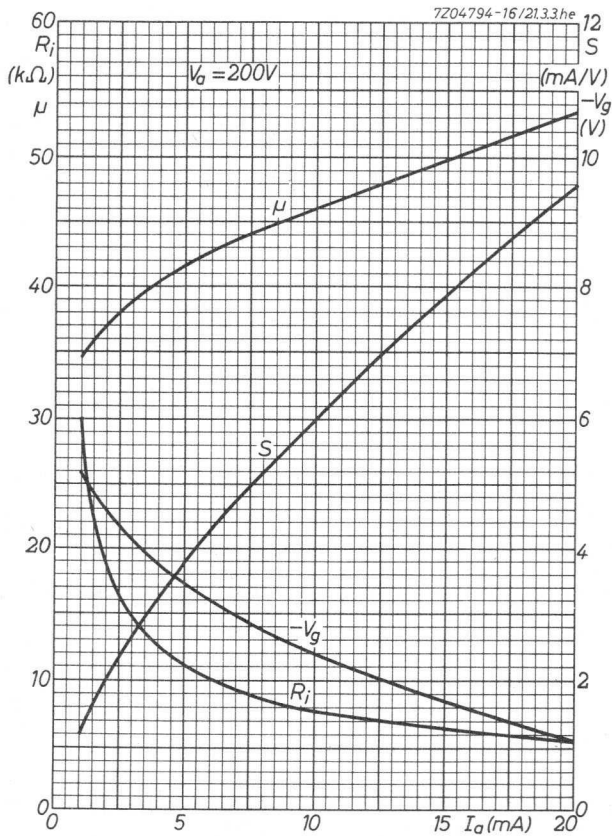

R.F. DOUBLE TRIODE

Double triode intended for use as cascode amplifier in television tuners.

QUICK REFERENCE DATA (Each unit)		
Anode current	I_a	15 mA
Transconductance	S	12.5 mA/V
Amplification factor	μ	33 -

HEATING: Indirect by A.C. or D.C.; series supply

Heater current

I_f 300 mA

Heater voltage

V_f 7.6 V

DIMENSIONS AND CONNECTIONS

Dimensions in mm

Base: Noval

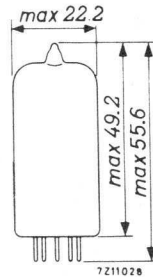
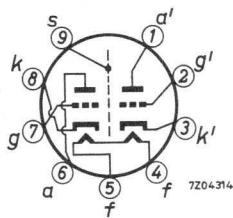

CAPACITANCES

		without external screen	with external screen
Anode to grid	C_{ag}	1.4	1.4 pF
Grid to cathode + heater + screen	$C_{g/kfs}$	3.3	3.3 pF
Anode to cathode + heater + screen	$C_{a/kfs}$	1.8	2.5 pF
Grid to heater	C_{gf}	0.13	0.13 pF
Anode to grid	$C_{a'g'}$	1.4	1.4 pF
Cathode to grid + heater + screen	$C_{k'/g'fs}$	6	6 pF
Anode to grid + heater + screen	$C_{a'/g'fs}$	2.8	3.7 pF
Cathode to heater	$C_{k'f}$	2.7	2.7 pF
Anode to cathode	$C_{a'k'}$	0.18	0.16 pF
Anode to anode	$C_{aa'}$	max. 0.045	max. 0.015 pF
Grid to anode other unit	$C_{ga'}$	max. 0.005	max. 0.005 pF

REMARK

The unit a, g, k should be used as the grounded cathode input section and unit a', g', k' as the grounded grid output unit.

TYPICAL CHARACTERISTICS

Anode voltage	V_a	90 V
Grid voltage	V_g	-1.3 V
Anode current	I_a	15 mA
Transconductance	S	12.5 mA/V
Amplification factor	μ	33 -
Equivalent noise resistance	R_{eq}	300 Ω

LIMITING VALUES (Design centre rating system) (each unit, unless otherwise stated)

Anode voltage	V_{a0}	max.	550 V
	V_a	max.	130 V
Anode dissipation	W_a	max.	1.8 W
Cathode current	I_k	max.	25 mA
Grid voltage	$-V_g$	max.	50 V
Grid resistor	R_g	max.	1 M Ω
Cathode to heater voltage	V_{kf}	max.	50 V
	$V_{k'f(k'pos)}$	max.	150 V ¹⁾

REMARK

In order not to exceed the maximum permissible anode voltage when the cascode amplifier is controlled, it is necessary to use a voltage divider for the grid of the grounded grid section. With grid current biasing for the grounded cathode section the anode voltage across this section should not be more than 75 V in the not controlled condition.

¹⁾ D.C. component max. 130 V.

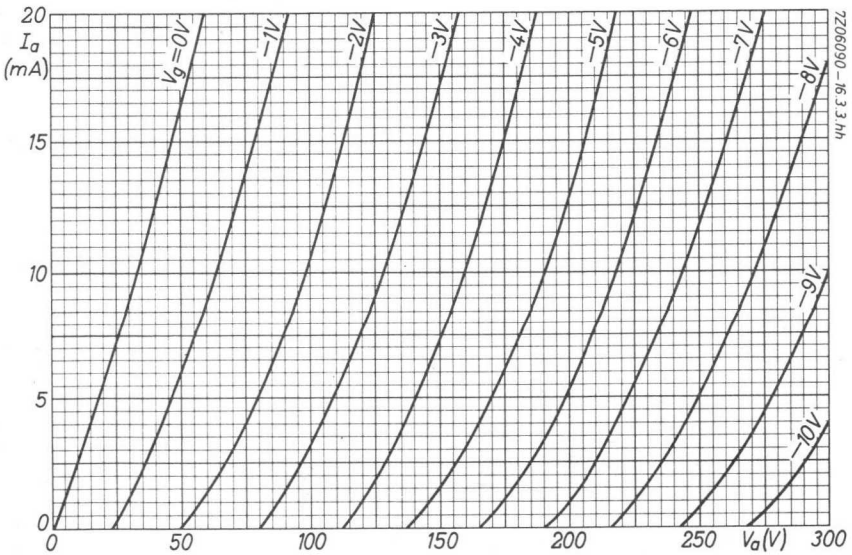
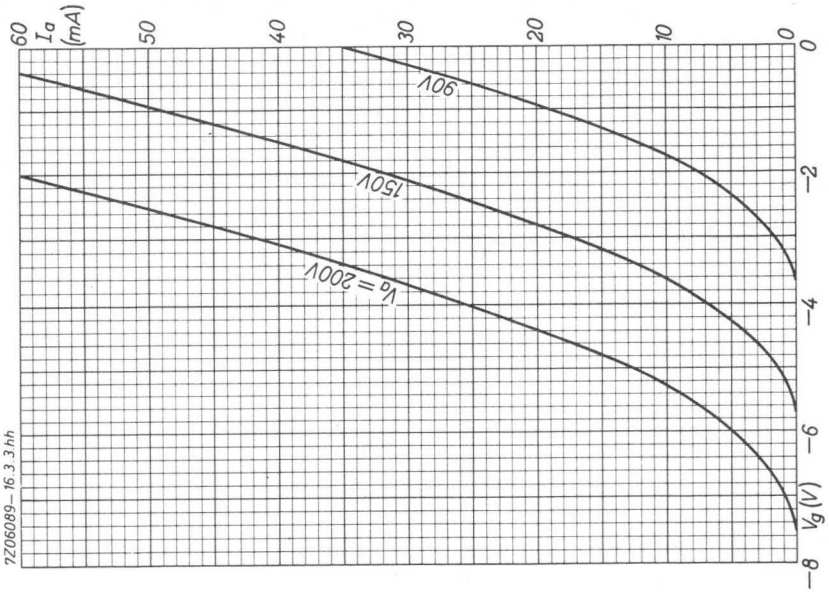

R.F. DOUBLE TRIODE

Double triode with variable transconductance intended for use as V.H.F. cascade amplifier in television receivers.

QUICK REFERENCE DATA

Anode current	I_a	15	mA
Transconductance	S	12.5	mA/V
Amplification factor	μ	31	-

HEATING: Indirect by A.C. or D.C.; series supply

Heater current	I_f	300	mA
Heater voltage	V_f	7.6	V

DIMENSIONS AND CONNECTIONS

Dimensions in mm

Base: Noval

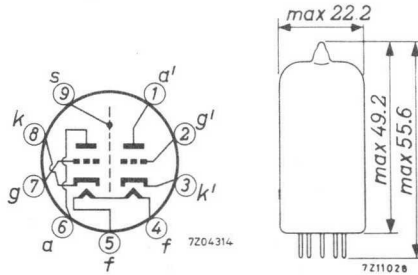

CAPACITANCES

		with external screen 22.2 mm diam.	without external screen
Grid to cathode + heater + screen	$C_{g/kfs}$	3.5	3.5 pF
Anode to cathode + heater + screen	$C_{a/kfs}$	2.3	1.7 pF
Anode to grid	C_{ag}	1.9	1.9 pF
Grid to heater	C_{gf}	max. 0.28	max. 0.28 pF
Cathode to grid + heater + screen	$C_{k'/g'fs}$	6.0	6.0 pF
Anode to grid, heater + screen	$C_{a'/g'fs}$	4.0	3.4 pF
Anode to cathode	$C_{a'k'}$	0.17	0.18 pF
Cathode to heater	$C_{k'f}$	2.7	2.7 pF
Anode to grid	$C_{a'g'}$	1.9	1.9 pF
Anode to anode	$C_{aa'}$	max. 0.015	max. 0.045 pF
Grid to anode other unit	$C_{ga'}$	max. 0.004	max. 0.004 pF

TYPICAL CHARACTERISTICS (each unit)

Anode voltage	V_a	90 V	
Grid voltage	V_g	-1.4 V	
Anode current	I_a	15 mA	
Transconductance	S	12.5 mA/V	
Internal resistance	R_i	2.5 k Ω	
{	Grid voltage	V_g	-5 V
	Transconductance	S	0.625 mA/V
{	Grid voltage	V_g	-9 V
	Transconductance	S	0.125 mA/V

LIMITING VALUES (Design centre rating system) (Each unit)

Anode voltage	V_{a0}	max.	550 V
	V_a	max.	130 V
Anode dissipation	W_a	max.	1.8 W
Grid voltage	$-V_g$	max.	50 · V
Grid resistor			
unit a, g, k	R_g	max.	1 M Ω
unit a', g', k'	$R_{g'}$	max.	0.5 M Ω
Cathode current	I_k	max.	22 mA
Cathode to heater voltage			
unit a, g, k	V_{kf}	max.	80 V
unit a', g', k' (cathode positive)	$V_{k'f}$	max.	180 V ¹⁾

REMARKS

In order not to exceed the maximum permissible anode voltage when the tube is controlled, it is necessary to use a voltage divider for the grid of the grounded grid section.

The system a, g, k should be used as the grounded cathode input section and the system a', g', k' as the grounded grid output section.

¹⁾ D. C. component max. 130 V.

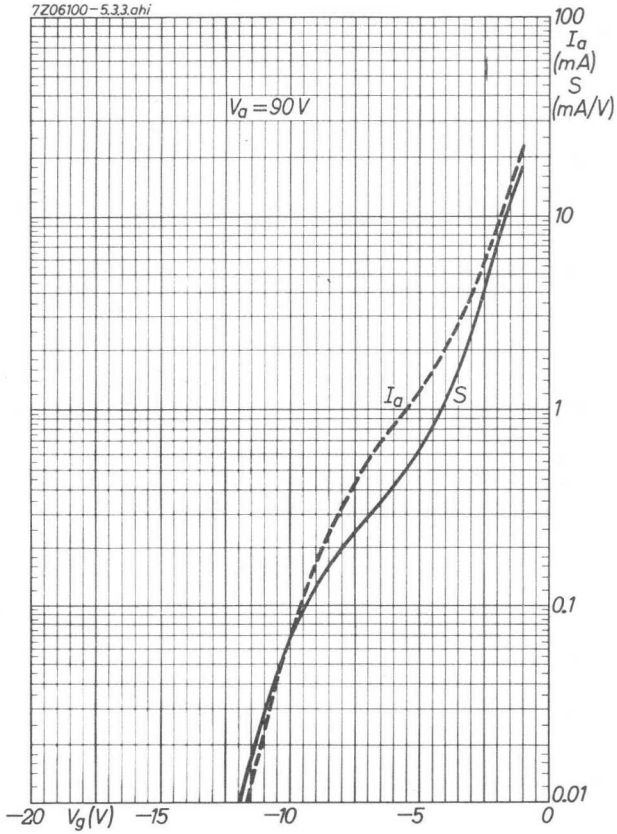

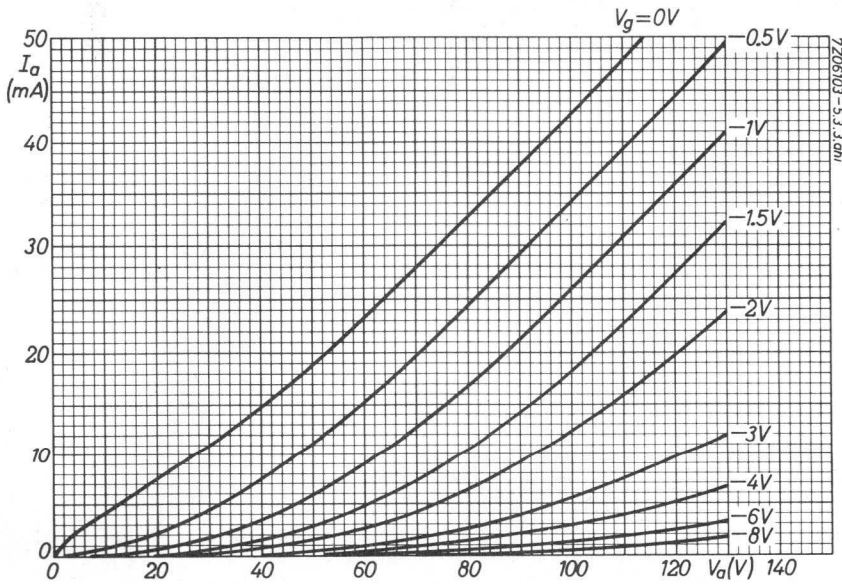
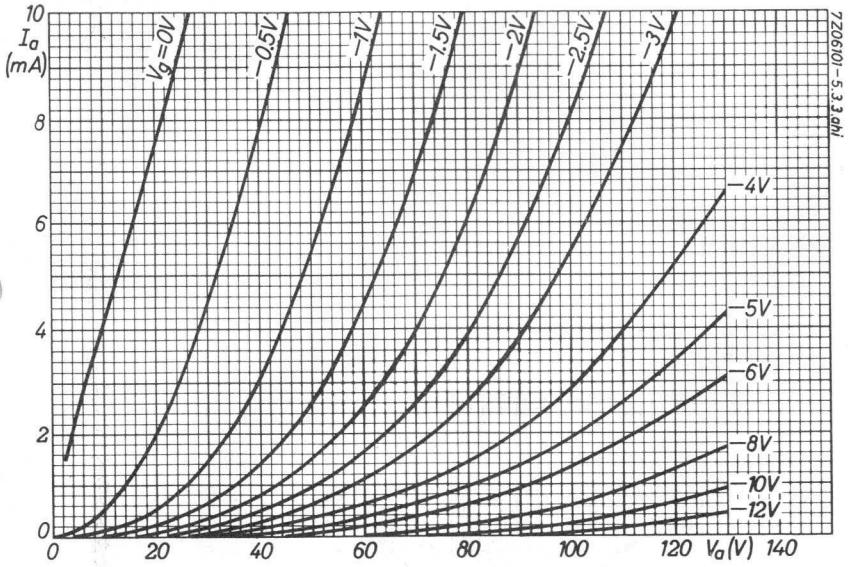

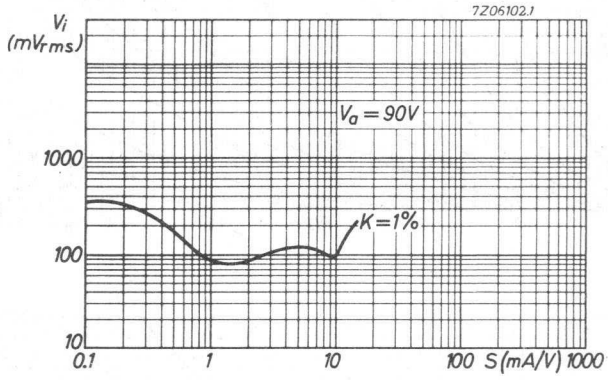

TRIODE PENTODE

Triode pentode with separate cathodes intended for use as frequency changer in television receivers.

QUICK REFERENCE DATA

<u>Triode section</u>		
Anode current	I_a	14 mA
Transconductance	S	5 mA/V
Amplification factor	μ	20 -
<u>Pentode section</u>		
Anode current	I_a	10 mA
Transconductance	S	6.2 mA/V
Amplification factor	$\mu_{g_2g_1}$	47 -

HEATING: Indirect by A.C. or D.C.; series supply

Heater current	I_f	300 mA
Heater voltage	V_f	9 V

DIMENSIONS AND CONNECTIONS

Dimensions in mm

Base: Noval

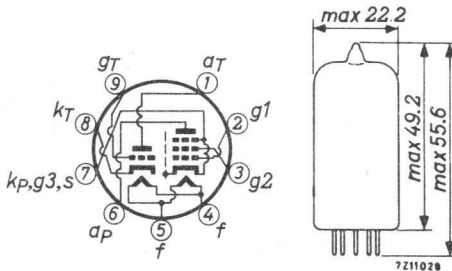

CAPACITANCES

Triode section (numbers denote pin number)

Anode to all except grid (1-4+5+7+8)	$C_{a(g)}$	1.8 pF
Grid to all except anode (9-4+5+7+8)	$C_{g(a)}$	2.5 pF
Anode to grid	C_{ag}	1.5 pF

Pentode section

Anode to all except grid No.1	$C_{a(g_1)}$	3.4 pF
Grid No.1 to all except anode	$C_{g_1(a)}$	5.2 pF
Anode to grid No.1	C_{ag_1}	max. 0.025 pF

Between triode and pentode sections

Anode triode to grid No.1 pentode	C_{aTg_1P}	max. 0.16 pF
Grid triode to anode pentode	C_{gTap}	max. 0.02 pF
Anode triode to anode pentode	C_{aTap}	max. 0.07 pF

TYPICAL CHARACTERISTICS

Triode section

Anode voltage	V_a	100 V
Grid voltage	V_g	-2 V
Anode current	I_a	14 mA
Transconductance	S	5 mA/V
Amplification factor	μ	20 -

Pentode section

Anode voltage	V_a	170 V
Grid No.2 voltage	V_{g_2}	170 V
Grid No.1 voltage	V_{g_1}	-2 V
Anode current	I_a	10 mA
Grid No.2 current	I_{g_2}	2.8 mA
Transconductance	S	6.2 mA/V
Amplification factor	$\mu_{g_2g_1}$	47 -
Internal resistance	R_i	0.4 M Ω
Grid No.1 impedance (Frequency 50 MHz)	r_{g_1}	10 k Ω
Equivalent noise resistance	R_{eq}	1.5 k Ω

OPERATING CONDITIONS

As frequency changer (It is recommended to employ the triode in a Colpitts type of circuit and not in a Hartley type)

Anode voltage	V_a	170	170 V
Grid No.2 voltage	V_{g2}	170	170 V
Grid No.1 resistor	R_{g1}	0.1	0.1 $M\Omega$
Cathode resistor	R_k	330	820 Ω
Oscillator voltage	V_{osc}	3.5	3.5 V_{RMS}
Anode current	I_a	6.5	5.2 mA
Grid No.2 current	I_{g2}	2.0	1.5 mA
Grid No.1 current	I_{g1}	20	0 μA
Conversion conductance	S_c	2.2	2.1 mA/V
Internal resistance	R_i	800	870 $k\Omega$

Frame output application (Optimum peak cathode current of the triode section)

To allow for tube spread, for deterioration during life and for emission drop at underheating the equipment should be so designed that it still operates satisfactorily with a peak cathode current of 100 mA (max. pulse duration 4 % of a cycle, but maximum 0.8 ms). The amplitude of the peak current occurring with new tubes should be limited automatically to this max. value of 100 mA. (E.g. by non-bypassed resistances in the grid lead.)

LIMITING VALUES (Design centre rating system)

Triode section

Anode voltage	V_{a0}	max. 550 V
	V_a	max. 250 V
Anode dissipation	W_a	max. 1.5 W
Cathode current		
average	I_k	max. 14 mA
peak	I_{kp}	see under "frame output applications"
Grid resistor	R_g	max. 0.5 M Ω
Cathode to heater voltage		
cathode neg	V_{kf}	max. 100 V
cathode pos	V_{kf}	max. 200 V
	D.C. component	max. 120 V

Pentode section

Anode voltage	V_{a0}	max. 550 V
	V_a	max. 250 V
Grid No.2 voltage	V_{g20}	max. 550 V
$I_k = 14$ mA	V_{g2}	max. 175 V
$I_k = \text{max. } 10$ mA	V_{g2}	max. 200 V
Anode dissipation	W_a	max. 1.7 W
Grid No.2 dissipation		
at $W_a = \text{min. } 1.2$ W	W_{g2}	max. 0.5 W
at $W_a = \text{max. } 1.2$ W	W_{g2}	max. 0.75 W
Cathode current	I_k	max. 14 mA
Grid resistor		
fixed bias	R_{g1}	max. 0.5 M Ω
automatic bias	R_{g1}	max. 1 M Ω
Cathode to heater voltage		
cathode neg	V_{kf}	max. 100 V
cathode pos	V_{kf}	max. 200 V
	D.C. component	max. 120 V

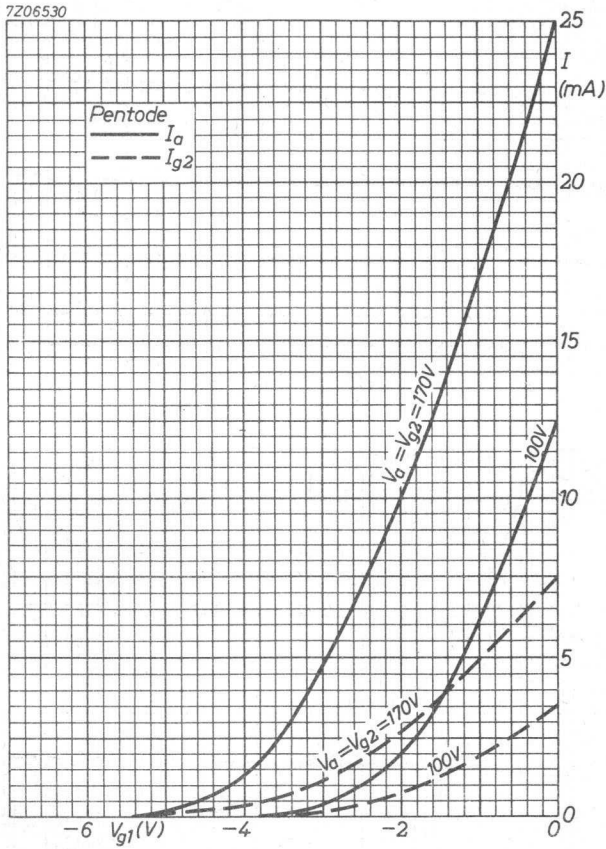

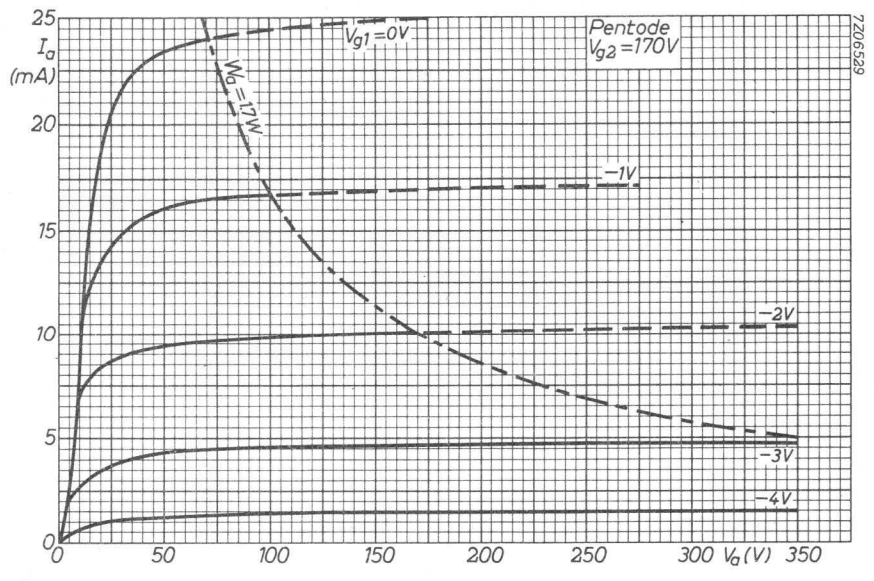
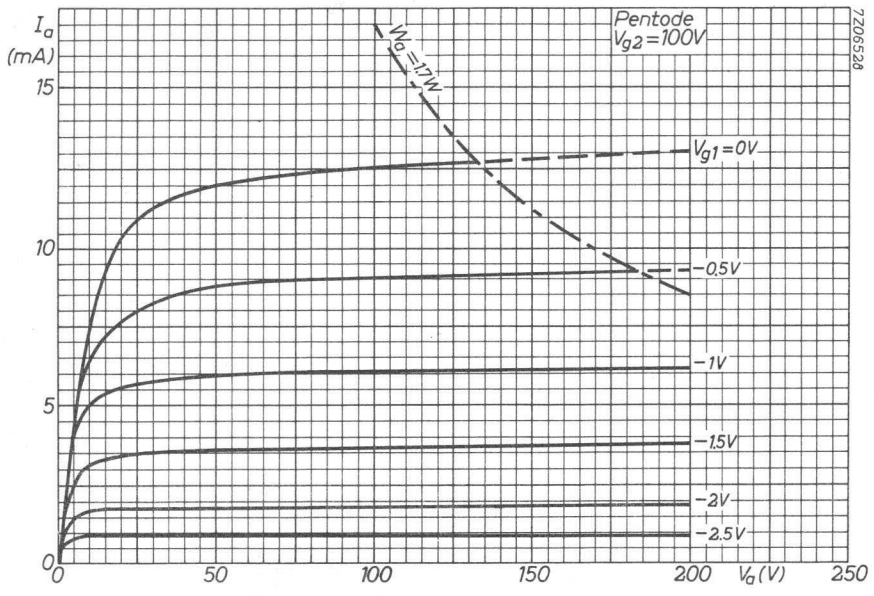

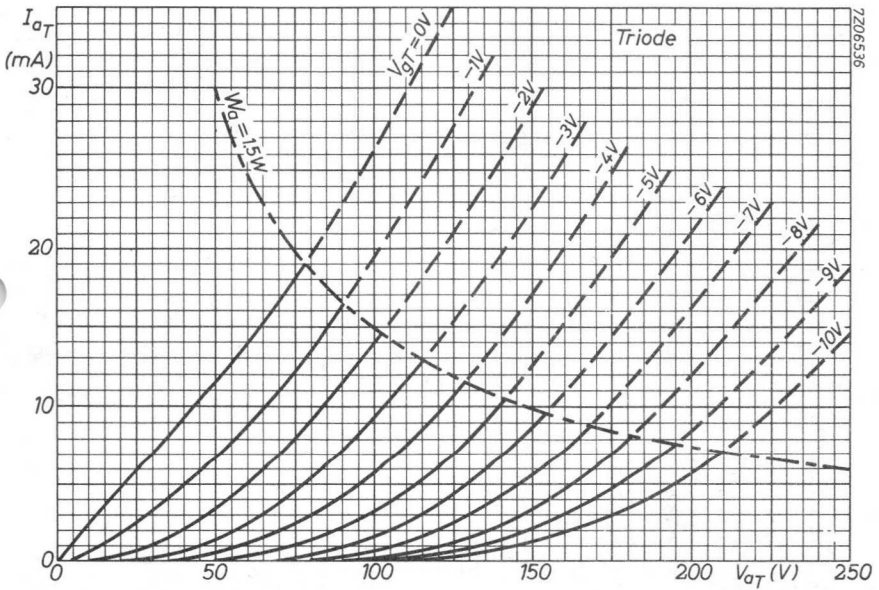
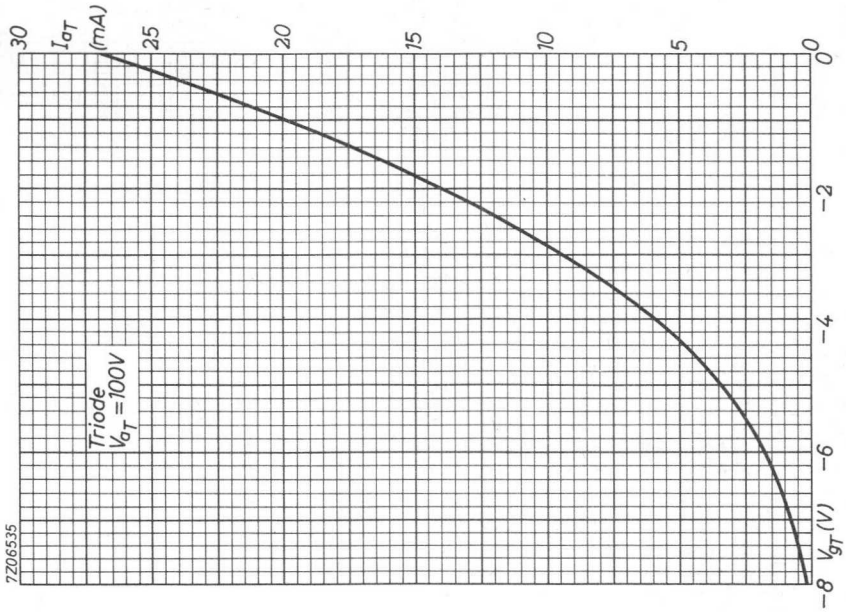

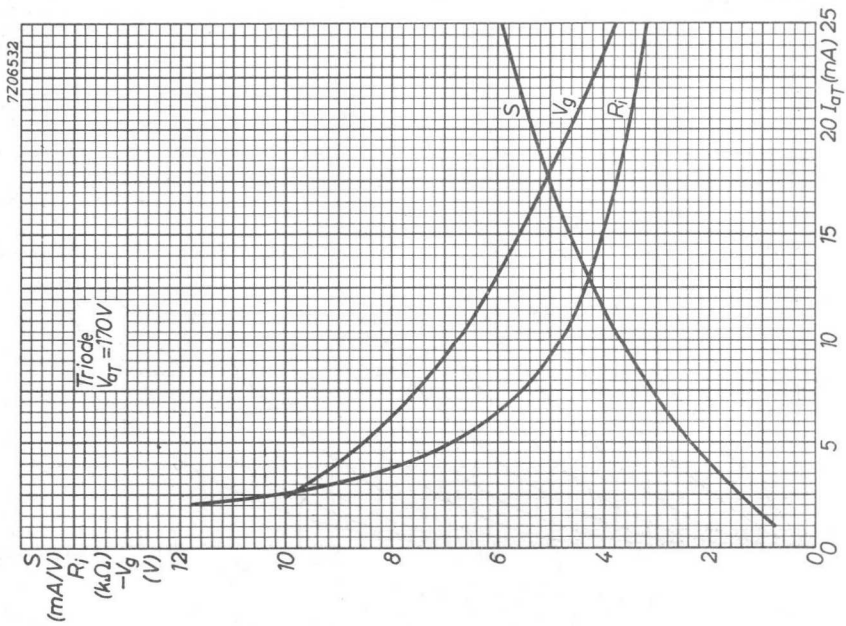
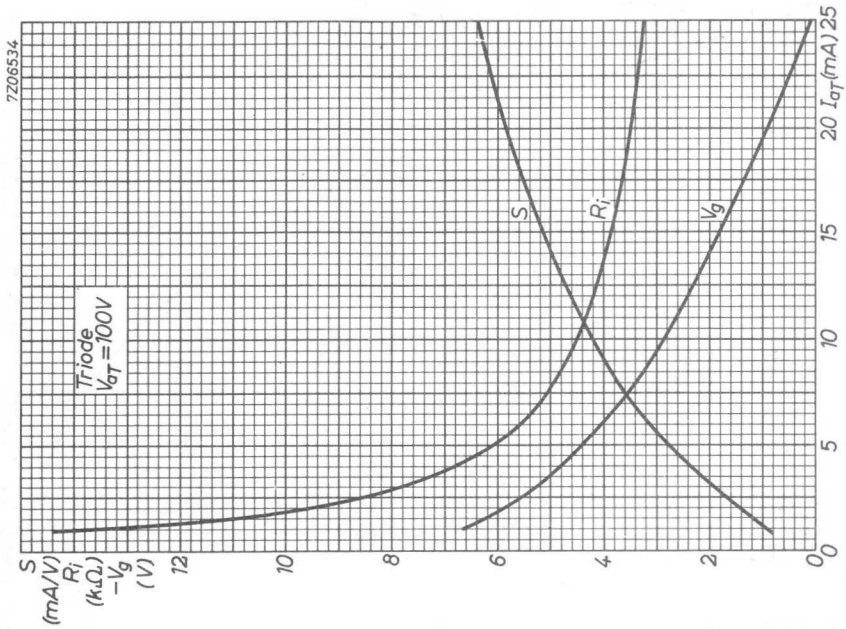

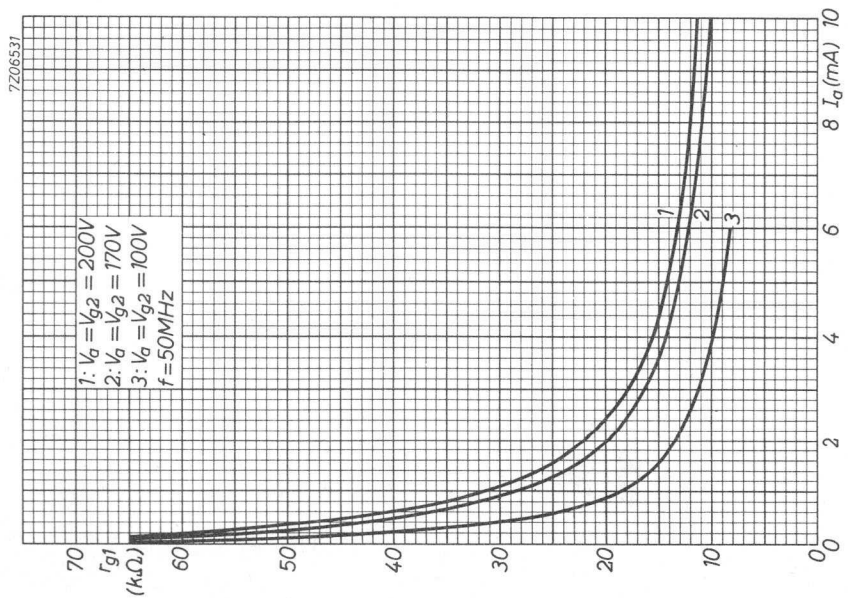
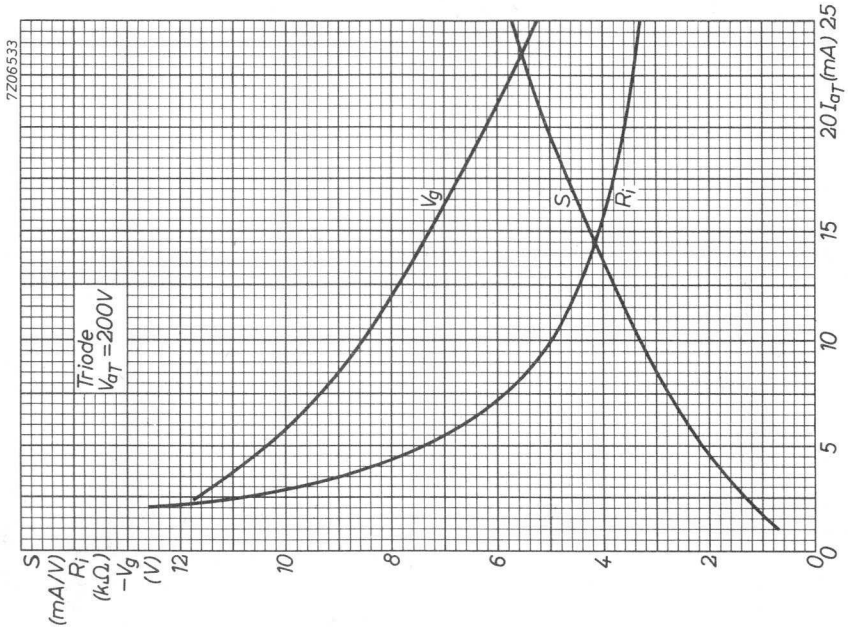

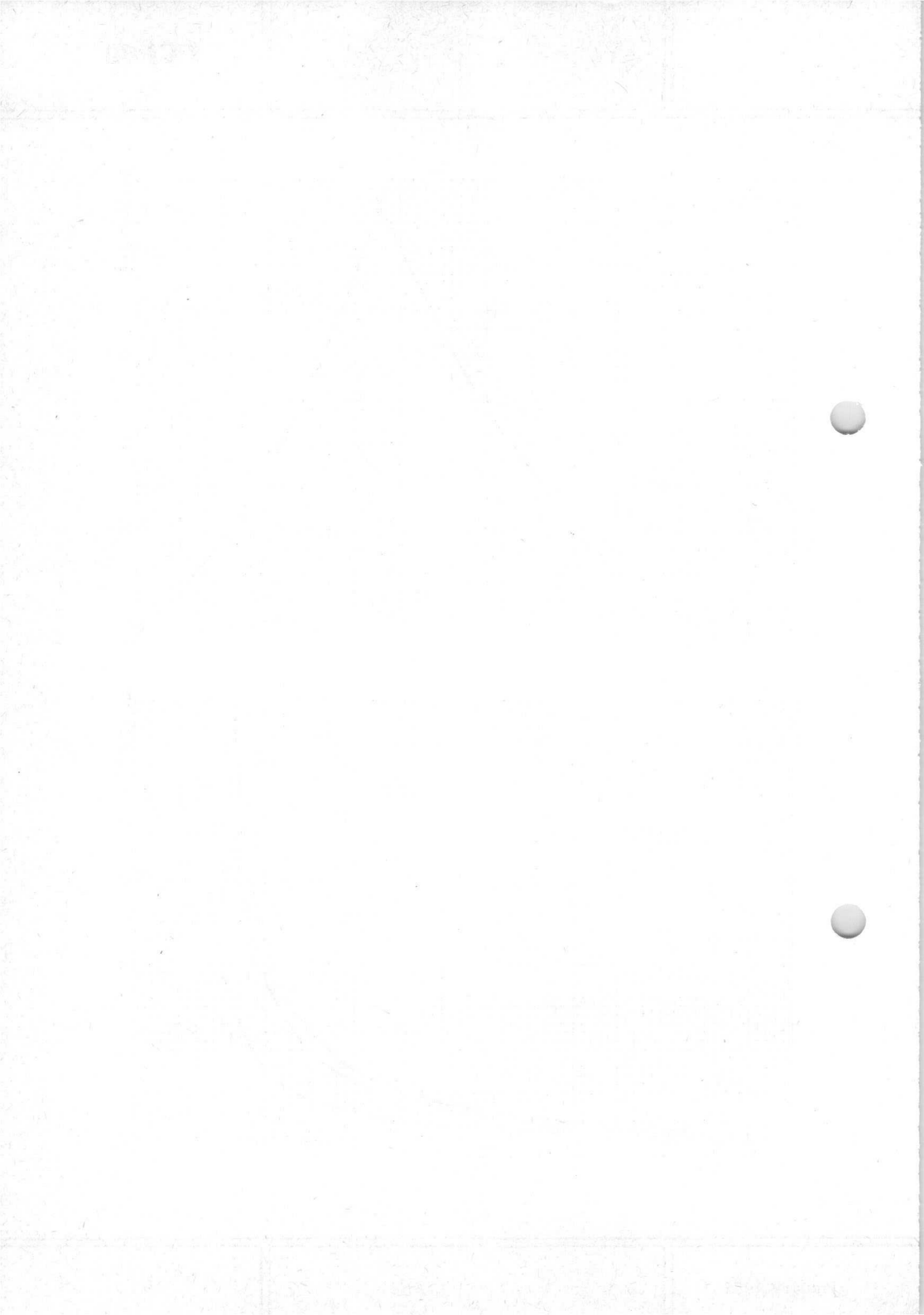

TRIODE-PENTODE

Triode pentode intended for use as frequency changer in V.H.F. television tuners.

QUICK REFERENCE DATA

Triode section

Anode current	I_a	14 mA
Transconductance	S	5.7 mA/V
Amplification factor	μ	17 -

Pentode section

Anode current	I_a	10 mA
Transconductance	S	12 mA/V
Amplification factor	$\mu_{g_2g_1}$	70 -

HEATING: Indirect by A. C. or D. C.; series supply

Heater current	I_f	300 mA
Heater voltage	V_f	8 V

DIMENSIONS AND CONNECTIONS

Dimensions in mm

Base: Noval

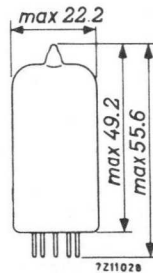
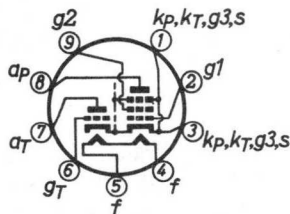

CAPACITANCESTriode section

Anode to all except grid	$C_{a(g)}$	1.1 pF
Grid to all except anode	$C_{g(a)}$	2.4 pF
Anode to grid	C_{ag}	2.0 pF

Pentode section

Anode to all except grid No. 1	$C_{a(g_1)}$	3.5 pF
Grid No. 1 to all except anode	$C_{g_1(a)}$	5.8 pF
Anode to grid No. 1	C_{ag_1}	0.012 pF
Grid No. 1 to grid No. 2	$C_{g_1g_2}$	1.7 pF

Between triode and pentode sections

Anode triode to anode pentode	C_{aTAp}	0.125 pF
Grid triode to anode pentode	C_{gTAp}	0.014 pF
Anode triode to grid No. 1 pentode	C_{aTg_1P}	max. 0.010 pF
Grid triode to grid No. 1 pentode	C_{gTg_1P}	max. 0.010 pF

TYPICAL CHARACTERISTICSTriode section

Anode voltage	V_a	100 V
Grid voltage	V_g	-3 V
Anode current	I_a	14 mA
Transconductance	S	5.7 mA/V
Amplification factor	μ	17 -

Pentode section

Anode voltage	V_a	170 V
Grid No. 2 voltage	V_{g_2}	150 V
Grid No. 1 voltage	V_{g_1}	-1.2 V
Anode current	I_a	10 mA
Grid No. 2 current	I_{g_2}	3.8 mA
Transconductance	S	12 mA/V
Amplification factor	$\mu_{g_2g_1}$	70 -
Internal resistance	R_i	min. 350 k Ω
Equivalent noise resistance	R_{eq}	1 k Ω

OPERATING CHARACTERISTICS

Triode section as oscillator

Anode supply voltage	V_{ba}	190 V
Anode resistor	R_a	8.2 k Ω
Grid resistor	R_g	10 k Ω
Oscillator voltage	V_{osc}	4.5 V _{RMS}
Anode current	I_a	12 mA
Effective transconductance	S_{eff}	3.5 mA/V

Pentode section as mixer

Anode supply voltage	V_{ba}	190 V
Grid No.2 supply voltage	V_{bg2}	190 V
Grid No.2 resistor	R_{g2}	18 k Ω
Grid No.1 resistor	R_{g1}	100 k Ω
Oscillator voltage	V_{osc}	2.3 V _{RMS}
Anode current	I_a	8.5 mA
Grid No.2 current	I_{g2}	3.0 mA
Grid No.1 current	I_{g1}	30 μ A
Conversion conductance	S_c	4.5 mA/V
Internal resistance	R_i	0.6 M Ω

LIMITING VALUES

Triode section

Anode voltage	V_{a0}	max. 550 V
	V_a	max. 250 V
Anode dissipation	W_a	max. 1.5 W
Cathode current	I_k	max. 15 mA
Grid resistor	R_g	max. 0.5 M Ω
Cathode to heater voltage	V_{kf}	max. 100 V ¹⁾

Pentode section

Anode voltage	V_{a0}	max. 550 V
	V_a	max. 250 V
Grid No. 2 voltage	V_{g20}	max. 550 V
	V_{g2}	max. 150 V
Anode dissipation	W_a	max. 2.0 W
Grid No. 2 dissipation	W_{g2}	max. 0.5 W
Cathode current	I_k	max. 18 mA
Grid No. 1 resistor	R_{g1}	max. 0.5 M Ω
Cathode to heater voltage	V_{kf}	max. 100 V ¹⁾

¹⁾ To fulfil the modulation hum requirements in intercarrier receivers, V_{kf} should not exceed 75 V_{RMS}.
With respect to modulation hum in A.M. sound receivers, V_{kf} should not exceed 50 V_{RMS}.

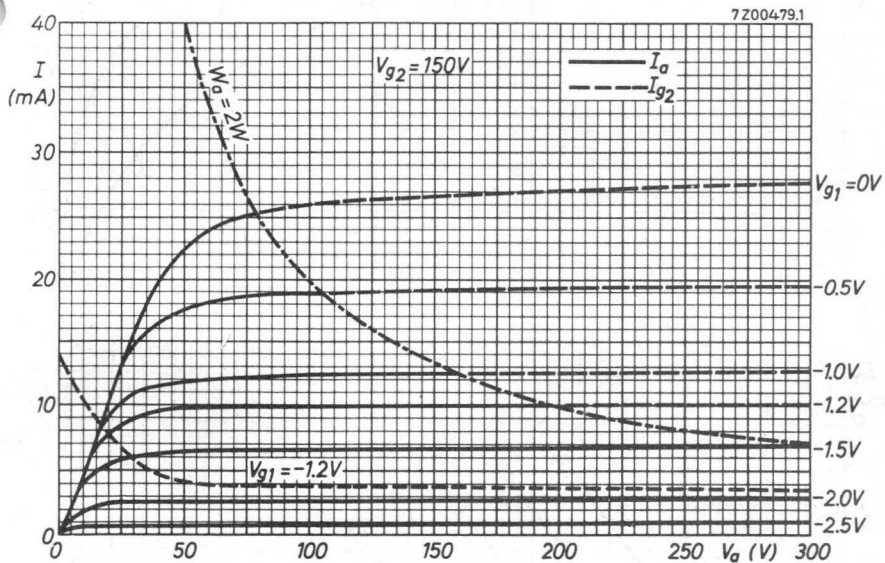

PCF86

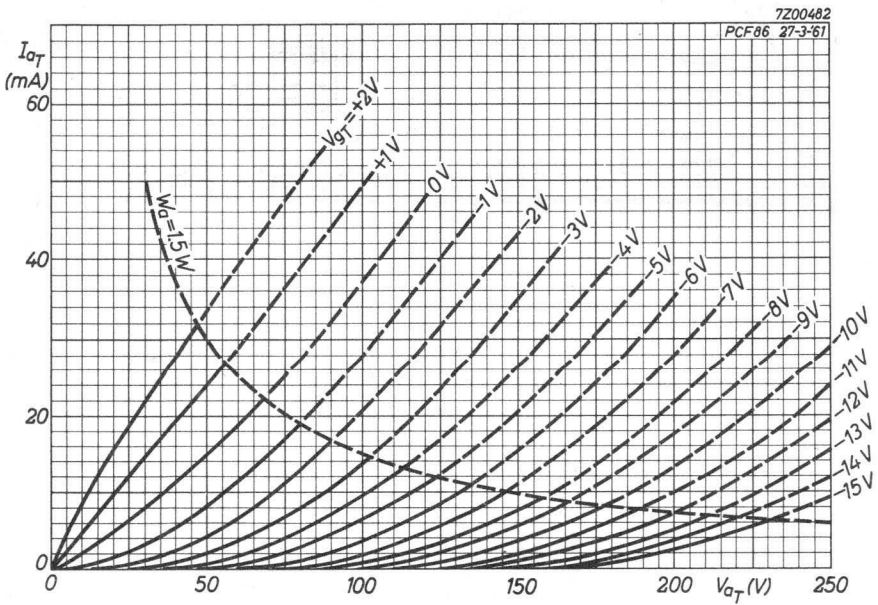
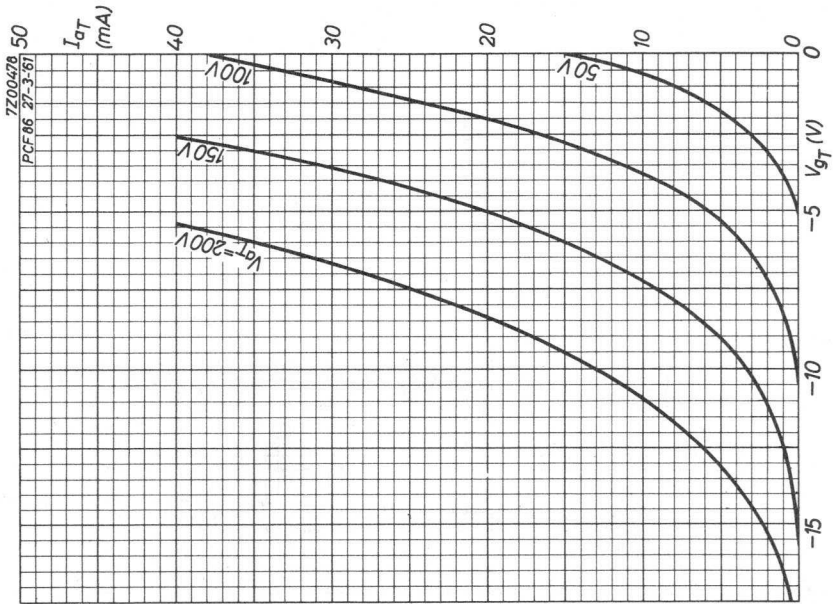

TRIODE-PENTODE

Triode-pentode intended for use in television receivers; triode section as limiter, noise detector, A.G.C. amplifier, sync. separator and pulse-amplifier; pentode section as sound I.F. amplifier and video I.F. amplifier.

QUICK REFERENCE DATA

<u>Pentode section</u>			
Anode current	I_a	13	mA
Transconductance	S	14	mA/V
Amplification factor	$\mu_{g_2g_1}$	53	-
<u>Triode section</u>			
Anode current	I_a	8.5	mA
Transconductance	S	5.2	mA/V
Amplification factor	μ	57	-

HEATING: Indirect by A.C. or D.C.; series supply

Heater current	I_f	300	mA
Heater voltage	V_f	8.5	V

DIMENSIONS AND CONNECTIONS

Base: Decal

Dimensions in mm

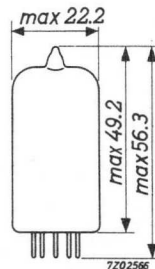
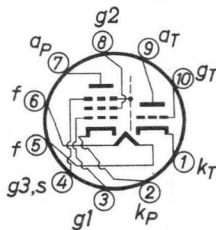

CAPACITANCESTriode section

Grid to all except anode	$C_{g(a)}$	2.1 pF
Anode to all except grid	$C_{a(g)}$	3.0 pF
Anode to grid	C_{ag}	2.2 pF

Pentode section

Grid No.1 to all except anode	$C_{g1(a)}$	6.0 pF
Anode to all except grid No.1	$C_{a(g1)}$	3.3 pF
Anode to grid No.1	C_{ag1}	0.0056 pF
	$C_{ag1 \text{ max.}}$	0.008 pF
Grid No.1 to grid No.2	C_{g1g2}	1.7 pF
Grid No.1 to cathode	C_{g1k}	3.7 pF

Between triode and pentode sections

Pentode anode to triode anode	C_{aP-aT}	max. 0.015 pF
Pentode grid No.1 to triode anode	C_{g1P-aT}	max. 0.0012 pF
Pentode grid No.1 to triode grid	C_{g1P-gT}	max. 0.0015 pF

TYPICAL CHARACTERISTICSPentode section

Anode voltage	V_a	160 V
Grid No.3 voltage	V_{g3}	0 V
Grid No.2 voltage	V_{g2}	135 V
Grid No.1 voltage	V_{g1}	-1.7 V
Anode current	I_a	13 mA
Grid No.2 current	I_{g2}	5.3 mA
Transconductance	S	14 mA/V
Amplification factor	μ_{g2g1}	53 -

Triode section

Anode voltage	V_a	170 V
Grid voltage	V_g	-1.0 V
Anode current	I_a	8.5 mA
Transconductance	S	5.2 mA/V
Amplification factor	μ	57 -

OPERATING CHARACTERISTICS

Pentode section as sound or video I.F. amplifier (g_3 connected to earth)

Supply voltage	V_b	210	230	V
Anode resistor	R_a	3.9	5.6	$k\Omega$
Grid No.2 resistor	R_{g_2}	15	22	$k\Omega$
Cathode resistor	R_k	91	83	Ω
Anode current	I_a	13.0	12.5	mA
Grid No.2 current	I_{g_2}	5.3	5.1	mA
Transconductance	S	14	14	mA/V
Input resistance at 40 MHz	r_{g_1}	6.6	6.6	$k\Omega$

Triode section as sync separator

Anode supply voltage	V_b	130 to 150	V
Anode resistor	R_a	33	$k\Omega$
Grid current	I_g	1	μA
Anode current	I_a	min. 2	mA

LIMITING VALUES (Design centre rating system)

Pentode section

Anode voltage	V_{a0}	max.	550 V
	V_a	max.	250 V
Anode dissipation	W_a	max.	2.1 W
Cathode current	I_k	max.	20 mA
Grid No.2 voltage	V_{g20}	max.	550 V
	V_{g2}	max.	250 V
Grid No.2 dissipation	W_{g2}	max.	0.75 W
Cathode to heater voltage	V_{kf}	max.	150 V
Grid No.1 resistor	R_{g1}	max.	1 M Ω

Triode section

Peak anode voltage ($I_a < 0.1$ mA)	V_{ap}	max.	600 V ¹⁾
Anode voltage	V_{a0}	max.	550 V
	V_a	max.	250 V
Anode dissipation	W_a	max.	1.5 W
Cathode current	I_k	max.	18 mA
Grid resistor	R_g	max.	1 M Ω
Cathode to heater voltage:			
cathode negative with respect to heater	V_{kf}	max.	150 V
cathode positive with respect to heater	V_{kf}	max.	200 V
		+ max.	150 V _{RMS}

¹⁾ Max. pulse duration is 18 % of a cycle but max. 18 μ sec.

7Z02883-5.3.6.bij

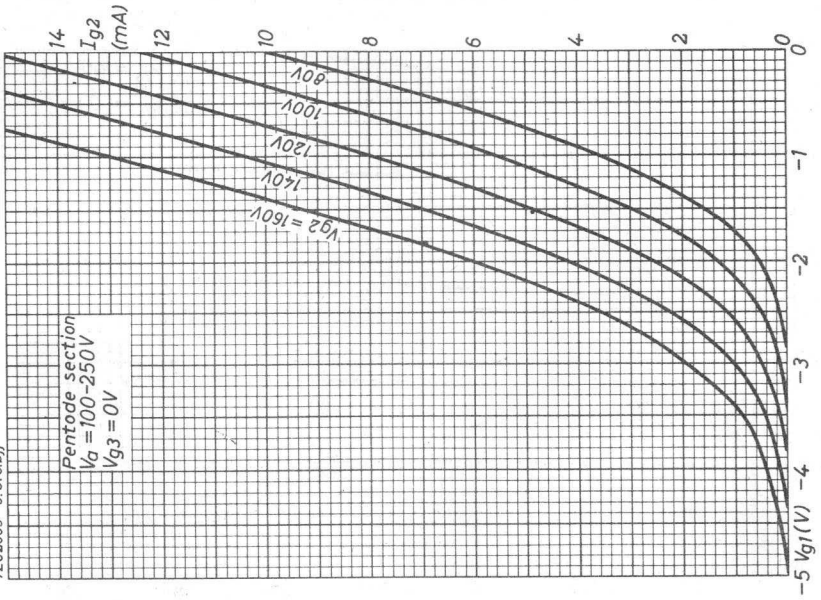

7Z02517-5.3.6.bij

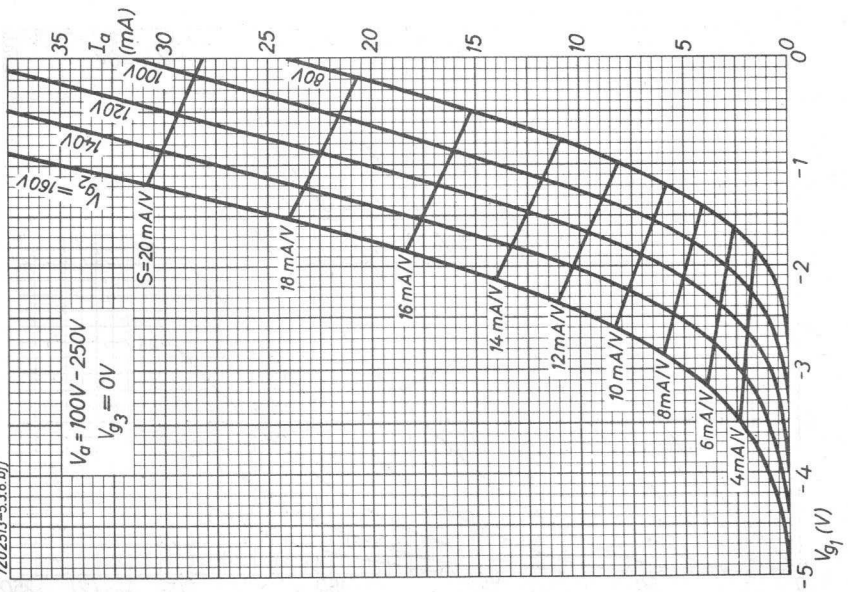

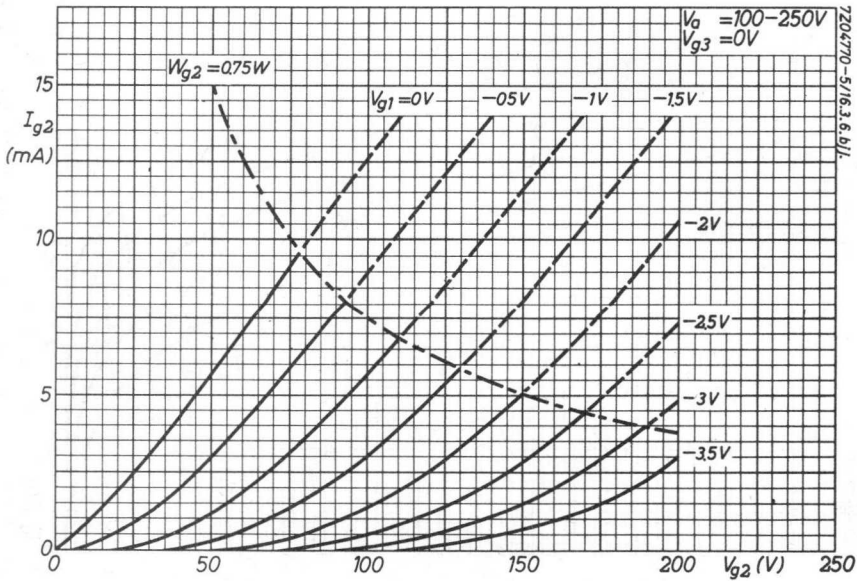
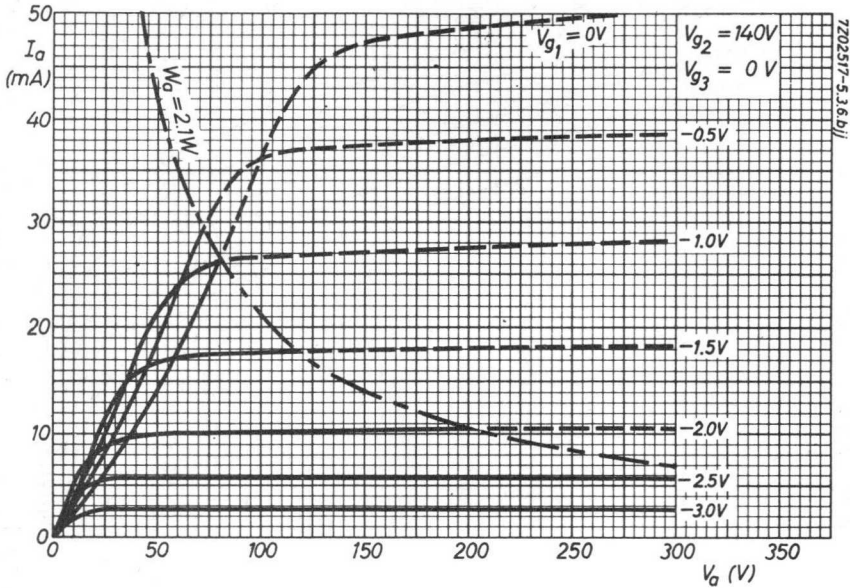

7Z02519-5.3.6.bjj

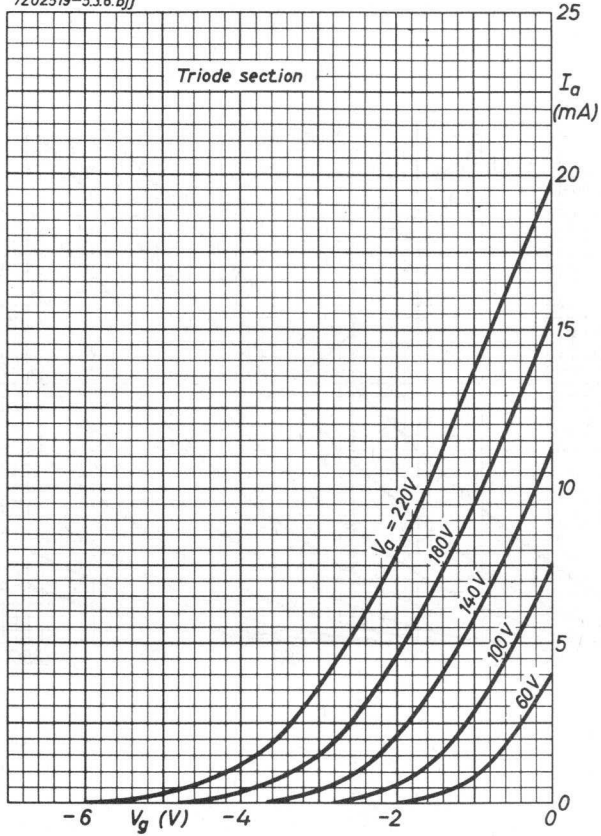

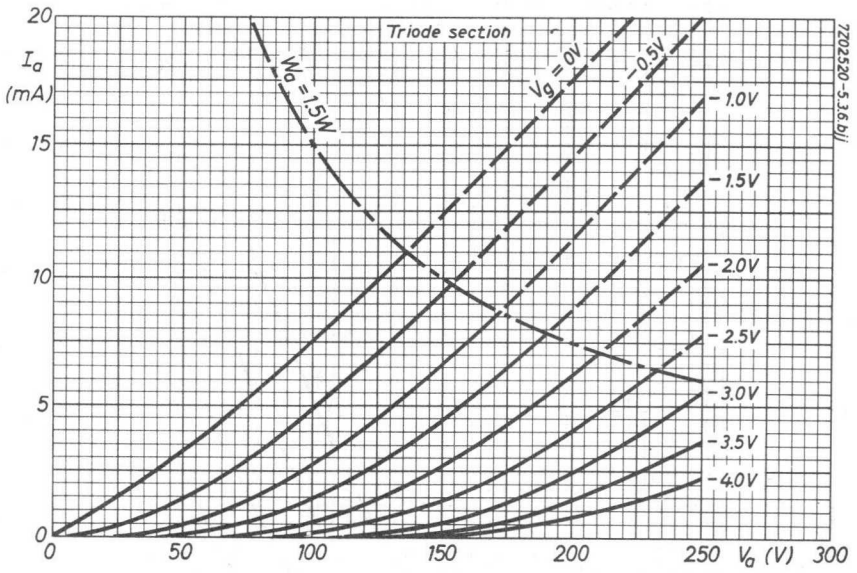

TRIODE-PENTODE

Triode pentode intended for use in T.V. receivers; triode section as line-blocking oscillator, part of a multivibrator, sync separator, pulse amplifier or A.G.C. delay diode; pentode section with remote cut-off as video I.F. amplifier.

QUICK REFERENCE DATA

Pentode section

Anode current	I_a	13 mA
Transconductance	S	12.6 mA/V
Amplification factor	$\mu_{g_2g_1}$	45 -

Triode section

Anode current	I_a	14 mA
Transconductance	S	4.8 mA/V
Amplification factor	μ	17.5 -
Cathode peak current	I_{kp}	max. 50 mA

HEATING: Indirect by A.C. or D.C.; series supply

Heater current

I_f 300 mA

Heater voltage

V_f 8.5 V

DIMENSIONS AND CONNECTIONS

Dimensions in mm

Base: Decal

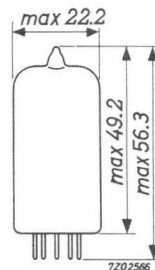
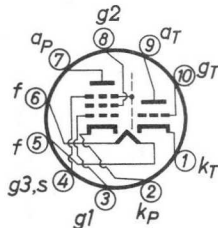

CAPACITANCES

Pentode section

Anode to all except grid No.1	$C_{a(g_1)}$	3.3 pF
Grid No.1 to all except anode	$C_{g_1(a)}$	6.0 pF
Grid No.1 to cathode	C_{kg_1}	3.7 pF
Anode to grid No.1	C_{ag_1}	0.0056 pF
	C_{ag_1}	max. 0.008 pF
Grid No.1 to grid No.2	$C_{g_1g_2}$	1.7 pF

Triode section

Anode to all except grid	$C_{a(g)}$	3.0 pF
Grid to all except anode	$C_{g(a)}$	2.1 pF
Anode to grid	C_{ag}	2.0 pF

Between pentode and triode sections

Pentode anode to triode anode	C_{aPaT}	max. 0.015 pF
Pentode grid No.1 to triode anode	C_{g_1PaT}	max. 0.0012 pF
Pentode grid No.1 to triode grid	C_{g_1PgT}	max. 0.0015 pF

TYPICAL CHARACTERISTICS

Pentode section

Anode voltage	V_a	160 V
Grid No.3 voltage	V_{g_3}	0 V
Grid No.2 voltage	V_{g_2}	110 V
Grid No.1 voltage	V_{g_1}	-1.4 V
Anode current	I_a	13 mA
Grid No.2 current	I_{g_2}	5.3 mA
Transconductance	S	12.6 mA/V
Amplification factor	$\mu_{g_2g_1}$	45 -

Triode section

Anode voltage	V_a	100 V
Grid voltage	V_g	-2 V
Anode current	I_a	14 mA
Transconductance	S	4.8 mA/V
Amplification factor	μ	17.5 -

OPERATING CHARACTERISTICS

Pentode section as video I.F. amplifier (g_3 connected to earth)

Supply voltage	V_b	210	230	250	V
Anode resistor	R_a	3.9	5.6	6.8	$k\Omega$
Grid No.2 resistor	R_{g_2}	18	22	27	$k\Omega$
Cathode resistor	R_k	79	79	76	Ω
Anode current	I_a	13.2	13.2	12.8	mA
Grid No.2 current	I_{g_2}	5.4	5.4	5.2	mA
Transconductance	S	12.6	12.6	12.6	mA/V
Grid No.1 voltage at 0.1 S	V_{g_1}	-5.1	-5.4	-5.7	V
Grid No.1 voltage at 0.01 S	V_{g_1}	-19	-20.5	-22	V
Grid No.1 input resistance at 40 MHz	r_{g_1}	7.4	7.4	7.4	$k\Omega$

Triode section as line-blocking oscillator

Anode voltage	V_a	30	V
Peak cathode current	I_{kp}	40	mA
Peak anode current	I_{ap}	25	mA
Peak grid current	I_{gp}	15	mA

Triode section as sync. separator

Anode supply voltage	V_{b_a}	130 to 150	V
Anode resistor	R_a	33	$k\Omega$
Grid current	I_g	1	μA
Anode current	I_a	min. 2	mA

LIMITING VALUES (Design centre rating system)Pentode section

Anode voltage	V_{a_0}	max. 550 V
	V_a	max. 250 V
Anode dissipation	W_a	max. 2.1 W
Grid No.2 voltage	$V_{g_{20}}$	max. 550 V
	V_{g_2}	max. 250 V
Grid No.2 dissipation	W_{g_2}	max. 0.7 W
Grid No.1 resistor	R_{g_1}	max. 1 M Ω
Cathode current	I_k	max. 20 mA
Cathode to heater voltage	V_{kf}	max. 150 V

Triode section

Anode voltage	V_{a_0}	max. 550 V
	V_a	max. 250 V
Anode dissipation	W_a	max. 1.5 W
Grid resistor	R_g	max. 1 M Ω
Cathode current	I_k	max. 18 mA
Peak cathode current	I_{kp}	max. 50 mA ¹⁾
Cathode to heater voltage	V_{kf}	max. 150 V

¹⁾ Maximum pulse duration 10% of a cycle but max. 10 μ s.

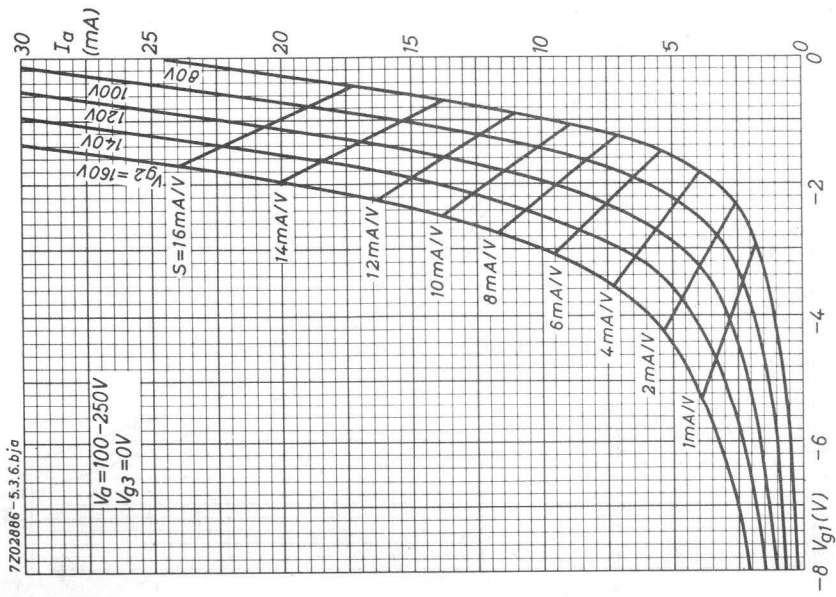
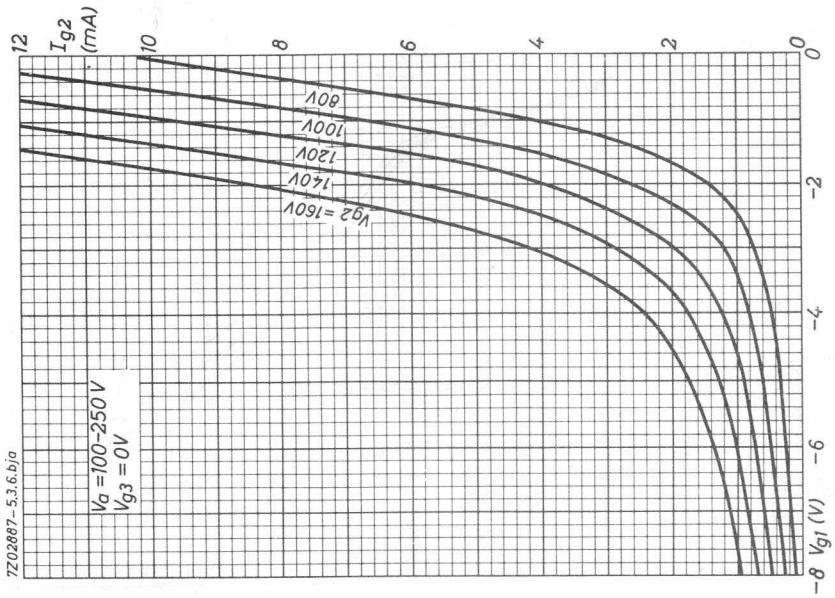

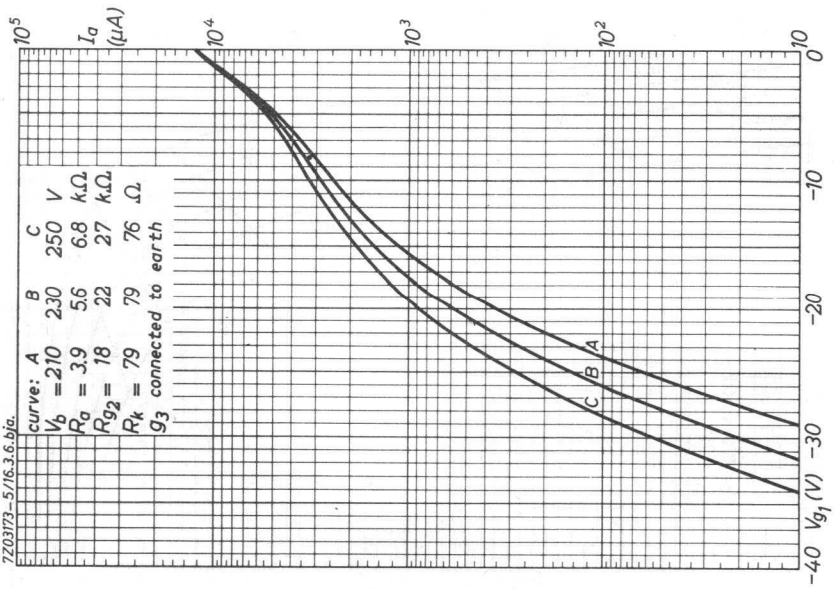
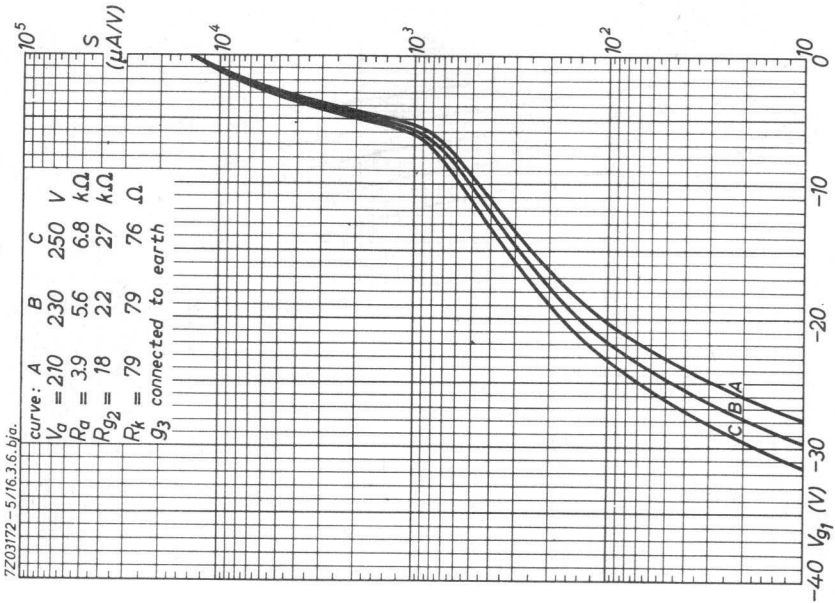

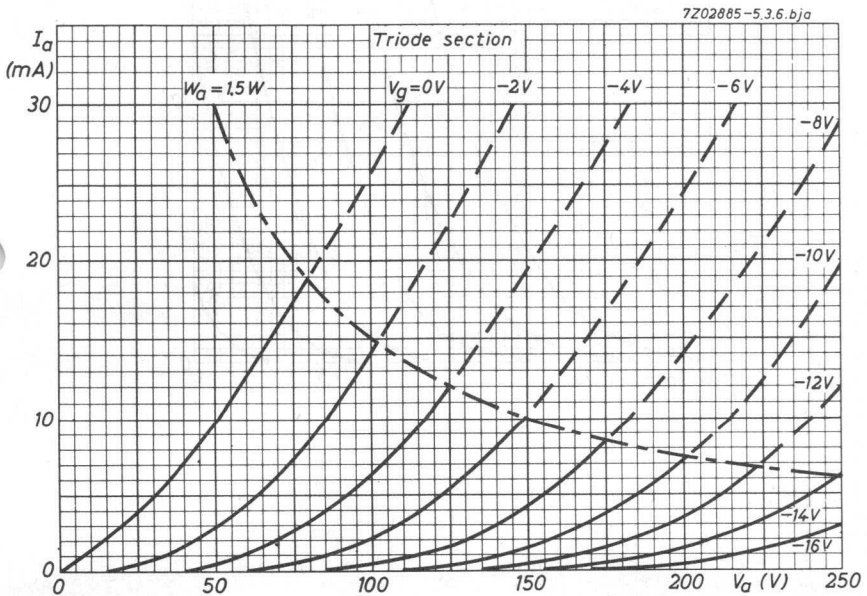
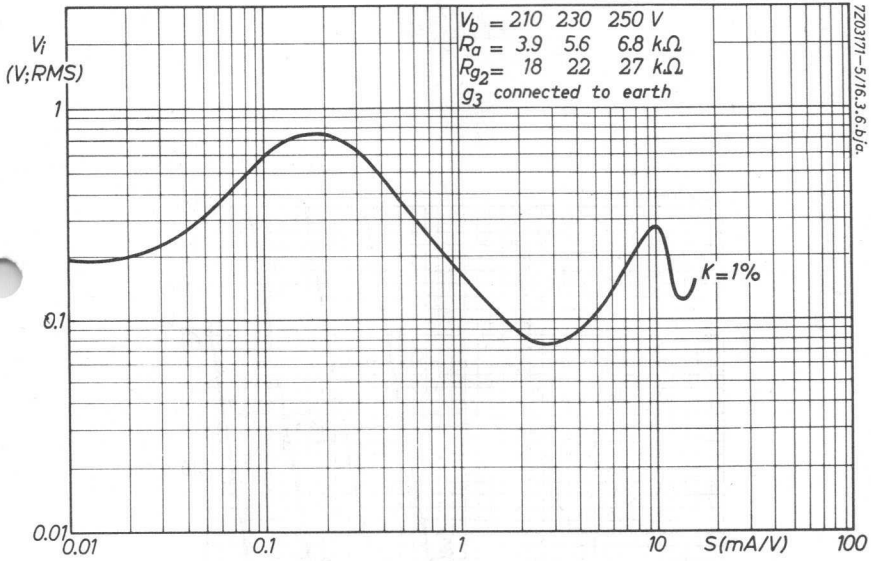

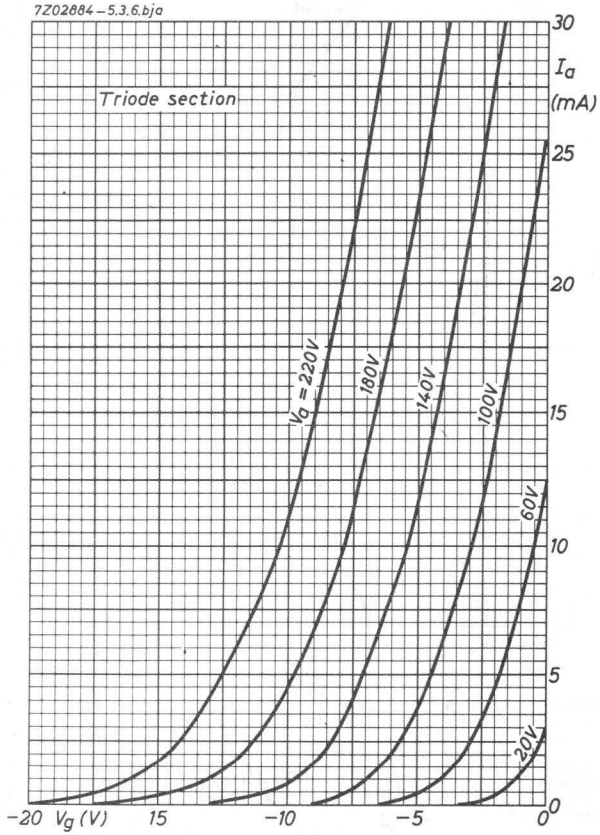

TRIODE-PENTODE

High transconductance triode and R.F. pentode intended for use as frequency changer in V.H.F. T.V. tuners.

QUICK REFERENCE DATA

<u>Pentode section</u>		
Anode current	I_a	10 mA
Transconductance	S	11 mA/V
Amplification factor	$\mu_{g_2g_1}$	55 -
Internal resistance	R_i	min. 350 k Ω
<u>Triode section</u>		
Anode current	I_a	15 mA
Transconductance	S	9 mA/V
Amplification factor	μ	20 -

HEATING: Indirect by A.C. or D.C.; series supply

Heater current

I_f 0.3 A

Heater voltage

V_f 8.5 V

DIMENSIONS AND CONNECTIONS

Dimensions in mm

Base: Noval

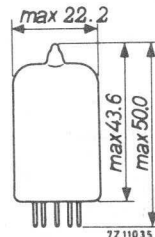
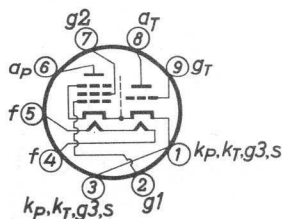

CAPACITANCES (with external shield)Pentode section

Grid No.1 to all except anode	$C_{g1(a)}$	5.9 pF
Anode to all except grid No.1	$C_{a(g1)}$	3.7 pF
Anode to grid No.1	C_{ag1}	0.009 pF
	C_{ag1}	max. 0.012 pF
Grid No.1 to grid No.2	C_{g1g2}	1.6 pF

Triode section

Grid to all except anode	$C_{g(a)}$	3.3 pF
Anode to all except grid	$C_{a(g)}$	1.7 pF
Anode to grid	C_{ag}	1.8 pF

Between pentode and triode sections

Pentode anode to triode anode	C_{aPaT}	max. 0.025 pF
Pentode anode to triode grid	C_{aPgT}	max. 0.010 pF
Pentode grid No.1 to triode anode	C_{g1PaT}	max. 0.010 pF
Pentode grid No.1 to triode grid	C_{g1PgT}	max. 0.010 pF

TYPICAL CHARACTERISTICSPentode section

Anode voltage	V_a	170 V
Grid No.2 voltage	V_{g2}	120 V
Grid No.1 voltage	V_{g1}	-1.4 V
Anode current	I_a	10 mA
Grid No.2 current	I_{g2}	3 mA
Transconductance	S	11 mA/V
Internal resistance	R_i	min. 350 k Ω
Amplification factor	μ_{g2g1}	55
Equivalent noise resistance	R_{eq}	1.5 k Ω

TYPICAL CHARACTERISTICS (continued)

Triode section

Anode voltage	V_a	100	V
Grid voltage	V_g	-3	V
Anode current	I_a	15	mA
Transconductance	S	9	mA/V
Amplification factor	μ	20	-

OPERATING CHARACTERISTICS

Pentode section as I. F. amplifier

Anode supply voltage	V_{ba}	200	V
Grid No. 2 supply voltage	V_{bg2}	200	V
Grid No. 2 resistor	R_{g2}	27	$k\Omega$
Anode resistor	R_a	2.7	4.7 $k\Omega$
Grid No. 1 supply voltage	V_{bg1}	-1.4	0 V
Grid No. 1 resistor	R_{g1}	0.1	1 $M\Omega$
Anode current	I_a	10	13 mA
Grid No. 2 current	I_{g2}	3.0	3.9 mA
Transconductance	S	11	14.5 mA/V
Input resistance at 50 MHz	r_{g1}	10	10 $k\Omega$
Grid No. 1 voltage	V_{g1}	-12	- V
Transconductance	S	0.11	- mA/V

OPERATING CHARACTERISTICS (continued)

Pentode section as mixer

Anode supply voltage	V_{ba}	200	V
Grid No.2 supply voltage	V_{bg2}	200	V
Grid No.2 resistor	R_{g2}	27	$k\Omega$
Anode resistor	R_a	2.7	4.7 $k\Omega$
Grid No.1 supply voltage	V_{bg1}	-1.4	0 V
Grid No.1 resistor	R_{g1}	0.1	1 $M\Omega$
Oscillator voltage	V_{osc}	1.6	1.6 $V_{(RMS)}$
Anode current	I_a	10	9.3 mA
Grid No.2 current	I_{g2}	3.0	2.9 mA
Grid No.1 current	I_{g1}	8	2.3 μA
Conversion conductance	S_c	5	4.7 mA/V

OPERATING CHARACTERISTICS

Triode section as oscillator

Anode supply voltage	V_{ba}	200	V
Grid resistor	R_g	10	$k\Omega$
Anode resistor	R_a	8.2	12 $k\Omega$
Oscillator voltage	V_{osc}	4.5	3.3 $V_{(RMS)}$
Anode current	I_a	16	12 mA
Effective transconductance (without higher harmonics)	S_{eff}	3.7	3.7 mA/V

LIMITING VALUES (Design centre rating system)Pentode section

Anode voltage	V_{a0}	max. 550 V
	V_a	max. 250 V
Anode dissipation	W_a	max. 2.0 W
Grid No.2 voltage	V_{g20}	max. 550 V
Grid No.2 supply voltage	V_{bg2}	max. 250 V
Grid No.2 voltage	V_{g2}	max. 250 V
Grid No.2 dissipation	See page 10	
Grid No.1 voltage	$-V_{g1}$	max. 50 V
Grid No.1 resistor, fixed bias	R_{g1}	max. 1 M Ω
automatic bias	R_{g1}	max. 2.2 M Ω
Cathode current	I_k	max. 18 mA
Cathode to heater voltage	V_{kf}	max. 100 V ¹⁾

Triode section

Anode voltage	V_{a0}	max. 550 V
Anode supply voltage	V_{ba}	max. 250 V
Anode voltage	V_a	max. 125 V
Anode dissipation	W_a	max. 1.5 W
Grid voltage	$-V_g$	max. 50 V
Grid resistor	R_g	max. 0.5 M Ω
Cathode current	I_k	max. 20 mA
Cathode to heater voltage	V_{kf}	max. 100 V ¹⁾

¹⁾ To fulfil the modulation hum requirements in intercarrier receivers, the voltage between heater and cathode should not exceed 100 V(RMS).

With respect to modulation hum in A.M. sound receivers the voltage between heater and cathode should not exceed 50 V(RMS).

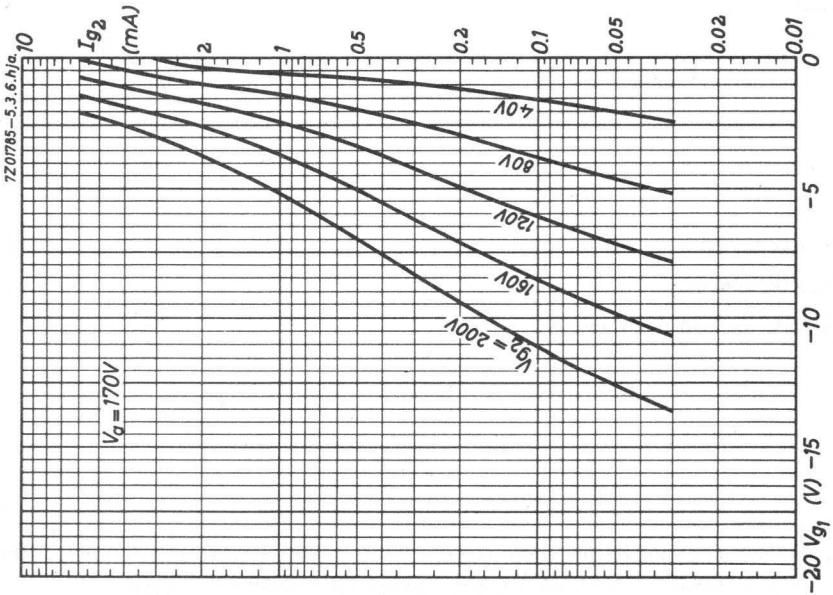
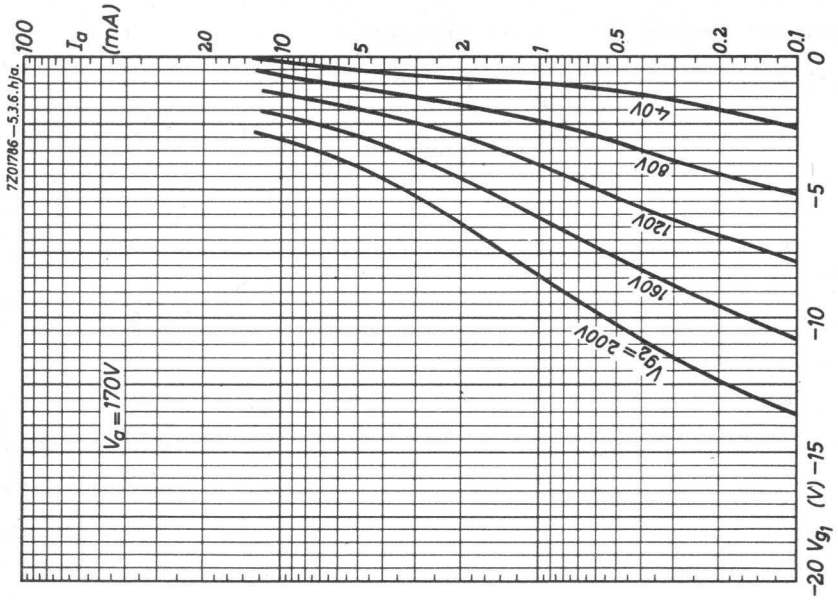

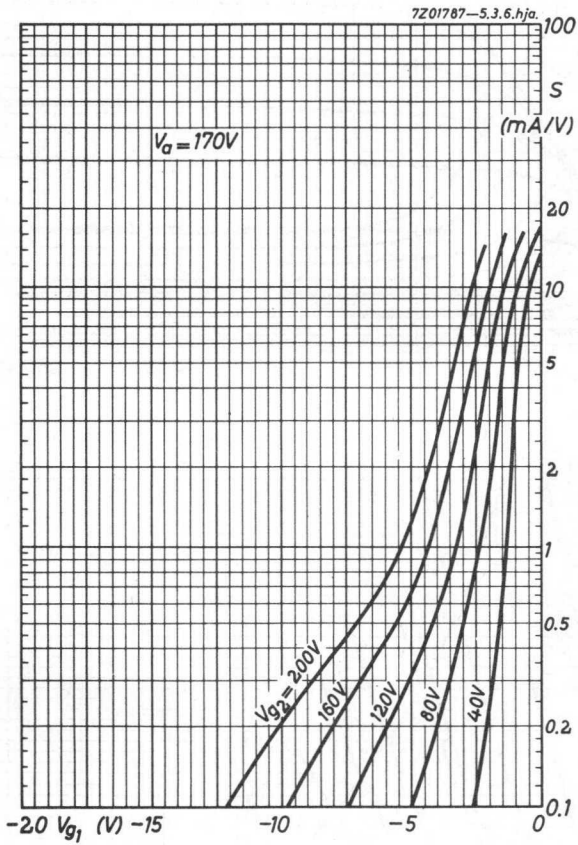

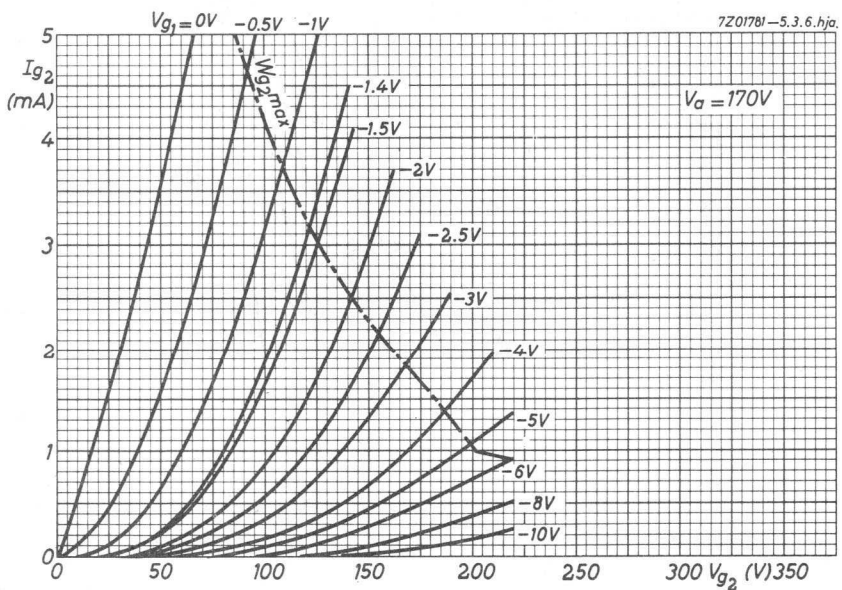
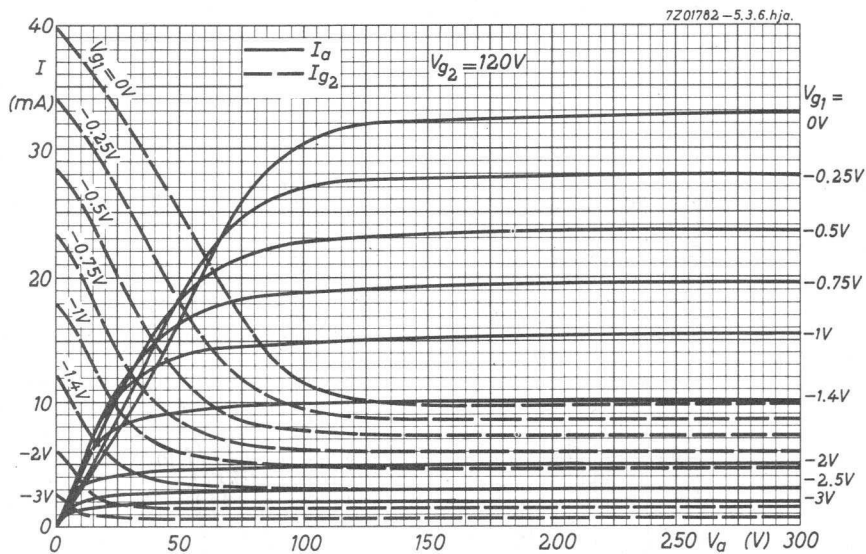

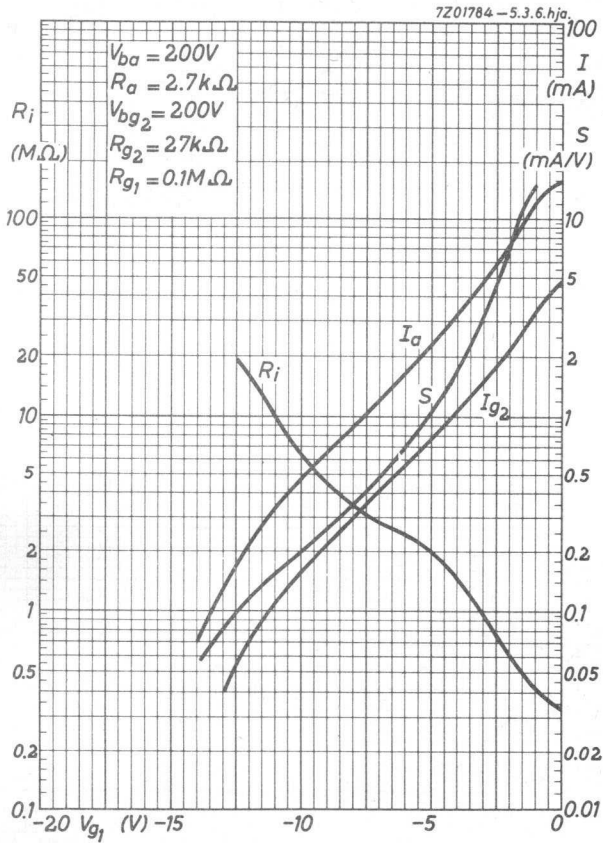

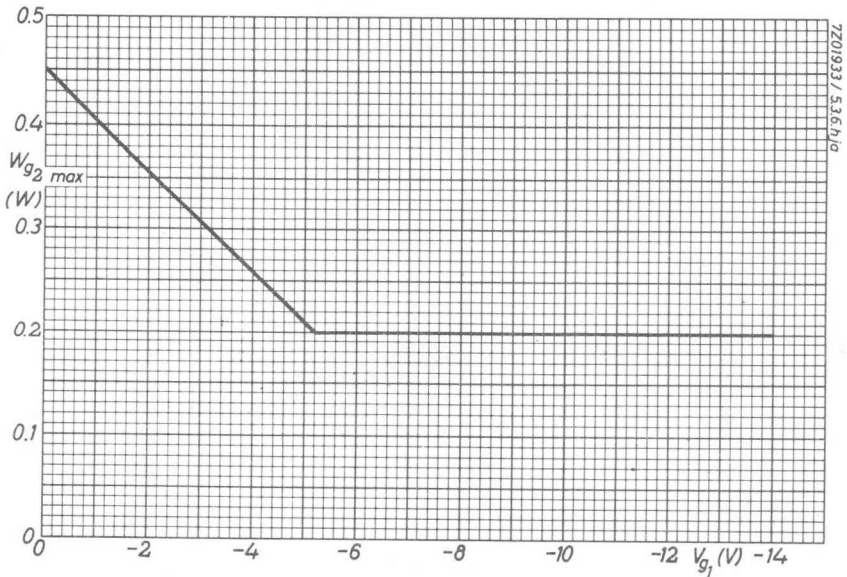
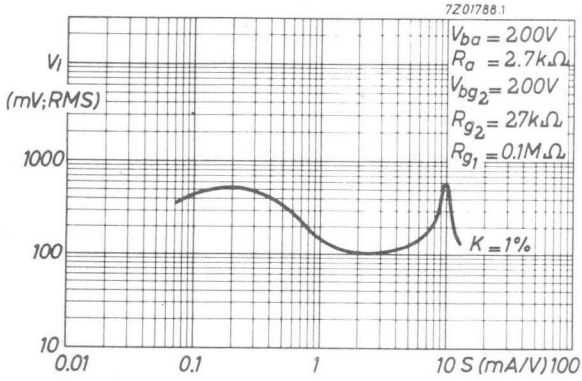

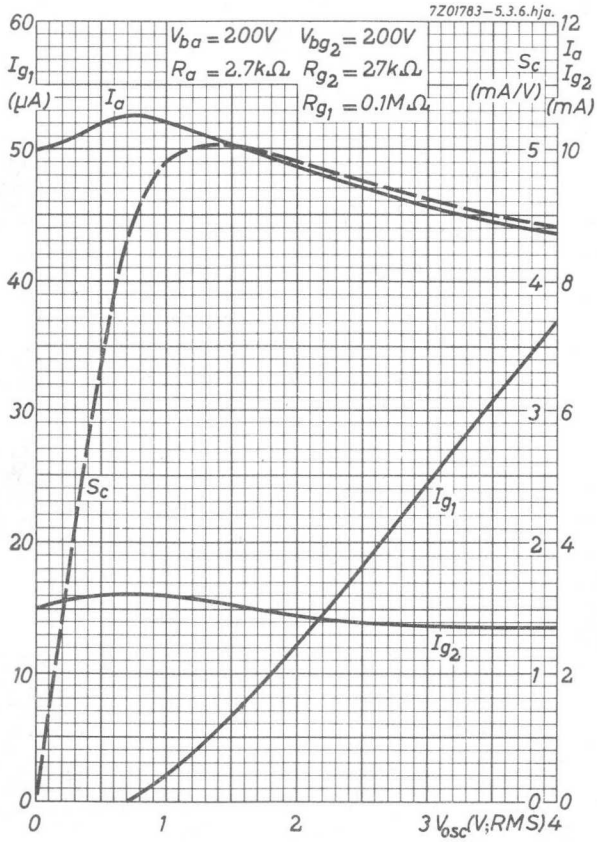

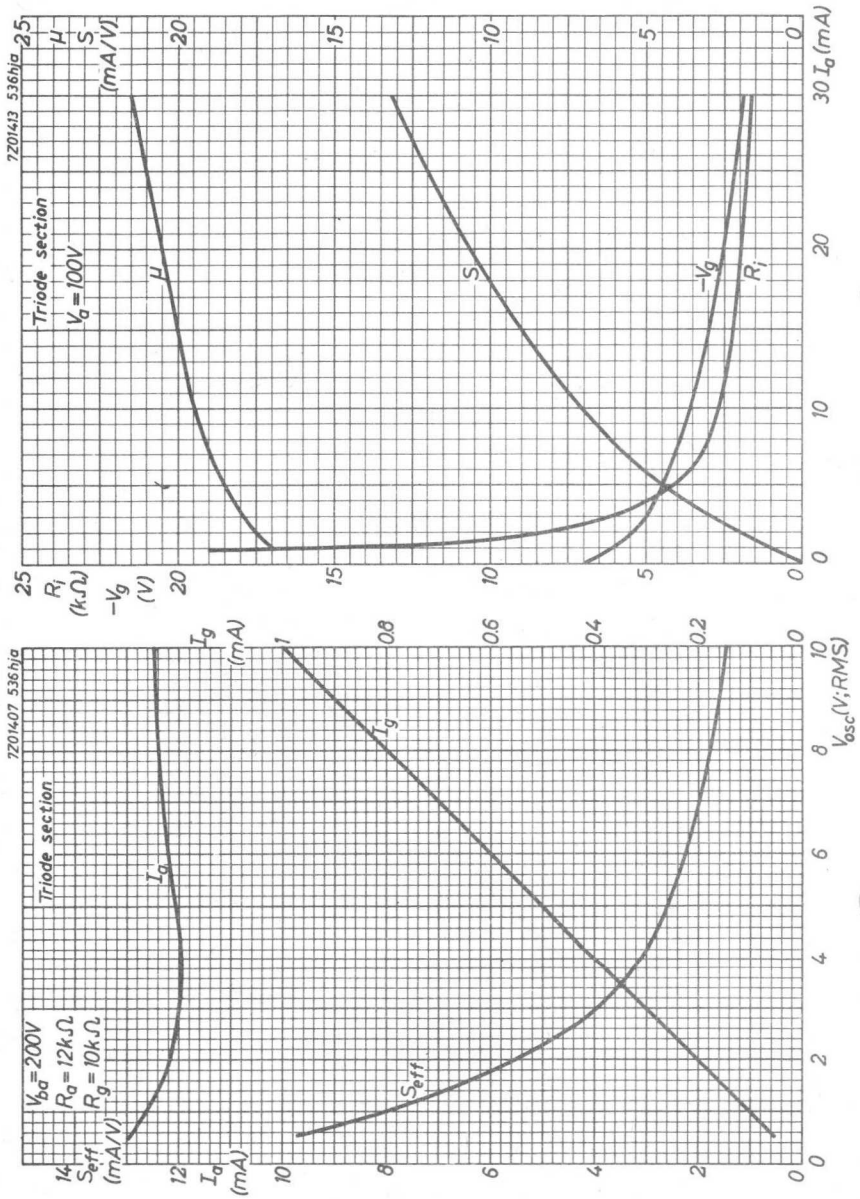

TRIODE-PENTODE

Triode pentode; triode section intended for use as reactance tube, pentode section intended for use as sine wave oscillator or pulse shaper in television receivers.

QUICK REFERENCE DATA

<u>Pentode section</u>		
Anode current	I_a	6 mA
Transconductance	S	5.5 mA/V
Amplification factor	$\mu_{g_2g_1}$	47 -
Internal resistance	R_i	400 k Ω
<u>Triode section</u>		
Anode current	I_a	3.5 mA
Transconductance	S	3.5 mA/V
Amplification factor	μ	70 -

HEATING: Indirect by A.C. or D.C.; series supply

Heater current I_f 300 mA

Heater voltage V_f 9 V

DIMENSIONS AND CONNECTIONS

Dimensions in mm

Base: Noval

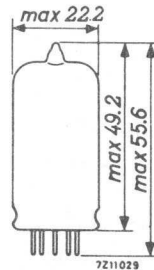
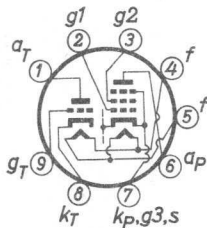

CAPACITANCES

Pentode section

Grid No. 1 to all except anode	$C_{g1(a)}$	5.4 pF
Anode to grid No. 1	C_{ag1}	0.06 pF
Grid No. 1 to heater	C_{g1f}	max. 0.1 pF

Triode section

Grid to all except anode	$C_{g(a)}$	2.4 pF
Anode to grid	C_{ag}	1.5 pF
Grid to heater	C_{gf}	max. 0.1 pF

TYPICAL CHARACTERISTICS

Pentode section

Anode voltage	V_a	100	100	200	100	V
Grid No. 2 voltage	V_{g2}	100	100	200	100	V
Grid No. 1 voltage	V_{g1}	-1	0	max. -16	max. -1.3	V
Anode current	I_a	6	12.5	0.01	-	mA
Grid No. 2 current	I_{g2}	1.7	3.5	-	-	mA
Transconductance	S	5.5	-	-	-	mA/V
Internal resistance	R_i	400	-	-	-	k Ω
Amplification factor	μ_{g2g1}	47	-	-	-	-
Grid No. 1 current	I_{g1}	-	-	-	0.3	μ A

Triode section

Anode voltage	V_a	200	200	200	V
Grid voltage	V_g	-2	-	max. -1.3	V
Anode current	I_a	3.5	10	-	mA
Transconductance	S	3.5	-	-	mA/V
Internal resistance	R_i	20	-	-	k Ω
Amplification factor	μ	70	-	-	-
Grid current	I_g	-	10	0.3	μ A

LIMITING VALUES (Design centre rating system)

Pentode section

Anode voltage	V_{a0}	max. 550 V
	V_a	max. 250 V
Anode dissipation	W_a	max. 1.2 W
Grid No.2 voltage	V_{g20}	max. 550 V ¹⁾
	V_{g2}	max. 250 V
Grid No.2 dissipation	W_{g2}	max. 0.8 W
Grid No.1 voltage	$-V_{g1}$	max. 220 V ¹⁾
Grid resistor, fixed bias	R_{g1}	max. 0.56 M Ω
automatic bias	R_{g1}	max. 1 M Ω
Cathode current, average	I_k	max. 15 mA
peak	I_{kp}	max. 50 mA
$T_{imp} = \max. 30 \mu s, \delta = \max. 0.3$		
Cathode to heater voltage	V_{kf}	max. 100 V ²⁾
Grid circuit impedance	Z_{g1} (f = 50 Hz)	max. 300 k Ω ²⁾

Triode section

Anode voltage	V_{a0}	max. 550 V
	V_a	max. 250 V
Anode dissipation	W_a	max. 1.4 W
Grid resistor, fixed bias	R_g	max. 3 M Ω
Cathode current	I_k	max. 10 mA
Cathode to heater voltage	V_{kf}	max. 100 V ³⁾
Grid circuit impedance	Z_g (f = 50 Hz)	max. 50 k Ω ³⁾

- 1) The instantaneous voltage between grid No.1 and grid No.2 should never exceed 550 V.
- 2) To avoid hum interference the A.C. component of V_{kf} should not exceed 65 V at the specified value of Z_{g1} .
- 3) To minimise hum interference decoupling of R_k is recommended. In circuits with undecoupled R_k the hum interference between grid and cathode will remain below 1000 μV when the A.C. component of V_{kf} does not exceed 25 V and the R_k is not higher than 1.2 k Ω at the specified value of Z_g .

PCF 802

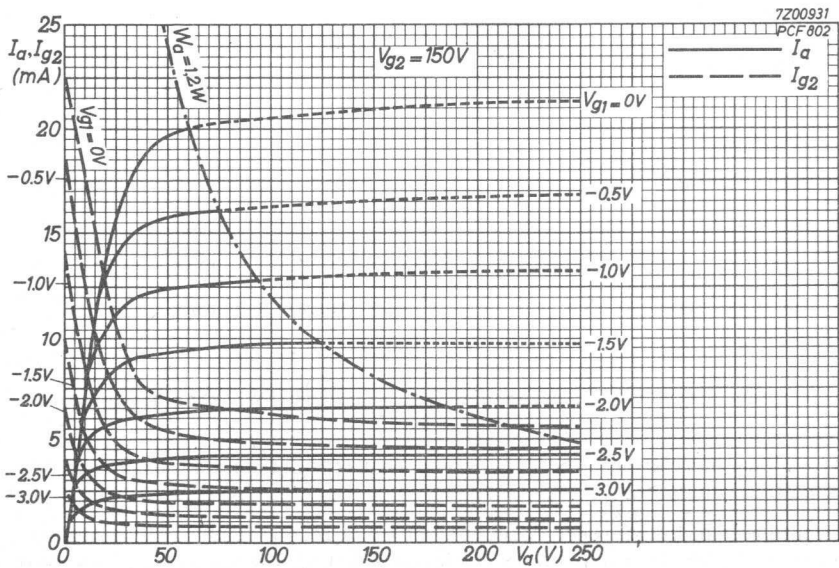
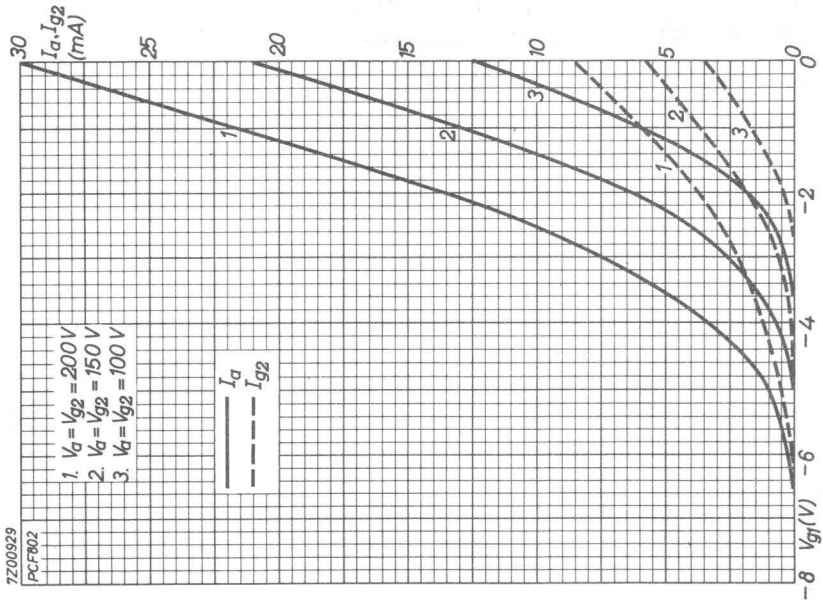

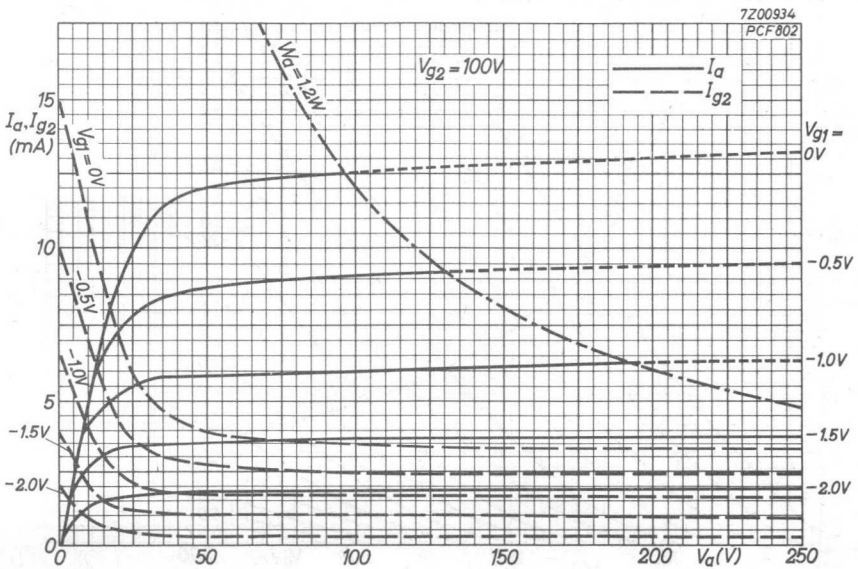
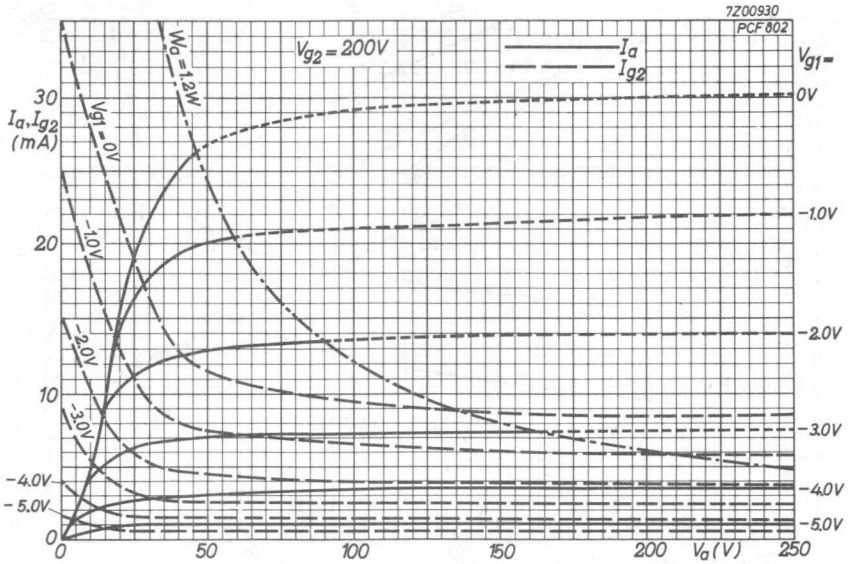

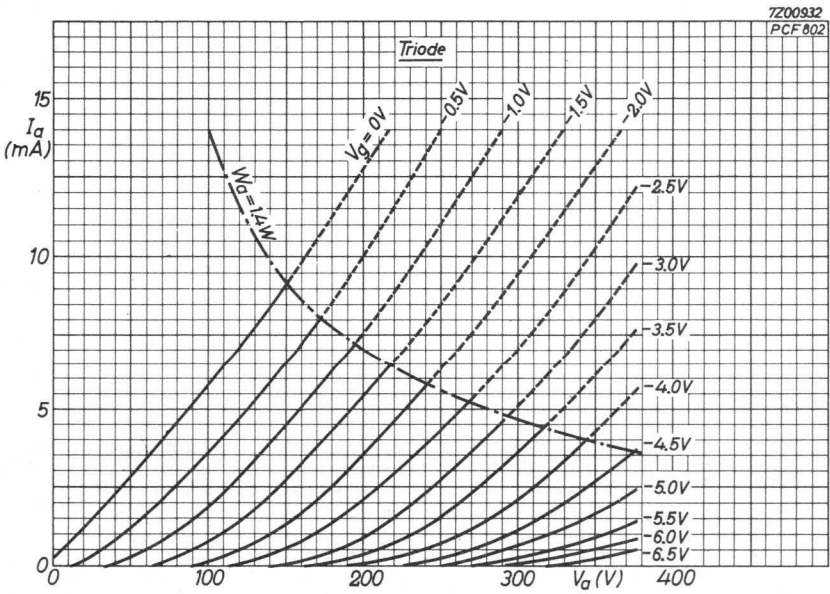
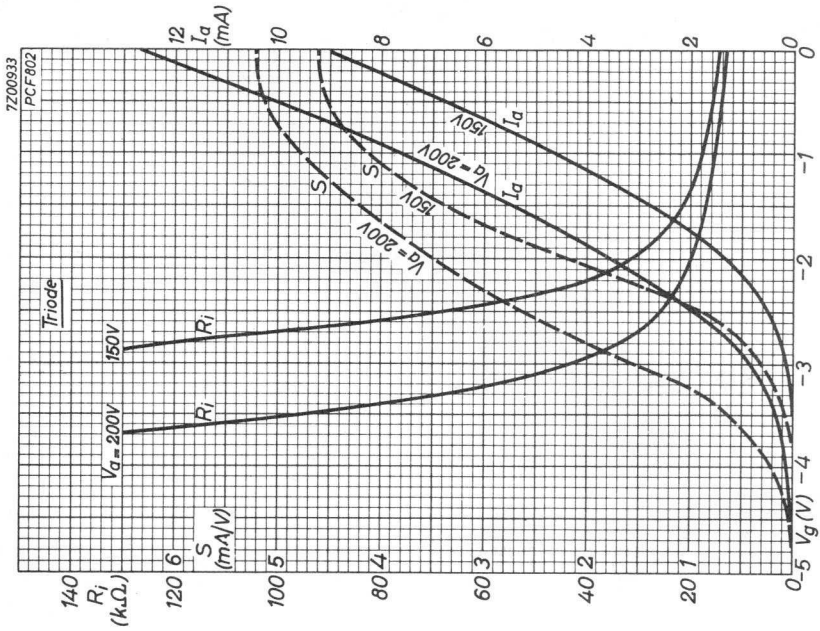

TRIODE-HEPTODE

Triode-heptode; triode section intended for use as pulse amplifier and heptode section for use as noise gated sync. separator.

QUICK REFERENCE DATA

<u>Triode section</u>			
Anode current	I_a	9	mA
Transconductance	S	8.8	mA/V
Amplification factor	μ	50	-
<u>Heptode section</u>			
Grid No.1 voltage	V_{g1}	0 -1.8	0 V
Grid No.3 voltage	V_{g3}	0 0 -1.8	V
Anode current	I_a	1500 20 20	μ A

HEATING: Indirect by A.C. or D.C.; series supply

Heater current	I_f	300	mA
Heater voltage	V_f	8.5	V

DIMENSIONS AND CONNECTIONS

Dimensions in mm

Base: decal

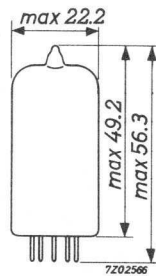
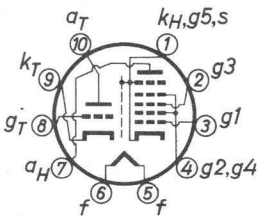

CAPACITANCES

Heptode section

Grid No.1 to all except anode	$C_{g_1(a)}$	4.4 pF
Anode to all except grid No.1	$C_{a(g_1)}$	5.4 pF
Anode to grid No.1	C_{ag_1}	max. 0.1 pF
Anode to grid No.3	C_{ag_3}	max. 0.25 pF
Grid No.1 to grid No.3	$C_{g_1g_3}$	0.3 pF

Triode section

Grid to all except anode	$C_g(a)$	3.3 pF
Anode to all except grid	$C_a(g)$	1.7 pF
Anode to grid	C_{ag}	1.8 pF

Between heptode and triode sections

Heptode grid No.1 to triode grid	C_{g_1HgT}	max. 0.005 pF
Heptode grid No.1 to triode anode	C_{g_1HaT}	max. 0.010 pF
Heptode grid No.3 to triode grid	C_{g_3HgT}	max. 0.020 pF
Heptode anode to triode anode	C_{aHaT}	max. 0.150 pF

TYPICAL CHARACTERISTICS

Triode section

Anode voltage	V_a	100	200	V
Anode current	I_a	9.0	0.1	mA
Grid voltage	V_g	-1	-7 (<11)	V
Transconductance	S	8.8	-	mA/V
Amplification factor	μ	50	-	-

Heptode section

Anode voltage	V_a	14	14	14	V
Grids No.2 and 4 voltage	V_{g_2, g_4}	14	14	14	V
Grid No.3 voltage	V_{g_3}	0	0	-1.8 (<2.2)	V
Grid No.1 voltage	V_{g_1}	0	-1.8	0	V
Anode current	I_a	1500	20	20	μA
Grids No.2 and 4 current	$I_{g_2+g_4}$	1300	-	-	μA

OPERATING CHARACTERISTICS

Heptode section as sync. separator

Anode voltage	V_a	14	1	14	14	V
Grids No.2 and 4 voltage	V_{g_2, g_4}	14	14	14	14	V
Grid No.3 voltage	V_{g_3}	-	-	+25	-1.9 (<2.3)	V
Grid No.1 voltage	V_{g_1}	-	-	-2	-	V
Anode current	I_a	750	>300	20	20	μA
Grid No.3 current	I_{g_3}	1	1	-	-	μA
Grid No.1 current	I_{g_1}	100	100	-	100	μA

LIMITING VALUES (Design centre rating system)

Triode section

Anode voltage	V_{a0}	max. 550 V
	V_a	max. 250 V
Anode dissipation	W_a	max. 1.5 W
Cathode current	I_k	max. 20 mA
Grid resistor (fixed bias)	R_g	max. 2 MΩ
(automatic bias)	R_g	max. 3 MΩ
Grid voltage, negative peak	$-V_{g_p}$	max. 200 V
Cathode to heater voltage	V_{kf}	max. 70 V ¹⁾ +100 V _{RMS}

Heptode section

Anode voltage	V_{a0}	max. 550 V
	V_a	max. 100 V
Grids No.2 and 4 voltage	$V_{(g2, g4)_0}$	max. 550 V
	$V_{g2, g4}$	max. 50 V ²⁾
Anode dissipation	W_a	max. 0.5 W
Grids No.2 and 4 dissipation	W_{g2+g4}	max. 0.5 W
Cathode current	I_k	max. 8 mA
Grid No.1 resistor	R_{g1}	max. 3 MΩ
Grid No.3 resistor	R_{g3}	max. 3 MΩ
Grid No.1 voltage, negative peak	$-V_{g1p}$	max. 100 V
Grid No.3 voltage, negative peak	$-V_{g3p}$	max. 150 V
Cathode to heater voltage	V_{kf}	max. 100 V

1) Cathode positive with respect to heater.

2) The grids No.2 and 4 voltage should not be less than 6 V with an average tube under the worst probable operating conditions.

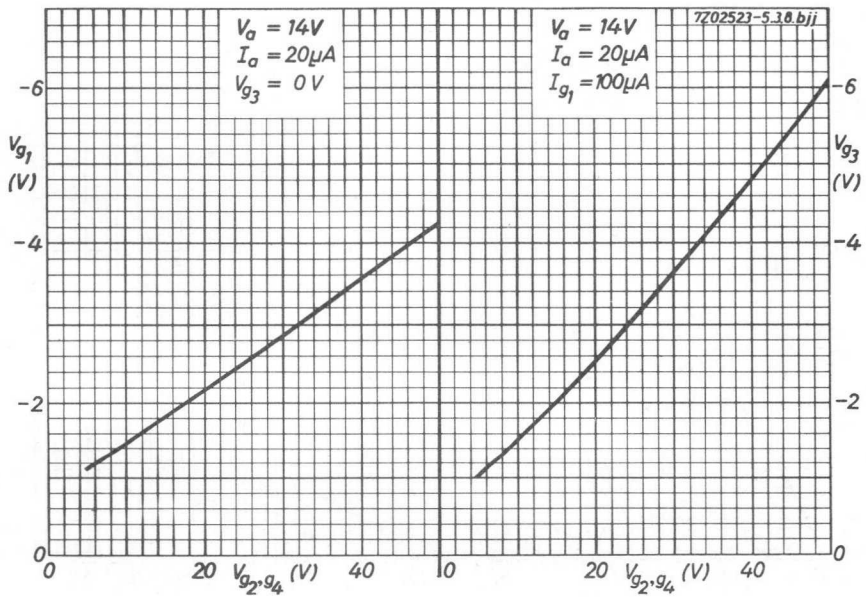
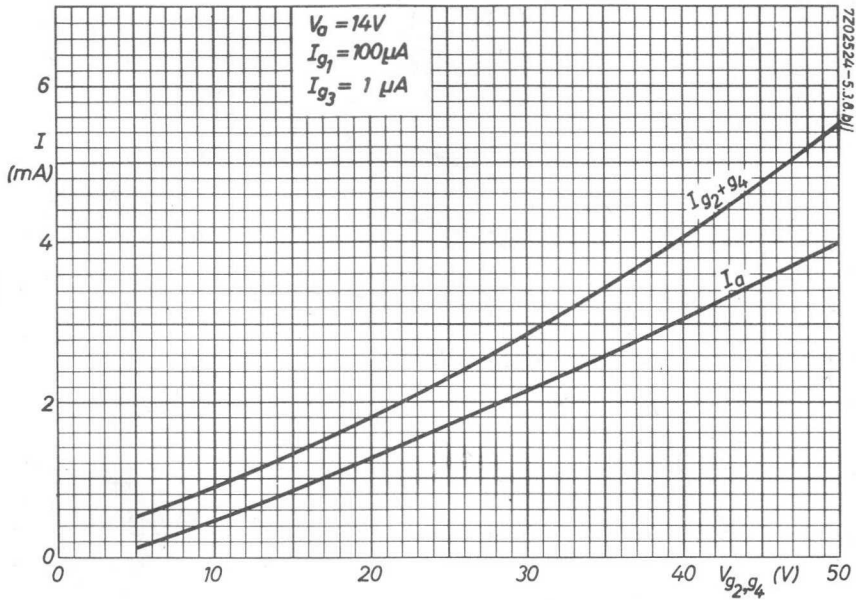

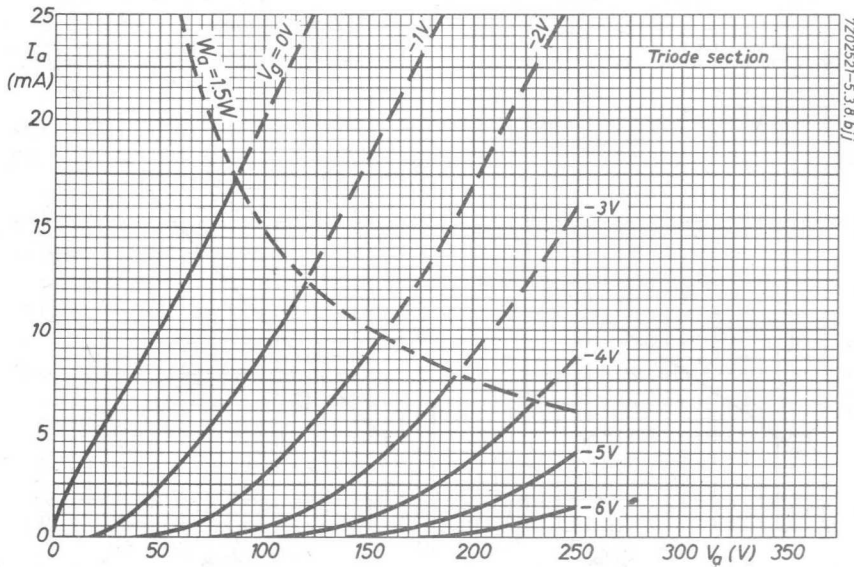
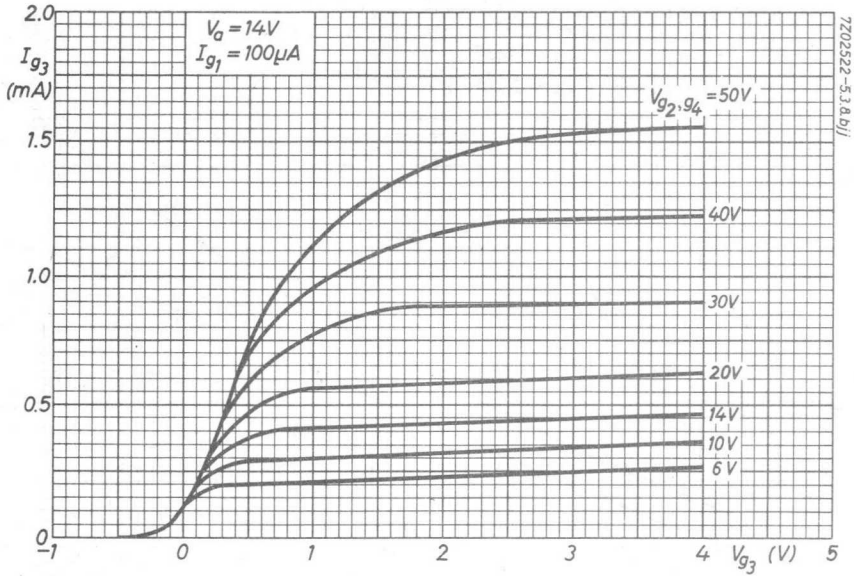

TRIODE-OUTPUT PENTODE

The triode section is intended for use as frame oscillator and A.F. amplifier. The pentode section is intended for use as frame output tube and A.F. power amplifier.

QUICK REFERENCE DATA			
<u>Triode section</u>			
Anode current	I_a	3.5	mA
Transconductance	S	2.2	mA/V
Amplification factor	μ	70	-
<u>Pentode section</u>			
Anode peak voltage	V_{ap}	max. 2.5	kV
Anode current	I_a	41	mA
Transconductance	S	7.5	mA/V
Amplification factor	$\mu_{g_2g_1}$	9.5	-
Output power	W_o	3.3	W

HEATING: Indirect by A.C. or D.C.; series supply

Heater current

I_f 300 mA

Heater voltage

V_f 16 V

DIMENSIONS AND CONNECTIONS

Dimensions in mm

Base: Noval

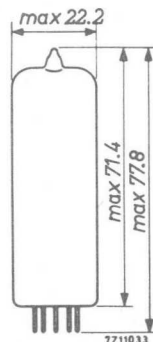
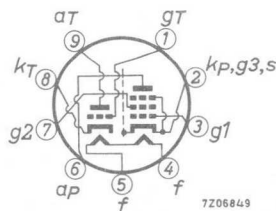

CAPACITANCES

Triode section

Anode to all except grid	$C_{a(g)}$	4.3	pF
Grid to all except anode	$C_{g(a)}$	2.7	pF
Anode to grid	C_{ag}	4.4	pF
Grid to heater	C_{gf}	max. 0.02	pF

Pentode section

Anode to all except grid No.1	$C_{a(g_1)}$	8.0	pF
Grid No.1 to all except anode	$C_{g_1(a)}$	9.3	pF
Anode to grid No.1	C_{ag_1}	max. 0.3	pF
Grid No.1 to heater	C_{g_1f}	max. 0.3	pF

Between triode and pentode sections

Anode triode to grid No.1 pentode	C_{aTg_1P}	max. 0.02	pF
Grid triode to anode pentode	C_{gTaP}	max. 0.02	pF
Grid triode to grid No.1 pentode	C_{gTg_1P}	max. 0.025	pF
Anode triode to anode pentode	C_{aTaP}	max. 0.25	pF

TYPICAL CHARACTERISTICS

Triode section

Anode voltage	V_a	100	V
Grid voltage	V_g	0	V
Anode current	I_a	3.5	mA
Transconductance	S	2.2	mA/V
Amplification factor	μ	70	-

Pentode section

Anode voltage	V_a	170	V
Grid No.2 voltage	V_{g_2}	170	V
Grid No.1 voltage	V_{g_1}	-11.5	V
Anode current	I_a	41	mA
Grid No.2 current	I_{g_2}	9	mA
Transconductance	S	7.5	mA/V
Amplification factor	$\mu_{g_2g_1}$	9.5	-
Internal resistance	R_i	16	k Ω

OPERATING CHARACTERISTICS

Triode section as A.F. amplifier

A. Signal source resistance	R_s	0.22		$M\Omega$		
Grid resistor	R_g	3		$M\Omega$		
Grid resistor of next stage	$R_{g'}$	0.68		$M\Omega$		
Supply voltage	V_b	200	170	V		
Cathode resistor	R_k	2.2	2.7	$k\Omega$		
Anode resistor	R_a	220	220	$k\Omega$		
Anode current	I_a	0.52	0.43	mA		
Voltage gain	V_o/V_i ¹⁾	52	51	-		
Max. output voltage	V_o max	26	25	V_{RMS}		
Distortion	d_{tot} ²⁾	1.6	2.3	%		
<hr/>						
B. Signal source resistance	R_s	0.22		$M\Omega$		
Grid resistor	R_g	22		$M\Omega$		
Grid resistor of next stage	$R_{g'}$	0.68		$M\Omega$		
Supply voltage	V_b	200	200	170	170	V
Cathode resistor	R_k	0	0	0	0	Ω
Anode resistor	R_a	100	220	100	220	$k\Omega$
Anode current	I_a	1.05	0.61	0.86	0.50	mA
Voltage gain	V_o/V_i ¹⁾	50	55	49	53	-
Max. output voltage	V_o max	24	25	19	20	V_{RMS}
Distortion	d_{tot} ³⁾	1.5	1.4	1.4	1.4	%

MICROPHONY AND HUM

The triode section can be used without special precautions against microphony and hum in circuits in which an input voltage $V_i \geq 10 \text{ mV}_{RMS}$ gives an output of 50 mW of the output stage. Z_g (50 Hz) = 0.25 $M\Omega$. The A.C. voltage between pin 4 and cathode should not exceed 6.3 V. If the tube is used in television circuits where the frequency of the heater supply is not synchronized with the frame frequency, this may cause interference due to hum. At page 8 the relation is shown between the permissible value of Z_{g1} of the pentode section and the A.C. voltage between pin 4 and the cathode. This curve applies to C_{g1f} is 0.8 pF (inclusive of wiring and tube socket).

1) Measured at small input voltage

2) At lower output voltages the distortion is proportionally lower.

3) At lower output voltages down to 5 V_{RMS} the distortion remains approximately constant. At values below 5 V_{RMS} the distortion is approximately proportional to V_o .

OPERATING CHARACTERISTICS

Pentode section

A.F. power amplifier, class A (measured with V_k constant)

Supply voltage	$V_{ba}=V_{bg_2}$	170	200	230	V		
Grid No.2 series resistor (non-decoupled)	R_{g_2}	0	470	1200	Ω		
Cathode resistor	R_k	200	330	490	Ω		
Load resistance	$R_{a\sim}$	3.25	4.5	6	$k\Omega$		
Grid No.1 driving voltage	V_i	0 0.61 5.9		0 0.66 6.7		0 0.75 7.8 V_{RMS}	
Anode current	I_a	42 - 44	35 - 37	30 - 31	mA		
Grid No.2 current	I_{g_2}	9.2 - 15.5	7.8 - 13.3	6.6 - 11.0	mA		
Output power	W_o	0 0.05 3.2	0 0.05 3.3	0 0.05 3.25	W		
Distortion	d_{tot}	- - 10	- - 10	- - 10	%		

A.F. power amplifier, class AB, two tubes in push-pull

Anode supply voltage	V_{ba}	200	230	V
Grid No.2 supply voltage	V_{bg_2}	200	200	V
Common cathode resistor	R_k	170	200	Ω
Load resistance	$R_{aa\sim}$	4.5	7	$k\Omega$
Grid No.1 driving voltage	V_i	0 14.2	0 13.0	V_{RMS}
Anode current	I_a	2x35 2x42.5	2x30 2x34.5	mA
Grid No.2 current	I_{g_2}	2x8 2x16.5	2x6.2 2x13.5	mA
Output power	W_o	0 9.3	0 10	W
Distortion	d_{tot}	- 6.3	- 5.5	%

Frame output application

The circuit should operate satisfactorily with peak anode current $I_{a_p} = 85$ mA at $V_a = 50$ V, $V_{g_2} = 170$ V, $I_f = 300$ mA. The minimum available I_{a_p} value at end of life is

- 70 mA at $V_a = 50$ V, $V_{g_2} = 170$ V, $I_f = 280$ mA
- 80 mA at $V_a = 50$ V, $V_{g_2} = 190$ V, $I_f = 280$ mA

LIMITING VALUES (Design centre rating system)

Triode section

Anode voltage	V_{a0}	max.	550 V
	V_a	max.	250 V
Anode peak voltage	V_{ap}	max.	600 V ¹⁾
Anode dissipation	W_a	max.	1 W
Cathode current, average	I_k	max.	15 mA
peak	I_{kp}	max.	100 mA ¹⁾
Grid resistor, for fixed bias	R_g	max.	1 M Ω
for automatic bias	R_g	max.	3 M Ω
Grid impedance at 50 Hz	Z_g	max.	0.5 M Ω
Cathode to heater voltage	V_{kf}	max.	200 V

Pentode section

Anode voltage	V_{a0}	max.	550 V
	V_a	max.	250 V
Anode peak voltage, positive	V_{ap}	max.	2.5 kV
negative	$-V_{ap}$	max.	500 V
Grid No.2 voltage	V_{g20}	max.	550 V
	V_{g2}	max.	250 V
Anode dissipation for frame output application	W_a	max.	5 W
for A.F. output application	W_a	max.	7 W
Grid No.2 dissipation, average	W_{g2}	max.	1.8 W
average for frame output application (W_a max 4 W)	W_{g2}	max.	2 W
peak	W_{g2p}	max.	3.2 W
Cathode current	I_k	max.	50 mA
Grid No.1 resistor, for fixed bias	R_{g1}	max.	1 M Ω
for automatic bias	R_{g1}	max.	2 M Ω
Cathode to heater voltage	V_{kf}	max.	200 V

¹⁾ Max. pulse duration 4% of a cycle with a maximum of 0.8 msec.

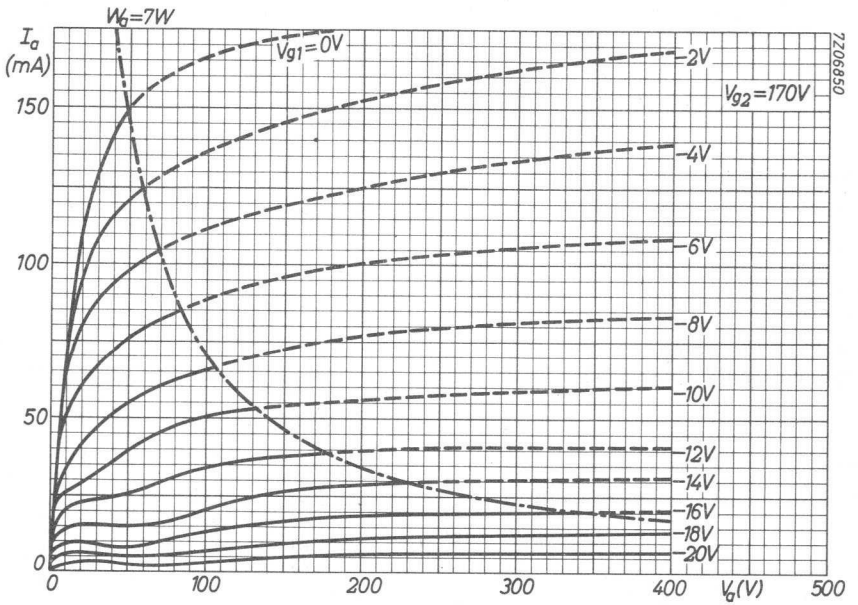
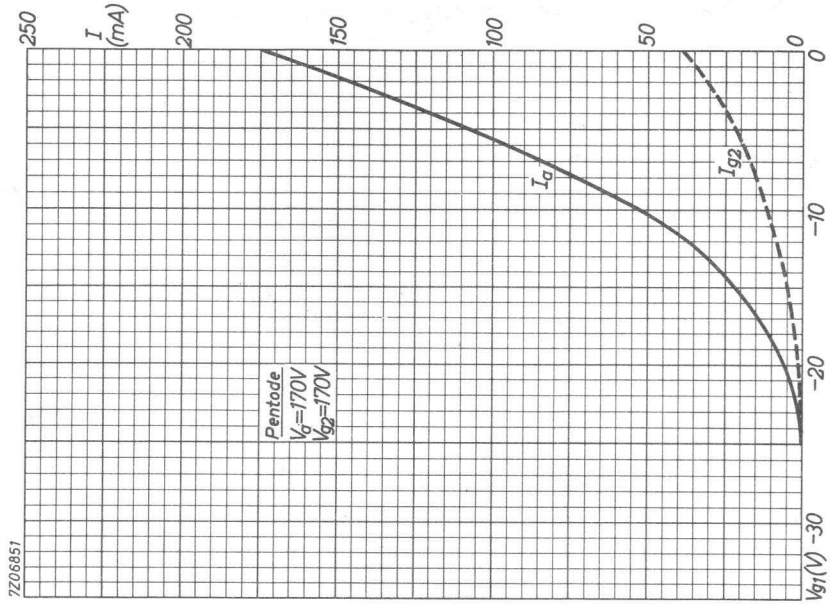

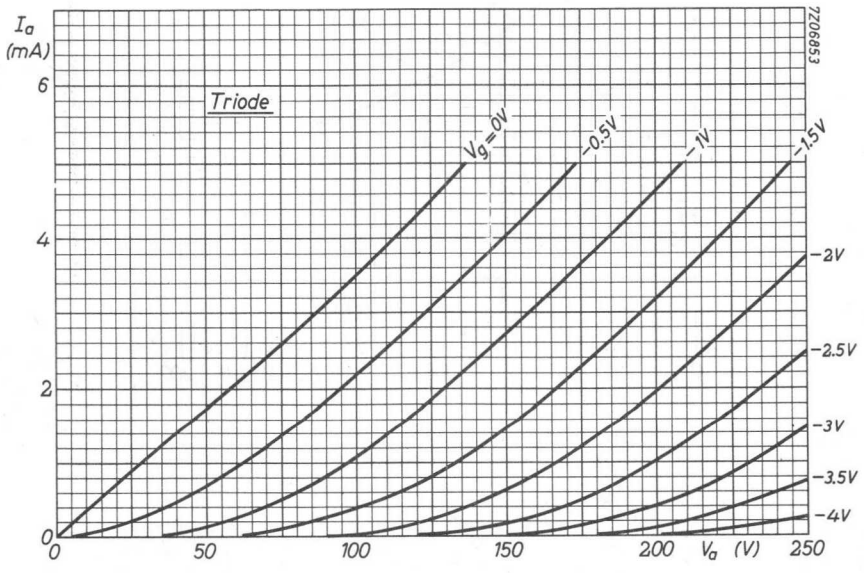
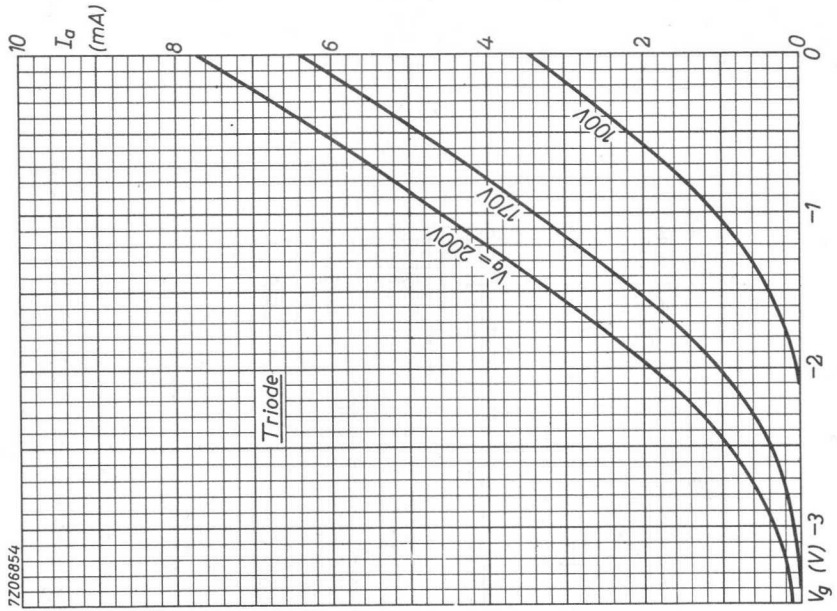

7206852

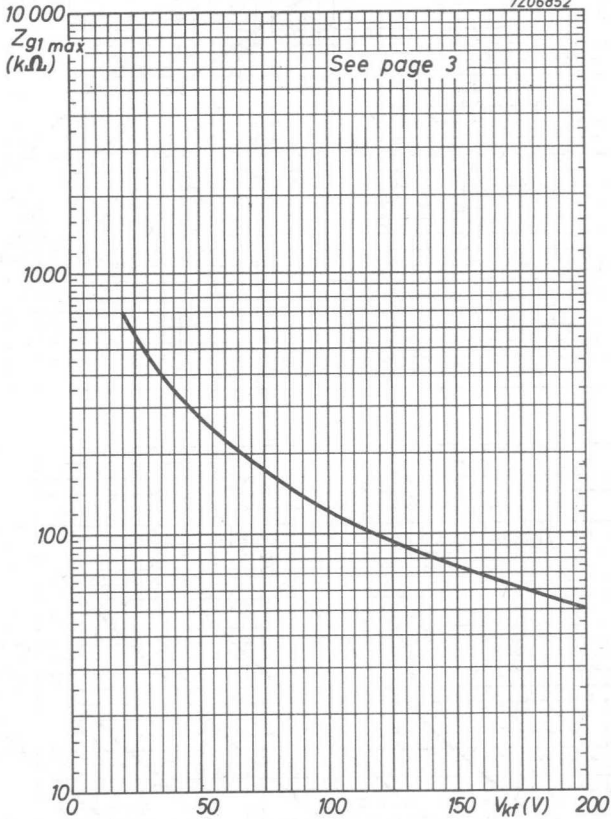

TRIODE-OUTPUT PENTODE

Triode-pentode with separate cathodes.

Triode section intended for use in circuits for keyed A.G.C., sync. separation, sync. amplification and noise suppression.

Pentode section is intended for use as video output tube.

QUICK REFERENCE DATA

Triode section

Anode current	I_a	3 mA
Transconductance	S	4 mA/V
Amplification factor	μ	65 -

Pentode section

Anode current	I_a	18 mA
Transconductance	S	11 mA/V
Amplification factor	$\mu_{g_2g_1}$	36 -

HEATING: Indirect by A.C. or D.C.; series supply

Heater current	I_f	300 mA
Heater voltage	V_f	15 V

DIMENSIONS AND CONNECTIONS

Dimensions in mm

Base: Noval

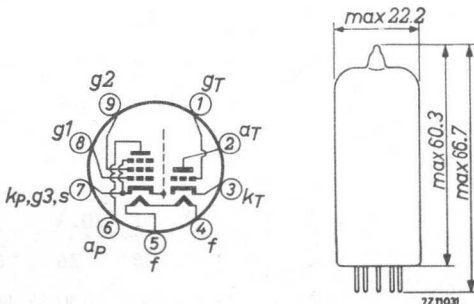

CAPACITANCES

Triode section

Anode to all except grid	$C_{a(g)}$	2.3 pF
Grid to all except anode	$C_{g(a)}$	3.8 pF
Anode to grid	C_{ag}	2.7 pF
Grid to heater	C_{gf} max.	0.1 pF

Pentode section

Anode to all except grid No. 1	$C_{a(g_1)}$	4.2 pF
Grid No. 1 to all except anode	$C_{g_1(a)}$	8.7 pF
Anode to grid No. 1	C_{ag_1} max.	0.1 pF
Grid No. 1 to heater	C_{g_1f} max.	0.1 pF

Between triode and pentode sections

Anode triode to grid No. 1 pentode	C_{a-Tg_1P} max.	0.01 pF
Grid triode to grid No. 1 pentode	C_{g-Tg_1P} max.	0.01 pF

TYPICAL CHARACTERISTICS

Triode section

Anode voltage	V_a	200 V
Grid voltage	V_g	-1.7 V
Anode current	I_a	3 mA
Transconductance	S	4 mA/V
Amplification factor	μ	65 -

Pentode section

Anode voltage	V_a	170	200	220	V
Grid No. 2 voltage	V_{g_2}	170	200	220	V
Grid No. 1 voltage	V_{g_1}	-2.1	-2.9	-3.4	V
Anode current	I_a	18	18	18	mA
Grid No. 2 current	I_{g_2}	3.0	3.0	3.0	mA
Transconductance	S	11	10.4	10	mA/V
Amplification factor	$\mu_{g_2g_1}$	36	36	36	-
Internal resistance	$R_{i\min}$	100	130	150	k Ω

OPERATING CHARACTERISTICS

Pentode sectionVideo output tube

Supply voltage	V_b	170	200	220	V
Grid No. 2 voltage	V_{g2}	170	200	220	V
Anode series resistor	R_a	3	3	3	k Ω
Grid No. 1 voltage	V_{g1}	-2	-2.8	-3.3	V
Anode current	I_a	18	18	18	mA
Grid No. 2 current	I_{g2}	3.2	3.1	3.1	mA
Transconductance	S	10.4	10.0	9.7	mA/V

LIMITING VALUES (Design centre rating system)Triode section

Anode voltage	V_{a0}	max.	± 550	V
	V_a	max.	± 300	V
Anode peak voltage (I_a max. 0.1 mA)	V_{ap}	max.	600	V ¹⁾
Anode dissipation	W_a	max.	1	W
Cathode current	I_k	max.	12	mA
Grid resistor, for fixed bias	R_g	max.	1	M Ω
for automatic bias	R_g	max.	3	M Ω
Cathode to heater voltage, cathode neg.	V_{kf}	max.	150	V
cathode pos.	V_{kf}	max.	200 V = +150	V _{RMS}

Pentode section

Anode voltage	V_{a0}	max.	550	V
	V_a	max.	300	V
Grid No. 2 voltage	V_{g20}	max.	550	V
	V_{g2}	max.	250	V
Anode dissipation	W_a	max.	4	W
Grid No. 2 dissipation	W_{g2}	max.	1.7	W
Cathode current	I_k	max.	40	mA
Grid No. 1 resistor, for fixed bias	R_{g1}	max.	1	M Ω
for automatic bias	R_{g1}	max.	2	M Ω
Cathode to heater voltage	V_{kf}	max.	200	V

¹⁾ Max. pulse duration 18% of a cycle with a maximum of 18 μ sec.

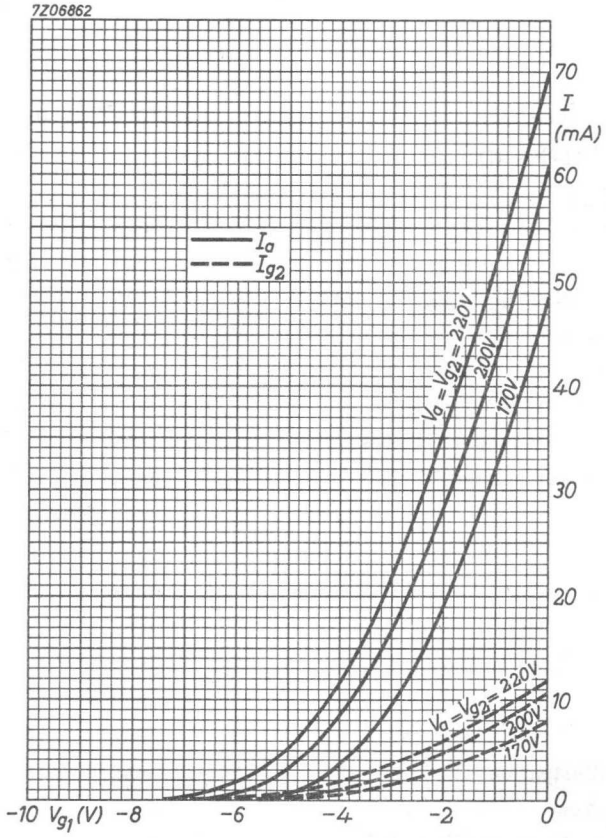

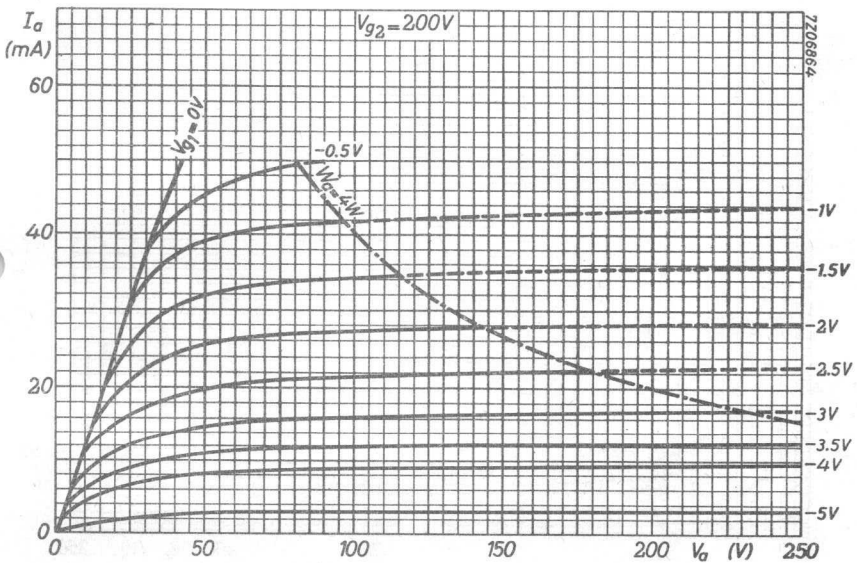
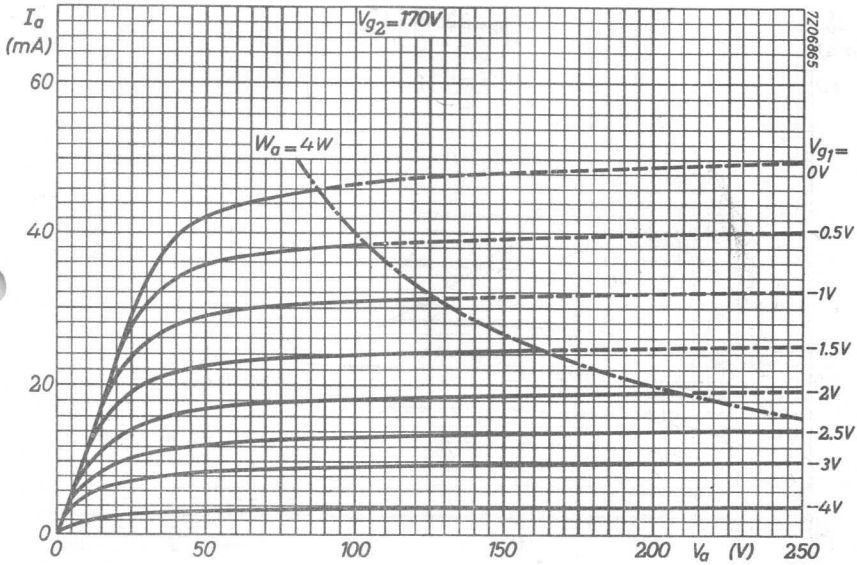

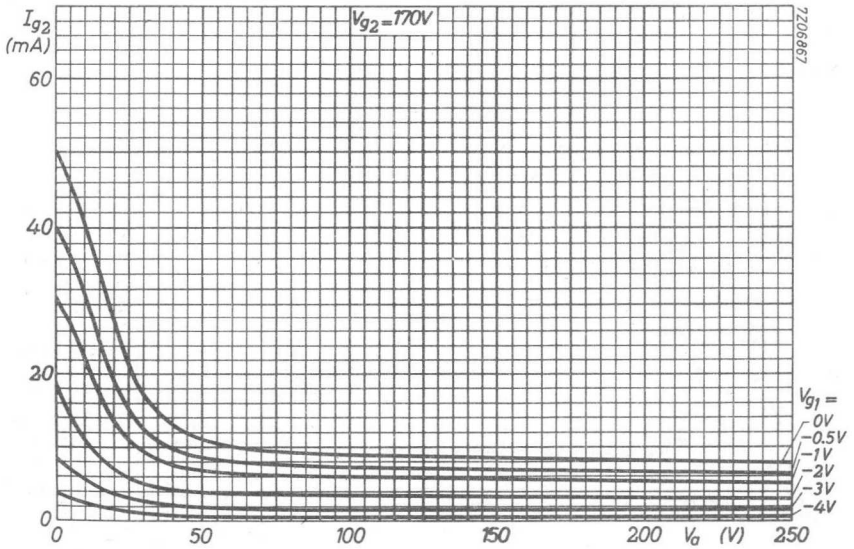
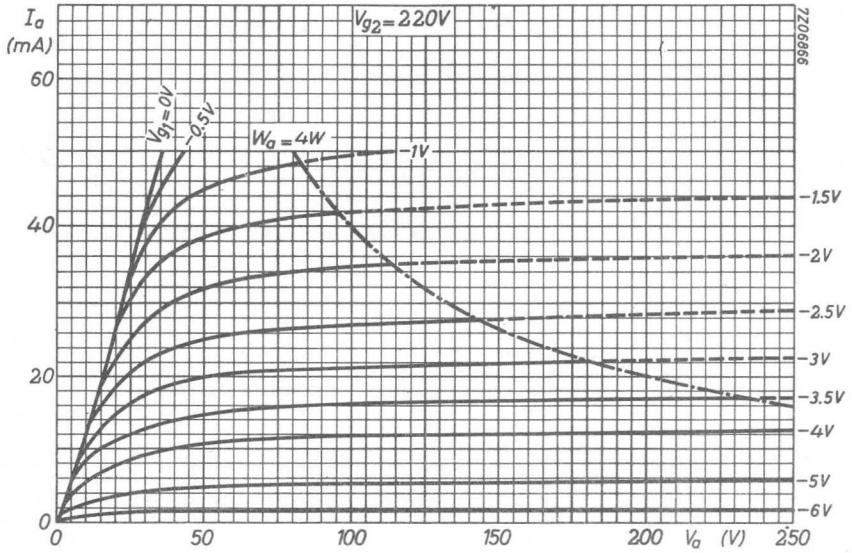

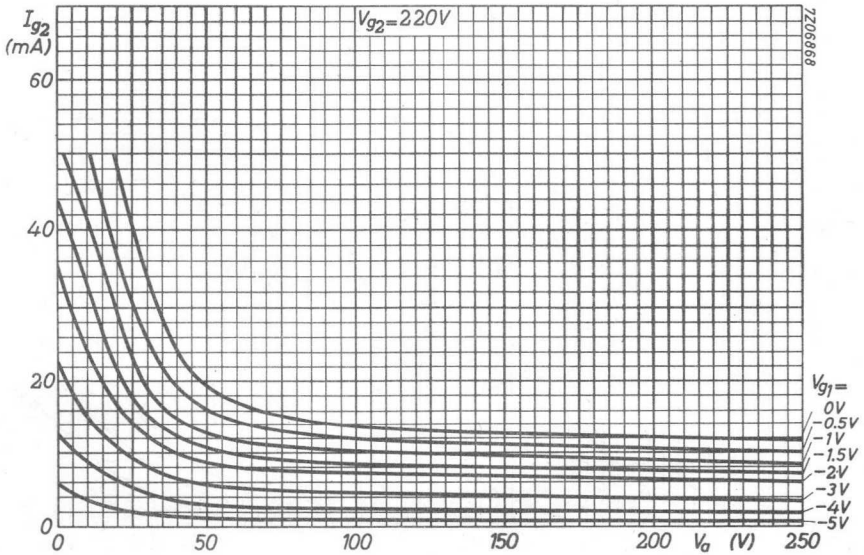
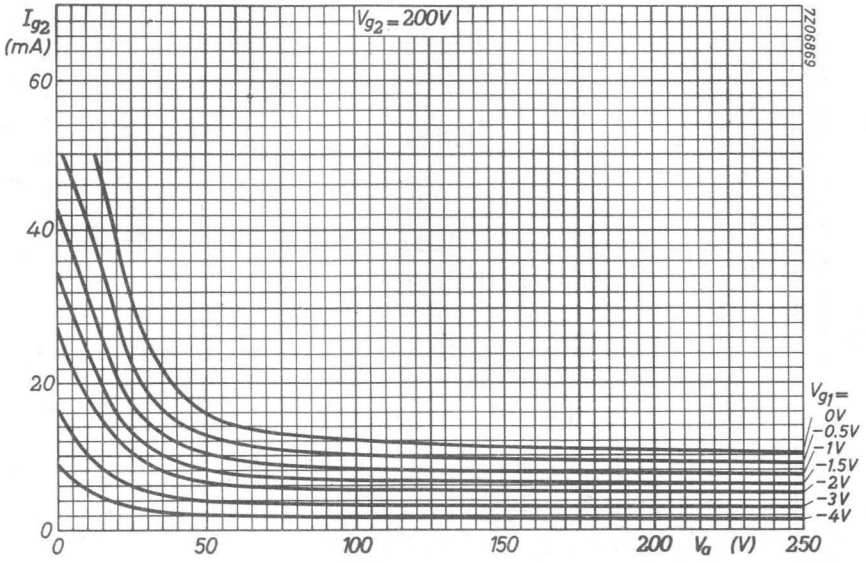

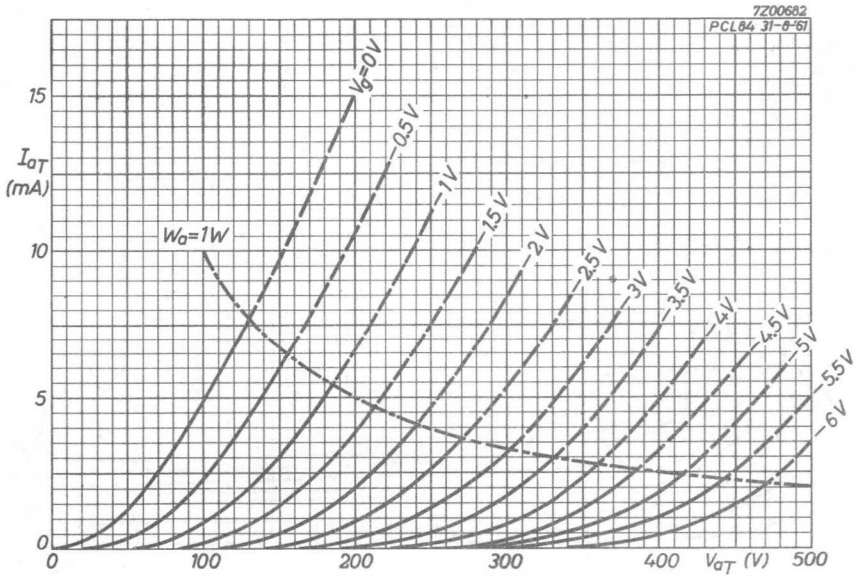
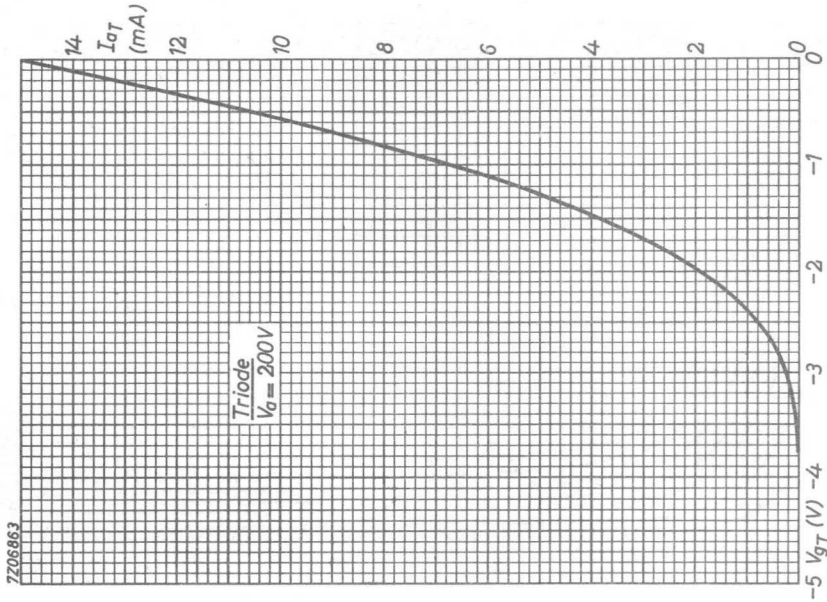

TRIODE-FRAME OUTPUT PENTODE

Triode-pentode with separate cathodes. Triode intended for use as frame oscillator or pulse amplifier.

Pentode intended for use as frame output tube.

QUICK REFERENCE DATA

<u>Triode section</u>			
Anode current	I_a	10.5	mA
Transconductance	S	7	mA/V
Amplification factor	μ	63	-
Cathode peak current	I_{kp}	max. 150	mA
<u>Pentode section</u>			
Anode peak voltage	V_{ap}	max. 2	kV
Cathode current	I_k	max. 75	mA
Anode dissipation	W_a	max. 8	W

HEATING: Indirect by A.C. or D.C.; series supply

Heater current

I_f 300 mA

Heater voltage

V_f 17.5 V

DIMENSIONS AND CONNECTIONS

Base: Noval

Dimensions in mm

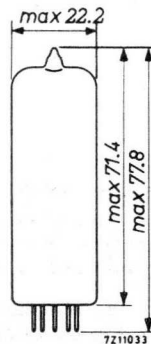
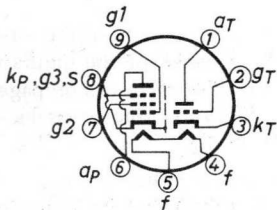

CAPACITANCES

Grid triode to anode pentode	C_{gTap}	max. 0.05 pF
Grid triode to heater	C_{gTf}	max. 0.15 pF
Grid No.1 pentode to anode pentode	C_{g1pap}	max. 1.0 pF
Grid No.1 pentode to anode triode	C_{g1paT}	max. 0.08 pF
Grid No.1 pentode to heater	C_{g1Pf}	max. 0.20 pF

TYPICAL CHARACTERISTICS

Triode section

Anode voltage	V_a	100	100	V
Grid voltage	V_g	-0.85	0	V
Anode current	I_a	5	10.5	mA
Transconductance	S	5.5	7.0	mA/V
Amplification factor	μ	60	63	-
Internal resistance	R_i	11	9	k Ω

OPERATING CHARACTERISTICS

Pentode section

Frame output application

Anode voltage	V_a	50	65	V
Grid No.2 voltage	V_{g2}	170	210	V
Grid No.1 voltage	V_{g1}	-1	-1	V
Anode peak current	I_{ap}	200	285	mA
Grid No.2 peak current	I_{g2p}	35	45	mA

Remarks

The minimum I_{ap} value to be expected as a result of spread of the tube characteristics, tube deterioration during life and decrease of the mains voltage to 10% below the nominal value, can be derived from the curves on page 9 by decreasing by 40% the I_a values of curve A-B at the V_{g2} value occurring at the decreased mains voltage.

In order not to exceed the maximum permissible value of W_{g2} , the circuit should be designed such that at a mains voltage of 10% below nominal, V_a at the end of scan will not be lower than the value determined by curve A-B at the relevant V_{g2} value.

HUM

The equivalent pentode grid hum voltage without negative feedback is max. 10 mV when Z_{g1} (at $f = 50$ Hz) ≤ 0.5 M Ω , $C_{g1-f} = 0.2$ pF and $V_{kf} = 150$ VRMS.

LIMITING VALUES (Design centre rating system)

Triode section

Anode voltage	V_{a0}	max. 550 V
	V_a	max. 300 V
Anode dissipation	W_a	max. 0.5 W
Cathode current		
average	I_k	max. 15 mA
peak	I_{kp}	max. 150 mA ¹⁾
peak	I_{kp}	max. 100 mA ²⁾
Grid resistor		
for fixed bias	R_g	max. 1 M Ω
for automatic bias	R_g	max. 3.3 M Ω
Cathode to heater voltage	V_{kf}	max. 200 V ³⁾

Remark

A cathode peak current of 100 mA will be available throughout life and at under-heating.

¹⁾ Max. pulse duration 2% of a cycle with a maximum of 400 μ sec.

²⁾ Max. pulse duration 4% of a cycle with a maximum of 800 μ sec.

³⁾ During warming up the D.C. component of $V_{kf} = \text{max. } 315$ V, k pos.

LIMITING VALUES (continued)

Pentode section

Anode voltage	V_{a0}	max. 550 V
	V_a	max. 300 V
Anode peak voltage	V_{ap}	max. 2 kV ¹⁾
Grid No.2 voltage	V_{g20}	max. 550 V
	V_{g2}	max. 250 V
Anode dissipation	W_a	max. 8 W ²⁾
Grid No.2 dissipation	W_{g2}	max. 1.5 W ³⁾
Cathode current	I_k	max. 75 mA
Grid No.1 resistor		
for fixed bias	R_{g1}	max. 1.0 M Ω
for automatic bias	R_{g1}	max. 2.2 M Ω
Cathode to heater voltage	V_{kf}	max. 200 V

¹⁾ Max. pulse duration 5% of a cycle with a maximum of 1 ms.

²⁾ For a nominal tube at the worst probable operating conditions and at normal picture height W_a should not exceed 10.5 W.

³⁾ For a nominal tube at the worst probable operating conditions and at normal picture height W_{g2} should not exceed 2 W.

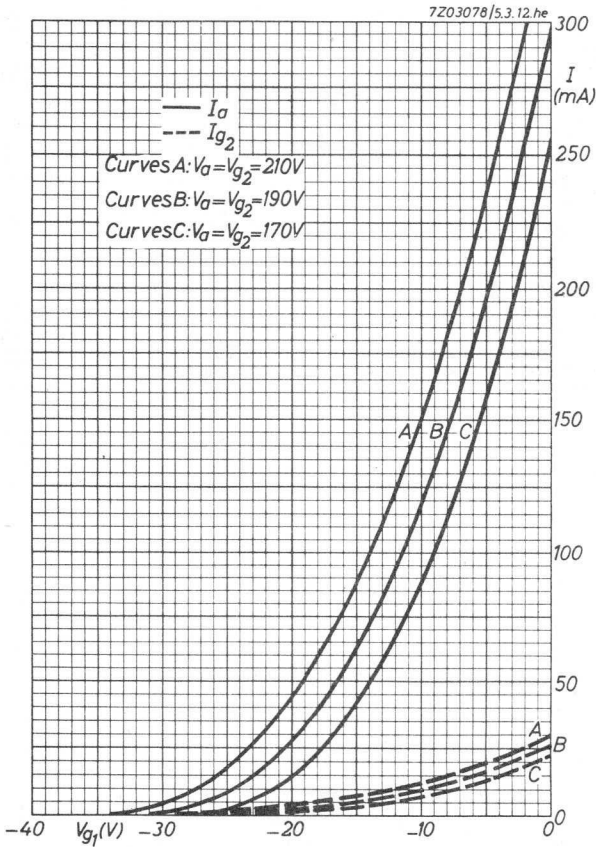

**PCL85
PCL805**

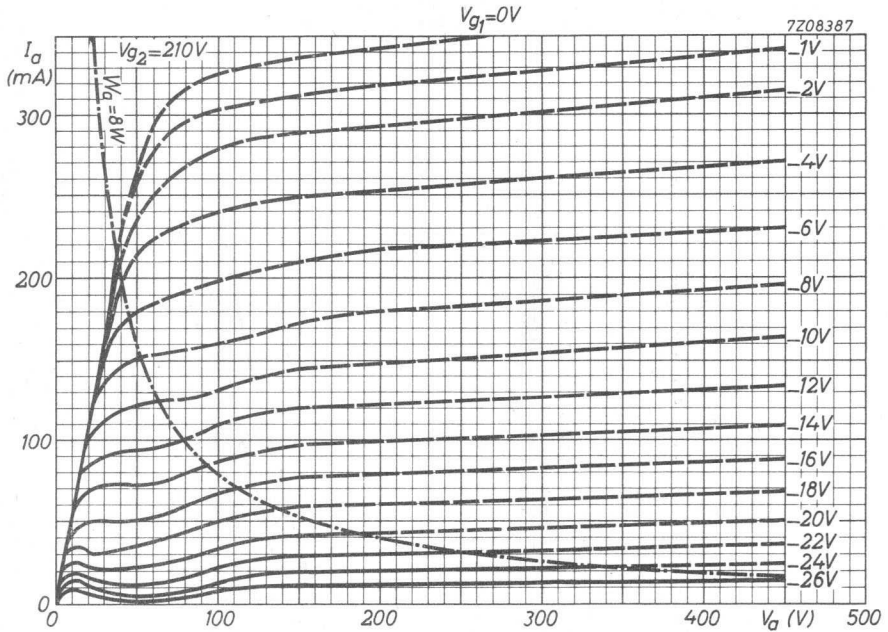

7203081 / 5.3.12. he

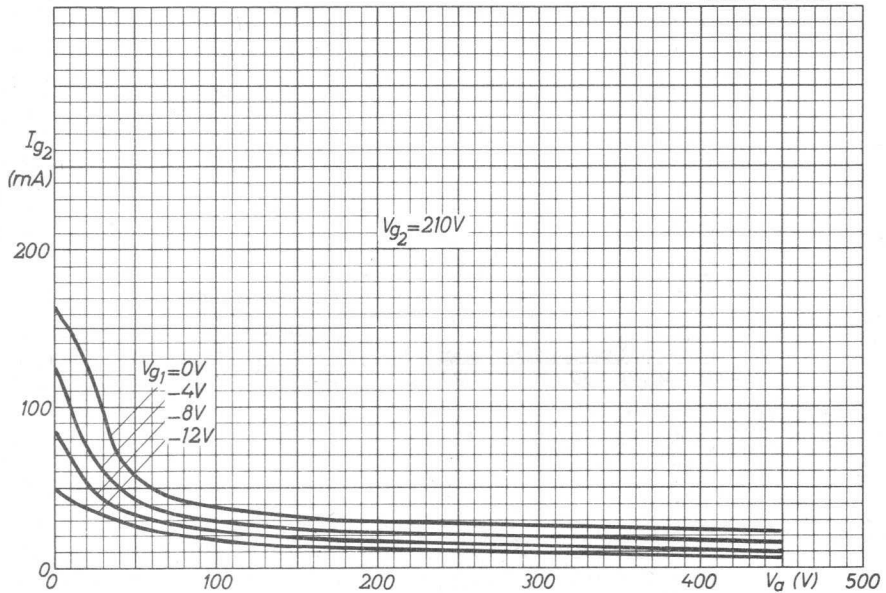

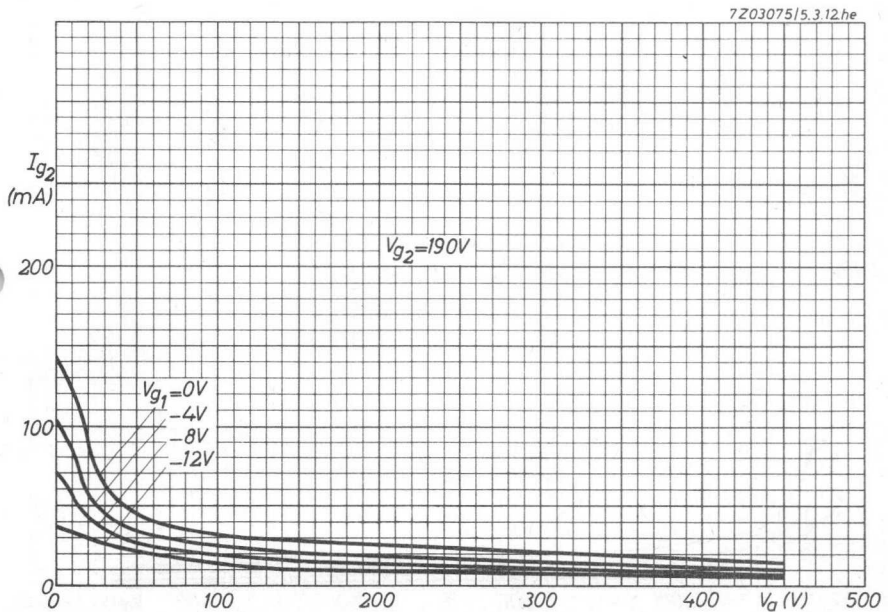
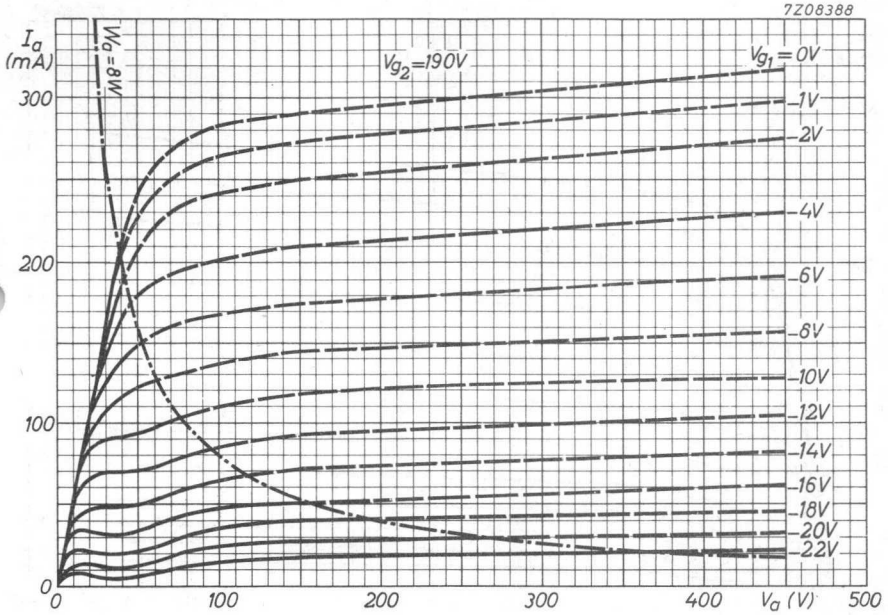

7Z08386

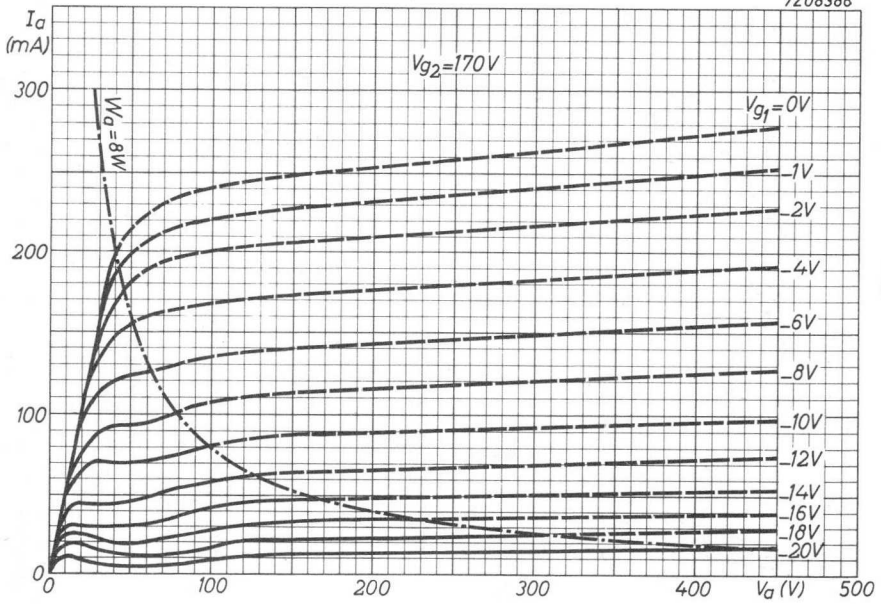

7Z03076/5.3.12.he

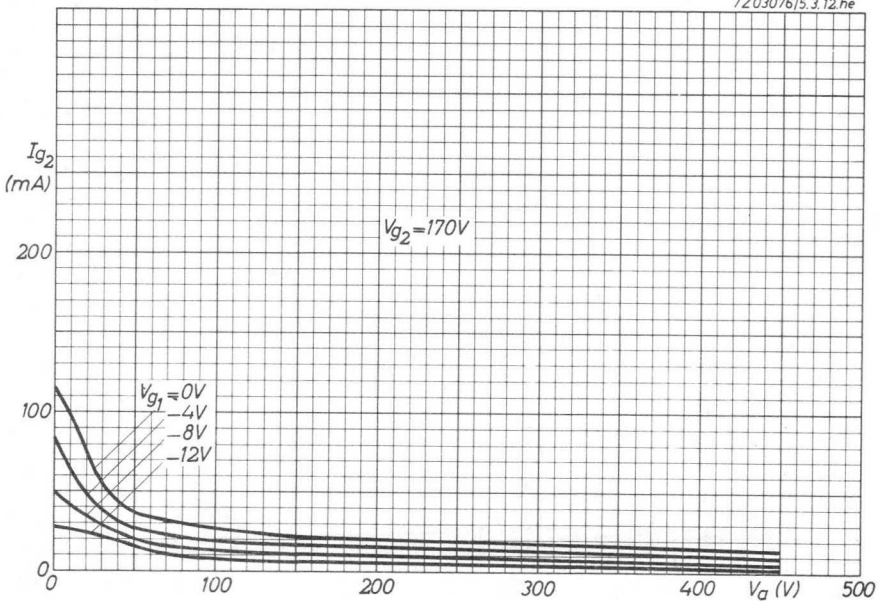

7Z03077/5.3.12.he

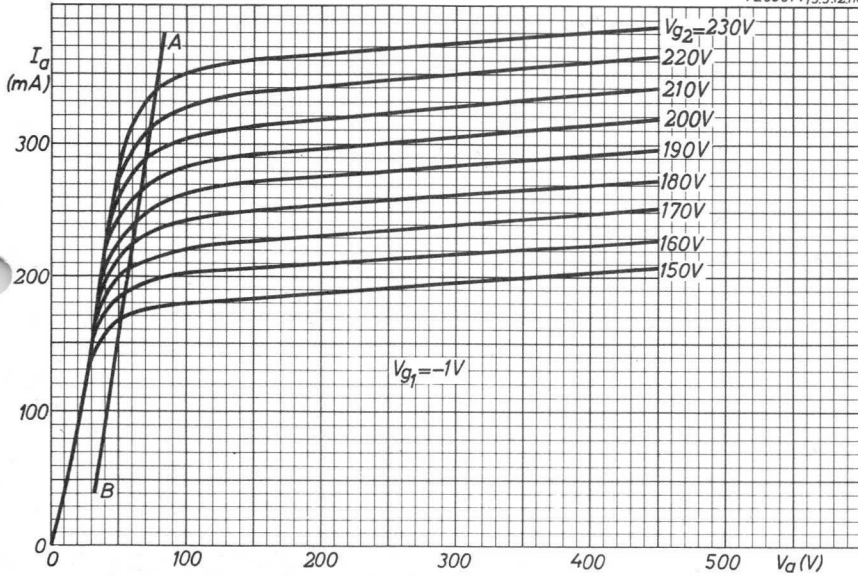

7Z09642

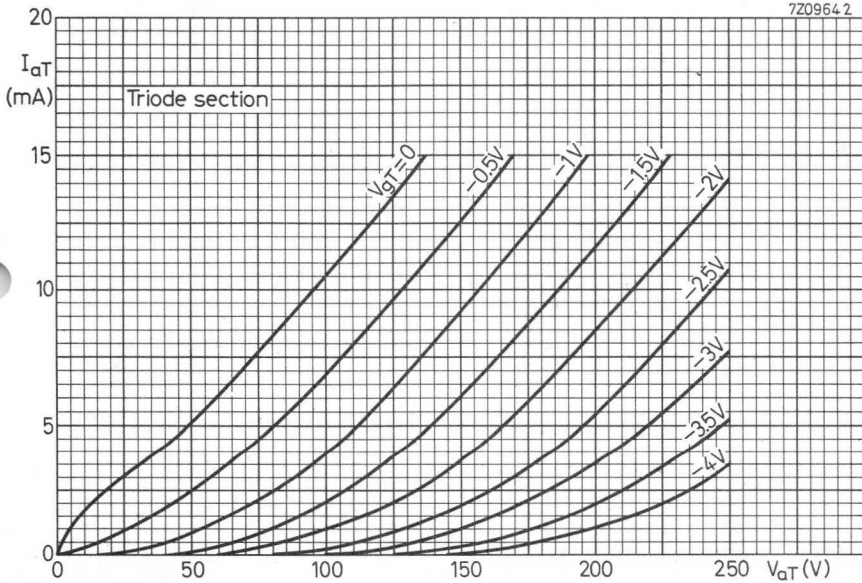

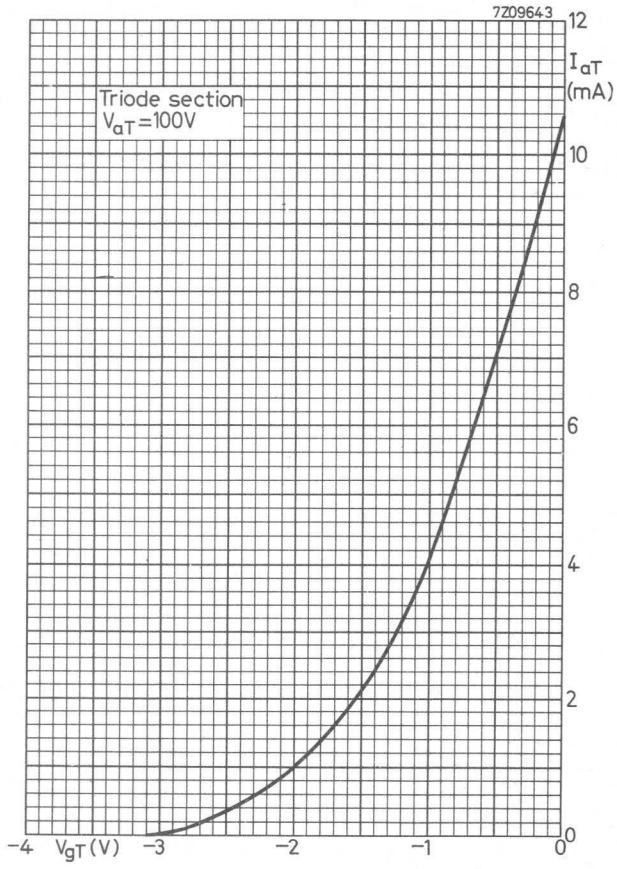

TRIODE-OUTPUT PENTODE

Triode-pentode with separate cathodes.

The triode section is intended for use as A.F. amplifier.

The pentode section is intended for use as A.F. power amplifier.

QUICK REFERENCE DATA

<u>Triode section</u>		
Anode current	I_a	1.2 mA
Transconductance	S	1.6 mA/V
Amplification factor	μ	100 -
<u>Pentode section</u>		
Anode current	I_a	39 mA
Transconductance	S	10.5 mA/V
Amplification factor	μ_{g2g1}	21 -
Output power	W_o	4.1 W

HEATING: Indirect by A.C. or D.C.; series supply

Heater current

I_f 300 mA

Heater voltage

V_f 13.3 V

DIMENSIONS AND CONNECTIONS

Dimensions in mm

Base: Noval

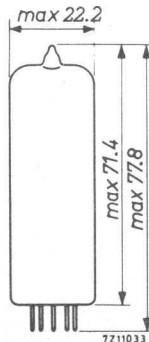
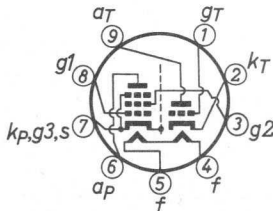

CAPACITANCES

Triode section

Anode to all except grid	$C_{a(g)}$	2.5	pF
Grid to all except anode	$C_{g(a)}$	2.3	pF
Anode to grid	C_{ag}	1.4	pF
Grid to heater	C_{gf}	max. 0.006	pF

Pentode section

Grid No. 1 to all except anode	$C_{g1(a)}$	10	pF
Anode to grid No. 1	C_{ag1}	max. 0.4	pF
Grid No. 1 to heater	C_{g1f}	max. 0.24	pF

Between triode and pentode sections

Anode triode to grid No. 1 pentode	C_{aTg1P}	max. 0.2	pF
Grid triode to grid No. 1 pentode	C_{gTg1P}	max. 0.02	pF
Anode triode to anode pentode	C_{aT^aP}	max. 0.15	pF
Grid triode to anode pentode	C_{gT^aP}	max. 0.006	pF ¹⁾

TYPICAL CHARACTERISTICS

Triode section

Anode voltage	V_a	230	V
Grid voltage	V_g	-1.7	V
Anode current	I_a	1.2	mA
Transconductance	S	1.6	mA/V
Amplification factor	μ	100	

Pentode section

Anode voltage	V_a	230	V
Grid No. 2 voltage	V_{g2}	230	V
Grid No. 1 voltage	V_{g1}	-5.7	V
Anode current	I_a	39	mA
Grid No. 2 current	I_{g2}	6.5	nA
Transconductance	S	10.5	mA/V
Amplification factor	μ_{g2g1}	21	
Internal resistance	R_i	45	k Ω

¹⁾ The capacitance between triode grid and pentode anode (C_{gT^aP}) can be reduced to a value of less than 0.002 pF by using a shielding ring with a diameter of 22.5 mm and a height of 15 mm with respect to the tube base.

OPERATING CHARACTERISTICS

Triode sectionA. F. amplifier

Supply voltage	V_b	200	230	200	230	V
Cathode resistor	R_k	0	0	2.6	2.1	$k\Omega$
Anode resistor	R_a	220	220	220	220	$k\Omega$
Grid resistor	R_g	10	10	-	-	$M\Omega$
Grid resistor of following stage	R_g'	680	680	680	680	$k\Omega$
Signal source resistance	R_s	47	47	-	-	$k\Omega$
Anode current	I_a	0.42	0.52	0.42	0.52	mA
Output voltage	V_o	3.2	3.2	3.2	3.2	V_{RMS}
Voltage gain	V_o/V_i	66	68	66	68	
Distortion	d_{tot}	0.6	0.5	0.6	0.5	%

Microphony

The triode section can be used without special precautions against microphonic effect in circuits in which an output of 50 mW is obtained at an input voltage of not less than 10 mV_{RMS}.

Hum

The hum level will be better than 60 dB under the following conditions;

Input voltage minimum 10 mV_{RMS} for 50 mW output.

Grid circuit impedance max. 0.5 $M\Omega$ at 50 Hz.

Cathode decoupling capacitor minimum 100 μF .

Pin 4 connected to earth.

A.C. voltage between pin 4 and cathode max. 30 V_{RMS}.

OPERATING CHARACTERISTICS

Pentode section

Class A (Measured with V_k constant)

Anode voltage	V_a	200	230	V
Grid No. 2 voltage	V_{g2}	200	230	V
Cathode resistor	R_k	115	125	Ω
(Grid No. 1 voltage)	V_{g1}	-4.7	-5.7	V)
Load resistance	$R_{a\sim}$	5.6	5.1	$k\Omega$
Grid No. 1 driving voltage	V_i	0 0.32 3.2	0 0.34 3.6	V_{RMS}
Anode current	I_a	35 - 34	39 - 40.7	mA
Grid No. 2 current	I_{g2}	6.0 - 9.0	6.5 - 10.5	mA
Output power	W_o	0 0.05 3.1	0 0.05 4.1	W
Distortion	d_{tot}	- 0.9 10	- 0.9 10	%

LIMITING VALUES (Design centre rating system)

Triode section

Anode voltage	V_{a0}	max.	550 V
	V_a	max.	300 V
Anode dissipation	W_a	max.	0.5 W
Cathode current	I_k	max.	4 mA
Grid resistor	R_g	max.	1 $M\Omega$ ¹⁾
Cathode to heater voltage	V_{kf}	max.	100 V

Pentode section

Anode voltage	V_{a0}	max.	550 V
	V_a	max.	300 V
Grid No. 2 voltage	V_{g20}	max.	550 V
	V_{g2}	max.	300 V
Anode dissipation	W_a	max.	9 W
Grid No. 2 dissipation, average	W_{g2}	max.	1.8 W
peak	W_{g2p}	max.	3.25 W
Cathode current	I_k	max.	55 mA
Grid No. 1 resistor, for automatic bias	R_{g1}	max.	1 $M\Omega$
Cathode to heater voltage	V_{kf}	max.	100 V

¹⁾ This value applies to operation with fixed bias. It may be multiplied by the D.C. inverse feedback factor resulting from e.g. cathode or anode resistors to a maximum of 10 $M\Omega$.

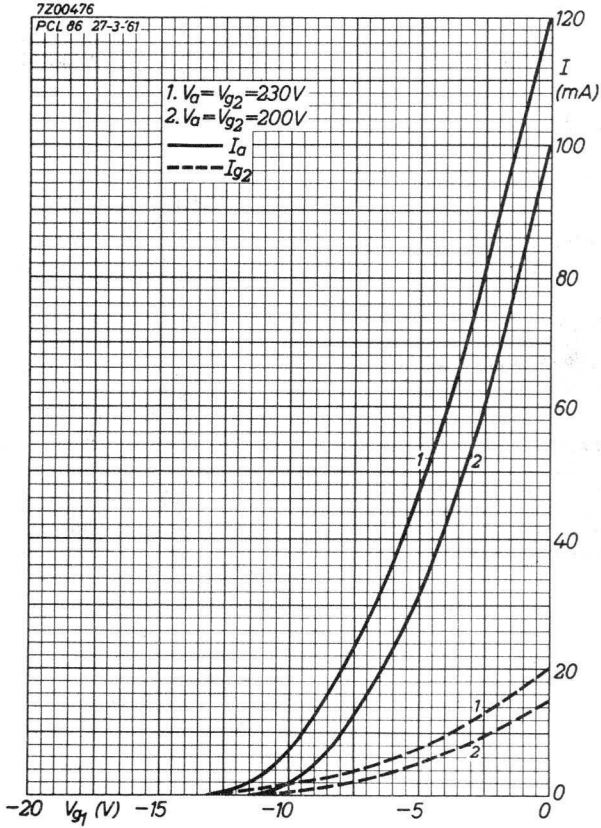

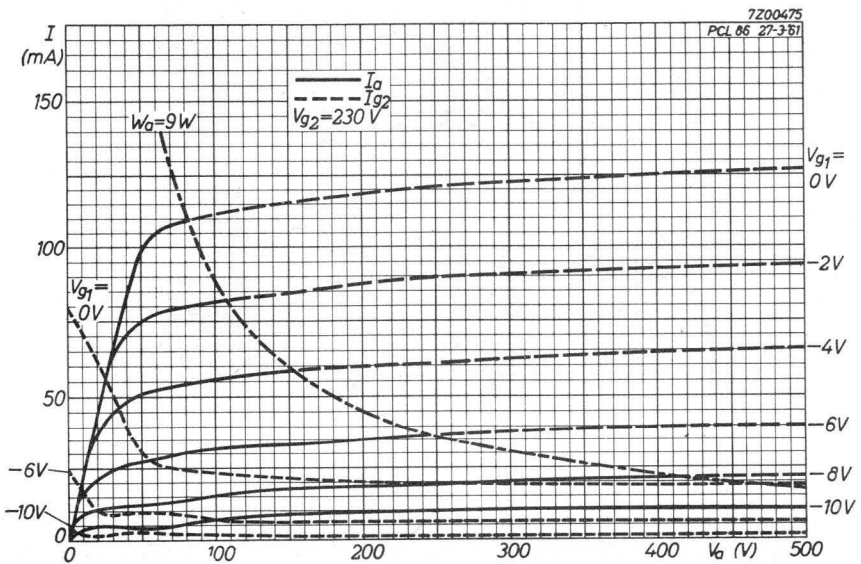
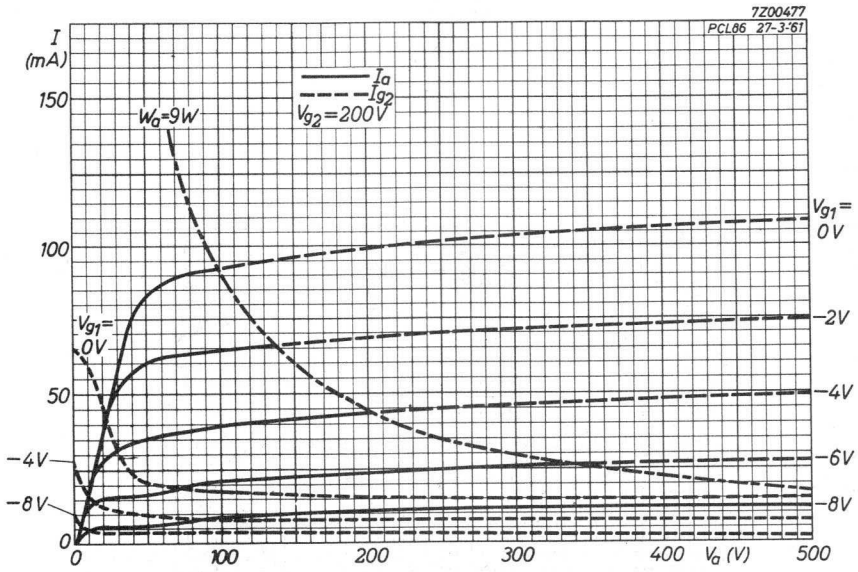

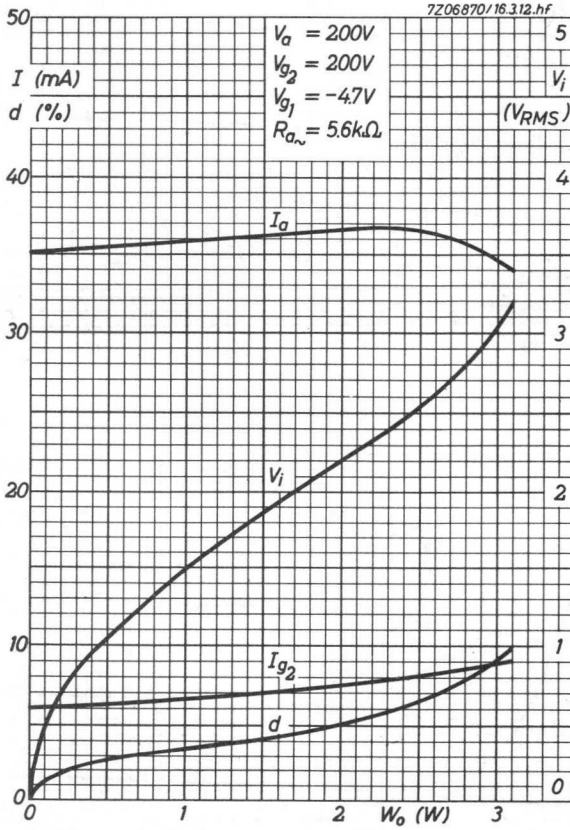

7Z06871/16.312.hf

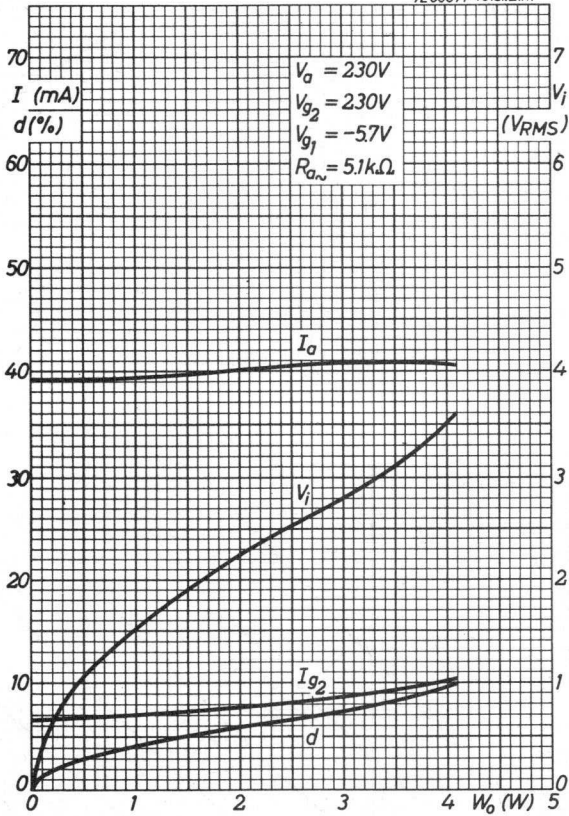

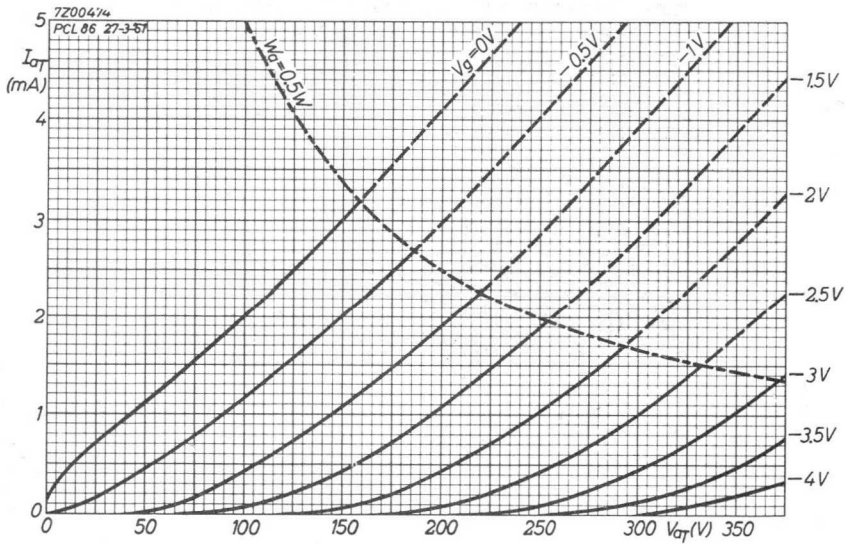
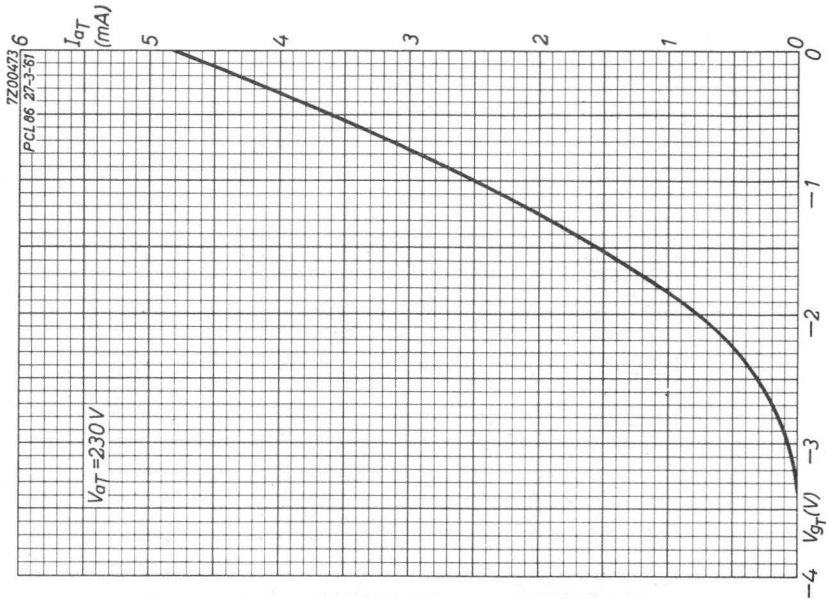

SHUNT STABILIZER TRIODE

Shunt stabilizer triode intended for use as in colour TV receivers.

QUICK REFERENCE DATA		
Anode voltage	V_a	25 kV
Anode current	I_a	max. 1.6 mA

HEATING: Indirect by A.C. or D.C.; series supply

Heater current	I_f	300 mA
Heater voltage	V_f	7.3 V

DIMENSIONS AND CONNECTIONS

Dimensions in mm

Base: Magnoval

Top cap: Type 2

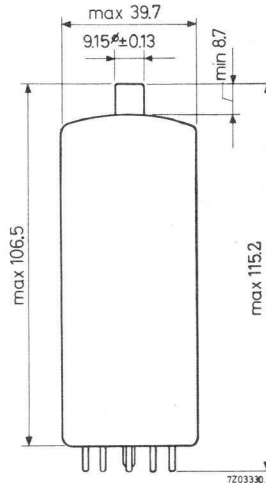
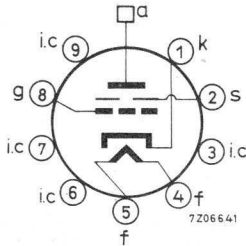

Mounting: Additional supporting of the tube at the top is required.

To prevent corona-effects any metal screening applied around the tube should be at least 5 cm from the nearest point of the bulb.

Adequate ventilation should be provided for.

TYPICAL CHARACTERISTICS

Anode voltage	V_a	25 kV
Screen voltage	V_s	0 V
Grid voltage change for an anode current change from 0.1 to 1.5 mA	ΔV_g	max. 10 V
Grid voltage at $I_a = 1.5$ mA	V_g	-7 to -30 V
at $I_a = 0.1$ mA	V_g	max. -40 V

LIMITING VALUES (Design centre rating system unless otherwise specified)

Anode voltage	V_a	max.	25 kV
Anode voltage (absolute max.)	V_a	max.	27.5 kV ¹⁾
Anode current	I_a	max.	1.6 mA
Anode dissipation	W_a	max.	30 W
Anode dissipation (absolute max.)	W_a	max.	40 W ²⁾
Negative grid voltage	$-V_g$	max.	150 V ³⁾
Grid resistor	R_g	max.	5 M Ω
Cathode to heater voltage			
cathode positive	V_{kf}	max.	400 V _{DC} +250 V _{AC}
cathode negative	$-V_{kf}$	max.	250 V
Screen voltage	V_s	max.	0 V
	$-V_s$	max.	400 V ⁴⁾
Anode seal temperature (absolute max.)	t_s	max.	200 °C

Precaution: x-ray shielding may be required to give protection against excessive radiation.

- 1) If due to a circuit failure the anode current becomes 0 mA the anode voltage should never exceed 45 kV (abs. max.)
- 2) Permissible only during short periods; in total up to a maximum of 10% of the operation time of the tube.
- 3) During equipment warm-up and for brief interval during receiver adjustment this voltage may rise to 440 V max.
- 4) The screen connected to pin 2 is provided to shield grid and cathode from the high anode voltage.
It is recommended to connect the screen directly to earth, with a minimum lead inductance.
The modulating influence of possible hum ripple of the screen to cathode voltage should be taken into account; the sensitivity for these variations in V_s/k is 2.5 $\mu A/V$ max.

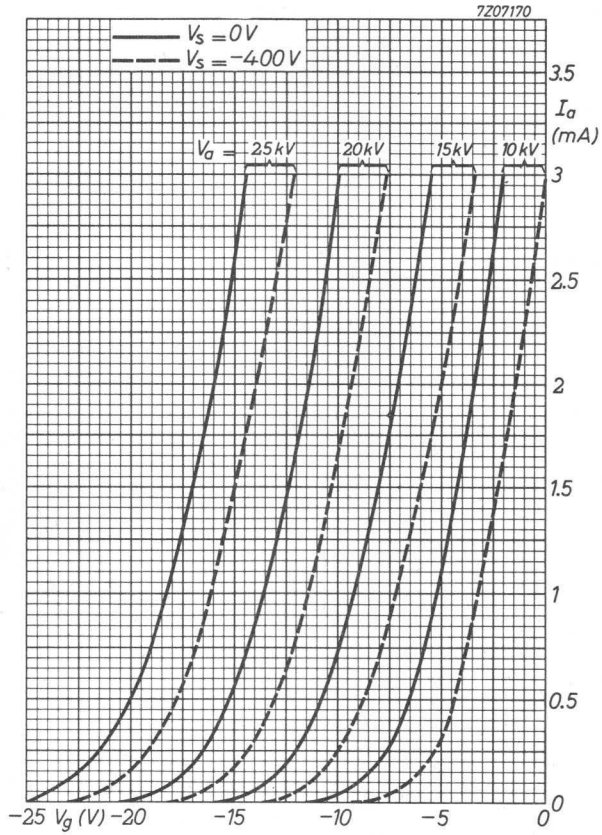

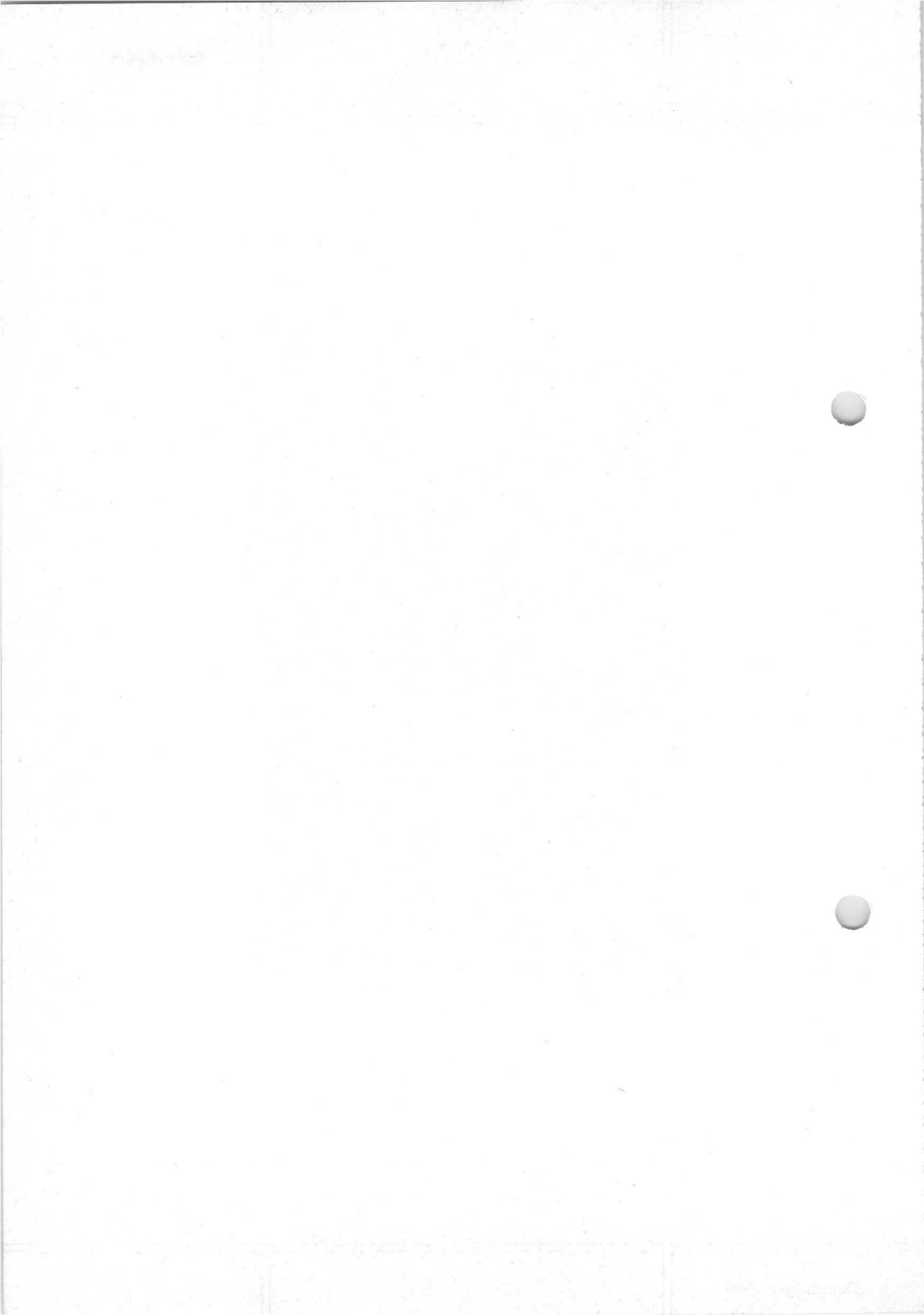

SHUNT STABILIZER TRIODE

Shunt stabilizer triode intended for use in colour TV receivers.

HEATING: Indirect by A.C. or D.C.; series supply

Heater current	I_f	300	mA
Heater voltage	V_f	7.3	V

DIMENSIONS AND CONNECTIONS

Dimensions in mm.

Base: Magnoval
Top cap: Type 2

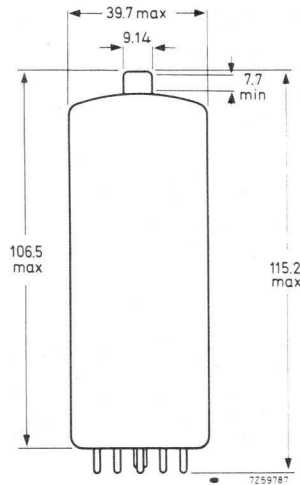
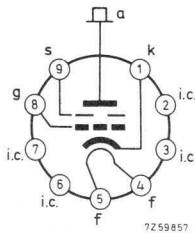

Mounting: Additional supporting of the tube at the top is required. To prevent corona effects any metal screening applied around the tube should be at least 5 cm from the nearest point of the bulb. Adequate ventilation should be provided for.

TYPICAL CHARACTERISTICS

Anode voltage	V_a	25	kV
Screen voltage	V_s	0	V
Grid voltage change for an anode current change from 0.1 mA to 1.5 mA	ΔV_g	max. 10	V
Grid voltage at $I_a = 1.5$ mA	V_g	-9 to -28	V
at $I_a = 0.1$ mA	V_g	max. -38	V

Data based on pre-production tubes

LIMITING VALUES (Design centre rating system unless otherwise specified)

Anode voltage	V_a	max.	25	kV
Anode voltage (absolute max.)	V_a	max.	27.5	kV 1)
Anode current	I_a	max.	1.6	mA
Anode dissipation	W_a	max.	30	W
Anode dissipation (absolute max.)	W_a	max.	40	W 2)
Negative grid voltage	$-V_g$	max.	150	V 3)
Grid resistor	R_g	max.	5	MΩ
Cathode to heater voltage				
cathode positive	V_{kf}	max.	400 V_{DC} + 250 V_{AC}	
cathode negative	$-V_{kf}$	max.	250	V
Screen voltage	V_s	max.	0	V
	$-V_s$	max.	50	V 4)
Anode seal temperature (absolute max.)	t_s	max.	200	°C

X-RAYS

When operating this tube will produce X-radiation, and a suitable screen may be required.

Because of the difference in X-ray characteristics the PD510 should never be replaced by a PD500 in equipment designed for the PD510.

-
- 1) If due to a circuit failure the anode current becomes 0 mA the anode voltage should never exceed 45 kV (abs. max.)
 - 2) Permissible only during short periods; in total up to a maximum of 10% of the operation time of the tube.
 - 3) During equipment warm-up and for brief interval during receiver adjustment this voltage may rise to 440 V max.
 - 4) The screen connected to pin 9 is provided to shield grid and cathode from the high anode voltage.
It is recommended to connect the screen directly to earth, with a minimum lead inductance.

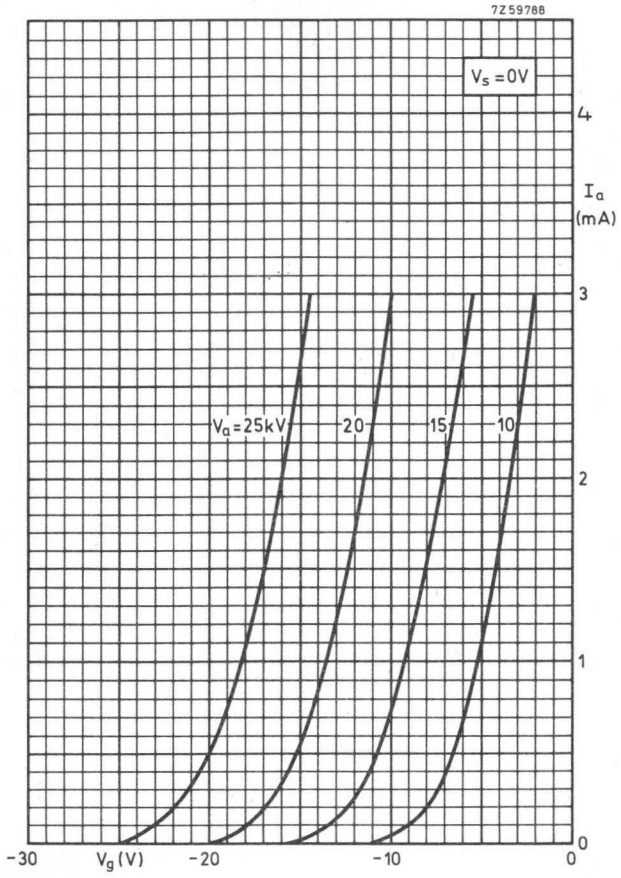

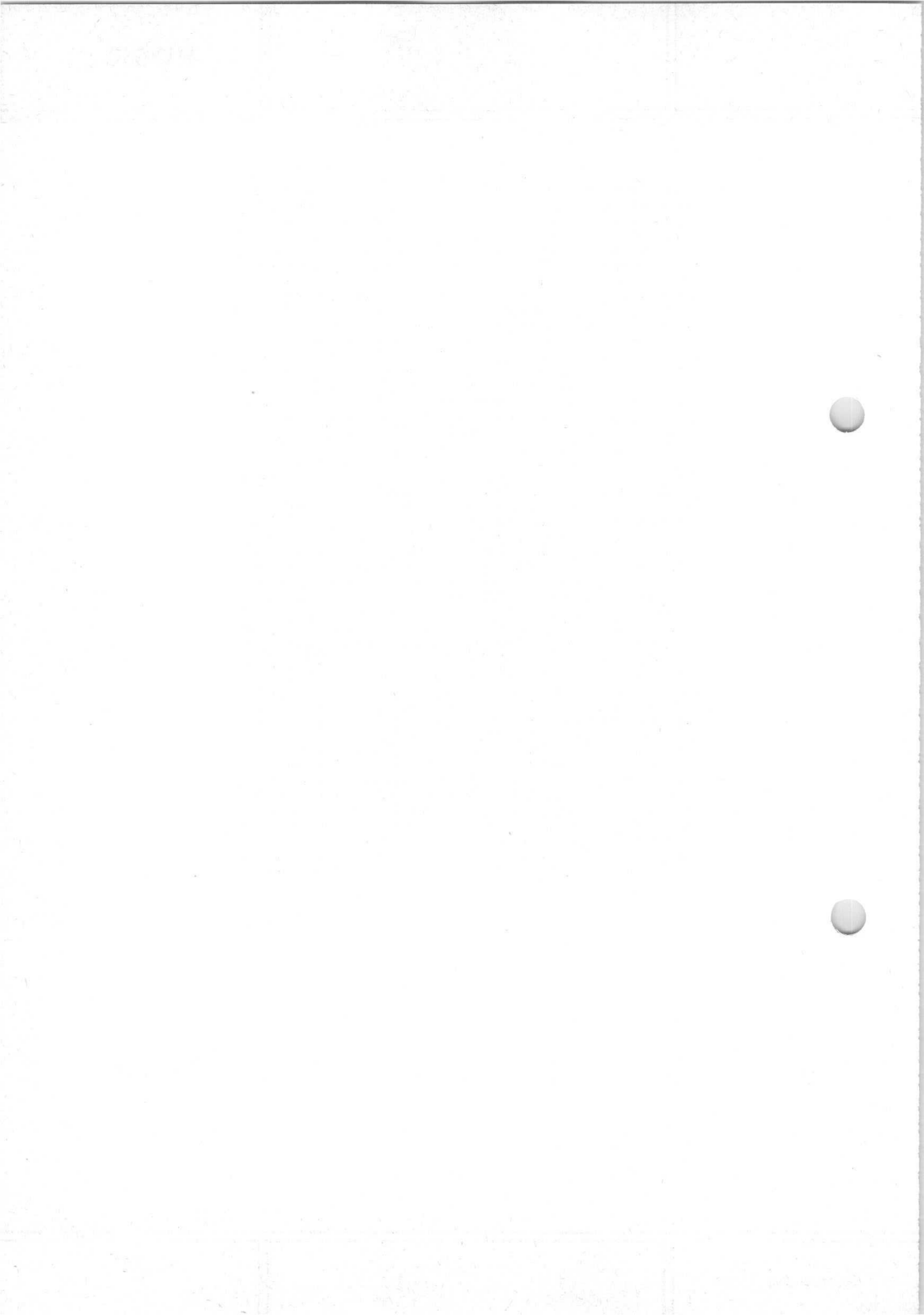

PENTODE

Pentode intended for use in transitron circuits in television receivers.

QUICK REFERENCE DATA			
Anode current	I_a	3.0	mA
Transconductance	S	2.2	mA/V
Amplification factor	$\mu_{g_2g_1}$	38	-
Internal resistance	R_i	2.5	M Ω

HEATING: Indirect by A. C. or D. C.; series supply

Heater current	I_f	300	mA
Heater voltage	V_f	4.5	V

DIMENSIONS AND CONNECTIONS

Dimensions in mm

Base: Noval

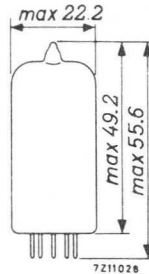
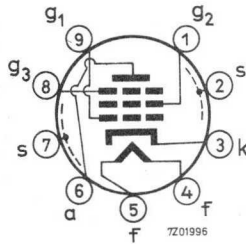

CAPACITANCES

Anode to all except grid No. 1	$C_{a(g_1)}$	5.1	pF
Grid No. 1 except anode	$C_{g_1(a)}$	3.5	pF
Anode to grid No. 1	C_{ag_1}	max. 0.07	pF
Grid No. 1 to heater	C_{g_1f}	max. 0.03	pF

TYPICAL CHARACTERISTICS

Anode voltage	V_a	100	250	V
Grid No.3 voltage	V_{g3}	-30	0	V
Grid No.2 voltage	V_{g2}	35	140	V
Grid No.1 voltage	V_{g1}	0	-2.2	V
Anode current	I_a	max.0.01	3.0	mA
Grid No.2 current	I_{g2}		0.6	mA
Transconductance	S		2.2	mA/V
Amplification factor	μ_{g2g1}		38	-
Internal resistance	R_i		2.5	$M\Omega$

LIMITING VALUES (Design centre rating system)

Anode voltage	V_{a0}	max.	550	V
	V_a	max.	300	V
Anode dissipation	W_a	max.	1	W
Grid No.2 voltage	V_{g20}	max.	550	V
	V_{g2}	max.	200	V
Grid No.2 dissipation	W_{g2}	max.	0.2	W
Cathode current, average	I_k	max.	4	mA
peak	I_{kp}	max.	25	mA ¹⁾
Grid No.1 resistor ($W_a < 0.2$ W)	R_{g1}	max.	10	$M\Omega$
($W_a > 0.2$ W)	R_{g1}	max.	3	$M\Omega$
Grid No.3 resistor	R_{g3}	max.	0.1	$M\Omega$
Cathode to heater voltage	V_{kf}	max.	100	V

¹⁾ Max. pulse duration 4% of a cycle but max. 0.8 ms.

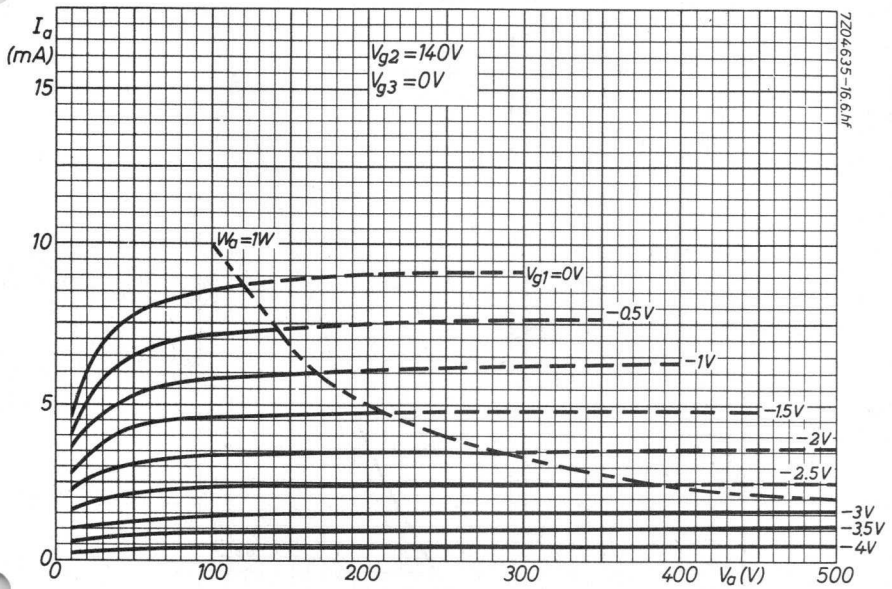

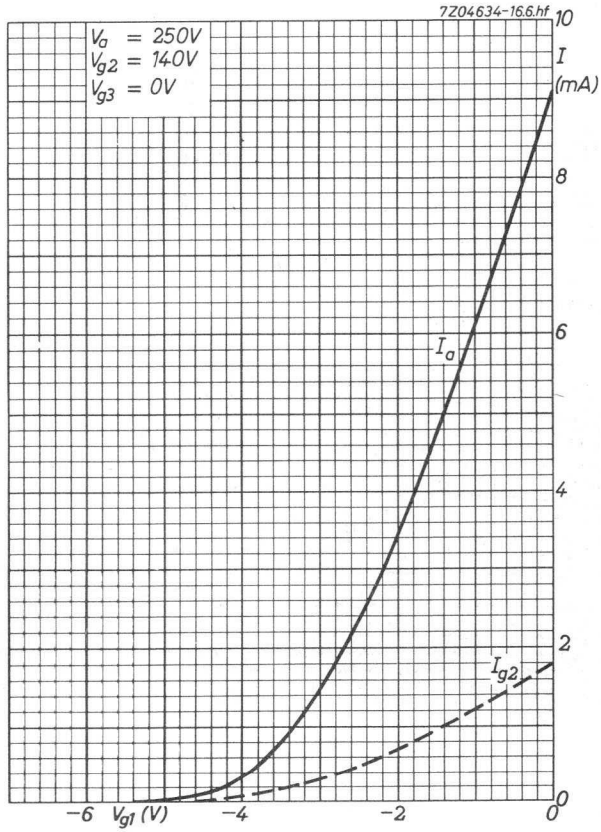

DOUBLE PENTODE

Double pentode intended for use as video output tube, sync. separator, A.C. amplifier or I.F. sound amplifier.

QUICK REFERENCE DATA		
<u>F section</u>		
Anode current	I_a	10 mA
Transconductance	S	8.5 mA/V
Amplification factor	$\mu g_2 g_1$	38 -
Internal resistance	R_i	150 k Ω
<u>L section</u>		
Anode current	I_a	30 mA
Transconductance	S	22 mA/V
Amplification factor	$\mu g_2 g_1$	38 -
Internal resistance	R_i	33 k Ω

HEATING: Indirect by A.C. or D.C.; series supply

Heater current	I_f 300 mA
Heater voltage	V_f 17 V

DIMENSIONS AND CONNECTIONS

Dimensions in mm

Base: Decal

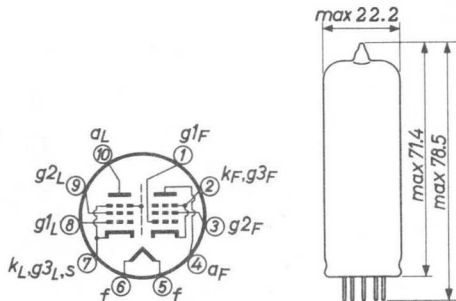

CAPACITANCES

	L section	F section
Anode to all except grid No. 1	$C_{a(g_1)}$ 6.5	10.5 pF
Grid No. 1 to all except anode	$C_{g_1(a)}$ 12.5	10.5 pF
Anode to grid No. 1	C_{ag_1} 0.100	0.15 pF
Grid No. 1 to heater	C_{g_1f}	max. 0.15 pF

Between the two pentode sections

Anode L section to anode F section	$C_{a_L a_F}$	max. 0.15 pF
Grid No. 1 L section to grid No. 1 F section	$C_{g_{1L} g_{1F}}$	max. 0.01 pF
Anode L section to grid No. 1 F section	$C_{a_L g_{1F}}$	max. 0.10 pF
Grid No. 1 L section to anode F section	$C_{g_{1L} a_F}$	max. 0.005 pF

TYPICAL CHARACTERISTICS

Output pentode (L section)

Anode voltage	V_a	170 V
Grid No. 2 voltage	V_{g_2}	170 V
Grid No. 1 voltage	V_{g_1}	-2.7 V
Anode current	I_a	30 mA
Grid No. 2 current	I_{g_2}	7 mA
Transconductance	S	22 mA/V
Internal resistance	R_i	33 k Ω
Amplification factor	$\mu_{g_2 g_1}$	38 -

Amplifier pentode (F section)

Anode voltage	V_a	150 V
Grid No. 2 voltage	V_{g_2}	150 V
Grid No. 1 voltage	V_{g_1}	-2.1 V
Anode current	I_a	10 mA
Grid No. 2 current	I_{g_2}	3.0 mA
Transconductance	S	8.5 mA/V
Internal resistance	R_i	150 k Ω
Amplification factor	$\mu_{g_2 g_1}$	38 -

OPERATING CHARACTERISTICS

Output pentode (L section) as video output tube

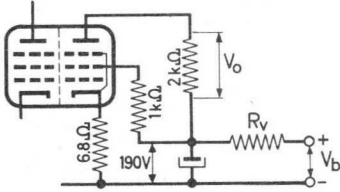

Supply voltage $V_b = 210 \quad 230 \text{ V}$

Series resistor $R_v = 390 \quad 820 \ \Omega$

R_v should be added to avoid excessive dissipation

Input voltage (peak to peak)

$V_{i_{p-p}} = 3.6 \text{ V}$

Output voltage (peak to peak)

$V_{o_{p-p}} = 100 \text{ V}$

Amplifier pentode (F section)

		Sync Separator	A.G.C. amplifier	I.F. amplifier
Supply voltage	V_b	200 to 250 V		
Anode resistor	R_a	50 k Ω		
Anode voltage	V_a		100 to 150 V	150 V
Grid No. 2 voltage	V_{g_2}	75 V	60 V	150 V
Grid No. 1 resistor	R_{g_1}	1 M Ω		
Grid No. 1 voltage	V_{g_1}	-2.7 V	-1.5 V	-2.1 V
Anode current	I_a	0.1 mA	1 mA	10 mA
Transconductance	S	0.2 mA/V	2.0 mA/V	8.5 mA/V

LIMITING VALUES (Design centre rating system)

Output pentode (L section)

Anode voltage	V_{a0}	max. 550 V
	V_a	max. 250 V
Anode dissipation	W_a	max. 5.1 W
Grid No.2 voltage	V_{g20}	max. 550 V
	V_{g2}	max. 250 V
Grid No.2 dissipation	W_{g2}	max. 2.5 W ¹⁾
Grid No.1 resistor	R_{g1}	max. 1 M Ω
Cathode current	I_k	max. 60 mA ²⁾
Cathode to heater voltage	V_{kf}	max. 200 V

Amplifier pentode (F section)

Anode voltage, peak ($I_a < 0.1$ mA)	V_{ap}	max. 600 V ³⁾
	V_{a0}	max. 550 V
	V_a	max. 250 V
Anode dissipation	W_a	max. 1.5 W
Grid No.2 voltage	V_{g20}	max. 550 V
	V_{g2}	max. 250 V
Grid No.2 dissipation	W_{g2}	max. 0.5 W
Grid No.1 resistor	R_{g1}	max. 1 M Ω
Cathode current	I_k	max. 15 mA
Cathode to heater voltage	V_{kf}	max. 200 V

¹⁾ During short periods $W_{g2} = \text{max. } 3.2 \text{ W}$

²⁾ During short periods $I_k = \text{max. } 85 \text{ mA}$

³⁾ Max. pulse duration 18% of a cycle, with a max. of 18 $\mu\text{sec.}$

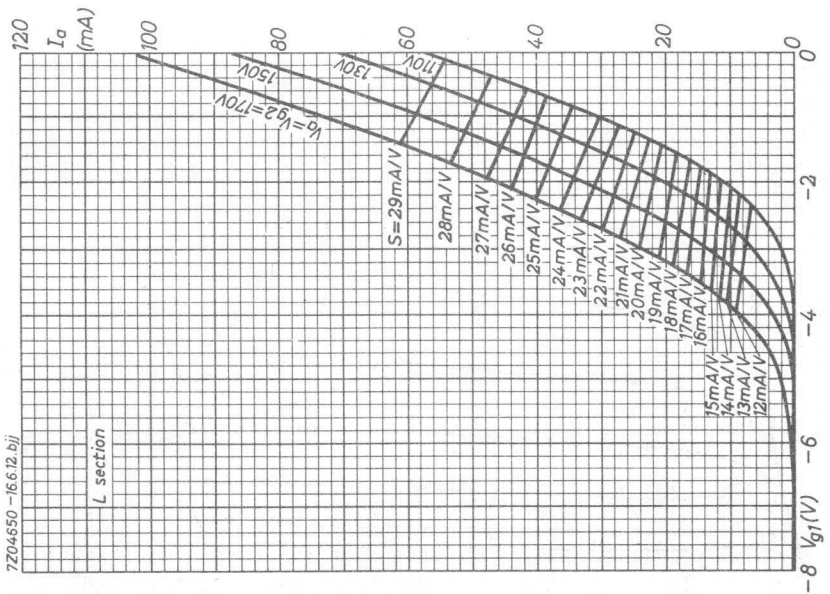
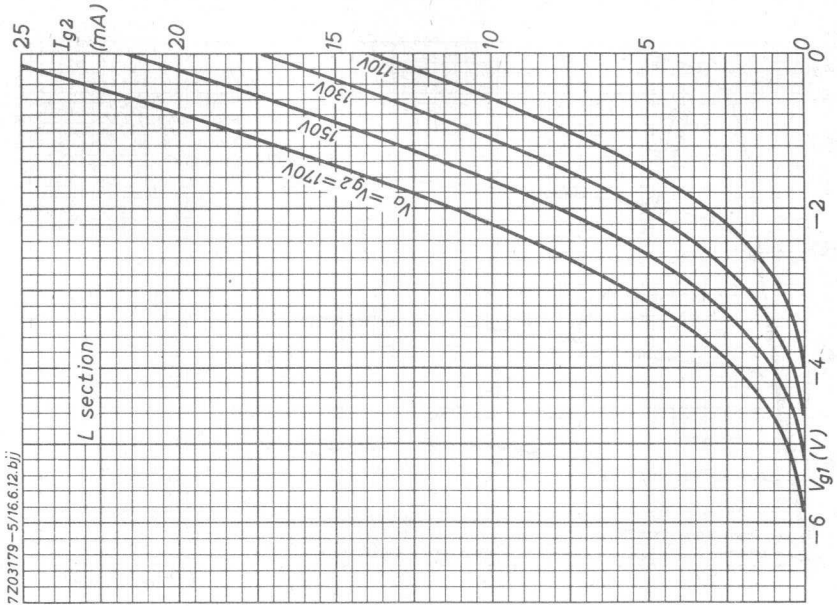

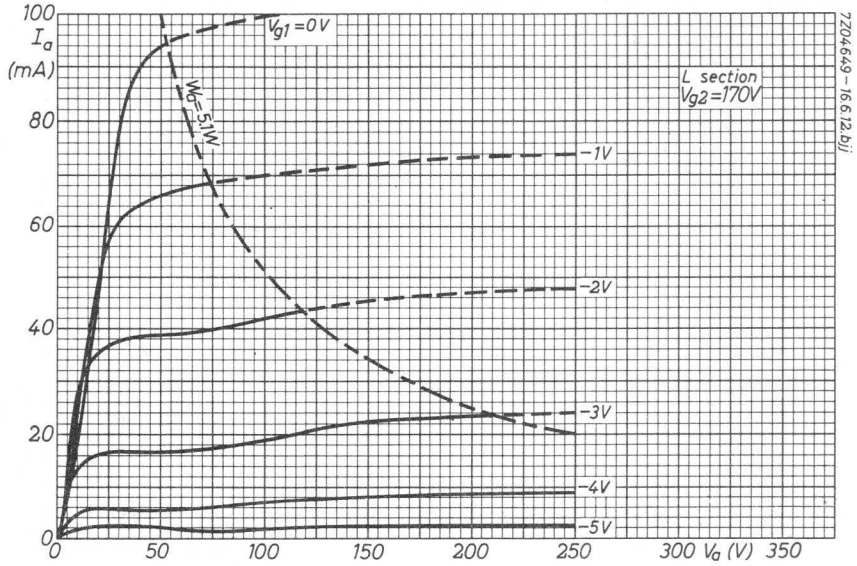

7204649-16.6.12.bj

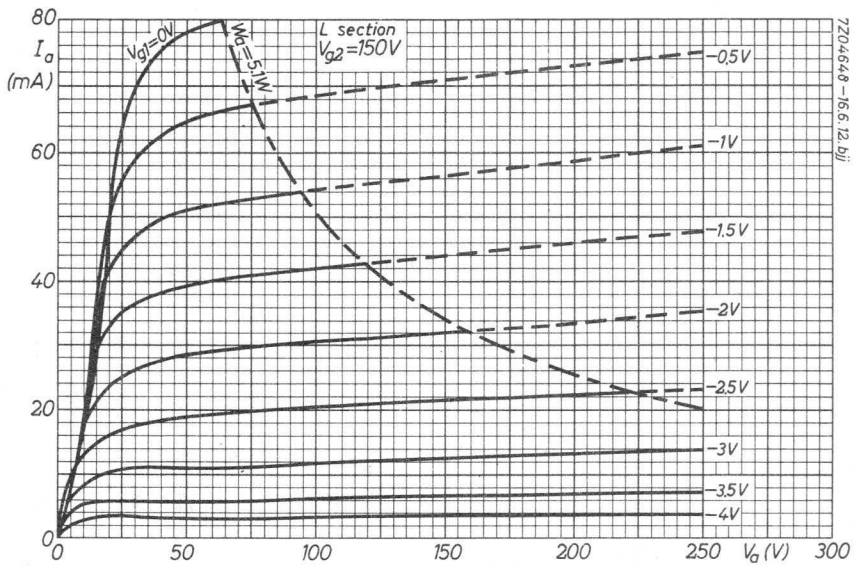

7204648-16.6.12.bj

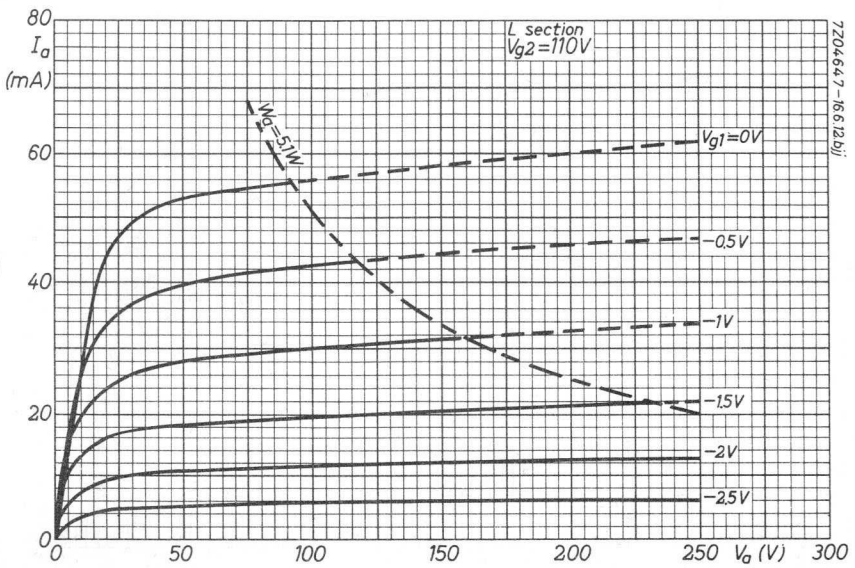
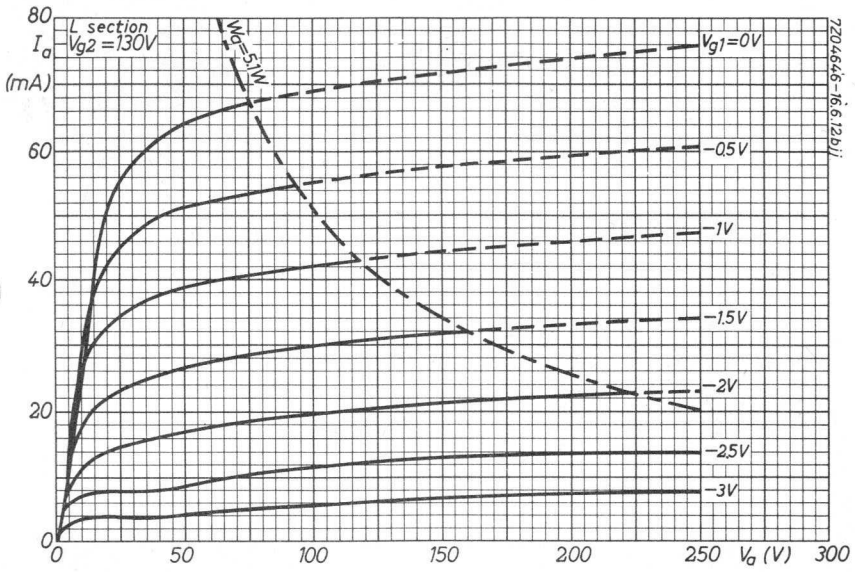

7203178-5/16.6.12.bij

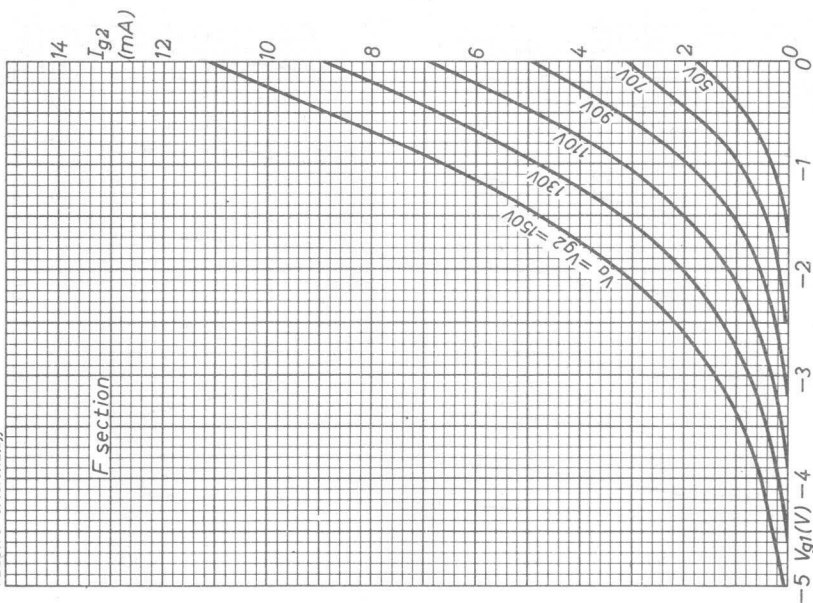

7203177-5/16.6.12.bij

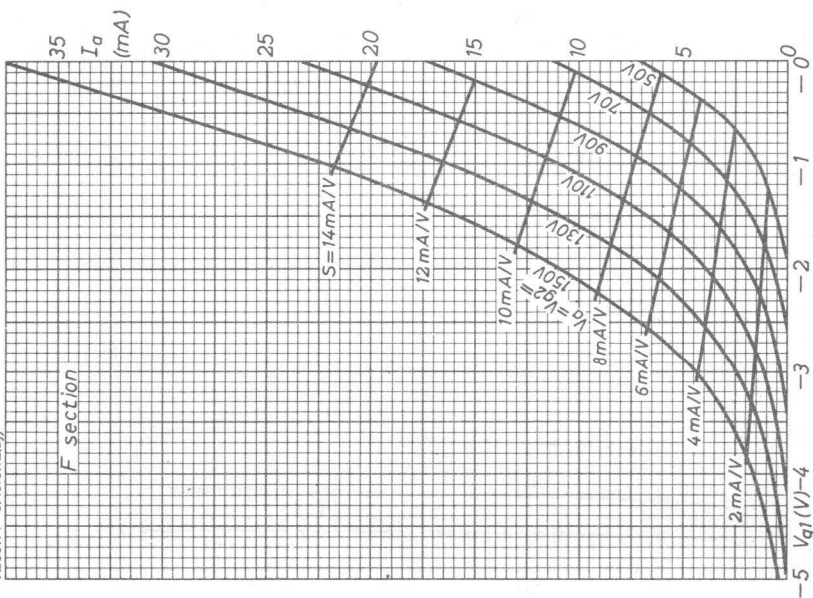

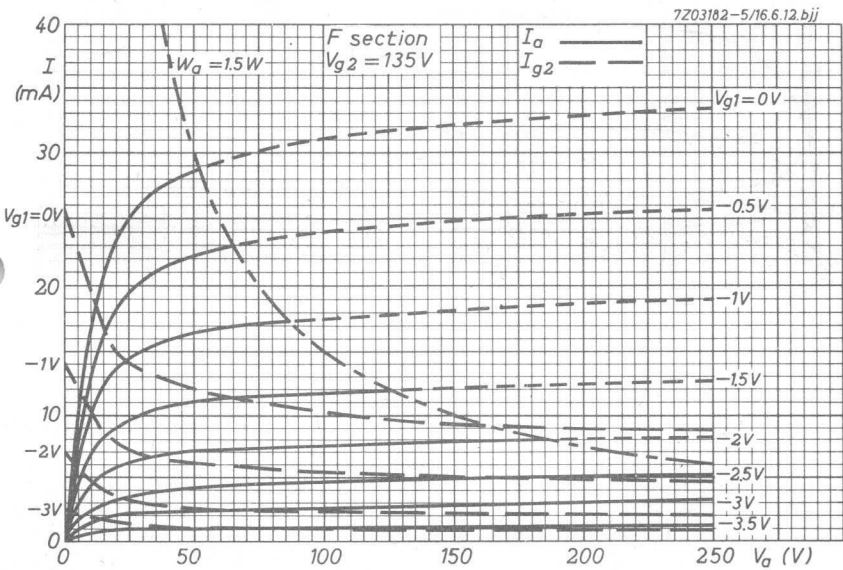
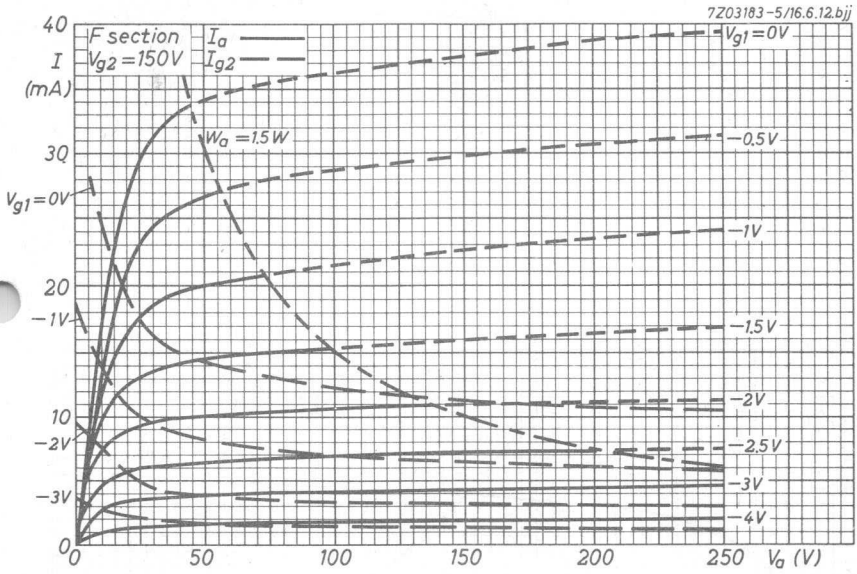

7Z03101-5/16.6.12.bjj

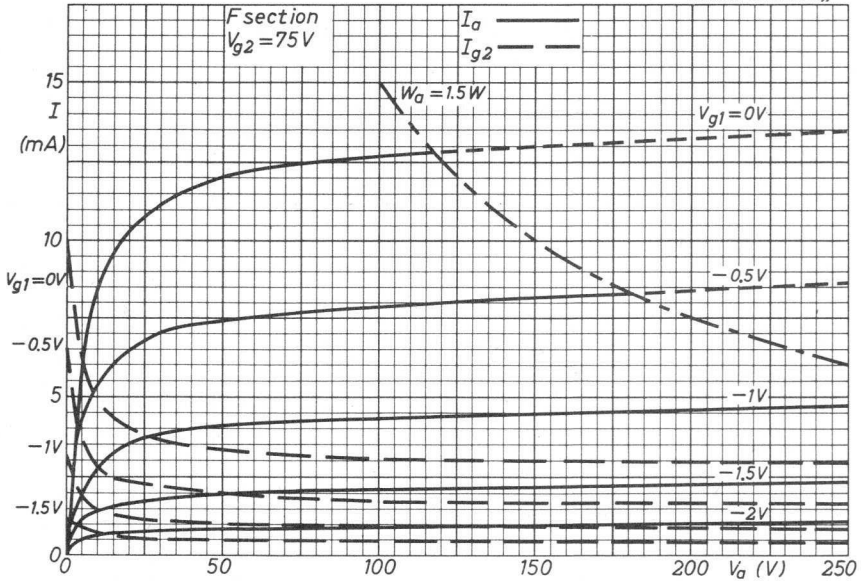

LINE OUTPUT PENTODE

Pentode intended for use as line output tube in television receivers.

QUICK REFERENCE DATA		
Anode peak voltage	V_{ap}	max. 7 kV
Cathode current	I_k	max. 200 mA
Drive at $V_{ap} = 7$ kV		min. 120 V

HEATING: Indirect by A.C. or D.C.; series supply

Heater current	I_f	300 mA
Heater voltage	V_f	25 V

DIMENSIONS AND CONNECTIONS

Base: Octal

Top cap: Type 1

Dimensions in mm

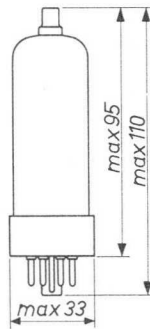
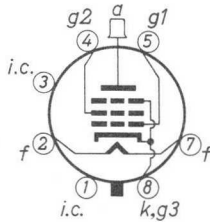

CAPACITANCES

Anode to all except grid No. 1

$C_{a(g_1)}$ 8 pF

Grid No. 1 to all except anode

$C_{g_1(a)}$ 17.5 pF

Anode to grid No. 1

C_{ag_1} max. 1.1 pF

TYPICAL CHARACTERISTICS

Anode voltage	V_a	100 V
Grid No.2 voltage	V_{g2}	100 V
Grid No.1 voltage	V_{g1}	-8.2 V
Anode current	I_a	100 mA
Grid No.2 current	I_{g2}	7 mA
Transconductance	S	14 mA/V
Amplification factor	μ_{g2g1}	5.6
Internal resistance	R_i	5 k Ω

REMARKS

On pages D to M curves are given for nominal new tubes. On designing a line output circuit it has to be taken into account that due to tube spread and deterioration during life the current may be reduced by 25%.

When the tube is operated below the knee of its $I_a - V_a$ characteristic the screen grid series resistor must have a minimum value of 2.2 k Ω to avoid the occurrence of Barkhausen oscillations.

The min. drive at $V_{ap} = 5$ kV is 100 V
 and at $V_{ap} = 7$ kV 120 V

LIMITING VALUES (Design centre rating system)

Anode voltage	V_{a0}	max. 550 V
	V_a	max. 250 V
Anode peak voltage		
positive	V_{ap}	max. 7 kV ¹⁾
negative	$-V_{ap}$	max. 1.5 kV ¹⁾
Grid No.2 voltage	V_{g20}	max. 550 V
	V_{g2}	max. 250 V
Grid No.1 peak voltage	V_{g1p}	max. 1 kV ¹⁾
Anode dissipation	W_a	} See page 7
Grid No.2 dissipation	W_{g2}	
Anode + grid No.2 dissipation	W_a+W_{g2}	
Cathode current	I_k	max. 200 mA
Grid No.1 resistor	R_{g1}	max. 0.5 M Ω ²⁾
Cathode to heater voltage		
A.C. value	V_{kf}	max. 250 V _{RMS}
D.C. value, k pos.	V_{kf}	max. 250 V
D.C. value, k neg.	V_{kf}	max. 200 V

¹⁾ Valid for application in line output circuits where the max. pulse duration is 22% of a cycle with a max. of 18 μs .

²⁾ R_{g1} = max. 2.2 M Ω for line output application only.

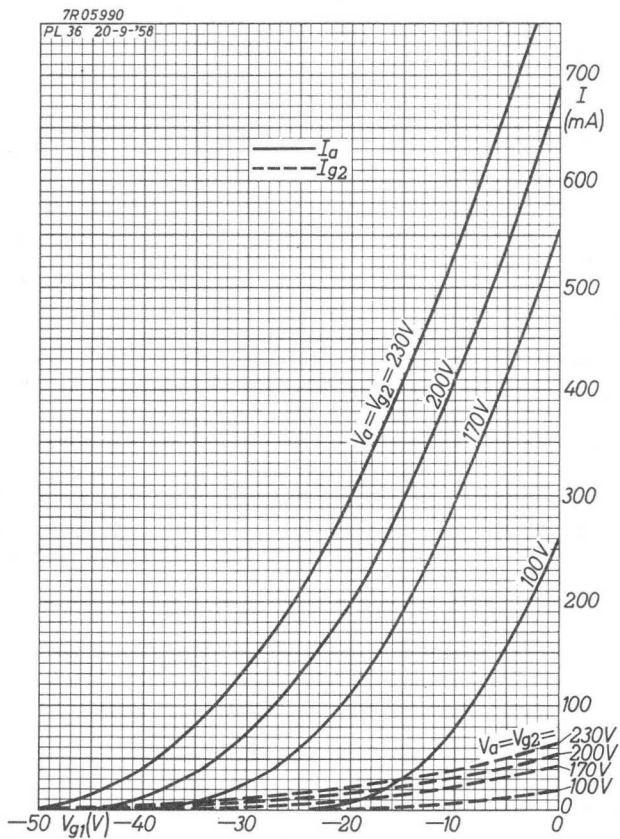

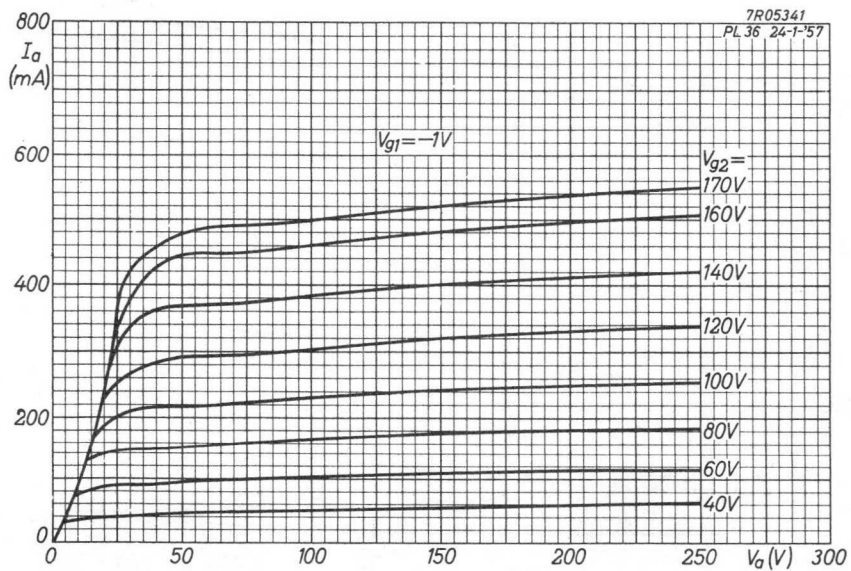
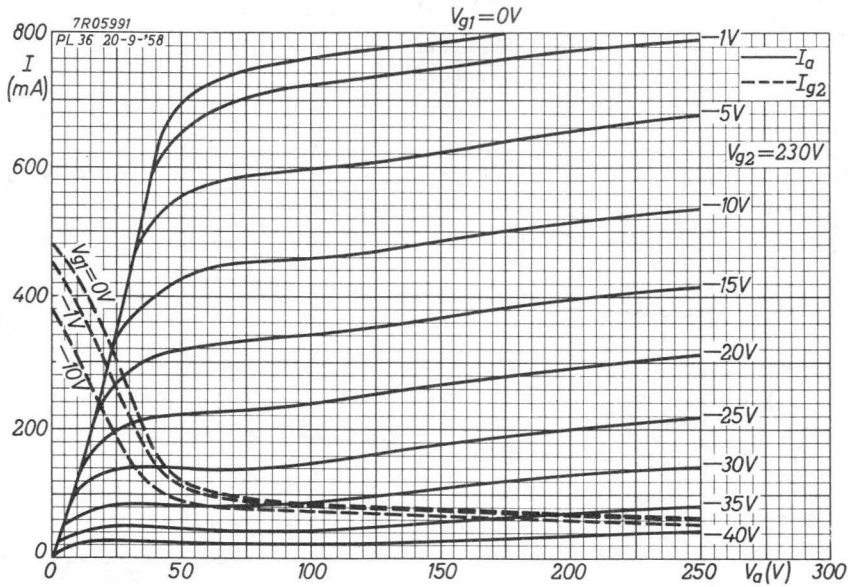

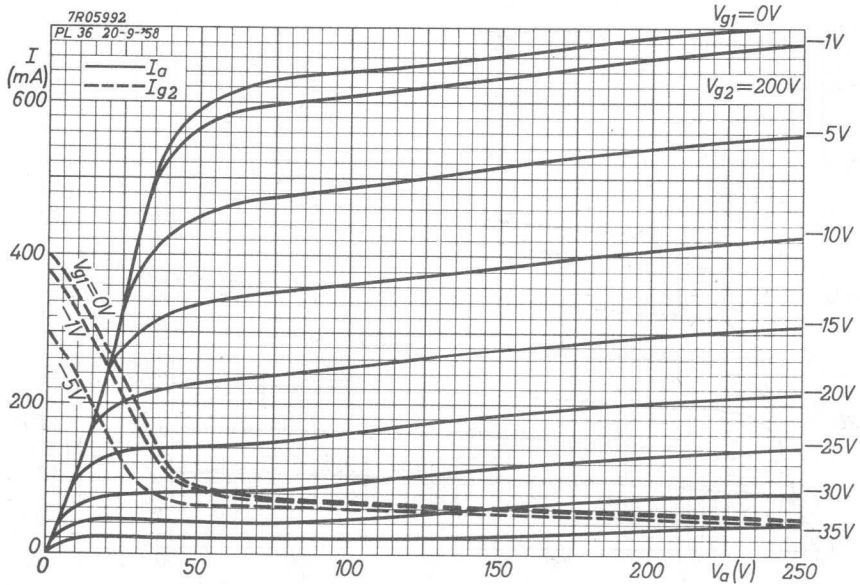
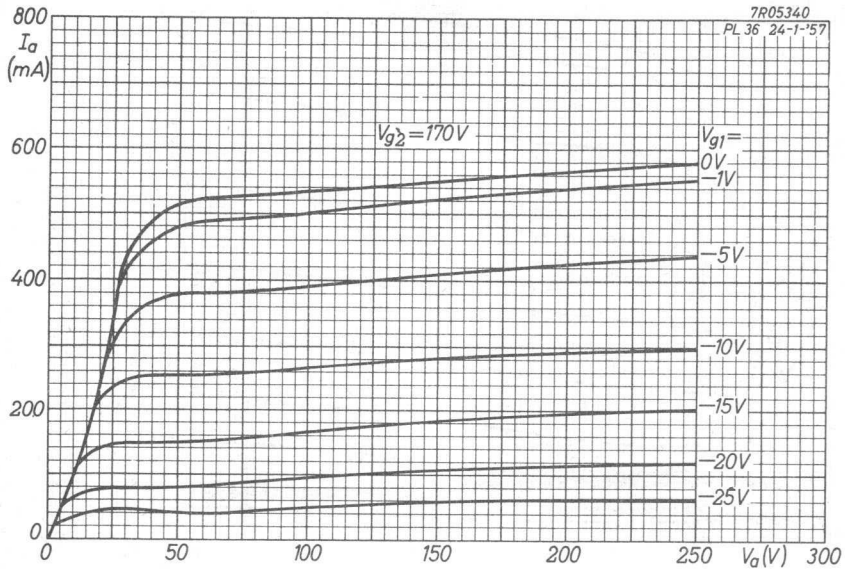

7206881

The max. permissible dissipations should not be exceeded with the chosen max. mean value of the beam current of the picture tube. If necessary a protecting device should be applied in order to avoid exceeding these dissipation.

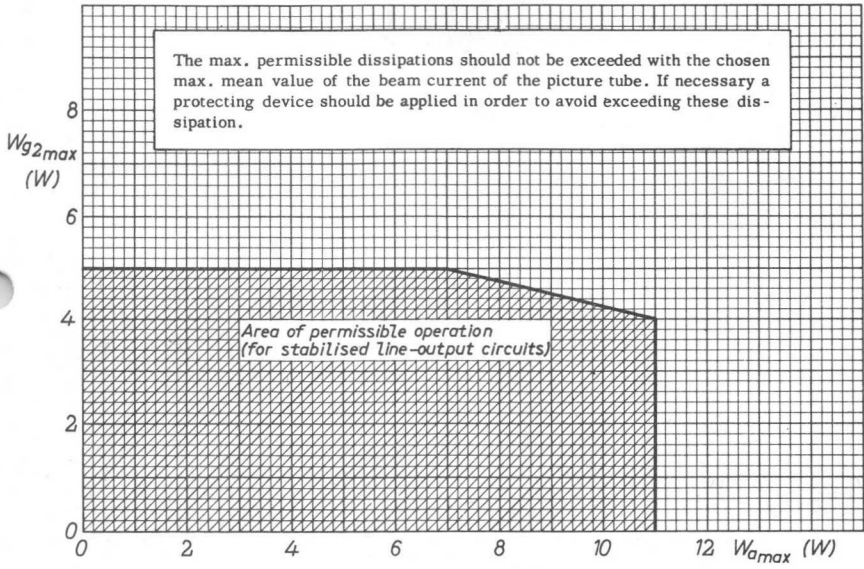

7206882

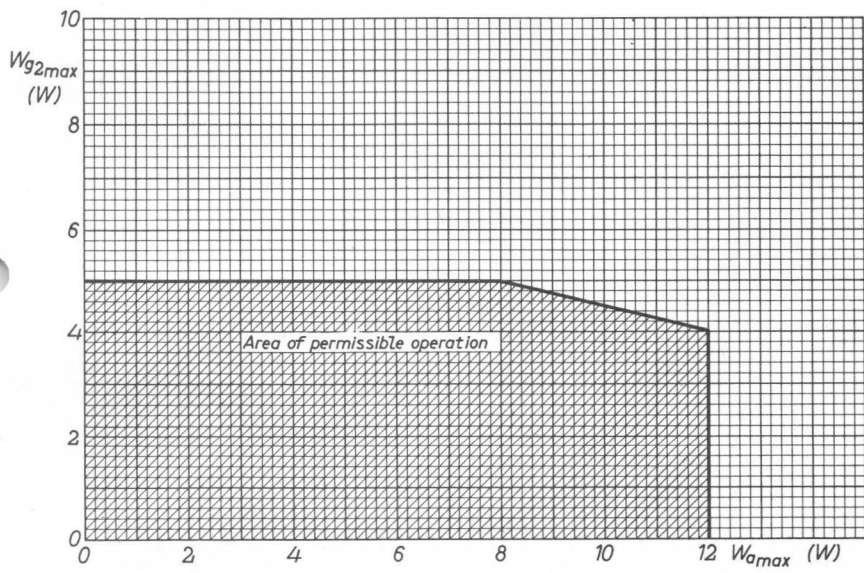

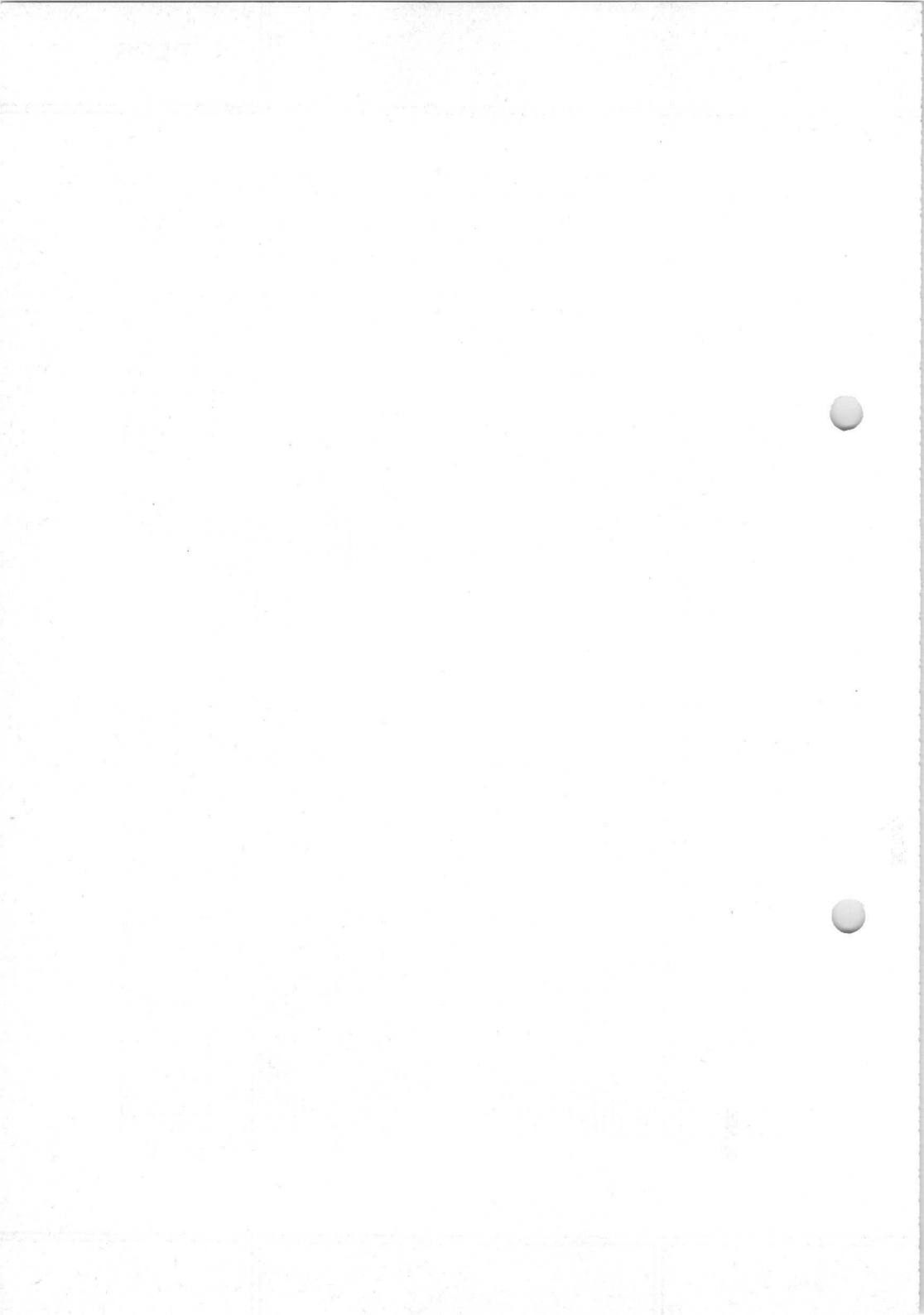

OUTPUT PENTODE FOR LINE DEFLECTION

Output pentode intended for use as horizontal deflection amplifier in small screen television receivers.

QUICK REFERENCE DATA

Anode peak voltage	V_{ap}	max.	7	kV
Cathode current	I_k	max.	180	mA

HEATING : Indirect by A. C. or D. C. ; series supply

Heater current

I_f 300 mA

Heater voltage

V_f 21.5 V

DIMENSIONS AND CONNECTIONS

Dimensions in mm

Base: Noval

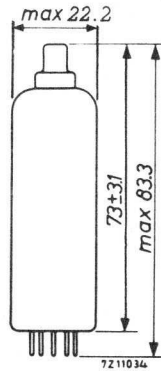
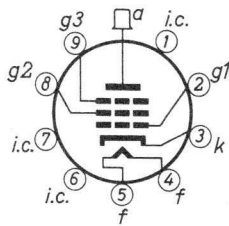

CAPACITANCES

Anode to all except grid No. 1	$C_{a(g1)}$	6 pF
Grid No. 1 to all except anode	$C_{g1(a)}$	14 pF
Anode to grid No. 1	C_{ag1}	max. 0.8 pF
Anode to cathode	C_{ak}	max. 0.1 pF
Grid No. 1 to heater	C_{g1f}	max. 0.2 pF

TYPICAL CHARACTERISTICS

A)

Anode voltage	V_a	170 V
Grid No. 3 voltage	V_{g3}	0 V
Grid No. 2 voltage	V_{g2}	170 V
Grid No. 1 voltage	V_{g1}	-24 V
Anode current	I_a	45 mA
Grid No. 2 current	I_{g2}	2.4 mA
Transconductance	S	6.3 mA/V
Internal resistance	R_i	11 k Ω
Amplification factor	μ_{g2g1}	5.0

TYPICAL CHARACTERISTICS (continued)

B) (Measured under pulse conditions)

Anode voltage	V_a	40 V
Grid No. 3 voltage	V_{g3}	0 V
Grid No. 2 supply voltage	V_{bg2}	190 V
Grid No. 2 series resistor	R_{g2}	4.7 k Ω
Grid No. 1 voltage	V_{g1}	0 V
Anode current	I_a	180 mA
Grid No. 2 current	I_{g2}	18 mA

OPERATING CONDITIONS

Stabilized circuits (D. C. feedback)

Cut-off voltage

The minimum required cut-off voltage ($-V_{g1}$) during flyback is 120 V at $V_a = 6000$ V, $V_{g2} = 190$ V and $Z_{g1} = 1$ k Ω at line frequency.

Supply voltage: See page 5

Minimum required values of the screengrid voltage and of the anode voltage, when the tube is used in a line output stage.

The graphs refer to nominal mains voltage provided the specified values of I_a at V_a min, will be available throughout life of the tube at supply voltage values 10% below nominal.

In order to prevent Barkhausen interferences and less of stabilisation, care should be taken that the anode voltage never drops below the specified V_a min during the scanning period.

LIMITING VALUES (Design centre rating system)

Anode voltage	V_{a0}	max. 550 V
	V_a	max. 250 V
Anode voltage, peak	V_{ap}	max. 7 kV 1)
negative peak	$-V_{ap}$	max. 7 kV 1)
Anode dissipation	W_a	} see figure below
Grid No. 2 dissipation	W_{g2} 2)	
Anode + grid No. 2 dissipation	$W_a + W_{g2}$	
Grid No. 2 voltage	V_{g20}	max. 550 V
	V_{g2}	max. 250 V
Cathode current	I_k	max. 180 mA
Cathode to heater voltage	V_{kf}	max. 200 V
Grid No. 1 resistor	R_{g1}	max. 0.5 M Ω

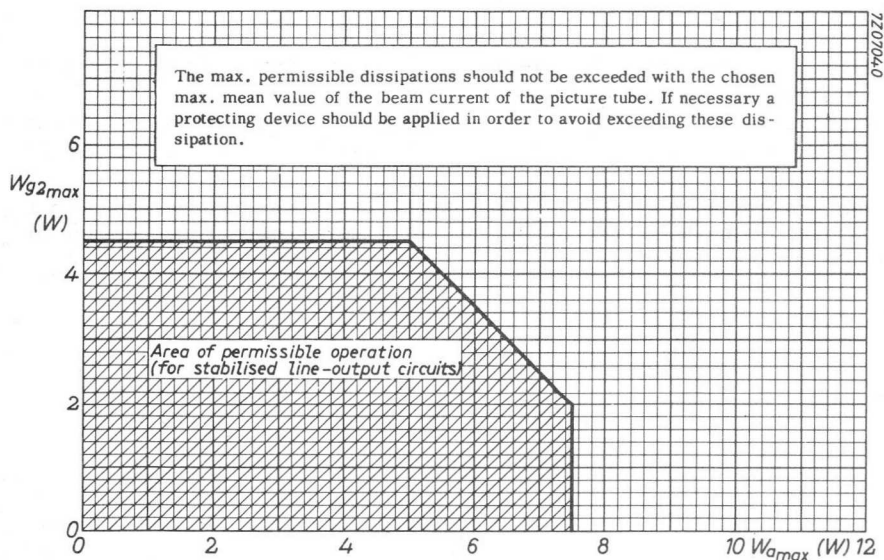

1) Maximum pulse duration 22% of a cycle but maximum 18 μ s.
 2) During the heating-up of the cathode $W_{g2} = \text{max. } 6 \text{ W}$.

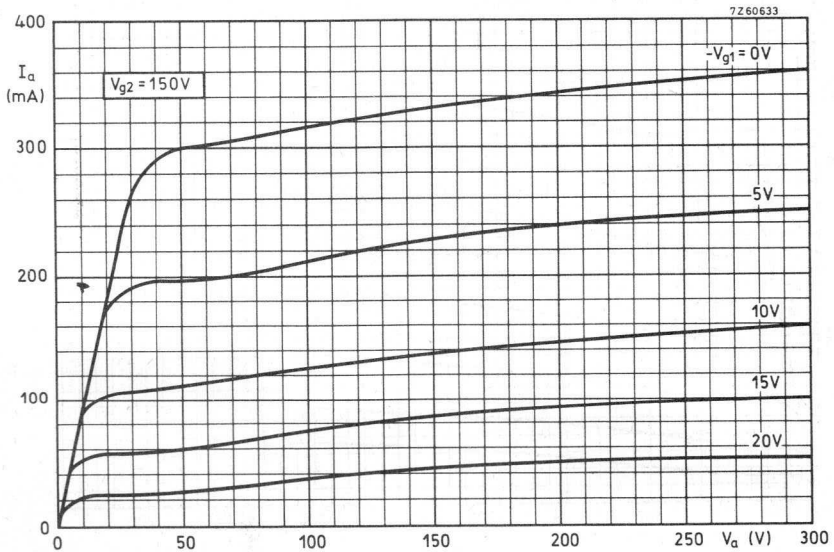
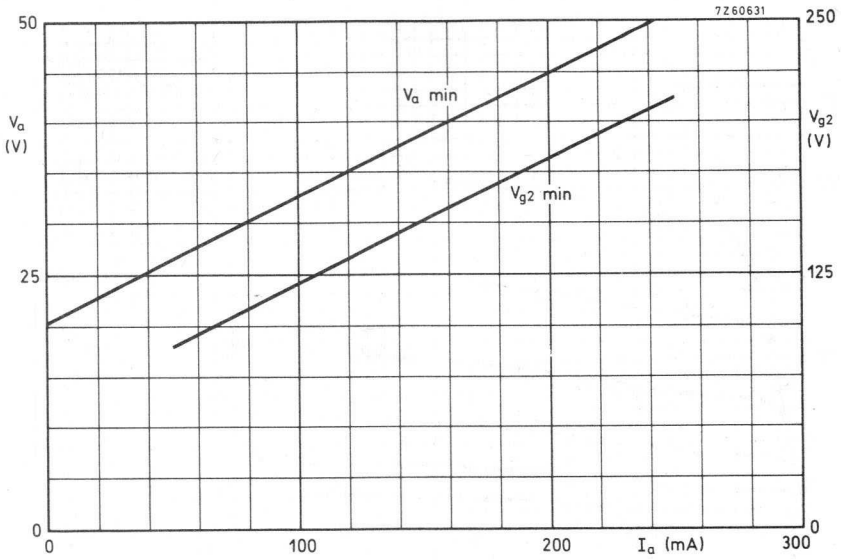

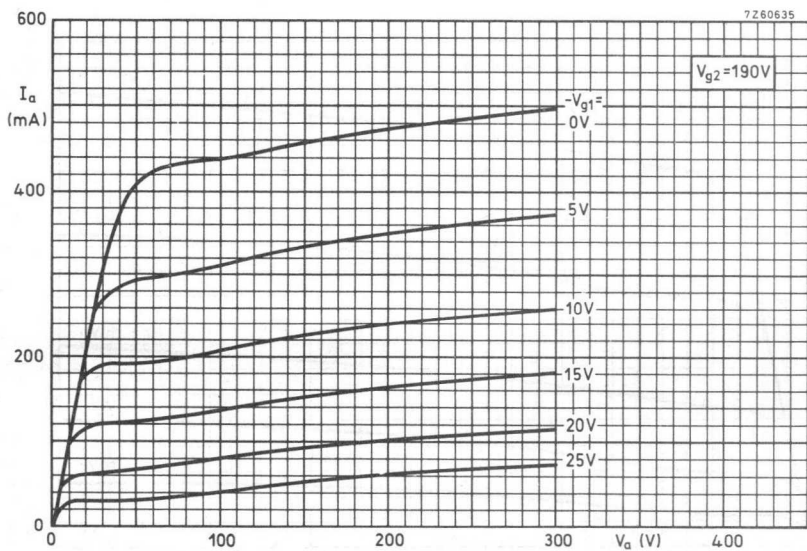
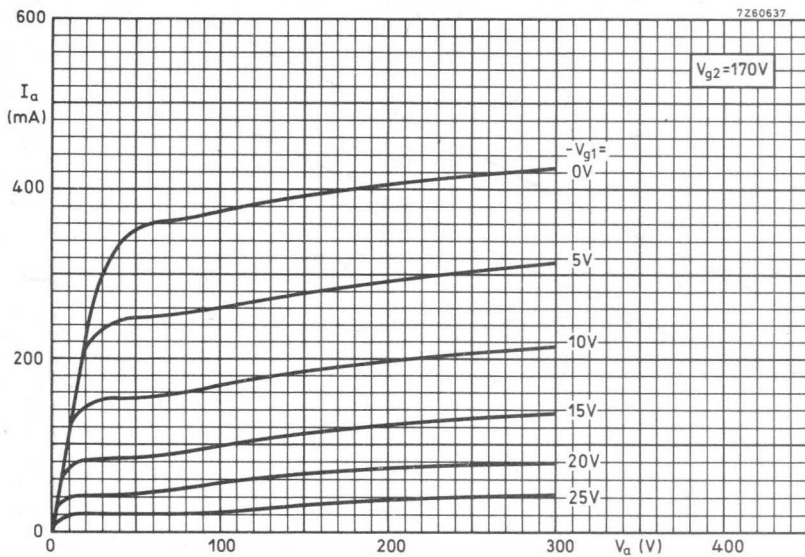

VIDEO OUTPUT PENTODE

Pentode intended for use as video output tube.

QUICK REFERENCE DATA		
Anode current	I_a	36 mA
Transconductance	S	10.5 mA/V
Amplification factor	$\mu_{g_2g_1}$	24 -

HEATING: Indirect by A.C. or D.C.; series supply

Heater current	I_f	300 mA
Heater voltage	V_f	15 V

DIMENSIONS AND CONNECTIONS

Dimensions in mm

Base: Noval

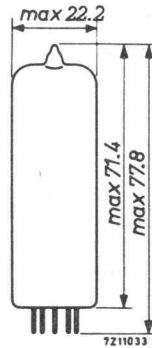
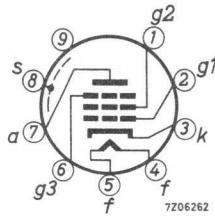

CAPACITANCES

Anode to all except grid No.1	$C_{a(g_1)}$	6.6 pF
Grid No.1 to all except anode	$C_{g_1(a)}$	10.8 pF
Anode to grid No.1	C_{ag_1}	max. 0.1 pF
Grid No.1 to grid No.2	$C_{g_1g_2}$	3.2 pF
Grid No.1 to heater	C_{g_1f}	max. 0.15 pF

TYPICAL CHARACTERISTICS

Anode voltage	V_a	170	200	V
Grid No.3 voltage	V_{g3}	0	0	V
Grid No.2 voltage	V_{g2}	170	200	V
Grid No.1 voltage	V_{g1}	-2.3	-3.5	V
Anode current	I_a	36	36	mA
Grid No.2 current	I_{g2}	5.0	5.0	mA
Transconductance	S	10.5	10.5	mA/V
Amplification factor	μ_{g2g1}	24	24	-
Internal resistance	R_i	0.1	0.1	M Ω

LIMITING VALUES (Design centre rating system)

Anode voltage	V_{a0}	max.	550	V
	V_a	max.	250	V
Grid No.2 voltage	V_{g20}	max.	550	V
	V_{g2}	max.	250	V
Anode dissipation	W_a	max.	9	W
Grid No.2 dissipation	W_{g2}	max.	2	W
Cathode current	I_k	max.	70	mA
Grid No.1 resistor	R_{g1}	for fixed bias	max.	0.5 M Ω
		for automatic bias	max.	1 M Ω
Cathode to heater voltage	V_{kf}	max.	200	V 1)

1) D.C. component max. 150 V

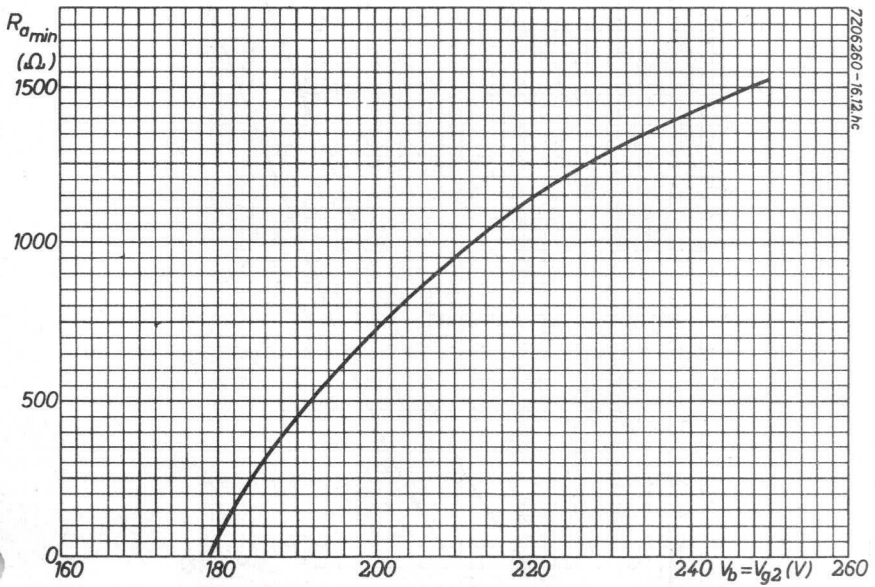

7Z06261-16.12,hc

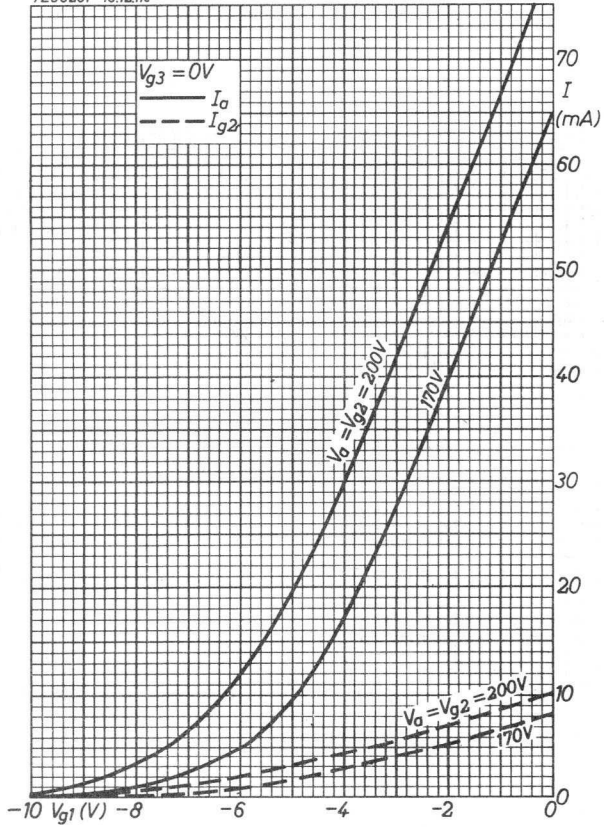

FRAME AND A.F. OUTPUT PENTODE

Pentode intended for use as frame output tube in television receivers and as A.F. power amplifier.

QUICK REFERENCE DATA		
Anode peak voltage	V_{ap}	max. 2 kV
Cathode current	I_k	max. 100 mA
Output power	W_o	5.3 W

HEATING: Indirect by A.C. or D.C.; series supply

Heater current	I_f	300 mA
Heater voltage	V_f	15 V

DIMENSIONS AND CONNECTIONS

Base: Noval

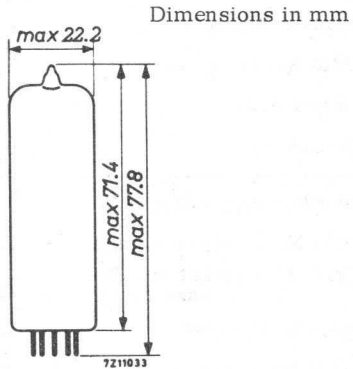
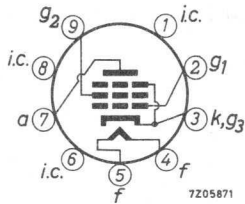

CAPACITANCES

Anode to all except grid No. 1	$C_{a(g_1)}$	6.8 pF
Grid No. 1 to all except anode	$C_{g_1(a)}$	13 pF
Anode to grid No. 1	C_{ag_1}	max. 0.6 pF
Grid No. 1 to heater	C_{g_1f}	max. 0.25 pF

OPTIMUM PEAK ANODE CURRENT IN FRAME OUTPUT APPLICATION

The circuit should be designed so that the peak anode current does not exceed:

- 145 mA at $V_a = 60$ V, $V_{g2} = 170$ V, $I_f = 300$ mA
- 190 mA at $V_a = 70$ V, $V_{g2} = 200$ V, $I_f = 300$ mA
- 220 mA at $V_a = 80$ V, $V_{g2} = 220$ V, $I_f = 300$ mA

The minimum available value of the peak anode current at end of life and $I_f = 285$ mA is:

- 125 mA at $V_a = 60$ V, $V_{g2} = 170$ V
- 160 mA at $V_a = 70$ V, $V_{g2} = 200$ V
- 185 mA at $V_a = 80$ V, $V_{g2} = 220$ V

OPERATING CHARACTERISTICS

A.F. power amplifier, class A (measured with V_k constant)

Supply voltage	V_b	170	200	V
Grid No.2 series resistor (non decoupled)	R_{g2}	0	470	Ω
Cathode resistor	R_k	130	215	Ω
Load resistance	$R_{a\sim}$	2	2.5	k Ω
Grid No.1 driving voltage	V_i	0 0.47 6.1	0 0.52 7.0	V_{RMS}
Anode current	I_a	75 - 76	65 - 64	mA
Grid No.2 current	I_{g2}	4.0 - 16.5	3.2 - 11.4	mA
Output power	W_o	0 0.05 5.1	0 0.05 5.3	W
Distortion	d_{tot}	- - 10	- - 10	%
Anode supply voltage	V_{ba}		230	V
Grid No.2 supply voltage	V_{bg2}		200	V
Grid No.2 series resistor (non decoupled)	R_{g2}		220	Ω
Cathode resistor	R_k		270	Ω
Load resistance	$R_{a\sim}$		3.25	k Ω
Grid No.1 driving voltage	V_i		0 0.42 5.7	V_{RMS}
Anode current	I_a		56 - 54	mA
Grid No.2 current	I_{g2}		2.2 - 9.7	mA
Output power	W_o		0 0.05 5.4	W
Distortion	d_{tot}		- 10	%

OPERATING CHARACTERISTICS

A.F. power amplifier, class AB, two tubes in push-pull

Anode supply voltage	V_{ba}	200	230	V
Grid No.2 voltage	V_{bg2}	200	200	V
Common cathode resistor	R_k	120	130	Ω
Load resistance	$R_{aa\sim}$	3	4	$k\Omega$
Grid No.1 driving voltage	V_i	0 0.47 14.3		0 0.4 14.6 V_{RMS}
Anode current	I_a	2x60 - 2x64.5	2x56 - 2x61	mA
Grid No.2 current	I_{g2}	2x3.0 - 2x18.5	2x2.3 - 2x17.5	mA
Output power	W_o	0 0.05 14.3	0 0.05 17.5	W
Distortion	d_{tot}	- - 3.8	- - 5.4	%

LIMITING VALUES (Design centre rating system)

Anode voltage	V_{a0}	max. 550	V
	V_a	max. 250	V
Anode peak voltage	V_{ap}	max. 2	kV ¹⁾
Grid No.2 voltage	V_{g20}	max. 550	V
	V_{g2}	max. 250	V
Anode dissipation	W_a	max. 12	W ²⁾
Grid No.2 dissipation			
	average	W_{g2}	max. 1.75
peak	W_{g2p}	max. 6	W
Cathode current	I_k	max. 100	mA
Grid No.1 resistor			
	for automatic bias	R_{g1}	max. 1
for frame output with automatic bias	R_{g1}	max. 2	$M\Omega$
Cathode to heater voltage	V_{kf}	max. 200	V

1) In frame output circuits where the max. pulse duration is 4% of a cycle with a max. of 0.8 ms.

2) For frame output application $W_a = \text{max. } 10 \text{ W.}$

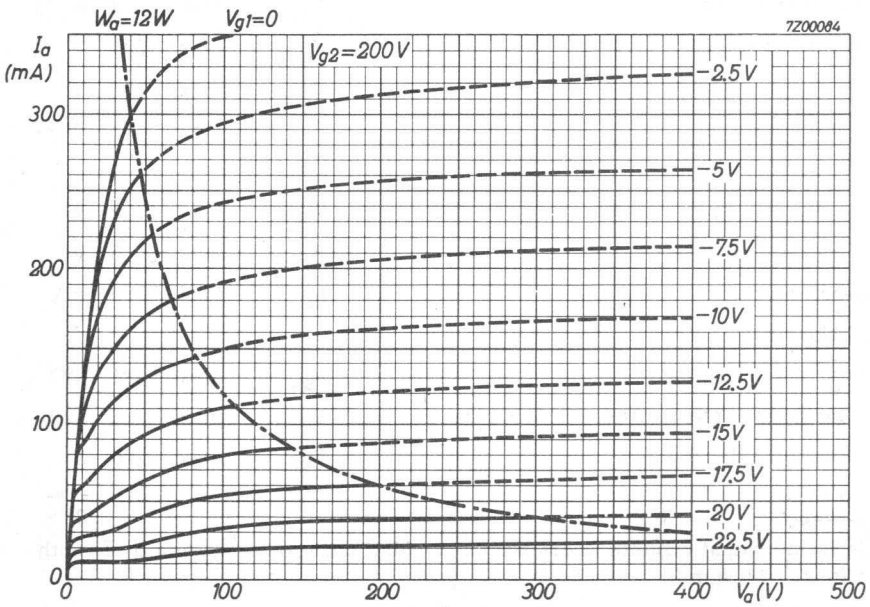
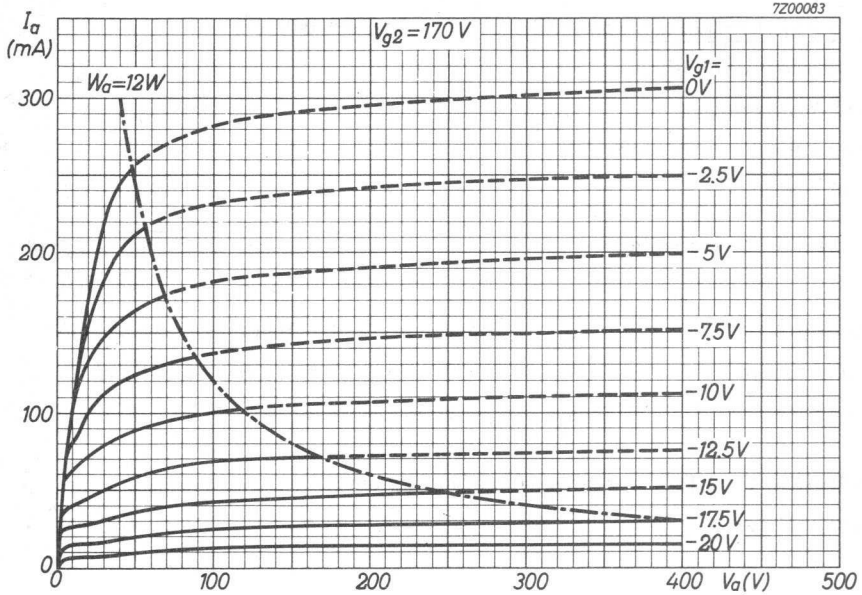

A.F. OUTPUT PENTODE

Pentode intended for use as A.F. power amplifier.

QUICK REFERENCE DATA			
Anode current	I_a	24	mA
Transconductance	S	5.4	mA/V
Amplification factor	μ_{g2g1}	17	
Output power	W_o	3	W

HEATING: Indirect by A.C. or D.C.; series supply

Heater current

I_f 300 mA

Heater voltage

V_f 4.5 V

DIMENSIONS AND CONNECTIONS

Dimensions in mm

Base: miniature 7-pin

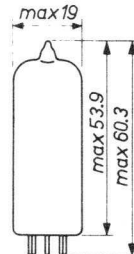
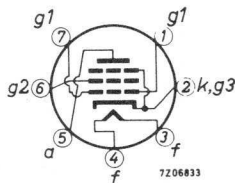

CAPACITANCES

Anode to all except grid No. 1

$C_{a(g1)}$ 3.5 pF

Grid No. 1 to all except anode

$C_{g1(a)}$ 5.3 pF

Anode to grid No. 1

C_{ag1} max. 0.4 pF

Grid No. 1 to heater

C_{g1f} max. 0.2 pF

TYPICAL CHARACTERISTICS

Anode voltage	V_a	250 V
Grid No.2 voltage	V_{g2}	250 V
Grid No.1 voltage	V_{g1}	-9.0 V
Anode current	I_a	24 mA
Grid No.2 current	I_{g2}	4.5 mA
Transconductance	S	5.4 mA/V
Amplification factor	μ_{g2g1}	17
Internal resistance	R_i	70 k Ω

OPERATING CHARACTERISTICS

Class A

Anode voltage	V_a	200	250 V
Grid No.2 voltage	V_{g2}	200	250 V
Cathode resistor	R_k	230	320 Ω
Anode current ($V_i = 0$)	I_a	23	24 mA
Grid No.2 current ($V_i = 0$)	I_{g2}	4.2	4.5 mA
Load resistance	$R_a \sim$	8	10 k Ω
Grid No.1 driving voltage	V_i	4.5	5 V_{RMS}
Output power	W_o	2.3	3.0 W
Distortion	d_{tot}	10	10 %
Grid No.1 driving voltage for $W_o = 50$ mW	V_i	0.50	0.50 V_{RMS}

LIMITING VALUES (Design centre rating system)

Anode voltage	V_{a0}	max.	550 V
	V_a	max.	300 V
Grid No. 2 voltage	V_{g20}	max.	550 V
	V_{g2}	max.	300 V
Anode dissipation	W_a	max.	6 W
Grid No. 2 dissipation			
average at $V_i = 0$	W_{g2}	max.	1.25 W
peak	W_{g2p}	max.	2.5 W
Cathode current	I_k	max.	35 mA
Grid No. 1 resistor, automatic bias	R_{g1}	max.	2.2 M Ω
Cathode to heater voltage	V_{kf}	max.	200 V

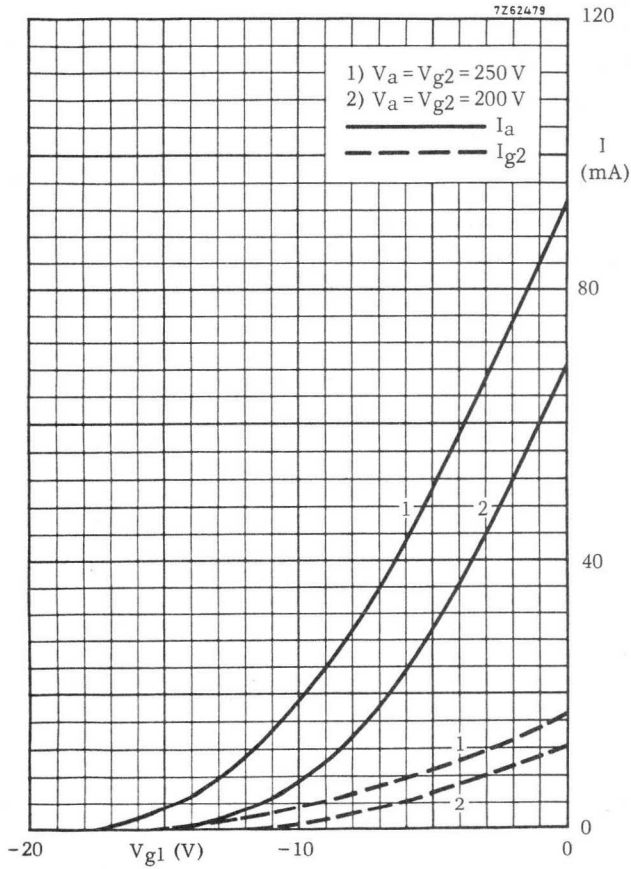

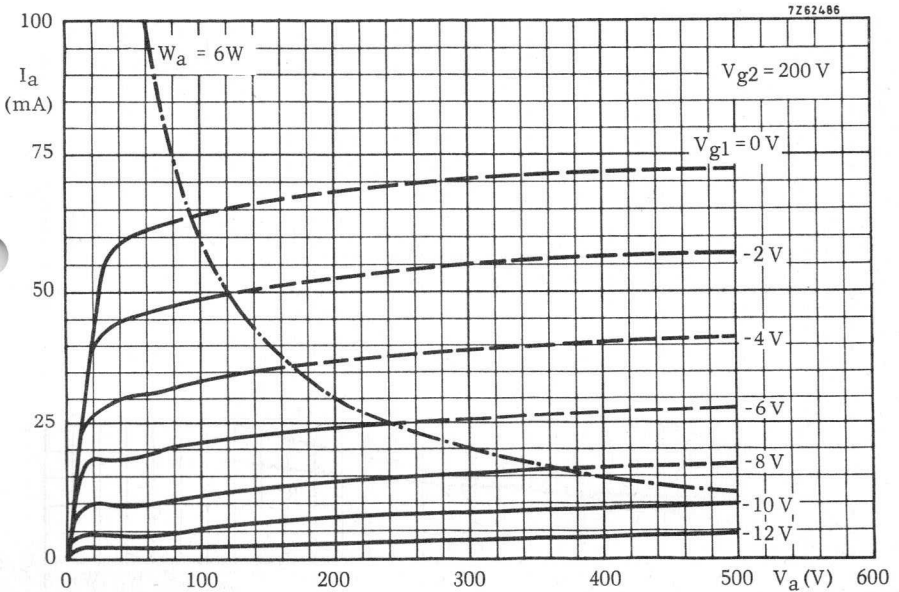
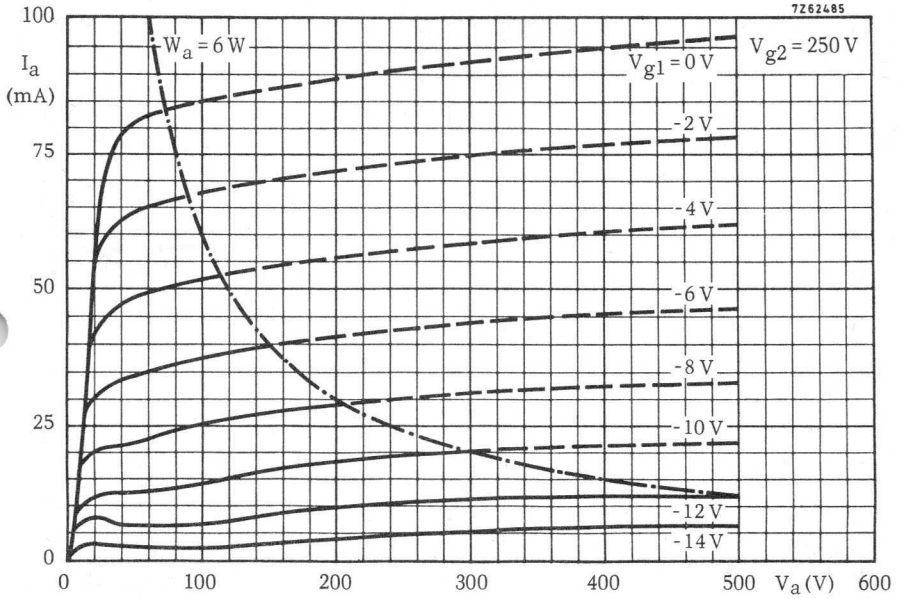

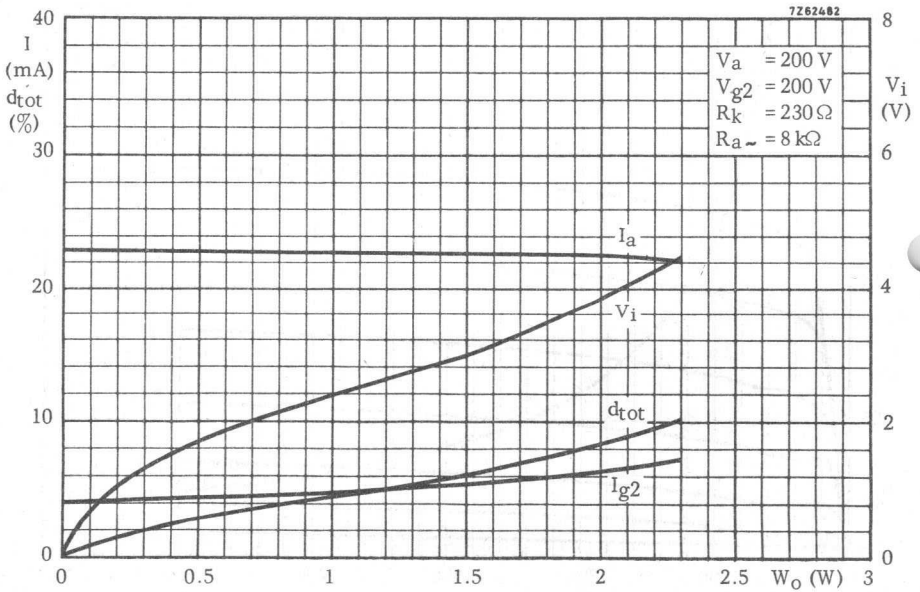
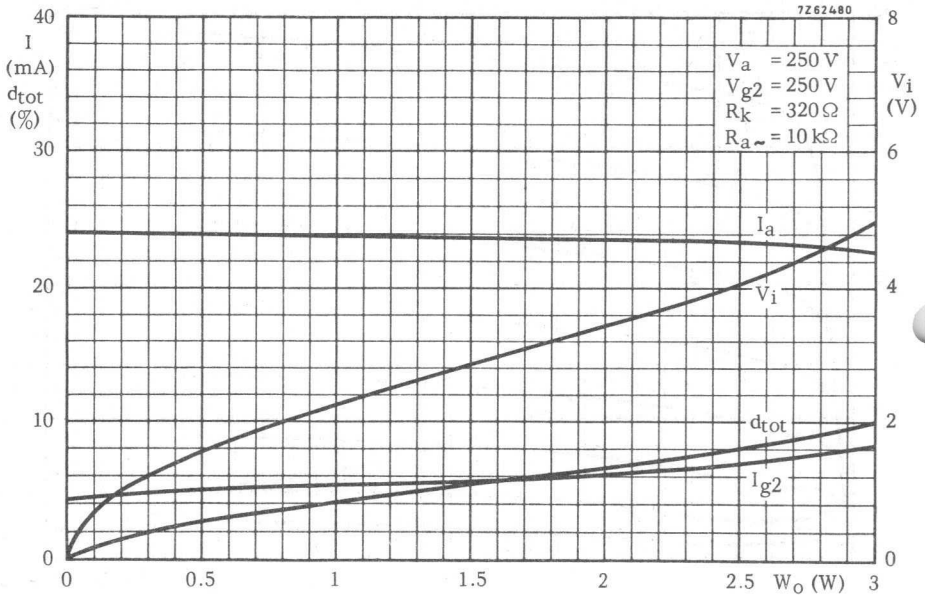

LINE OUTPUT PENTODE

Beam pentode intended for use as line output tube in television receivers.

QUICK REFERENCE DATA

Anode peak voltage	V_{ap}	max.	7 kV
Cathode current	I_K	max.	250 mA
Anode dissipation	W_a	max.	12 W

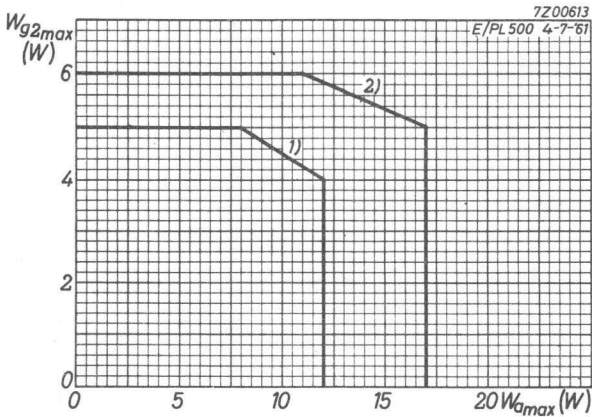

1) Design centre limits for W_a and W_{g2} .

2) These limits for W_a and W_{g2} should not be exceeded with a nominal tube operating in a normal line deflection circuit under the worst probable conditions.

 For further data and curves of this type
 please refer to PL504

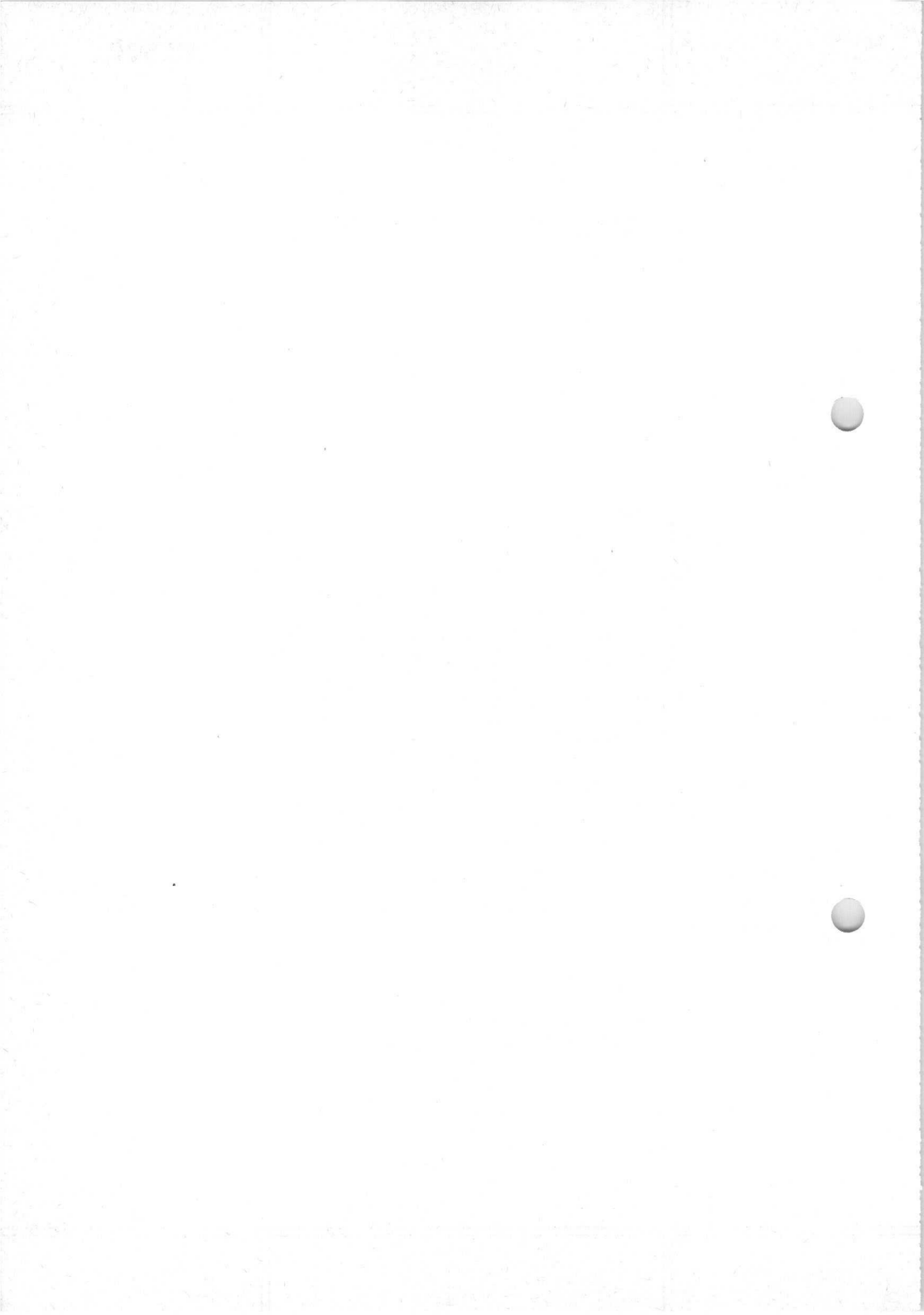

LINE OUTPUT PENTODE

Beam pentode intended for use as line output tube in television receivers.

QUICK REFERENCE DATA

Anode peak voltage	V_{ap}	max.	7 kV
Cathode current	I_k	max.	250 mA
Anode dissipation	W_a	max.	16 W

HEATING: Indirect by A.C. or D.C.; series supply

Heater current

I_f 300 mA

Heater voltage

V_f 27 V

DIMENSIONS AND CONNECTIONS

Dimensions in mm

Base: Magnoval; IEC 67-I-36a

Cap : Type 1

Outline: IEC67-II-15, type 6

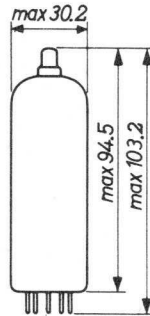
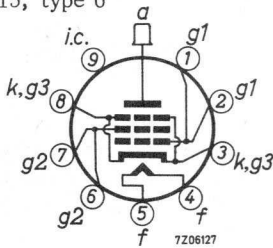

CAPACITANCES

Anode to grid No. 1

C_{ag1} 1.75 pF

Grid No. 1 to heater

C_{g1f} max. 0.2 pF

TYPICAL DYNAMIC CHARACTERISTICS (measured under pulse conditions)

Anode voltage	V_a	50	7000	V
Grid No.2 voltage	V_{g2}	200	200	V
Grid No.1 voltage	V_{g1}	-10	-120	V
Anode current	I_a	420	0.05	mA
Grid No.2 current	I_{g2}	37		mA

OPERATING CHARACTERISTICS

Stabilized circuits (D.C. feedback)

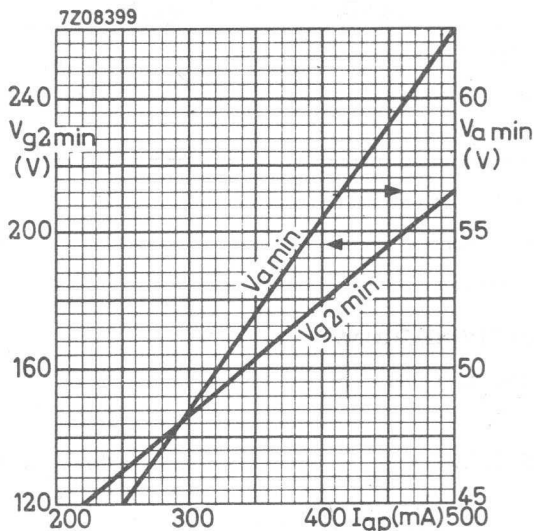

Minimum required values of the screen grid voltage and of the anode voltage when the tube is used in line output stages. The graphs refer to nominal mains voltage provided the specified values of V_a are increased by 10% of the anode supply voltage. The specified values of I_{ap} will be available throughout life of the tube at supply voltage values 10% below nominal.

In order to prevent Barkhausen interferences, care should be taken that the anode voltage never drops below the specified $V_a min.$ during the scanning period.

Non stabilized circuits

Supply voltage	V_b	190	230	V
Grid No.2 series resistor	R_{g2}	2.2	2.2	k Ω
Grid No.1 voltage	V_{g1}	+1	+1	V
Anode peak current	$I_{a,p}$	230	320	mA ¹⁾

¹⁾ See page 3

HUM

At $Z_{g1} = 200 \text{ k}\Omega$ ($f = 50 \text{ Hz}$), $V_{kf} = 220 \text{ V}_{\text{RMS}}$ and without wiring and socket capacitances, the equivalent grid hum voltage is $< 5 \text{ mV}$.

LIMITING VALUES (Design centre rating system unless otherwise stated)

Anode voltage	V_{a0}	max.	550 V
Anode voltage	V_a	max.	250 V
Anode voltage, peak	V_{ap}	max.	7000 V 3)4)
Grid No.2 voltage	V_{g20}	max.	550 V
Grid No.2 voltage	V_{g2}	max.	250 V
Anode dissipation	W_a	see page 4	
Grid No.2 dissipation	W_{g2}	see page 4	2)
Cathode current	I_k	max.	250 mA
Grid No.1 resistor	R_{g1}	max.	0.5 $\text{M}\Omega$ 5)
Cathode to heater voltage	V_{kf}	max.	250 V
Bulb temperature	t_{bulb}	max.	280 $^{\circ}\text{C}$ 6)

NOTES

- To allow for tube spread, deterioration during life and a mains voltage 10 % below nominal, the specified values for I_{ap} should not be exceeded at nominal mains voltage and at the specified conditions.
- To prevent an excessive value of W_{g2} during the heating-up period, the minimum R_{g2} values are given in the graph below.

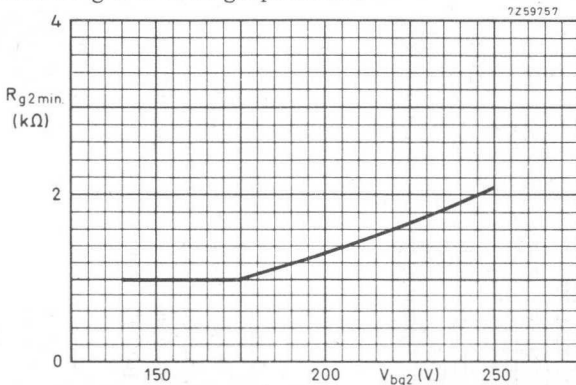

- Maximum pulse duration is 22 % of a cycle and max. 18 μs .
- V_{ap} design max. 8 kV
- $R_{g1} = \text{max. } 2.2 \text{ M}\Omega$ for line output application.
- Absolute max. value.

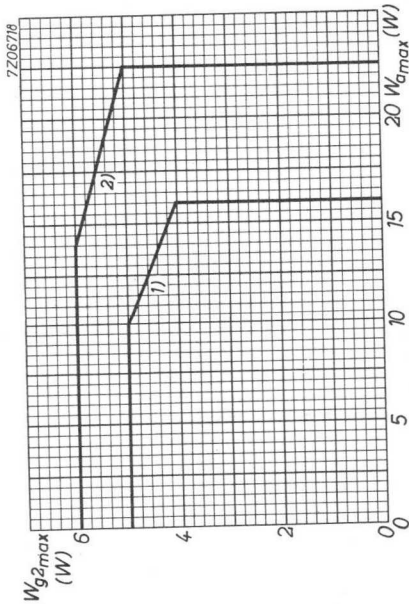
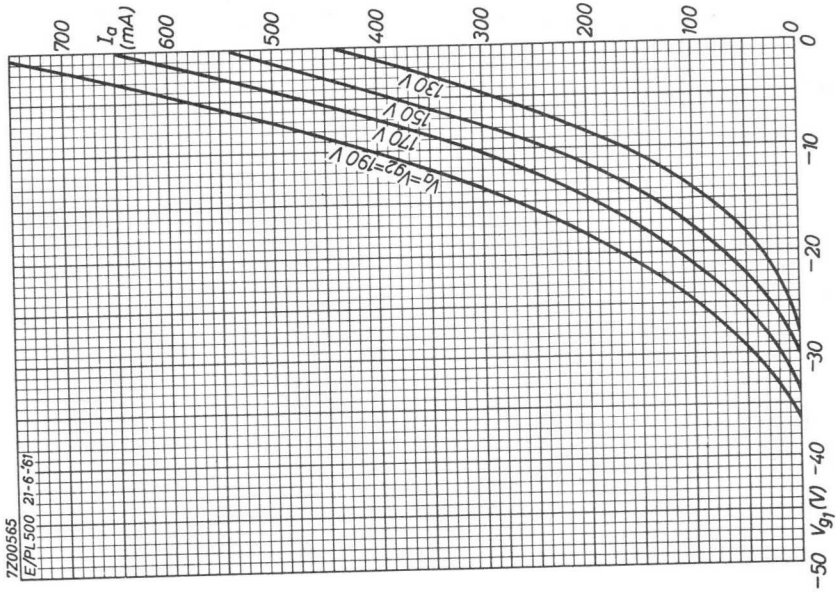

- 1) Design centre limits for W_a and W_{g2} .
- 2) These limits for W_a and W_{g2} should not be exceeded with a nominal tube operating in a normal line deflection circuit under the worst probable conditions.

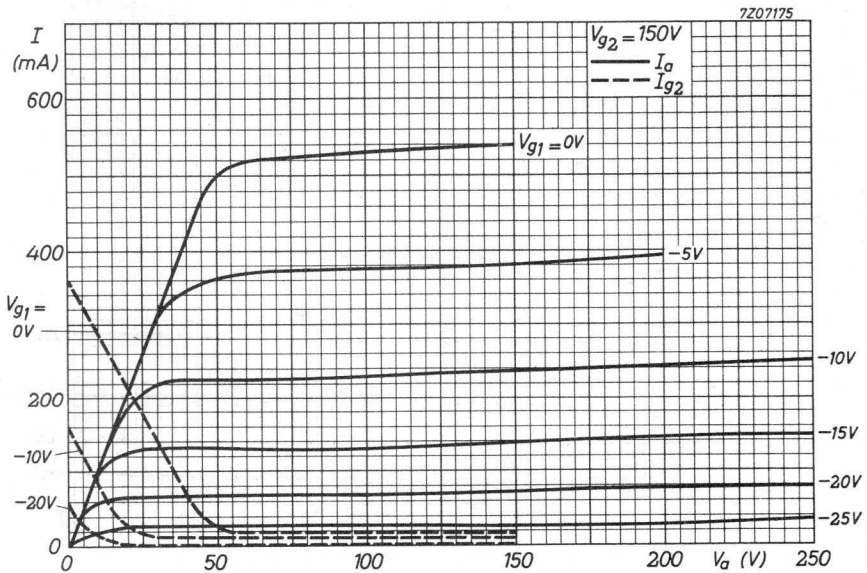
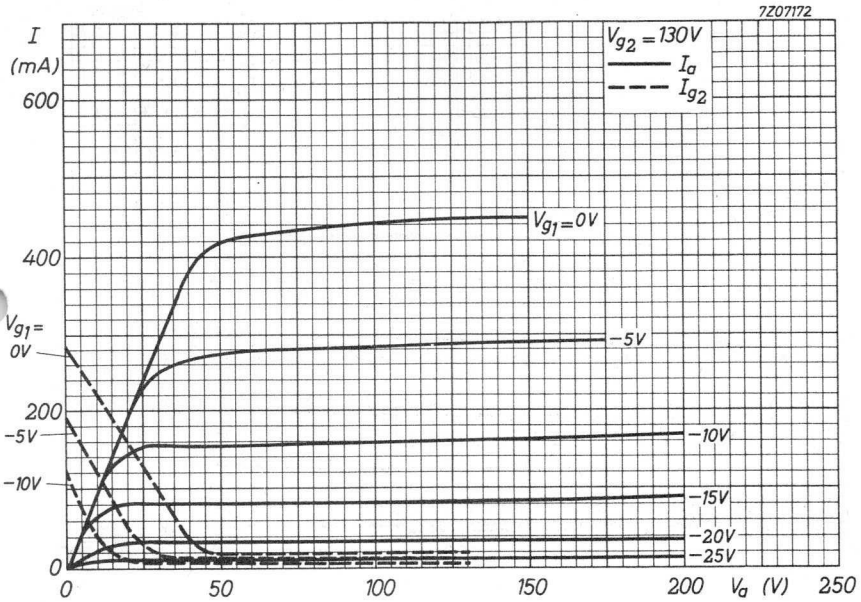

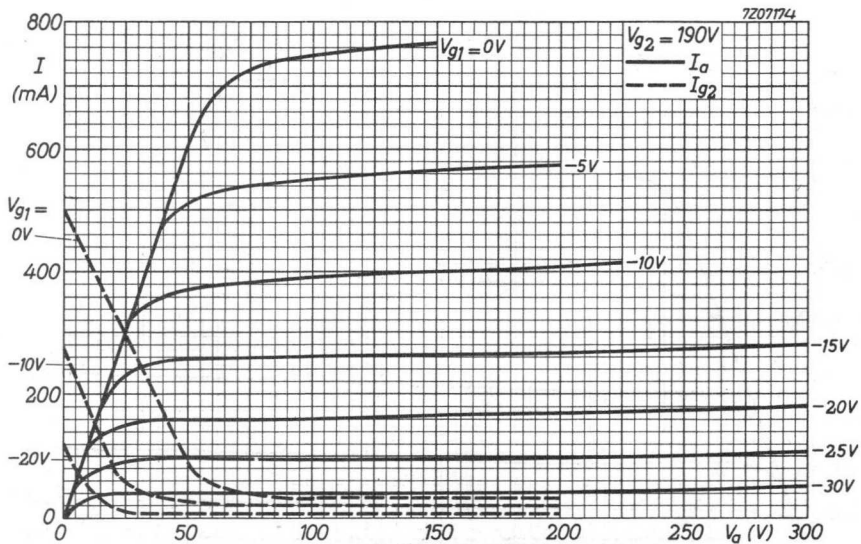
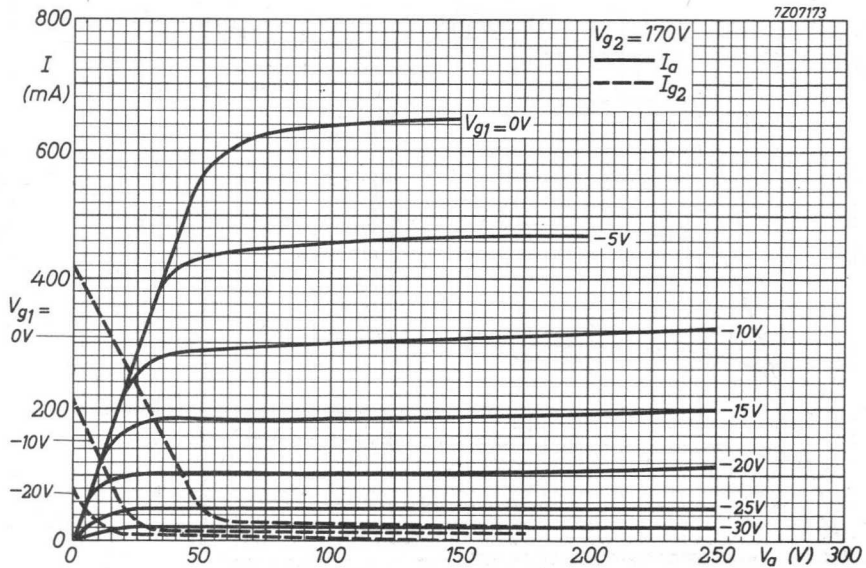

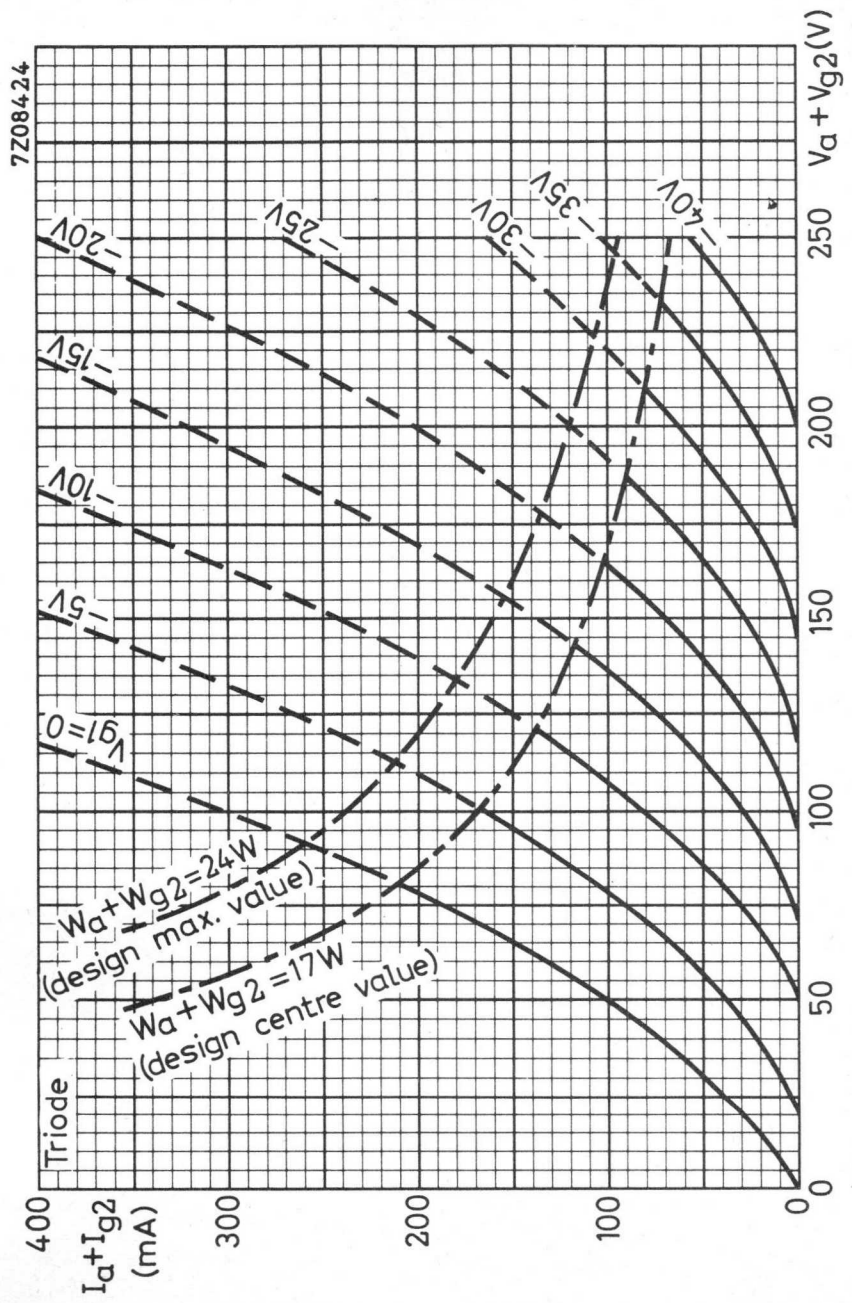

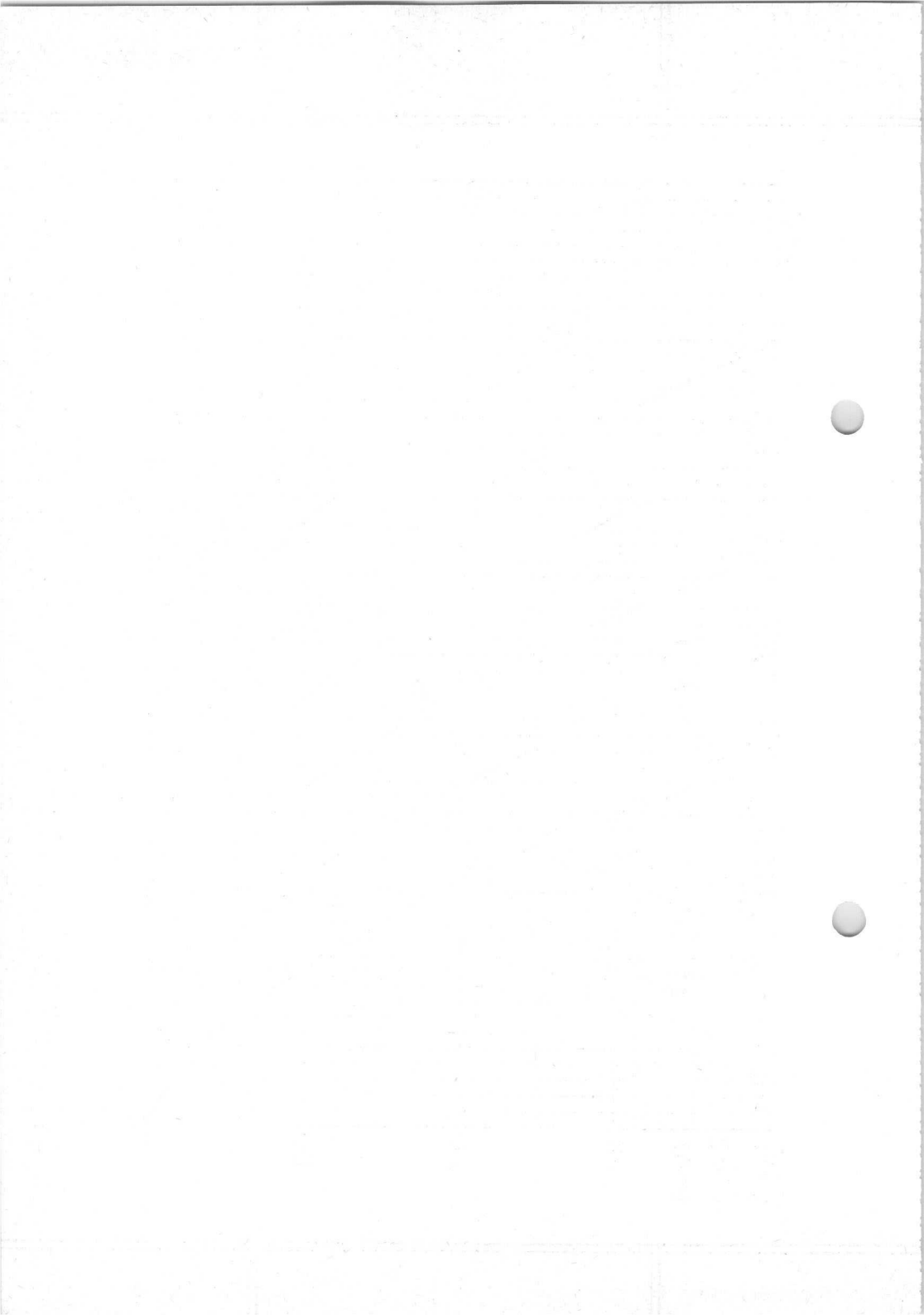

LINE OUTPUT PENTODE

Output pentode intended for colour TV line deflection circuits.

QUICK REFERENCE DATA

Anode peak voltage	V_{ap}	7000	V
Cathode current	I_k	max. 500	mA
Anode dissipation	W_a	max. 25	W

LIMITING VALUES (Design centre rating system)

Anode dissipation	W_a	max. 25	W
Anode + grid No. 2 dissipation (triode connected)	W_a+W_{g2}	max. 26	W

(Design max. rating system)¹⁾

Anode dissipation	W_a	max. 34	W
Anode + grid No. 2 dissipation (triode connected)	W_a+W_{g2}	max. 35	W

 For further data and curves of this type
 please refer to type PL 509

¹⁾ The design maximum limits should not be exceeded with a nominal tube under the worst probable operating conditions at a normal picture width.

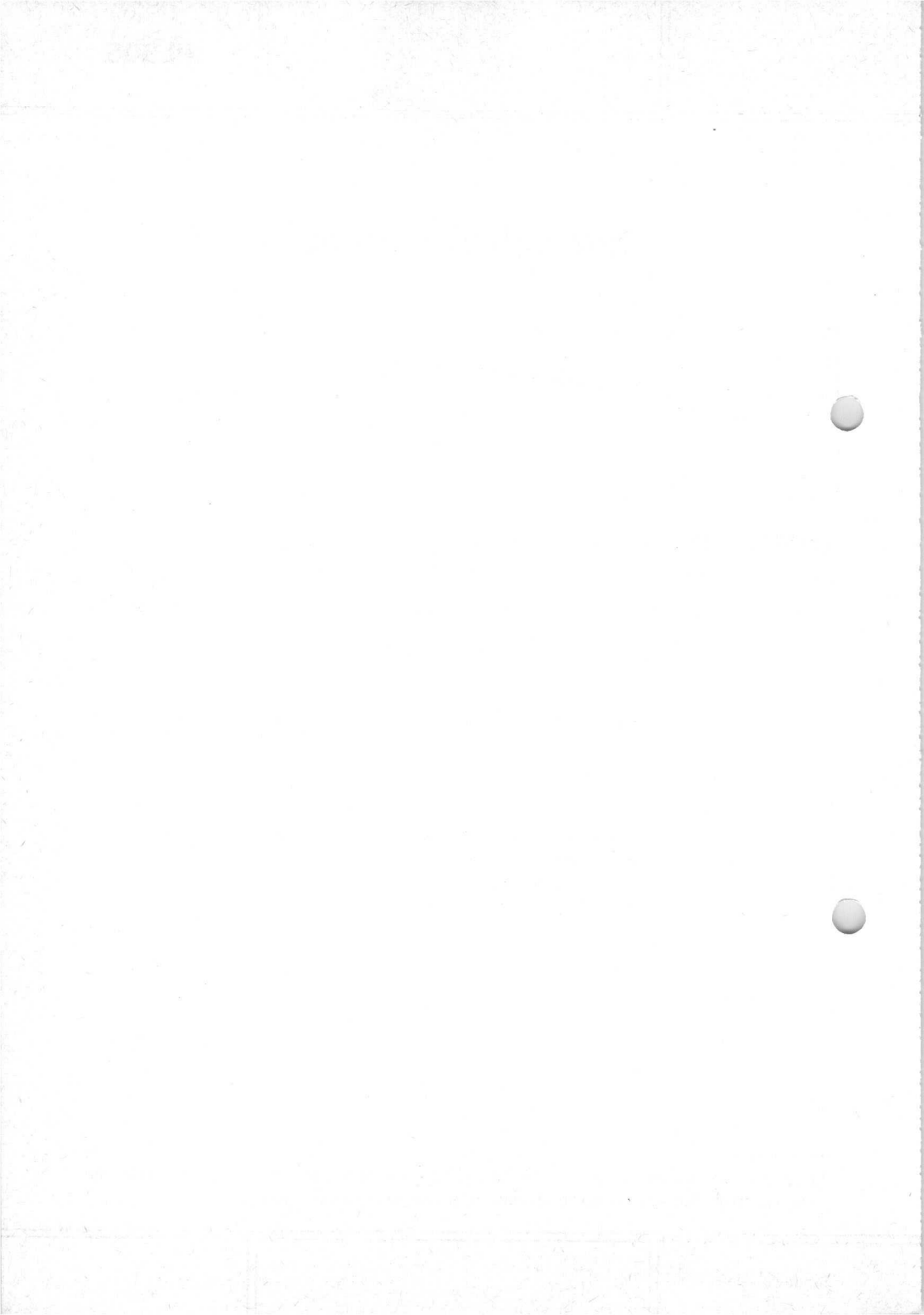

FRAME OUTPUT PENTODE

Pentode intended for use as frame output amplifier in colour television receivers.

QUICK REFERENCE DATA

Cathode current, average	I_k max. 100 mA
Anode dissipation	W_a max. 12 W

HEATING: Indirect by A.C. or D.C.; series supply

Heater current	I_f 300 mA
Heater voltage	V_f 17 V

DIMENSIONS AND CONNECTIONS

Dimensions in mm

Base: Magnoval

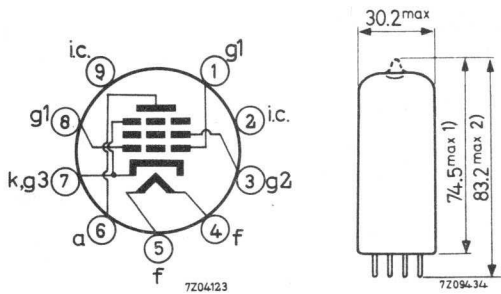

CAPACITANCES

Anode to grid No. 1	C_{ag1} max. 1.6 pF
Grid No. 1 to heater	C_{gf1} max. 0.2 pF

1) Max. 71.4
 2) Max. 80.1 for execution with pumping stem on base side.

TYPICAL CHARACTERISTICS

(Measured under pulse conditions)

Anode voltage	V_a	50	V_a	190 V
Grid No.2 voltage	V_{g2}	190	V_{g2}	190 V
Grid No.1 voltage	V_{g1}	-1	V_{g1}	-17 V
Anode current	I_{ap}	320	I_a	60 mA
Grid No.2 current	I_{g2}	approx. 60	I_{g2}	5 mA
Transconductance			S	9 mA/V
Amplification factor			μ_{g2g1}	8 -

Remarks.

The minimum I_a to be expected as a result of spread of the tube characteristics tube deterioration during life and decrease of the mains voltage to 10 % below the nominal value can be derived from the curves on page B by decreasing by 40 % the I_a values situated on the curve A-B at V_{g2} occurring at the decreased mains voltage.

In order not to exceed the maximum permissible value of W_{g2} , the circuit should be designed in such a way that the anode voltage should never be lower than the value determined by curve A-B at the relevant V_{g2} value.

OPERATING CHARACTERISTICS (end of scan values)

Anode voltage	V_a	70 V
Grid No.2 voltage	V_{g2}	200 V
Grid No.1 voltage	V_{g1}	-5 V
Anode peak current	I_{ap}	230 mA

LIMITING VALUES (design centre rating system) unless otherwise stated

Anode voltage	V_{a_0}	max.	700	V
	V_a	max.	400	V
Anode peak voltage	V_{ap}	max.	2.5 kV	1)
Grid No.2 voltage	V_{g2_0}	max.	700	V
	V_{g2}	max.	275	V
Anode dissipation	W_a	max.	12	W
Grid No.2 dissipation	W_{g2}	max.	3	W
design max.	W_{g2}	max.	4	W
Cathode current	I_k	max.	100	mA
Grid No.1 resistor, fixed bias	R_{g1}	max.	1	$M\Omega$
automatic bias	R_{g1}	max.	2.2	$M\Omega$
Cathode to heater voltage	V_{kf}	max.	220	V

MICROPHONY

The maximum peak acceleration to which the tube may be subjected under the most unfavourable conditions is 1.5 g at frequencies < 600 Hz. and 0.2 g at frequencies > 600 Hz. The equivalent interference voltage at grid No.1 will than be < 25 mV.

1) Max. pulse duration 5% of a cycle and max. 1 ms.

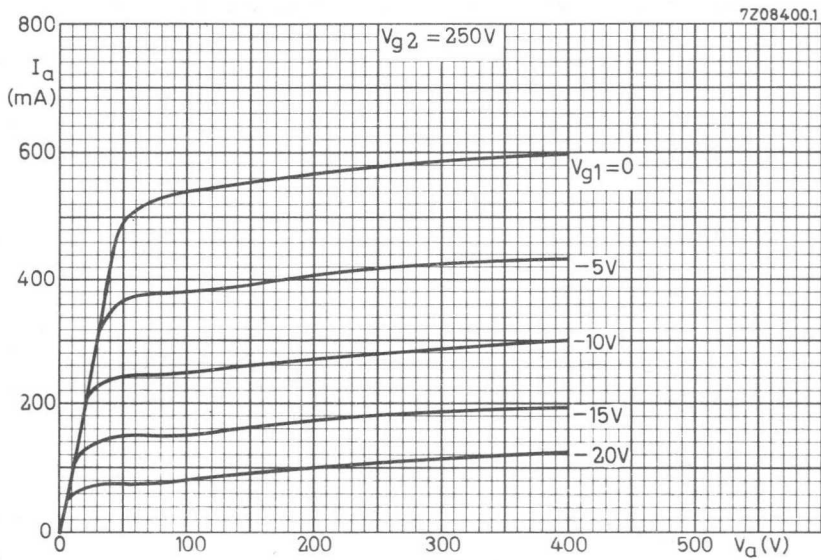
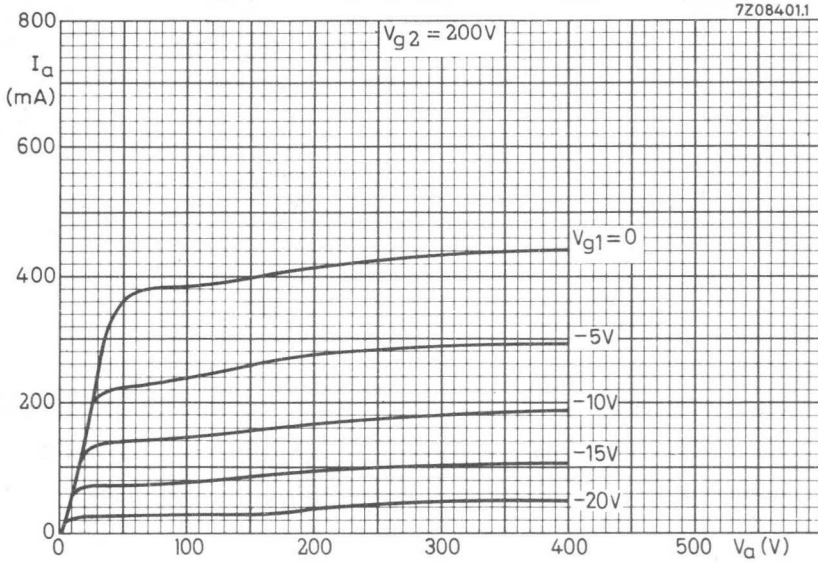

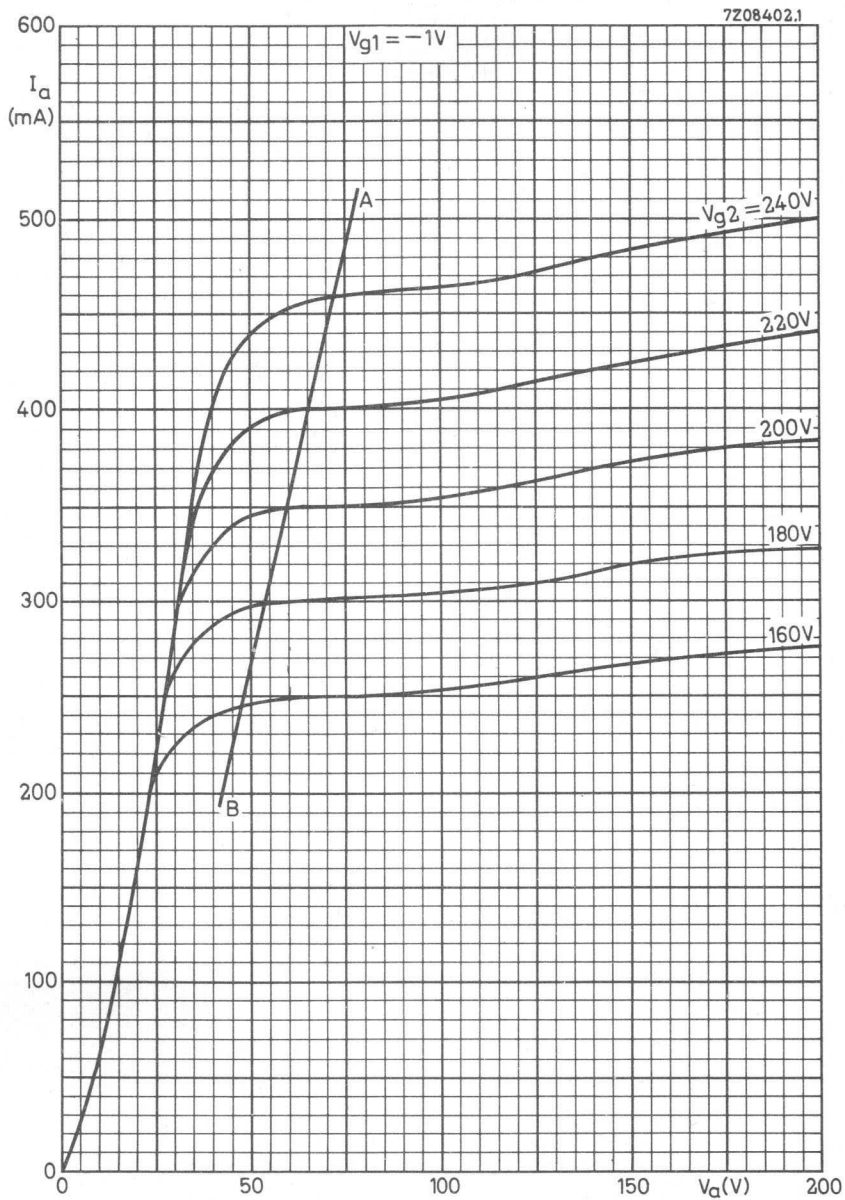

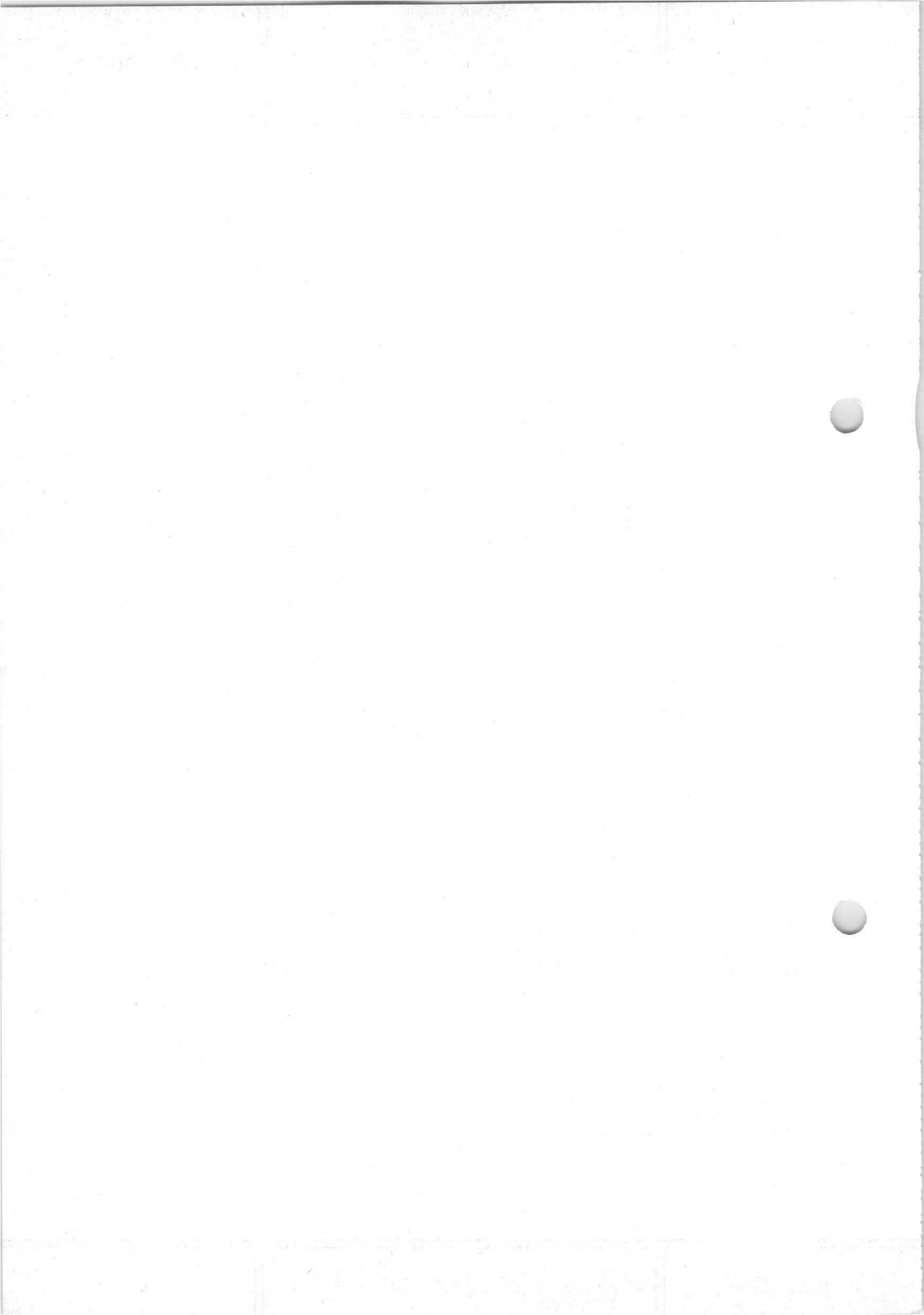

LINE OUTPUT PENTODE

Output pentode intended for colour TV line deflection circuits.

QUICK REFERENCE DATA			
Anode peak voltage	V_{a_p}	7000	V
Cathode current	I_k	max. 500	mA
Anode dissipation	W_a	max. 30	W

HEATING: Indirect by A.C. or D.C.; series supply

Heater current

I_f 300 mA

Heater voltage

V_f 40 V

DIMENSIONS AND CONNECTIONS

Dimensions in mm

Base: Magnoval

Top cap: Type 1

Mounting: Additional supporting of the tube at the top is required.

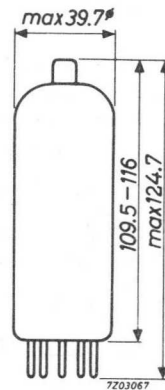
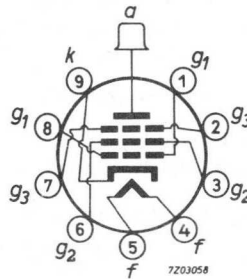

CAPACITANCES

Grid No.1 to filament

C_{g_1f} max. 0.2 pF

Anode to grid No.1

C_{ag_1} max. 3.0 pF

C_{ag_1} 2.5 pF

TYPICAL CHARACTERISTICS (measured under pulse conditions)

Anode voltage	V_a	160	50 V
Grid No.3 voltage	V_{g3}	0	0 V
Grid No.2 voltage	V_{g2}	160	175 V
Grid No.1 voltage	V_{g1}	0	-10 V
Anode current	I_a	1400	800 mA
Grid No.2 current	I_{g2}	45	70 mA

OPERATING CONDITIONS (D.C. feedback)

Cut-off voltage

The minimum required cut-off voltage ($-V_{g1}$) during flyback at $V_a = 7000$ V and at line frequency is at :

$$\begin{aligned} V_{g2} = 150 \text{ V} : V_{g1} &= -175 \text{ V} \\ V_{g2} = 200 \text{ V} : V_{g1} &= -195 \text{ V} \\ V_{g2} = 250 \text{ V} : V_{g1} &= -215 \text{ V} \end{aligned}$$

Supply voltages: See pages 4-5-6

Minimum required anode voltage: $V_a \text{ min}$

In order to prevent Barkhausen interference and loss of stabilization, care should be taken that the anode voltage never drops below the specified $V_a \text{ min}$ during the scanning period.

If low values of $V_a \text{ min}$ are required, the $V_a \text{ min}$ 1-line can be shifted over 10 V to $V_a \text{ min}$ 2, provided a D.C. voltage of at least +20 V is applied to the beamplate (g_3). To compensate for the influence of mains voltage variations, the specified values of $V_a \text{ min}$ have to be increased with 10% of the anode supply voltage.

Minimum required values of the screen grid voltage: $V_{g2 \text{ min}}$

The graph refers to nominal mains voltage. The specified values of I_{aP} will be available throughout life of the tube at supply voltages 10% below nominal.

Maximum permissible screen grid series resistance: $R_{g2 \text{ max}}$. See pages 4-5-6

Decoupling-capacitors in the grid no 2 and/or grid no 3 circuit

In circuits where decoupling capacitors in the grid no 2 or the grid no 3 circuits are applied, incidental flashover in the tube may give rise to excessive discharge currents and component or tube failure.

Therefore it is recommended to limit the discharge currents to these capacitors by means of an 100 Ohm resistance between g_2 and the g_2 -bypass capacitance.

The 1000 Ohms resistance should be protected by a spark-gap connected between g_3 and earth.

Hum

At $Z_{g1} = 200 \text{ k}$ ($f = 50 \text{ Hz}$), $V_{k/f} = 220 \text{ V}_{\text{RMS}}$ and without wiring and socket capacitance, the equivalent grid hum voltage is less than 5 mV.

LIMITING VALUES

Design centre rating system

Anode voltage in cold condition	V_{Ao}	max.	700 V
Anode peak voltage	V_{Ap}	max.	7000 V ¹⁾
Anode dissipation	W_a	max.	30 W
Anode + grid No.2 dissipation (triode-connected)	$W_a + W_{g2}$	max.	31 W
Grid No.3 voltage	V_{g3}	max.	50 V
Grid No.2 voltage in cold condition	V_{g2o}	max.	700 V
Grid No.2 voltage	V_{g2}	max.	275 V
Grid No.2 dissipation	W_{g2}	max.	7 W ²⁾
Cathode current	I_k	max.	500 mA
Cathode peak current	I_{kp}	max.	1200 mA
Cathode-to-heater voltage	V_{kf}	max.	250 V
Grid No.1 resistor: fixed bias	R_{g1}	max.	0.5 MΩ ³⁾
stabilized circuits	R_{g1}	max.	2.2 MΩ ³⁾
Grid No.3 circuit resistance	R_{g3}	max.	10 kΩ ⁴⁾
Bulb temperature	t_{bulb}	max.	300 °C ⁵⁾

Design max. rating system ⁶⁾

Anode dissipation	W_a	max.	40 W
Anode + grid No.2 dissipation (triode connected)	$W_a + W_{g2}$	max.	42 W
Grid No.2 dissipation	W_{g2}	max.	9 W
Anode peak voltage	V_{Ap}	max.	8000 V ¹⁾
Neg. grid No.1 peak voltage	$-V_{g1p}$	max.	550 V ¹⁾

- Max. pulse duration is 22% of a cycle and max. 18 μs.
- To prevent an excessive value of W_{g2} the minimum R_{g2} values are given in the graph below.

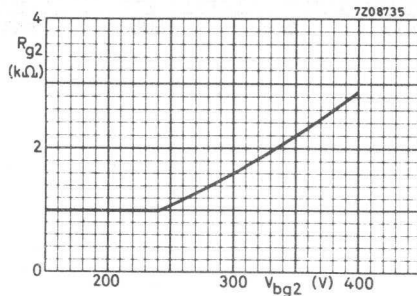

- The circuit design has to be such that negative control grid currents up to 5 micro-amperes do not have any detrimental effect upon tube adjustment or circuit performance.

Care should be taken that with 5 micro-amperes grid current the limiting values for I_k , W_a and W_{g2} are not exceeded.

- With $R_{g3} \leq 10 \text{ k}\Omega$ capacitive decoupling of g_3 is not required.
- Absolute max. value.
- The design maximum limits should not be exceeded with a nominal tube under the worst probable operating conditions at a normal picture width.

Min. required anode voltage.

$R_{g2 \text{ max}}$: max. permissible screen grid series resistance for 400 V screen grid supply.

The specified values of I_{ap} are available at supply voltages 10% below nominal and throughout the tube life.

Remark: $R_{g2 \text{ min}}$ for 400 V screen grid supply is 2.9 k Ω . (See page 3)

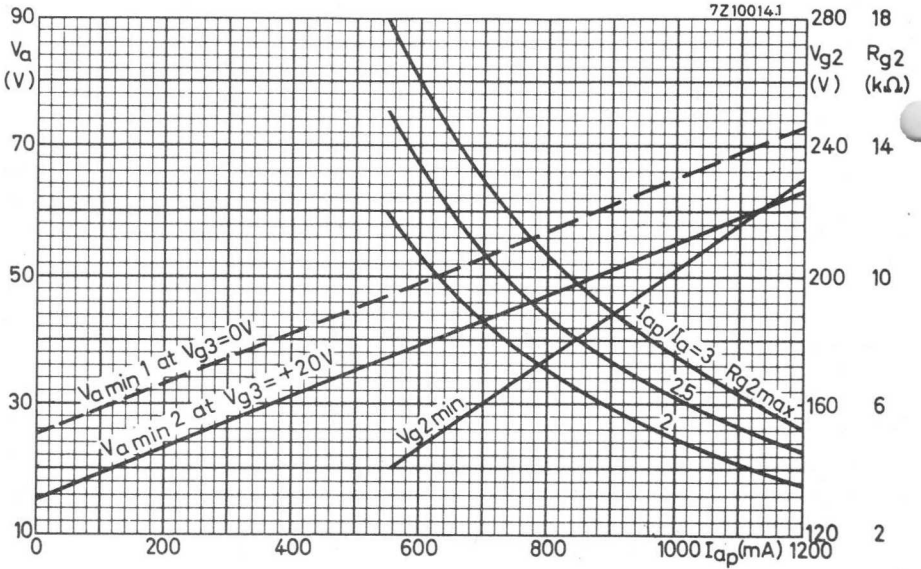

Min. required anode voltage.

$R_{g2\text{ max}}$: max. permissible screen grid series resistance for 350 V screen grid supply.

The specified values of I_{ap} are available at supply voltages 10% below nominal and throughout the tube life.

Remark: $R_{g2\text{ min}}$ for 350 V screen grid supply is 2.2 k Ω . (See page 3)

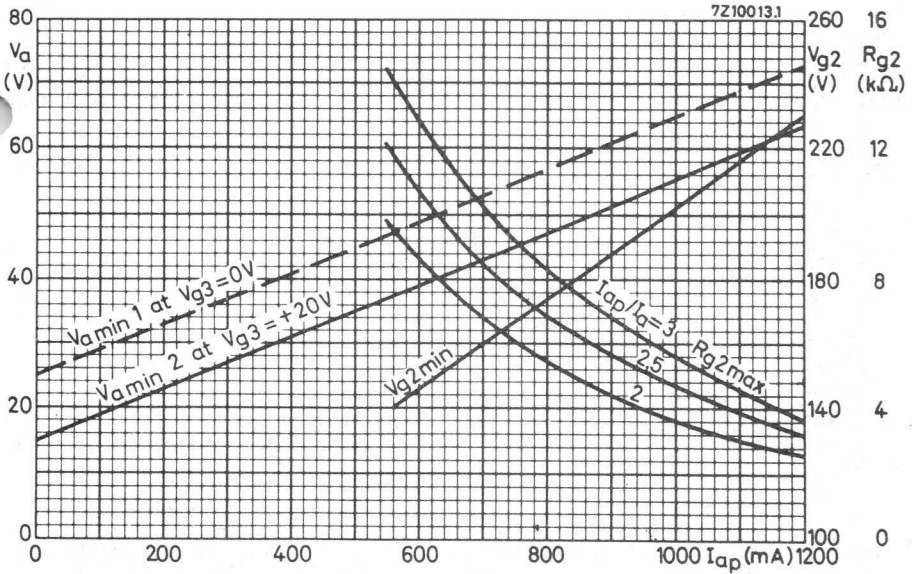

Min. required anode voltage.

$R_{g2 \text{ max.}}$: max. permissible screen grid series resistance for 280 V screen grid supply.

The specified values of I_{aP} are available at supply voltages 10% below nominal and throughout the tube life.

Remark: $R_{g2 \text{ min}}$ for 280 V screen grid supply is 1.4 k Ω . (See page 3)

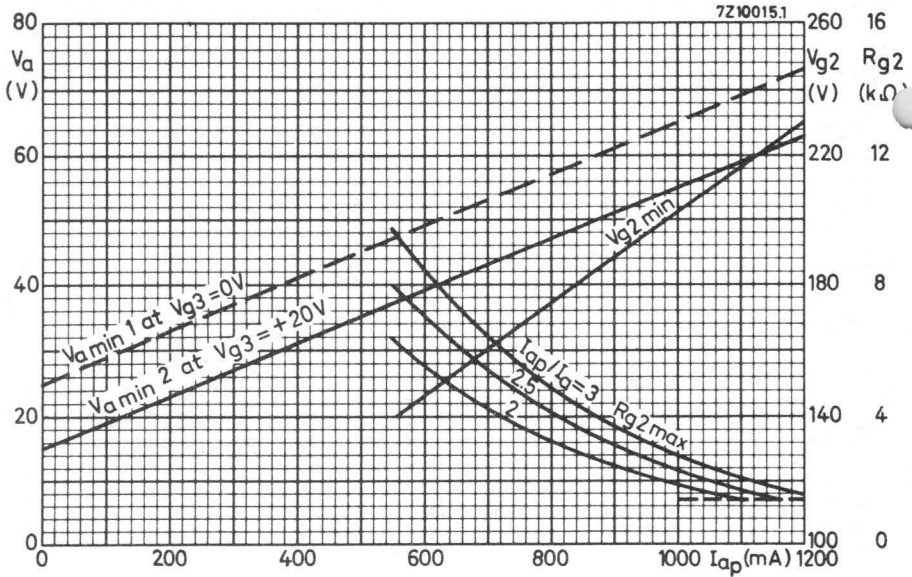

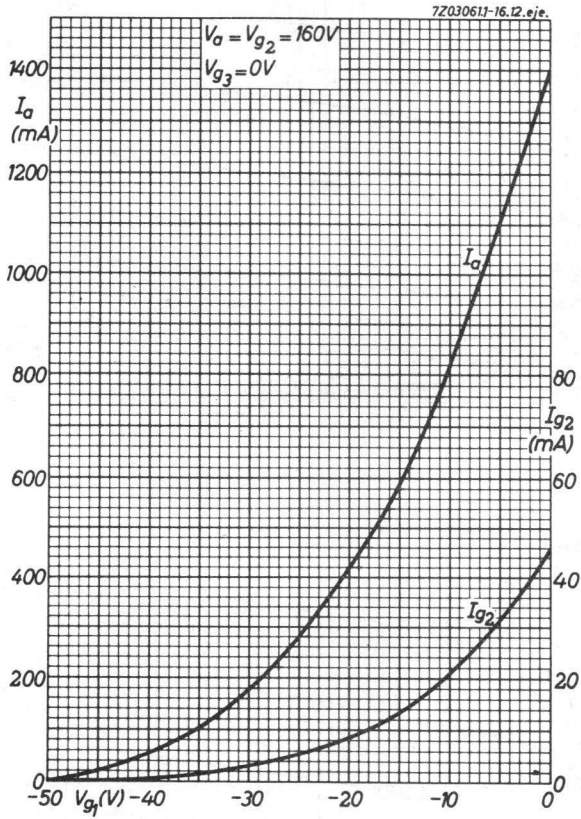

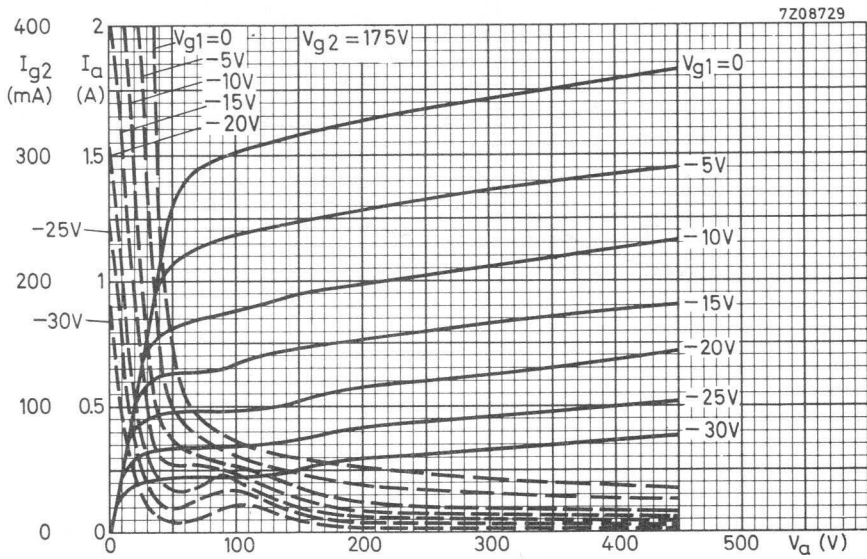
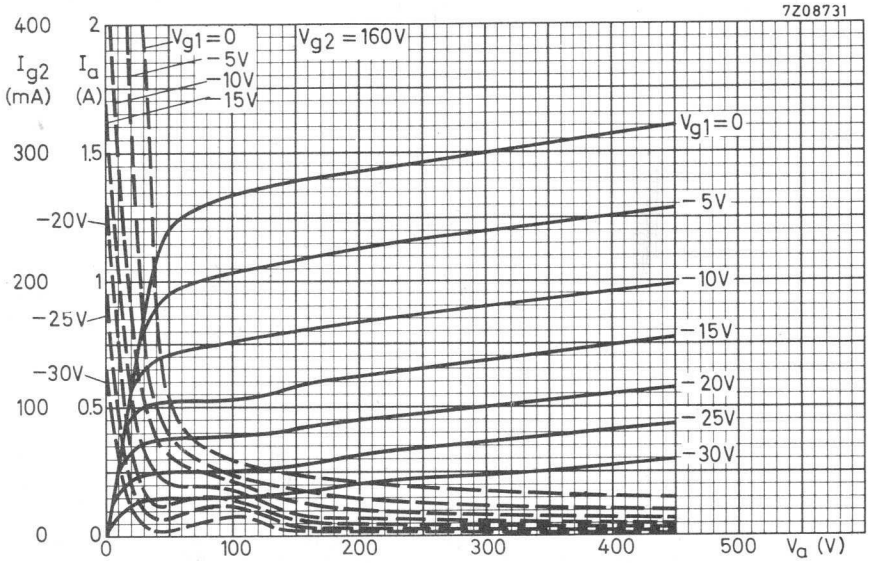

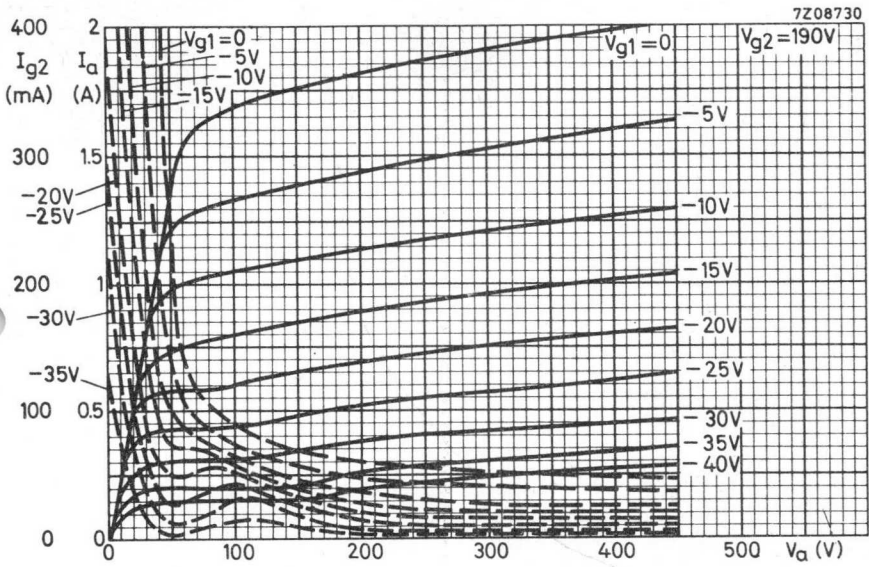



LINE OUTPUT PENTODE

Output pentode intended for colour TV line deflection circuits.

HEATING: Indirect by A.C. or D.C.; series supply

Heater current

I_f 300 mA

Heater voltage

V_f 40 V

DIMENSIONS AND CONNECTIONS

Base: Magnoval

Top cap: Type 1

Mounting: Additional supporting of the tube at the top is required.

Dimensions in mm

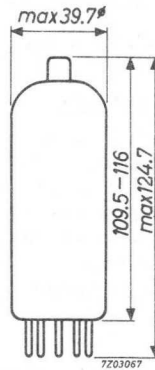
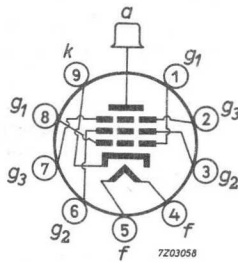

CAPACITANCES

Grid No. 1 to filament

C_{g1f} max. 0.2 pF

Anode to grid No. 1

C_{ag1} max. 3.0 pF

C_{ag1} 2.5 pF

TYPICAL CHARACTERISTICS (measured under pulse conditions)

Anode voltage	V_a	160	50	70	V
Grid No. 3 voltage	V_{g3}	0	0	0	V
Grid No. 2 voltage	V_{g2}	160	175	205	V
Grid No. 1 voltage	V_{g1}	0	-10	-11	V
Anode current	I_a	1400	800	1100	mA
Grid No. 2 current	I_{g2}	45	70	85	mA

OPERATING CONDITIONS (D. C. feedback)

Cut-off voltage

The minimum required cut-off voltage ($-V_{g1}$) during flyback at $V_a = 7000$ V and at line frequency is at :

$$\begin{aligned} V_{g2} = 150 \text{ V} : V_{g1} &= -175 \text{ V} \\ V_{g2} = 200 \text{ V} : V_{g1} &= -195 \text{ V} \\ V_{g2} = 250 \text{ V} : V_{g1} &= -215 \text{ V} \end{aligned}$$

Minimum required anode voltage during the scanning period: V_a min. See page 6

Minimum required screen grid voltage: V_{g2} min. See page 4, 5

Recommended screen grid series resistor: R_{g2} rec See page 4, 5

Decoupling capacitors in the grid no. 2 and/or grid no. 3 circuit

In circuits where decoupling capacitors in the grid no. 2 or the grid no. 3 circuits are applied, incidental flashover in the tube may give rise to excessive discharge currents and component or tube failure.

Therefore it is recommended to limit the discharge currents from these capacitors by means of a 100Ω resistor between g_2 and the g_2 -bypass capacitor and a 1000Ω resistor between g_3 and the g_3 -bypass capacitor. The 1000Ω resistor should be protected by a spark-gap connected between g_3 and earth.

Hum

At $Z_{g1} = 200 \text{ k}\Omega$ ($f = 50 \text{ Hz}$), $V_{kf \text{ RMS}} = 220 \text{ V}$ and without wiring and socket capacitance, the equivalent grid hum voltage is less than 5 mV.

LIMITING VALUES

Design centre rating system

Anode voltage in cold condition	V_{a0}	max.	700	V
Anode peak voltage	V_{ap}	max.	7000	V
Anode dissipation	W_a	max.	35	W
Grid No. 3 voltage	V_{g3}	max.	30	V
Grid No. 2 voltage in cold condition	V_{g20}	max.	700	V
Grid No. 2 voltage	V_{g2}	max.	275	V
Grid No. 2 dissipation	W_{g2}	max.	7	W ²⁾
Cathode current	I_k	max.	500	mA
Cathode peak current	I_{kp}	max.	1500	mA
Cathode-to-heater voltage	V_{kf}	max.	250	V
Grid No. 1 resistor: fixed bias stabilized circuits	R_{g1}	max.	0.5	$M\Omega$ ³⁾
	R_{g1}	max.	2.2	$M\Omega$ ³⁾
Grid No. 3 circuit resistance	R_{g3}	max.	10	$k\Omega$ ⁴⁾
Bulb temperature	t_{bulb}	max.	300	$^{\circ}C$ ⁵⁾

Design max. rating system ⁶⁾

Anode dissipation	W_a	max.	45	W
Grid No. 2 dissipation	W_{g2}	max.	9	W
Anode peak voltage	V_{ap}	max.	8000	V ¹⁾
Neg. grid No. 1 peak voltage	$-V_{g1p}$	max.	550	V ¹⁾

1. Max. pulse duration is 22% of a cycle and max. 18 μs .
2. To prevent an excessive value of W_{g2} the minimum R_{g2} values are given in the graph below.

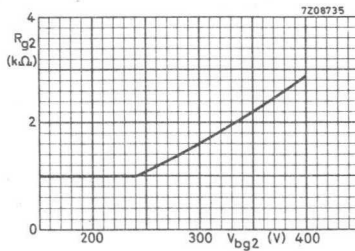

3. The circuit design has to be such that negative control grid currents up to 5 micro-amperes do not have any detrimental effect upon tube adjustment or circuit performance.
Care should be taken that with 5 micro-amperes grid current the limiting values for I_k , W_a and W_{g2} are not exceeded.
4. With $R_{g3} \leq 10 k\Omega$ capacitive decoupling of g_3 is not required.
5. Absolute max. value.
6. The design maximum limits should not be exceeded with a nominal tube under the worst probable operating conditions at a normal picture width.

Min. required V_{g2} and recommended R_{g2}
 Non-stabilized supply voltages.

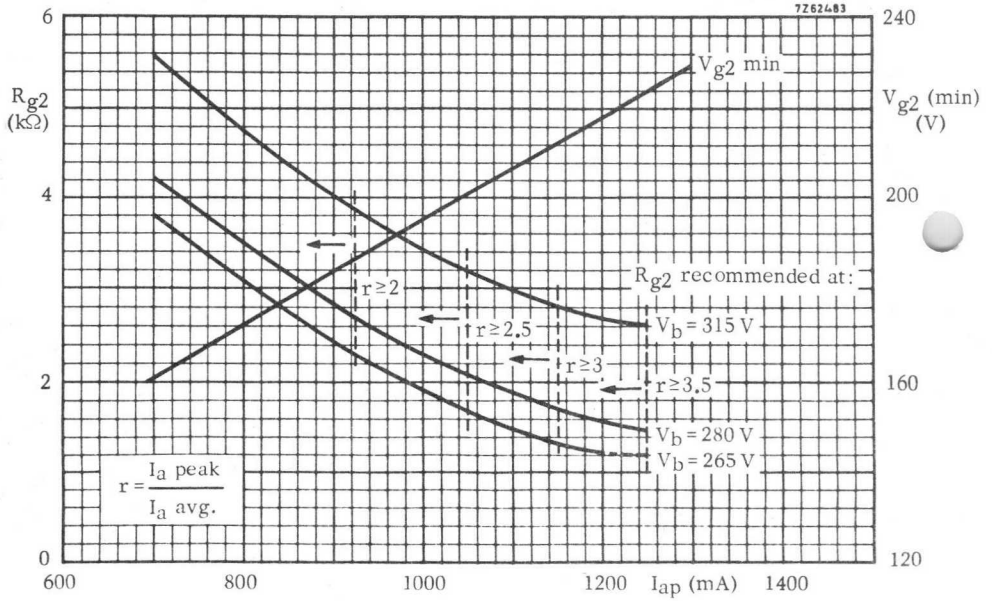

Min. required V_{g2} and recommended R_{g2}
 Stabilized supply voltage.

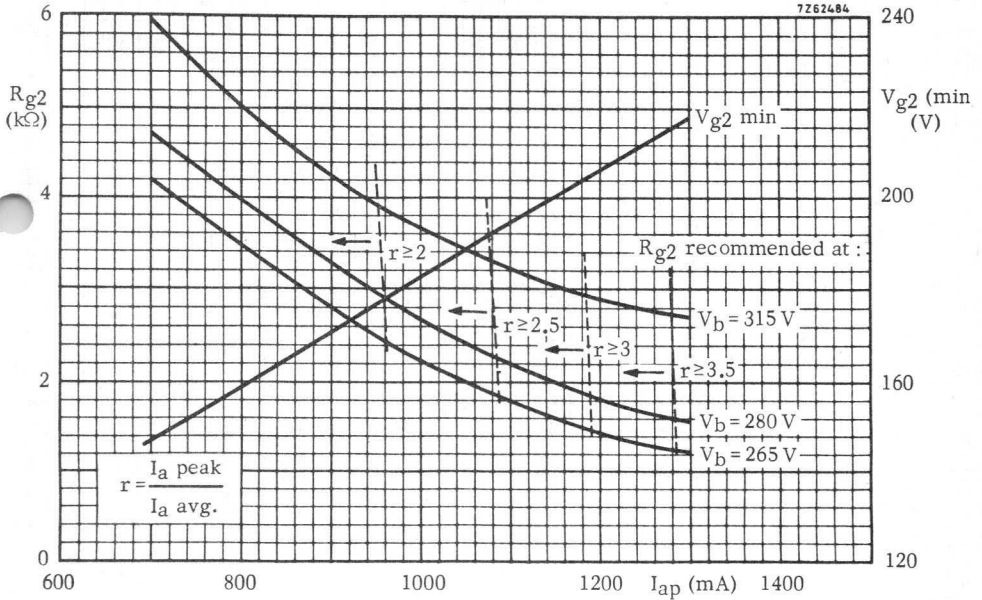

The above graphs concern the design of a line-output circuit adjusted at a beam current of 1000 μ A and a nominal mains voltage.

If the recommended R_{g2} is used, V_{g2} will be equal to higher or than the specified V_{g2} min. and there will be adequate reserve in anode peak current throughout the life of the tube. (Tolerances of deflection-components and 10 % mains voltage fluctuations taken into account).

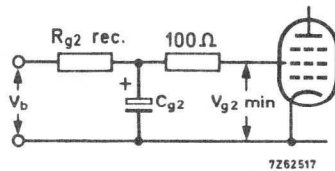

Min. required anode voltage, during the scanning period.

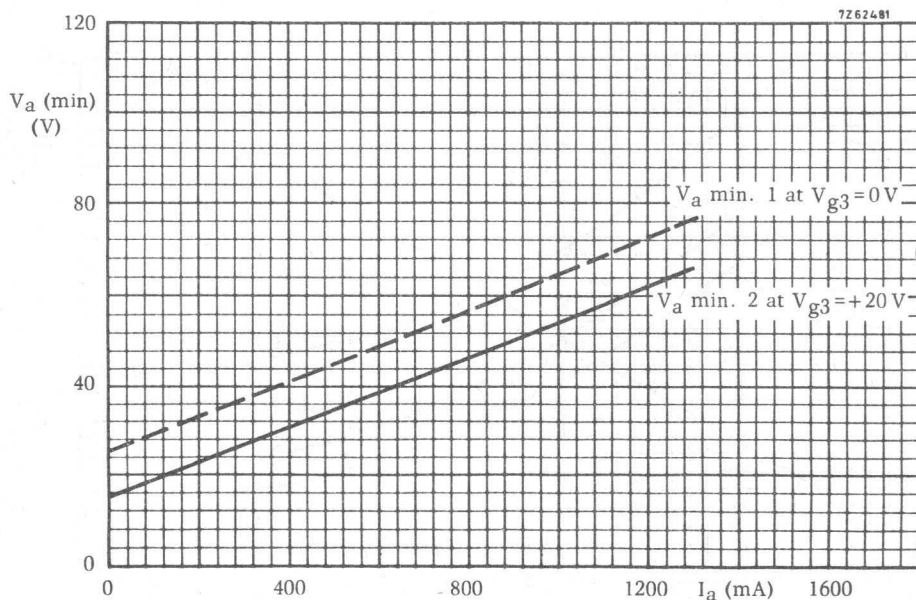

To suppress Barkhausen interference and to ensure stability, the anode load line should not be allowed to drop below the V_a line shown in the diagram. If V_a min. must be low, the V_a min. 1-line can be shifted over 10 V to V_a min. 2, provided a D.C. voltage of at least +20 V is applied to the beam plate (g_3). To compensate for the influence of mains voltage fluctuations, the specified values of V_a min. must be increased with 10 % of the anode supply voltage when not stabilized.

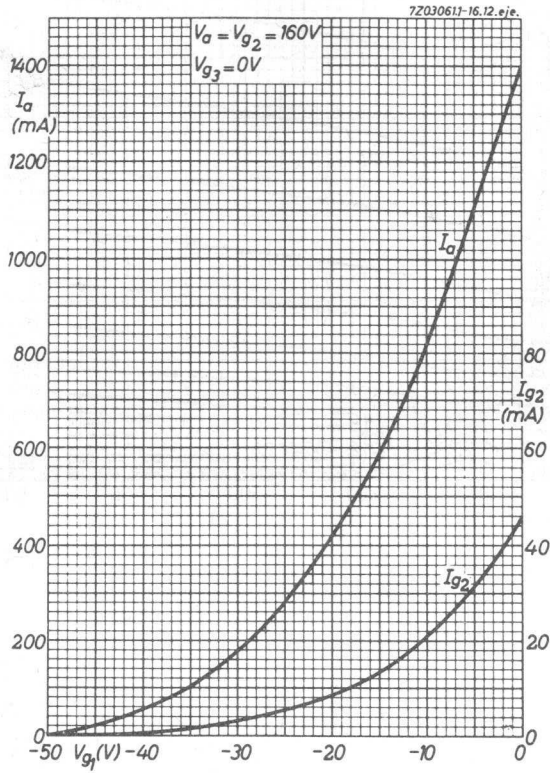

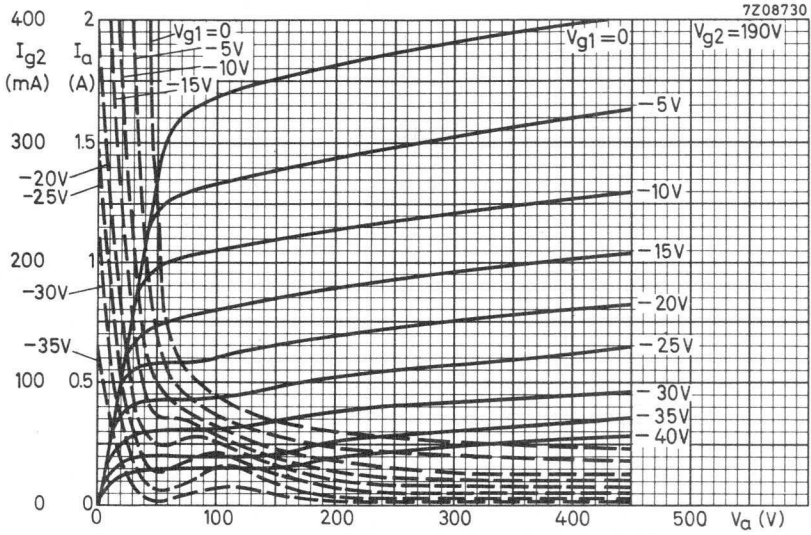

VIDEO OUTPUT PENTODE

Luminance output tube in colour TV receivers.

QUICK REFERENCE DATA		
Anode current	I_a	30 mA
Transconductance	S	40 mA/V
Anode dissipation	W_a	max. 6 W

HEATING: Indirect by A.C. or D.C.; series supply

Heater current	I_f	300 mA
Heater voltage	V_f	16 V

DIMENSIONS AND CONNECTIONS

Dimensions in mm

Base: Noval

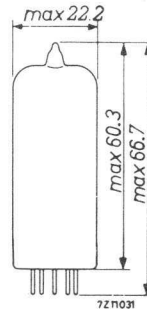
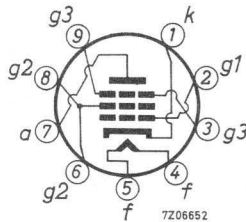

CAPACITANCES

Anode to all except grid No.1	$C_a(g_1)$	4 pF
Grid No.1 to all except anode	$C_{g_1(a)}$	20 pF
Anode to grid No.1	C_{ag_1}	0.075 pF
Anode to grid No.1	C_{ag_1} max.	0.1 pF

TYPICAL CHARACTERISTICS

Anode voltage	V_a	170 V
Grid No.2 voltage	V_{g2}	170 V
Grid No.3 voltage	V_{g3}	0 V
Grid No.1 supply voltage	V_{bg1}	0 V
Cathode resistor (decoupled)	R_k	36 Ω
Anode current	I_a	30 mA
Grid No.2 current	I_{g2}	6.5 mA
Transconductance	S	40 mA/V
Amplification factor	μ_{g2g1}	70 -

LIMITING VALUES (Design centre rating system unless otherwise stated)

Anode supply voltage	V_{ba}	max. 400 V
Anode voltage,	V_{a0}	max. 550 V
long term average	V_a	max. 300 V
Grid No.2 voltage	V_{g20}	max. 550 V
	V_{g2}	max. 300 V
Anode dissipation	W_a	max. 6 W
Grid No.2 dissipation	W_{g2}	max. 2.5 W
	W_{g2}	max. 3.0 W 1)
Cathode current	I_k	max. 100 mA
Grid No.1 resistor	R_{g1}	max. 0.1 M Ω
at $R_k \geq 39 \Omega$	R_{g1}	max. 0.5 M Ω
Cathode to heater voltage	V_{kf}	max. 200 V

¹⁾ Design maximum rating system including no signal condition.

OPERATING CONDITIONS (negative modulation)

- $V_b = 250 \text{ V}$
- $R_b = 330 \ \Omega$
- $R_{av} = 560 \ \Omega$
- $R_a = 2.7 \text{ k}\Omega$
- $R_{g2} = 5.6 \text{ k}\Omega$
- $R_k^{1)} = 39 \ \Omega$
- $+V_{bg1} = 4 \text{ V}$

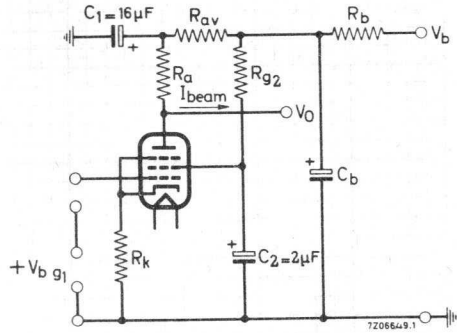

fig. 1

- $V_{o1} = 100 \text{ V}$
- $V_{opp} \cong 140 \text{ V}$
- Video-linearity $\cong 0.8 -$
- V_{ipp} ca. 5 V
- I_{beam} max. 7 mA

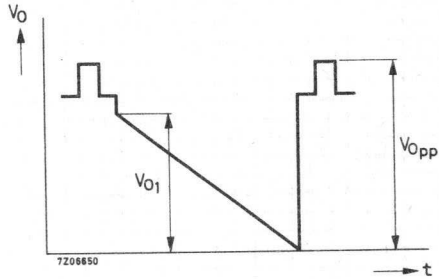
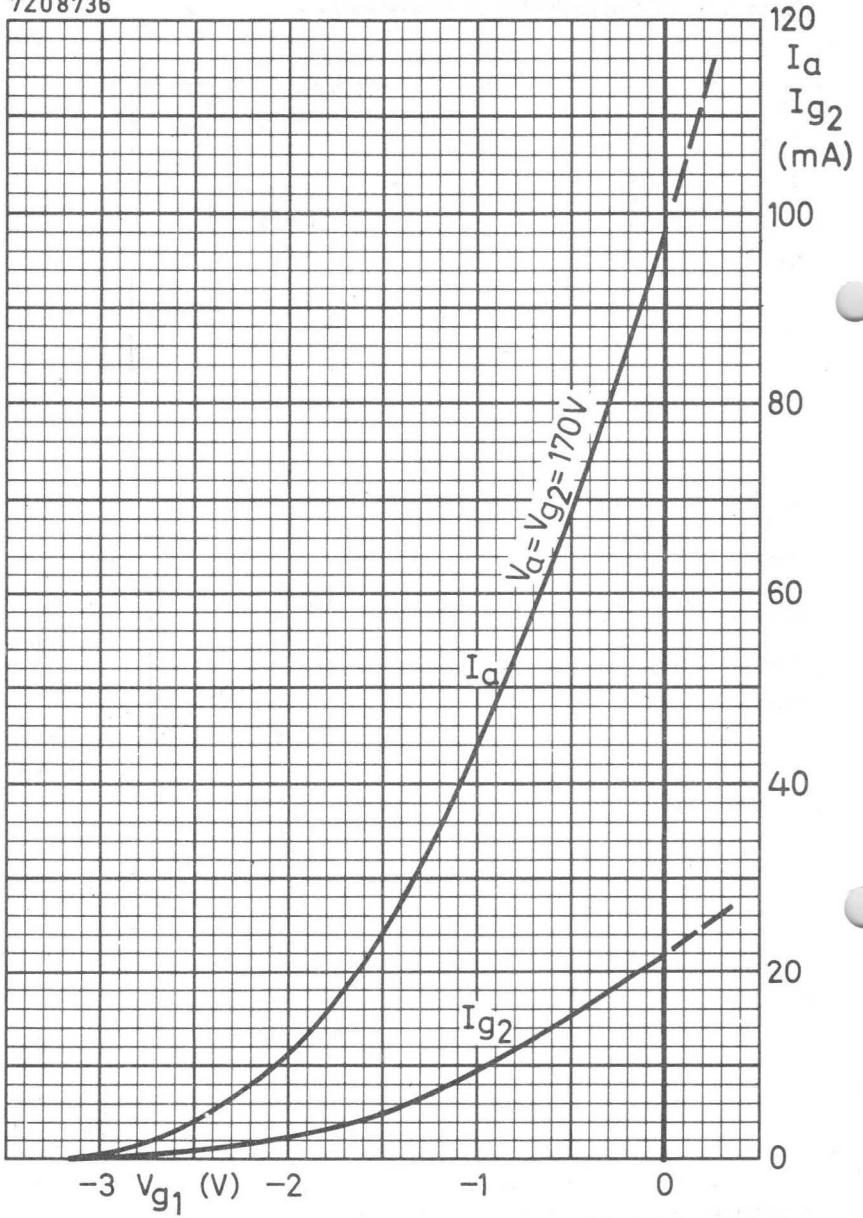
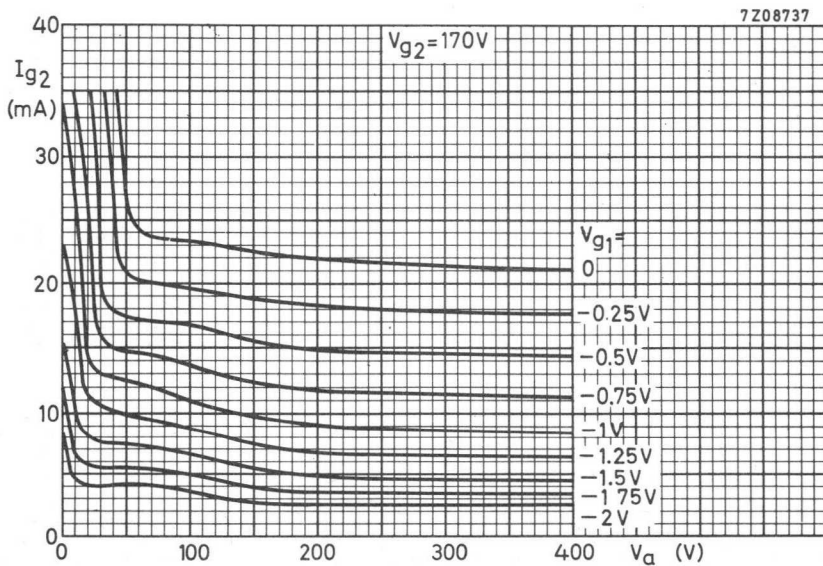
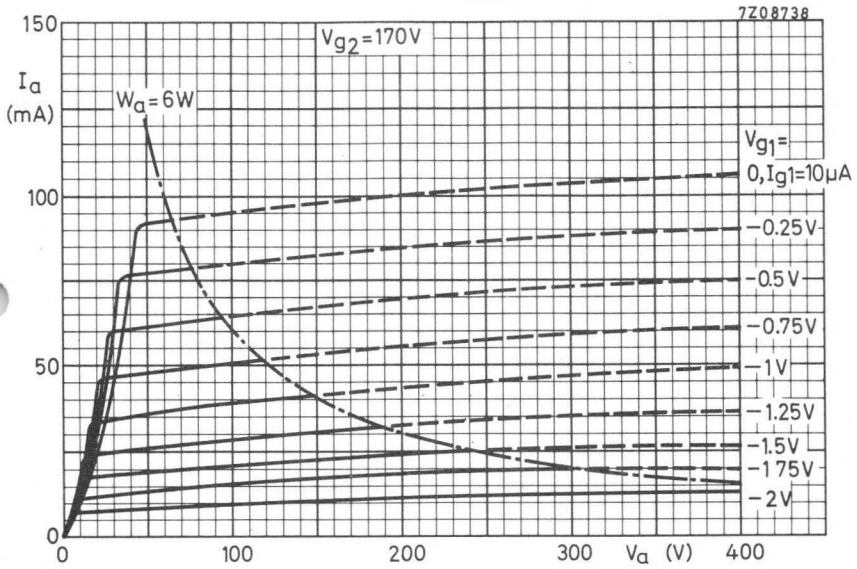

fig. 2

1) Without by-pass capacitor.

7Z08736





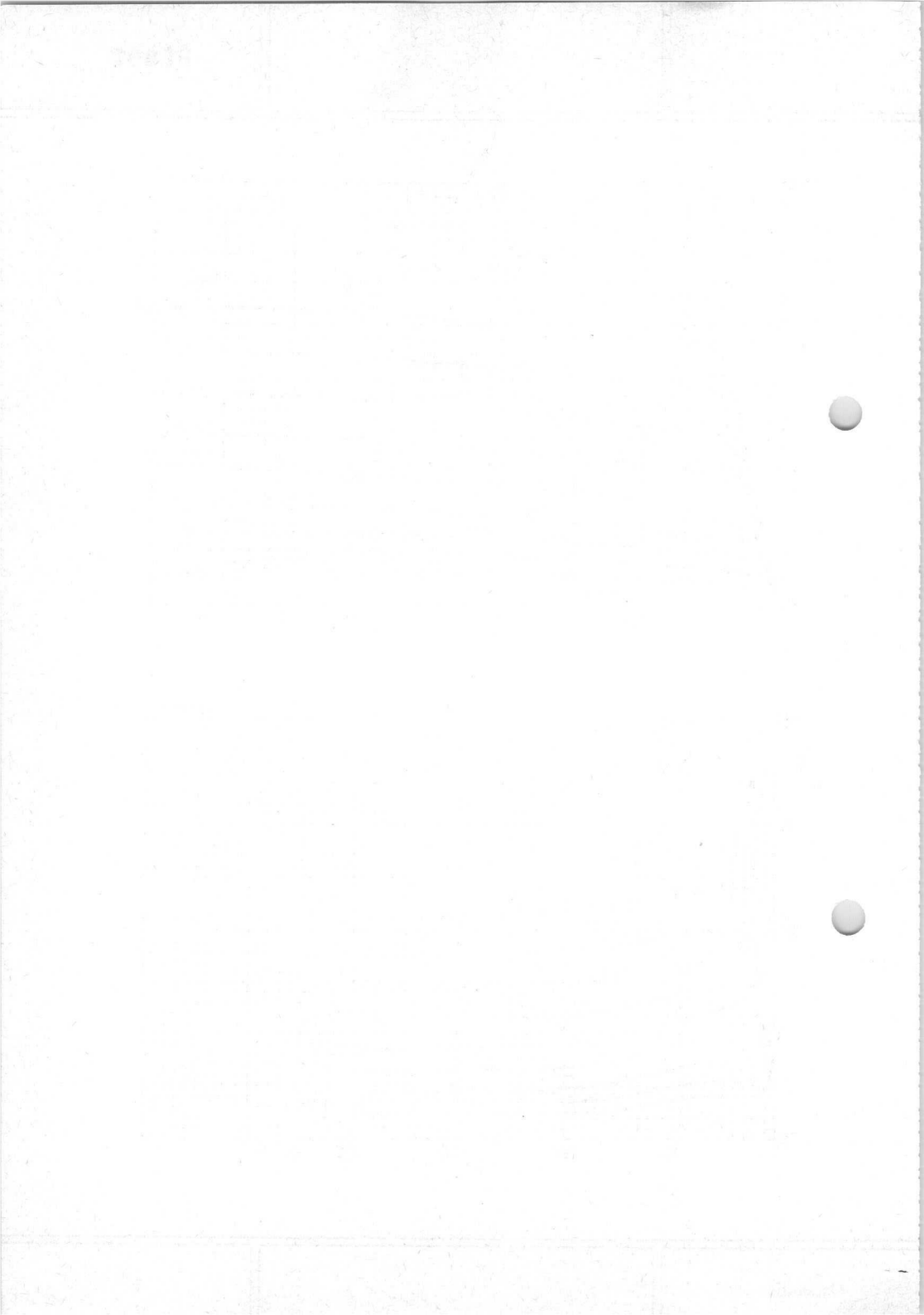

BOOSTER DIODE

Booster diode intended for use in line time-base circuits of transformerless television receivers.

QUICK REFERENCE DATA

Anode current, peak	I_{ap}	max.	450 mA
Anode voltage, peak	V_{ap}	max.	5000 V
Cathode to heater voltage, peak	V_{kf_p}	max.	5000 V

HEATING: Indirect by A. C. or D. C.; series supply

Heater current

I_f 300 mA

Heater voltage

V_f 17 V

DIMENSIONS AND CONNECTIONS

Dimensions in mm

Base: Noval

Top cap: Type 1

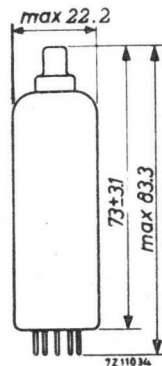
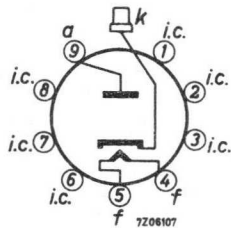

CAPACITANCES

Anode to all

C_a 6.4 pF

Cathode to heater

C_{kf} 2.8 pF

LIMITING VALUES (Design centre rating system, unless otherwise specified)

Supply voltage	V_{b0}	max.	550 V
	V_b	max.	250 V
Anode dissipation	W_a	max.	3.5 W
Anode current, average	I_a	max.	150 mA
peak	I_{ap}	max.	450 mA
Anode voltage, peak	V_{ap}	max.	5000 V ¹⁾²⁾
Absolute max.	V_{ap}	max.	5600 V ¹⁾²⁾
Cathode to heater voltage, peak	V_{kfp}	max.	5000 V ¹⁾
Series resistance heater chain	R_s	min.	80 Ω ³⁾
Heater to earth voltage	$V_{f/earth}$	max.	220 V _{RMS}

REMARK

In general it will be necessary to take measures in order to prevent the maximum permissible screen grid dissipation of the tube that derive their anode voltage from this booster grid, from being exceeded during the heating-up time of the booster diode.

¹⁾ Max. pulse duration 22% of a cycle with a maximum of 18 μ sec.

²⁾ Cathode positive with respect to the anode.

³⁾ R_s = minimum resistance of the heater chain between any heater pin and any mains terminal under working conditions (the heater of another tube can be used for this resistance).

7Z06108 - 16.25 ha

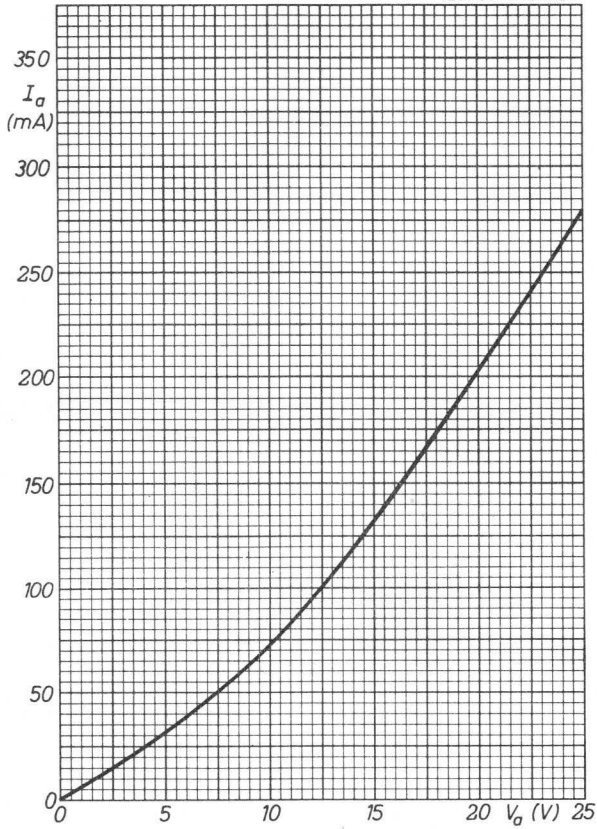

SINGLE ANODE RECTIFYING TUBE

Single anode high vacuum rectifying tube.

QUICK REFERENCE DATA			
Transformer voltage	V_{tr}	250	V_{RMS}
D.C. current	I_o	180	mA

HEATING: Indirect by A.C. or D.C.; series supply

Heater current	I_f	300	mA
Heater voltage	V_f	19	V

DIMENSIONS AND CONNECTIONS

Base: Noval

Dimensions in mm

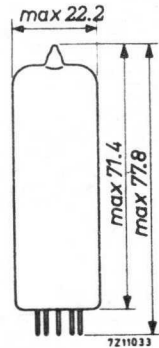
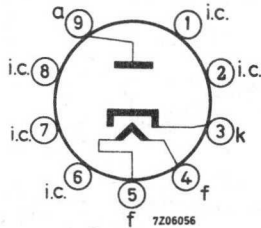

OPERATING CHARACTERISTICS as single-phase half-wave rectifier

Transformer voltage	V_{tr}	250	240	220	200	127	V_{RMS}
D.C. output voltage	V_o	195	195	195	195	127	V
D.C. current	I_o	180	180	180	180	180	mA
Protecting resistance	R_t	125	105	65	30	0	Ω
Input capacitance of smoothing filter	C_{filt}	60	60	60	60	60	μF

LIMITING VALUES (Design centre rating system)

Transformer voltage	V_{tr}	max.	250	V_{RMS}			
Anode voltage, peak inverse	V_{ainvp}	max.	700	V			
D.C. current	I_o	max.	180	mA			
Cathode to heater voltage, peak	V_{kf_p}	max.	550	V ¹⁾			
Input capacitance of smoothing filter	C_{filt}	max.	60	μF ²⁾			
Protecting resistance at transformer voltage	R_t min.	100	80	40	30	0	Ω
	V_{tr}	250	240	220	200	127	V

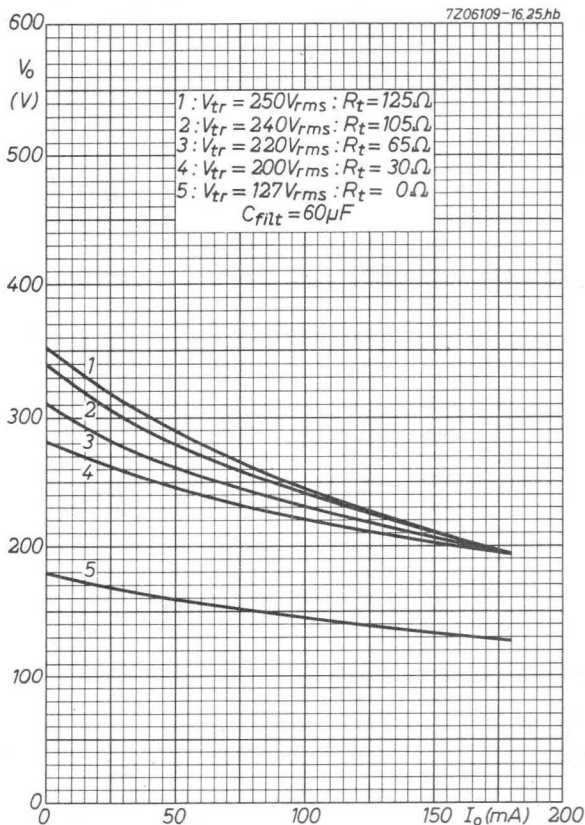

- 1) Max. 220 V_{RMS} A.C. voltage + max. 250 $V_{D.C.}$ voltage.
Cathode positive with respect to the heater.
- 2) When two tubes are placed in parallel, $C_{filt} = \text{max. } 100 \mu F$.
The resistor R_t must be inserted in the anode lead of each tube.

BOOSTER DIODE

Booster diode intended for use in line time-base circuits of transformerless television receivers.

QUICK REFERENCE DATA		
Anode current, peak	I_{ap}	max. 550 mA
Anode voltage, negative peak	$-V_{ap}$	max. 6000 V
Cathode to heater voltage, peak	V_{kf_p}	max. 6600 V

HEATING: Indirect by A.C. or D.C.; series supply

Heater current	I_f	300 mA
Heater voltage	V_f	30 V

DIMENSIONS AND CONNECTIONS

Dimensions in.mm

Base: Noval
Top cap: Type 1

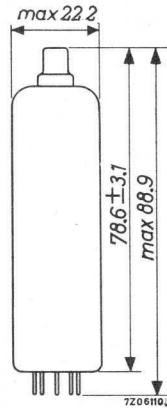
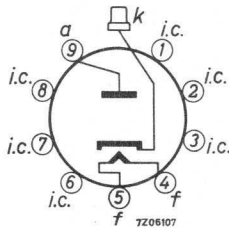

CAPACITANCES

Anode to all	C_a	8.6 pF
Cathode to heater	C_{kf}	2.7 pF

LIMITING VALUES (Design centre rating system unless otherwise specified)

Supply voltage	V_{b0}	max. 550 V
	V_b	max. 250 V
Anode dissipation	W_a	max. 5 W
Anode current, average	I_a	max. 220 mA
peak	I_{ap}	max. 550 mA
Anode voltage, negative peak	$-V_{ap}$	max. 6000 V ¹⁾
negative peak (absolute max.)	$-V_{ap}$	max. 7500 V ¹⁾
Cathode to heater voltage, peak	V_{kfP}	max. 6600 V ¹⁾
Heater to earth voltage	$V_{f/earth}$	max. 220 V _{RMS}

Series resistance heater chain

During operation, the external resistance between either heater pin of the PY88 and either mains terminal should be at least 80 Ω when $V_{f/earth} = 220 V_{RMS}$
 40 Ω when $V_{f/earth} = 110 V_{RMS}$

The hot heater resistances of other tubes in the heater chain can serve for this purpose.

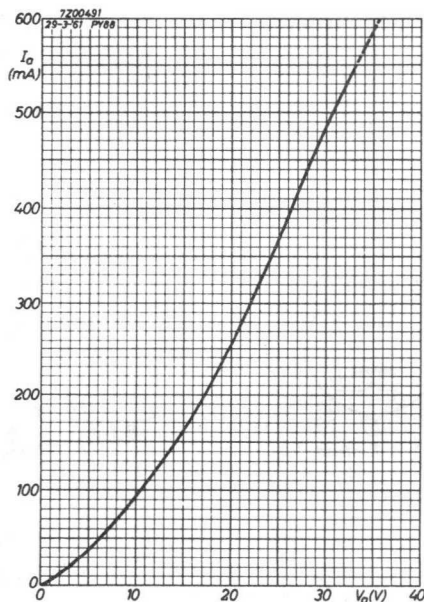

¹⁾ Max. pulse duration 22% of a cycle but maximum 18 μs.

BOOSTER DIODE

Booster diode for timebase circuits of colour TV receivers.

HEATING: Indirect by A.C. or D.C.; series supply

Heater current

I_f 300 mA

Heater voltage

V_f 42 V

MECHANICAL DATA

Dimensions in mm

Base: Magnoval

Cap: Type 1

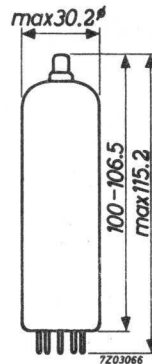
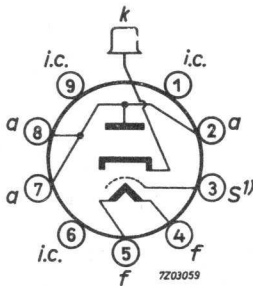

CAPACITANCES

Anode to cathode

C_{ak} 13 pF

Cathode to heater

C_{kf} 3.7 pF

¹⁾ Insertion of a resistor of 300 Ω between pins 3 and 5 is recommended to improve the high-tension properties of the tube. If no resistor is used, pins 3 and 4 should be interconnected.

TYPICAL CHARACTERISTICS

Internal resistance ($I_a = 440$ mA)	R_i	45.5 Ω
---------------------------------------	-------	---------------

LIMITING VALUES (Design centre rating system)

Anode dissipation	W_a	max. 11 W
Anode current, average	I_a	max. 440 mA
peak	I_{a_p}	max. 800 mA
Anode voltage, negative peak	$-V_{a_p}$	max. 5600 V ¹⁾
negative peak,(absolute max.)	$-V_{a_p}$	max. 7000 V ¹⁾
Cathode to heater voltage, peak	V_{kfp}	max. 6300 V ¹⁾

Series resistance heater chain

During operation, the external resistance between either heater pin of the PY500 and either mains terminal should be at least 100 Ω when $V_f/\text{earth} = 220$ V_{RMS}
50 Ω when $V_f/\text{earth} = 110$ V_{RMS}

The hot heater resistances of other tubes in the heater chain can serve for this purpose.

¹⁾ Max. pulse duration 22% of a cycle, but max. 18 μ s.

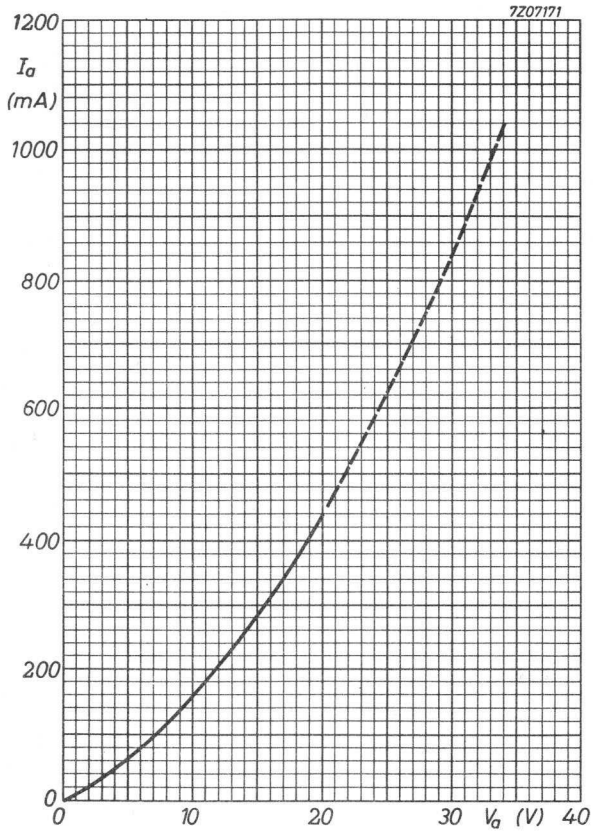

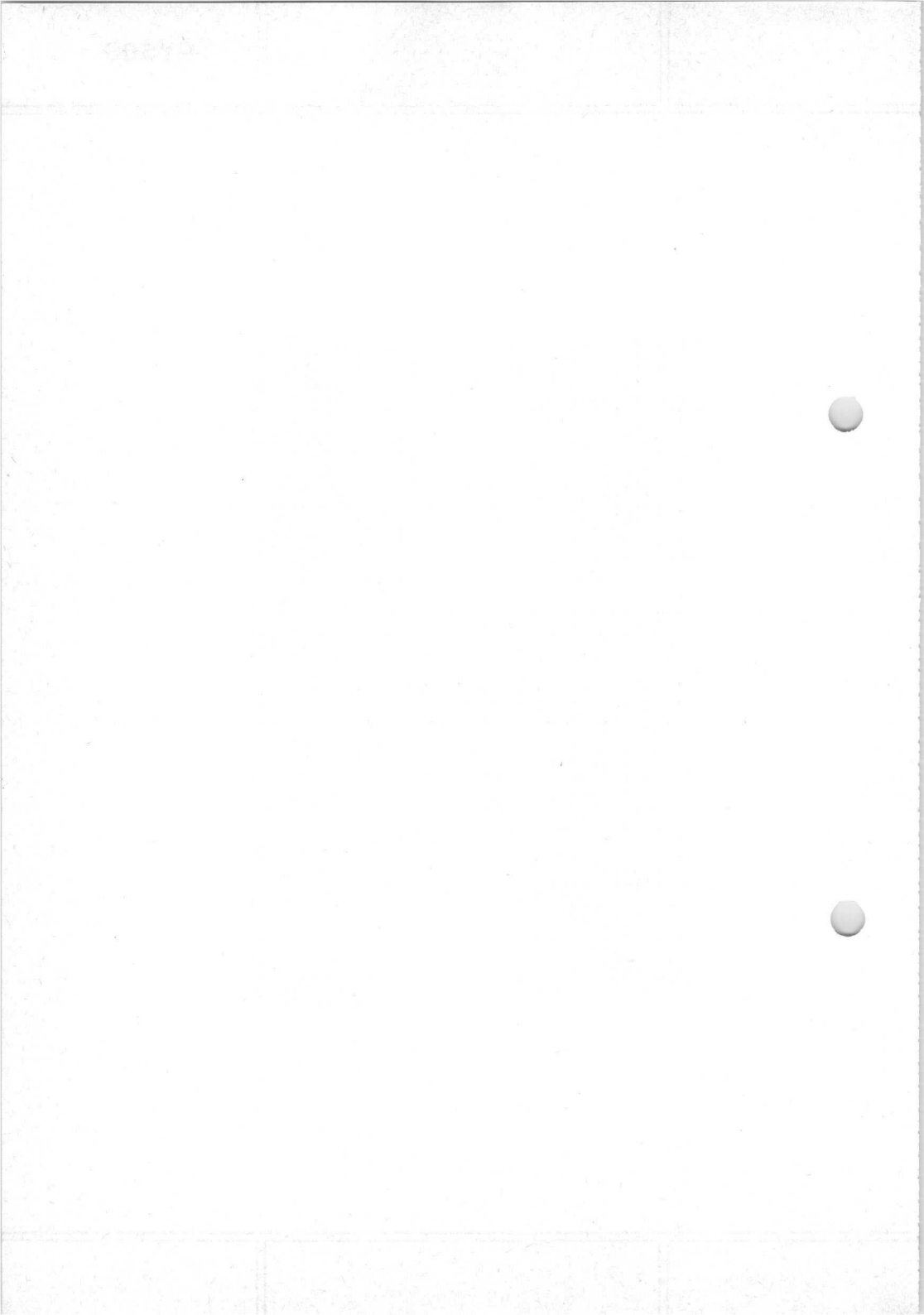

BOOSTER DIODE

Booster diode for timebase circuits of colour television receivers. The PY500A is unilaterally interchangeable with the PY500 in existing circuits. In new equipment designs the 300 Ω protection resistance between pins 3 and 5 can be deleted for the PY500A.

HEATING: Indirect by A. C. or D. C.; series supply

Heater current

I_f 300 mA

Heater voltage

V_f 42 V

MECHANICAL DATA

Base: Magnoval

Cap: Type 1

Dimensions in mm

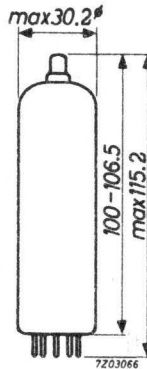
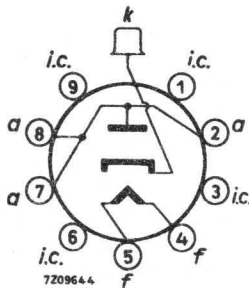

CAPACITANCES

Anode to cathode

C_{ak} 12.5 pF

Cathode to heater

C_{kf} 3.1 pF ←

TYPICAL CHARACTERISTICS

Internal resistance ($I_a = 440 \text{ mA}$) R_i 45.5 Ω

LIMITING VALUES (Design centre rating system)

Anode dissipation	W_a	max. 11 W
Anode current, average	I_a	max. 440 mA
peak	I_{a_p}	max. 1000 mA
Anode voltage, negative peak	$-V_{a_p}$	max. 5600 V ¹⁾
negative peak (absolute max.)	$-V_{a_p}$	max. 7000 V ¹⁾
Cathode to heater voltage, peak	V_{kfp}	max. 6300 V ¹⁾

Series resistance heater chain

During operation, the external resistance between either heater pin of the PY500A and either mains terminal should be at least 100 Ω when $V_f/\text{earth} = 220 V_{RMS}$
 50 Ω when $V_f/\text{earth} = 110 V_{RMS}$

The hot heater resistances of other tubes in the heater chain can serve for this purpose.

¹⁾ Max. pulse duration 22% of a cycle, but max. 18 μs .

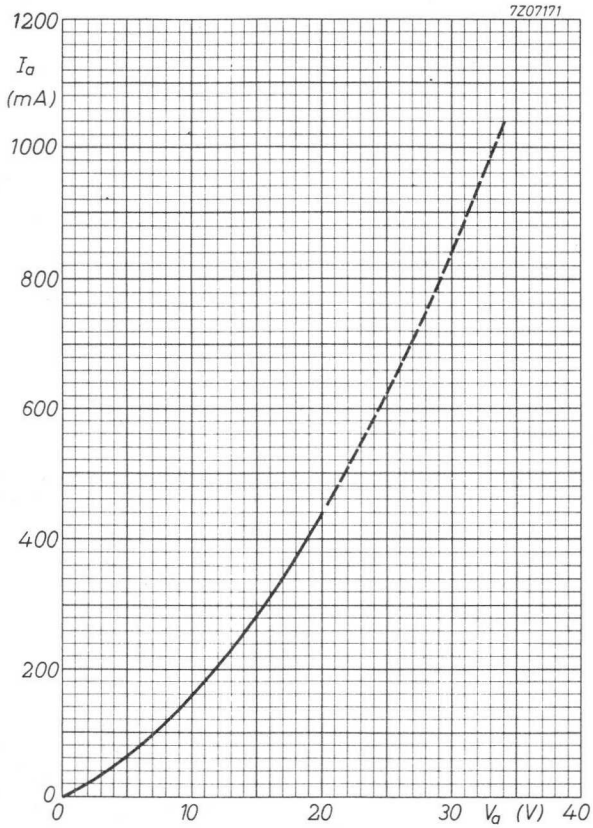



TRIPLE DIODE-TRIODE

Triple diode-triode intended for F.M. and A.M. signal detection and A.F. signal amplification.

QUICK REFERENCE DATA

Triode section	
Anode current	I_a 1.0 mA
Transconductance	S 1.45 mA/V
Amplification factor	μ 70 -

HEATING: Indirect by A.C. or D.C.; series supply

Heater current	I_f 100 mA
Heater voltage	V_f 28 V

DIMENSIONS AND CONNECTIONS

Dimensions in mm

Base: Noval

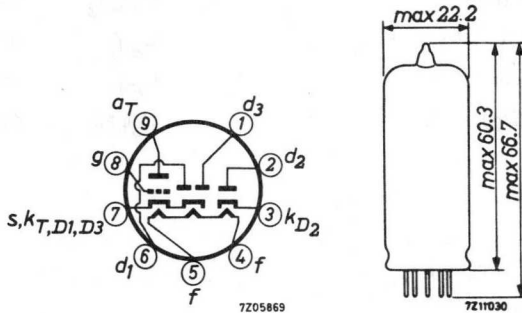

It is recommended to connect pin 5 to earth.

CAPACITANCES

Triode section

Grid to all except anode	$C_{g(a)}$	1.9 pF
Anode to all except grid	$C_{a(g)}$	1.4 pF
Anode to grid	C_{ag}	2.0 pF
Grid to heater	C_{gf}	max. 0.04 pF

Diode sections

Diode No. 1 to all	C_{d1}	0.8 pF
Diode No. 2 to all	C_{d2}	4.8 pF
Diode No. 3 to all	C_{d3}	4.8 pF
Cathode (D_2) to all	C_{kD_2}	5.0 pF
Diode No. 1 to heater	C_{d1f}	max. 0.25 pF
Diode No. 3 to heater	C_{d3f}	max. 0.2 pF
Cathode (D_2) to heater	C_{kD_2f}	2.5 pF

Between triode and diode sections

Anode to diode No. 1	C_{ad1}	max. 0.12 pF
Anode to diode No. 3	C_{ad3}	max. 0.1 pF
Anode to cathode (D_2)	C_{akD_2}	max. 0.01 pF
Grid to diode No. 1	C_{gd1}	max. 0.07 pF
Grid to diode No. 3	C_{gd3}	max. 0.02 pF
Grid to cathode (D_2)	C_{gkD_2}	max. 0.005 pF

TYPICAL CHARACTERISTICS

Triode section

Anode voltage	V_a	100	170	200	V
Grid voltage	V_g	-1	-1.85	-2.3	V
Anode current	I_a	0.8	1.0	1.0	mA
Transconductance	S	1.45	1.45	1.40	mA/V
Amplification factor	μ	70	70	70	-
Internal resistance	R_i	48	48	50	k Ω

OPERATING CHARACTERISTICS

Triode section as R.C. coupled A.F. amplifier

Grid resistor $R_g = 10 \text{ M}\Omega$

Supply voltage	V_b	200	200	200	170	170	170	V
Anode resistor	R_a	220	100	47	220	100	47	k Ω
Grid resistor next stage	R_g'	0.68	0.33	0.15	0.68	0.33	0.15	M Ω
Anode current	I_a	0.56	1.00	1.60	0.46	0.82	1.25	mA
Voltage gain	V_o/V_i	53	44	34	51	42	32	-
Distortion:								
at output voltage $V_o = 3 \text{ V}_{\text{RMS}}$	d_{tot}	0.3	0.4	0.5	0.4	0.5	0.6	%
at output voltage $V_o = 5 \text{ V}_{\text{RMS}}$	d_{tot}	0.4	0.6	0.9	0.5	0.8	1.1	%
at output voltage $V_o = 8 \text{ V}_{\text{RMS}}$	d_{tot}	0.9	1.0	1.5	1.1	1.3	2.0	%

Supply voltage	V_b	100	100	100	V
Anode resistor	R_a	220	100	47	k Ω
Grid resistor next stage	R_g'	0.68	0.33	0.15	M Ω
Anode current	I_a	0.21	0.35	0.52	mA
Voltage gain	V_o/V_i	44	35	26	-
Distortion:					
at output voltage $V_o = 3 \text{ V}_{\text{RMS}}$	d_{tot}	1.0	1.3	2.0	%
at output voltage $V_o = 5 \text{ V}_{\text{RMS}}$	d_{tot}	1.7	2.3	4.3	%

TYPICAL CHARACTERISTICS

Diode section

Internal resistance diode No.1
at diode voltage $V_{d1} = +10$ V

$$R_i D_1 = 5 \text{ k}\Omega$$

Internal resistance diode No.2
at diode voltage $V_{d2} = +5$ V

$$R_i D_2 = 200 \Omega$$

Internal resistance diode No.3
at diode voltage $V_{d3} = +5$ V

$$R_i D_3 = 200 \Omega$$

Ratio between $R_i (D_2)$ and $R_i (D_3)$

$$\begin{aligned} &\text{min. } 0.67 \\ &\text{max. } 1.5 \end{aligned}$$

Microphony

Triode section

No special precautions against microphony are required in circuits where the input voltage is min. 10 mV for 50 mW output of the output tube at frequencies higher than 800 Hz.

At lower frequencies the sensitivity may be increased according to the figure below.

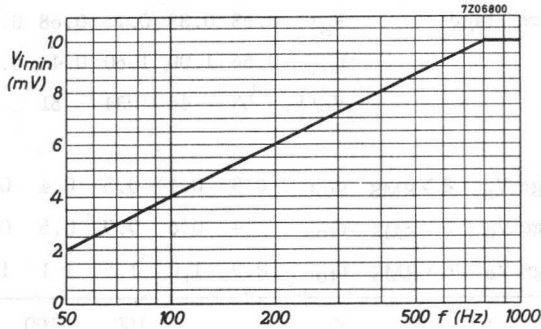

LIMITING VALUES (Design centre rating system)

Triode section

Anode voltage	V_{a0}	max. 550 V
	V_a	max. 250 V
Anode dissipation	W_a	max. 1 W
Cathode current	I_k	max. 5 mA
Grid resistor	R_g	max. 3 M Ω
Grid resistor at grid current bias	R_{g}	max. 22 M Ω
Cathode to heater voltage	V_{kf}	max. 150 V ¹⁾

Diode sections

Diode No.1 voltage, negative peak	$-V_{d1p}$	max. 350 V
Diode No.2 voltage, negative peak	$-V_{d2p}$	max. 350 V
Diode No.3 voltage, negative peak	$-V_{d3p}$	max. 350 V
Diode No.1 current:		
D.C. component	I_{d1}	max. 1 mA
peak	I_{d1p}	max. 6 mA
Diode No.2 current:		
D.C. component	I_{d2}	max. 10 mA
peak	I_{d2p}	max. 75 mA
Diode No.3 current:		
D.C. component	I_{d3}	max. 10 mA
peak	I_{d3p}	max. 75 mA

¹⁾ With regard to hum a max. AC heater to cathode voltage of 30 V_{RMS} is recommended.

[Faint, illegible text, likely bleed-through from the reverse side of the page]



DOUBLE DIODE-TRIODE

Double diode-triode. Triode intended for use as A.F. amplifier.

QUICK REFERENCE DATA		
<u>Triode section</u>		
Anode current	I_a	1.5 mA
Transconductance	S	1.65 mA/V
Amplification factor	μ	70 -

HEATING: Indirect by A.C. or D.C.; series supply

Heater current

I_f 100 mA

Heater voltage

V_f 14 V

DIMENSIONS AND CONNECTIONS

Dimensions in mm

Base: Noval

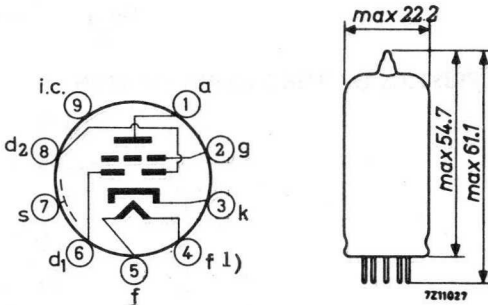

1) Earthed side of the heater circuit.

CAPACITANCES

Triode section

Grid to all except anode	$C_{g(a)}$	2.3 pF
Anode to all except grid	$C_{a(g)}$	2.3 pF
Anode to grid	C_{ag}	1.2 pF
Grid to heater	C_{gf}	max. 0.05 pF

Diode sections

Diode No.1 to all	C_{d_1}	0.9 pF
Diode No.2 to all	C_{d_2}	0.9 pF
Diode No.1 to diode No.2	$C_{d_1d_2}$	max. 0.2 pF
Diode No.1 to heater	C_{d_1f}	max. 0.25 pF
Diode No.2 to heater	C_{d_2f}	max. 0.05 pF

Between triode and diode sections

Diode No.1 to grid	C_{d_1g}	max. 0.007 pF
Diode No.2 to grid	C_{d_2g}	max. 0.007 pF
Diode No.1 to anode	C_{d_1a}	max. 0.005 pF
Diode No.2 to anode	C_{d_2a}	max. 0.01 pF

TYPICAL CHARACTERISTICS OF THE TRIODE SECTION

Anode voltage	V_a	170	100 V
Grid voltage	V_g	-1.55	-1.0 V
Anode current	I_a	1.5	0.8 mA
Transconductance	S	1.65	1.4 mA/V
Amplification factor	μ	70	70 -
Internal resistance	R_i	42	50 k Ω

OPERATING CHARACTERISTICS

Triode section as A.F. amplifier, circuit Fig. 1

Supply voltage	V_b	170	100	170	100	V
Anode resistor	R_a	0.22	0.22	0.1	0.1	$M\Omega$
Cathode resistor	R_k	5.6	5.6	3.9	3.9	$k\Omega$
Grid resistor	R_g	1.0	1.0	1.0	1.0	$M\Omega$
Grid resistor next stage	$R_{g'}$	0.68	0.68	0.33	0.33	$M\Omega$
Anode current	I_a	0.28	0.18	0.45	0.28	mA
Voltage gain	V_o/V_i	44	41	37	34	
Distortion at:						
output voltage $V_o = 3 V_{RMS}$	d_t	1.1	1.4	1.1	2.0	%
output voltage $V_o = 5 V_{RMS}$	d_t	1.3	1.9	1.7	3.5	%
output voltage $V_o = 8 V_{RMS}$	d_t	1.85	-	2.6	-	%
Supply voltage	V_b	170	100	170	100	V
Anode resistor	R_a	0.22	0.22	0.1	0.1	$M\Omega$
Cathode resistor	R_k	0	0	0	0	Ω
Grid resistor	R_g	22	22	22	22	$M\Omega$
Grid resistor next stage	$R_{g'}$	0.68	0.68	0.33	0.33	$M\Omega$
Anode current	I_a	0.46	0.21	0.82	0.35	mA
Voltage gain	V_o/V_i	48	41	42	35	
Distortion at						
output voltage $V_o = 3 V_{RMS}$	d_t	0.95	1.45	0.75	1.6	%
output voltage $V_o = 5 V_{RMS}$	d_t	1.1	2.0	1.0	2.8	%
output voltage $V_o = 8 V_{RMS}$	d_t	1.3	-	1.2	-	%

OPERATING CHARACTERISTICS (continued)

Microphony

No special precautions against microphony are required in circuits where the input voltage is min. 10 mV for 50 mW output of the output tube.

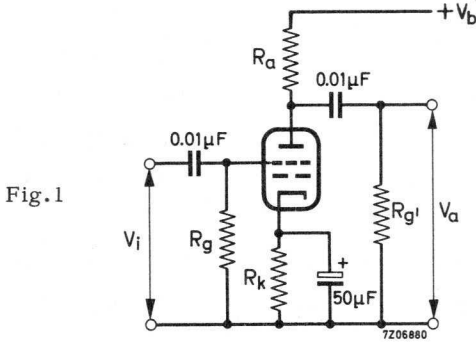

Fig. 1

LIMITING VALUES (Design centre rating system)

Triode section

Anode voltage	V_{a0}	max.	550 V
	V_a	max.	250 V
Anode dissipation	W_a	max.	0.5 W
Cathode current	I_k	max.	5 mA
Grid resistor	R_g	max.	3 MΩ
Cathode to heater voltage	V_{kf}	max.	100 V

Diode sections (each diode)

Diode voltage, negative peak	$-V_{dp}$	max.	350 V
Diode current:			
average	I_d	max.	0.8 mA
peak	I_{dp}	max.	5 mA
Cathode to heater voltage	V_{kf}	max.	100 V

DOUBLE DIODE-PENTODE

Double diode-pentode. Pentode intended for use as R.F. or I.F. amplifier.

QUICK REFERENCE DATA

Pentode section

Variable transconductance

Anode current	I_a	11 mA
Transconductance	S	4.5 mA/V
Amplification factor	$\mu_{g_2g_1}$	20 -

HEATING: Indirect by A.C. or D.C.; series supply

Heater current	I_f	100 mA
Heater voltage	V_f	19 V

DIMENSIONS AND CONNECTIONS

Dimensions in mm

Base: Noval

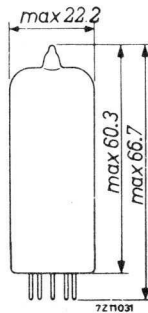
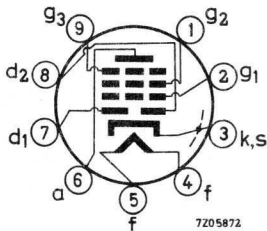

CAPACITANCESPentode section

Anode to all except grid No.1	$C_{a(g_1)}$	5.2	pF
Grid No.1 to all except anode	$C_{g_1(a)}$	5.0	pF
Anode to grid No.1	C_{ag_1}	max. 0.0025	pF
Grid No.1 to heater	C_{g_1f}	max. 0.05	pF

Diode sections

Diode No.1 to all	C_{d_1}	2.5	pF
Diode No.2 to all	C_{d_2}	2.5	pF
Diode No.1 to diode No.2	$C_{d_1d_2}$	max. 0.25	pF
Diode No.1 to heater	C_{d_1f}	max. 0.015	pF
Diode No.2 to heater	C_{d_2f}	max. 0.003	pF

Between pentode and diode sections

Diode No.1 to grid No.1	$C_{d_1g_1}$	max. 0.0008	pF
Diode No.2 to grid No.1	$C_{d_2g_1}$	max. 0.001	pF
Diode No.1 to anode	C_{d_1a}	max. 0.15	pF
Diode No.2 to anode	C_{d_2a}	max. 0.025	pF

TYPICAL CHARACTERISTICS

Pentode section

Anode voltage	V_a	200	170	100	V
Grid No.2 voltage	V_{g2}	100	100	100	V
Grid No.3 voltage	V_{g3}	0	0	0	V
Grid No.1 voltage	V_{g1}	-1.5	-1 ¹⁾	-2	V
Anode current	I_a	11	12	8.5	mA
Grid No.2 current	I_{g2}	3.3	4	2.8	mA
Transconductance	S	4.5	5	3.5	mA/V
Amplification factor	μ_{g2g1}	20	20	20	-
Internal resistance	R_i	0.6	0.4	0.3	M Ω

OPERATING CHARACTERISTICS

Pentode section as R.F. or I.F. amplifier

Supply voltage	V_b	200	100	V		
Anode resistor	R_a	0	0	Ω		
Grid No.3 voltage	V_{g3}	0	0	V		
Grid No.2 resistor	R_{g2}	30	0	k Ω		
Grid No.1 voltage	V_{g1}	-1.5	-20	-2	-10	V
Anode current	I_a	11	-	8.5	-	mA
Grid No.2 current	I_{g2}	3.3	-	2.8	-	mA
Transconductance	S	4.5	0.12	3.5	0.11	mA/V
Internal resistance	R_i	0.6	-	0.3	-	M Ω

1) To avoid grid No.1 current the negative grid No.1 voltage should be min. 1.5 V

LIMITING VALUES (Design centre rating system)

Pentode section

Anode voltage	V_{a0}	max.	550	V
	V_a	max.	250	V
Anode dissipation	W_a	max.	2.25	W
Grid No.2 voltage	V_{g20}	max.	550	V
Grid No.2 voltage				
at anode current I_a max. 4 mA	V_{g2}	max.	250	V
at anode current I_a min. 8 mA	V_{g2}	max.	125	V
Grid No.2 dissipation	W_{g2}	max.	0.45	W
Cathode current	I_k	max.	16.5	mA
Grid No.1 resistor	R_{g1}	max.	3	M Ω
Grid No.3 resistor	R_{g3}	max.	10	k Ω
Cathode to heater voltage	V_{kf}	max.	100	V

Diode sections (each diode)

Diode voltage, negative peak	$-V_{dp}$	max.	200	V
Diode current; average	I_d	max.	0.8	mA
peak	I_{dp}	max.	5	mA
Cathode to heater voltage	V_{kf}	max.	100	V

R.F. DOUBLE TRIODE

Double triode intended for use as R.F. amplifier and self oscillating mixer.

QUICK REFERENCE DATA		
Anode current	I_a	10 mA
Transconductance	S	6.7 mA/V
Amplification factor	μ	48 -

HEATING: Indirect by A.C. or D.C.; series supply

Heater current	I_f	100 mA
Heater voltage	V_f	26 V

DIMENSIONS AND CONNECTIONS

Dimensions in mm

Base: Noval

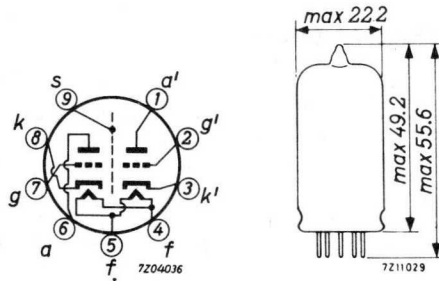

CAPACITANCES (each unit unless otherwise specified)

Anode to grid	C_{ag}	1.5	pF
Anode to cathode	C_{ak}	0.18	pF
Anode to cathode + heater + screen	$C_{a/kfs}$	1.2	pF
Grid to cathode + heater + screen	$C_{g/kfs}$	3.1	pF
Anode to cathode + heater + screen (measured with external screen of 22.5 mm diam.)	$C_{a/kfs}$	1.8	pF
Anode to anode other unit	$C_{aa'}$	max. 0.04	pF
Anode to anode other unit (measured with external screen of 22.5 mm diam.)	$C_{aa'}$	max. 0.008	pF
Grid to grid other unit	$C_{gg'}$	max. 0.003	pF
Anode to grid other unit	$C_{ag'}$	max. 0.008	pF
Anode to grid other unit	$C_{a'g}$	max. 0.008	pF
Anode to cathode other unit	$C_{ak'}$	max. 0.008	pF
Grid to cathode other unit	$C_{gk'}$	max. 0.003	pF
Anode to cathode other unit	$C_{a'k}$	max. 0.008	pF
Grid to cathode other unit	$C_{g'k}$	max. 0.003	pF

TYPICAL CHARACTERISTICS (each unit)

Anode voltage	V_a	100	170	200	V
Grid voltage	V_g	-1.2 ¹⁾	-1.75	-2.4	V
Anode current	I_a	4.5	10	10	mA
Transconductance	S	4.8	6.7	6	mA/V
Amplification factor	μ	46	48	46	-

¹⁾ In this case grid current may occur. If this is not permissible, a condition with a bias of -1.5 V should be chosen.

OPERATING CHARACTERISTICS

As R.F. amplifier (unit a, g, k)

Supply voltage	V_b	170	170	100	V
Anode resistor	R_a	1.3	1.5	1.5	$k\Omega$
Anode voltage	V_a	161	155	91	V
Cathode resistor	R_k	330	150	138	Ω
Grid voltage	V_g	-2.2	-1.5	-0.8	V
Anode current	I_a	6.6	9.8	5.7	mA
Transconductance	S	5.1	6.7	5.9	mA/V
Internal resistance	R_i	8.5	7	8	$k\Omega$
Grid input resistance (f = 100 MHz)	r_g	5.2	3.8	2.8	$k\Omega$
Equivalent noise resistance	R_{eq}	0.82	0.55	0.61	$k\Omega$

As self oscillating additive mixer (each unit)

Anode supply voltage	V_b	100	170	200	V
Anode resistor	R_a	4.7	4.7	8.2	$k\Omega$
Grid resistor	R_g	1	1	1	$M\Omega$
Oscillator voltage	$V_{osc.}$	1.8	2.8	2.8	V_{RMS}
Anode current	I_a	2.7	5.5	6	mA
Conversion conductance	S_c	2.2	2.8	2.9	mA/V
Internal resistance	R_i	19	15	14	$k\Omega$
Grid input resistance (f = 100 MHz)	r_g		15		$k\Omega$

LIMITING VALUES (each unit) (Design centre rating system)

Anode voltage	V_{a0}	max.	550	V
	V_a	max.	250	V
Anode dissipation	W_a	max.	2.5	W
Anode dissipation, total	W_a+W_a'	max.	4.5	W
Cathode current	I_k	max.	15	mA
Cathode to heater voltage	V_{kf}	max.	90	V
Grid voltage (negative)	$-V_g$	max.	100	V
Grid resistor	R_g	max.	1	$M\Omega$

For curves please refer to type PCC85

OPERATING CHARGES

As of 12/31/50

1. Telephone
 2. Postage
 3. Printing
 4. Reproduction
 5. Travel
 6. Entertainment
 7. Office supplies
 8. Maintenance
 9. Insurance
 10. Security
 11. Utilities
 12. Rent
 13. Depreciation
 14. Amortization
 15. Other

1. Telephone
 2. Postage
 3. Printing
 4. Reproduction
 5. Travel
 6. Entertainment
 7. Office supplies
 8. Maintenance
 9. Insurance
 10. Security
 11. Utilities
 12. Rent
 13. Depreciation
 14. Amortization
 15. Other

1. Telephone
 2. Postage
 3. Printing
 4. Reproduction
 5. Travel
 6. Entertainment
 7. Office supplies
 8. Maintenance
 9. Insurance
 10. Security
 11. Utilities
 12. Rent
 13. Depreciation
 14. Amortization
 15. Other

1. Telephone
 2. Postage
 3. Printing
 4. Reproduction
 5. Travel
 6. Entertainment
 7. Office supplies
 8. Maintenance
 9. Insurance
 10. Security
 11. Utilities
 12. Rent
 13. Depreciation
 14. Amortization
 15. Other

For current period - see page 10

TRIODE-HEPTODE

Triode-heptode. Heptode section intended for use as mixer R.F. - or I.F. amplifier. Triode section intended for use as oscillator in A.M./F.M. receivers.

QUICK REFERENCE DATA

Triode section

Anode current	I_a	13.5 mA
Transconductance	S	3.7 mA/V
Amplification factor	μ	22 -

Heptode section

Anode current	I_a	9.8 mA
Transconductance	S	4.3 mA/V
Amplification factor	$\mu_{g_2g_1}$	25 -

HEATING: Indirect by A.C. or D.C.; series supply

Heater current	I_f	100 mA
Heater voltage	V_f	19 V

DIMENSIONS AND CONNECTIONS

Dimensions in mm

Base: Noval

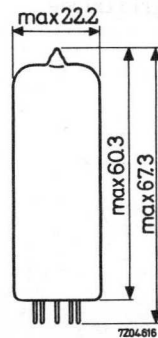
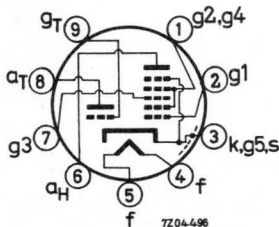

CAPACITANCES

Triode section

Grid to all except anode	$C_{g(a)}$	2.6 pF
Anode to all except grid	$C_{a(g)}$	2.1 pF
Anode to grid	C_{ag}	1.0 pF
Grid to heater	C_{gf}	max. 0.02 pF

Heptode section

Grid No.1 to all except anode	$C_{g_1(a)}$	4.8 pF
Anode to all except grid No.1	$C_{a(g_1)}$	7.9 pF
Anode to grid No.1	C_{ag_1}	max. 0.006 pF
Grid No.1 to heater	C_{g_1f}	max. 0.17 pF
Grid No.3 to all	C_{g_3}	6 pF
Grid No.1 to grid No.3	$C_{g_1g_3}$	max. 0.3 pF
Grid No.3 to heater	C_{g_3f}	max. 0.06 pF

Between heptode and triode sections

Anode heptode to anode triode	C_{aHaT}	0.20 pF
Anode heptode to grid triode	C_{aHgT}	max. 0.09 pF
Grid No.1 heptode to anode triode	C_{g_1HaT}	max. 0.06 pF
Grid No.1 heptode to grid triode	C_{g_1HgT}	max. 0.17 pF
Grid No.1 heptode to grid triode + grid No.3	C_{g_1H/gTg_3}	max. 0.45 pF
Anode heptode to grid triode + grid No.3	C_{aH/gTg_3}	max. 0.35 pF

TYPICAL CHARACTERISTICS

Triode section

Anode voltage	V_a	100 V
Grid voltage	V_g	0 V
Anode current	I_a	13.5 mA
Transconductance	S	3.7 mA/V
Amplification factor	μ	22 -

Heptode section

Anode voltage	V_a	160 V
Grid No.3 voltage	V_{g_3}	0 V
Grids No.2 and 4 voltage	$V_{g_{2+4}}$	90 V
Grid No.1 current	I_{g_1}	0.5 μ A
Grid No.1 voltage	V_{g_1}	-0.5 V
Anode current	I_a	9.8 mA
Grids No.2 and 4 current	$I_{g_{2+4}}$	6.1 mA
Transconductance	S	4.3 mA/V
Amplification factor	$\mu_{g_2g_1}$	25 -

OPERATING CHARACTERISTICS

Heptode section as mixer

Supply voltage	V_b	100	170	200	V			
Anode resistor	R_a	0	0	0	Ω			
Grids No.2 and 4 resistor	$R_{g_{2+4}}$	10	10	10	$k\Omega$			
Grid triode + grid No.3 resistor	$R_{g_T+g_3}$	47	47	47	$k\Omega$			
Grid triode + grid No.3 current	$I_{g_T+g_3}$	115	200	230	μA			
Grid No.1 current	I_{g_1}	0.5	-	0.5	-	μA ¹⁾		
Grid No.1 voltage	V_{g_1}	-0.5	-12	-0.5	-19	-0.5	-22	V
Anode voltage	V_a	100	-	170	-	200	-	V
Grids No.2 and 4 voltage	$V_{g_{2+4}}$	56	-	88	-	100	-	V
Anode current	I_a	2.0	-	3.3	-	4.1	-	mA
Grids No.2 and 4 current	$I_{g_{2+4}}$	4.4	-	8.2	-	10	-	mA
Conversion conductance	S_c	850	8.5	1100	11	1200	12	$\mu A/V$
Internal resistance	R_i	0.75	min.3	0.8	min.3	0.85	min.3	$M\Omega$
Equivalent noise resistance	R_{eq}	33	-	30	-	32	-	$k\Omega$

¹⁾ Grid current bias obtained with $R_{g_1} = 1 M\Omega$ and with zero volts a.g.c. voltage; resulting grid No.1 voltage: -0.5 V.

OPERATING CHARACTERISTICS (continued)

Heptode section as R.F. or I.F. amplifier

Supply voltage	V_b	100	170	200	V			
Anode resistor	R_a	0	0	3.9	k Ω			
Grids No.2 and 4 resistor	$R_{g_{2+4}}$	18	18	18	k Ω			
Grid No.3 voltage	V_{g_3}	0	0	0	V			
Grid No.1 current	I_{g_1}	0.5	- 0.5	0.5	- μA ¹⁾			
Grid No.1 voltage	V_{g_1}	-0.5	-15.7	-0.5	-26	-0.5	-30	V
Anode voltage	V_a	100	-	170	-	162	-	V
Grids No.2 and 4 voltage	$V_{g_{2+4}}$	52	-	80	-	90	-	V
Anode current	I_a	4.1	-	8.0	-	9.8	-	mA
Grids No.2 and 4 current	$I_{g_{2+4}}$	2.7	-	5.0	-	6.1	-	mA
Transconductance	S	2900	29	3900	39	4300	43	$\mu A/V$
Internal resistance	R_i	0.45 min.10	0.4	min.10	0.35	min.10		M Ω
Amplification factor	$\mu_{g_2g_1}$	24	-	25	-	25	-	-
Equivalent noise resistance	R_{eq}	4.0	-	4.0	-	4.3	-	k Ω

Triode section as oscillator

Supply voltage	V_b	100	170	200	V
Anode resistor	R_a	15	15	15	k Ω
Grid triode + grid No.3 resistor	$R_{g_T+g_3}$	47	47	47	k Ω
Grid triode + grid No.3 current	$I_{g_T+g_3}$	115	200	230	μA
Anode current	I_a	2.5	4.5	5.4	mA
Effective transconductance	S_{eff}	0.58	0.65	0.65	mA/V

1) Grid current bias obtained with $R_{g_1} = 1 \text{ M}\Omega$ and with zero volts a.g.c. voltage; resulting grid No.1 voltage: -0.5 V.

LIMITING VALUES (Design centre rating system)

Heptode section

Anode voltage	V_{a_0}	max. 550 V
	V_a	max. 250 V
Anode dissipation	W_a	max. 1.8 W
Grids No.2 and 4 voltage	$V_{g_{2+4_0}}$	max. 550 V
	$V_{g_{2+4}}$	max. 125 V
Grids No.2 and 4 voltage (I_a max. 1 mA)	$V_{g_{2+4}}$	max. 250 V
Grids No.2 and 4 dissipation	$W_{g_{2+4}}$	max. 1 W
Cathode current	I_k	max. 18 mA
Grid No.1 resistor	R_{g_1}	max. 3 M Ω
Grid No.3 resistor	R_{g_3}	max. 20 k Ω
Grid No.3 resistor grid No.3 directly connected to grid triode	R_{g_3}	max. 3 M Ω
Cathode to heater voltage	V_{kf}	max. 100 V

Triode section

Anode voltage	V_{a_0}	max. 550 V
	V_a	max. 250 V
Anode dissipation	W_a	max. 0.8 W
Cathode current	I_k	max. 6.5 mA
Grid resistor	R_g	max. 3 M Ω
Cathode to heater voltage	V_{kf}	max. 100 V

TRIODE-OUTPUT PENTODE

The triode section is intended for use as A.F. amplifier.
 The pentode section is intended for use as A.F. power amplifier.

QUICK REFERENCE DATA			
<u>Triode section</u>			
Anode current	I_a	3.5	mA
Transconductance	S	2.2	mA/V
Amplification factor	μ	70	-
<u>Pentode section</u>			
Anode current	I_a	41	mA
Transconductance	S	7.5	mA/V
Amplification factor	$\mu_{g_2g_1}$	9.5	-
Output power	W_o	3.3	W

HEATING: Indirect by A.C. or D.C.; series supply

Heater current	I_f	100	mA
Heater voltage	V_f	50	V

DIMENSIONS AND CONNECTIONS

Base: Noval

Dimensions in mm

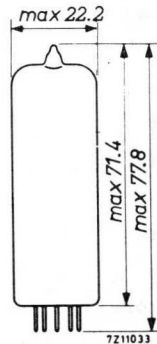
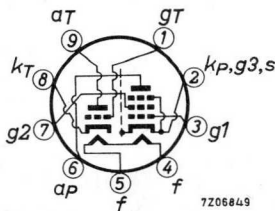

CAPACITANCESTriode section

Anode to all except grid	$C_{a(g)}$	4.3 pF
Grid to all except anode	$C_{g(a)}$	2.7 pF
Anode to grid	C_{ag}	4.4 pF
Grid to heater	C_{gf}	max. 0.02 pF

Pentode section

Anode to all except grid No. 1	$C_{a(g_1)}$	8.0 pF
Grid No. 1 to all except anode	$C_{g_1(a)}$	9.3 pF
Anode to grid No. 1	C_{ag_1}	max. 0.3 pF
Grid No. 1 to heater	C_{g_1f}	max. 0.3 pF

Between triode and pentode sections

Anode triode to grid No. 1 pentode	C_{aTg_1P}	max. 0.02 pF
Grid triode to anode pentode	C_{gTap}	max. 0.02 pF
Grid triode to grid No. 1 pentode	C_{gTg_1P}	max. 0.025 pF
Anode triode to anode pentode	C_{aTap}	max. 0.25 pF

TYPICAL CHARACTERISTICSTriode section

Anode voltage	V_a	100 V
Grid voltage	V_g	0 V
Anode current	I_a	3.5 mA
Transconductance	S	2.2 mA/V
Amplification factor	μ	70 -

Pentode section

Anode voltage	V_a	170 V
Grid No. 2 voltage	V_{g_2}	170 V
Grid No. 1 voltage	V_{g_1}	-11.5 V
Anode current	I_a	41 mA
Grid No. 2 current	I_{g_2}	9 mA
Transconductance	S	7.5 mA/V
Amplification factor	$\mu_{g_2g_1}$	9.5 -
Internal resistance	R_i	16 k Ω

OPERATING CHARACTERISTICS

Triode section as A.F. amplifier

A) Signal source resistance	R_S		0.22		$M\Omega$	
Grid resistor	R_g		3		$M\Omega$	
Grid resistor of next stage	$R_{g'}$		0.68		$M\Omega$	
Supply voltage	V_b		170	100	V	
Cathode resistor	R_k		2.7	2.7	$k\Omega$	
Anode resistor	R_a		220	220	$k\Omega$	
Anode current	I_a		0.43	0.23	mA	
Voltage gain	V_o/V_i ¹⁾		51	47	-	
Max. output voltage	$V_{o\max}$		25	15	V_{RMS}	
Distortion	d_{tot} ²⁾		2.3	4.0	%	
B) Signal source resistance	R_S		0.22		$M\Omega$	
Grid resistor	R_g		22		$M\Omega$	
Grid resistor of next stage	R_g		0.68		$M\Omega$	
Supply voltage	V_b	170	170	100	100	V
Cathode resistor	R_k	0	0	0	0	Ω
Anode resistor	R_a	100	220	100	220	$k\Omega$
Anode current	I_a	0.86	0.50	0.37	0.22	mA
Voltage gain	V_o/V_i ¹⁾	49	53	42	46	-
Max. output voltage	$V_{o\max}$	19	20	8	9	V_{RMS}
Distortion	d_{tot}	1.4 ³⁾	1.4 ³⁾	1.3 ²⁾	1.5 ²⁾	%

Microphony and hum

The triode section can be used without special precautions against microphony and hum in circuits in which an input voltage of minimum 10 mV_{RMS} is required for an output of 50 mW of the output stage, Z_g ($f = 50\text{ Hz}$) = $0.25\text{ M}\Omega$ and without A.C. voltage between pin 4 and cathode.

¹⁾ Measured at small input voltage.

²⁾ At lower output voltages the distortion is proportionally lower.

³⁾ At lower output voltages down to 5 V_{RMS} the distortion is approximately constant. At values below 5 V_{RMS} the distortion is approximately proportional to V_o .

OPERATING CHARACTERISTICS

Pentode section

Class A (Measured with V_k constant)

Supply voltage	$V_{ba} = V_{bg2}$	100	170	V
Cathode resistor	R_k	170	200	Ω
Load resistance	$R_{a\sim}$	3.0	3.25	$k\Omega$
Grid No.1 driving voltage	V_i	0 0.7 3.75	0 0.61 5.9	V_{RMS}
Anode current	I_a	26 - 27	42 - 44	mA
Grid No.2 current	I_{g2}	5.8 - 8.6	9.2 - 15.5	mA
Output power	W_o	0 0.05 1.0	0 0.05 3.2	W
Distortion	d_{tot}	- - 10	- - 10	%

Supply voltage	$V_{ba} = V_{bg2}$	200	V
Grid No.2 series resistor (non-decoupled)	R_{g2}	470	Ω
Cathode resistor	R_k	330	Ω
Load resistance	$R_{a\sim}$	4.5	$k\Omega$
Grid No.1 driving voltage	V_i	0 0.66 6.7	V_{RMS}
Anode current	I_a	35 - 37	mA
Grid No.2 current	I_{g2}	7.8 - 13.3	mA
Output power	W_o	0 0.05 3.3	W
Distortion	d_{tot}	- - 10	%

LIMITING VALUES (Design centre rating system)Triode section

Anode voltage	V_{a0}	max.	550 V
	V_a	max.	250 V
Anode dissipation	W_a	max.	1 W
Cathode current	I_k	max.	15 mA
Grid resistor			
for fixed bias	R_g	max.	1 M Ω
for automatic bias	R_{g1}	max.	3 M Ω
Grid impedance at 50 Hz	Z_g	max.	0.5 M Ω
Cathode to heater voltage	V_{kf}	max.	200 V

Pentode section

Anode voltage	V_{a0}	max.	550 V
	V_a	max.	250 V
Grid No.2 voltage	V_{g20}	max.	550 V
	V_{g2}	max.	250 V
Anode dissipation	W_a	max.	7 W
Grid No.2 dissipation			
average	W_{g2}	max.	2 W
peak	W_{g2p}	max.	3.2 W
Cathode current	I_k	max.	50 mA
Grid No.1 resistor			
for fixed bias	R_{g1}	max.	1 M Ω
for automatic bias	R_{g1}	max.	2 M Ω
Cathode to heater voltage	V_{kf}	max.	200 V

LIMITING VALUES - General Service - (continued)

Cathode section	
At 100 volts	At 150 volts
Grid No. 1 voltage	0 to 100
Grid No. 2 voltage	0 to 100
Grid No. 3 voltage	0 to 100
Grid No. 4 voltage	0 to 100
Grid No. 5 voltage	0 to 100
Grid No. 6 voltage	0 to 100
Grid No. 7 voltage	0 to 100
Grid No. 8 voltage	0 to 100
Grid No. 9 voltage	0 to 100
Grid No. 10 voltage	0 to 100
Grid No. 11 voltage	0 to 100
Grid No. 12 voltage	0 to 100
Grid No. 13 voltage	0 to 100
Grid No. 14 voltage	0 to 100
Grid No. 15 voltage	0 to 100
Grid No. 16 voltage	0 to 100
Grid No. 17 voltage	0 to 100
Grid No. 18 voltage	0 to 100
Grid No. 19 voltage	0 to 100
Grid No. 20 voltage	0 to 100
Grid No. 21 voltage	0 to 100
Grid No. 22 voltage	0 to 100
Grid No. 23 voltage	0 to 100
Grid No. 24 voltage	0 to 100
Grid No. 25 voltage	0 to 100
Grid No. 26 voltage	0 to 100
Grid No. 27 voltage	0 to 100
Grid No. 28 voltage	0 to 100
Grid No. 29 voltage	0 to 100
Grid No. 30 voltage	0 to 100
Grid No. 31 voltage	0 to 100
Grid No. 32 voltage	0 to 100
Grid No. 33 voltage	0 to 100
Grid No. 34 voltage	0 to 100
Grid No. 35 voltage	0 to 100
Grid No. 36 voltage	0 to 100
Grid No. 37 voltage	0 to 100
Grid No. 38 voltage	0 to 100
Grid No. 39 voltage	0 to 100
Grid No. 40 voltage	0 to 100
Grid No. 41 voltage	0 to 100
Grid No. 42 voltage	0 to 100
Grid No. 43 voltage	0 to 100
Grid No. 44 voltage	0 to 100
Grid No. 45 voltage	0 to 100
Grid No. 46 voltage	0 to 100
Grid No. 47 voltage	0 to 100
Grid No. 48 voltage	0 to 100
Grid No. 49 voltage	0 to 100
Grid No. 50 voltage	0 to 100
Grid No. 51 voltage	0 to 100
Grid No. 52 voltage	0 to 100
Grid No. 53 voltage	0 to 100
Grid No. 54 voltage	0 to 100
Grid No. 55 voltage	0 to 100
Grid No. 56 voltage	0 to 100
Grid No. 57 voltage	0 to 100
Grid No. 58 voltage	0 to 100
Grid No. 59 voltage	0 to 100
Grid No. 60 voltage	0 to 100
Grid No. 61 voltage	0 to 100
Grid No. 62 voltage	0 to 100
Grid No. 63 voltage	0 to 100
Grid No. 64 voltage	0 to 100
Grid No. 65 voltage	0 to 100
Grid No. 66 voltage	0 to 100
Grid No. 67 voltage	0 to 100
Grid No. 68 voltage	0 to 100
Grid No. 69 voltage	0 to 100
Grid No. 70 voltage	0 to 100
Grid No. 71 voltage	0 to 100
Grid No. 72 voltage	0 to 100
Grid No. 73 voltage	0 to 100
Grid No. 74 voltage	0 to 100
Grid No. 75 voltage	0 to 100
Grid No. 76 voltage	0 to 100
Grid No. 77 voltage	0 to 100
Grid No. 78 voltage	0 to 100
Grid No. 79 voltage	0 to 100
Grid No. 80 voltage	0 to 100
Grid No. 81 voltage	0 to 100
Grid No. 82 voltage	0 to 100
Grid No. 83 voltage	0 to 100
Grid No. 84 voltage	0 to 100
Grid No. 85 voltage	0 to 100
Grid No. 86 voltage	0 to 100
Grid No. 87 voltage	0 to 100
Grid No. 88 voltage	0 to 100
Grid No. 89 voltage	0 to 100
Grid No. 90 voltage	0 to 100
Grid No. 91 voltage	0 to 100
Grid No. 92 voltage	0 to 100
Grid No. 93 voltage	0 to 100
Grid No. 94 voltage	0 to 100
Grid No. 95 voltage	0 to 100
Grid No. 96 voltage	0 to 100
Grid No. 97 voltage	0 to 100
Grid No. 98 voltage	0 to 100
Grid No. 99 voltage	0 to 100
Grid No. 100 voltage	0 to 100

R.F. PENTODE

Pentode with variable transconductance intended for use as R.F. or I.F. amplifier.

QUICK REFERENCE DATA		
Anode current	I_a	12 mA
Transconductance	S	4.4 mA/V
Amplification factor	$\mu_{g_2g_1}$	21
Internal resistance	R_i	400 k Ω

HEATING: Indirect by A.C. or D.C.; series supply

Heater current	I_f	100 mA
Heater voltage	V_f	12.6 V

DIMENSIONS AND CONNECTIONS

Dimensions in mm

Base: Noval

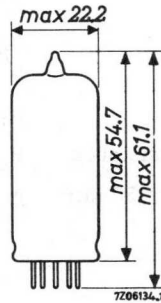
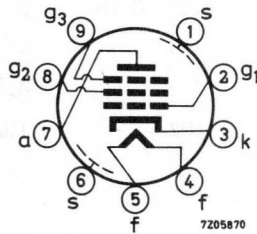

CAPACITANCES

Anode to all except grid No.1	$C_{a(g_1)}$	5.1 pF
Grid No.1 to all except anode	$C_{g_1(a)}$	5.5 pF
Anode to grid No.1	C_{ag_1}	max. 0.002 pF
Grid No.1 to heater	C_{g_1f}	0.05 pF

TYPICAL CHARACTERISTICS

Anode voltage	V_a	170	V
Grid No.2 voltage	V_{g2}	100	V
Grid No.3 voltage	V_{g3}	0	V
Anode current	I_a	12	mA
Grid No.1 voltage	V_{g1}	-1.2	V ¹⁾
Grid No.2 current	I_{g2}	4.4	mA
Transconductance	S	4.4	mA/V
Internal resistance	R_i	0.4	MΩ
Amplification factor	μ_{g2g1}	21	

OPERATING CHARACTERISTICS

Anode voltage, supply voltage	$V_a = V_b$	200	170	V		
Grid No.3 voltage	V_{g3}	0	0	V		
Grid No.2 resistor	R_{g2}	24	15	kΩ		
Cathode resistor	R_k	130	130	Ω		
Grid No.1 voltage	V_{g1}	-1.95	-20	V		
Anode current	I_a	11.1	-	11.0	mA	
Grid No.2 current	I_{g2}	3.8	-	3.9	mA	
Transconductance	S	3.85	0.16	3.8	0.11	mA/V
Internal resistance	R_i	550	-	450	-	kΩ
Equivalent noise resistance	R_{eq}	4.2	-	4.5	-	kΩ
Input conductance f = 50 MHz	g	102	-	102	-	μA/V

¹⁾ In this case control grid current may occur. If this is not permissible, the negative grid bias should be increased to a value of 1.5 V at least.

TYPICAL CHARACTERISTICS AND OPERATING CHARACTERISTICS

(continued)

Anode voltage, supply voltage	$V_a = V_b$	100	100	V		
Grid No.3 voltage	V_{g3}	0	0	V		
Grid No.2 resistor	R_{g2}	15	0	k Ω		
Cathode resistor	R_k	130	160	Ω		
Grid No.1 voltage	V_{g1}	-1.05	-10	-1.9	-10	V
Anode current	I_a	6.0	-	8.6	-	mA
Grid No.2 current	I_{g2}	2.1	-	3.1	-	mA
Transconductance	S	3.2	0.15	3.3	0.16	mA/V
Internal resistance	R_i	475	-	300	-	k Ω
Equivalent noise resistance	R_{eq}	3.5	-	4.7	-	k Ω
Input conductance $f = 50$ MHz	g	120	-	102	-	μ A/V

LIMITING VALUES (Design centre rating system)

Anode voltage	V_{a0}	max. 550	V
	V_a	max. 250	V
Anode dissipation	W_a	max. 2.25	W
Grid No.2 voltage	V_{g20}	max. 550	V
	V_{g2}	max. 250	V
Grid No.2 dissipation	W_{g2}	max. 0.45	W
Cathode current	I_k	max. 16.5	mA
Grid No.1 resistor	R_{g1}	max. 3	M Ω
Grid No.3 resistor	R_{g3}	max. 10	k Ω
Cathode to heater voltage	V_{kf}	max. 150	V

TYPICAL CHARACTERISTICS AND OPERATING CHARACTERISTICS

(continued)

Symbol	Value	Symbol	Value	Symbol	Value	Symbol	Value
V_{L1}	100	V_{L2}	100	V_{L3}	100	V_{L4}	100
V_{L5}	100	V_{L6}	100	V_{L7}	100	V_{L8}	100
V_{L9}	100	V_{L10}	100	V_{L11}	100	V_{L12}	100
V_{L13}	100	V_{L14}	100	V_{L15}	100	V_{L16}	100
V_{L17}	100	V_{L18}	100	V_{L19}	100	V_{L20}	100
V_{L21}	100	V_{L22}	100	V_{L23}	100	V_{L24}	100
V_{L25}	100	V_{L26}	100	V_{L27}	100	V_{L28}	100
V_{L29}	100	V_{L30}	100	V_{L31}	100	V_{L32}	100
V_{L33}	100	V_{L34}	100	V_{L35}	100	V_{L36}	100
V_{L37}	100	V_{L38}	100	V_{L39}	100	V_{L40}	100
V_{L41}	100	V_{L42}	100	V_{L43}	100	V_{L44}	100
V_{L45}	100	V_{L46}	100	V_{L47}	100	V_{L48}	100
V_{L49}	100	V_{L50}	100	V_{L51}	100	V_{L52}	100
V_{L53}	100	V_{L54}	100	V_{L55}	100	V_{L56}	100
V_{L57}	100	V_{L58}	100	V_{L59}	100	V_{L60}	100
V_{L61}	100	V_{L62}	100	V_{L63}	100	V_{L64}	100
V_{L65}	100	V_{L66}	100	V_{L67}	100	V_{L68}	100
V_{L69}	100	V_{L70}	100	V_{L71}	100	V_{L72}	100
V_{L73}	100	V_{L74}	100	V_{L75}	100	V_{L76}	100
V_{L77}	100	V_{L78}	100	V_{L79}	100	V_{L80}	100
V_{L81}	100	V_{L82}	100	V_{L83}	100	V_{L84}	100
V_{L85}	100	V_{L86}	100	V_{L87}	100	V_{L88}	100
V_{L89}	100	V_{L90}	100	V_{L91}	100	V_{L92}	100
V_{L93}	100	V_{L94}	100	V_{L95}	100	V_{L96}	100
V_{L97}	100	V_{L98}	100	V_{L99}	100	V_{L100}	100

Symbol	Value	Symbol	Value	Symbol	Value	Symbol	Value
V_{L101}	100	V_{L102}	100	V_{L103}	100	V_{L104}	100
V_{L105}	100	V_{L106}	100	V_{L107}	100	V_{L108}	100
V_{L109}	100	V_{L110}	100	V_{L111}	100	V_{L112}	100
V_{L113}	100	V_{L114}	100	V_{L115}	100	V_{L116}	100
V_{L117}	100	V_{L118}	100	V_{L119}	100	V_{L120}	100
V_{L121}	100	V_{L122}	100	V_{L123}	100	V_{L124}	100
V_{L125}	100	V_{L126}	100	V_{L127}	100	V_{L128}	100
V_{L129}	100	V_{L130}	100	V_{L131}	100	V_{L132}	100
V_{L133}	100	V_{L134}	100	V_{L135}	100	V_{L136}	100
V_{L137}	100	V_{L138}	100	V_{L139}	100	V_{L140}	100
V_{L141}	100	V_{L142}	100	V_{L143}	100	V_{L144}	100
V_{L145}	100	V_{L146}	100	V_{L147}	100	V_{L148}	100
V_{L149}	100	V_{L150}	100	V_{L151}	100	V_{L152}	100
V_{L153}	100	V_{L154}	100	V_{L155}	100	V_{L156}	100
V_{L157}	100	V_{L158}	100	V_{L159}	100	V_{L160}	100
V_{L161}	100	V_{L162}	100	V_{L163}	100	V_{L164}	100
V_{L165}	100	V_{L166}	100	V_{L167}	100	V_{L168}	100
V_{L169}	100	V_{L170}	100	V_{L171}	100	V_{L172}	100
V_{L173}	100	V_{L174}	100	V_{L175}	100	V_{L176}	100
V_{L177}	100	V_{L178}	100	V_{L179}	100	V_{L180}	100
V_{L181}	100	V_{L182}	100	V_{L183}	100	V_{L184}	100
V_{L185}	100	V_{L186}	100	V_{L187}	100	V_{L188}	100
V_{L189}	100	V_{L190}	100	V_{L191}	100	V_{L192}	100
V_{L193}	100	V_{L194}	100	V_{L195}	100	V_{L196}	100
V_{L197}	100	V_{L198}	100	V_{L199}	100	V_{L200}	100

A.F. OUTPUT PENTODE

Pentode intended for use as A.F. power amplifier.

QUICK REFERENCE DATA		
Anode current	I_a	70 mA
Transconductance	S	11 mA/V
Amplification factor	$\mu_{g_2g_1}$	8
Output power	W_o	5.3 W

HEATING: Indirect by A.C. or D.C.; series supply

Heater current

I_f 100 mA

Heater voltage

V_f 45 V

DIMENSIONS AND CONNECTIONS

Dimensions in mm

Base: Noval

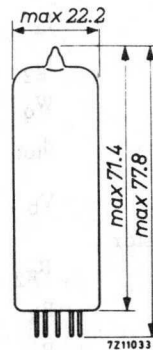
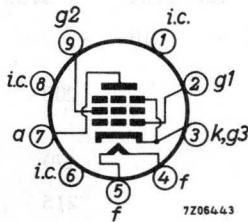

CAPACITANCES

Anode to all except grid No. 1

$C_{a(g_1)}$ 6.8 pF

Grid No. 1 to all except anode

$C_{g_1(a)}$ 13 pF

Anode to grid No. 1

C_{ag_1} max. 0.6 pF

Grid No. 1 to heater

C_{g_1f} max. 0.25 pF

TYPICAL CHARACTERISTICS

Anode voltage	V_a	170 V
Grid No. 2 voltage	V_{g2}	170 V
Grid No. 1 voltage	V_{g1}	-12.5 V
Anode current	I_a	70 mA
Grid No. 2 current	I_{g2}	3.5 mA
Transconductance	S	11 mA/V
Amplification factor	μ_{g2g1}	8
Internal resistance	R_i	26 k Ω

OPERATING CHARACTERISTICS

Class A 1)

Supply voltage	V_b	100	170	V
Cathode resistor	R_k	130	130	Ω
Load resistance	$R_{a\sim}$	2.1	2.0	k Ω
Grid No. 1 driving voltage	V_i	0 0.55 3.8	0 0.47 6.1	V _{RMS}
Anode current	I_a	41 - 42	75 - 76	mA
Grid No. 2 current	I_{g2}	2.6 - 8.6	4.0 - 16.5	mA
Output power	W_o	0 0.05 1.55	0 0.05 5.1	W
Distortion	d_{tot}	- - 10	- - 10	%
Supply voltage	V_b		200	V
Grid No. 2 series resistor (non decoupled)	R_{g2}		470	Ω
Cathode resistor	R_k		215	Ω
Load resistance	$R_{a\sim}$		2.5	k Ω
Grid No. 1 driving voltage	V_i		0 0.52 7.0	V _{RMS}
Anode current	I_a		65 - 64	mA
Grid No. 2 current	I_{g2}		3.2 - 11.4	mA
Output power	W_o		0 0.05 5.3	W
Distortion	d_{tot}		- - 10	%

1) Measured with V_k kept constant.

OPERATING CHARACTERISTICS (continued)

Class AB, two tubes in push-pull

Supply voltage	V_b	200	V
Common cathode resistor	R_k	120	Ω
Load resistance	$R_{aa\sim}$	3	$k\Omega$
Grid No.1 driving voltage	V_i	0 0.47 14.3	V_{RMS}
Anode current	I_a	2x60 - 2x64.5	mA
Grid No.2 current	I_{g2}	2x3.0 - 2x18.5	mA
Output power	W_o	0 0.05 14.3	W
Distortion	d_{tot}	- - 3.8	%

LIMITING VALUES (Design centre rating system)

Anode voltage	V_{a0}	max. 550	V
	V_a	max. 250	V
Grid No.2 voltage	V_{g20}	max. 550	V
	V_{g2}	max. 200	V
Anode dissipation	W_a	max. 12	W
Grid No.2 dissipation, average	W_{g2}	max. 1.75	W
	W_{g2p}	max. 6	W
Cathode resistor	I_k	max. 100	mA
Grid No.1 resistor, automatic bias	R_{g1}	max. 1	$M\Omega$
Cathode to heater voltage	V_{kf}	max. 200	V

INTERNATIONAL CHARTER OF FREEDOM OF INFORMATION

Article 1. Purpose and Scope

1. This Charter is intended to ensure that the right of every individual to know what his government is doing is recognized and protected.

2. It is the right of every individual to know what his government is doing, and it is the duty of every government to provide this information.

3. This Charter applies to all governments, whether they are democracies or authoritarian regimes.

4. It is the duty of every government to provide this information in a timely and accessible manner.

5. This Charter is intended to ensure that the right of every individual to know what his government is doing is recognized and protected.

Article 2. Right of Access to Information

1. Every individual has the right to access information held by his government.

2. This right is subject to such limitations as are necessary to protect national security, public safety, or the privacy of individuals.

3. Every government should establish a system of access to information which is simple, efficient, and free of charge.

4. Every government should establish a system of access to information which is simple, efficient, and free of charge.

5. Every government should establish a system of access to information which is simple, efficient, and free of charge.

6. Every government should establish a system of access to information which is simple, efficient, and free of charge.

7. Every government should establish a system of access to information which is simple, efficient, and free of charge.

8. Every government should establish a system of access to information which is simple, efficient, and free of charge.

9. Every government should establish a system of access to information which is simple, efficient, and free of charge.

10. Every government should establish a system of access to information which is simple, efficient, and free of charge.

SINGLE ANODE RECTIFYING TUBE

Single anode high vacuum rectifying tube.

QUICK REFERENCE DATA			
Transformer voltage	V_{tr}	250	V_{RMS}
D.C. current	I_o	110	mA

HEATING: Indirect by A.C. or D.C.; series supply

Heater current	I_f	100	mA
Heater voltage	V_f	38	V

DIMENSIONS AND CONNECTIONS

Base: Noval

Dimensions in mm

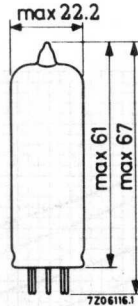
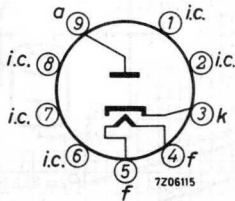

OPERATING CHARACTERISTICS as single-phase half-wave rectifier

Transformer voltage	V_{tr}	250	220	127	110	V_{RMS}
D.C. output voltage	V_o	245	215	135	112	V
D.C. current	I_o	110	110	110	110	mA
Protecting resistance	R_t	100	90	0	0	Ω
Input capacitor of smoothing filter	C_{filt}	100	100	100	100	μF

LIMITING VALUES (Design centre rating system)

Anode voltage, peak inverse	V_{ainvp}		max.	700	V
D.C. current	I_o		max.	110	mA
Anode peak current	I_{ap}		max.	660	mA
Cathode to heater voltage, peak, k pos.	V_{kfp}		max.	550	V
Input capacitor of smoothing filter	C_{filt}		max.	100	μF
Protecting resistance at transformer voltage	R_t	min. 100	90	0	0 Ω
	V_{tr}	250	220	127	110 V_{RMS}

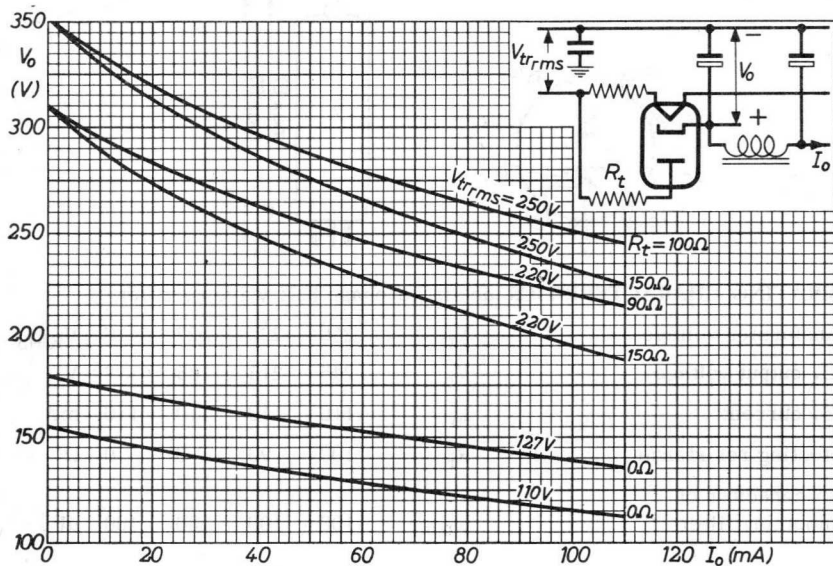

7206114-21.25 he

SINGLE ANODE RECTIFYING TUBE

Single anode high vacuum rectifying tube.

QUICK REFERENCE DATA		
Transformer voltage	V_{tr}	250 V
D.C. current	I_o	100 mA

HEATING: Indirect by A.C. or D.C.; series supply

Heater current	I_f	100 mA
Heater voltage	V_f	31 V

DIMENSIONS AND CONNECTIONS

Base: Noval

Dimensions in mm

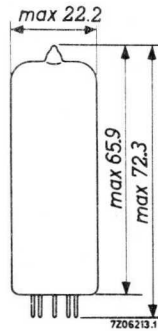
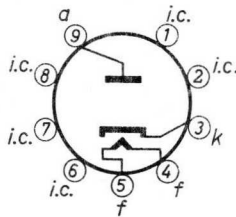

OPERATING CHARACTERISTICS as single-phase half-wave rectifier.

Transformer voltage	V_{tr}	250	220	127	110	V_{RMS}
D.C. output voltage	V_o	205	188	135	113	V
D.C. current	I_o	100	100	100	100	mA
Protecting resistance	R_t	210	160	0	0	Ω
Input capacitor of smoothing filter	C_{filt}	50	50	50	50	μF

LIMITING VALUES (Design centre rating system)

Anode voltage, peak inverse	V_{ainvp}	max.	700	V			
D.C. current	I_o	max.	100	mA			
Anode current, peak	I_{ap}	max.	600	mA			
Heater to cathode voltage, peak, k pos.	V_{kfp}	max.	550	V			
Protecting resistance at transformer voltage	R_t	min.	210	160	0	0	Ω
	V_{tr}		250	220	127	110	V_{RMS}

INDEX OF TYPE NUMBERS

Type No.	Type No.	Type No.	Type No.
DY51	ECL82	EY500	PL36
DY86	ECL84	EY500A	PL81
DY87	ECL85	EZ80	PL83
DY802	ECL86	EZ81	PL84
EAA91	ECL805	GY501	PL95
EABC80	ED500	GZ34	PL500
EB91	EF80	PABC80	PL504
EBC81	EF85	PC86	PL505
EBF80	EF86	PC88	PL508
EBF89	EF89	PC92	PL509
EC86	EF183	PC900	PL519
EC88	EF184	PCC85	PL802
EC92	EFL200	PCC88	PY81
EC900	EL34	PCC189	PY82
ECC81	EL36	PCF80	PY88
ECC82	EL81	PCF86	PY500
ECC83	EL84	PCF200	PY500A
ECC85	EL86	PCF201	UABC80
ECC88	EL95	PCF801	UBC81
ECC189	EL500	PCF802	UBF89
ECF80	EL503	PCH200	UCC85
ECF86	EL504	PCL82	UCH81
ECF200	EL508	PCL84	UCL82
ECF201	EL509	PCL85	UF89
ECF801	EL519	PCL86	UL84
ECF802	EL802	PCL805	UY85
ECH81	EM84	PD500	UY89
ECH83	EM87	PD510	
ECH84	EY81	PF86	
ECH200	EY88	PFL200	

INDEX OF THE NUMBERS

Page	Page	Page	Page
1	1	1	1
2	2	2	2
3	3	3	3
4	4	4	4
5	5	5	5
6	6	6	6
7	7	7	7
8	8	8	8
9	9	9	9
10	10	10	10
11	11	11	11
12	12	12	12
13	13	13	13
14	14	14	14
15	15	15	15
16	16	16	16
17	17	17	17
18	18	18	18
19	19	19	19
20	20	20	20
21	21	21	21
22	22	22	22
23	23	23	23
24	24	24	24
25	25	25	25
26	26	26	26
27	27	27	27
28	28	28	28
29	29	29	29
30	30	30	30
31	31	31	31
32	32	32	32
33	33	33	33
34	34	34	34
35	35	35	35
36	36	36	36
37	37	37	37
38	38	38	38
39	39	39	39
40	40	40	40
41	41	41	41
42	42	42	42
43	43	43	43
44	44	44	44
45	45	45	45
46	46	46	46
47	47	47	47
48	48	48	48
49	49	49	49
50	50	50	50
51	51	51	51
52	52	52	52
53	53	53	53
54	54	54	54
55	55	55	55
56	56	56	56
57	57	57	57
58	58	58	58
59	59	59	59
60	60	60	60
61	61	61	61
62	62	62	62
63	63	63	63
64	64	64	64
65	65	65	65
66	66	66	66
67	67	67	67
68	68	68	68
69	69	69	69
70	70	70	70
71	71	71	71
72	72	72	72
73	73	73	73
74	74	74	74
75	75	75	75
76	76	76	76
77	77	77	77
78	78	78	78
79	79	79	79
80	80	80	80
81	81	81	81
82	82	82	82
83	83	83	83
84	84	84	84
85	85	85	85
86	86	86	86
87	87	87	87
88	88	88	88
89	89	89	89
90	90	90	90
91	91	91	91
92	92	92	92
93	93	93	93
94	94	94	94
95	95	95	95
96	96	96	96
97	97	97	97
98	98	98	98
99	99	99	99
100	100	100	100

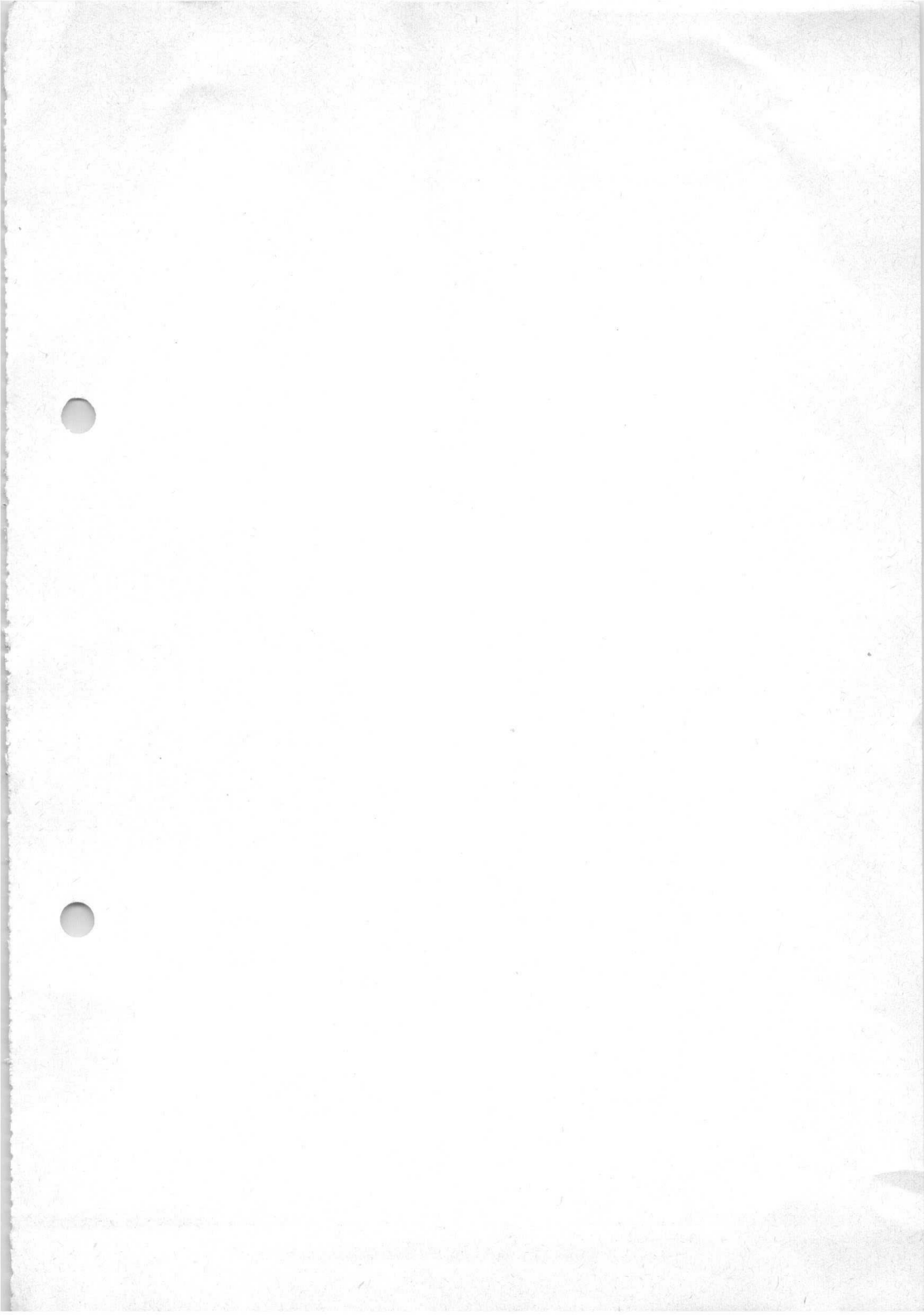

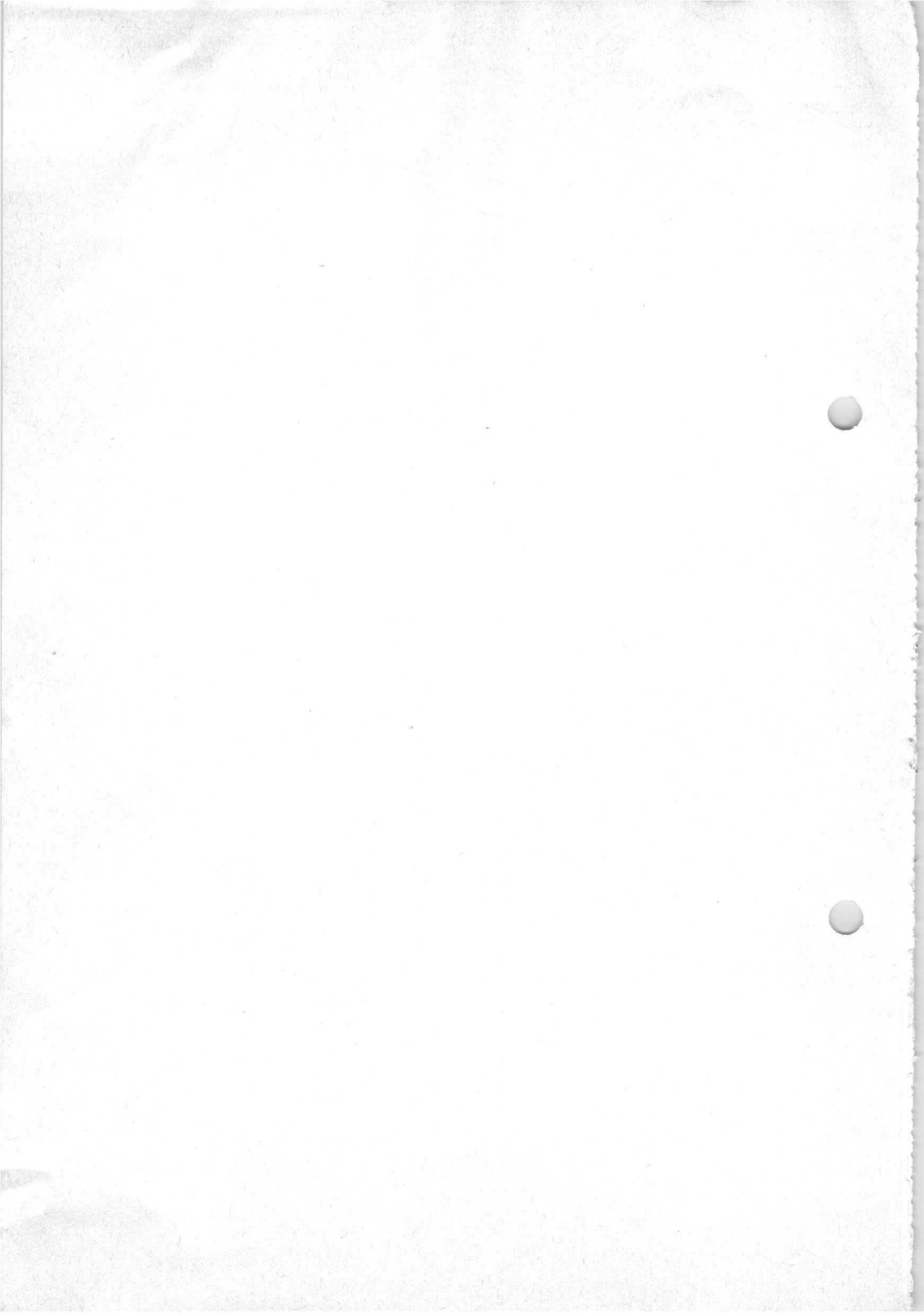

Gene. of section

Receiving tubes

General section

Receiving tubes

●

●

