

PHILIPS

Data handbook



Electronic
components
and materials

Electron tubes

Part 7a March 1977

Thyratrons

Industrial rectifying tubes

Ignitrons

High voltage rectifying tubes



ELECTRON TUBES

Part 7a

March 1977

Thyratrons

Industrial rectifying tubes

Ignitrons

High - voltage rectifying tubes

Associated accessories

Index

Some devices are labelled

Maintenance type

Obsolescent type

or

Obsolete type

Maintenance type - Available for equipment maintenance
No longer recommended for equipment production.

Obsolescent type - Available until present stocks are exhausted.

Obsolete type - No longer available.

DATA HANDBOOK SYSTEM

Our Data Handbook System is a comprehensive source of information on electronic components, subassemblies and materials; it is made up of three series of handbooks each comprising several parts.

ELECTRON TUBES

BLUE

SEMICONDUCTORS AND INTEGRATED CIRCUITS

RED

COMPONENTS AND MATERIALS

GREEN

The several parts contain all pertinent data available at the time of publication, and each is revised and reissued periodically.

Where ratings or specifications differ from those published in the preceding edition they are pointed out by arrows. Where application information is given it is advisory and does not form part of the product specification.

If you need confirmation that the published data about any of our products are the latest available, please contact our representative. He is at your service and will be glad to answer your inquiries.

This information is furnished for guidance, and with no guarantee as to its accuracy or completeness; its publication conveys no licence under any patent or other right, nor does the publisher assume liability for any consequence of its use; specifications and availability of goods mentioned in it are subject to change without notice; it is not to be reproduced in any way, in whole or in part without the written consent of the publisher.

RATING SYSTEM

(in accordance with I.E.C. publication 134)

Absolute maximum rating system

Absolute maximum ratings are limiting values of operating and environmental conditions applicable to any electronic device of a specified type as defined by its published data, which should not be exceeded under the worst probable conditions.

These values are chosen by the device manufacturer to provide acceptable serviceability of the device, taking no responsibility for equipment variations, environmental variations, and the effects of changes in operating conditions due to variations in the characteristics of the device under consideration and of all other electronic devices in the equipment.

The equipment manufacturer should design so that, initially and throughout life, no absolute-maximum value for the intended service is exceeded with any device under the worst probable operating conditions with respect to supply voltage variation, equipment component variation, equipment control adjustment, load variations, signal variation, environmental conditions, and variations in characteristics of the device under consideration and of all other electronic devices in the equipment.

Thyratrons



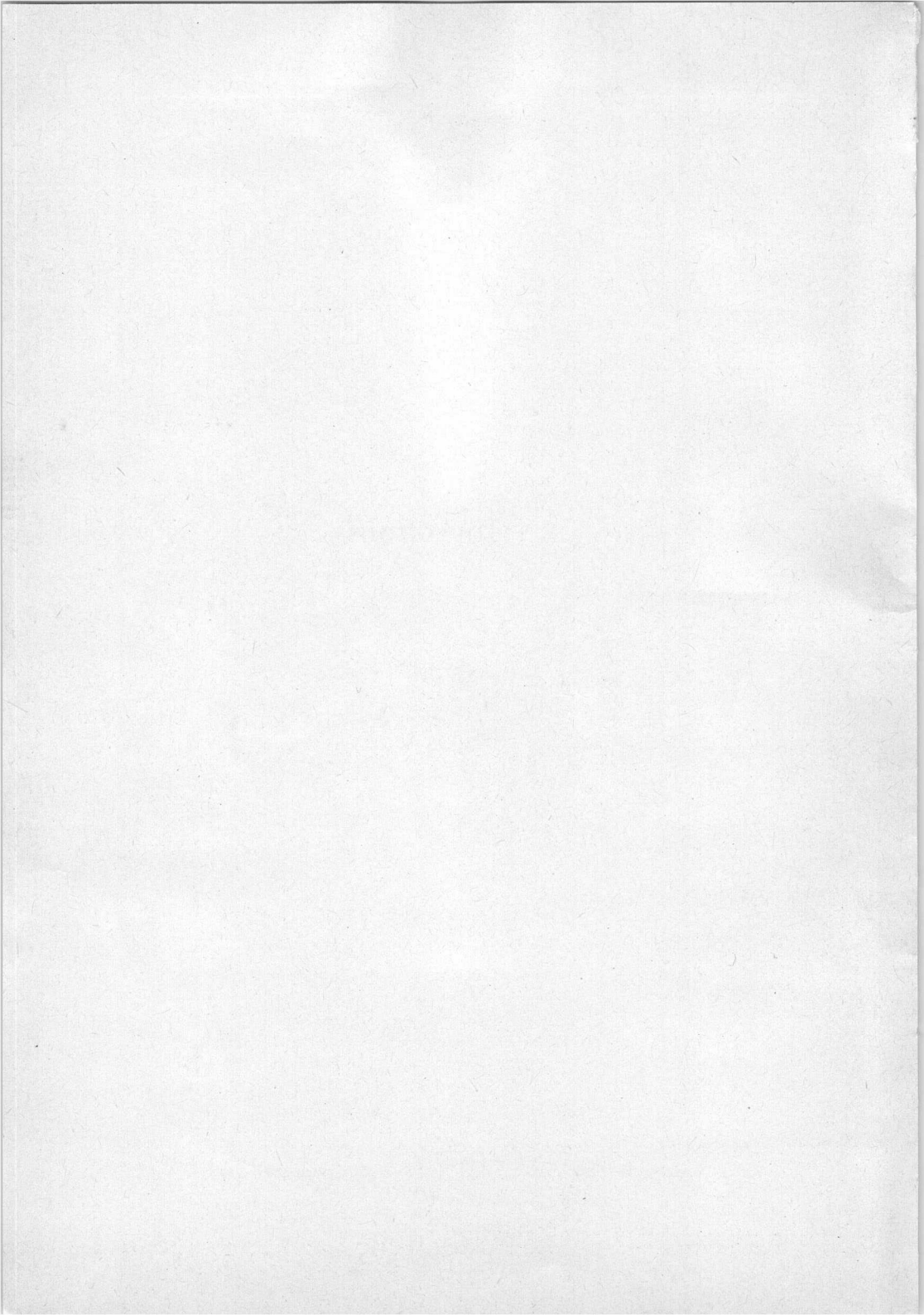

GENERAL OPERATIONAL RECOMMENDATIONS

THYRATRONS

The following instructions and recommendations apply in general to all types of thyratrons. If there are deviations for any type of tube they will be indicated on the published data sheets of the type in question.

MOUNTING

Normally the tubes must be mounted vertically with the base or filament strips at the lower end. They must be mounted so that air can circulate freely around them. Where additional cooling is necessary forced air should assist the natural convection. (This is of great importance in the case of mercury-vapour filled tubes, in order to condense the mercury in the lower part of the tube). The clearance between the tubes and other components of the circuit and between the tubes and cabinet walls should be at least half the maximum tube diameter.

When 2 or more tubes are used the minimum clearance between them should be $3/4$ the maximum tube diameter. When the tube is mounted in a closed cabinet the heat dissipated by the tube and other components should be taken into account. While the tube is working it must not touch any other part of the installation or be exposed to falling drops of liquid.

The tubes should be mounted in such a way that they are not subjected to dangerous shock or vibration. In general, if shock or vibration exceeds 0.5 g a shock absorbing device should be used.

The electrode connections, except for those of the tube holder, must be flexible. The nuts (e.g. of the anode connections) should be well tightened but care must be taken to ensure that no undue forces are exerted on the tube. The contacts must be checked at regular intervals and their surfaces kept clean in order to avoid excessive heating of the glass-metal seals. The cross section of the conductors and leads should be sufficient to carry the r.m.s. value of the current. (It should be noted that in grid controlled rectifier circuits the r.m.s. value of the anode current may reach $2.5 \times$ the average d.c. value and even more).

FILAMENT SUPPLY

In order to obtain the maximum life of a directly heated tube, a filament transformer with centre-tap and a phase shift of $90^\circ \pm 30^\circ$ between V_a and V_f is recommended.

If, in the published data, limits are given for the filament voltage, steps should be taken to prevent the filament voltage exceeding these limits owing to the spread of the transformer, fluctuations of the mains voltage, etc. The filament voltage at nominal mains voltage is measured at the terminals of the tube. If no limits for the filament voltage are given, deviations with a maximum of 2.5% from the published value, can be accepted.

It is therefore recommended to have tappings on the filament transformer. The mains fluctuations should, in general, not exceed 5%. During short intervals fluctuations of 10% are admissible.

In calculating the ratings of the filament transformer a variation in the filament current of plus and minus 10% from tube to tube should be taken into account, whilst for directly heated tubes the d.c. current flowing through the filament winding should also be considered.

TEMPERATURE

1. For tubes filled with mercury vapour or with a mixture of mercury vapour and inert gas.

For these tubes temperature limits for the condensed mercury are given in the published data. Care should be taken to ensure that the temperature during operation is between these limits. Too low temperature gives low gas pressure which results in a low current capability, high arc drop and consequently shortening of life. Too high a temperature gives high gas pressure which results in a reduction of the "arc-back" voltage, and with it the permissible peak inverse and forward voltages. The condensed mercury temperature can be measured with a thermo-element placed against the envelope. The measurement should be made at the coldest part of the bulb where the mercury condenses; in general this will be just above the base or the lower connections.

Good technique and instruments are necessary for accurate thermocouple measurements. In addition to the temperature limits for the condensed mercury sometimes limits for the ambient temperature are given.

The latter are only intended as a guide, as the difference between the ambient and the condensed mercury temperature largely depends on mounting and cooling.

The mercury condensed temperature is decisive in all cases.

The ambient temperature can be measured with a thermometer which has been screened against direct heat radiation. The measurement should be carried out at various points around the lower part of the tube.

2. Tubes with inert gas-filling

For these tubes only the limits of the ambient temperature are given. These limits are in general minimum -55°C and maxima $+75^{\circ}\text{C}$.

SWITCHING ON

1. Tubes filled with mercury vapour or with a mixture of mercury vapour and inert gas

It is necessary to allow some time for the cathode to reach its operating temperature before drawing cathode current. Therefore the minimum cathode heating time is given on the published data sheets.

After the cathode heating time the tube may be switched on provided the temperature of the condensed mercury is not too low.

Switching on (not after transport) may be done at a condensed mercury temperature which lies 5 to 10 °C below the minimum temperature published (minimum waiting time required).

However, it is good practice to switch on after the temperature having passed its minimum published value (recommended waiting time)

The switching on times, the minimum required and the recommended one can be read from the curve representing the condensed mercury temperature as a function of time with only the filament voltage applied to the tube.

The minimum required switching on time can directly be read from the curve representing this time as a function of the ambient temperature.

Switching on after transport or after a considerable interruption of operation should be done according to the instructions for use which are packed with the tube.

In order to avoid long preheating times it is recommended to leave the filament supply on during stand-by periods (e.g. overnight) at 60-80% of the nominal voltage.

2. Tubes with inert gas-filling

It is necessary to allow the cathode to reach operating temperature before drawing cathode current.

Therefore the minimum cathode heating time is published after which the anode voltage may be applied provided that the ambient temperature is not below the minimum published value.

LIMITING VALUES

In general these values are given as absolute maxima; i.e. maxima which should not be exceeded under any conditions (so they may not be exceeded owing to mains voltage fluctuations, load variations, tolerances on components, over-voltages etc.)

For each rating of maximum average current a maximum averaging time is quoted. This is to ensure that an anode current greater than the maximum continuously permissible average value is not drawn for such a length of time as would give rise to an excessive temperature within the tube.

The maximum peak anode current is determined by the available safe cathode emission whereas the average current is limited by its heating effects.

Under no circumstances may the peak current exceed its maximum published value. For the determination of the actual value of the peak inverse voltage and the peak anode current, the measured values with an oscilloscope or otherwise are decisive.

TYPICAL CHARACTERISTICS

1. Arc voltage

The value published for V_{arc} applies to average operating conditions; under high peak current conditions, e.g. 6 phase rectification, V_{arc} will be higher. The spread which is dependent on the circuit can be expected to be plus and minus 1 V.

During life and increase of approximately 2 V must be taken into account.

2. Frequency

Unless otherwise stated the maximum frequency at which the tubes may run under full load is 150 Hz.

Under special conditions higher frequencies may be used, details should be obtained from the manufacturer.

OPERATING CHARACTERISTICS

The data under this heading are based on normal practical conditions.

SHORT CIRCUIT PROTECTION

In order to prevent the tube from being damaged by passing too high a peak current a value for the surge current is given. The figure given for the maximum surge current is intended as a guide to equipment designers. It indicates the maximum value of a transient current resulting from a sudden overload or short circuit which the thyatron can pass for a period not exceeding 0.1 second without resulting in its immediate destruction. Several overloads of this nature will, however, considerably reduce the life of the tube.

The equipment designer has to take into account this maximum surge current rating when calculating the short-circuit impedance of the equipment.

This surge current value is not intended as a peak current that may occur on switching or during operation.

A simple method to limit the surge current to the max. rating is to incorporate a series resistance in the anode circuit.

SCREENING AND INTERFERENCE

In order to prevent unwanted ionisation of the gas filling (and consequent flash over) due to strong R.F. fields, it may be necessary to enclose the thyatron in a separate earthed screening box.

In circuits with gas-filled tubes oscillation in the transformer windings and other circuit components may occur, resulting in excessive peak inverse voltages and arc back. Damping of these oscillations is necessary especially at higher voltages. Parallel RC-circuits are recommended for this purpose.

SMOOTHING CIRCUITS

In order to limit the peak anode current in a rectifier it is necessary that a choke should precede the first smoothing condenser.

To ensure good voltage regulation on fluctuating loads the inductance value of the choke should be large enough to give uninterrupted current at minimum load.

The choke and capacitor must not resonate at the supply or ripple frequency. In grid controlled rectifier circuits under phased-back conditions the harmonic content of the d. c. output will be large unless the inductance is adequate.

PARALLEL OPERATION OF GAS-FILLED TUBES

As individual gas-filled thyratrons may have slightly different characteristics two or more tubes must not be connected directly in parallel. An alternative expedient must be adopted if a higher current output is required. Information on suitable methods will be supplied on request.

EFFECTS OF POSITIVE ION CURRENT

When a thyatron is conducting, a positive ion current of a magnitude proportional to the cathode current is generated. This current will, in general, flow to that electrode which is at the most negative potential during conduction (e. g. the grid). In order to prevent damage to the tube it is necessary to ensure that the voltage of this electrode is more positive than -10 V during this phase. This precaution will prevent an increase in grid emission due to excessive grid dissipation, sputtering of grid material, changes in the control characteristics caused by shifts in contact potential and, in the case of inert-gas-filled tubes, a rapid gas clean up.

In circuits where the control grid is held negative during anode conduction, a suitable choice of resistor in series with the grid will maintain an effective grid bias more positive than -10 V. The minimum allowable value of the grid resistor is 0.1 x the recommended one.

In circuits where the anode potential changes from a positive to a negative value and the control grid is at a positive potential, thereby drawing cathode current, a small positive ion current flows to the anode. At high negative anode voltages it is therefore essential to limit the magnitude of the positive ion current by severely restricting the current flowing from cathode to grid. This may be effected by using the maximum permitted series resistor, or preferably by using fixed negative grid bias and a narrow positive firing pulse.

In those circuits where the anode potential changes very rapidly from a positive to a high negative value, such as with inductive loads fed from polyphase supplies, there will be residual positive ions within the tube which will be drawn towards the anode with considerable energy. In the case of an inert-gas filled tube this would result in excessive gas clean-up and it is therefore necessary to observe the limitations imposed by the commutation factor.

CONTROL CHARACTERISTICS

In most cases the control characteristic given on the data sheets is shown by upper and lower boundary curves within which all tubes may be expected to remain at all temperatures of the published range and during life.

In multitube circuits where the tubes are operating under the same conditions the spread will in general be smaller. The published boundaries are therefore to be considered as extreme limits. This should be taken into consideration when designing grid excitation circuits.

GRID EXCITATION CIRCUITS

To keep the instant of ignition as constant as possible a large value of excitation voltage is recommended.

The use of a negative grid bias (20 to 50 V for a d.c. output voltage of 200 to 600 V) and a sharp positive grid pulse is recommended.

The magnitude of the grid should be 70 to 100 V with a grid series resistor of 20 k Ω and a maximum impedance of the peaking transformer of 30 k Ω . If a sinusoidal grid voltage is used the following r.m.s. values are recommended. With inductive or resistive load without a back E.M.F. this excitation voltage should be of the order of 8 x the spread of the control characteristic (30 to 50 V_{rms}).

If a back E.M.F. is present the value of excitation voltage should be 15 x the spread of the control characteristic (50 to 100 V_{rms}).

THYRATRON

Thyratron, inert gas filled tetrode for relay service, electronic timers, stabilized rectifiers, stabilization of A.C. output, in grid circuits of power thyratrons.

QUICK REFERENCE DATA	
Peak anode voltage	$V_{ap} = 650 \text{ V}$
Cathode current, peak	$I_{kp} = 0.5 \text{ A}$
average	$I_k = 0.1 \text{ A}$

HEATING: indirect by A.C. or D.C.

Heater voltage	$V_f = 6.3 \text{ V}$
Heater current	$I_f = 600 \text{ mA}$
Waiting time	$T_w = 20 \text{ s } ^1)$

CAPACITANCES

Grid No.1 to all other elements	$C_{g1} = 2.4 \text{ pF}$
Anode to all other elements	$C_a = 1.6 \text{ pF}$
Anode to grid No.1	$C_{ag1} = 26 \text{ mpF}$

MECHANICAL DATA

Dimensions in mm

Base: 7 pin miniature

Net weight: 10 g

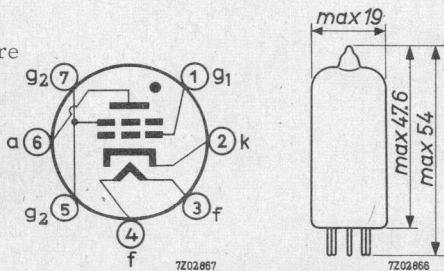

Mounting position: any

¹⁾ If urgently wanted T_w may be decreased to min. 10 s.

TYPICAL CHARACTERISTICS

Ionization time

at $V_{a\sim} = 100$ V, grid No.1 over-voltage = 50 V (substantial square pulse)
Anode peak current during conduction = 0.5 A

$$T_{ion} = 0.5 \mu s$$

Deionization time

at $V_{a\sim} = 125$ V, $V_{g1} = -100$ V,
 $R_{g1} = 1000 \Omega$, $I_a = 0.1$ A

$$T_{dion} = 35 \mu s$$

Deionization time

at $V_{a\sim} = 125$ V, $V_{g1} = -10$ V,
 $R_{g1} = 1000 \Omega$, $I_a = 0.1$ A

$$T_{dion} = 75 \mu s$$

Critical grid No.1 current

at $V_{a\sim} = 125$ VRMS, $I_a = 0.1$ A

$$I_{g1} = 0.5 \mu A$$

Maintaining voltage

$$V_{arc} = 8$$
 V

Control ratio grid No.1 at striking point

$R_{g1} = 0 \Omega$, $V_{g2} = 0$ V

$$\frac{V_a}{V_{g1}} = 250$$

Control ratio grid No.2 at striking point

$V_{g1} = 0$ V, $R_{g1} = 0 \Omega$, $R_{g2} = 0 \Omega$

$$\frac{V_a}{V_{g2}} = 1000$$

OPERATING CONDITIONSfor relay service

Anode voltage	$V_{a\sim} = 117$	400	VRMS
Grid No.2 voltage	$V_{g2} = 0$	0	V
Grid No.1 (bias) voltage	$V_{g1\sim} = 5$	-	VRMS ¹⁾
Grid No.1 (bias) voltage	$V_{g1} = -$	-6	V
Grid No.1 peak (signal) voltage	$V_{g1p} = 5$	6	V
Anode circuit resistance	$R_a = 1.2$	2.0	k Ω
Grid No.1 circuit resistance	$R_{g1} = 1.0$	1.0	M Ω

¹⁾ Phase difference between V_a and V_{g1} approx. 180°.

LIMITING VALUES for relay- and grid controlled service
(Absolute max. rating system)

Anode voltage,	
forward peak	$V_{ap} = \text{max. } 650 \text{ V}$
inverse peak	$V_{a \text{ inv}p} = \text{max. } 1300 \text{ V}$
Grid No.2 voltage,	
peak before conduction	$-V_{g2p} = \text{max. } 100 \text{ V}$
average during conduction $T_{av} = \text{max. } 30 \text{ s}$	$-V_{g2} = \text{max. } 10 \text{ V}$
Grid. No.1 voltage,	
peak before conduction	$-V_{g1p} = \text{max. } 100 \text{ V}$
average during conduction $T_{av} = \text{max. } 30 \text{ s}$	$-V_{g1} = \text{max. } 10 \text{ V}$
Cathode current,	
peak	$I_{kp} = \text{max. } 0.5 \text{ A}$
average, $T_{av} = \text{max. } 30 \text{ s}$	$I_k = \text{max. } 0.1 \text{ A}$
surge, $T = \text{max. } 0.1 \text{ s}$	$I_{\text{surge}} = \text{max. } 10 \text{ A}$
Grid No.2 current	
average, $T_{av} = \text{max. } 30 \text{ s}$	$I_{g2} = \text{max. } 10 \text{ mA } ^1)$
Grid No.1 current,	
average, $T_{av} = \text{max. } 30 \text{ s}$	$I_{g1} = \text{max. } 10 \text{ mA}$
Cathode to heater voltage,	
k pos., peak	$V_{+kf-} = \text{max. } 100 \text{ V}$
k neg., peak	$V_{-kf+} = \text{max. } 25 \text{ V}$
Heater voltage	
	$V_f = \text{max. } 6.9 \text{ V}$
	$= \text{min. } 5.7 \text{ V}$
Ambient temperature	
	$t_{\text{amb}} = \text{max. } +90 \text{ } ^\circ\text{C}$
	$= \text{min. } -75 \text{ } ^\circ\text{C}$

CIRCUIT DESIGN VALUES

Grid No.1 circuit resistance	$R_{g1} = \text{max. } 10 \text{ M}\Omega$
recommended value	$R_{g1} = 1 \text{ M}\Omega$

¹⁾ In order not to exceed this maximum value it is recommended to insert a resistor of 1000Ω in the grid No.2 lead.

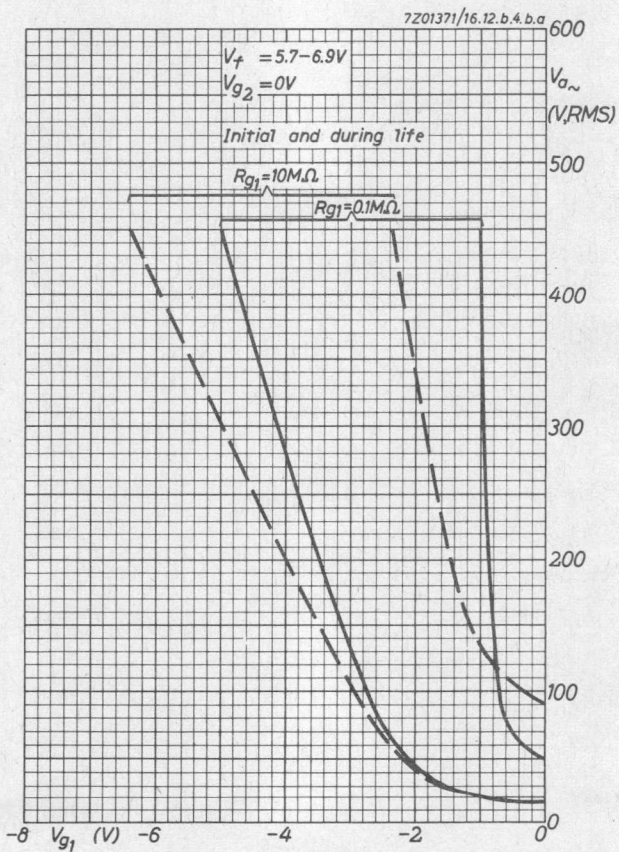

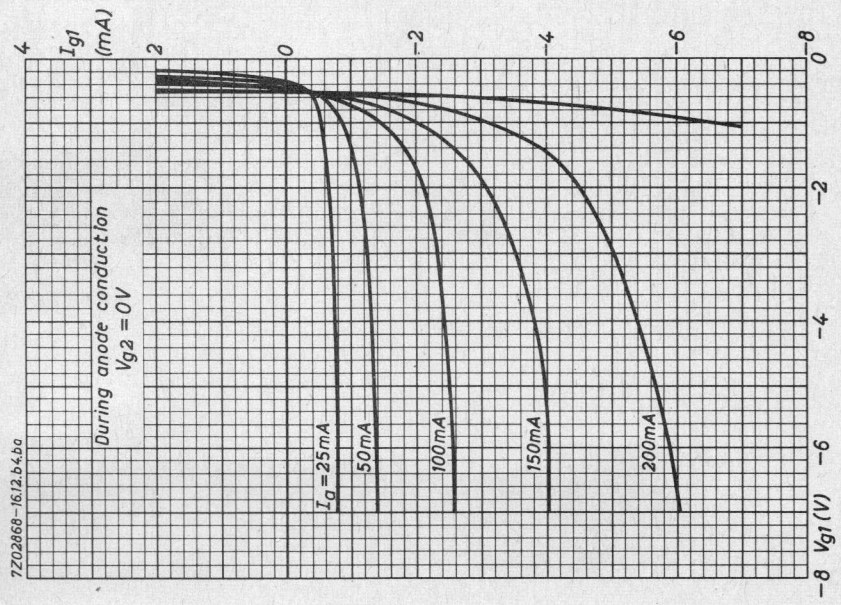
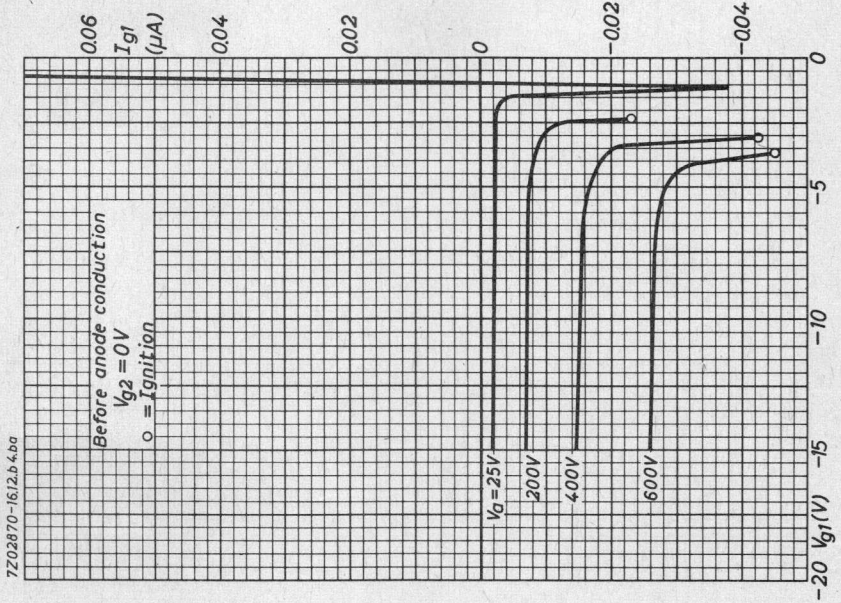

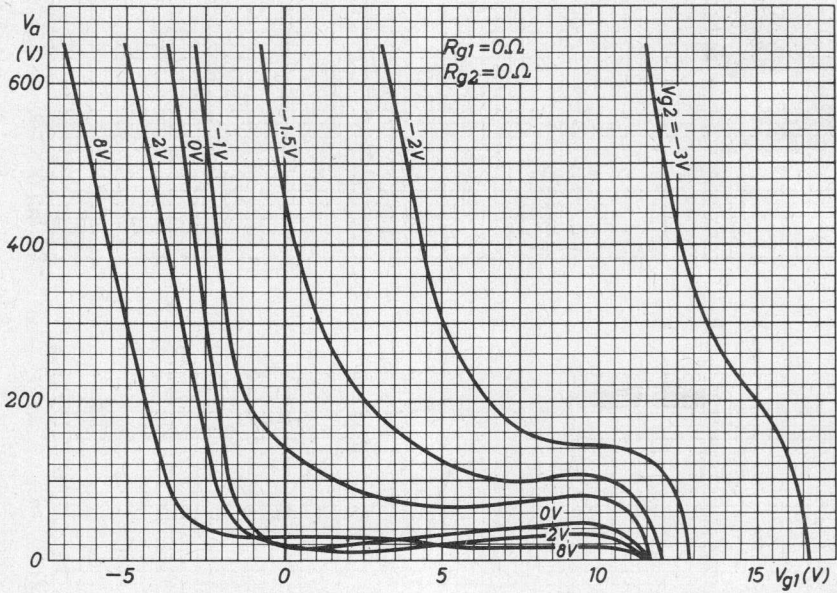

7202869-1612.b4ba

TRIODE THYRATRON

Mercury vapour and inert gas filled triode thyatron with negative control characteristic.

QUICK REFERENCE DATA			
Peak forward anode voltage	V_{ap}	max.	1500 V
Peak inverse anode voltage	V_{ainvp}	max.	1500 V
Average cathode current	I_k	max.	1,6 A
Peak cathode current	I_{kp}	max.	6,4 A
Average grid current	I_g	max.	10 mA
Peak grid current	I_{gp}	max.	50 mA

HEATING : direct

Filament voltage	V_f		2,5 V
Filament current	I_f		7 A
Waiting time	T_w	min.	15 s) ¹⁾

CAPACITANCE

Anode to grid	C_{ag}		2 pF
---------------	----------	--	------

TYPICAL CHARACTERISTICS

Arc voltage	V_{arc}		10 V
Ionisation time	T_{ion}		10 μ s
Deionisation time	T_{dion}		1000 μ s

¹⁾ Recommended waiting time 30 s

²⁾ Page 2. The ambient temperature is defined as the temperature of the surrounding air and shall be measured under the following conditions:

- normal atmospheric pressure;
- the tube shall be adjusted to the worst probable operating conditions;
- the temperature shall be measured when thermal equilibrium is reached;
- the distance of the thermometer shall be 52 mm from the outside of the envelope (measured in a plane perpendicular to the main axis of the tube at the height of the condensed mercury boundary);
- the thermometer shall be shielded to avoid direct heat radiation.

MECHANICAL DATA

Dimensions in mm

Base : Medium 4p with bayonet

Cap : 40619

Net mass: 90 g

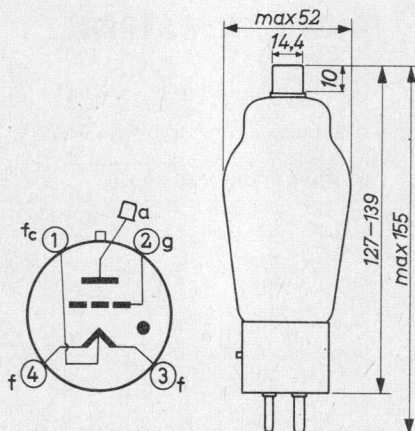

Mounting position: Vertical with base down

LIMITING VALUES (Absolute limits)

Peak forward anode voltage	V_{ap}	max.	1500 V
Peak inverse anode voltage	V_{ainvp}	max.	1500 V
Negative grid voltage before conduction	$-V_g$	max.	500 V
Negative grid voltage during conduction	$-V_g$	max.	10 V
Average grid current, anode positive (Averaging time)	I_g T_{av}	max.	10 mA 5 s
Peak grid current	I_{gp}	max.	50 mA
Grid circuit resistance	R_g		5 to 100 k Ω ¹⁾
Average cathode current (Averaging time)	I_k T_{av}	max.	1,6 A 5 s
Peak cathode current	I_{kp}	max.	6,4 A
Surge cathode current (Duration)	I_{surge} T	max.	120 A 0,1 s
Ambient temperature	t_{amb}		-40 to +50 °C ²⁾³⁾
Condensed mercury temperature	t_{Hg}		-40 to +80 °C

¹⁾ Recommended value 50 k Ω

²⁾ See page 1

³⁾ Recommended temperature approximately 25 °C.

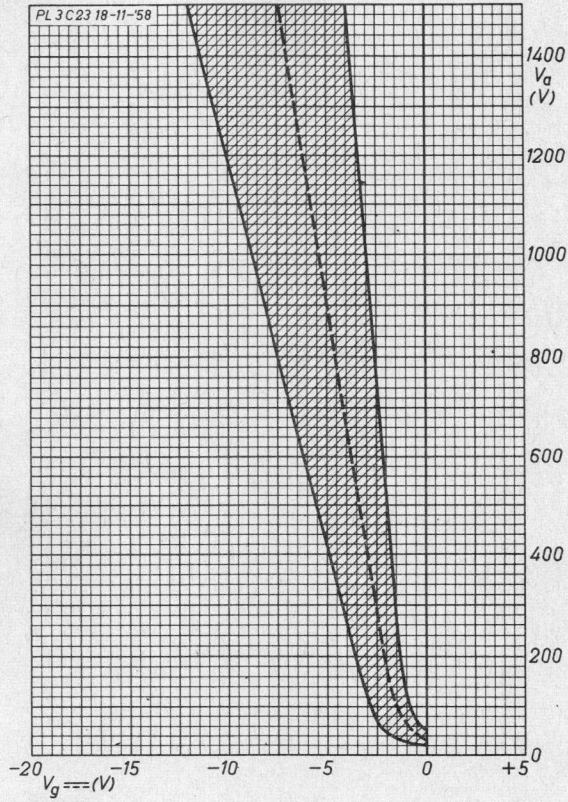

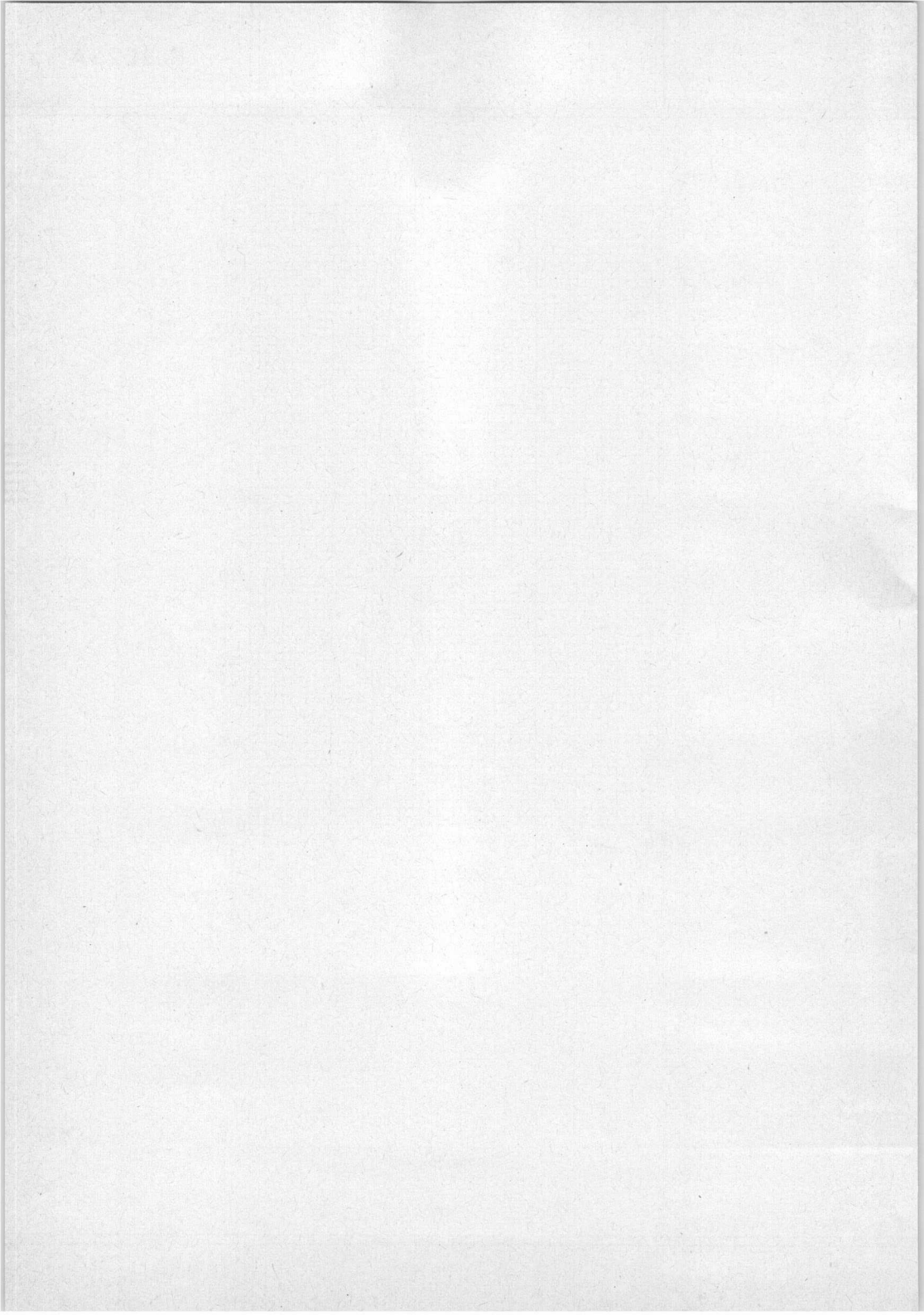

THYRATRON

Mercury vapour filled tetrode thyatron intended for the following applications:

D.C. : for use as rectifier with variable or stabilized output voltage and for electronic D.C. motor speed control.

A.C. : for use as electronic switch and control of ignition circuits; control of electric furnaces, incandescent lamps and discharge lamps; for resistance welding up to 27 kVA.

QUICK REFERENCE DATA

Anode voltage, peak forward	V_{ap}	max. 2500 V
peak inverse	V_{invp}	max. 2500 V
Anode current, average ($T_{av} = \text{max. } 15 \text{ s}$)	I_a	max. 6.4 A
peak ($f \geq 25 \text{ Hz}$)	I_{ap}	max. 40 A

HEATING: indirect

Heater voltage	V_f	5.0 V \pm 5%
Heater current	I_f	10 A
Waiting time	T_w	min. 5 min.

MECHANICAL DATA

Dimensions in mm

Base : Super jumbo with bayonet

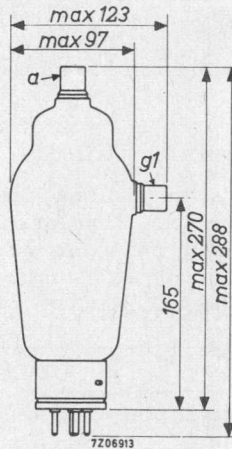
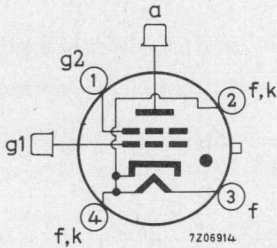

Pins 2 and 3 heater, pin 4 cathode return

Mounting position: vertical, base down

Net weight: 510 g

ACCESSORIES

Socket 2422 511 01001

Cap connector 40620

CAPACITANCES

Anode to grid No. 1 C_{ag_1} 1.8 pF

Grid No. 1 to cathode C_{g_1k} 5.0 pF

TYPICAL CHARACTERISTICS

Arc voltage V_{arc} 12 V

Ionization time T_{ion} 10 μs

Recovery time (Reionization time) T_{dion} 1000 μs

Frequency f max. 150 Hz

Intermittent service**LIMITING VALUES** (Absolute max. rating system)

Anode voltage, peak forward	V_{ap}	max.	750 V
peak inverse	V_{invp}	max.	750 V
Grid No.2 voltage	$-V_{g2}$	max.	500 V
tube conducting	$-V_{g2}$	max.	10 V
Grid No.1 voltage	$-V_{g1}$	max.	1000 V
tube conducting	$-V_{g1}$	max.	10 V
Anode current, peak ($f < 25$ Hz)	I_{ap}	max.	5.0 A
($f \geq 25$ Hz)	I_{ap}	max.	77 A
average ($T_{av} = \text{max. } 5$ s)	I_a	max.	2.5 A
Surge current ($T = \text{max. } 0.1$ s)	I_{surge}	max.	400 A
Grid No.2 current, peak	I_{g2p}	max.	2.0 A
average ($T_{av} = \text{max. } 5$ s)	I_{g2}	max.	0.5 A
Grid No.1 current, peak	I_{g1p}	max.	1.0 A
average ($T_{av} = \text{max. } 5$ s)	I_{g1}	max.	0.25 A
Grid No.2 resistor	R_{g2}	max.	10 k Ω
recommended value	R_{g2}		10 k Ω
Grid No.1 resistor	R_{g1}	max.	100 k Ω
recommended value	R_{g1}		10 k Ω
Mercury temperature	t_{Hg}	40 to 80	$^{\circ}\text{C}$
recommended value	t_{Hg}	60	$^{\circ}\text{C}$

Continuous service

LIMITING VALUES (Absolute max. rating system)

Anode voltage, peak forward	V_{ap}	max.	2500 V
peak inverse	V_{invp}	max.	2500 V
Grid No.2 voltage	$-V_{g2}$	max.	500 V
tube conducting	$-V_{g2}$	max.	10 V
Grid No.1 voltage	$-V_{g1}$	max.	1000 V
tube conducting	$-V_{g1}$	max.	10 V
Anode current, peak ($f < 25$ Hz)	I_{ap}	max.	12.8 A
($f \geq 25$ Hz)	I_{ap}	max.	40 A
average ($T_{av} = \text{max. } 15$ s)	I_a	max.	6.4 A
Surge current ($T = \text{max. } 0.1$ s)	I_{surge}	max.	400 A
Grid No.2 current, peak	I_{g2p}	max.	2.0 A
average ($T_{av} = \text{max. } 15$ s)	I_{g2}	max.	0.5 A
Grid No.1 current, peak	I_{g1p}	max.	1.0 A
average ($T_{av} = \text{max. } 15$ s)	I_{g1}	max.	0.25 A
Grid No.2 resistor	R_{g2}	max.	10 $k\Omega$
recommended value	R_{g2}		10 $k\Omega$
Grid No.1 resistor	R_{g1}	max.	100 $k\Omega$
recommended value	R_{g1}		10 $k\Omega$
Mercury temperature	t_{Hg}	40 to 80	$^{\circ}C$
recommended value	t_{Hg}	60	$^{\circ}C$

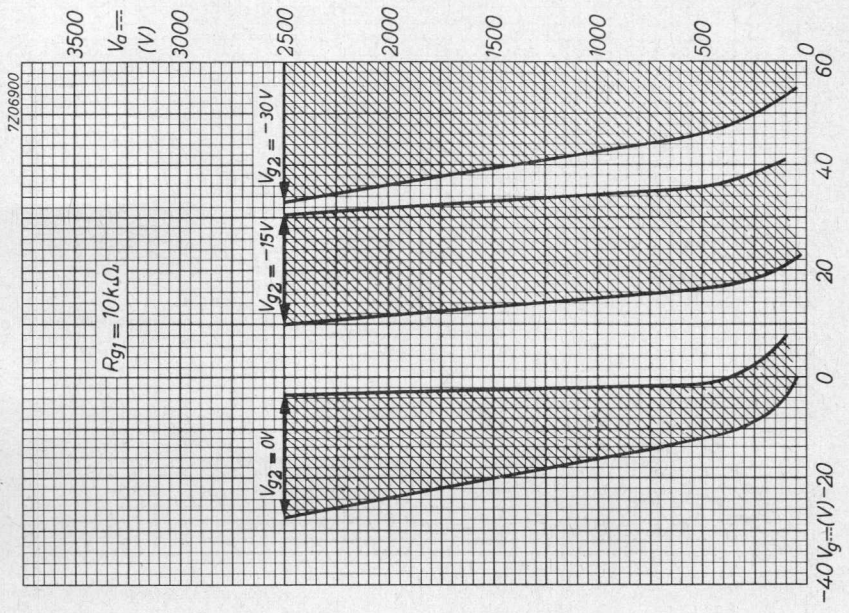
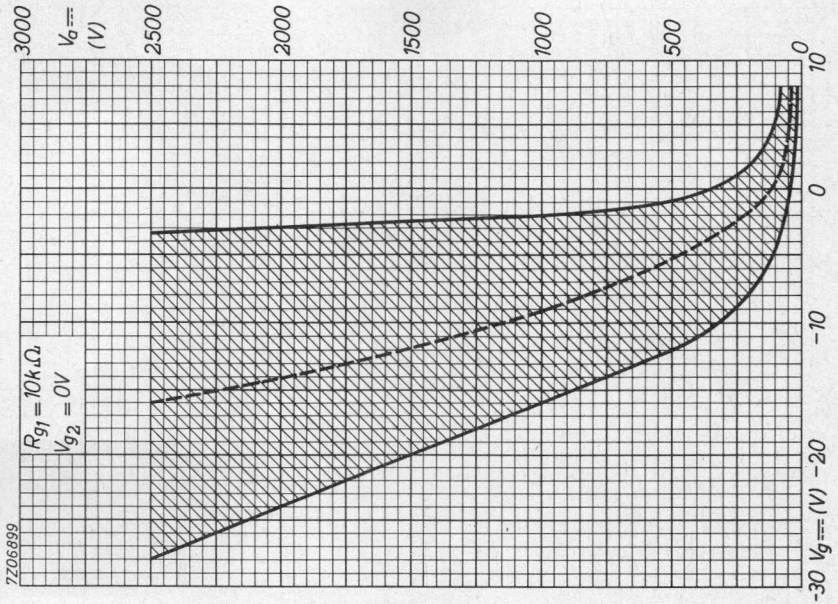

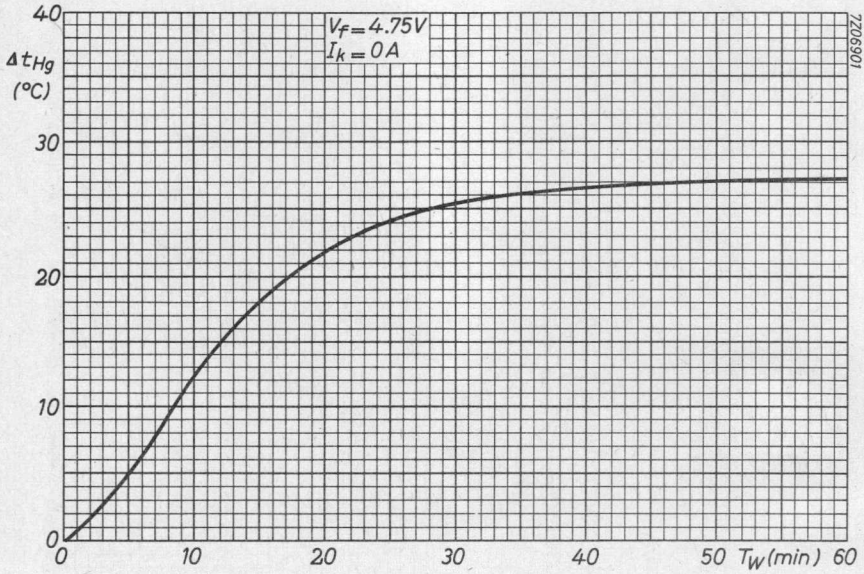

7206901

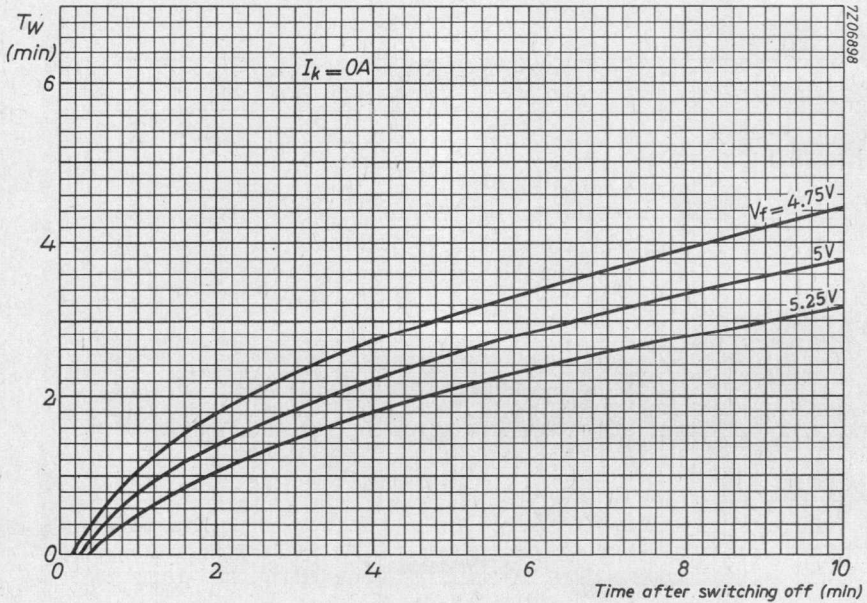

7206898

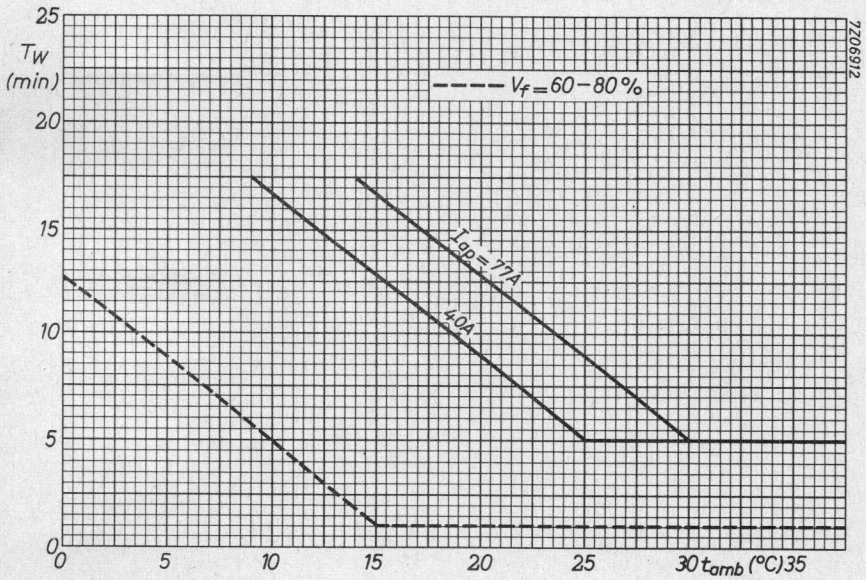

THYRATRON

Mercury-vapour triode thyatron intended for use in motor control equipment and resistance welding equipment.

QUICK REFERENCE DATA			
Anode voltage, peak forward	V_{ap}	max. 1500	V
peak inverse	V_{invp}	max. 2500	V
Cathode current, average ($T_{av} = \text{max. } 10 \text{ s}$)	I_k	max. 10	A
peak	I_{kp}	max. 100	A

HEATING: indirect

Heater voltage	V_f	5.0	V
Heater current	I_f	11	A
	I_f	max. 13	A
Waiting time (See also page 4)	T_w	min. 10	min

If during long periods of service interruption (e.g. during night hours) the heater voltage is maintained at 5 V, the waiting time can be omitted.

MECHANICAL DATA

Dimensions in mm

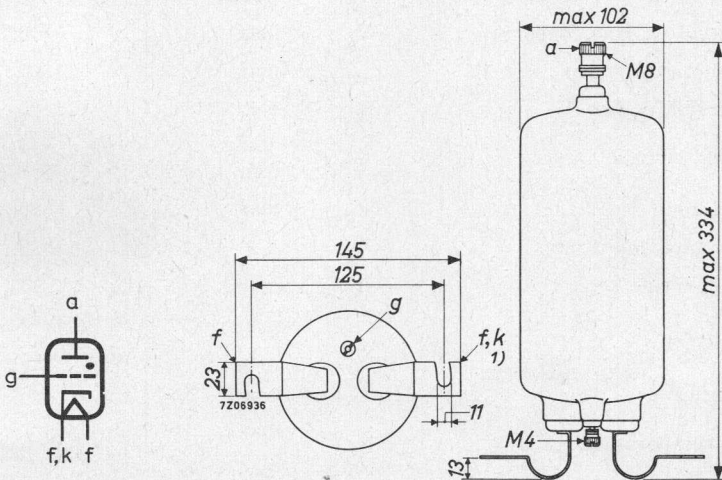

¹⁾ Marked red.

MECHANICAL DATA (continued)

Mounting position: vertical, base down

Net weight: 820 g

MERCURY TEMPERATURE

$V_f = 5.0$ V the temperature rise above ambient is approximately 10°C .

CAPACITANCES

Grid to all except anode	$C_{g(a)}$	30	pF
Anode to grid	C_{ag}	8	pF

TYPICAL CHARACTERISTICS

Arc voltage	V_{arc}	10	V
Ionization time	T_{ion}	10	μs
Recovery time (Deionization time)	T_{dion}	1000	μs

Continuous service (motor control)

LIMITING VALUES (Absolute max. rating system)

Frequency	f	max.	150	Hz
Anode voltage, peak forward	V_{ap}	max.	1500	V
peak inverse	V_{invp}	max.	2500	V
Grid voltage, before conduction	$-V_g$	max.	300	V
during conduction	$-V_g$	max.	10	V
Surge current (T = max. 0.1 s)	I_{surge}	max.	1500	A
Grid current, (V_a pos.)	I_g	max.	0.25	A
peak	I_{gp}	max.	1	A
		min.	0.5	A
Grid resistor	R_g	max.	50	$k\Omega$
recommended value	R_g		10	$k\Omega$
Cathode current, peak	I_{kp}	max.	80 100 160	¹⁾ A
RMS	I_k	max.	30 30 50	¹⁾ A
average	I_k	max.	12.5 10 20	¹⁾ A
Averaging time	T_{av}	max.	15 15	²⁾ s
Mercury temperature	t_{Hg}	max.	75 75 75	$^\circ\text{C}$
		min.	35 40 40	$^\circ\text{C}$
recommended value	t_{Hg}		60 60 60	$^\circ\text{C}$

¹⁾ Overload during max. 5 s in each 5 minutes operation period.

²⁾ Max. 1 cycle.

A. C. control and welding control

Two tubes in inverse parallel

LIMITING VALUES (Absolute max. rating system)

Frequency	f	max.	150	Hz
Anode voltage, peak forward	V_{ap}	max.	750	V
peak inverse	V_{invp}	max.	750	V
Grid voltage, before conduction	$-V_g$	max.	300	V
during conduction	$-V_g$	max.	10	V
Surge current (T = max. 0.1 s)	I_{surge}	max.	1500	A
Grid current (anode positive)	I_g	max.	0.25	A
Grid resistor	R_g	max.	50	k Ω
recommended value	R_g		10	k Ω
Mercury temperature	t_{Hg}	max.	80	$^{\circ}C$
recommended value	t_{Hg}	min.	40	$^{\circ}C$
Duty factor	δ		0.1	0.5
Cathode current, peak	I_{kp}	max.	156	78
RMS	I_k	max.	110	55
average	I_k	max.	5	12.5
Averaging time	T_{av}	max.	5	5
			15	s

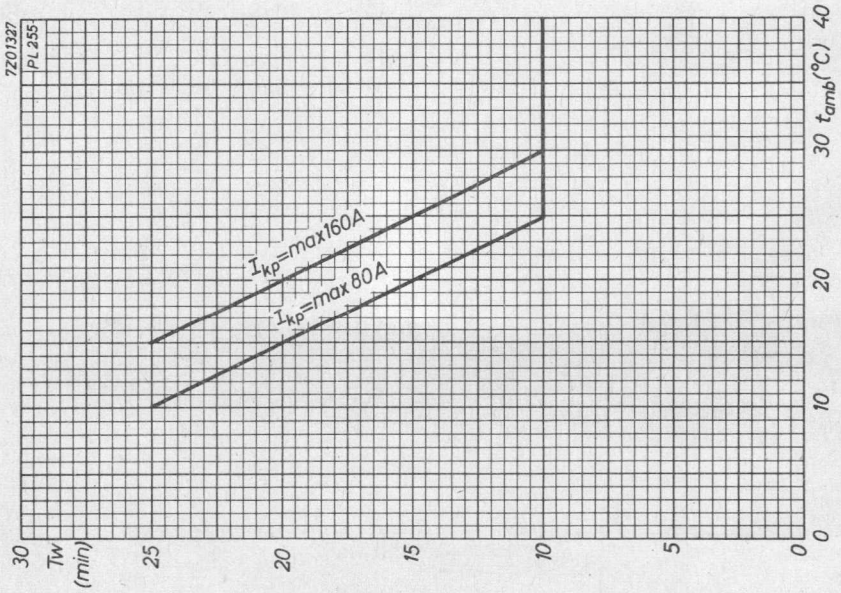
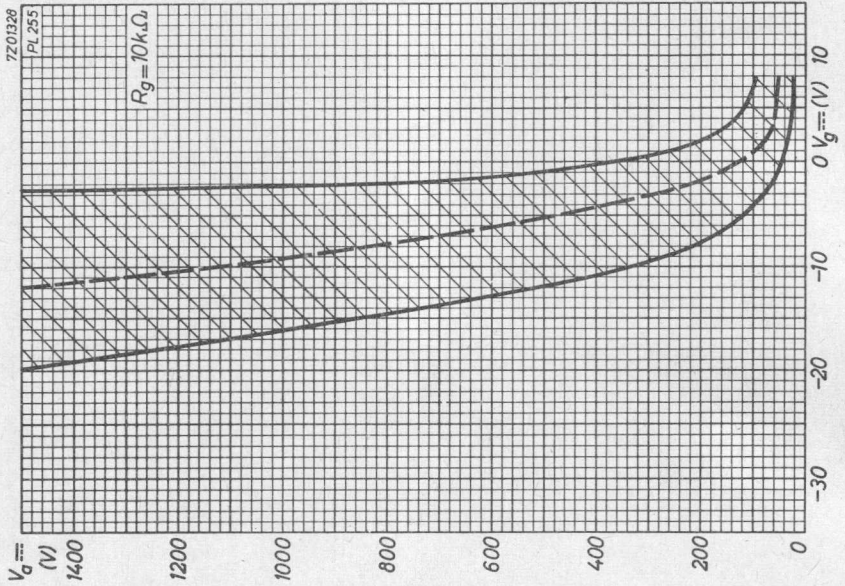

THYRATRON

Mercury-vapour triode thyatron intended for use in motor control equipment, relay service and other industrial applications.

QUICK REFERENCE DATA

Continuous service			
Anode voltage, peak forward	V_{ap}	max. 2000	V
peak inverse	V_{invp}	max. 2500	V
Cathode current, average ($T_{av} = \text{max. } 15 \text{ s}$)	I_k	max. 60	A
peak	I_{kp}	max. 200	A

HEATING: indirect

Heater voltage	V_f	5	V
Heater current	I_f	19	A
	I_f	max. 21	A
Waiting time (See also page 6)	T_w	min. 10	min

During long periods of interrupted service (e.g. during night hours) it is recommended to reduce V_f to 60-80% of the nominal value instead of switching off the heater. In this way the value of T_w can be decreased according to the dotted curve.

MECHANICAL DATA

Dimensions in mm

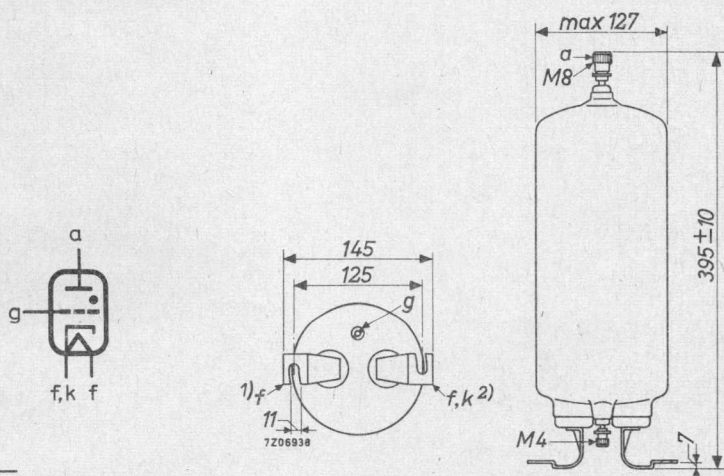

1) Marked black

2) Marked red

MECHANICAL DATA (continued)

Mounting position: vertical, base down

Net weight: 1600 g

MERCURY TEMPERATURE

At $V_f = 5.0$ V the temperature rise above ambient of the mercury is approximately 10 °C.

CAPACITANCES

Grid to all except anode	$C_{g(a)}$	60 pF
Anode to grid	C_{ag}	15 pF

TYPICAL CHARACTERISTICS

Arc voltage	V_{arc}	10 V
Ionization time	T_{ion}	10 μ s
Recovery time (Deionization time)	T_{dion}	1000 μ s

Continuous service

LIMITING VALUES (Absolute max. rating system)

Frequency	f	max. 150 Hz
Anode voltage, peak forward	V_{ap}	max. 2000 V
peak inverse	V_{invp}	max. 2500 V
Grid voltage, before conduction	$-V_g$	max. 300 V
during conduction	$-V_g$	max. 10 V
Surge current (T = max. 0.1 s)	I_{surge}	max. 2500 A
Grid current, (V_a pos.)	I_g	max. 0.25 A ¹⁾
peak	I_{gp}	min. 3 mA max. 1 A
Grid resistor	R_g	max. 20 k Ω
recommended value	R_g	10 k Ω

¹⁾ See page 4.

Continuous service (continued)

LIMITING VALUES (Absolute max. rating system)

Anode fuse	max.				80 A
recommended value					60 A
Cathode current, peak	I_{kp}	max.	160	200	300 ²⁾ A
RMS	I_k	max.	60	60	100 ²⁾ A
average	I_k	max.	25	20	40 ²⁾ A
Averaging time	T_{av}	max.	15	15	²⁾ s
Mercury temperature	t_{Hg}	max.	75	75	75 ²⁾ °C
recommended value	t_{Hg}	min.	35	35	40 ²⁾ °C
			60	60	60 °C

A.C. control and welding control

Two tubes in inverse parallel

LIMITING VALUES (Absolute max. rating system)

Frequency	f	max.			150 Hz
Anode voltage, peak forward	V_{ap}	max.			750 V
peak inverse	V_{invp}	max.			750 V
Grid voltage, before conduction	$-V_g$	max.			300 V
during conduction	$-V_g$	max.			10 V
Surge current, (T = max. 0.1 s)	I_{surge}	max.			2500 A
Grid current (V_a pos.)	I_g	max.			0.25 A ¹⁾
Grid resistor	R_g	max.			20 kΩ
recommended value	R_g				10 kΩ
Mercury temperature	t_{Hg}	max.			80 °C
recommended value	t_{Hg}	min.			40 °C
					60 °C
Duty factor	δ		0.1	0.5	1
Cathode current, peak	I_{kp}	max.	285	156	78 A
average	I_k	max.	9	25	25 A
Averaging time	T_{av}	max.	5	5	15 s
Output current, RMS	I_o	max.	200	110	55 A

¹⁾ See page 4.

NOTES

1. In order to facilitate the ignition of the tube a positive grid current of at least 3 mA is necessary. The use of a fixed negative grid bias (30 V to 50 V for D.C. output voltages of 220 V to 600 V) and a sharp grid pulse (100 V to 130 V) is recommended ($R_g = 10 \text{ k}\Omega$, impedance of pulse transformer max. 10 $\text{k}\Omega$). If a sinusoidal grid voltage is used for control, this voltage should be at least 60 V_{RMS}. The bias source impedance should be low compared with the total grid series impedance.
2. Overload during max. 5 s in each 5 minutes operating period. $T_{av} = \text{max.}$ 1 cycle.

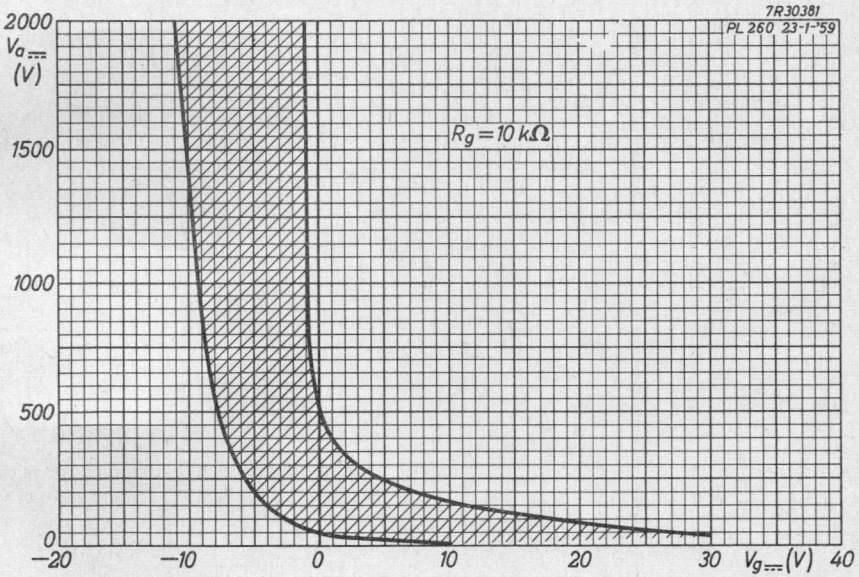

7Z06937

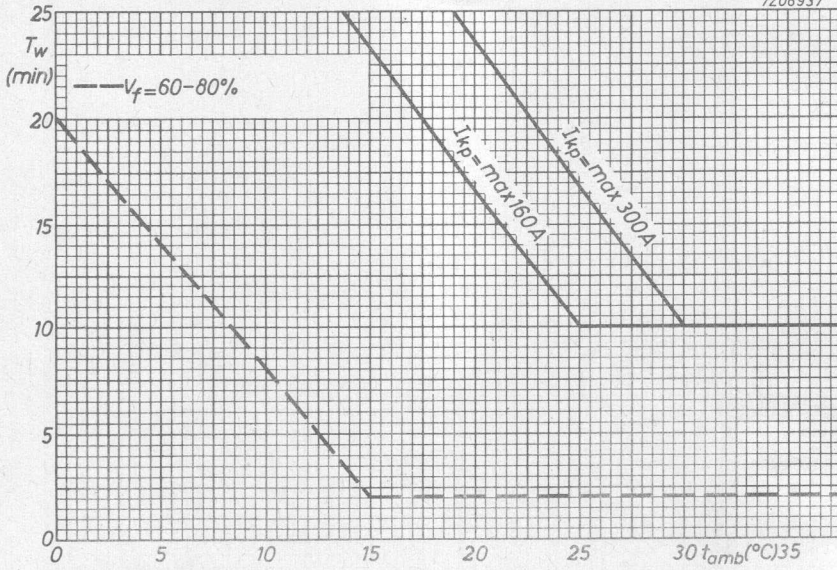

7Z06939

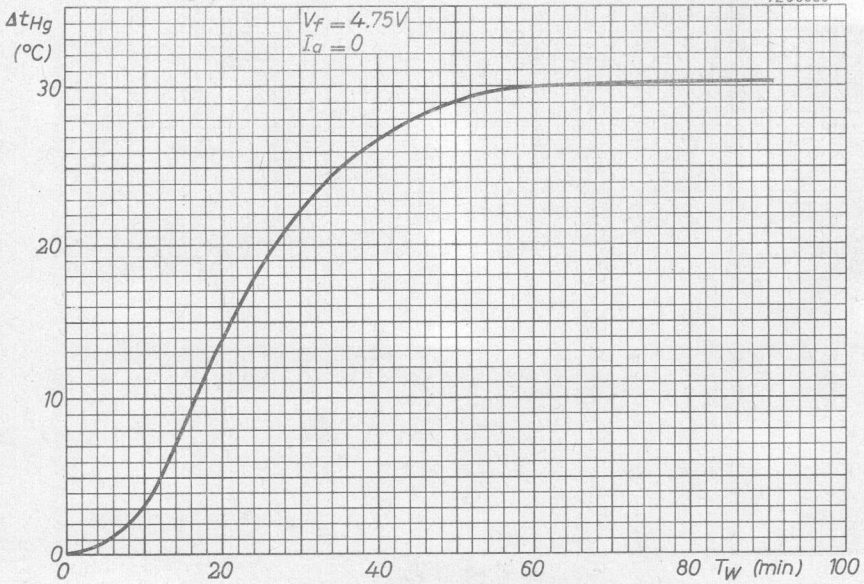

THYRATRON

Xenon-filled tetrode intended for use in electronic timers, in grid-controlled rectifiers with variable or constant output voltage.

QUICK REFERENCE DATA			
Anode voltage, peak forward	V_{ap}	max.	650 V
peak inverse	V_{invp}	max.	650 V
Anode current, average ($T_{AV} = \text{max. } 5 \text{ s}$)	I_a	max.	0.5 A
peak ($f \geq 25 \text{ Hz}$)	I_{ap}	max.	2 A

HEATING: direct

Filament voltage	V_f	2.0 V \pm 5%
Filament current	I_f	2.6 A
Waiting time	T_w	min. 30 s

MECHANICAL DATA

Dimensions in mm

Base: O

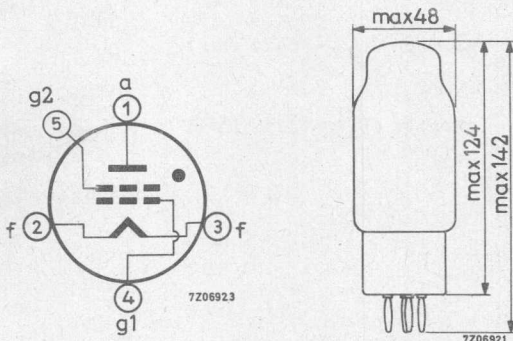

Pin 3 cathode return

Mounting position: any

Accessories

Socket type 2422 512 02001

Net weight 75 g

CAPACITANCES

Anode to grid No. 1	C_{ag1}	0.55 pF
Anode to grid No. 2	C_{ag2}	12 pF

TYPICAL CHARACTERISTICS

Arc voltage	V_{arc}	15 V
Recovery time (Deionization time)	T_{dion}	500 μs

LIMITING VALUES (Absolute max. rating system)

Anode voltage, peak forward	V_{ap}	max.	650 V
peak inverse	V_{invp}	max.	650 V
Grid No. 2 voltage, before conduction	$-V_{g2}$	max.	100 V
during conduction	$-V_{g2}$	max.	10 V
Grid No. 1 voltage, before conduction	$-V_{g1}$	max.	100 V
during conduction	$-V_{g1}$	max.	10 V
Anode current, peak ($f < 25$ Hz)	I_{ap}	max.	1 A
peak ($f > 25$ Hz)	I_{ap}	max.	2 A
average ($T_{av} = \text{max. } 15$ s)	I_a	max.	0.5 A
Grid No. 2 current, peak	I_{g2p}	max.	0.25 A
average ($T_{av} = \text{max. } 15$ s)	I_{g2}	max.	0.05 A
Grid No. 1 current, peak	I_{g1p}	max.	0.25 A
average ($T_{av} = \text{max. } 15$ s)	I_{g1}	max.	0.05 A
Grid No. 2 resistor		max.	1 $M\Omega$
	R_{g2}	min.	0.1 $M\Omega$
Grid No. 1 resistor		max.	5 $M\Omega$
	R_{g1}	min.	0.1 $M\Omega$
Ambient temperature		max.	+90 $^{\circ}C$
	t_{amb}	min.	-75 $^{\circ}C$

THYRATRON

Xenon-filled triode thyatron intended for use in motor control equipment and similar applications.

QUICK REFERENCE DATA		
Anode voltage, peak forward	V_{ap}	max. 1500 V
peak inverse	V_{invp}	max. 1500 V
Cathode current, average ($T_{av} = \text{max. } 15 \text{ s}$)	I_k	max. 3.2 A
peak	I_{kp}	max. 40 A

HEATING: direct

Filament voltage	V_f	2.5 V \pm 5%
Filament current	I_f	12 A
Waiting time	T_w	min. 60 s

MECHANICAL DATA

Dimensions in mm

Base: Super Jumbo with bayonet

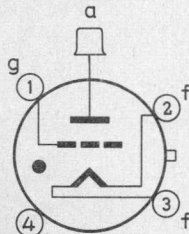

7Z06895

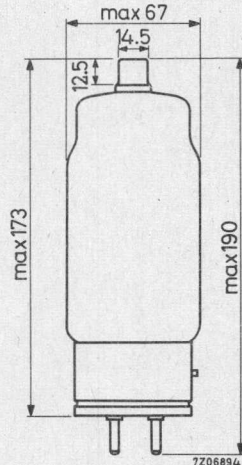

7Z06894

Mounting position: Arbitrary between horizontal and vertical with base down

Accessories

Socket	2422 511 01001
Cap connector	40619
<u>Net weight</u>	300 g

CAPACITANCES

Anode to grid	C_{ag}	0.8 pF
Grid to filament	C_{gf}	45 pF

TYPICAL CHARACTERISTICS

Arc voltage	V_{arc}	12 V
Ionization time	T_{ion}	10 μs
Recovery time (Deionization time), ($V_g = -250$ V)	T_{dion}	40 μs
($V_g = -12$ V)	T_{dion}	400 μs

LIMITING VALUES (Absolute max. rating system)

Anode voltage, peak forward	V_{ap}	max. 1500 V
peak inverse	V_{invp}	max. 1500 V
Grid voltage, before conduction	$-V_g$	max. 250 V
during conduction	$-V_g$	max. 10 V
Surge current ($T = \text{max. } 0.1$ s)	I_{surge}	max. 560 A
Grid current ($T_{av} = \text{max. } 1$ cycle)	I_g	max. 0.2 A
Cathode current, peak	I_{kp}	max. 40 A
average ($T_{av} = \text{max. } 15$ s)	I_k	max. 3.2 A
Grid resistor	R_g	max. 100 $k\Omega$ min. 0.5 $k\Omega$
recommended value	R_g	10 $k\Omega$
Ambient temperature	t_{amb}	max. 70 $^{\circ}C$ min. -55 $^{\circ}C$

7Z06893

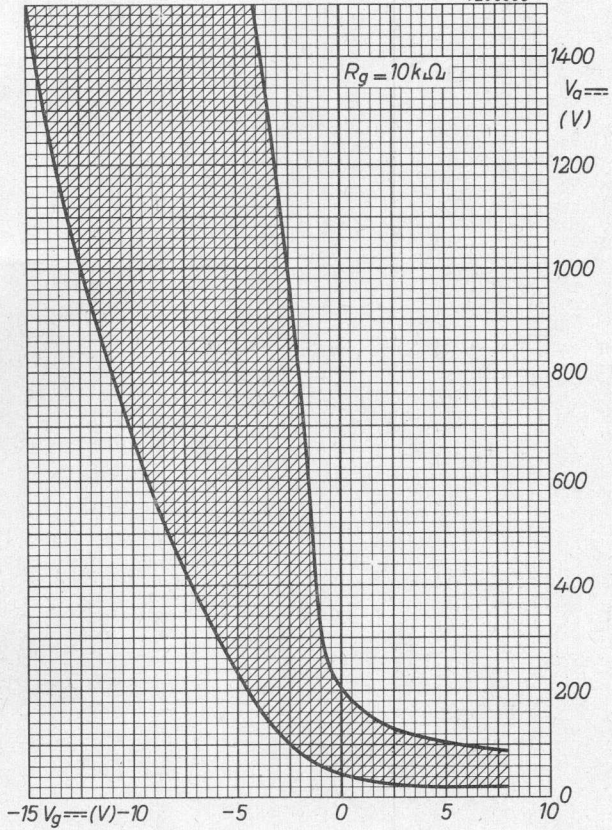

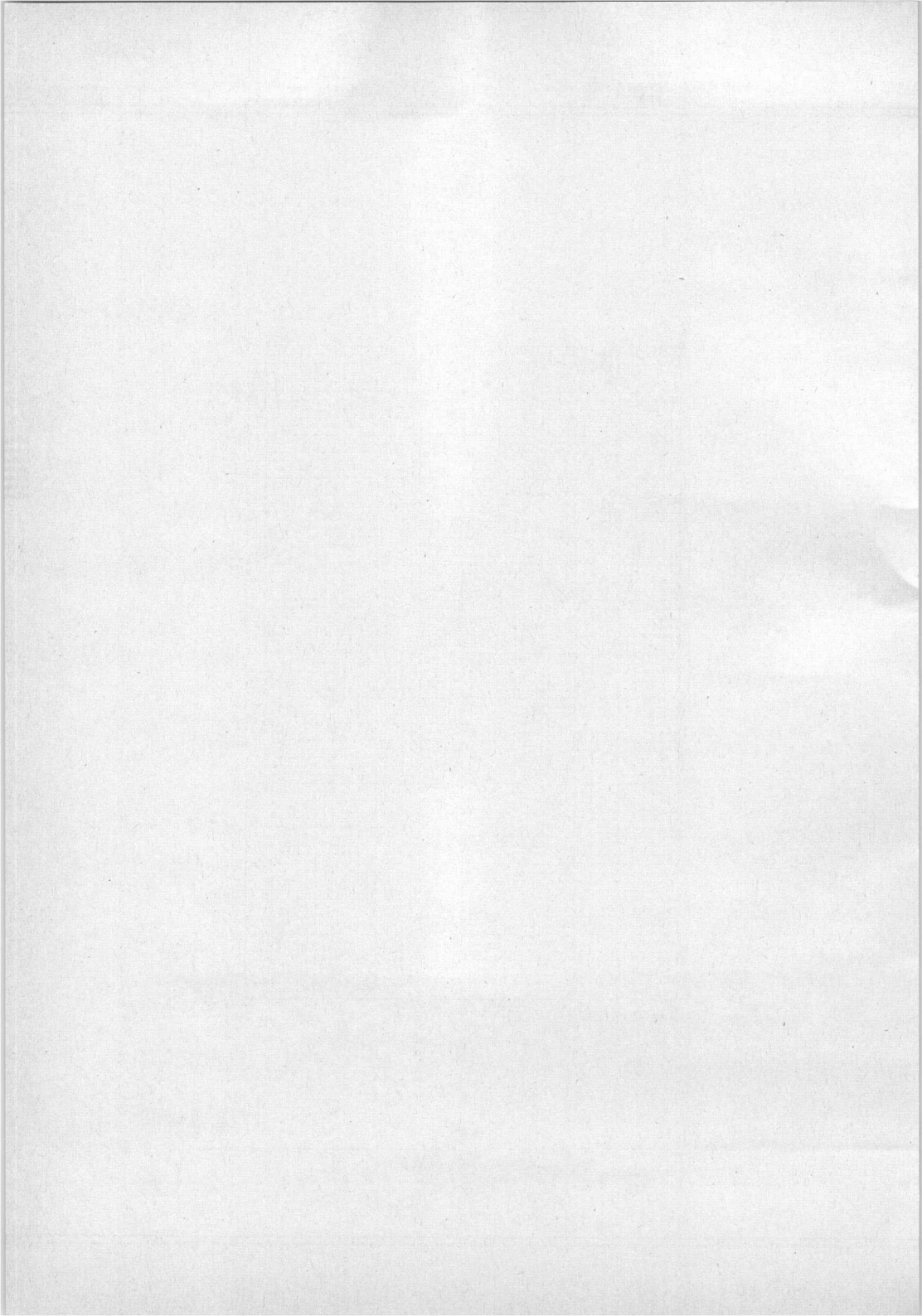

THYRATRON

Xenon-filled triode thyatron intended for use in motor control equipment and similar applications.

QUICK REFERENCE DATA			
Anode voltage, peak forward	V_{ap}	max. 1500	V
peak inverse	V_{invp}	max. 1500	V
Cathode current, average ($T_{av} = \text{max. } 15 \text{ s}$)	I_k	max. 6.4	A
peak	I_{kp}	max. 80	A

HEATING: direct

Filament voltage	V_f	2.5	V \pm 5%
Filament current	I_f	21	A
Waiting time	T_w	min. 60	s

MECHANICAL DATA

Dimensions in mm

Base: Super Jumbo with bayonet

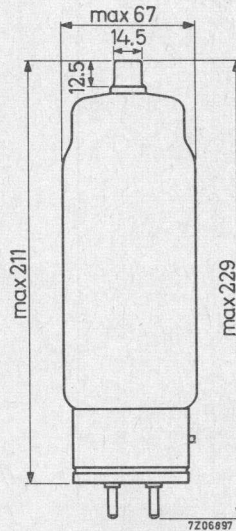
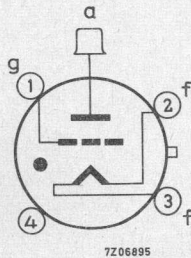

Mounting position: Arbitrary between horizontal and vertical with base down

Accessories

Socket	2422 511 01001
Cap connector	40619

MECHANICAL DATA (continued)

Net weight 340 g

CAPACITANCES

Anode to grid	C_{ag}	0.8 pF
Grid to filament	C_{gf}	45 pF

TYPICAL CHARACTERISTICS

Arc voltage	V_{arc}	12 V
Ionization time	T_{ion}	10 μ s
Recovery time (Deionization time) ($V_g = -250$ V)	T_{dion}	50 μ s
	T_{dion}	500 μ s
		($V_g = -12$ V)

LIMITING VALUES (Absolute max. rating system)

Anode voltage, peak forward	V_{ap}	max. 1500 V
		peak inverse
	V_{invp}	max. 1500 V
Grid voltage, before conduction	$-V_g$	max. 250 V
		during conduction
	$-V_g$	max. 10 V
Surge current ($T = \text{max. } 0.1$ s)	I_{surge}	max. 1120 A
Grid current ($T_{av} = \text{max. } 1$ cycle)	I_g	max. 0.2 A
Cathode current, peak	I_{kp}	max. 80 A
		average ($T_{av} = \text{max. } 15$ s)
	I_k	max. 6.4 A
Grid resistor	R_g	max. 100 $k\Omega$
		min. 0.5 $k\Omega$
	R_g	10 $k\Omega$
Ambient temperature		max. +70 $^{\circ}$ C
	t_{amb}	min. -55 $^{\circ}$ C

7206896

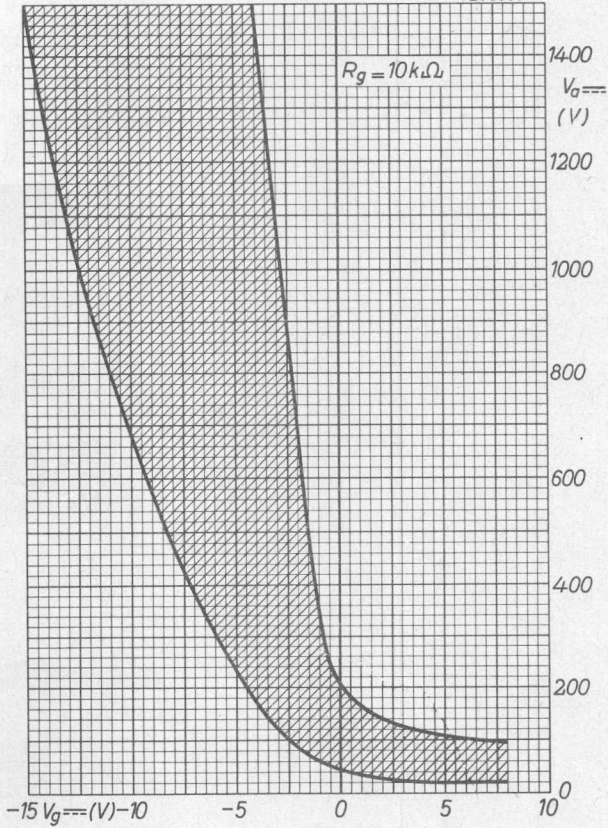

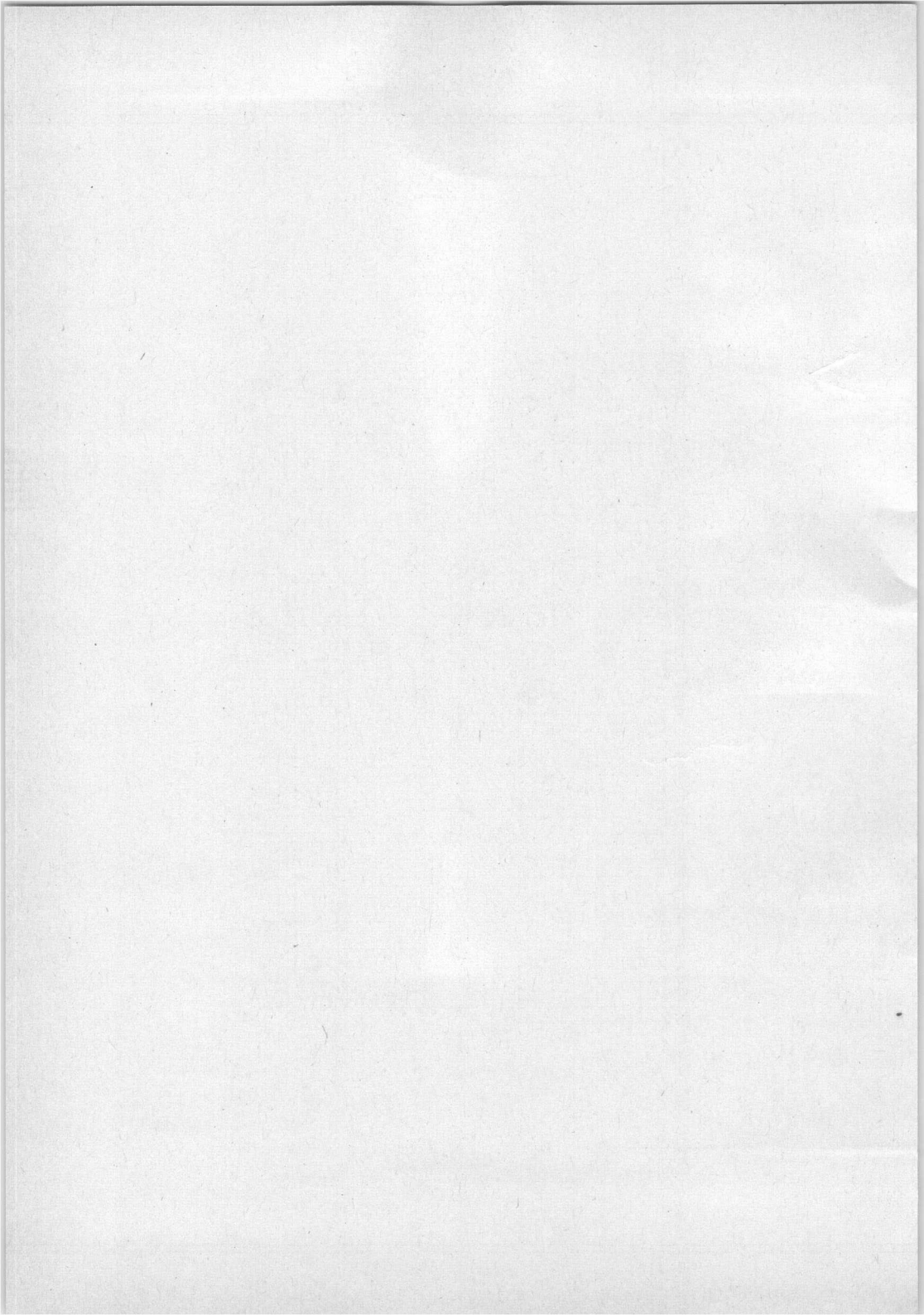

THYRATRON

Thyratron, mercury-vapour triode, for relay service, alarm and protection installations, D.C. and A.C. motor control, circuits for obtaining a variable A.C. output current (inverse parallel circuit), rectifier in a half-wave or full-wave circuit (with or without grid control).

QUICK REFERENCE DATA			
Anode voltage, peak forward	V_{ap}	max. 2500	V
peak inverse	V_{ainvp}	max. 5000	V
Anode current, peak	I_{ap}	max. 2	A
average	I_a	max. 0.5	A

HEATING: direct

Filament voltage	V_f	2.5	V
Filament current	I_f	5.0	A
Waiting time, recommended	T_w	10	s
minimum	T_w	min. 5	s ¹⁾

MECHANICAL DATA

Dimensions in mm

Base: Medium 4p with bayonet

Net weight: 100 g

Mounting position: vertical, base down

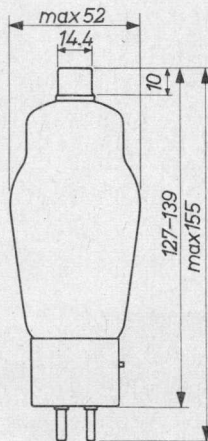
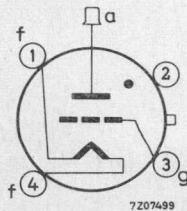

¹⁾ See curve page 4.

CAPACITANCES

Anode to grid	C_{ag}	3.3 pF
Grid to filament	C_{gf}	5.0 pF

TYPICAL CHARACTERISTICS

Arc voltage	V_{arc}	12 V
Ionization time	T_{ion}	10 μ s
Deionization time	T_{dion}	1000 μ s
Frequency	f	max. 150 Hz

LIMITING VALUES (Absolute max. rating system)

Anode voltage, forward peak	V_{ap}	max. 2500 V
inverse peak	V_{ainvp}	max. 5000 V
Grid voltage	$-V_g$	max. 500 V
tube conductive	$-V_g$	max. 10 V
Anode current, peak (f < 25 Hz)	I_{ap}	max. 1 A
(f \geq 25 Hz)	I_{ap}	max. 2 A
average (T_{av} = max. 15 s)	I_a	max. 0.5 A
Grid current, average (T_{av} = max. 15 s)	I_g	max. 0.05 A
Grid circuit resistance	R_g	max. 100 k Ω
recommended value	R_g	10 k Ω
Mercury temperature	t_{Hg}	35 to 80 $^{\circ}$ C
recommended value	t_{Hg}	50 $^{\circ}$ C
Surge current (T = max. 0.1 s)	I_{surge}	max. 40 A

7Z08890

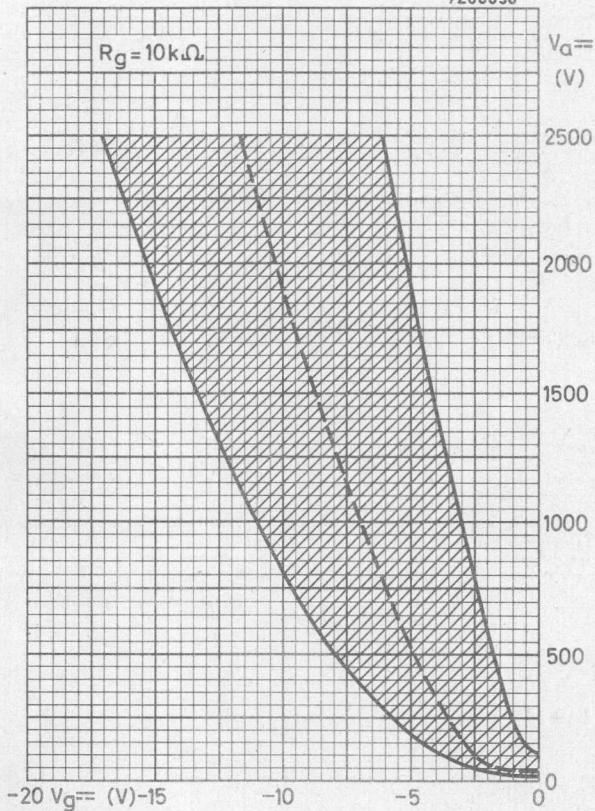

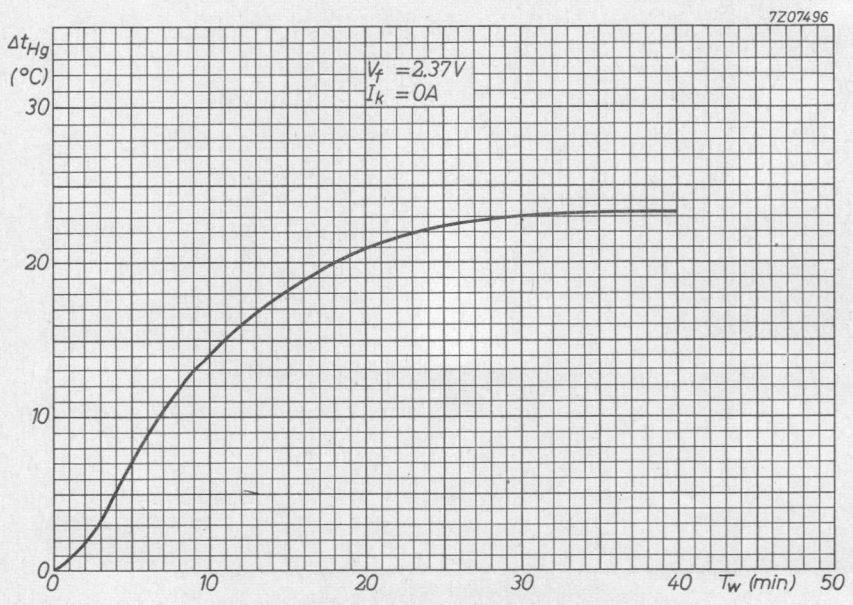
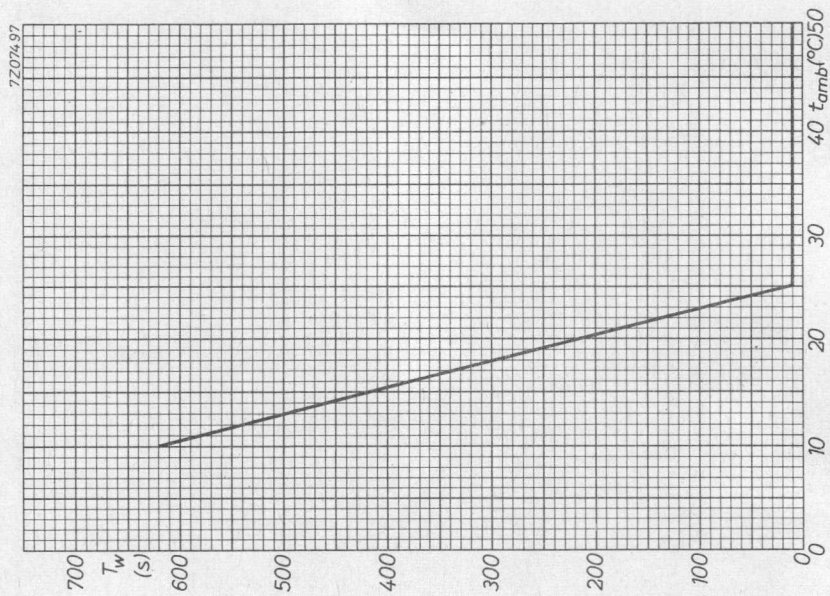

THYRATRON

Thyratron, mercury-vapour triode, for relay service, motor control, variable and stabilised output rectifiers, automatically operated battery chargers. In anti-parallel circuits the tube can also be used for controlling and switching A.C. power and for firing ignitrons.

QUICK REFERENCE DATA		
Anode voltage, peak forward	V_{ap}	max. 1000 V
peak inverse	$V_{ainv p}$	max. 1000 V
Cathode current, peak	I_{kp}	max. 15 A
average	I_k	max. 2.5 A

HEATING: indirect

Heater voltage	V_f	5.0 V $\pm 5\%$
Heater current	I_f	4.5 A
Waiting time	T_w	min. 5 min. ¹⁾

MECHANICAL DATA

Dimensions in mm

Base : Medium 4 p with bayonet

Net weight: 125 g

Mounting position: Vertical, base down

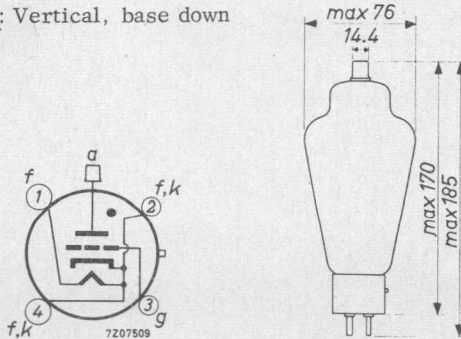

¹⁾ See curve page 3.

CAPACITANCES

Anode to grid	C_{ag}	3.6 pF
Grid to cathode	C_{gk}	7.8 pF

TYPICAL CHARACTERISTICS

Arc voltage	V_{arc}	12 V
Ionisation time	T_{ion}	10 μ s
Deionisation time	T_{dion}	1000 μ s
Frequency	f	max. 150 Hz

LIMITING VALUES (Absolute max. rating system)

Anode voltage, forward peak	V_{ap}	max. 1000 V
inverse peak	V_{ainvp}	max. 1000 V
Grid voltage,	$-V_g$	max. 500 V
tube conductive	$-V_g$	max. 10 V
Cathode current, peak ($f < 25$ Hz)	I_{kp}	max. 5 A
($f \geq 25$ Hz)	I_{kp}	max. 15 A max. 40 A ¹⁾
average ($T_{av} = \text{max. } 15$ s)	I_k	max. 2.5 A max. 1 A ¹⁾
Grid current, average ($T_{av} = \text{max. } 15$ s)	I_g	max. 0.25 A
Grid circuit resistance	R_g	max. 100 k Ω
recommended value	R_g	10 k Ω
Mercury temperature	t_{Hg}	40 to 80 $^{\circ}$ C
recommended value	t_{Hg}	60 $^{\circ}$ C
Surge current ($T = \text{max. } 0.1$ s)	I_{surge}	max. 200 A

1) In firing circuits of ignitrons.

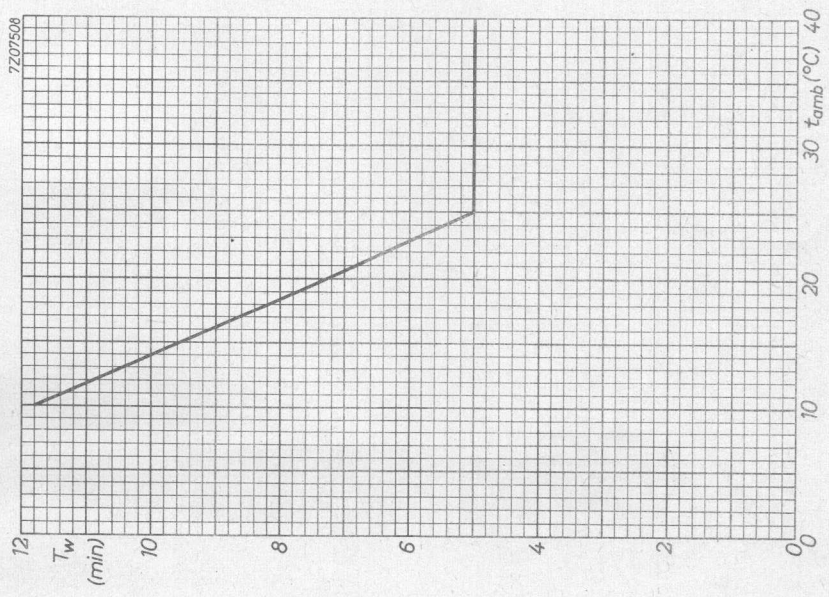
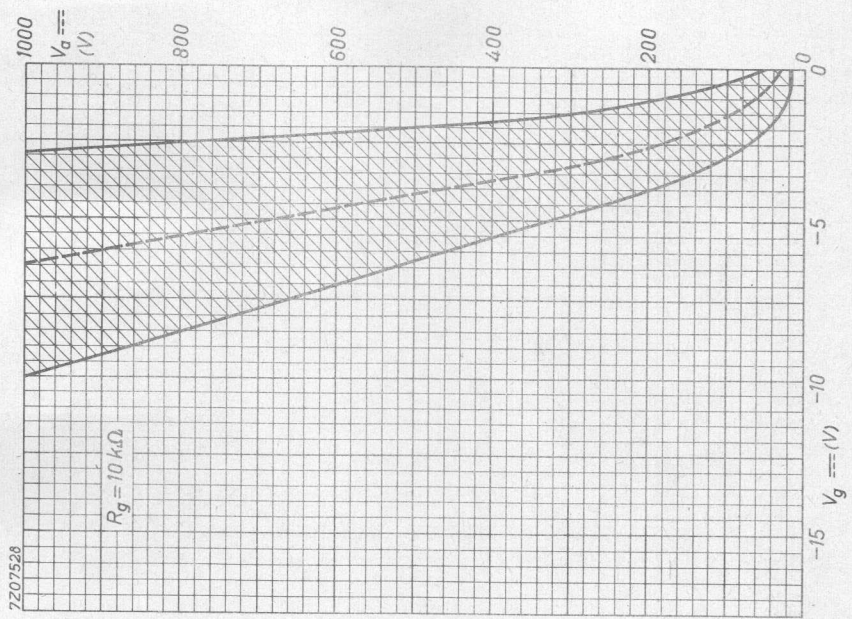

7207506

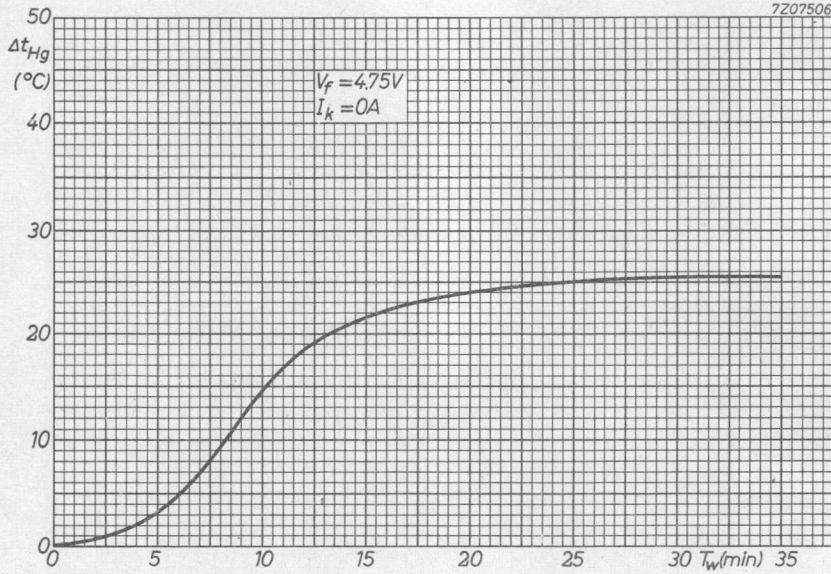

7207507

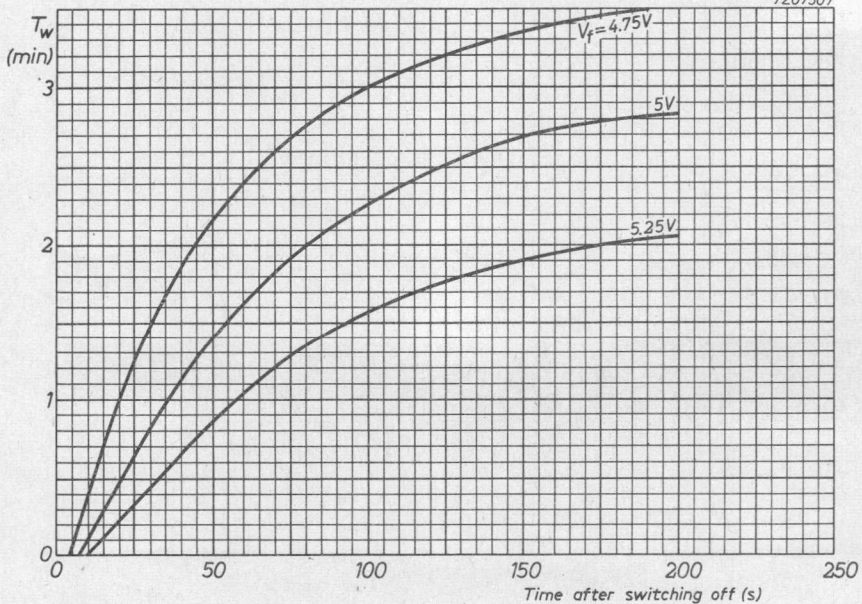

THYRATRON

Thyratron, xenon-filled triode with negative control characteristic, for relay service, motor control, ignitor firing service.

QUICK REFERENCE DATA		
Anode voltage, peak forward	V_{a_p}	max. 1000 V
peak inverse	$V_{a_{inv_p}}$	max. 1250 V
Cathode current, peak	I_{k_p}	max. 30 A
average	I_k	max. 2.5 A

HEATING: direct

Filament voltage	V_f	2.5 V
Filament current	I_f	9 A
Waiting time, recommended	T_w	60 s
minimum	T_w	min. 30 s

MECHANICAL DATA

Dimensions in mm

Base: Medium 4 p with bayonet

Cap connector: 40619

Net weight: 95 g

Mounting position: any

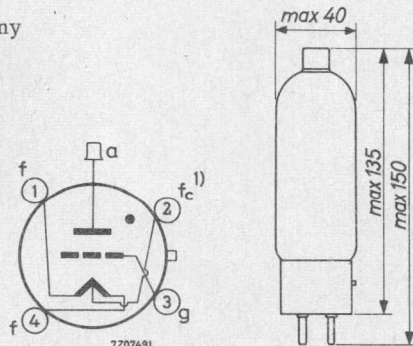

1) Load return

CAPACITANCES

Anode to grid	C_{ag}	3 pF
Grid to filament	C_{gf}	14 pF

TYPICAL CHARACTERISTICS

Arc voltage	V_{arc}	10 V
Ionization time	T_{ion}	10 μs
Deionization time	T_{dion}	1000 μs

LIMITING VALUES (Absolute max. rating system)

Anode voltage, forward peak	V_{ap}	max. 1000 V
inverse peak	V_{invp}	max. 1250 V
Grid voltage	$-V_g$	max. 300 V
up to $V_a = 900$ V and $R_g = 50$ to 100 k Ω	$-V_g$	max. 400 V
tube conductive	$-V_g$	max. 10 V
Cathode current, peak	I_{kp}	max. 30 A
average ($T_{av} = \text{max. } 5$ s)	I_k	max. 2.5 A
Grid current, peak	I_{gp}	max. 0.5 A
average ($T_{av} = 1$ cycle)	I_g	max. 0.1 A
Grid circuit resistance	R_g	10 to 60 k Ω
recommended value	R_g	33 k Ω
Ambient temperature	t_{amb}	-55 to +75 $^{\circ}C$
Surge current ($T = \text{max. } 0.1$ s)	I_{surge}	max. 300 A ¹⁾
Commutation factor		$0.7 \frac{V}{\mu s} \times \frac{A}{\mu s}$

¹⁾ Fuse in anode circuit max. 10 A (recommended 6 A).

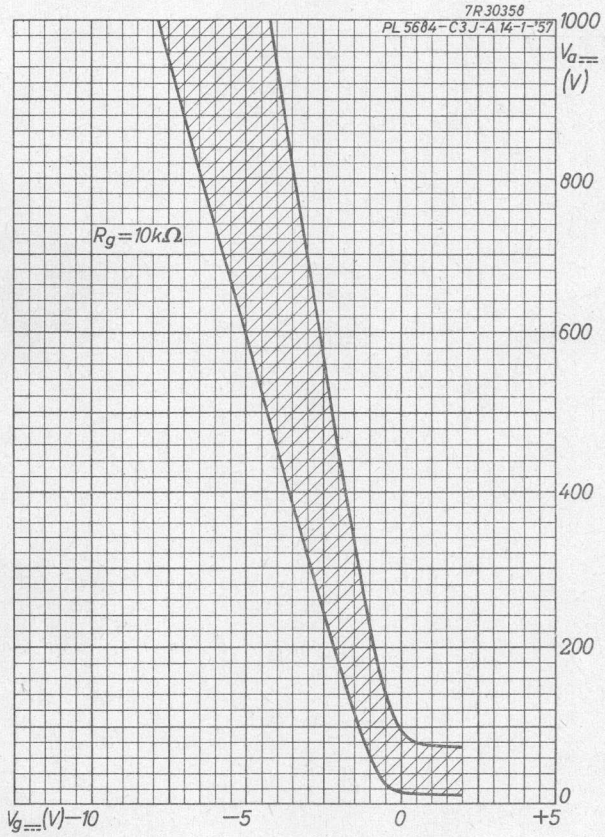

THYRATRON

Thyratron, inert gas-filled tetrode, for relay service, pulse modulator, grid-controlled rectifier service, servo control, ignitron ignition.

The PL5727 is a special quality type, is shock and vibration resistant and designed for use in mobile equipment.

QUICK REFERENCE DATA

Peak anode voltage	$V_{ap} = 650 \text{ V}$
Cathode current, peak	$I_{kp} = 0.5 \text{ A}$
average	$I_k = 0.1 \text{ A}$

HEATING

Indirect by A.C. or D.C.

Heater voltage	$V_f = 6.3 \text{ V}$
Heater current	$I_f = 600 \text{ mA}$
Waiting time	$T_w = 20 \text{ s } ^1)$

CAPACITANCES

Grid No.1 to all	$C_{g1} = 2.4 \text{ pF}$
Anode to all	$C_a = 1.6 \text{ pF}$
Anode to grid No.1	$C_{ag1} = 26 \text{ mpF}$

MECHANICAL DATA

Dimensions in mm

Base : 7 pin miniature

Net weight: 10 g

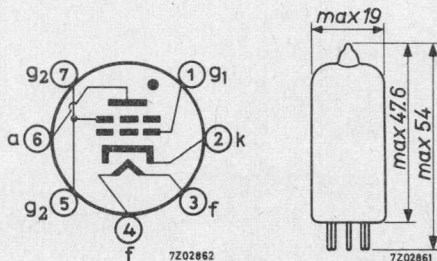

Mounting position: any

1) If urgently wanted T_w may be decreased to min. 10 s.

TYPICAL CHARACTERISTICS

Ionization time

at $V_a = 100$ V, grid No.1 over-voltage = 50 V (substantial square pulse)
Anode peak current during conduction = 0.5 A

$T_{ion} = 0.5 \mu s$

Deionization time

at $V_a = 125$ V, $V_{g1} = -100$ V,
 $R_{g1} = 1000 \Omega$, $I_a = 0.1$ A

$T_{dion} = 35 \mu s$

Deionization time

at $V_a = 125$ V, $V_{g1} = -10$ V,
 $R_{g1} = 1000 \Omega$, $I_a = 0.1$ A

$T_{dion} = 75 \mu s$

Critical grid No.1 current

at $V_a = 125$ V_{RMS}, $I_a = 0.1$ A

$I_{g1} = 0.5 \mu A$

Maintaining voltage

$V_{arc} = 8$ V

Control ratio grid No.1 at striking point

$R_{g1} = 0 \Omega$, $V_{g2} = 0$ V

$\frac{V_a}{V_{g1}} = 250$

Control ratio grid No.2 at striking point

$V_{g1} = 0$ V, $R_{g1} = 0 \Omega$, $R_{g2} = 0 \Omega$

$\frac{V_a}{V_{g2}} = 1000$

OPERATING CONDITIONS for relay service

Anode voltage	$V_{a\sim}$	=	117	400	V _{RMS}
Grid No.2 voltage	V_{g2}	=	0	0	V
Grid No.1 (bias) voltage	$V_{g1\sim}$	=	5	-	V _{RMS} ¹⁾
Grid No.1 (bias) voltage	V_{g1}	=	-	-6	V
Grid No.1 peak (signal) voltage	V_{g1p}	=	5	6	V
Anode circuit resistance	R_a	=	1.2	2.0	k Ω
Grid No.1 circuit resistance	R_{g1}	=	1.0	1.0	M Ω

¹⁾ Phase difference between V_a and V_{g1} approx. 180°.

LIMITING VALUES for relay- and grid controlled service
(Absolute max. rating system)

Anode voltage,

forward peak	V_{ap}	= max. 650 V
inverse peak	V_{ainvp}	= max. 1300 V

Grid No.2 voltage,

peak before conduction	$-V_{g2p}$	= max. 100 V
average during conduction $T_{av} = \text{max. } 30 \text{ s}$	$-V_{g2}$	= max. 10 V

Grid No.1 voltage,

peak before conduction	$-V_{g1p}$	= max. 100 V
average during conduction $T_{av} = \text{max. } 30 \text{ s}$	$-V_{g1}$	= max. 10 V

Cathode current,

peak	I_{kp}	= max. 0.5 A
average, $T_{av} = \text{max. } 30 \text{ s}$	I_k	= max. 0.1 A
surge, $T = \text{max. } 0.1 \text{ s}$	I_{surge}	= max. 10 A

Grid No.2 current,

average, $T_{av} = \text{max. } 30 \text{ s}$	I_{g2}	= max. 10 mA ¹⁾
-----------------------------------------------	----------	----------------------------

Grid No.1 current,

average, $T_{av} = \text{max. } 30 \text{ s}$	I_{g1}	= max. 10 mA
-----------------------------------------------	----------	--------------

Cathode to heater voltage,

k pos., peak	V_{+kf-p}	= max. 100 V
k neg., peak	V_{-kft+p}	= max. 25 V
Heater voltage	V_f	= max. 6.9 V = min. 5.7 V

Ambient temperature

t_{amb}	= min. -75 °C
-----------	---------------

Bulb temperature

t_{bulb}	= max. 150 °C
------------	---------------

CIRCUIT DESIGN VALUES

Grid No.1 circuit resistance	R_{g1}	= max. 10 MΩ
recommended value	R_{g1}	= 1 MΩ

¹⁾ In order not to exceed this maximum value it is recommended to insert a resistor of 1000 Ω in the grid No.2 lead.

LIMITING VALUES for pulse modulator service (Absolute max. rating system)

Anode voltage,	
forward peak	$V_{ap} = \text{max. } 500 \text{ V } ^1)$
inverse peak	$V_{ainvp} = \text{max. } 100 \text{ V}$
Grid No.2 voltage,	
peak before conduction	$-V_{g2p} = \text{max. } 50 \text{ V}$
average during conduction	$-V_{g2} = \text{max. } 10 \text{ V}$
Grid No.1 voltage,	
peak before conduction	$-V_{g1p} = \text{max. } 100 \text{ V}$
average during conduction	$-V_{g1} = \text{max. } 10 \text{ V}$
Cathode current,	
peak	$I_{kp} = \text{max. } 10 \text{ A}$
average	$I_k = \text{max. } 10 \text{ mA}$
rate of change	$dI_k/dT = \text{max. } 100 \text{ A}/\mu\text{s}$
Grid No.2 current, peak	$I_{g2p} = \text{max. } 20 \text{ mA}$
Grid No.1 current, peak	$I_{g1p} = \text{max. } 20 \text{ mA}$
Impulse duration	$T_{imp} = \text{max. } 5 \mu\text{s}$
Impulse repetition frequency	$f = \text{max. } 500 \text{ pps}$
Duty factor	$\delta = \text{max. } 0.001$
Cathode to heater voltage, peak	$V_{kf_p} = \text{max. } 0 \text{ V}$
Heater voltage	$V_f = \text{max. } 6.0 \text{ V}$ $\quad\quad\quad = \text{min. } 6.9 \text{ V}$
Ambient temperature	$t_{amb} = \text{min. } -75 \text{ }^\circ\text{C}$
Bulb temperature	$t_{bulb} = \text{max. } 150 \text{ }^\circ\text{C}$

CIRCUIT DESIGN VALUES

Grid No.2 circuit resistance	$R_{g2} = \text{min. } 2 \text{ k}\Omega$ $\quad\quad\quad = \text{max. } 25 \text{ k}\Omega$
Grid No.1 circuit resistance	$R_{g1} = \text{max. } 500 \text{ k}\Omega$

¹⁾ After completion of an impulse, a 20 μs delay is required before a positive voltage of more than 10 V is applied to the tube.

LIMITING VALUES for use in capacitor discharge circuit for ignitron ignition
(Absolute max. rating system)

See also data sheet ignitron ZX1000 under the heading "Life expectancy"

Anode voltage,

forward peak V_{ap} = max. 650 V

inverse peak V_{ainvp} = max. 100 V

Grid No.2 voltage,

peak before conduction $-V_{g2p}$ = max. 50 V

average during conduction $-V_{g2}$ = max. 10 V

Grid No.1 voltage,

peak before conduction $-V_{g1p}$ = max. 100 V

average during conduction $-V_{g1}$ = max. 10 V

Cathode current,

peak I_{kp} = max. 10 A

average I_k = max. 5 mA

rate of change dI_k/dT = max. 6 A/ μ s

Grid No.2 current, peak I_{g2p} = max. 20 mA

Grid No.1 current, peak I_{g1p} = max. 20 mA

Impulse duration (half sine wave) T_{imp} = max. 15 μ s

Impulse repetition frequency f = max. 60 pps

Cathode to heater voltage, peak V_{kfp} = max. 3 V

Heater voltage V_f = min. 5.7 V
= max. 6.9 V

Ambient temperature t_{amb} = min. -75 °C

Bulb temperature t_{bulb} = max. 150 °C

CIRCUIT DESIGN VALUES

Grid No.2 circuit resistance R_{g2} = min. 1 k Ω
= max. 25 k Ω

Grid No.1 circuit resistance R_{g1} = max. 100 k Ω

SHOCK AND VIBRATION RESISTANCE

These conditions are used solely to assess the mechanical quality of the tube. The tube should not be continuously operated under these conditions.

Shock resistance: 750 g

Forces as applied by the NRL impact machine for electronic devices caused by 5 blows of the hammer lifted over an angle of 48° in each of 4 different positions of the tube.

Vibration resistance: 2.5 g

Vibrational forces for a period of 32 hours at a frequency of 50 Hz in each of 3 directions of the tube.

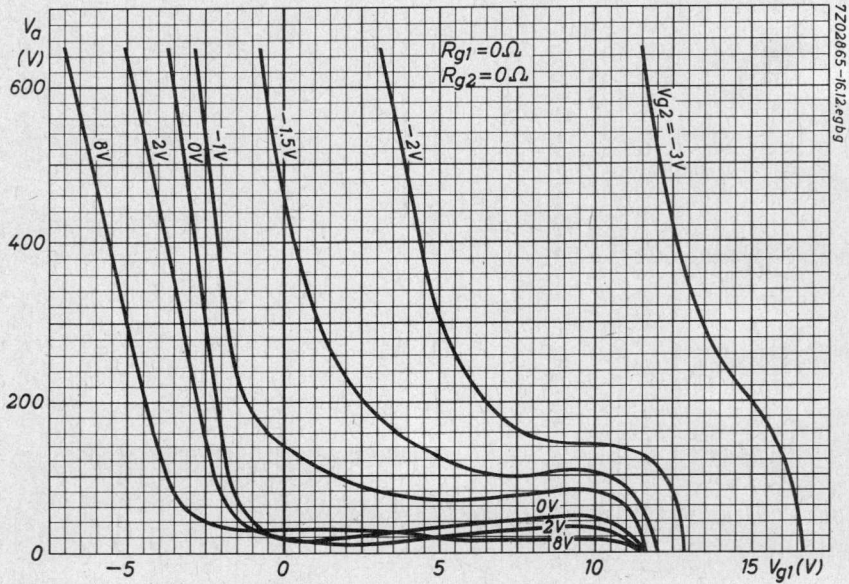

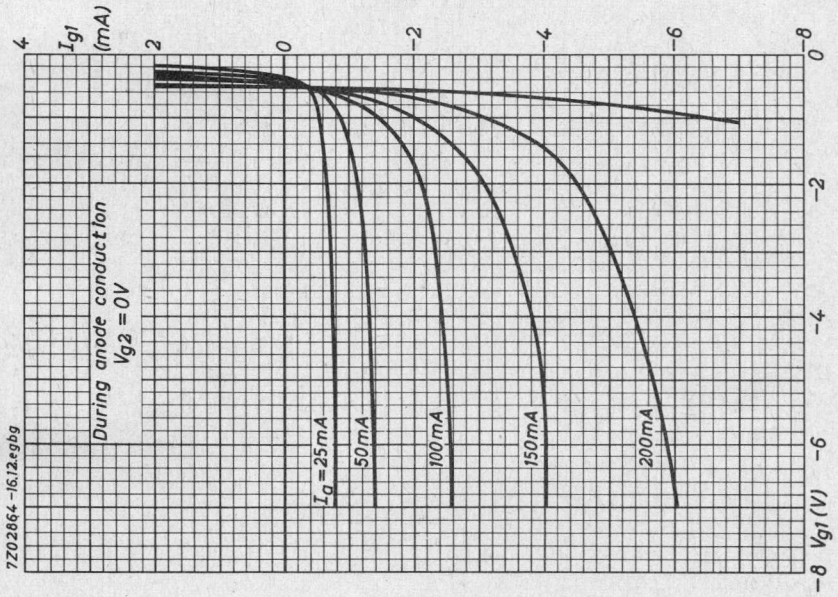
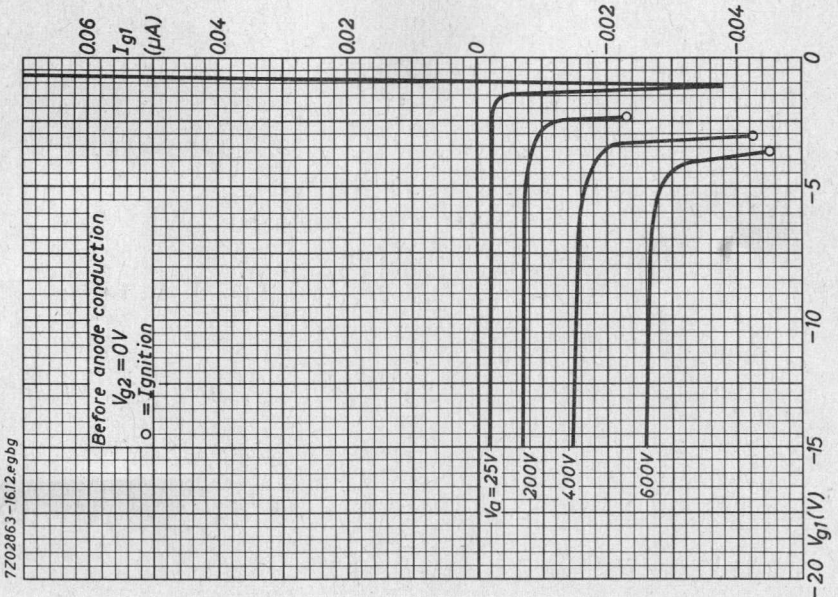

7Z01372/16.12.e.g.b.g

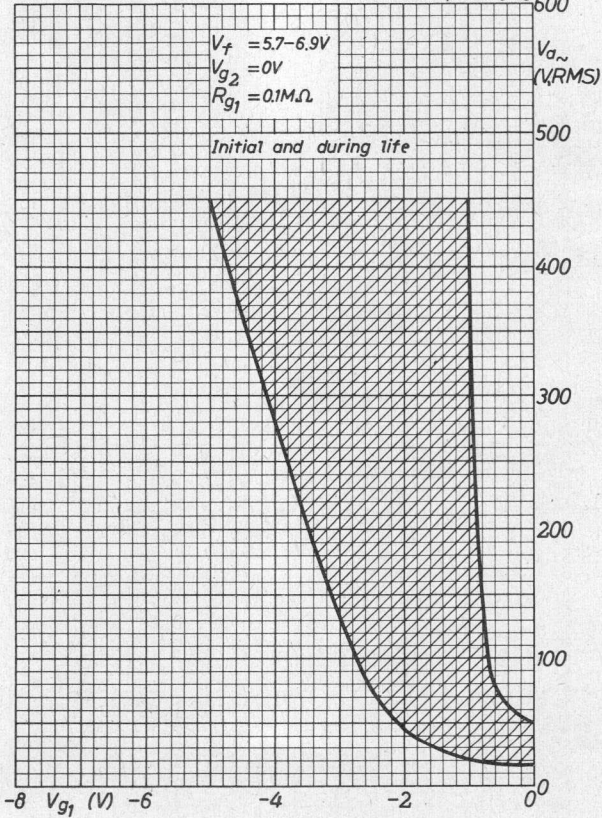

LIMITING VALUES (Absolute max. rating system)

Anode voltage, peak forward	V_{ap}	max. 650	V
peak inverse	V_{ainv_p}	max. 1.3	kV
Grid No. 2 voltage	V_{g2}	max. 100	V
tube conductive	V_{g2}	max. 10	V
Grid No. 1 voltage	$-V_{g1}$	max. 250	V
tube conductive	$-V_{g1}$	max. 10	V
Cathode current, peak	I_{kp}	max. 2	A
average ($T_{av} = \text{max. } 15 \text{ s}$)	I_k	max. 300	mA
Grid No. 1 current, peak	I_{g1p}	max. 1	mA ¹⁾
average ($V_a > -10 \text{ V}$) ($T_{av} = 1 \text{ cycle}$)	I_{g1}	max. 20	mA
Grid No. 2 current ($V_a > -10 \text{ V}$) ($T_{av} = 1 \text{ cycle}$)	I_{g2}	max. 20	mA
Grid No. 1 circuit resistance ($I_k = 200 \text{ mA}$)	R_{g1}	max. 10	MΩ
Ambient temperature	t_{amb}	-75 to +90	°C
Surge current ($T = \text{max. } 0.1 \text{ s}$)	I_{surge}	max. 10	A
Cathode to heater voltage, k pos.	V_{kf}	max. 100	V
k neg.	V_{kf}	max. 25	V



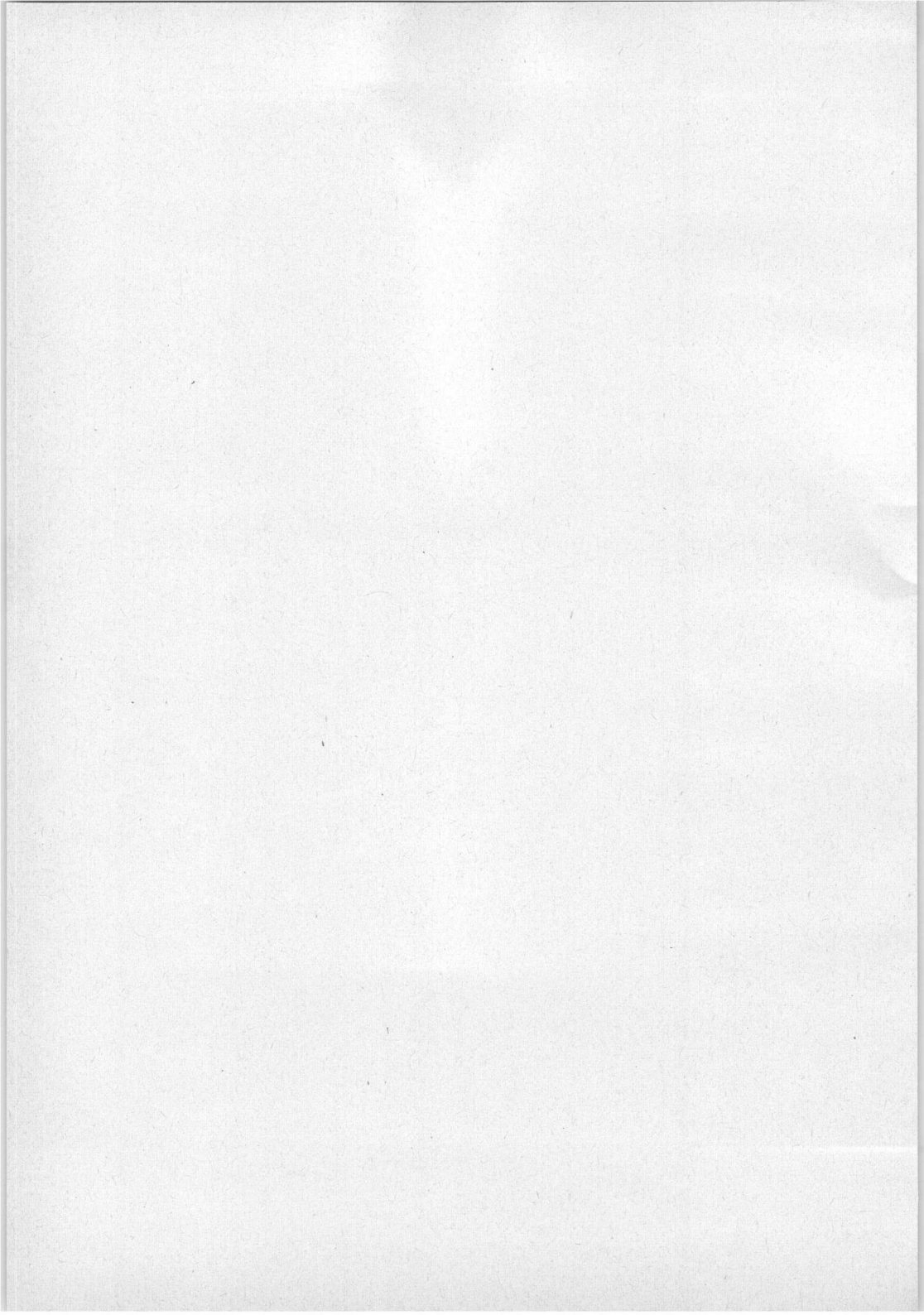

¹⁾ During the period that V_a is more negative than -10 V .

Industrial rectifying tubes





INDUSTRIAL RECTIFYING TUBES

Type	$V_f(V)$ $I_f(A)$	Typical characteristics	Limiting values	Base
328 Double anode rectifier	1,9 3,0	$V_{arc} = 7 V$ $V_{ign} = 16 V$	$V_{ainvp} = 90 V$ $I_a = 0,65 A$ $I_{ap} = 4,0 A$	$R_t = \min 3 \Omega$ $-55 \text{ }^\circ C$ $t_{amb} +75 \text{ }^\circ C$ 
354 Single anode rectifier	1,9 5,5	$V_{arc} = 8 V$ $V_{ign} = 16 V$	$V_{ainvp} = 400 V$ $I_a = 0,25 A$ $I_{ap} = 1,25 A$	$R_t = \min 50 \Omega$ $-55 \text{ }^\circ C$ $t_{amb} +75 \text{ }^\circ C$ Edison
367 Double anode rectifier	1,9 8,0	$V_{arc} = 9 V$ $V_{ign} = 16 V$	$V_{ainvp} = 140 V$ $I_a = 3 A$ $I_{ap} = 18 A$	$R_t = \min 1 \Omega$ $-55 \text{ }^\circ C$ $t_{amb} +75 \text{ }^\circ C$ 
451 Double anode rectifier	1,9 2,8	$V_{arc} = 7 V$ $V_{ign} = 11 V$	$V_{ainvp} = 50 V$ $I_a = 0,65 A$ $I_{ap} = 4,0 A$	$R_t = \min 3 \Omega$ $t_{Hg} = 30-75 \text{ }^\circ C$ 
1010 Double anode rectifier	1,9 3,5	$V_{arc} = 9 V$ $V_{ign} = 16 V$	$V_{ainvp} = 185 V$ $I_a = 0,65 A$ $I_{ap} = 4,0 A$	$R_t = \min 10 \Omega$ $-55 \text{ }^\circ C$ $t_{amb} +75 \text{ }^\circ C$ 
1037 Double anode rectifier	1,9 11	$V_{arc} = 9 V$ $V_{ign} = 16 V$	$V_{ainvp} = 185 V$ $I_a = 3,0 A$ $I_{ap} = 18 A$	$R_t = \min 1,75 \Omega$ $t_{Hg} = 30-80 \text{ }^\circ C$ Goliath
1039 Double anode rectifier	1,9 20	$V_{arc} = 9 V$ $V_{ign} = 16 V$	$V_{ainvp} = 185 V$ $I_a = 7,5 A$ $I_{ap} = 45 A$	$R_t = \min 0,75 \Omega$ $t_{Hg} = 30-80 \text{ }^\circ C$ Goliath
1049 Double anode rectifier	1,9 28,5	$V_{arc} = 9 V$ $V_{ign} = 16 V$	$V_{ainvp} = 185 V$ $I_a = 12,5 A$ $I_{ap} = 75 A$	$R_t = \min 0,3 \Omega$ $t_{Hg} = 30-80 \text{ }^\circ C$ Straps
1054 Double anode rectifier	1,9 68	$V_{arc} = 9 V$ $V_{ign} = 16 V$	$V_{ainvp} = 150 V$ $I_a = 20 A$ $I_{ap} = 120 A$	$R_t = \min 0,18 \Omega$ $t_{Hg} = 30-80 \text{ }^\circ C$ Straps
1069K Double anode rectifier	3,25 70	$V_{arc} = 10 V$ $V_{ign} = 16 V$	$V_{ainvp} = 170 V$ $I_a = 30 A$ $I_{ap} = 200 A$	$R_t = \min 0,12 \Omega$ $t_{Hg} = 30-75 \text{ }^\circ C$ Straps

**INDUSTRIAL
RECTIFYING TUBES**

Type	$V_f(V)$ $I_f(A)$	Typical characteristics	Limiting values	Base	
1110 Double anode rectifier	1,9 3,5	$V_{arc} = 9 V$ $V_{ign} = 16 V$	$V_{ainvp} = 185 V$ $I_a = 0,85 A$ $I_{ap} = 5,0 A$	$R_t = \min 4 \Omega$ $-55 \text{ }^\circ\text{C}$ $t_{amb} +75 \text{ }^\circ\text{C}$	
1119 Double anode rectifier	1,9 5,8	$V_{arc} = 9 V$ $V_{ign} = 16 V$	$V_{ainvp} = 140 V$ $I_a = 1,5 A$ $I_{ap} = 9,0 A$	$R_t = \min 1,8 \Omega$ $-55 \text{ }^\circ\text{C}$ $t_{amb} +75 \text{ }^\circ\text{C}$	
1138 Single anode rectifier	2,5 27	$V_{arc} = 10 V$ $V_{ign} = 16 V$	$V_{ainvp} = 275 V$ $I_a = 15 A$ $I_{ap} = 85 A$	$R_t = \min 0,3 \Omega$ $t_{Hg} = 30-80 \text{ }^\circ\text{C}$	Goliath
1163 Single anode rectifier	2,25 17	$V_{arc} = 9 V$ $V_{ign} = 16 V$	$V_{ainvp} = 375 V$ $I_a = 6 A$ $I_{ap} = 36 A$	$R_t = \min 0,5 \Omega$ $-55 \text{ }^\circ\text{C}$ $t_{amb} +75 \text{ }^\circ\text{C}$	Goliath
1164 Single anode rectifier	2,5 25	$V_{arc} = 9 V$ $V_{ign} = 16 V$	$V_{ainvp} = 225 V$ $I_a = 15 A$ $I_{ap} = 90 A$	$R_t = \min 0,3 \Omega$ $-55 \text{ }^\circ\text{C}$ $t_{amb} +75 \text{ }^\circ\text{C}$	Goliath
1173 Single anode rectifier	1,9 13	$V_{arc} = 12 V$ $V_{ign} = 22 V$	$V_{ainvp} = 850 V$ $I_a = 4 A$ $I_{ap} = 20 A$	$R_t = \min 0,75 \Omega$ $t_{Hg} = 30-75 \text{ }^\circ\text{C}$	
1174 Single anode rectifier	1,9 12	$V_{arc} = 12 V$ $V_{ign} = 22 V$	$V_{ainvp} = 850 V$ $I_a = 6 A$ $I_{ap} = 30 A$	$R_t = \min 0,5 \Omega$ $t_{Hg} = 30-75 \text{ }^\circ\text{C}$	
1176 Single anode rectifier	1,9 28	$V_{arc} = 12 V$ $V_{ign} = 22 V$	$V_{ainvp} = 850 V$ $I_a = 15 A$ $I_{ap} = 75 A$	$R_t = \min 0,2 \Omega$ $t_{Hg} = 30-75 \text{ }^\circ\text{C}$	Straps
1177 Single anode rectifier	1,9 60	$V_{arc} = 12 V$ $V_{ign} = 28 V$	$V_{ainvp} = 850 V$ $I_a = 25 A$ $I_{ap} = 135 A$	$R_t = \min 0,1 \Omega$ $t_{Hg} = 30-75 \text{ }^\circ\text{C}$	Straps
1710 Double anode rectifier	1,9 8,0	$V_{arc} = 10 V$ $V_{ign} = 22 V$	$V_{ainvp} = 470 V$ $I_a = 1,5 A$ $I_{ap} = 9,0 A$	$R_t = \min 2,5 \Omega$ $t_{Hg} = 30-80 \text{ }^\circ\text{C}$	
1725A Double anode rectifier	1,9 3,5	$V_{arc} = 10 V$ $V_{ign} = 22 V$	$V_{ainvp} = 470 V$ $I_a = 0,65 A$ $I_{ap} = 4,0 A$	$R_t = \min 5 \Omega$ $-55 \text{ }^\circ\text{C}$ $t_{amb} +75 \text{ }^\circ\text{C}$	
1738 Double anode rectifier	1,9 18	$V_{arc} = 9 V$ $V_{ign} = 20 V$	$V_{ainvp} = 300 V$ $I_a = 7,5 A$ $I_{ap} = 45 A$	$R_t = \min 0,2 \Omega$ $t_{Hg} = 30-80 \text{ }^\circ\text{C}$	Goliath

**INDUSTRIAL
RECTIFYING TUBES**

Type	$V_f(V)$ $I_f(A)$	Typical characteristics	Limiting values		Base
1749A Double anode rectifier	1,9 25	$V_{arc} = 10 V$ $V_{ign} = 22 V$	$V_{ainvp} = 300 V$ $I_a = 12,5 A$ $I_{ap} = 75 A$	$R_t = \min 0,1 \Omega$ $t_{Hg} = 30-80 ^\circ C$	Straps
1788 Double anode rectifier	1,9 11	$V_{arc} = 9 V$ $V_{ign} = 22 V$	$V_{ainvp} = 300 V$ $I_a = 5 A$ $I_{ap} = 30 A$	$R_t = \min 0,3 \Omega$ $t_{Hg} = 30-80 ^\circ C$	Goliath
1838 Double anode rectifier	1,9 21,5	$V_{arc} = 10 V$ $V_{ign} = 22 V$	$V_{ainvp} = 360 V$ $I_a = 7,5 A$ $I_{ap} = 45 A$	$R_t = \min 0,25 \Omega$ $t_{Hg} = 30-80 ^\circ C$	
1849 Double anode rectifier	1,9 29	$V_{arc} = 10 V$ $V_{ign} = 22 V$	$V_{ainvp} = 360 V$ $I_a = 12,5 A$ $I_{ap} = 75 A$	$R_t = \min 0,2 \Omega$ $t_{Hg} = 30-80 ^\circ C$	Straps
1859 Double anode rectifier	1,9 60	$V_{arc} = 12 V$ $V_{ign} = 28 V$	$V_{ainvp} = 360 V$ $I_a = 25 A$ $I_{ap} = 150 A$	$R_t = \min 0,1 \Omega$ $t_{Hg} = 30-80 ^\circ C$	Straps

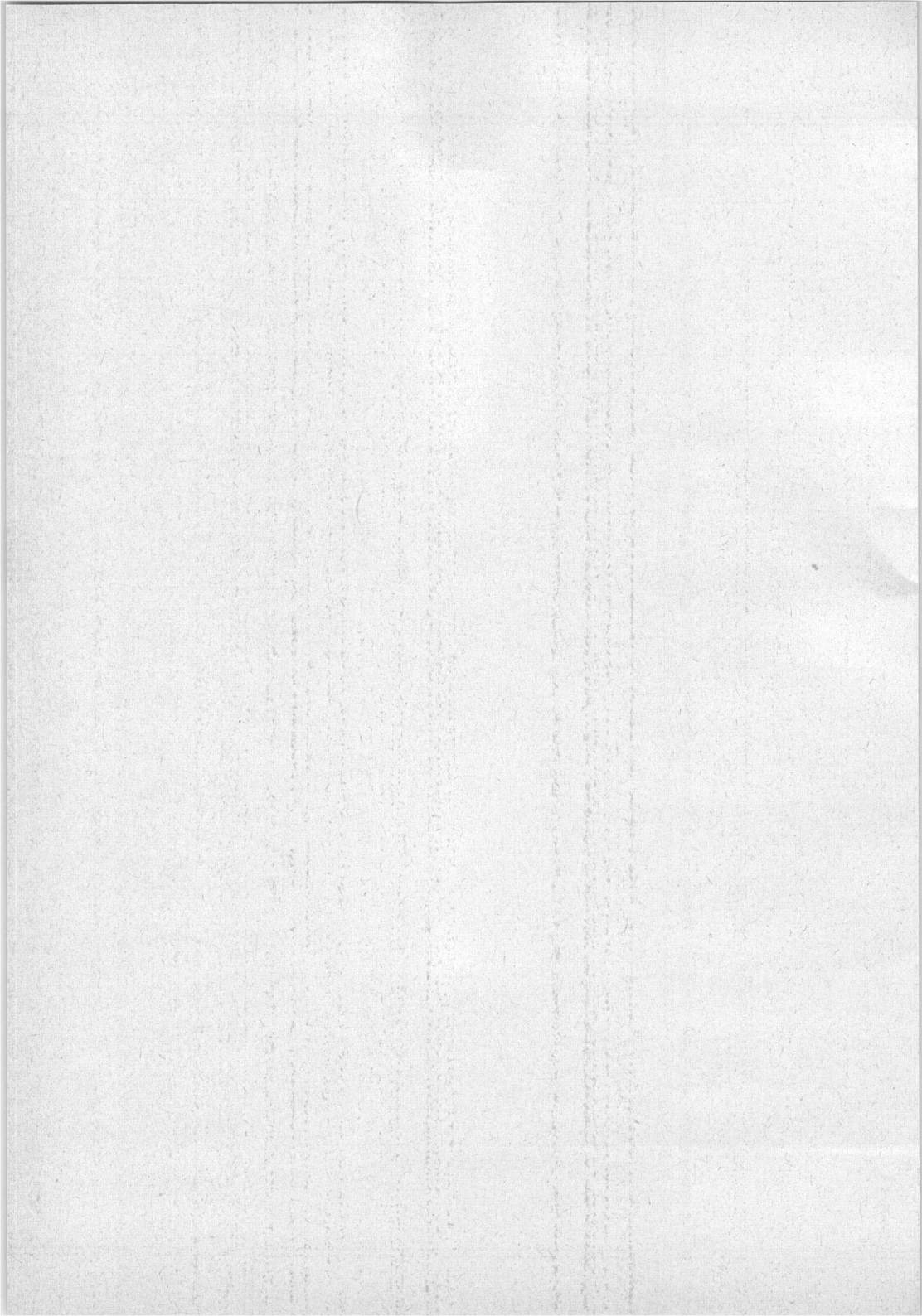

Ignitrons



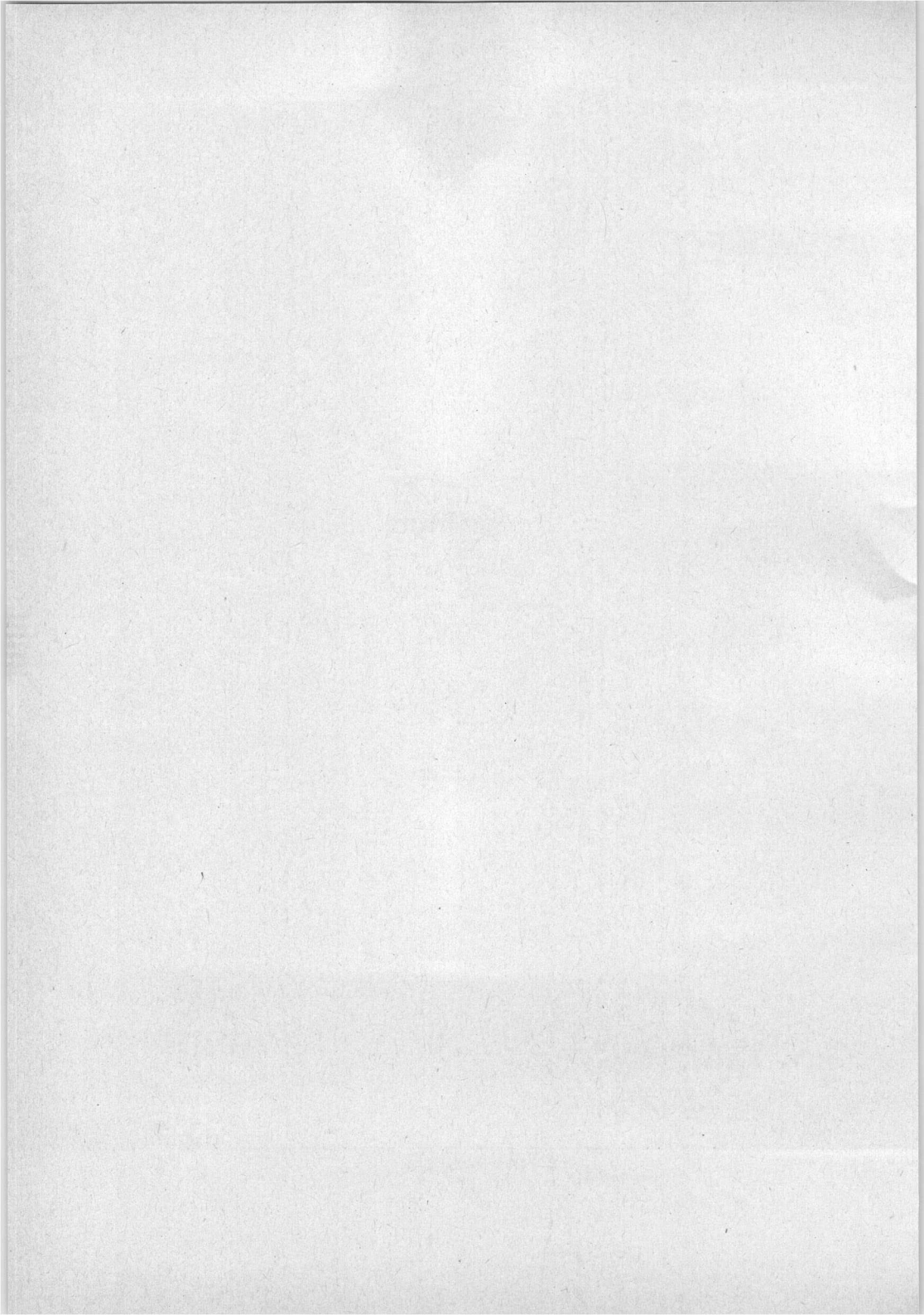

GENERAL OPERATIONAL RECOMMENDATIONS IGNITRONS

The following instructions and recommendations are generally applicable to all ignitron types. When there are variations for a particular type of tube, specific recommendations are given on the appropriate data sheets.

The absolute maximum rating system is used for ignitrons.

MOUNTING

Ignitrons must be mounted vertically the cathode terminal facing downwards. The tubes should be mounted so that the leads and supporting members do not impose stresses on the metal-to-glass seals.

The cross-section of the tube supports should be sufficient to bear the weight of the tube and to carry the required current.

The tube cathode connection must be fixed to its support by means of steel bolts, which should be well tightened.

The anode cable must be fixed to the corresponding terminal on the apparatus using a steel bolt.

Where applicable the anode cable must also be connected to the tube lead-in with a steel bolt using two wrenches.

A check should be made periodically to ensure that the bolts are securely fixed and the contact surfaces still clean. This must be done in any case after the first few hours of operation following the installation of a new tube. Discoloration of the contact area is indicative of a poor contact.

In making the cathode and ignitor connections, care should be taken not to damage the ignitor lead-in. It is recommended to use the ignitor cable supplied by the manufacturer.

Ignitrons are mechanically strong and will withstand moderate shocks. Operation will be most stable however, if they are protected against shock and vibration which would disturb the surface of the mercury pool and tend to change the tube operating characteristics.

Ignitrons must be shielded against strong R. F. and magnetic fields.

WATER COOLING

The cooling water must satisfy the following requirements as regards the content of solids and soluble chemicals:

1. pH 7 to 9
2. Max. weight of chlorides per litre 15 mg.
Max. weight of nitrates per litre 25 mg.
Max. weight of sulphates per litre 25 mg.
3. Max. weight of insoluble solids per litre 25 mg.
4. Total hardness max. 10 German degrees/18 French degrees/12.5 English degrees/10.5 US degrees.
5. Specific resistance min. 2000 Ω cm.

In most cases tap-water will satisfy these requirements. If the water locally available is unsuitable a system of cooling employing a heat exchanger with sufficient suitable water in circulation can alternatively be used.

The temperature of the cooling water should be at least 10 °C.

The water-hoses must be of electrically insulating material and should be connected to the ignitrons so that the water enters the water jacket at the bottom and leaves it at the top. Up to 3 tubes may be cooled in series. The hoses should have a length of at least 50 cm in order to ensure that the electrical resistance of the internal water column is sufficiently high. They should be fixed by means of clamps to the hose nipples, care being taken that no leakage can occur. The water must be allowed to flow freely from the last tube into a funnel, which enables the water flow to be easily checked and prevents the water pressure in the jackets from becoming excessive. The water pressure in the tube jackets should never exceed 3.5 atm (50 pounds/square inch).

The water jackets of ignitrons are normally connected to the mains and thus have mains potential to earth. When thermostatic switches are used they must therefore be capable of withstanding this operating voltage. Should the thermostat not be rated for mains voltages an isolating step-down transformer can be used to protect it from damage.

The tubes should not be put into operation until all air is removed from the cooling system and filling completed. This is indicated by water flowing from the outlet pipe on the last tube.

The cooling system should be installed so that the water jackets are not emptied by the water flowing or syphoning away. As an aid to ensuring that the tubes have been correctly installed a useful test is to momentarily close the stop valve after filling and check that after a brief interval the outflow of water ceases. A continuous flow of water when the stop valve is closed is evidence of faulty installation and may result in the tubes being completely drained when the equipment is finally shut down. When recommencing operations unless an interval is allowed for refilling this may endanger the tubes.

Important note

In the tube data, ratings are given for the required waterflow as a function of the average tube current and water inlet temperature. It is often more economical to use continuous water cooling according to the reduced cooling ratings rather than a water saving thermostat and solenoid valve. This enables a more constant tube temperature to be obtained which, moreover improves the life expectancy of the tube.

TUBE PROTECTION

Care must be taken to ensure that the prescribed temperature limits of ignitrons are never exceeded. When the tubes are cooled with tapwater the temperature of which remains within the rated limits, it is generally sufficient to ensure that an adequate quantity of water flows through the jacket. To prevent the temperature of the tubes becoming excessive in the event of a failure of the water supply, e.g.: stopped-up or defective hoses, insufficient pressure of the water mains, accidentally closed main cock etc. a protecting thermostat should be used. If the temperature limit set by the protecting thermostat is exceeded either the ignition circuits of the ignitrons are interrupted or the main circuit breaker is tripped by means of a relay. The protecting thermostat, which should be mounted on the last tube of a series, should not actuate its relay under normal operating conditions.

In a three phase welding service using 6 tubes it is recommended that not more than 3 tubes are connected hydraulically in series for cooling purposes. When ignitrons are used for heavy power switching at a high duty factor the internal tube temperature rises very rapidly. Under such conditions it is advisable for the cooling water to circulate through the jackets as soon as the master switch is closed.

Note

When ignitrons are used as rectifiers with the cathode not at earth potential, an electrolytic erosion target connected to the metal envelope may be used to avoid corrosion of tube parts.

SWITCHING

Before firing and during operation the anode and lead-in insulator should always be at a higher temperature than the cooling water. If necessary, a suitable heating device can be used to maintain the required temperature difference.

Care must be taken not to touch live parts, such as the water jackets which are at full line voltage. Some tube types have a plastic-coated water jacket which can withstand voltages up to 3 kV. With this type water condensation on the jacket is kept to a minimum under conditions of high humidity and low cooling water temperature. The uncoated tube parts are at full line voltage.

To prevent mercury from re-condensing on the anode and the anode insulator when the installation is switched off, the cooling water should be allowed to flow through the tubes so that all internal parts are evenly cooled down; this normally takes from 15 to 30 minutes.

Incompletely cooled tubes must always be kept with the anode connection uppermost.

Mercury may also condense on the anode insulator as a result of cold air draught in the vicinity of the tube. It is then necessary either to prevent the occurrence of the air flow or to ensure that the anode and anode insulator are not cooled down to a temperature below that of the cooling water.

SPARE TUBES

In order to have some tubes available in a ready-for-use condition it is advisable to place an adequate number of tubes with the anodes uppermost under a lighted incandescent lamp. The heat produced by the lamp is sufficient to remove any mercury deposits on the anode insulator.

TUBE RATINGS

Parameters of the particular ignitron type are the demand and max. average currents.

The demand is the total permissible power which an ignitron contactor can handle in a single-phase control system (acting as a power switch). It is equal to the product of the R.M.S. values of line voltage and contactor current.

The max. average current is valid for a limited demand (or peak current) only. For higher demands or higher peak currents the permissible average current must be reduced as indicated on the particular derating curve.

The longest time over which the max. average current may be calculated is the max. averaging time.

Diagram showing the relationship between max. average anode current and demand or peak anode current respectively:

- a) Max. average anode current for lower demand or peak currents.
- b) Demand (peak current) up to which this value applies.
- c) Max. average current at max. demand or peak current.

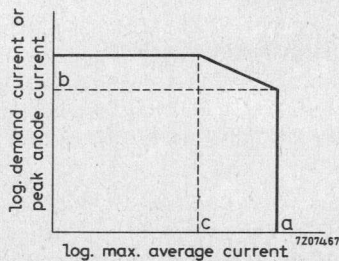

All data assumes full cycle conduction with an equally distributed load on all ignitrons, regardless of whether phase control is used.

The load must be limited so that at zero phase delay no overload will result. The parameters of a particular ignitron give the derived values, depending on line voltage. The parameters may be calculated as follows:

$$1) \text{ Demand current: } I_{\text{RMS}} = \frac{P \text{ (kVA)}}{V \text{ (V}_{\text{RMS}})} \cdot 1000 \text{ (A}_{\text{RMS}}) \quad \begin{array}{l} P = \text{demand} \\ V = \text{line voltage} \end{array}$$

$$2) \text{ Max. duty factor: } \delta = 2.22 \frac{I_{\text{AV}}}{I_{\text{RMS}}} \cdot 100 \text{ (\%)} \quad I_{\text{AV}} = \text{max. av. current}$$

3) Max. number of cycles within max. averaging time:

$$n = f \cdot \frac{\delta}{100} \cdot T_{\text{AVmax}} \quad f = \text{mains frequency}$$

4) Integrated R.M.S. load current:

$$I_{\text{F}} = I_{\text{RMS}} \cdot \sqrt{\frac{\delta}{100}} \text{ (A}_{\text{RMS}})$$

The tube parameters are tabulated for every ignitron type at several values of mains voltage.

IGNITOR RATINGS

The ignitor of an ignitron should never carry a negative current, i.e. current resulting from the ignitor being negative with respect to cathode.

The possibility of this occurring can be avoided by incorporating a rectifying element in the ignitor circuit.

The ignitor current and voltage required to ensure reliable firing of the tube is given on the ignitron data sheet. In addition, maximum limiting values are quoted which must not be exceeded.

IGNITION CIRCUITS

Two types of excitation are in common use:

A. Self (anode) excitation used in single phase resistance welding and similar applications.

B. Separate excitation used in all other applications.

Typical examples are given in fig.1 (self excitation) and fig.2 (separate excitation).

For both circuits two fuses, F_1 and F_2 are recommended.

F_1 safeguards the ignition circuit; F_2 is connected directly in series with the ignitor, protecting it against shorting between the main anode and ignition circuits.

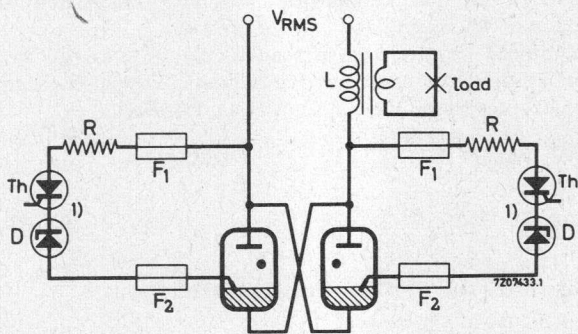

Fig.1

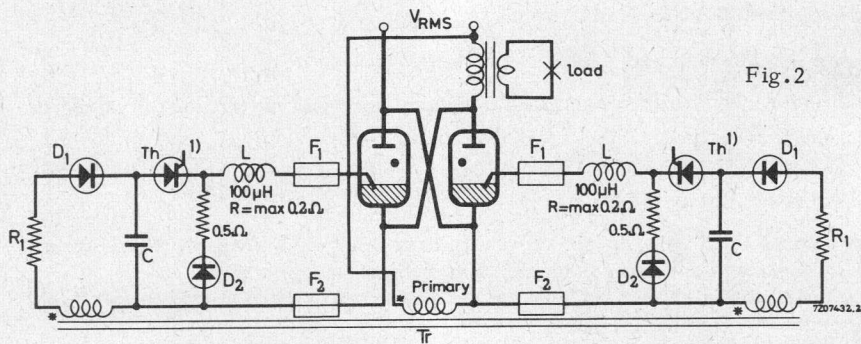

Fig.2

* Indicate identical phase

The ignitor must be connected to its control circuit by a screened lead which affords protection against R.F. fields. It is inadvisable to operate separate excitation in the absence of anode mains voltage.

A. Anode excitation (fig.1)

The "Ignitor voltage required to fire", must not be interpreted as the instantaneous value of mains voltage at the instant of ignition, but as the voltage measured between the ignitor lead-in and cathode. The values of the resistors in the ignition circuit and the level of supply voltage should be chosen so that the prescribed value of voltage is applied to the ignitor.

Recommended values of R are given in the data sheets. Deviations from these recommended values may impair the performance of the tube.

To ensure a short and reproducible delay between the firing of the ignitor and anode take-over, the rate of rise of ignition current must be sufficiently high. The current rise time is mainly determined by the reactance of the load and at high load reactances it may be too small for proper ignition. In such circumstances separate excitation can be successfully used.

B. Separate excitation (fig. 2)

With separate excitation ignition of the ignitron is independent of the anode circuit parameters. This method is therefore suitable for rectifiers and for A.C. control circuits where the available voltage at the desired ignition angle is, or is very nearly, below the required minimum value for reliable firing.

AUXILIARY ANODE CIRCUIT

When a rectifier feeds a load which generates a back e.m.f., the available voltage between the main anode and cathode will often be insufficient to ensure takeover of the arc discharge when the tube is fired. Moreover, if the ignition current is too small, the main discharge may cease prematurely.

For this reason ignitrons designed for use in rectifying equipment are provided with an auxiliary anode which maintains the arc discharge during the period when the main anode voltage falls below the minimum value necessary for continued conduction of the tube. The auxiliary anode should be connected to a low voltage A.C. source so that auxiliary anode current flows throughout tube conduction.

MAIN CIRCUIT

When the main discharge of an ignitron is interrupted voltage transients are produced in the transformer primary due to its self-inductance, which may puncture the insulation of the transformer.

In resistance welding circuits the transients may be reduced by a damping resistor mounted across the transformer primary terminals. The values of the current drawn by this resistor are determined by the duty factor of the machine.

In rectifier circuits damping is obtained by a series R.C. circuit shunted across the transformer primary.

Cathode and/or anode breakers are usually required in addition to the supply switches, particularly when back e.m.f.'s are present.

IGNITRONS

PL5551A	Replaced by ZX1051
PL5552A	Replaced by ZX1052
PL5553B	Replaced by ZX1053



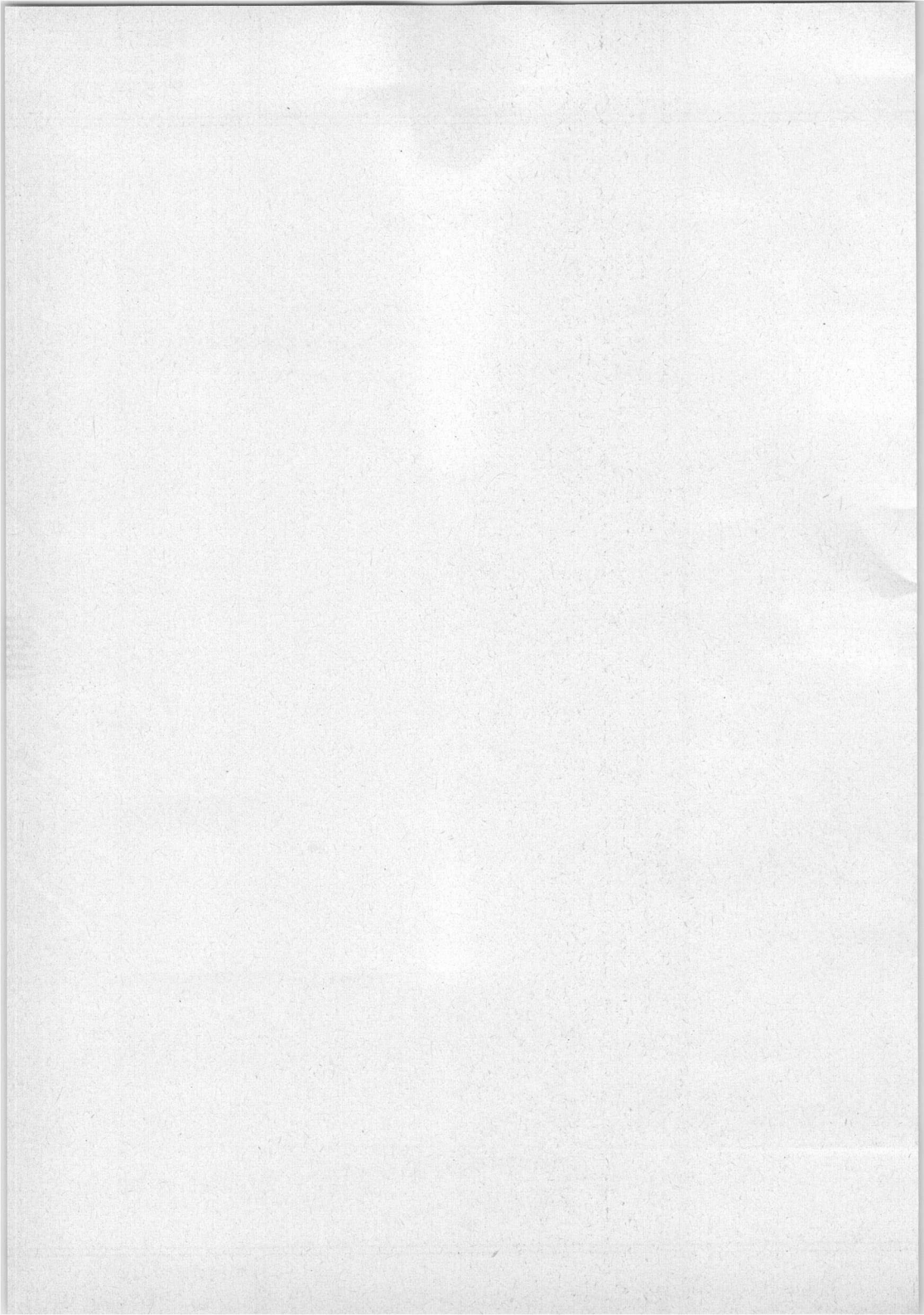

IGNITRON

B-size ignitron intended for use in single-phase and three-phase resistance welding control and similar a.c. control applications.

The tube has a plastic coated stainless steel watercooling jacket, quick change water connections and a temperature sensing pad for mounting of a thermostat.

QUICK REFERENCE DATA

Maximum demand power (two tubes in inverse parallel)	600	kVA
Maximum average current	56	A
Ignitor voltage	150	V
Ignitor current	max. 12	A

MECHANICAL DATA

Dimensions and connections	see page 2
Net mass	1420 g
Shipping mass	2040 g
Mounting position	vertical, anode connection up

Accessories

Ignitor cable	type 55351
Water hose connections : hose nipple coupling nut	type TE 1051c type TE 1051b
Overload protection thermostat	type 55306 or 55318
Water economy thermostat	type 55305 or 55317

DIMENSIONS AND CONNECTIONS

Dimensions in mm

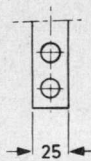
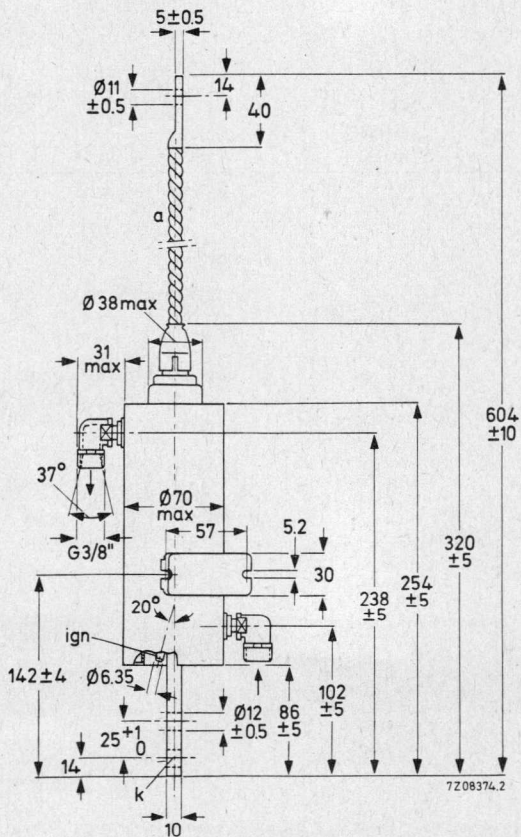
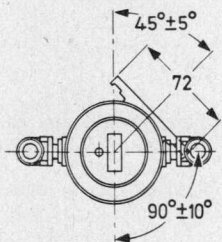

TEMPERATURE LIMITS AND COOLING

TYPICAL CHARACTERISTICS

Pressure drop of cooling water ($q = 2$ l/min)	P_i	max. 0.08	kg/cm ²
Temperature rise at max. average current ($q = 2$ l/min)	$t_o - t_i$	max. 6	°C

LIMITING VALUES (Absolute max. rating system)

A.C. control service

Required water flow at max. average current (See also page 9)	q	min. 2	l/min
Inlet temperature ¹⁾	t_i	min. 10 max. 40	°C
Temperature of thermostat mount ²⁾	t_m	max. 50	°C

Intermittent rectifier service or three-phase welding service

Required continuous water flow at max. average current	q	min. 2	l/min
Inlet temperature ¹⁾	t_i	min. 10 max. 35	°C
Temperature of thermostat mount ²⁾	t_m	max. 45	°C

Pulse service

Under conditions of pulse service with low average load (less than 1 A) continuous cooling is normally not required. The cooling jacket can e.g. be permanently filled with oil.

Care should be taken to prevent condensation of mercury at the anode or glass seal. See also "Application directions ignitrons".

Recommended condensed mercury temperature	t_{Hg}	25 to 30	°C
-------------------------------------------	----------	----------	----

¹⁾ When a number of tubes is cooled in series, t_i min refers to the coldest tube and t_i max. to the hottest tube.

²⁾ WARNING. The thermostat mount is at full line voltage.

When the cooling systems of a number of tubes are connected in series the overload protecting thermostat should be mounted on the last and the water economy thermostat on the last but one tube.

ELECTRICAL DATA

LIMITING VALUES (Absolute max. rating system)

The limiting values are based on full cycle conduction duty, with equally distributed load on all ignitrons, regardless of whether phase control is used or not.

The load must be limited so that at zero phase delay no overload will result.

Single phase A.C. control, two tubes in inverse parallel connection

Table I. See also pages 10, 11 and 12.

Mains frequency range	f	25 to 60					Hz
Mains voltage	V_{RMS}	220 ¹⁾	250	380	500	600	V
Max. averaging time	$T_{av\ max}$	18	18	11.8	9	7.5	s
A. Max. demand power							
Max. demand power	$P_{\ max}$	530	600	600	600	600	kVA
Corresponding max. average current	I_{av}	30.2	30.2	30.2	30.2	30.2	A
Demand current	I_{RMS}	2400	2400	1600	1200	1000	A
Duty factor	δ	2.8	2.8	4.2	5.6	6.7	%
Number of cycles within $T_{av\ max}$. ²⁾	n(50 Hz)	25	25	25	25	25	c/ $T_{av\ max}$
Integrated RMS load current	$I_{F\ RMS}$	400	400	320	280	260	A
B. Max. average current							
Max. average current	$I_{av\ max}$	56	56	56	56	56	A
Corresponding max. demand power	P	180	200	200	200	200	kVA
Demand current	I_{RMS}	800	800	530	400	330	A
Duty factor	δ	15.6	15.6	23.5	31.1	37.7	%
Number of cycles within $T_{av\ max}$. ²⁾	n(50 Hz)	140	140	140	140	140	c/ $T_{av\ max}$
Integrated RMS load current	$I_{F\ RMS}$	320	320	260	220	200	A
Max. surge current RMS ($T_{max} = 0.15\ s$)	I_{surge}	6700	6700	4500	3400	2800	A

1) For mains voltages below 250V(RMS) the max. demand current and max. averaging time valid at 250 V shall not be exceeded.

2) This is the maximum integrated number of cycles a pair of tubes may conduct with or without interruption during the maximum averaging time:

$$n_{max} = \text{duty factor} \times T_{av\ max} \times \text{mains frequency.}$$

LIMITING VALUES (Absolute max. rating system; continued)

Intermittent rectifier service or frequency changer resistance welding service

Mains frequency range	f	50 to 60		Hz
Anode voltage, forward peak	$V_{a\text{ fwd}_p\text{ max}}$	1200	1500	V
inverse peak	$V_{a\text{ inv}_p\text{ max}}$	1200	1500	V
A. <u>Max. peak current</u>				
Anode current, peak	$I_{ap\text{ max}}$	600	480	A
Corresponding average current	I_{av}	5	4	A
B. <u>Max. average current</u>				
Anode current, average	$I_{av\text{ max}}$	22.5	18	A
Corresponding peak current	I_{ap}	135	108	A
Averaging time	$T_{av\text{ max}}$	10	10	s
Ratio I_a/I_{ap} ($T_{av} = \text{max. } 0.5\text{ s}$)	$I_a/I_{ap\text{ max}}$	1/6	1/6	
Ratio I_{surge}/I_{ap} ($T_{\text{max}} = 0.15\text{ s}$)	$I_{\text{surge}}/I_{ap\text{ max}}$	12.5	12.5	

Pulse service

Under certain conditions this ignitron may be used to switch aperiodic current pulses to a very high value (up to 50 kA) and voltages up to 10 kV. The performance depends on the circuit in which the tube is used. The manufacturer should be consulted.

IGNITOR CHARACTERISTICS AND IGNITION CIRCUIT REQUIREMENTS

LIMITING VALUES (Absolute max. rating system)

Ignitor voltage, forward peak	V_{igp}	max. 2000	V
inverse peak (including any transients)	$-V_{igp}$	max. 5	V
Ignitor current, forward peak	I_{igp}	max. 100	A
inverse peak	$-I_{igp}$	max. 0	A
forward RMS	I_{igRMS}	max. 10	A
forward average ($T_{av} = \text{max. } 5 \text{ s}$)	I_{ig}	max. 1	A

A. Anode excitation

Ignitor characteristics

Firing voltage	V_{ig}	150	V
Firing current	I_{ig}	6 to 8	A
		max. 12	A
Ignition time at the above voltage or current	T_{ig}	max. 50	μs ¹⁾

Ignition circuit requirements

Peak voltage required to fire	V_p	min. 200	V
Peak current required to fire	I_p	min. 12	A
Rate of rise of ignitor current	di/dT	min. 0.1	A/ μs

¹⁾ Ignition time is taken from the instant that the stated voltage and current are reached.

IGNITOR CHARACTERISTICS AND IGNITRON CIRCUIT REQUIREMENTS

(continued)

Recommended circuits for anode excitation

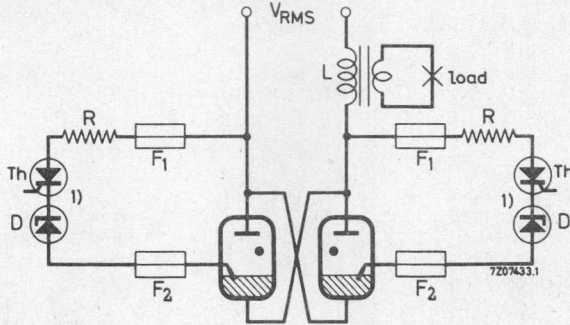

Anode excitation with individual thyristors

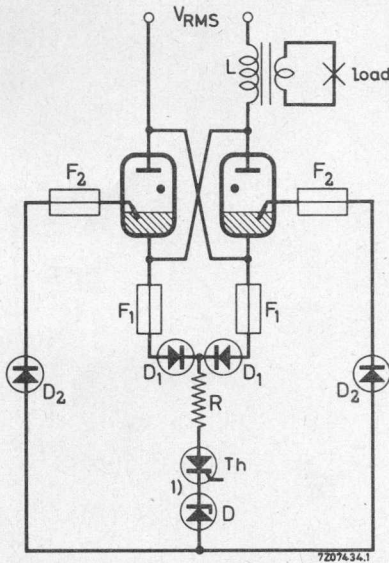

Anode excitation with common thyristor

V_{RMS}	220	250	380	500	600	V
R	2	2	4	5	6	Ω
F_1	= 2 A fast response time					
F_2	= 10 A fast response time					
D	= zener voltage ≥ 18 V					

1) The thyristor-zener diode combination may be substituted by a thyatron.

IGNITOR CHARACTERISTICS AND IGNITION CIRCUIT REQUIREMENTS

(continued)

B. Separate excitation

Recommended circuit for separate excitation

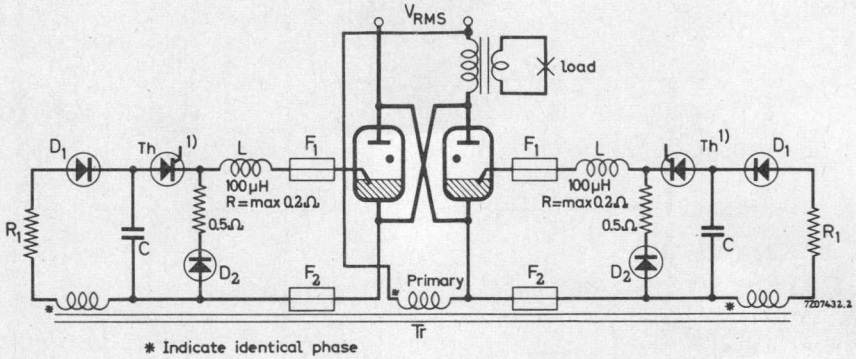

Capacitor value

C 2 8 μ F

Capacitor voltage

V_C 650 400 V \pm 10%

Peak value of closed circuit current

80 to 100 A

1). The thyristor may be substituted by a thyatron.

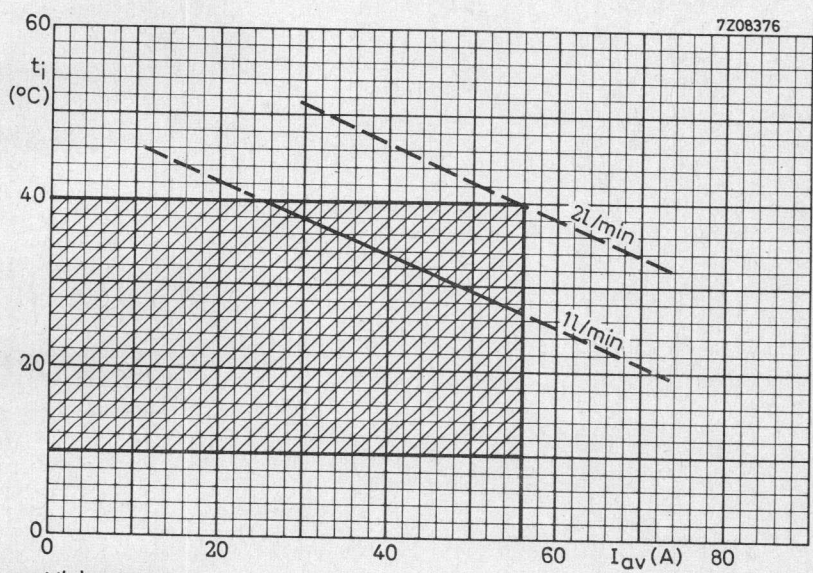
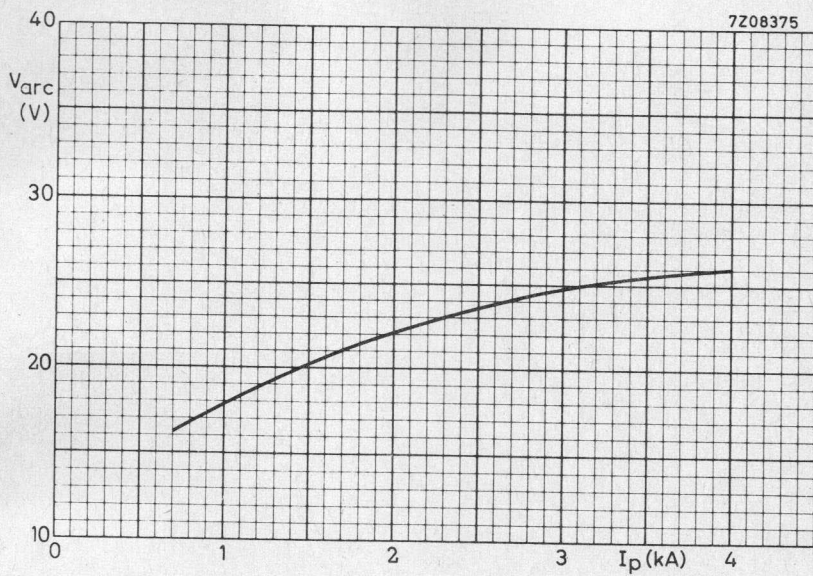

Minimum required continuous waterflow (two tubes cooled in series)



Graph to determine demand current versus duty factor as a function of the mains voltage (page 11)

Construction:

1. Determine cross points in the left hand graph for the chosen mains voltage (points a and b).
2. Draw horizontal lines from the points a and b to determine cross points a_1 and b_2 in the right hand graph.
3. The boundary of the operating area for the pertaining mains voltage is thus determined by straight line interconnections of b_1 , b_2 , a_1 , c, c_1 .

Not for intermittent rectifier service

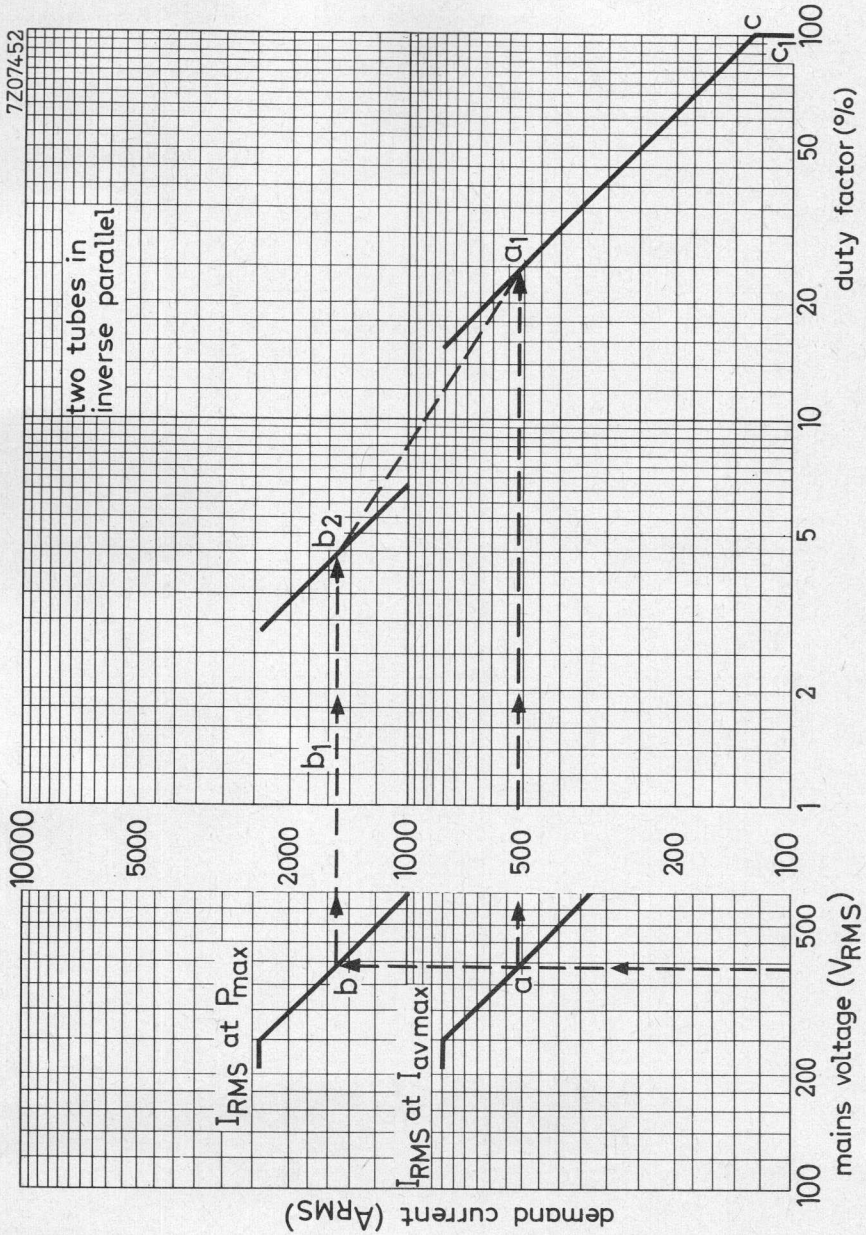

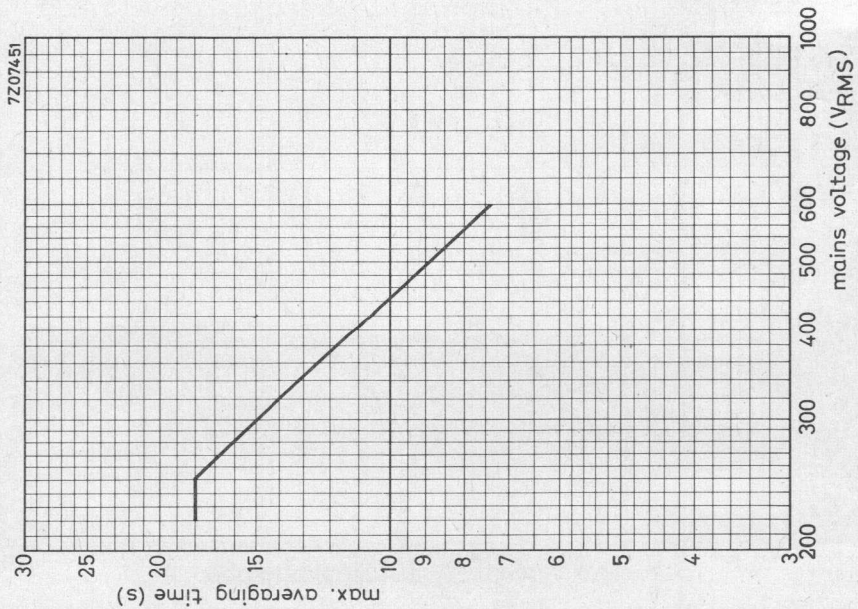
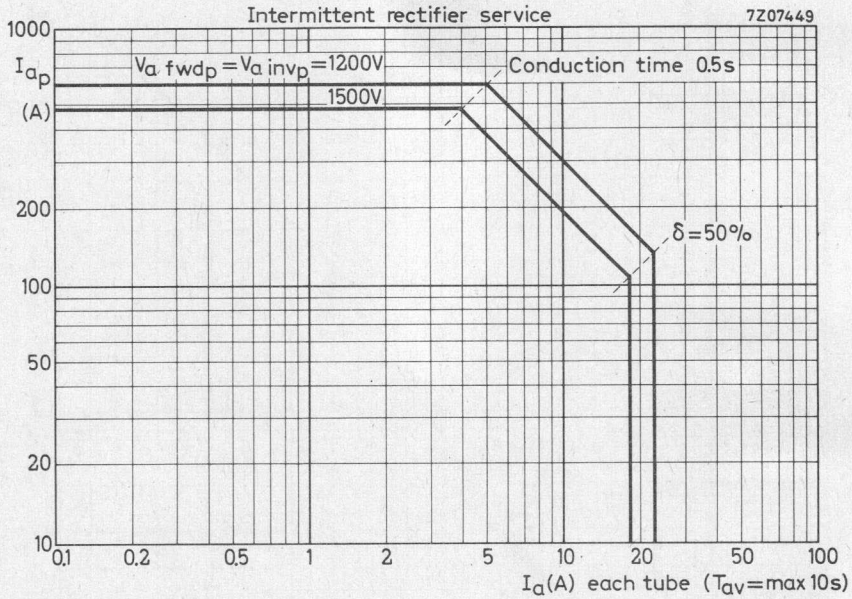

IGNITRON

C-size ignitron intended for use in single-phase resistance welding control and similar a. c. control applications.

The tube has a plastic coated stainless steel watercooling jacket, quick change water connections and a temperature sensing pad for mounting of a thermostat.

QUICK REFERENCE DATA

Maximum demand power (two tubes in inverse parallel)	1200	KVA
Maximum average current	140	A
Ignitor voltage	150	V
Ignitor current	max. 12	A

MECHANICAL DATA

Dimensions and connections	see page 2
Net mass	2820 g
Shipping mass	4080 g
Mounting position	vertical, anode connection up

Accessories

Ignitor cable	type 55351
Water hose connections : hose nipple coupling nut	type TE 1051c type TE 1051b
Overload protection thermostat	type 55306 or 55318
Water economy thermostat	type 55305 or 55317

DIMENSIONS AND CONNECTIONS

Dimensions in mm

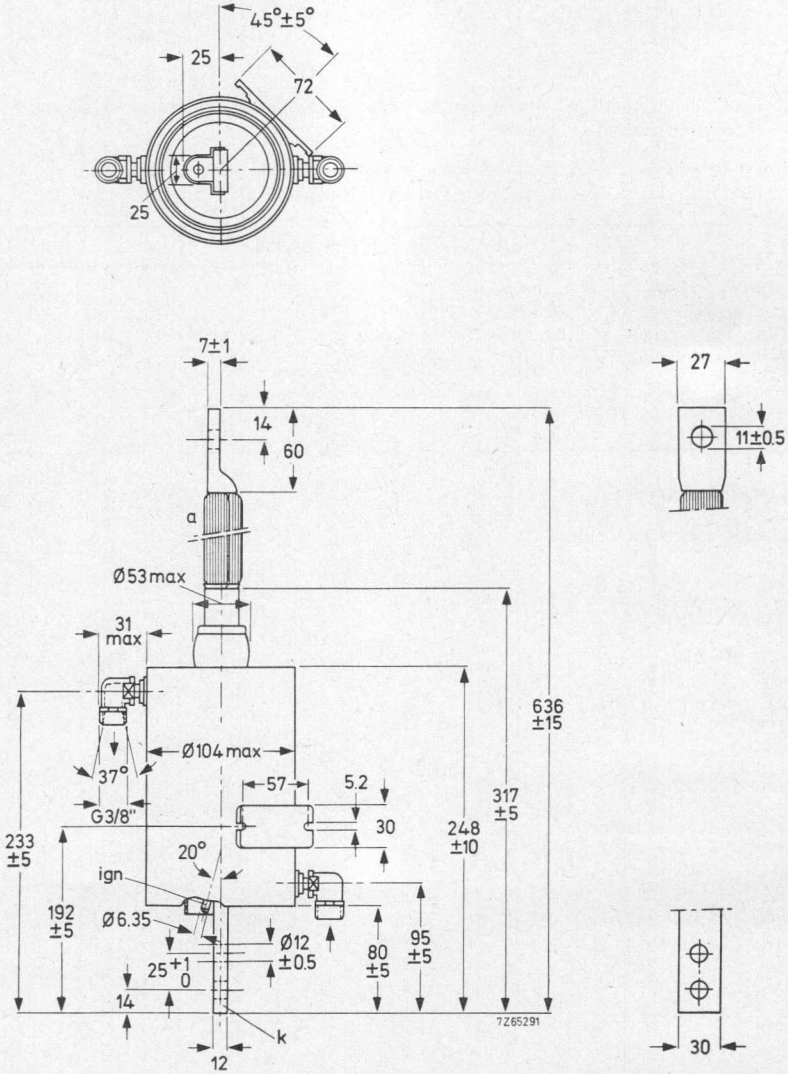

TEMPERATURE LIMITS AND COOLING

TYPICAL CHARACTERISTICS

Pressure drop of cooling water ($q = 5$ l/min)	p_i	max. 0.16	kg/cm ²
Temperature rise at max. average current ($q = 5$ l/min)	$t_o - t_i$	max. 6	°C

LIMITING VALUES (Absolute max. rating system)

A.C. control service

Required water flow at max. average current (See also page 10)	q	min. 5	l/min.
Inlet temperature 1)	t_i	min. 10 max. 40	°C
Temperature of thermostat mount 2)	t_m	max. 50	°C

Pulse service

Under conditions of pulse service with low average load (less than 1 A) continuous cooling is normally not required. The cooling jacket can e.g. be permanently filled with oil.

Care should be taken to prevent condensation of mercury at the anode or glass seal. See also "Application directions ignitrons"

Recommended condensed mercury temperature	t_{Hg}	25 to 30	°C
-------------------------------------------	----------	----------	----

1) When a number of tubes is cooled in series, $t_{i \text{ min}}$ refers to the coldest tube and $t_{i \text{ max}}$. to the hottest tube.

2) **WARNING:** The thermostat mount is at full line voltage.
When the cooling systems of a number of tubes are connected in series the overload protecting thermostat should be mounted on the last and the water economy thermostat on the last but one tube.

ELECTRICAL DATA

LIMITING VALUES (Absolute max. rating system)

The limiting values are based on full cycle conduction duty, with equally distributed load on all ignitrons, regardless of whether phase control is used or not.

The load must be limited so that at zero phase delay no overload will result.

Single phase A.C. control, two tubes in inverse parallel connection.

Table I. See also pages 8, 9, and 11.

Mains frequency range	f	25 to 60					Hz
Mains voltage	V_{RMS}	220 ¹⁾	250	380	500	600	V
Max. averaging time	$T_{av\ max}$	14	14	9.4	7	5.8	s
A. Max. demand power	P_{max}	1060	1200	1200	1200	1200	kVA
Max. demand power Corresponding max. average current							
Demand current	I_{RMS}	4800	4800	3150	2400	2000	A
Duty factor	δ	3.5	3.5	5.3	7.0	8.4	%
Number of cycles within $T_{av\ max.}$ ²⁾	n (50 Hz)	25	25	25	25	25	c/ $T_{av\ max}$
Integrated RMS load current	$I_{F\ RMS}$	900	900	720	630	580	A
B. Max. average current	$I_{av\ max}$	140	140	140	140	140	A
Max. average current Corresponding max. demand power							
Demand current	I_{RMS}	1600	1600	1050	800	660	A
Duty factor	δ	19.4	19.4	29.5	39.0	47.0	%
Number of cycles within $T_{av\ max.}$ ²⁾	n (50 Hz)	140	140	140	140	140	c/ $T_{av\ max}$
Integrated RMS load current	$I_{F\ RMS}$	700	700	570	500	450	A
Max. surge current RMS ($T_{max} = 0.15\ s$)	I_{surge}	13.5	13.5	9.0	6.7	5.7	kA

1) For mains voltages below 250 V(RMS) the max. demand current and max. averaging time valid at 250 V shall not be exceeded.

2) This is the maximum integrated number of cycles a pair of tubes may conduct with or without interruption during the maximum averaging time:
 $n_{max} = \text{duty factor} \times T_{av\ max} \times \text{mains frequency.}$

ELECTRICAL DATA (continued)

Pulse service

Under certain conditions this ignitron may be used to switch aperiodic current pulses to a very high value (up to 100 kA) and voltages up to 10 kV. The performance depends on the circuit in which the tube is used. The manufacturer should be consulted.

IGNITOR CHARACTERISTICS AND IGNITION CIRCUIT REQUIREMENTS

LIMITING VALUES (Absolute max. rating system)

Ignitor voltage, forward peak	V_{igp}	max. 2000 V
inverse peak (including any transients)	$-V_{igp}$	max. 5 V
Ignitor current, forward peak	I_{igp}	max. 100 A
inverse peak	$-I_{igp}$	max. 0 A
forward RMS	I_{igRMS}	max. 10 A
forward average ($T_{av} = \text{max. } 5 \text{ s}$)	I_{ig}	max. 1 A

A. Anode excitation

Ignitor characteristics

Firing voltage	V_{ig}	150 V
Firing current	I_{ig}	6 to 8 A max. 12 A
Ignition time at the above voltage or current	T_{ig}	max. 50 μs ¹⁾

Ignition circuit requirements

Peak voltage required to fire	V_p	min. 200 V
Peak current required to fire	I_p	min. 12 A
Rate of rise of ignitor current	di/dT	min. 0.1 A/ μs

¹⁾ Ignition time is taken from the instant that the stated voltage and current are reached.

IGNITOR CHARACTERISTICS AND IGNITION CIRCUIT REQUIREMENTS

(continued)

Recommended circuits for anode excitation

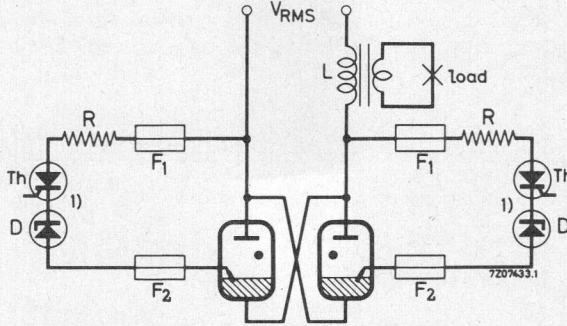

Anode excitation with individual thyristors

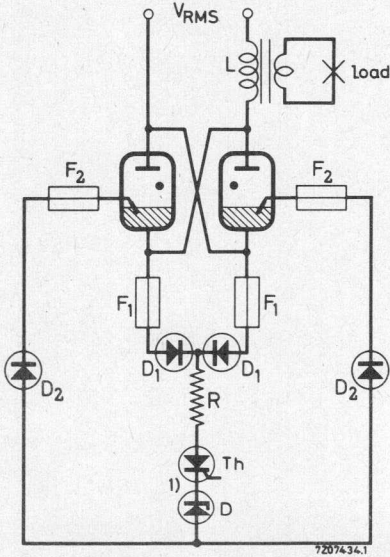

Anode excitation with common thyristor

V_{RMS}	220	250	380	500	600	V
R	2	2	4	5	6	Ω
F_1	= 2 A fast response time					
F_2	= 10 A fast response time					
D	= zener voltage ≥ 18 V					

1) The thyristor-zener diode combination may be substituted by a thyatron.

IGNITOR CHARACTERISTICS AND IGNITION CIRCUIT REQUIREMENTS

(continued)

B. Separate excitation

Recommended circuit for separate excitation

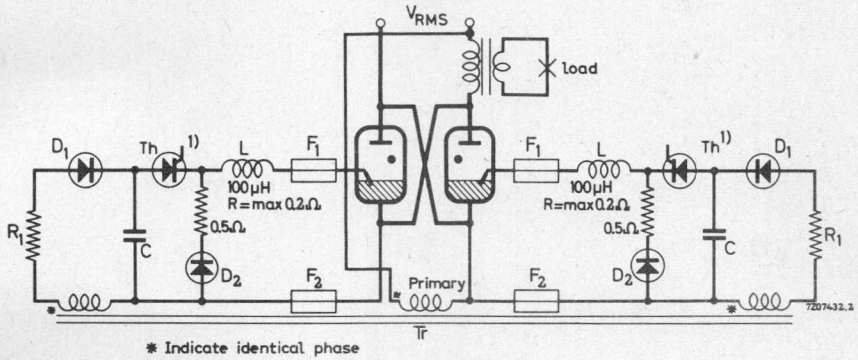

Capacitor value

C 2 8 μ F

Capacitor voltage

V_c 650 400 V $\pm 10\%$

Peak value of closed circuit current

80 to 100 A

¹⁾ The thyristor may be substituted by a thyatron.

Graph to determine demand current versus duty factor as a function of the mains voltage (page 9)

Construction:

1. Determine cross points in the left hand graph for the chosen mains voltage (points a and b).
2. Draw horizontal lines from the points a and b to determine cross points a_1 and b_2 in the right hand graph.
3. The boundary of the operating area for the pertaining mains voltage is thus determined by straight line interconnections of b_1 , b_2 , a_1 , c, c_1 .

Not for intermittent rectifier service

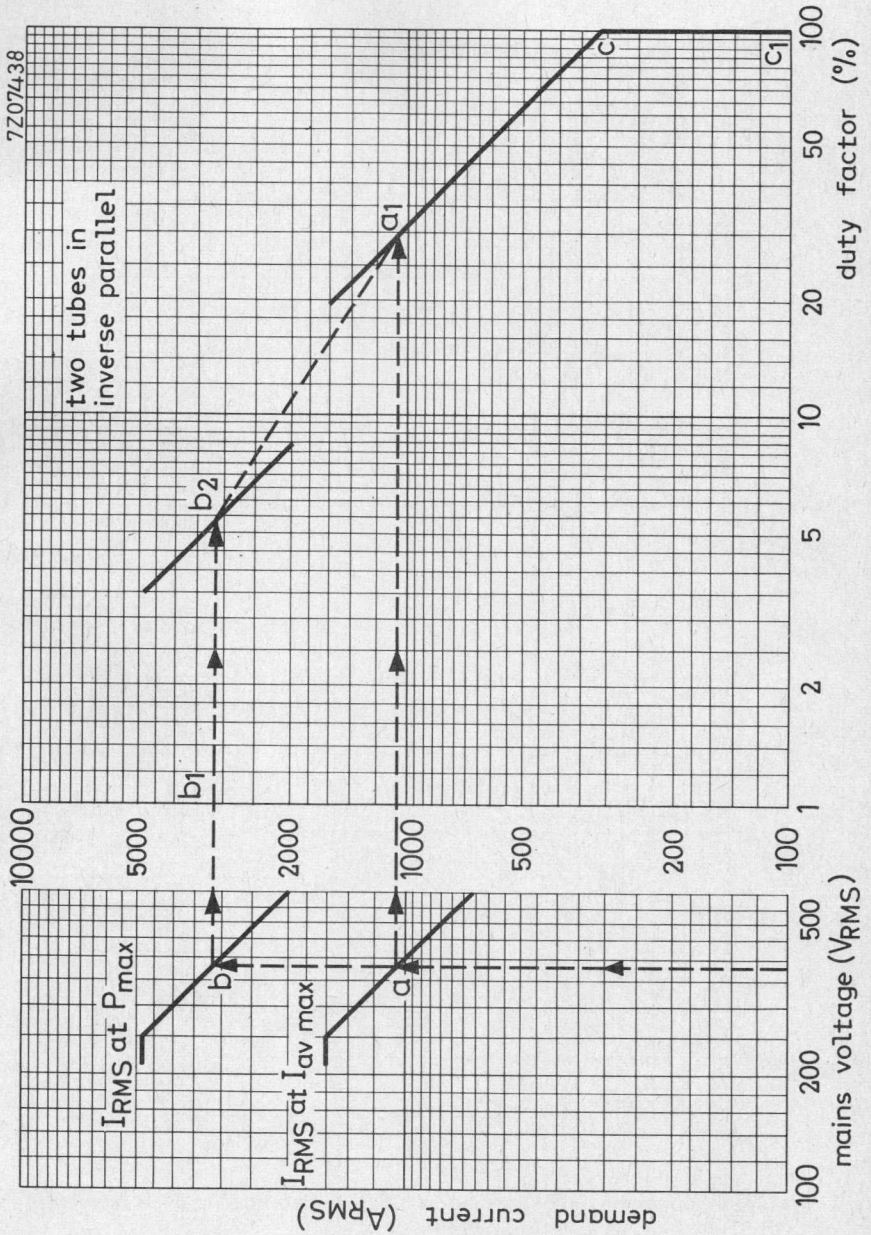

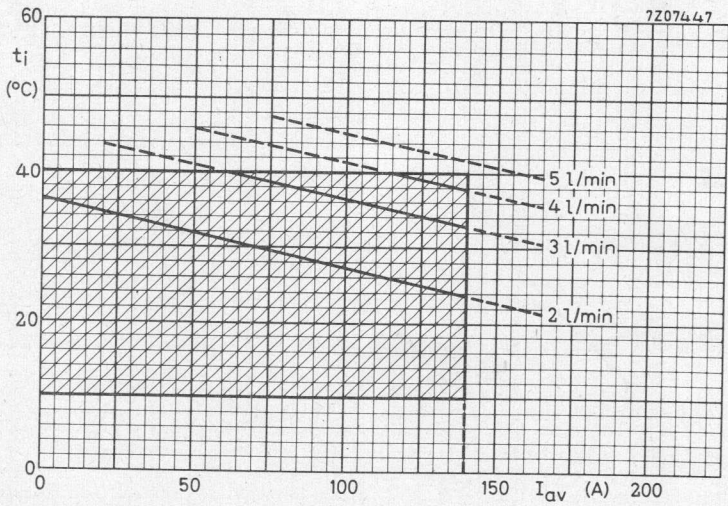
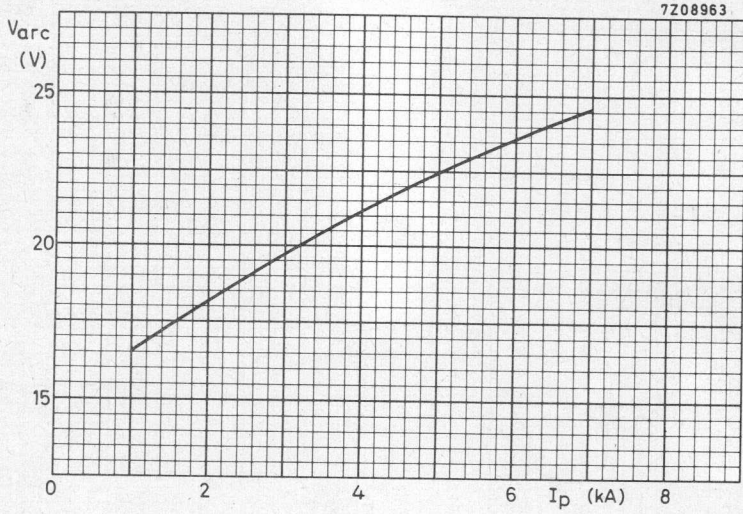

Minimum required continuous waterflow (two tubes cooled in series)

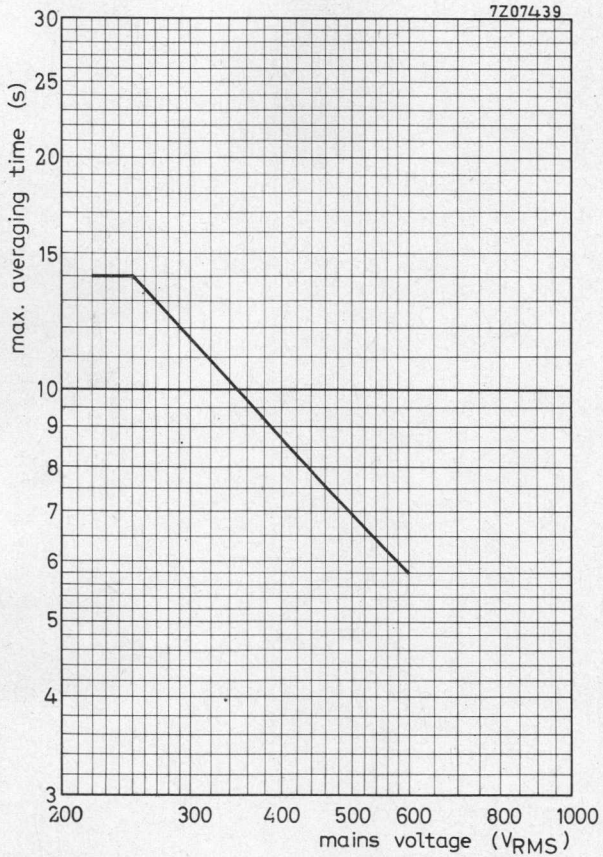

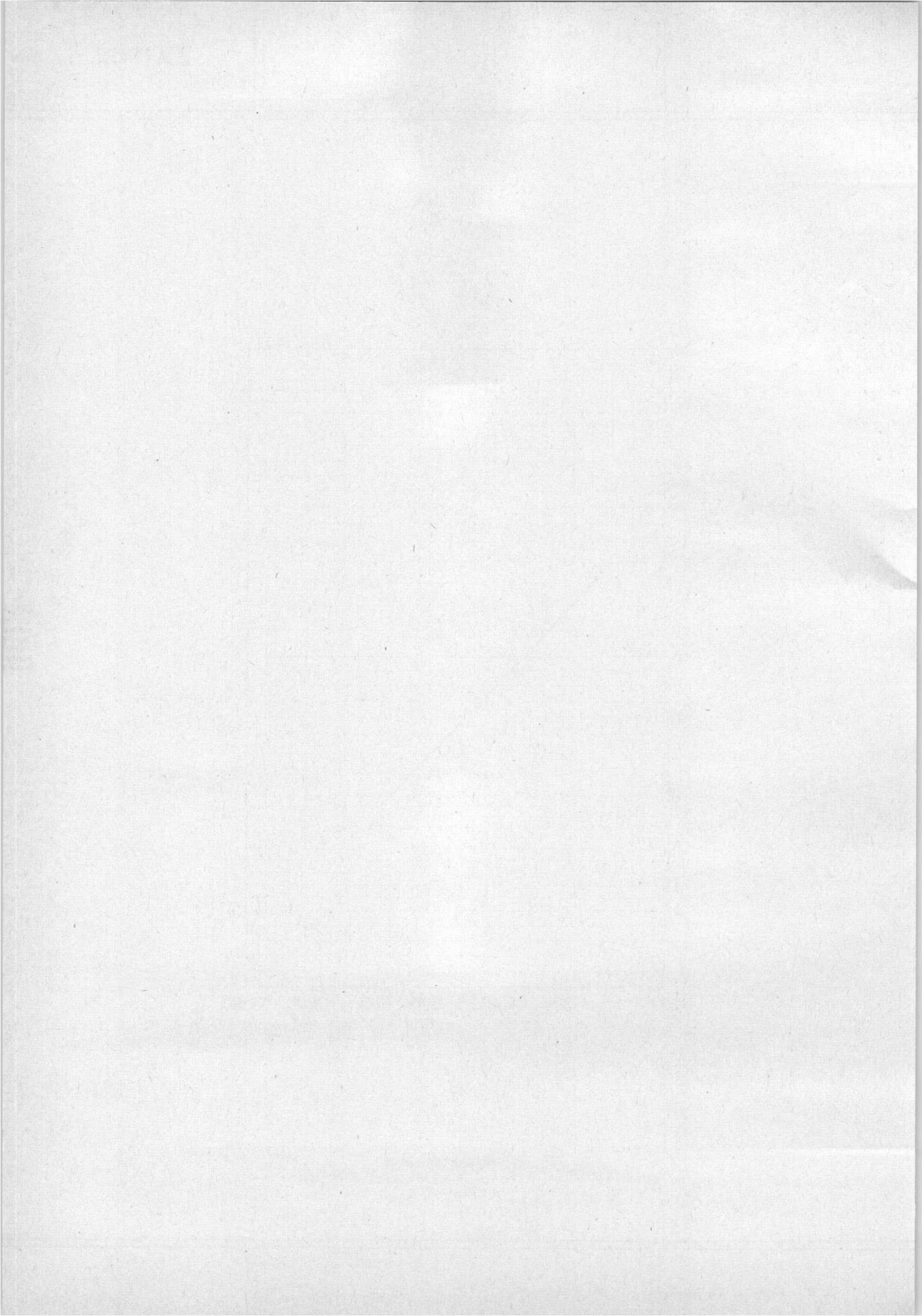

IGNITRON

D-size ignitron intended for use in single-phase and three-phase resistance welding control and similar a. c. control applications.

The tube has a plastic coated stainless steel watercooling jacket, quick change water connections and a temperature sensing pad for mounting of a thermostat.

QUICK REFERENCE DATA

Maximum demand power (two tubes in inverse parallel)	2400	kVA
Maximum average current	355	A
Ignitor voltage	180	V
Ignitor current	max. 12	A

MECHANICAL DATA

Dimensions and connections	see page 2
Net mass	8.7 kg
Shipping mass	11 kg
Mounting position	vertical, anode connection up

Accessories

Ignitor cable	type 55351
Water hose connections : hose nipple coupling nut	type TE 1051c type TE 1051b
Overload protection thermostat	type 55306 or 55318
Water economy thermostat	type 55305 or 55317

DIMENSIONS AND CONNECTIONS

Dimensions in mm

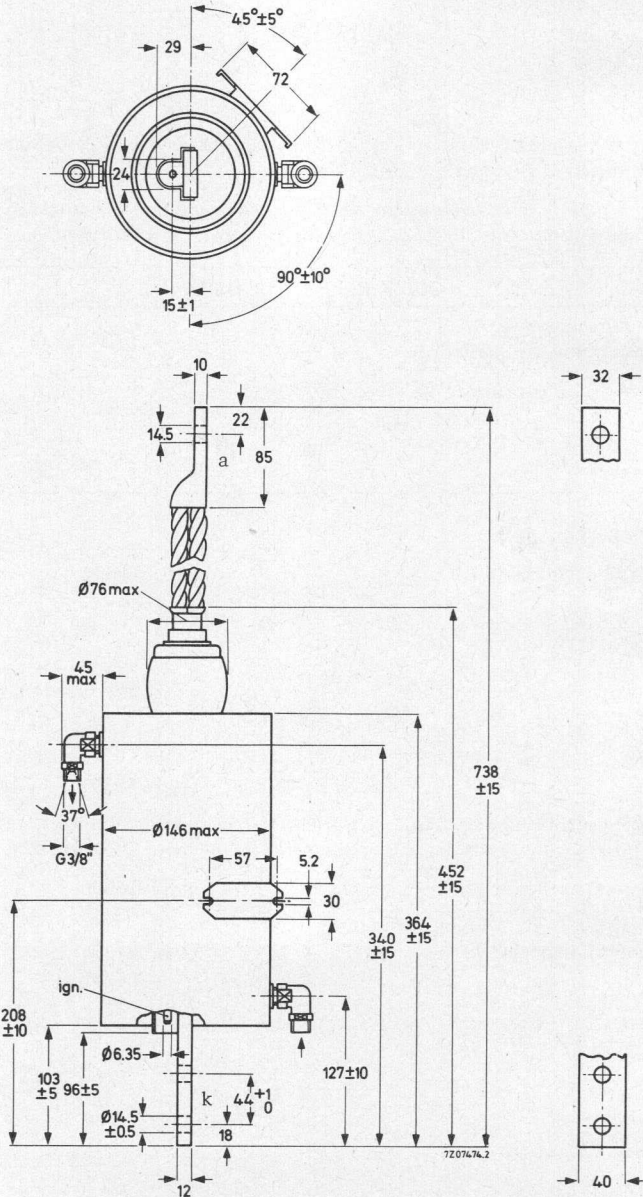

TEMPERATURE LIMITS AND COOLING

TYPICAL CHARACTERISTICS

Pressure drop of cooling water (q = 9 l/min)	P_i	max. 0.35	kg/cm ²
Temperature rise at max. average current (q = 9 l/min)	$t_o - t_i$	max. 9	°C

LIMITING VALUES (Absolute max. rating system)

A.C. control service

Required water flow at max. average current (see also page 9)	q	min. 9	l/min.
Inlet temperature ¹⁾	t_i	min. 10 max. 40	°C
Temperature of thermostat mount ²⁾	t_m	max. 50	°C

Intermittent rectifier service or three-phase welding service

Required water flow at max. average current	q	min. 9	l/min.
Inlet temperature ¹⁾	t_i	min. 10 max. 35	°C
Temperature of thermostat mount ²⁾	t_m	max. 45	°C

¹⁾ When a number of tubes is cooled in series, $t_{i \text{ min}}$ refers to the coldest tube and $t_{i \text{ max}}$ to the hottest tube.

²⁾ WARNING. The thermostat mount is at full line voltage. When the cooling systems of a number of tubes are connected in series the overload protecting thermostat should be mounted on the last and the water economy thermostat on the last but one tube.

ELECTRICAL DATA

LIMITING VALUES (Absolute max. rating system)

The limiting values are based on full cycle conduction duty, with equally distributed load on all ignitrons, regardless of whether phase control is used or not.

The load must be limited so that at zero phase delay no overload will result.

Single phase A.C. control, two tubes in inverse parallel connection

Table I. See also pages 10, 11 and 12

Mains frequency range	f	25 to 60					Hz
Mains voltage	V_{RMS}	220 ¹⁾	250	380	500	600	V
Max. averaging time	$T_{av\ max}$	11	11	7.3	5.6	4.6	s
A. Max. demand power							
Max. demand power	P max	2120	2400	2400	2400	2400	kVA
Corresponding max. average current	I_{av}	192	192	192	192	192	A
Demand current	I_{RMS}	9600	9600	6300	4800	4000	A
Duty factor	δ	4.4	4.4	6.8	8.8	10.6	%
Number of cycles within $T_{av\ max}$. ²⁾	n (50 Hz)	25	25	25	25	25	c/ $T_{av\ max}$
Integrated RMS load current	$I_{F\ RMS}$	2000	2000	1640	1420	1300	A
B. Max. average current							
Max. average current	$I_{av\ max}$	355	355	355	355	355	A
Corresponding max. demand power	P	700	800	800	800	800	kVA
Demand current	I_{RMS}	3200	3200	2100	1600	1320	A
Duty factor	δ	24.6	24.6	37.5	49.3	60.0	%
Number of cycles within $T_{av\ max}$. ²⁾	n (50 Hz)	140	140	140	140	140	c/ $T_{av\ max}$
Integrated RMS load current	$I_{F\ RMS}$	1600	1600	1300	1130	1020	A
Max. surge current RMS ($T_{max} = 0.15\ s$)	I_{surge}	27	27	17.8	13.5	11.2	kA

1) For mains voltages below 250 V(RMS) the max. demand current and max. averaging time valid at 250 V shall not be exceeded.

2) This is the maximum integrated number of cycles a pair of tubes may conduct with or without interruption during the maximum averaging time:
 $n_{max} = \text{duty factor} \times T_{av\ max} \times \text{mains frequency.}$

LIMITING VALUES (Absolute max. rating system; continued)

Intermittent rectifier service or frequency changer resistance welding service

Mains frequency range	f	50 to 60 Hz		
Anode voltage, forward peak	$V_{a\ fwd_p\ max}$	600	1200	1500 V
inverse peak	$V_{a\ inv_p\ max}$	600	1200	1500 V
A. Max. peak current				
Anode current, peak	$I_{a_p\ max}$	4000	3000	2400 A
Corresponding average current	I_{av}	54	40	32 A
B. Max. average current				
Anode current, average	$I_{av\ max}$	190	140	112 A
Corresponding peak	I_{a_p}	1140	840	672 A
Averaging time	$T_{av\ max}$	6.25	6.25	6.25 s
Ratio I_a/I_{a_p} ($T_{av} = \max. 0.5\ s$)	$I_a/I_{a_p\ max}$	1/6	1/6	1/6
Ratio I_{surge}/I_{a_p} ($T_{max} = 0.15\ s$)	$I_{surge}/I_{a_p\ max}$	12.5	12.5	12.5

IGNITOR CHARACTERISTICS AND IGNITION CIRCUIT REQUIREMENTS

LIMITING VALUES (Absolute max. rating system)

Ignitor voltage, forward peak	V_{igp}	max. 2000 V
inverse peak (including any transients)	$-V_{igp}$	max. 5 V
Ignitor current, forward peak	I_{igp}	max. 100 A
inverse peak	$-I_{igp}$	max. 0 A
forward RMS	I_{igRMS}	max. 10 A
forward average ($T_{av} = \max. 5\ s$)	I_{ig}	max. 1 A

IGNITOR CHARACTERISTICS AND IGNITION CIRCUIT REQUIREMENTS

(continued)

A. Anode excitation

Ignitor characteristics

Firing voltage	V_{ig}	180 V
Firing current	I_{ig}	6 to 8 A max. 12 A
Ignition time at the above voltage or current	T_{ig}	max. 100 μs ¹⁾

Ignition circuit requirements

Peak voltage required to fire	V_p	min. 200 V
Peak current required for anode take over	I_p	15 to 30 A ²⁾
Rate of rise of ignitor current	di/dT	min. 0.1 A/ μs

¹⁾ Ignition time is taken from the instant that the stated voltage and current are reached.

²⁾ The higher value holds for the lower anode voltage and the lower cooling water temp., the lower value for higher anode voltage and higher cooling water temp.

IGNITOR CHARACTERISTICS AND IGNITION CIRCUIT REQUIREMENTS

Recommended circuits for anode excitation

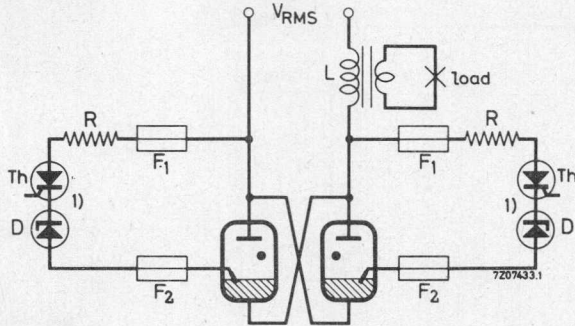

Anode excitation with individual thyristors

V_{RMS}	220	250	380	500	600	V
-----------	-----	-----	-----	-----	-----	---

R	2	2	4	5	6	Ω
---	---	---	---	---	---	----------

$F_1 = 2$ A fast response time

$F_2 = 10$ A fast response time

D = zener voltage ≥ 18 V

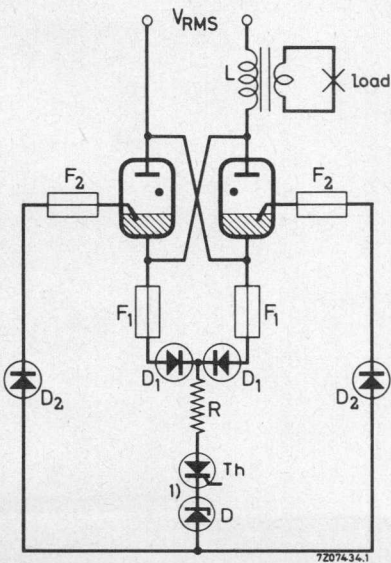

Anode excitation with common thyristor

1) The thyristor-zener diode combination may be substituted by a thyatron.

IGNITOR CHARACTERISTICS AND IGNITION CIRCUIT REQUIREMENTS

B. Separate excitation

Recommended circuit for separate excitation

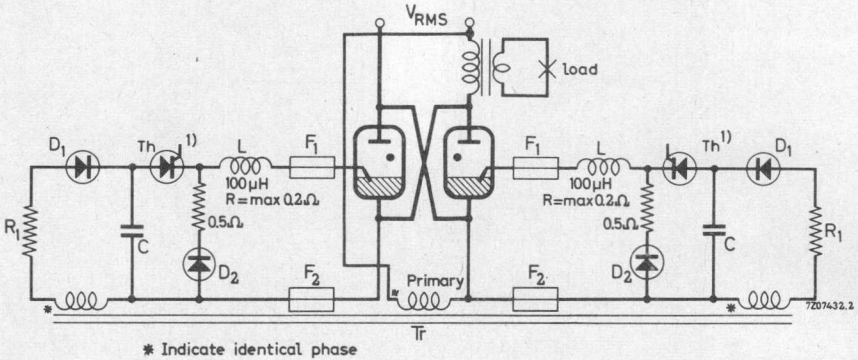

Capacitor value	2 μF
Capacitor voltage	650 V ± 10%
Peak value of closed circuit current	80 to 100 A

1) The thyristor may be substituted by a thyatron.

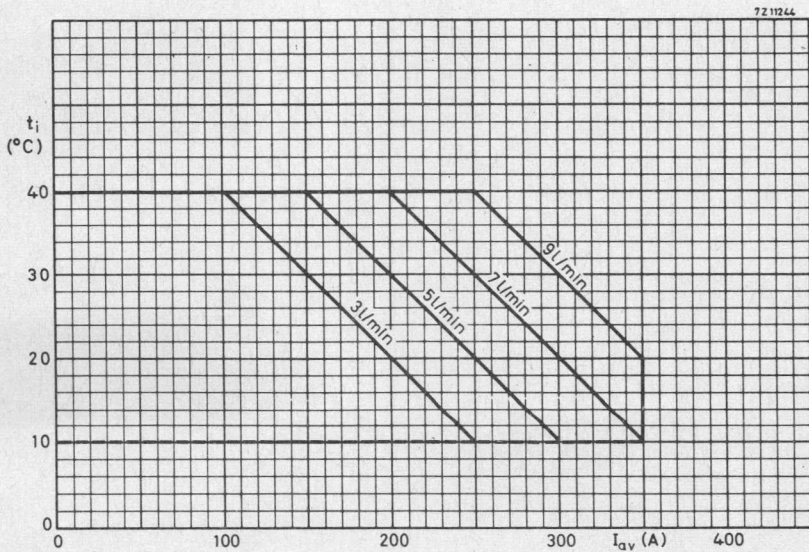
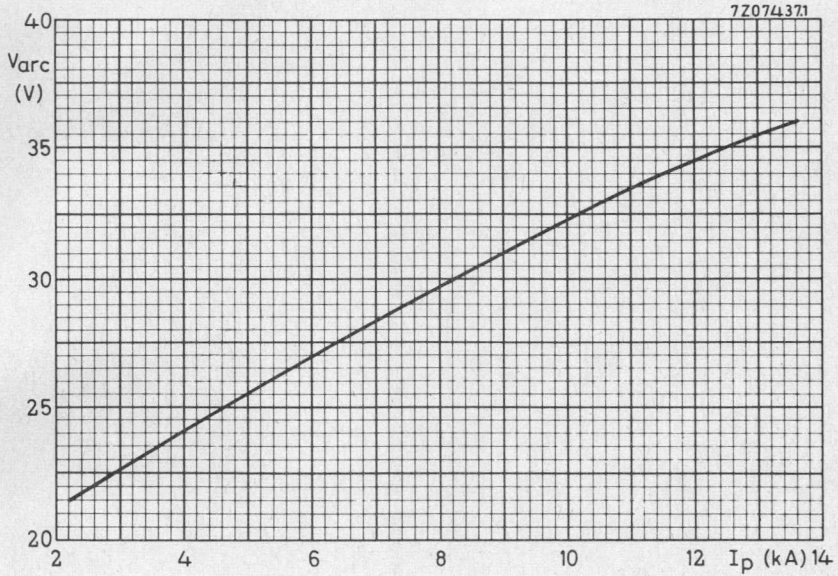

Minimum required continuous waterflow (two tubes cooled in series)

Graph to determine demand current versus duty factor as a function of the mains voltage (page 11)

Construction:

1. Determine cross points in the left hand graph for the chosen mains voltage (points a and b).
2. Draw horizontal lines from the points a and b to determine cross points a_1 and b_2 in the right hand graph.
3. The boundary of the operating area for the pertaining mains voltage is thus determined by straight line interconnections of b_1 , b_2 , a_1 , c, c_1 .

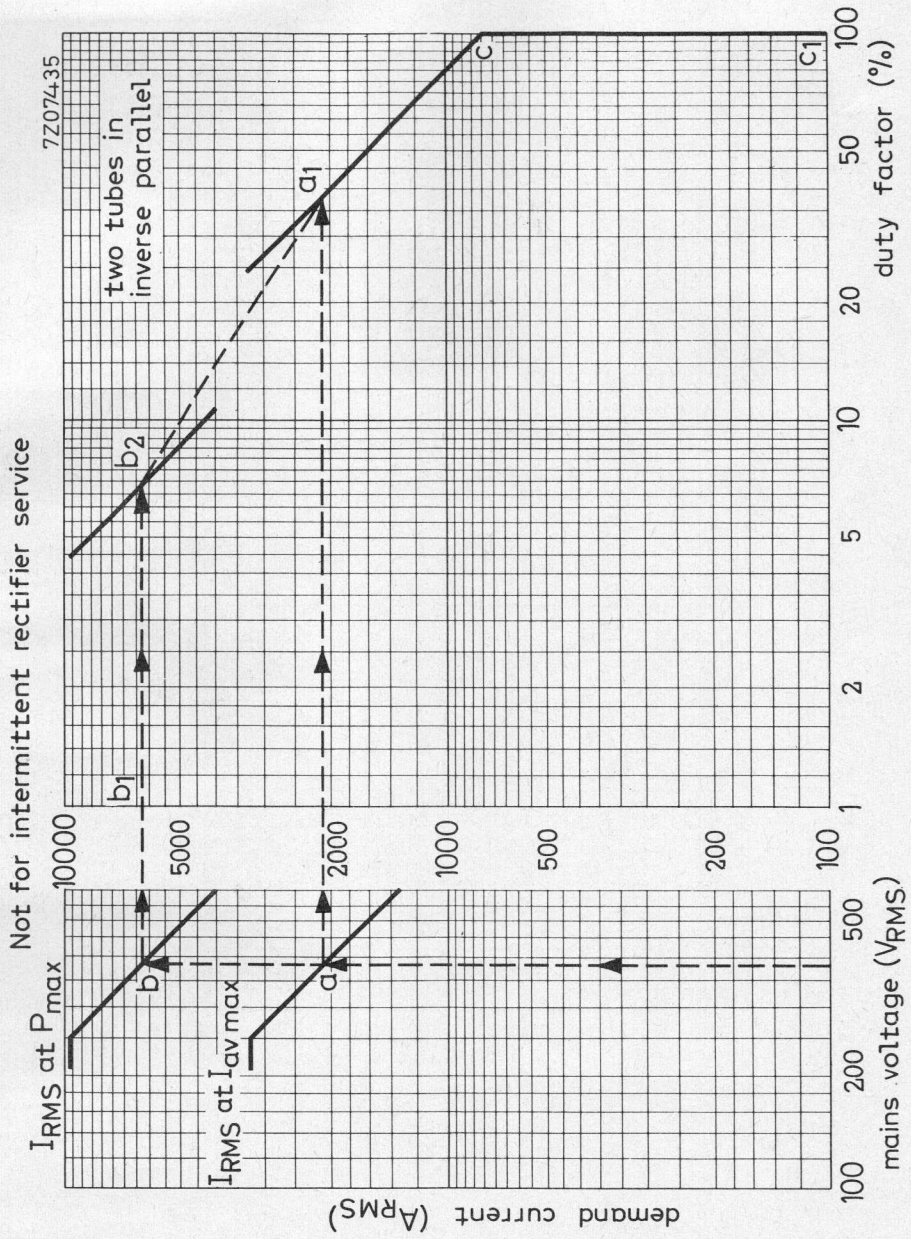

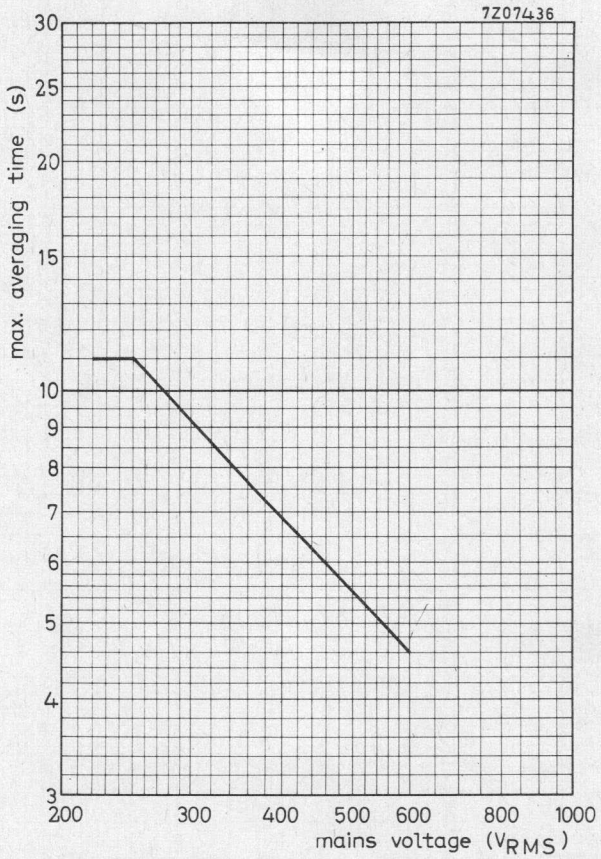

Intermittent rectifier service

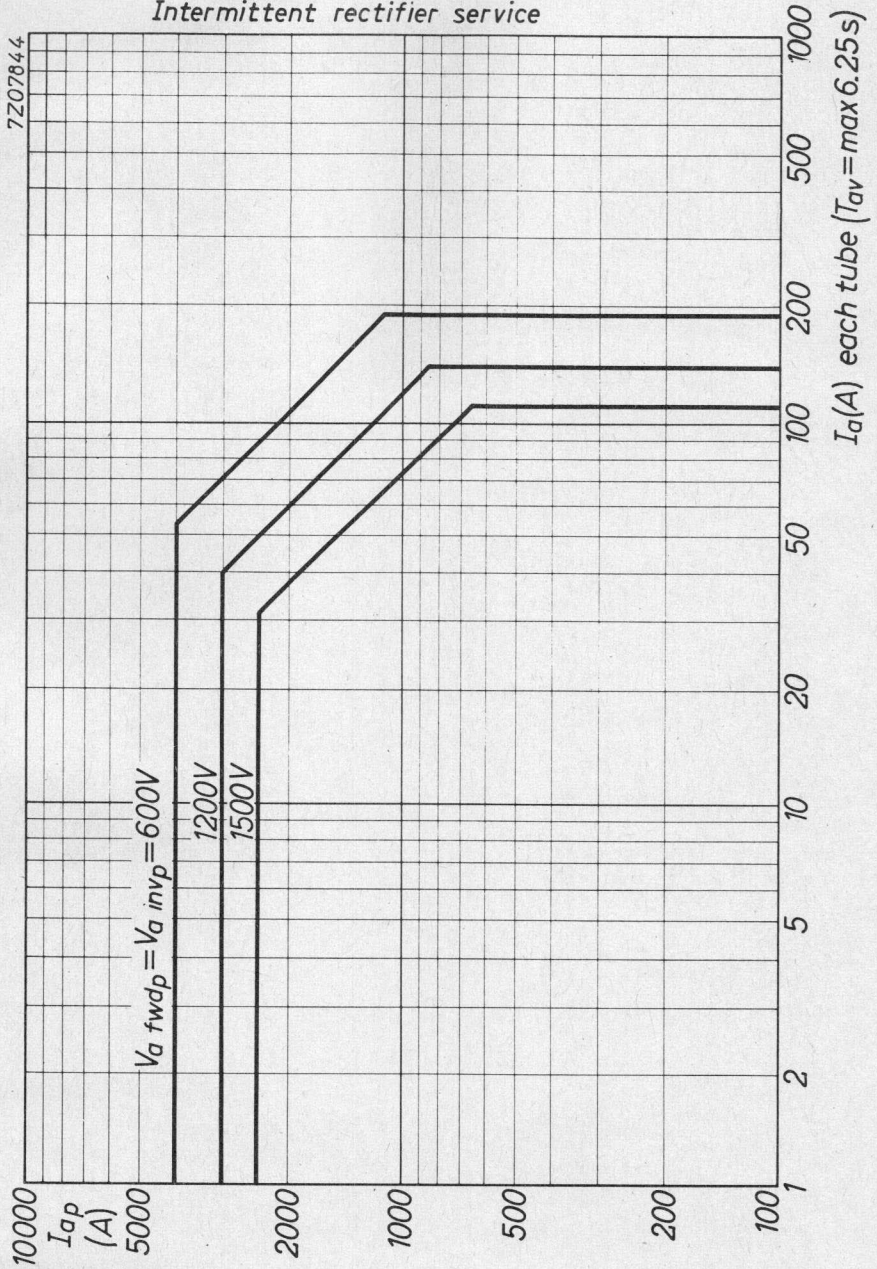



IGNITRON

Up-rated B-size ignitron intended for use in single-phase and three-phase resistance welding control and similar a. c. control applications.

The tube has a plastic coated stainless steel watercooling jacket, quick change water connections and a temperature sensing pad for mounting of a thermostat.

QUICK REFERENCE DATA

Maximum demand power (two tubes in inverse parallel) at 600 V (r. m. s.)	1200	kVA
Maximum average current	70	A
Ignitor voltage	150	V
Ignitor current	max. 12	A

MECHANICAL DATA

Dimensions and connections	see page 2
Net mass	1660 g
Shipping mass	2280 g
Mounting position	vertical, anode connection up

Accessories

Ignitor cable	type 55351
Water hose connections : hose nipple coupling nut	type TE 1051c type TE 1051b
Overload protection thermostat	type 55306 or 55318
Water economy thermostat	type 55305 or 55317

DIMENSIONS AND CONNECTIONS

Dimensions in mm

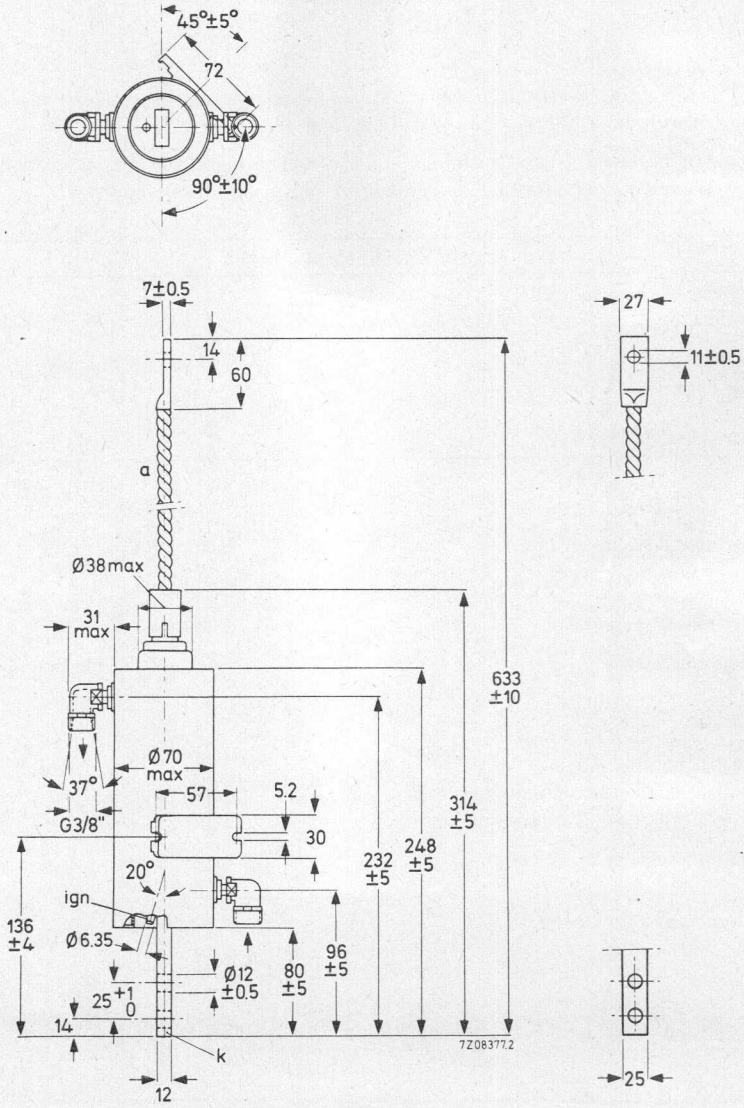

TEMPERATURE LIMITS AND COOLING

TYPICAL CHARACTERISTICS

Pressure drop of cooling water ($q = 3$ l/min)	p_i	max.	0.1	kg/cm ²
Temperature rise at max. average current ($q = 3$ l/min)	$t_o - t_i$	max.	5.5	°C

LIMITING VALUES (Absolute max. rating system)

A.C. control service

Required water flow at max. average current (See also page 9)	q	min.	3	l/min
Inlet temperature	t_i	min.	10	°C
		max.	40	°C
Temperature of thermostat mount ²⁾	t_m	max.	50	°C

Intermittent rectifier service or three-phase welding service

Required continuous water flow at max. average current	q	min.	4	l/min
Inlet temperature ¹⁾	t_i	min.	10	°C
		max.	35	°C
Temperature of thermostat mount ²⁾	t_m	max.	45	°C

Pulse service

Under conditions of pulse service with low average load (less than 1·A) continuous cooling is normally not required. The cooling jacket can e.g. be permanently filled with oil.

Care should be taken to prevent condensation of mercury at the anode or glass seal. See also "Application directions ignitrons".

Recommended condensed mercury temperature	t_{Hg}	25 to 30	°C
-------------------------------------------	----------	----------	----

1) When a number of tubes is cooled in series, t_i min refers to the coldest tube and t_i max to the hottest tube.

2) WARNING. The thermostat mount is at full line voltage.

When the cooling systems of a number of tubes are connected in series the over-load protecting thermostat should be mounted on the last and the water economy thermostat at the last but one tube.

ELECTRICAL DATA

LIMITING VALUES (Absolute max. rating system)

The limiting values are based on full cycle conduction duty, with equally distributed load on all ignitrons, regardless of whether phase control is used or not.

The load must be limited so that at zero phase delay no overload will result.

Single phase A.C. control, two tubes in inverse parallel connection

Table I. See also pages 10 and 11

Mains frequency range	f	25 to 60					Hz
Mains voltage	V_{RMS}	220 ¹⁾	250	380	500	600	V
Max. averaging time	$T_{av \max}$	24	24	15.8	12	10	s
A. Max. demand power							
Max. demand power	P_{\max}	550	630	850	1050	1200	kVA
Corresponding max. average current	I_{av}	38	38	38	38	38	A
Demand current	I_{RMS}	2500	2500	2250	2100	2000	A
Duty factor	δ	3.3	3.3	3.8	4.0	4.2	%
Number of cycles within $T_{av \max}$ ²⁾	n (50 Hz)	40	40	30	24	21	c/ $T_{av \max}$
Integrated RMS load current	I_{FRMS}	460	460	440	420	410	A
B. Max. average current							
Max. average current	$I_{AV\max}$	70	70	70	70	70	A
Corresponding max. demand power	P	180	210	280	350	400	kVA
Demand current	I_{RMS}	850	850	750	700	660	A
Duty factor	δ	18.3	18.3	20.8	22.2	23.5	%
Number of cycles within $T_{av \max}$ ²⁾	n (50 Hz)	220	220	164	134	118	c/ $T_{av \max}$
Integrated RMS load current	I_{FRMS}	360	360	340	330	320	A
Max. surge current RMS I_{surge} ($T_{\max} = 0.15$ s)		7000	7000	6300	5900	5600	A

1) For mains voltages below 250V(RMS) the max. demand current and max. averaging time valid at 250 V shall not be exceeded.

2) This is the maximum integrated number of cycles a pair of tubes may conduct with or without interruption during the maximum averaging time:

$$n_{\max} = \text{duty factor} \times T_{av \max} \times \text{mains frequency.}$$

IGNITOR CHARACTERISTICS AND IGNITION CIRCUIT REQUIREMENTS

LIMITING VALUES (Absolute max. rating system)

Ignitor voltage, forward peak	V_{igp}	max. 2000 V
inverse peak (including any transients)	$-V_{igp}$	max. 5 V
Ignitor current, forward peak	I_{igp}	max. 100 A
inverse peak	$-I_{igp}$	max. 0 A
forward RMS	I_{igRMS}	max. 10 A
forward average ($T_{av} = \text{max. } 5 \text{ s}$)	I_{ig}	max. 1 A

A. Anode excitation

Ignitor characteristics

Firing voltage	V_{ig}	150 V
Firing current	I_{ig}	6 to 8 A
		max. 12 A
Ignition time at the above voltage or current	T_{ig}	max. 50 μs ¹⁾

Ignition circuit requirements

Peak voltage required to fire	V_p	min. 200 V
Peak current required to fire	I_p	min. 12 A
Rate of rise of ignitor current	di/dT	min. 0.1 A/ μs

¹⁾ Ignition time is taken from the instant that the stated voltage and current are reached.

IGNITOR CHARACTERISTICS AND IGNITION CIRCUIT REQUIREMENTS

(continued)

Recommended circuits for anode excitation

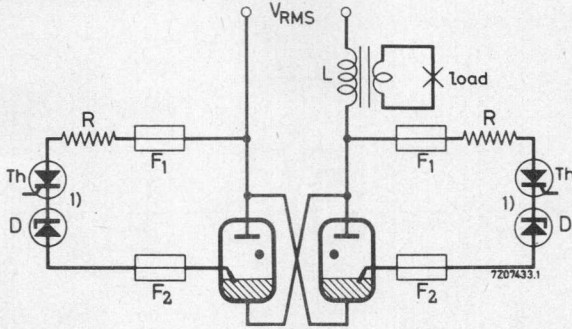

Anode excitation with individual thyristors

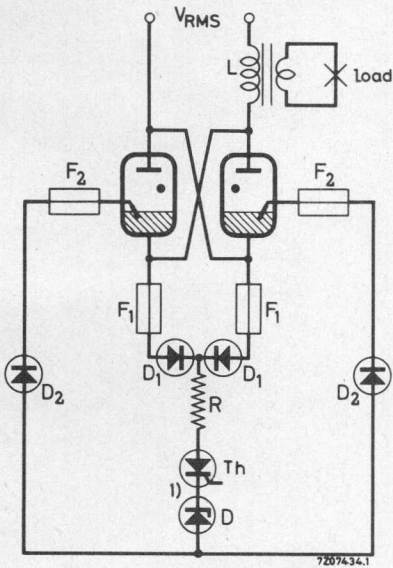

V_{RMS}	220	250	380	500	600	V
R	2	2	4	5	6	Ω
F_1	=	2 A fast response time				
F_2	=	10 A fast response time				
D	=	zener voltage ≥ 18 V				

Anode excitation with common thyristor

1) The thyristor-zener diode combination may be substituted by a thyatron.

IGNITOR CHARACTERISTICS AND IGNITION CIRCUIT REQUIREMENTS

(continued)

B. Separate excitation

Recommended circuit for separate excitation

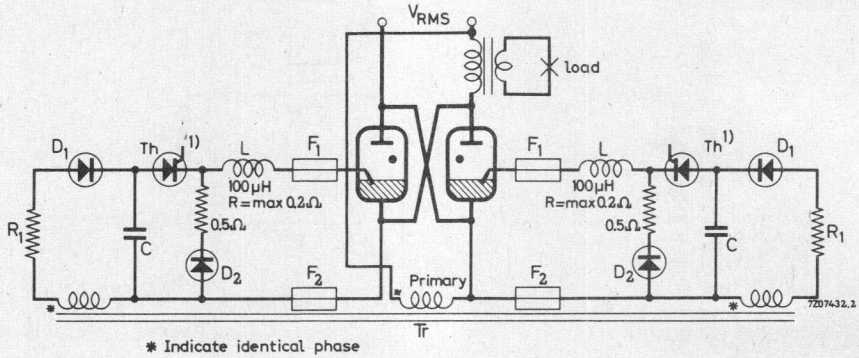

Capacitor value

C 2 8 μ F

Capacitor voltage

V_C 650 400 V \pm 10%

Peak value of closed circuit current

80 to 100 A

¹⁾ The thyristor may be substituted by a thyatron.

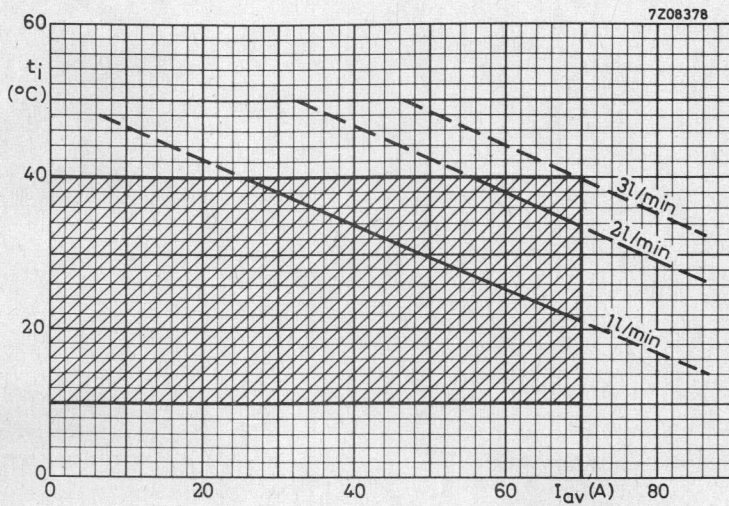
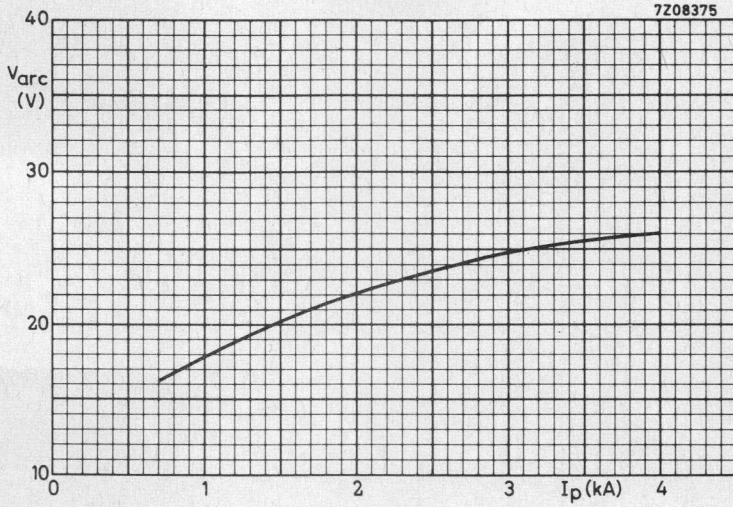

Minimum required continuous waterflow (two tubes cooled in series)

Graph to determine demand current versus duty factor as a function of the mains voltage (page 11)

Construction:

1. Determine cross points in the left hand graph for the chosen mains voltage (points a and b).
2. Draw horizontal lines from the points a and b to determine cross points a_1 and b_2 in the right hand graph.
3. The boundary of the operating area for the pertaining mains voltage is thus determined by straight line interconnections of b_1 , b_2 , a_1 , c, c_1 .

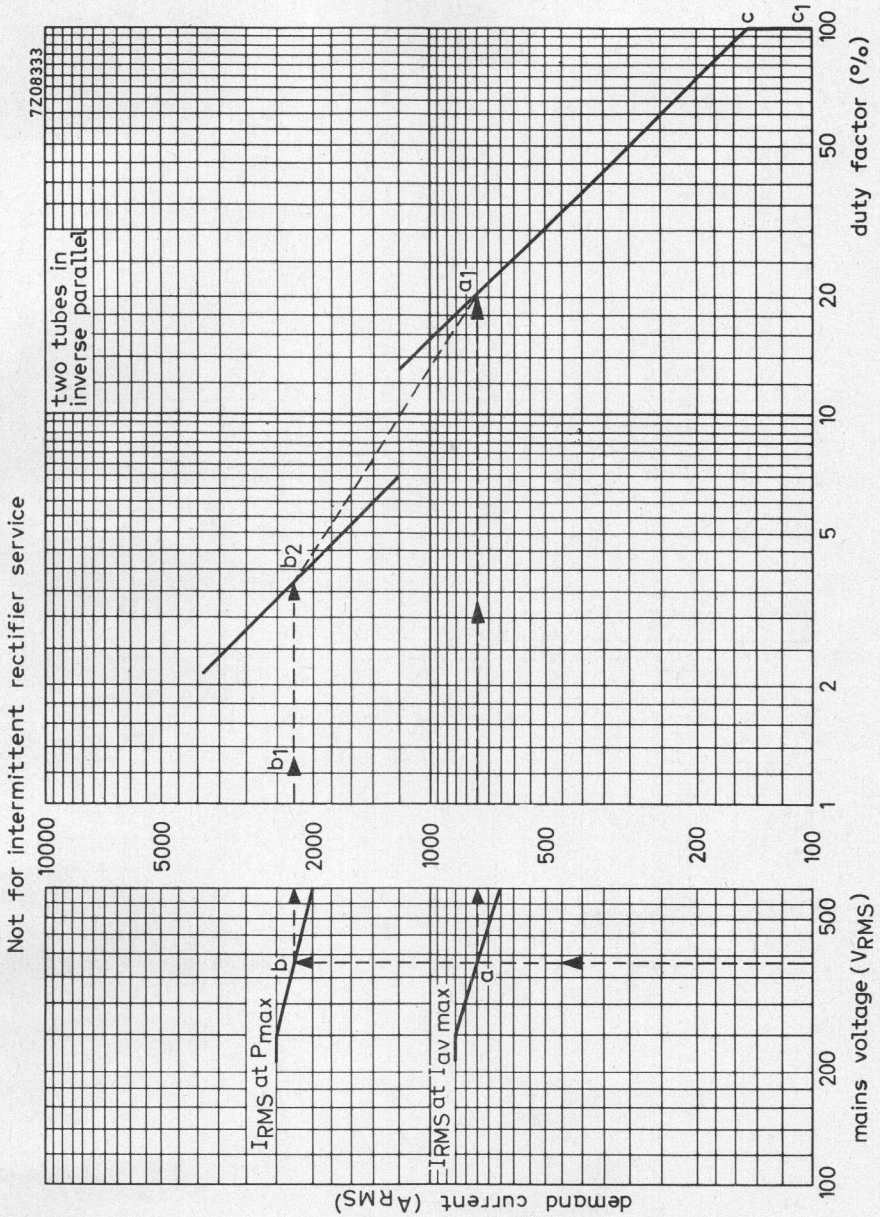

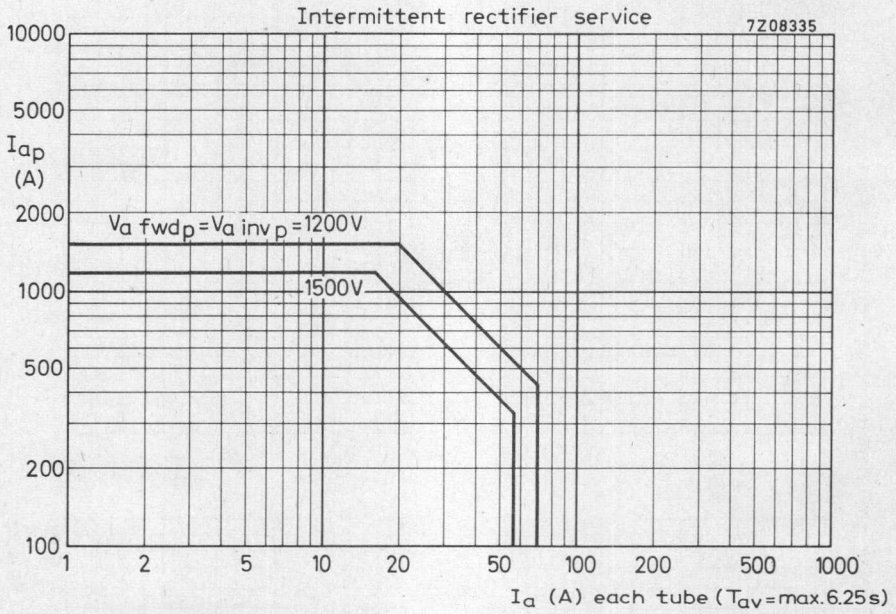

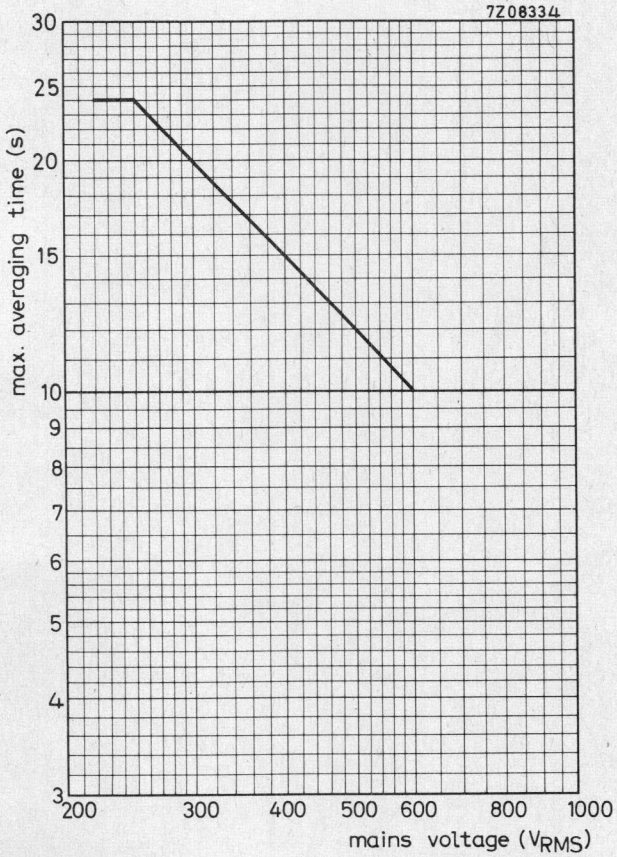

IGNITRON

Up-rated C-size ignitron intended for use in single-phase resistance welding control and similar a. c. control applications.

The tube has a plastic coated stainless steel watercooling jacket, quick change water connections and a temperature sensing pad for mounting of a thermostat.

QUICK REFERENCE DATA

Maximum demand power (two tubes in inverse parallel) at 600 V (r. m. s.)	2300	kVA
Maximum average current	180	A
Ignitor voltage	150	V
Ignitor current	max. 12	A

MECHANICAL DATA

Dimensions and connections	see page 2
Net mass	2900 g
Shipping mass	4160 g
Mounting position	vertical, anode connection up

Accessories

Ignitor cable	type 55351
Water hose connections : hose nipple coupling nut	type TE 1051c or TE 1051b
Overload protection thermostat	type 55306 or 55318
Water economy thermostat	type 55305 or 55317

TEMPERATURE LIMITS AND COOLING

TYPICAL CHARACTERISTICS

Pressure drop of cooling water (q = 6 l/min)	p_i	max. 0.2 kg/cm ²
Temperature rise at max. average current (q = 6 l/min)	$t_o - t_i$	max. 6 °C

LIMITING VALUES (Absolute max. rating system)

A.C. control service

Required water flow at max. average current (See also page 10)	q	min. 6 l/min
Inlet temperature ¹⁾	t_i	min. 10 °C max. 40 °C
Temperature of thermostat mount ²⁾	t_m	max. 50 °C

Pulse service

Under conditions of pulse service with low average load (less than 1 A) continuous cooling is normally not required. The cooling jacket can e.g. be permanently filled with oil.

Care should be taken to prevent condensation of mercury at the anode or glass seal. See also "Application directions ignitrons"

Recommended condensed mercury temperature	t_{Hg}	25 to 30 °C
-------------------------------------------	----------	-------------

¹⁾ When a number of tubes is cooled in series, $t_{i \text{ min}}$ refers to the coldest tube and $t_{i \text{ max}}$. to the hottest tube.

²⁾ WARNING: The thermostat mount is at full line voltage. When the cooling systems of a number of tubes are connected in series the overload protecting thermostat should be mounted on the last and the water economy thermostat on the last but one tube.

ELECTRICAL DATA

LIMITING VALUES (Absolute max. rating system)

The limiting values are based on full cycle conduction duty, with equally distributed load on all ignitrons, regardless of whether phase control is used or not.

The load must be limited so that at zero phase delay no overload will result.

Single phase A.C. control, two tubes in inverse parallel connection.

Table I. See also pages 8, 9 and 11.

Mains frequency range		25 to 60					Hz
Mains voltage	V_{RMS}	220 ¹⁾	250	380	500	600	V
Max. averaging time	$T_{av\ max}$	21.0	21.0	13.8	10.5	8.7	s
A. Max. demand power							
Max. demand power	P_{max}	1100	1250	1650	2000	2300	kVA
Corresponding max. average current	I_{av}	110	110	110	110	110	A
Demand current	I_{RMS}	5000	5000	4350	4000	3800	A
Duty factor	δ	4.9	4.9	5.6	6.1	6.4	%
Number of cycles within $T_{av\ max}$. ²⁾	$n(50\ Hz)$	51	51	38	32	27	$c/T_{av\ max}$
Integrated RMS load current	I_{FRMS}	1100	1100	1030	990	970	A
B. Max. average current							
Max. average current	$I_{av\ max}$	180	180	180	180	180	A
Corresponding max. demand power	P	340	415	550	670	760	kVA
Demand current	I_{RMS}	1650	1650	1450	1330	1270	A
Duty factor	δ	24.2	24.2	27.2	30.0	31.4	%
Number of cycles within $T_{av\ max}$. ²⁾	$n(50\ Hz)$	254	254	190	157	136	$c/T_{av\ max}$
Integrated RMS load current	I_{FRMS}	810	810	760	730	710	A
Max. surge current RMS	I_{surge}	14.0	14.0	12.2	11.2	10.6	kA
$(T_{max} = 0.15\ s)$							

¹⁾ For mains voltages below 250V(RMS) the max. demand current and max. averaging time valid at 250 V shall not be exceeded.

²⁾ This is the maximum integrated number of cycles a pair of tubes may conduct with or without interruption during the maximum averaging time:
 $n_{max} = \text{duty factor} \times T_{av\ max} \times \text{mains frequency}.$

ELECTRICAL DATA (continued)

Pulse service

Under certain conditions this ignitron may be used to switch aperiodic current pulses to a very high value (up to 100 kA) and voltages up to 10 kV. The performance depends on the circuit in which the tube is used. The manufacturer should be consulted.

IGNITOR CHARACTERISTICS AND IGNITION CIRCUIT REQUIREMENTS

LIMITING VALUES (Absolute max. rating system)

Ignitor voltage, forward peak	V_{igp}	max. 2000 V
inverse peak (including any transients)	$-V_{igp}$	max. 5 V
Ignitor current, forward peak	I_{igp}	max. 100 A
inverse peak	$-I_{igp}$	max. 0 A
forward RMS	I_{igRMS}	max. 10 A
forward average ($T_{av} = \text{max. } 5 \text{ s}$)	I_{ig}	max. 1 A

A. Anode excitation

Ignitor characteristics

Firing voltage	V_{ig}	150 V
Firing current	I_{ig}	6 to 8 A
		max. 12 A
Ignition time at the above voltage or current	T_{ig}	max. 50 μs ¹⁾

Ignition circuit requirements

Peak voltage required to fire	V_p	min. 200 V
Peak current required to fire	I_p	min. 12 A
Rate of rise of ignitor current	di/dT	min. 0.1 A/ μs

¹⁾ Ignition time is taken from the instant that the stated voltage and current are reached.

IGNITOR CHARACTERISTICS AND IGNITION CIRCUIT REQUIREMENTS

(continued)

Recommended circuits for anode excitation

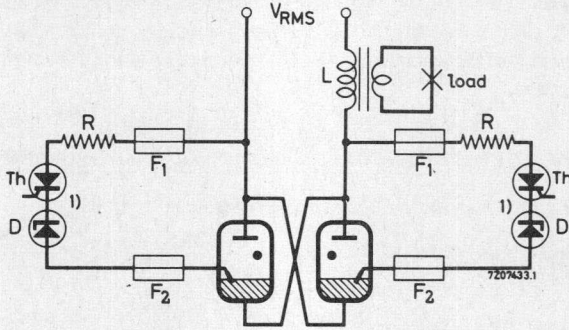

Anode excitation with individual thyristors

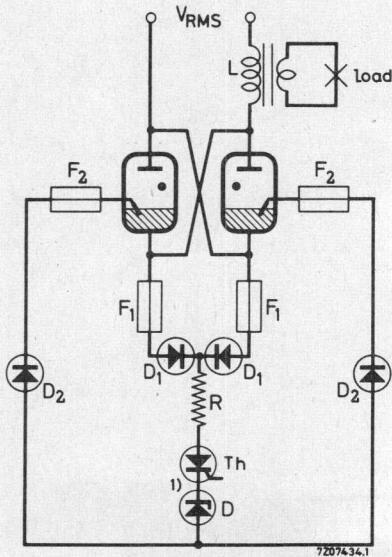

Anode excitation with common thyristor

V_{RMS}	220	250	380	500	600	V
R	2	2	4	5	6	Ω
F_1	= 2 A fast response time					
F_2	= 10 A fast response time					
D	= zener voltage ≥ 18 V					

1) The thyristor-zener diode combination may be substituted by a thyatron.

Graph to determine demand current versus duty factor as a function of the mains voltage (page 9)

Construction:

1. Determine cross points in the left hand graph for the chosen mains voltage (points a and b).
2. Draw horizontal lines from the points a and b to determine cross points a_1 and b_2 in the right hand graph.
3. The boundary of the operating area for the pertaining mains voltage is thus determined by straight line interconnections of b_1 , b_2 , a_1 , c, c_1 .

Not for intermittent rectifier service

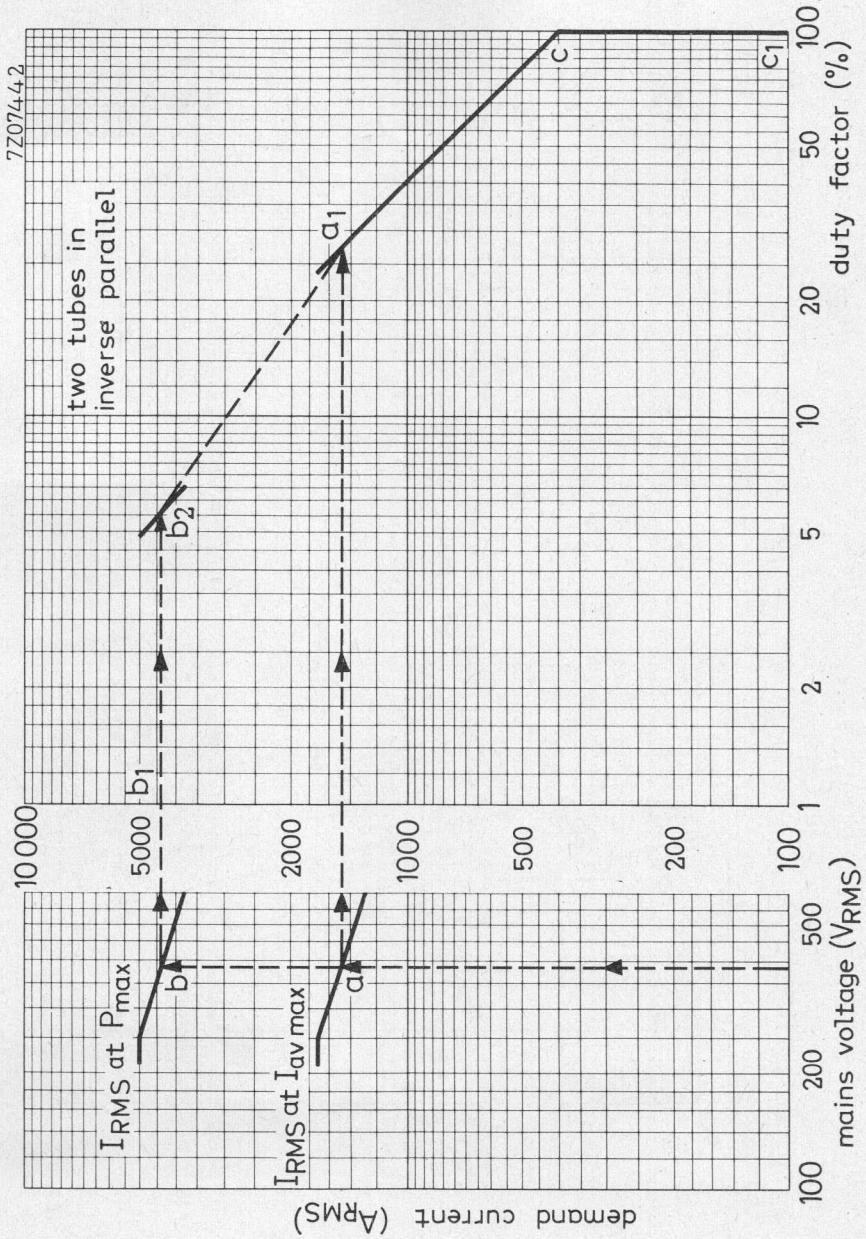

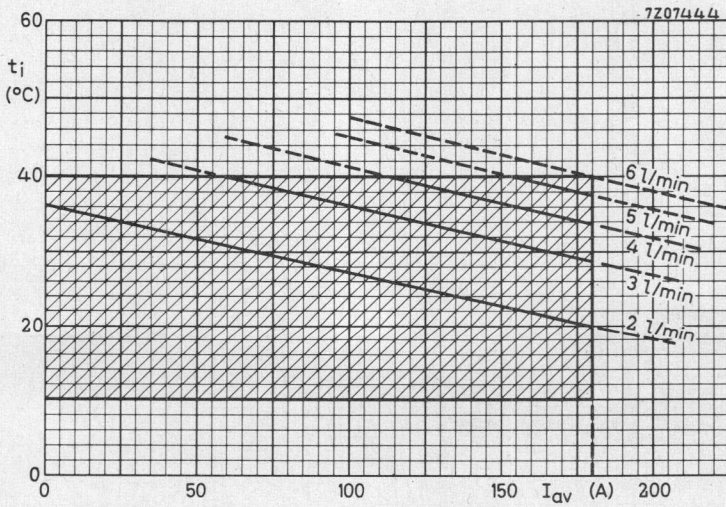
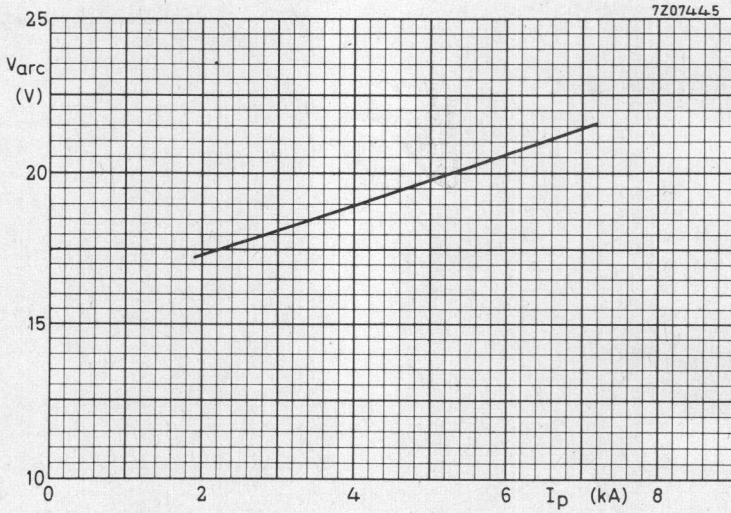

Minimum required continuous waterflow (two tubes cooled in series)

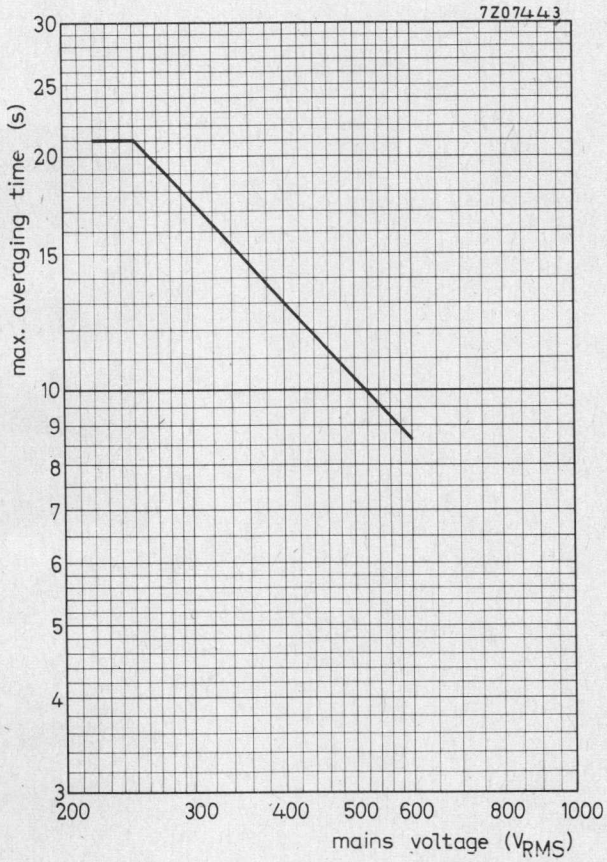

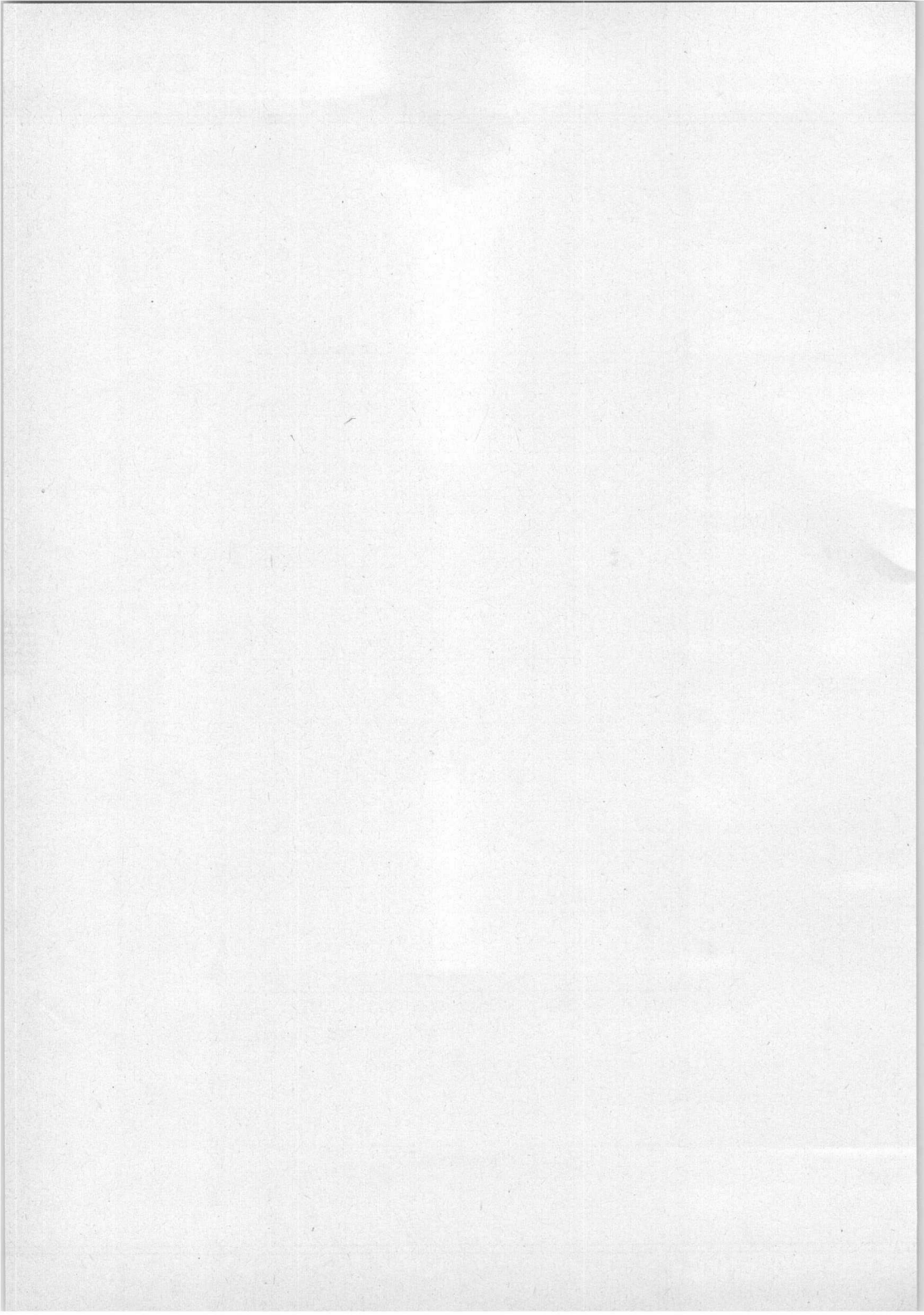

IGNITRON

D-size ignitron intended for use in single-phase resistance welding control and similar a. c. control applications.

The tube has a stainless steel watercooling jacket, quick change water connections and a temperature sensing pad for mounting of a thermostat.

QUICK REFERENCE DATA

Maximum demand power (two tubes in inverse parallel)	3225	kVA
Maximum average current	400	A
Ignitor voltage	180	V
Ignitor current	max. 12	A

MECHANICAL DATA

Dimensions and connections	see page 2
Net mass	8.5 kg
Shipping mass	10.8 kg
Mounting position	vertical, anode connection up

Accessories

Ignitor cable	type 55351
Water hose connections : hose nipple coupling nut	type TE 105 1c type TE 105 1b
Overload protection thermostat	type 55306 or 55318
Water economy thermostat	type 55305 or 55317

DIMENSIONS AND CONNECTIONS

Dimensions in mm

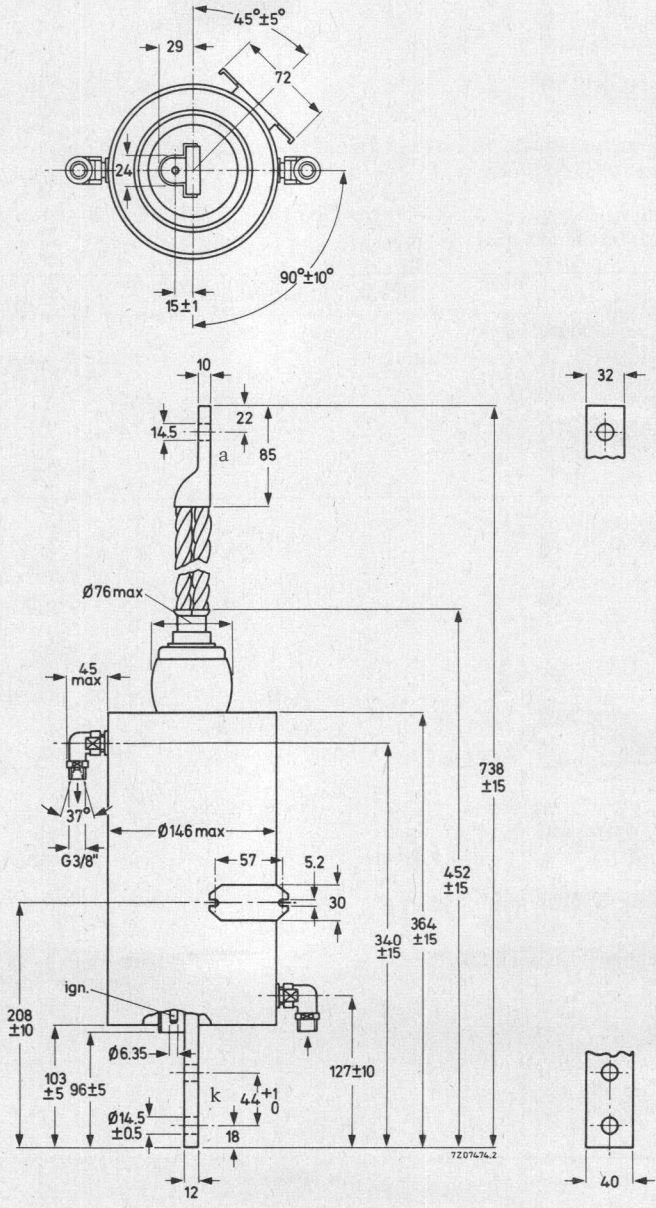

TEMPERATURE LIMITS AND COOLING

TYPICAL CHARACTERISTICS

Pressure drop of cooling water (q = 10 l/min)	p_i	max.	0.35	kg/cm ²
Temperature rise at max. average current (q = 10 l/min)	$t_o - t_i$		9	°C

LIMITING VALUES

A.C. control service

Required water flow at max. average current (See also page 8)	q	min.	10	l/min
Inlet temperature ¹⁾	t_i	min.	10	°C
		max.	40	°C
Temperature of thermostat mount ²⁾	t_m	max.	50	°C

¹⁾ When a number of tubes is cooled in series, t_i min. refers to the coldest tube and t_i max. to the hottest tube.

²⁾ WARNING. The thermostat mount is at full line voltage.
When the cooling systems of a number of tubes are connected in series the overload protecting thermostat should be mounted on the last and the water economy thermostat on the last but one tube.

ELECTRICAL DATA

LIMITING VALUES (Absolute max. rating system)

The limiting values are based on full cycle conduction duty, with equally distributed load on all ignitrons, regardless of whether phase control is used or not.

The load must be limited so that at zero phase delay no overload will result.

Single phase A. C. control, two tubes in inverse parallel connection

Table 1. See also pages 10, 11 and 12.

Mains frequency range	f	25 to 60					Hz
Mains voltage	V_{RMS}	220 ¹⁾	250	380	500	600	V
Max. averaging time	T_{avmax}	12.5	12.5	8.4	6.4	5.3	s
A. Max. demand power							
Max. demand power	P_{max}	2200	2500	2750	3000	3225	kVA
Corresponding average current	I_{av}	210	210	210	210	210	A
Demand current	I_{RMS}	10000	10000	7250	6000	5380	A
Duty factor	δ	4.7	4.7	6.5	7.8	8.7	%
Number of cycles within T_{avmax} ²⁾	n (50 Hz)	29	29	27	25	23	c/ T_{avmax} .
Integrated RMS load current	$I_{F RMS}$	2160	2160	1850	1670	1580	A
B. Max. average current							
Max. average current	I_{avmax}	400	400	400	400	400	A
Corresponding demand power	P	735	835	915	1000	1075	kVA
Demand current	I_{RMS}	3335	3335	2415	2000	1795	A
Duty factor	δ	26.6	26.6	36.8	44.4	49.5	%
Number of cycles within T_{avmax} ²⁾	n (50 Hz)	166	166	155	142	132	c/ T_{avmax} .
Integrated RMS load current	$I_{F RMS}$	1720	1720	1465	1330	1260	A
Max. surge current	$T_{max.} = 0.15$ s RMS I_{surge}	28	28	21	17	15	kA

1) For mains voltage below 250V(RMS) the max. demand current and max. averaging time valid at 250 V shall not be exceeded.

2) This is the maximum integrated number of cycles a pair of tubes may conduct with or without interruption during the maximum averaging time:

$$n_{max} = \text{duty factor} \times T_{avmax} \times \text{mains frequency.}$$

IGNITOR CHARACTERISTICS AND IGNITION CIRCUIT REQUIREMENTS

LIMITING VALUES (Absolute max. rating system)

Ignitor voltage, forward peak	V_{igp}	max. 2000 V
inverse peak (including any transients)	$-V_{igp}$	max. 5 V
Ignitor current, forward peak	I_{igp}	max. 100 A
inverse peak	$-I_{igp}$	max. 0 A
forward RMS	I_{igRMS}	max. 10 A
forward average ($T_{av} = \text{max. } 5 \text{ s}$)	I_{ig}	max. 1 A

A. Anode excitation

Ignitor characteristics

Firing voltage	V_{ig}	180 V
Firing current	I_{ig}	6 to 8 A max. 12 A
Ignition time at the above voltage or current	T_{ig}	max. 50 μs ¹⁾

Ignition circuit requirements

Peak voltage required to fire	V_p	min. 200 V
Peak current required for anode take over	I_p	12 A
Rate of rise of ignitor current	di/dT	min. 0.1 A/ μs

¹⁾ Ignition time is taken from the instant that the stated voltage and current are reached.

IGNITOR CHARACTERISTICS AND IGNITION CIRCUIT REQUIREMENTS

Recommended circuits for anode excitation

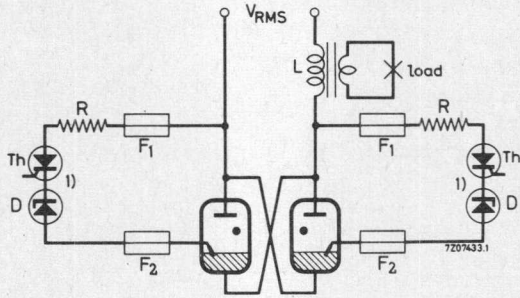

Anode excitation with individual thyristors

V_{RMS} 220 250 380 500 600 V

R 2 2 4 5 6 Ω

F_1 = 2 A fast response time

F_2 = 10 A fast response time

D = zener voltage ≥ 18 V

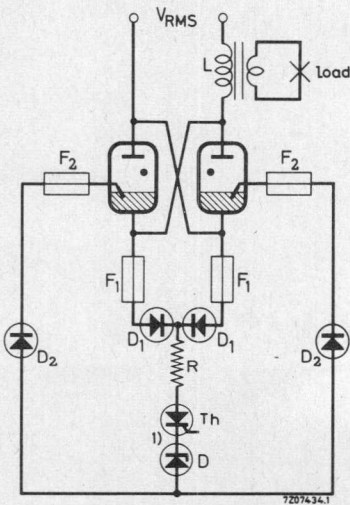

Anode excitation with common thyristor

1) The thyristor-zener diode combination may be substituted by a thyratron.

IGNITOR CHARACTERISTICS AND IGNITION CIRCUIT REQUIREMENTS

B. Separate excitation

Recommended circuit for separate excitation

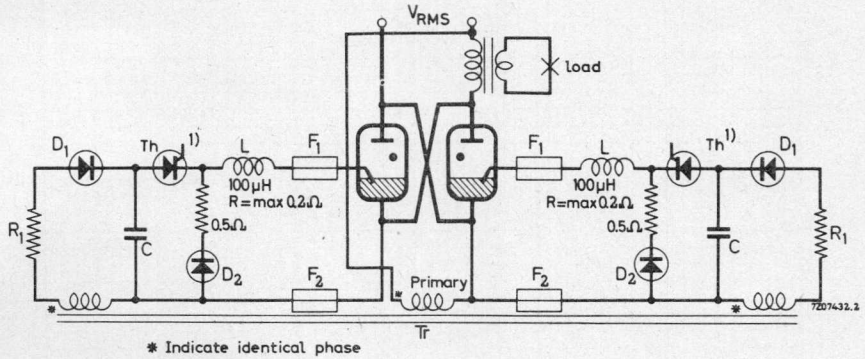

Capacitor value

2 μ F

Capacitor voltage

650 V \pm 10%

Peak value of closed circuit current

80 to 100 A

¹⁾ The thyristor may be substituted by a thyratron.

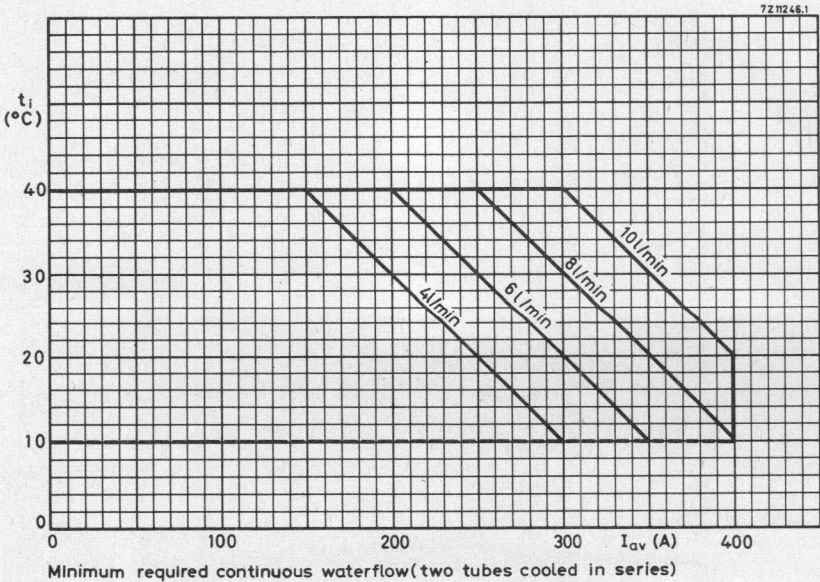
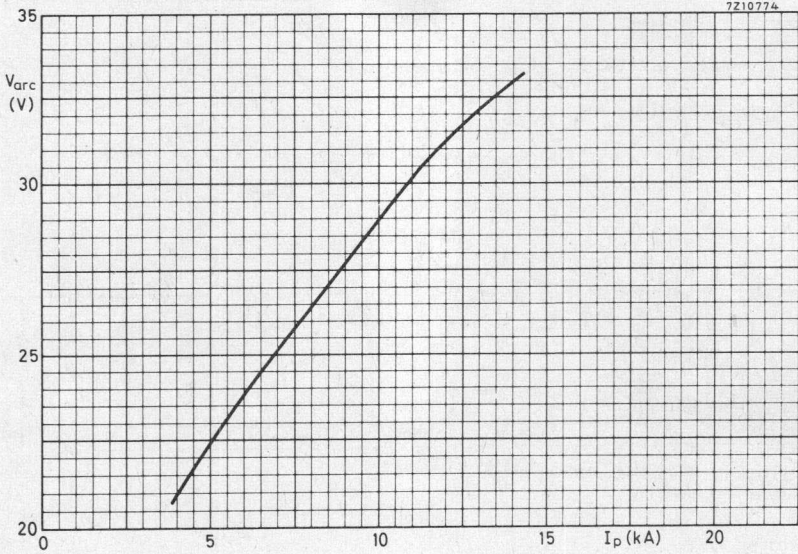

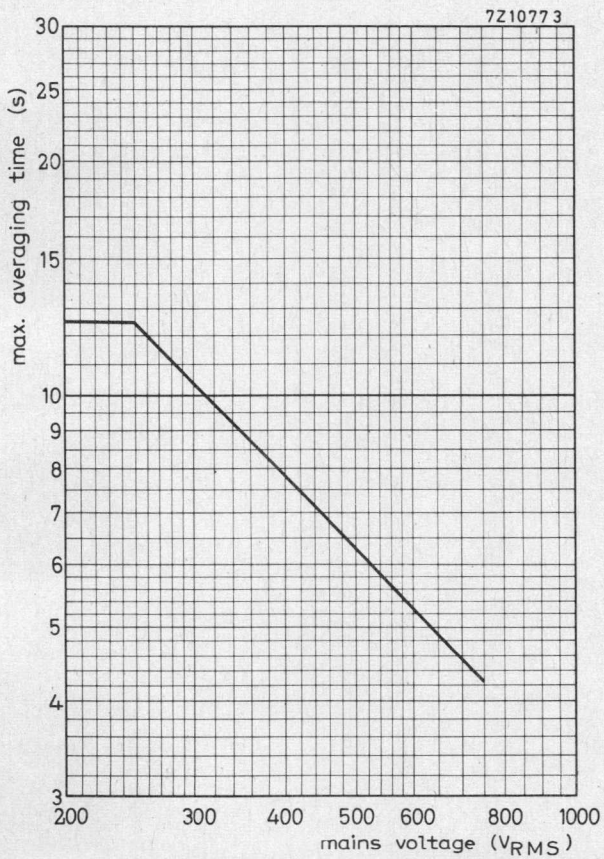

Graph to determine demand current versus duty factor as a function of the mains voltage (page 11)

Construction:

1. Determine cross points in the left hand graph for the chosen mains voltage (points a and b).
2. Draw horizontal lines from the points a and b to determine cross points a₁ and b₂ in the right hand graph.
3. The boundary of the operating area for the pertaining mains voltage is thus determined by straight line interconnections of b₁, b₂, a₁, c, c₁.

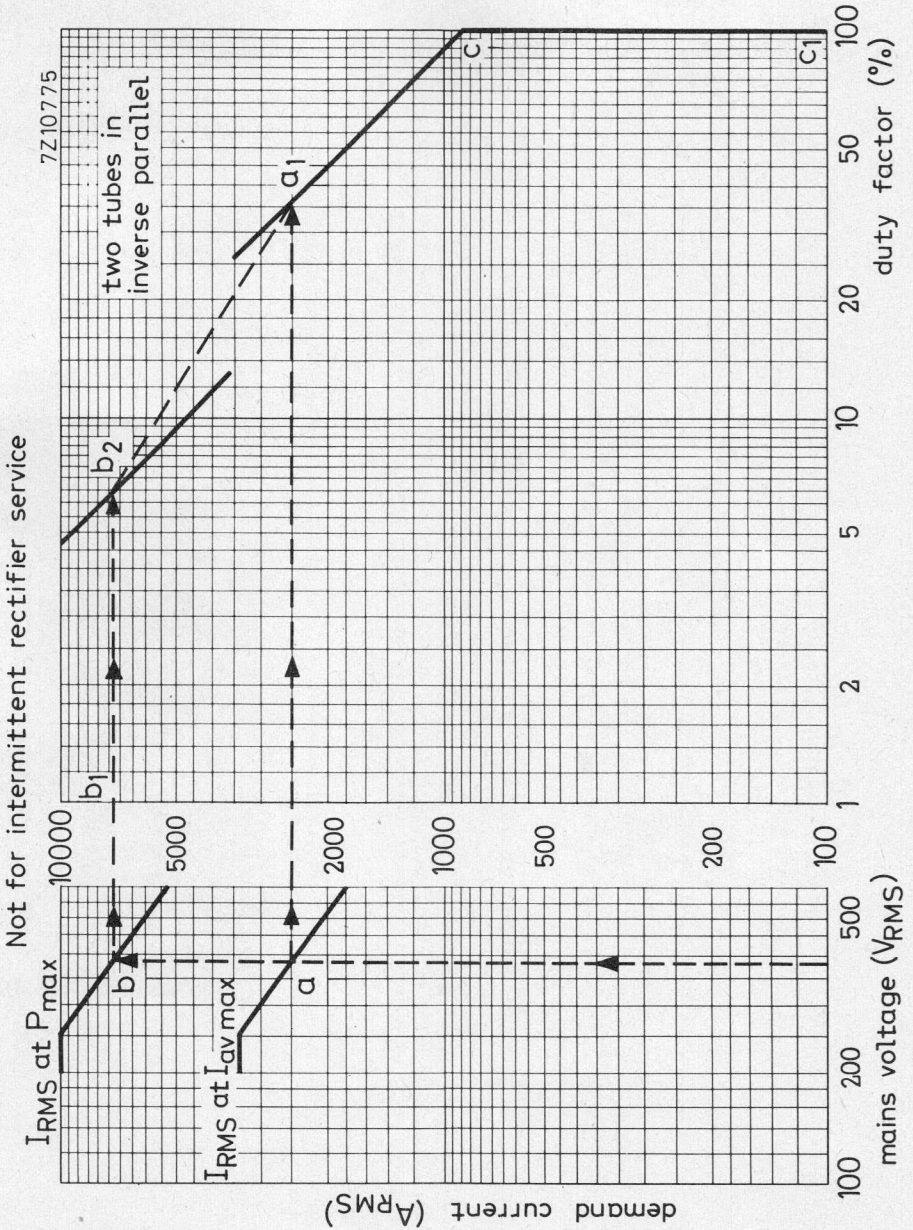

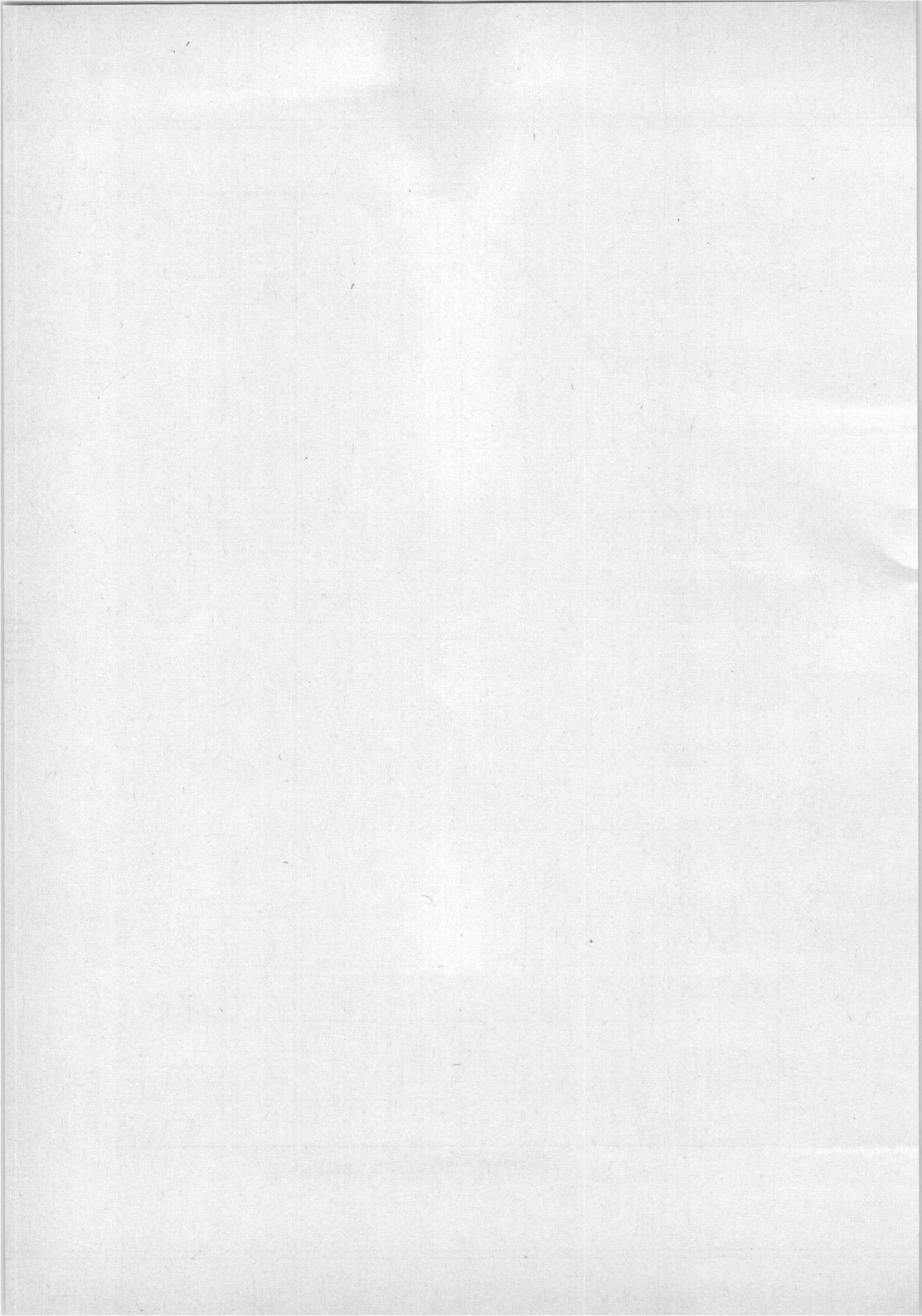

IGNITRON

B-size ignitron in coaxial construction intended for use in single-phase and three-phase resistance welding control and similar a. c. control applications.

The tube has a plastic coated stainless steel watercooling jacket, quick change water connections and a temperature sensing pad for mounting of a thermostat.

QUICK REFERENCE DATA

Maximum demand power (two tubes in inverse parallel)	600	kVA
Maximum average current	56	A
Ignitor voltage	150	V
Ignitor current	max. 12	A

MECHANICAL DATA

Dimensions and connections	see page 2
Net mass	1.4 kg
Shipping mass	2.1 kg,
Mounting position	vertical, anode connection up

Accessories

Ignitor cable	type 55351
Water hose connections : hose nipple coupling nut	type TE 1051c type TE 1051b
Overload protection thermostat	type 55306 or 55318
Water economy thermostat	type 55305 or 55317

DIMENSIONS AND CONNECTIONS

Dimensions in mm

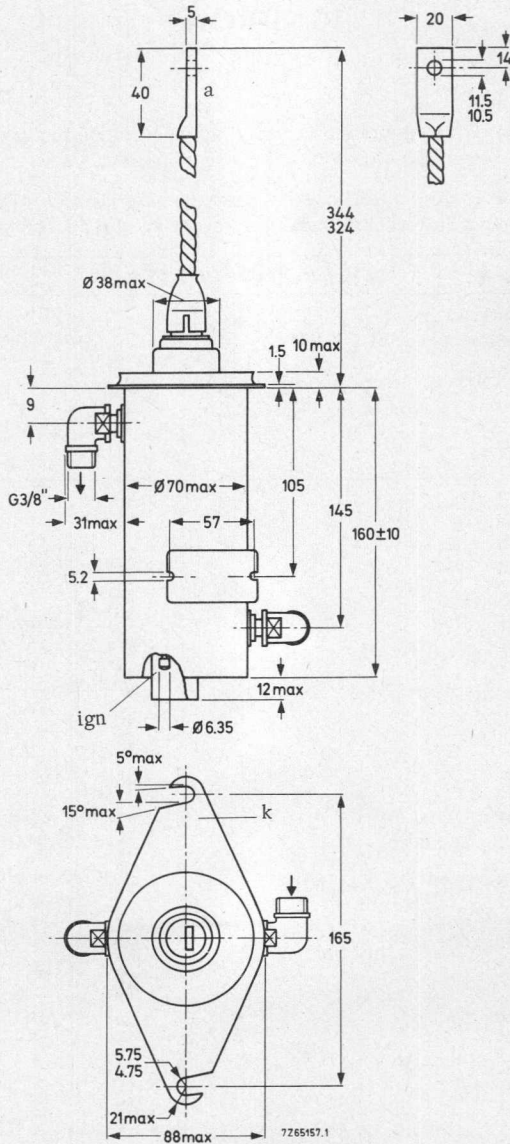

TEMPERATURE LIMITS AND COOLING

TYPICAL CHARACTERISTICS

Pressure drop of cooling water ($q = 2 \text{ l/min}$)	p_i	max.	0.08 kg/cm^2
Temperature rise at max. average current ($q = 2 \text{ l/min}$)	$t_o - t_i$	max.	$6 \text{ }^\circ\text{C}$

LIMITING VALUES (Absolute max. rating system)

A.C. control service

Required water flow at max. average current (See also page 9)	q	min.	2 l/min
Inlet temperature ¹⁾	t_i	min.	$10 \text{ }^\circ\text{C}$
		max.	$40 \text{ }^\circ\text{C}$
Temperature of thermostat mount ²⁾	t_m	max.	$50 \text{ }^\circ\text{C}$

Intermittent rectifier service or three-phase welding service

Required continuous water flow at max. average current	q	min.	2 l/min
Inlet temperature ¹⁾	t_i	min.	$10 \text{ }^\circ\text{C}$
		max.	$35 \text{ }^\circ\text{C}$
Temperature of thermostat mount ²⁾	t_m	max.	$45 \text{ }^\circ\text{C}$

Pulse service

Under conditions of pulse service with low average load (less than 1 A) continuous cooling is normally not required. The cooling jacket can e.g. be permanently filled with oil.

Care should be taken to prevent condensation of mercury at the anode or glass seal. See also "Application directions ignitrons".

Recommended condensed mercury temperature	t_{Hg}	$25 \text{ to } 30 \text{ }^\circ\text{C}$
-------------------------------------------	-----------------	--------------------------------------------

1) When a number of tubes is cooled in series, $t_{i \text{ min}}$ refers to the coldest tube and $t_{i \text{ max}}$ to the hottest tube.

2) WARNING. The thermostat mount is at full line voltage. When the cooling systems of a number of tubes are connected in series the over-load protecting thermostat should be mounted on the last and the water economy thermostat on the last but one tube.

ZX1081

ELECTRICAL DATA

For electrical data please refer to type ZX1051

IGNITRON

C-size ignitron in coaxial construction intended for use in single-phase resistance welding control and similar a. c. control applications.

The tube has a plastic coated stainless steel watercooling jacket, quick change water connections and a temperature sensing pad for mounting of a thermostat.

QUICK REFERENCE DATA

Maximum demand power (two tubes in inverse parallel)	1200	kVA
Maximum average current	140	A
Ignitor voltage	150	V
Ignitor current	max. 12	A

MECHANICAL DATA

Dimensions and connections	see page 2
Net mass	2.4 kg
Shipping mass	3.7 kg
Mounting position	vertical, anode connection up

Accessories

Ignitor cable	type 55351
Water hose connections : hose nipple coupling nut	type TE 1051c type TE 1051b
Overload protection thermostat	type 55306 or 55318
Water economy thermostat	type 55305 or 55317

DIMENSIONS AND CONNECTIONS

Dimensions in mm

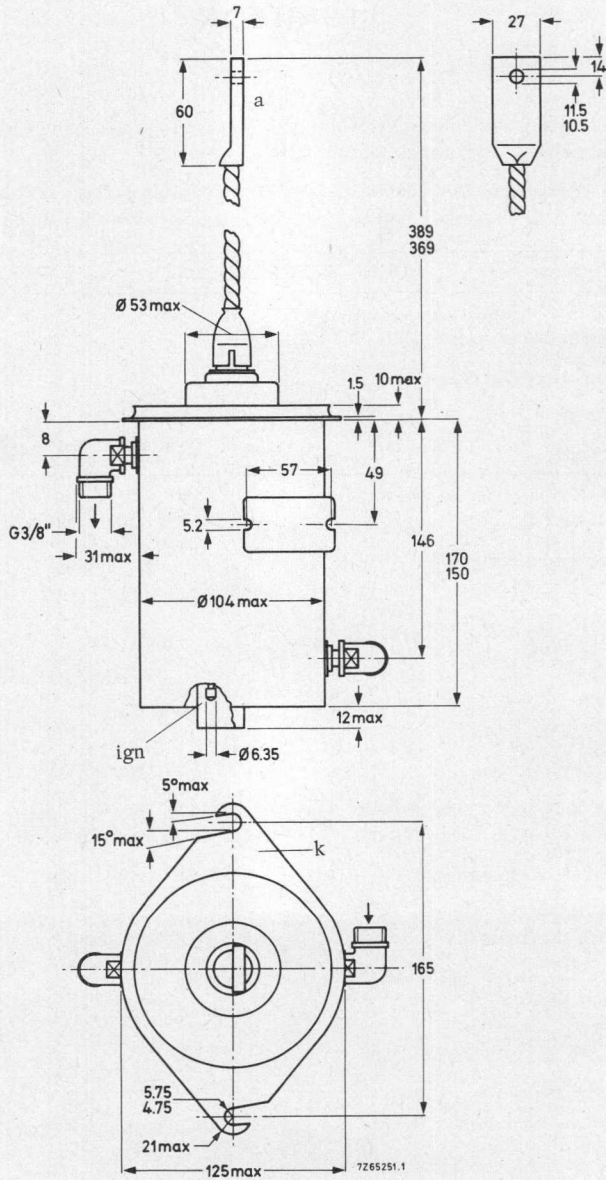

TEMPERATURE LIMITS AND COOLING

TYPICAL CHARACTERISTICS

Pressure drop of cooling water ($q = 5$ l/min)	p_i	max.	0.16	kg/cm ²
Temperature rise at max. average current ($q = 5$ l/min)	$t_o - t_i$	max.	6	°C

LIMITING VALUES (Absolute max. rating system)

A.C. control service

Required water flow at max. average current (See also page 10)	q	min	5	l/min
Inlet temperature ¹⁾	t_i	min.	10	°C
		max.	40	°C
Temperature of thermostat mount ²⁾	t_m	max.	50	°C

Pulse service

Under conditions of pulse service with low average load (less than 1 A) continuous cooling is normally not required. The cooling jacket can e. g. be permanently filled with oil.

Care should be taken to prevent condensation of mercury at the anode or glass seal. See also "Application directions ignitrons"

Recommended condensed mercury temperature	t_{Hg}	25 to 30	°C
-------------------------------------------	----------	----------	----

1) When a number of tubes is cooled in series, $t_{i\min.}$ refers to the coldest tube and $t_{i\max.}$ to the hottest.

2) WARNING. The thermostat mount is at full line voltage.

When the cooling systems of a number of tubes are connected in series the over-load protecting thermostat should be mounted on the last and the water economy thermostat on the last but one tube.

For electrical data please refer to type ZX1052

High-voltage rectifying tubes



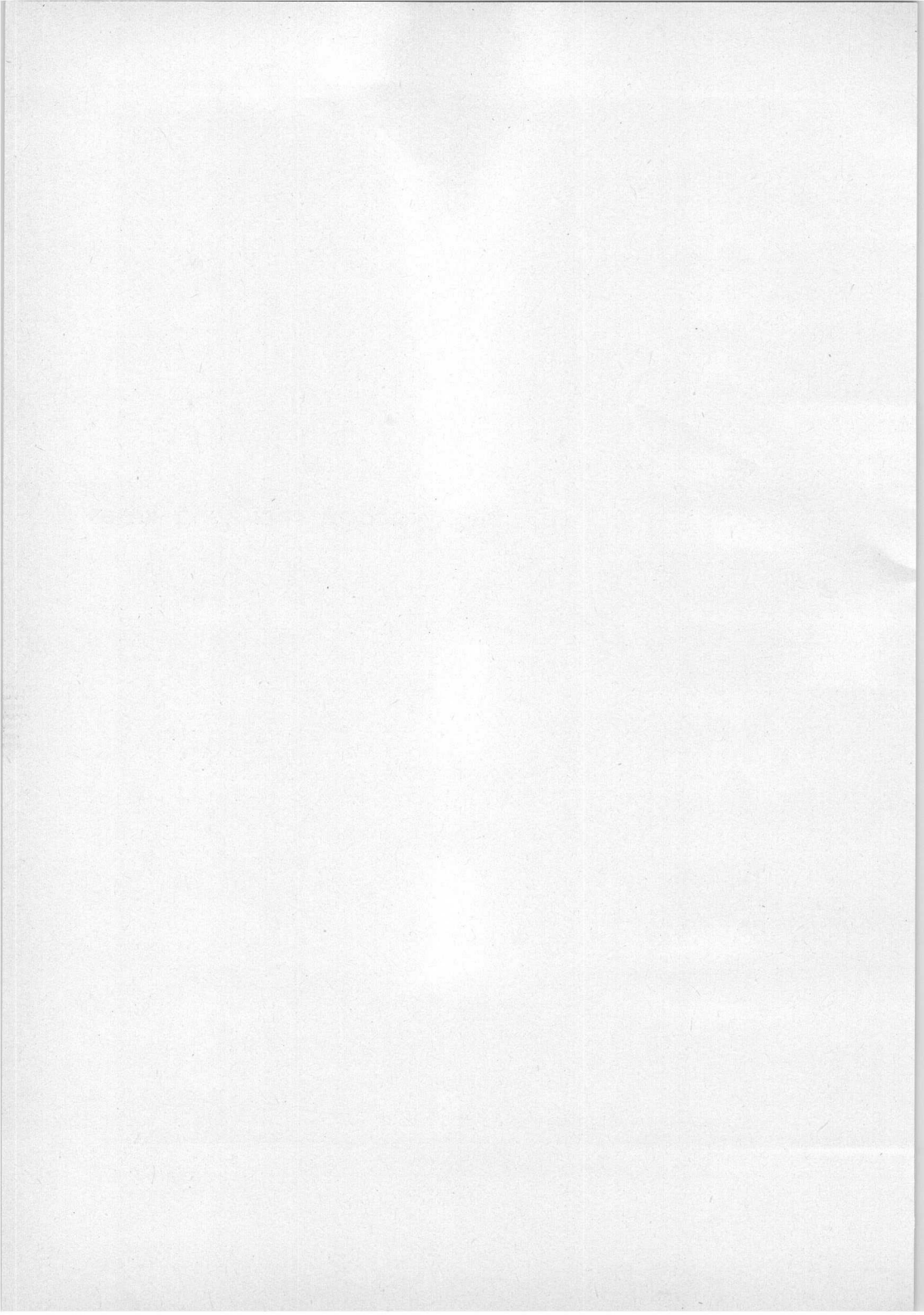

HIGH-VOLTAGE RECTIFYING TUBES

LIST OF SYMBOLS

Remarks

- a. In the case of indirectly heated tubes the voltages on the various electrodes are with respect to the cathode, in the case of a. c. fed, directly heated tubes with respect to the electrical centre of the filament, unless otherwise stated.
- b. The symbols for voltages and currents quoted below represent the average values of the concerning voltages and currents, unless otherwise stated.
- c. The positive electrical current is directed opposite to the direction of the electron current

Anode	a
Capacitance between anode and grid (the other elements being earthed)	C_{ag}
Capacitance between grid and all other elements except anode	C_g
Frequency	f
Filament or heater	f
Grid	g
Anode current	I_a
Filament or heater current	I_f
Grid current	I_g
D. C. output current of a rectifying tube	I_o
Peak value of a current	I_p
Fault current	I_{surge}
Cathode	k
Resistance in grid lead	R_g
Ambient temperature	t_{amb}
Averaging time	T_{av}
Deionisation time	T_{dion}
Temperature of condensed mercury	t_{Hg}
Ionisation time	T_{ion}

Waiting time (= time which has to pass between switching on of the filament or heater voltage and switching on of the other voltages)	T_w
Anode voltage	V_a
Arc voltage	V_{arc}
Heater voltage	V_f
Grid voltage	V_g
Inverse voltage	V_{inv}
D.C. voltage supplied by a rectifying tube	V_o
Secondary transformer voltage	V_{tr}
Output power	W_o

GENERAL OPERATIONAL RECOMMENDATIONS HIGH-VOLTAGE RECTIFYING TUBES

The following instructions apply in general to all types of high-voltage rectifying tubes. If there are additional instructions for any type of tube it will be indicated on the technical data sheets of the concerning type.

MOUNTING

The mercury-vapour filled types must be mounted vertically with the base or filament strips at the lower end. The mounting position of the gas-filled types is in general arbitrary.

The tubes must be mounted so that air can circulate freely around them. Therefore the clearance between the tubes and other components of the circuit and between the tubes and the cabinet walls should be at least half the maximum bulb diameter. The minimum clearance between tubes should be $3/4$ the maximum bulb diameter.

It should be realised that a minimum clearance is also required for reasons of high voltage insulation.

When a tube is operating and the cooling is only obtained by natural convection the temperature distribution along the bulb will be such that the lowest temperature occurs at the bottom. This distribution is of special importance in the case of mercury-vapour filled types in order to condense the mercury-vapour in the lower part of the tube. Where additional cooling is necessary this cooling should not disturb this normal temperature distribution along the bulb.

Generally if shock or vibration exceeds 0.5 g a shock absorbing device should be used.

The electrode connections, except those of the tube socket, must be flexible. The nuts (e.g. of the anode connections) should be well tightened but care must be taken to ensure that no undue forces are exerted on the tube. The contacts must be checked at regular intervals and their surfaces kept clean in order to avoid excessive heating of the glass-metal seals. The cross section of the conductors should be sufficient to avoid overheating by the current. However, to maintain the normal temperature distribution along the bulb the conductors should not conduct too much heat away from the tube. (It should be noted that in rectifier circuits the r.m.s. value of the anode current may reach 2.5 times the average value.)

FILAMENT SUPPLY

In order to obtain the maximum life of a directly heated cathode, a filament transformer with centre-tap and a phase shift of $90^\circ \pm 30^\circ$ between V_a and V_f is recommended. Series connection of filaments is not allowable.

The filament voltage at nominal mains voltage must be measured at the terminals of the tube. Permanent deviations up to 2.5% from the published value can be accepted. It is therefore recommended that the filament transformer be equipped with suitable tapings. Temporary variations should not exceed 5%.

However to ensure maximum life it is important to keep the filament voltage as near as possible to the nominal value.

In calculating the rating of the filament transformer a spread in the filament current of $\pm 10\%$ from tube to tube should be taken into account, whilst for directly heated tubes the d.c. current flowing through the heater winding should also be considered. It is recommended to furnish the filament transformer with several taps on the primary especially in case of h.t. -insulated high magnetic leakage transformers.

TEMPERATURE

1. Tubes filled with mercury vapour

In the technical data of these tube types temperature limits for the condensed mercury are given. During operation the condensed mercury should only be visible in the neighbourhood of the socket or the lowest part of the bulb. Care should be taken to ensure that the condensed mercury temperature during operation is between the published temperature limits. Too low a temperature gives low gas pressure which results in a low current carrying capability, high arc drop and consequently shortening of life. Too high a temperature gives high gas pressure which results in a reduction of the permissible peak inverse and forward voltage.

Accurate values of the condensed mercury temperature can be measured by means of a thermocouple placed against the envelope, but good technique and instruments are necessary for this measurement. In general temperature values of sufficient accuracy can be obtained by using a normal mercury thermometer the mercury vessel of which is wrapped in staniol strips and that can be fixed against the bulb by means of a cotton thread.

The temperature measurements should be made at the coldest part of the bulb where the mercury vapour condenses which in general will be just above the base or the lower connections.

In addition to the temperature limits for the condensed mercury sometimes limits for the ambient temperature are given. For each type there is a specific difference between ambient and condensed mercury temperature. High ambient temperature can make it desirable to decrease this difference, which can be

obtained by directing a low velocity air flow of ambient temperature or less to the glass just above the base.

The condensed mercury temperature is decisive in all cases.

The ambient temperature can be measured by a thermometer which has been screened against direct heat radiation. The measurement should be carried out at a distance of max. once and min. half the tube diameter from the tube at the same height as the condensed mercury or just above the base.

2. Tubes with inert gas filling.

For these tubes only the limits of the ambient temperature are given. These limits are in general minimum -55°C and maximum $+75^{\circ}\text{C}$.

SWITCHING ON

If switching on of the rectifier takes place twice a day or less the allowable peak anode current when switching on may amount up to twice the maximum published value for I_{a_p} .

1. Tubes filled with mercury vapour.

It is necessary to allow time for the cathode to reach its operating temperature before drawing anode current. Therefore the minimum cathode heating time is given in the published data sheets of each type. After the cathode heating time the high voltage may be switched on provided the temperature of the condensed mercury is not too low and all the condensed mercury is confined to the lower part of the bulb.

Sometimes a heat conserving hood is prescribed for the tube. The purpose of this hood is to avoid condensation of the mercury vapour on the electrodes and upper part of the bulb whilst the tube is cooling.

Switching on (not after transport) may be done at a condensed mercury temperature which lies 5 to 10°C below the published minimum temperature (minimum waiting time required). However, it is good practice to switch on after the temperature has reached its minimum published value (recommended waiting time).

The waiting times, the minimum required and the recommended one can be read from the curve representing the condensed mercury temperature rise as a function of time with only the filament voltage applied to the tube.

Switching on after transport or after a considerable interruption of operation should be done according to the instructions on the published data sheets.

In order to avoid long preheating times it is recommended to leave the filament supply on during standby periods (e.g. overnight) at 60 to 80% of the nominal value.

Standby position for mercury vapour filled tubes.

In order to have a spare tube always ready for immediate operation it is recommended to have a spare position where a tube stands with continuously a filament voltage of 60-80% of the nominal voltage applied.

When for a certain type a heat conserving hood is prescribed this hood should be fitted on the tube.

2. Tubes with inert gas-filling

It is necessary to allow the cathode to reach operating temperature before drawing anode current. The relevant minimum cathode heating time is given in the technical data sheets of each type. After warming up the anode voltage may be applied provided that the ambient temperature is not below the minimum published value.

No other delays apart from the cathode heating delay are required.

LIMITING VALUES

The limiting values should be used in accordance with the "Absolute maximum rating system" as defined by IEC publication 134.

Absolute maximum rating system. Absolute maximum ratings are limiting values of operating and environmental conditions applicable to any electronic device of a specified type as defined by its published data, and should not be exceeded under the worst probable conditions.

These values are chosen by the device manufacturer to provide acceptable serviceability of the device, taking no responsibility for equipment variations, environmental variations, and the effects of changes in operating conditions due to variations in the characteristics of the device under consideration and of all other electronic devices in the equipment.

The equipment manufacturer should design so that, initially and throughout life, no absolute-maximum value for the intended service is exceeded with any device under the worst probable operating conditions with respect to supply voltage variation, equipment components variation, equipment control adjustment, load variations, signal variation, environmental conditions, and variations in characteristics of the device under consideration and of all other electronic devices in the equipment.

For some ratings of average current a maximum averaging time is quoted. This is to ensure that an anode current greater than the maximum continuously permissible average value is not drawn for such a length of time as would give rise to an excessive temperature within the tube.

The maximum peak anode current is determined by the available safe cathode emission whereas the average current is limited by its heating effects. During normal operation or frequent switching the peak current should not exceed its

maximum published value.

For the determination of the actual value of the peak inverse voltage and the peak anode current, the measured values with an oscilloscope or otherwise are decisive.

The I_{surge} is the maximum fault current which should ever be allowed to pass through the tube. (See section "Short circuit protection".)

DESIGN VALUES

1. V_{arc}

The value published for V_{arc} applies to average operating conditions.

2. Frequency

Unless otherwise stated the maximum frequency at which the tubes may run under full load is 150 Hz. Under special conditions (derating of voltage and current) higher frequencies may be used; details should be obtained from the manufacturer.

TYPICAL OPERATING CONDITIONS

Sometimes 2 columns of operating conditions are given viz. one giving theoretical values based on the absolute maxima and one giving more practical values in which mains fluctuations of max. 10% and a voltage drop in tube, transformer, filter etc. of max. 8% are incorporated.

SHORT CIRCUIT PROTECTION

In order to prevent the tube from being damaged by passing too high a fault current a value for the maximum permissible surge current is given.

The figure given for the maximum surge current is intended as a guide to equipment designers. It indicates the maximum value of a transient current resulting from a sudden overload or short circuit which the rectifier can pass for a period not exceeding 0.1 second without resulting in its immediate destruction. Several overloads of this nature will, however, considerably reduce the life of the tube.

The equipment designer has to take into account this maximum surge current rating when calculating the short-circuit impedance of the equipment.

This surge current value is not intended as a peak current that may occur during switching-on or during operation.

A simple method to limit the surge current to the maximum rating is to put a series resistance in the anode circuit which in most cases will also be necessary because the relation between the ohmic and the inductive resistance of the short circuit path should be at least 0.3.

SCREENING AND INTERFERENCE

In order to prevent unwanted ionisation of the gas filling (and consequent flash over) due to strong r.f. fields, it may be necessary to enclose the rectifier in a separate earthed screening box. Of course r.f. should be prevented from reaching the rectifier by r.f. chokes and condensers.

In circuits with gas filled tubes oscillation in the transformer windings can occur especially in grid controlled circuits. These oscillations should be reduced by suitable circuits as excessive peak inverse voltages may occur, causing arc back. The use of two parallel RC circuits is advisable.

An air choke in the order of $100\mu\text{H}$ should be connected in series with and close to the anode connection. This choke can advantageously be wound from resistance wire in order to help short circuit protection.

SMOOTHING CIRCUITS

In order to limit the peak anode current in a rectifying tube it is necessary to use a choke-input filter.

If switching on of the rectifier takes place twice a day or less the allowable peak anode current when switching on may reach a value of twice the published max. value for I_{ap} .

To ensure good voltage regulation on fluctuating loads the inductance value of the choke should be large enough to give uninterrupted current at minimum load. The choke and capacitor must not resonate at the supply or ripple frequency. Damping of this choke will be necessary.

In grid controlled rectifier circuits under "phased back" conditions the harmonic content of the d.c. output will be large unless the inductance is adequate.

PARALLEL OPERATION OF MERCURY-VAPOUR OF GAS-FILLED TUBES

As individual gas or mercury-vapour filled tubes may have slightly different characteristics two or more tubes must not be connected directly in parallel.

Parallel operation is permissible when series resistances are used and the peak voltage drop over this series resistance is at least the ignition voltage. Coupling transformers in the anode leads of parallel connected tubes can serve the same purpose.

GRID CONTROLLED RECTIFIERS

When a thyatron is conducting, a positive ion current of a magnitude proportional to the cathode current is generated. This current will, in general, flow to that electrode which is at the most negative potential during conduction (e.g. the grid). In order to prevent damage to the tube it is necessary to ensure that

the voltage of this electrode is less negative than -10 volts during this phase. This precaution will prevent an increase in electrode emission due to excessive electrode dissipation, sputtering of electrode material, changes in the control characteristics caused by shift in contact potential and, in the case of inert gas-filled tubes, a rapid gas clean-up. The minimum allowable value of the grid resistor is 0.1 x the recommended one.

In circuits where the anode potential changes from a positive to a negative value and the control grid is at a positive potential, thereby drawing grid current, a small positive ion current flows to the anode. At high negative anode voltages it is therefore essential to limit the magnitude of the positive ion current by severely restricting the current flowing from cathode to grid.

This may be effected by using fixed negative grid bias and narrow positive firing pulses.

However, for bridge circuits the minimum width of these pulses should be sufficiently large to secure safe "take-over" of the discharge.

In those circuits where the anode potential changes very rapidly from a positive to a high negative value, such as with inductive loads fed from polyphase supplies, there will be residual positive ions within the tube which will be drawn towards the anode with considerable energy. In the case of an inert gas-filled tube this would result in excessive gas clean-up and it is therefore necessary to observe the limitations imposed by the commutation factor.

CONTROL CHARACTERISTICS

In most cases the control characteristic given on the data sheets is shown by upper and lower boundary curves within which all tubes may be expected to remain at all temperatures of the published range and during life.

In multitube circuits where the tubes are operating under the same conditions the spread will in general be smaller.

The published boundaries are therefore to be considered as extreme limits. This should be taken into consideration when designing grid excitation circuits.

GRID EXCITATION CIRCUITS

To keep the instant of ignition as constant as possible a large value of excitation voltage is recommended.

The use of a negative grid bias (50 to 120 volts) and a sharp positive grid pulse is recommended. The magnitude of the grid pulse should be 100 to 200 volts with a grid series resistor of 10 k Ω and a maximum impedance of the peaking transformer of 10 k Ω . If a sinusoidal grid voltage is used r.m.s. values of 50 to 120 volts in combination with a negative grid bias of 50 to 120 volts are recommended.

BRIDGE CIRCUITS (diagrams b, d and g)

For output voltages of more than 6 kV bridge circuits are recommended because of the lower peak inverse anode voltage and the larger range of applicable ambient temperatures.

The current angle of the grid should be for 2 phase bridge circuits $> 90^\circ$, for 3 phase $> 60^\circ$, and for 4 phase $> 45^\circ$.

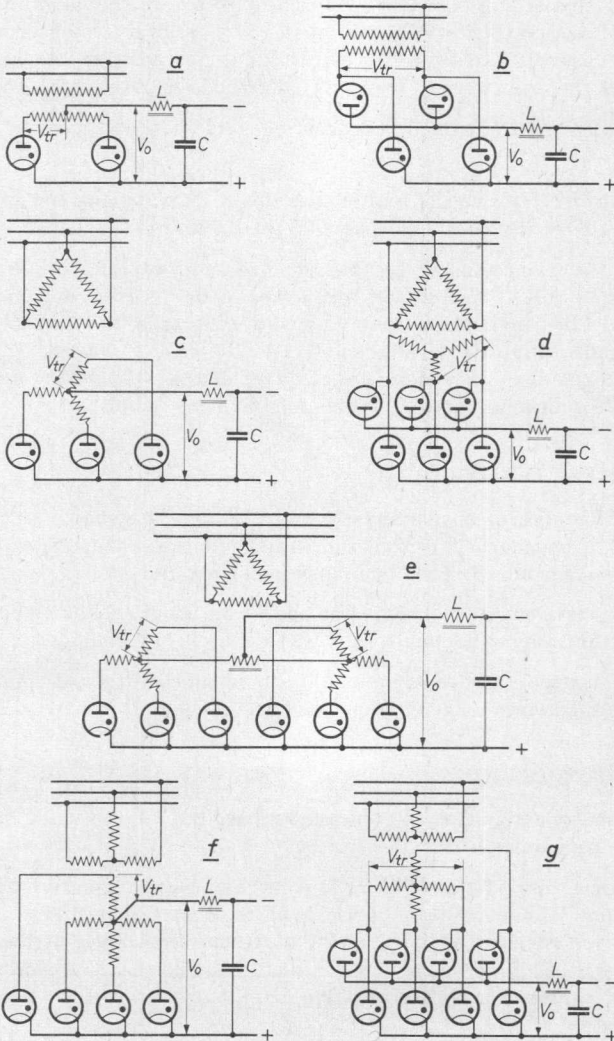

GRID-CONTROLLED HIGH-VOLTAGE MERCURY-VAPOUR RECTIFYING TUBE

QUICK REFERENCE DATA

Peak inverse voltage	$V_{a \text{ inv}_p}$	max.	13 kV
Peak forward voltage	V_{a_p}	max.	13 kV
Output current	I_o	max.	1 A
Peak anode current	I_{a_p}	max.	4 A
Negative grid voltage	$-V_g$	max.	300 V
Peak grid current	I_{g_p}	max.	50 mA

For electrical data please refer to type DCG6/6000

MECHANICAL DATA (Dimensions in mm)

Base : Jumbo 4 p. with bayonet

Socket : 2422 511 02001

Anode cap : 40616

This cap must always be mounted on the tube, thus also during preheating

Net weight : 240 g

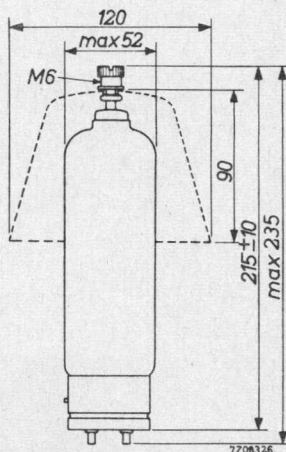
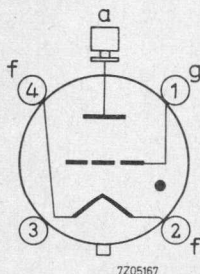

Mounting position: vertical with base down

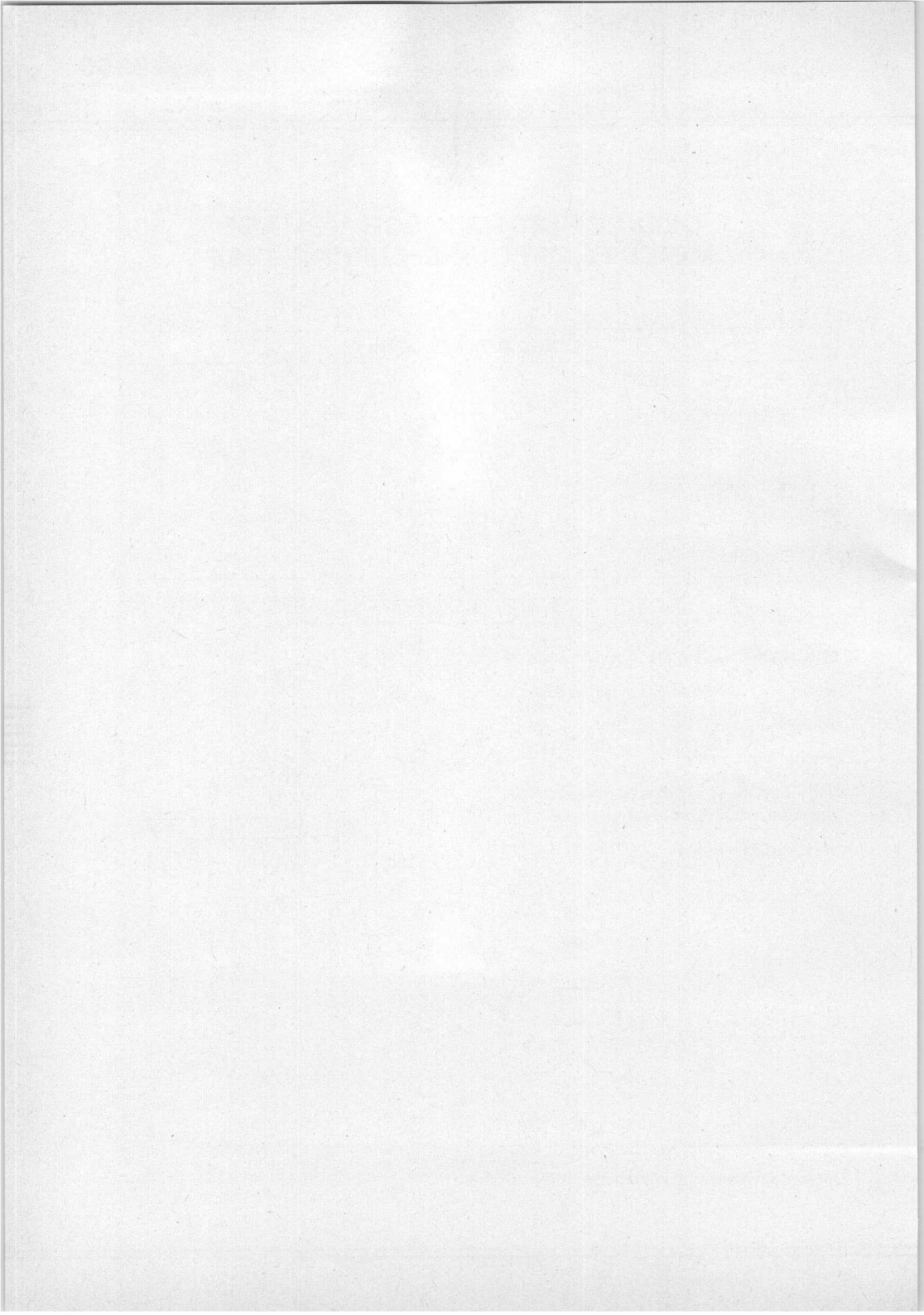

HIGH-VOLTAGE MERCURY-VAPOUR RECTIFYING TUBE

QUICK REFERENCE DATA			
Peak inverse voltage	$V_{a\text{ invp}}$	= max. 10 kV	max. 2 kV
Output current	I_o	= max. 0.25 A	max. 0.5 A
Peak anode current	I_{ap}	= max. 1 A	max. 2 A

HEATING: direct; filament oxide-coated

Filament voltage	V_f	=	2.5 V
Filament current	I_f	=	4.8 A
Cathode heating time	T_w	=	min. 30 s

Phase shift of $90^\circ \pm 30^\circ$ between V_a and V_f and use of a centre-tapped filament transformer is recommended

After transport and after a long interruption of service a waiting time of at least 30 minutes between the switching on of the filament voltage and the switching on of the anode voltage should be observed

TYPICAL CHARACTERISTICS

Arc voltage $V_{\text{arc}} (I_a = 0.25 \text{ A}) = 12 \text{ V}$

LIMITING VALUES (Absolute limits)

Output current	I_o	= max. 0.25 A	max. 0.5 A
Peak anode current	I_{ap}	= max. 1 A	max. 2 A
Peak inverse voltage	$V_{a\text{ invp}}$	= max. 10 kV	max. 2 kV
(Frequency	f	= max. 150 Hz	max. 150 Hz)
Condensed mercury temperature ¹⁾	t_{Hg}	= 25 to 60 °C	25 to 70 °C
Ambient temperature ²⁾	t_{amb}	= 15 to 40 °C	15 to 50 °C

¹⁾ If the equipment is started not more than twice daily it is permitted to apply the high tension at a condensed mercury temperature of 20 °C

²⁾ With convection cooling only

MECHANICAL DATA

Mounting position: vertical with base down

DCG4/1000 ED

Base : Edison

Anode connector : 40619

Net mass : 65 g

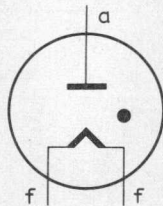

Dimensions in mm

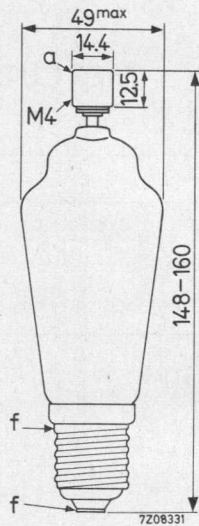

DCG4/1000 G = 866A

Base : Medium 4p with bayonet

Anode connector : 40619

Net mass : 80 g

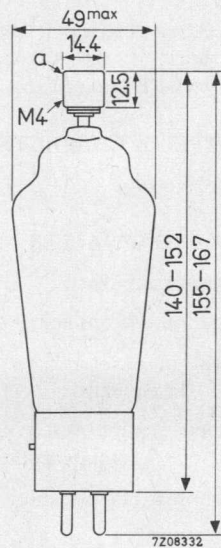
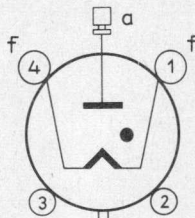

¹⁾ At voltages above 2 kV the socket must be insulated from the chassis.

OPERATING CONDITIONS

Transformer regulation and voltage drops in the tubes are neglected

Peak inverse voltage $V_{ainvp} = 10 \text{ kV}$				
Circuit ¹⁾	Transformer voltage V_{tr} (kVRMS)	Output voltage V_o (kV)	Output current I_o (A)	Power output W_o (W)
a	3.5	3.2	0.5	1590
b	7.1	6.4	0.5	3180
c	4.1	4.8	0.75	3600
d	7.1	9.6	0.75	7200
e	3.5	4.1	1.5	6200
f	3.5	4.5	1	4500
g	7.1	9.0	1	9000

Peak inverse voltage $V_{ainvp} = 2 \text{ kV}$				
Circuit ¹⁾	Transformer voltage V_{tr} (kVRMS)	Output voltage V_o (kV)	Output current I_o (A)	Power output W_o (W)
a	0.71	0.63	1	630
b	1.41	1.27	1	1270
c	0.82	0.96	1.5	1430
d	1.41	1.91	1.5	2870
e	0.71	0.83	3	2480
f	0.71	0.90	2	1800
g	1.41	1.80	2	3600

¹⁾ For circuits see page 8 in front of this section.

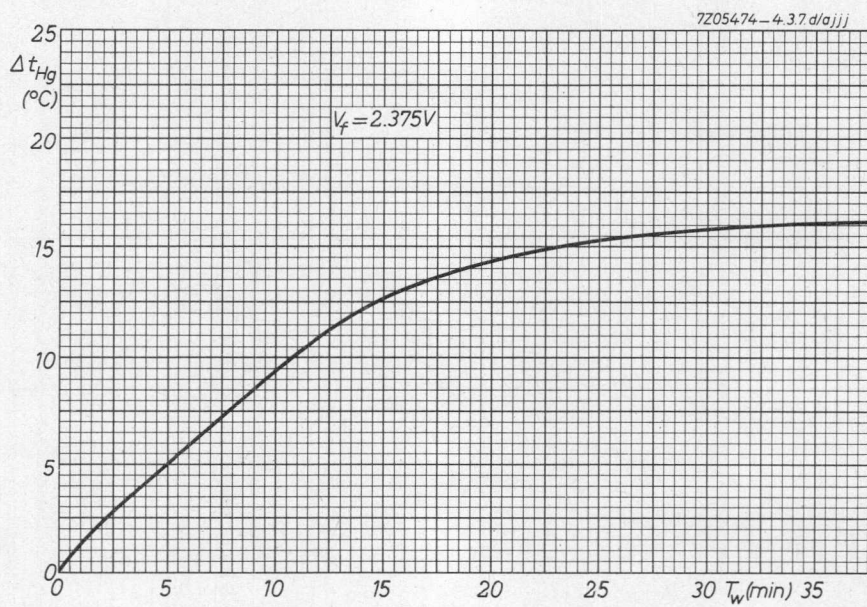

HIGH-VOLTAGE MERCURY-VAPOUR RECTIFYING TUBE

QUICK REFERENCE DATA

Peak inverse voltage	$V_{a\text{ invp}}$	= max.	13 kV
Output current	I_o	= max.	1.25 A
Peak anode current	I_{ap}	= max.	5 A

HEATING: direct; filament oxide-coated

Filament voltage	V_f	=	4 V
Filament current	I_f	=	7 A
Cathode heating time	T_w	= min.	30 s

Phase shift of $90^\circ \pm 30^\circ$ between V_a and V_f and/or use of a centre-tapped filament transformer are recommended.

After transport and after a long interruption of service a waiting time of at least 30 minutes between the switching on of the filament voltage and the switching on of the anode voltage should be observed.

TYPICAL CHARACTERISTICS

Arc voltage $V_{arc}(I_a = 1.25 \text{ A}) = 12 \text{ V}$

LIMITING VALUES (Absolute limits)

Peak inverse voltage	$V_{a\text{ invp}}$	= max.	13 kV	max.	10 kV
(Frequency)	f	= max.	150 Hz	max.	150 Hz)
Output current	I_o	= max.	1.25 A	max.	1.25 A
(Averaging time)	T_{av}	= max.	10 s	max.	10 s)
Peak anode current	I_{ap}	= max.	5 A	max.	5 A
Surge current	I_{surge}	= max.	40 A	max.	40 A
(Duration)	T	= max.	0.1 s	max.	0.1 s)
Condensed mercury temperature ¹⁾	t_{Hg}	=	25 to 55 °C	25 to 60 °C	
Ambient temperature ²⁾	t_{amb}	=	10 to 35 °C	10 to 40 °C	

¹⁾²⁾ See page 2

MECHANICAL DATA (Dimensions in mm)

Base : Goliath
 Anode connector : 20619
 Net weight : 200 g

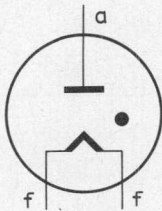

Mounting position: vertical with base down

OPERATING CONDITIONS

Transformer regulation and voltage drops in the tubes are neglected.

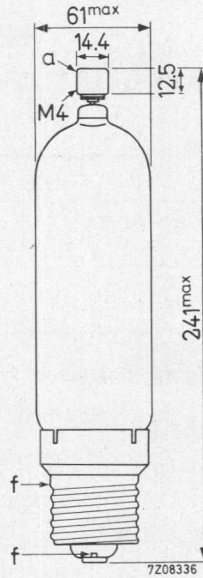

Peak inverse voltage $V_{a\text{inv}p} = 13 \text{ kV}$				
Circuit ³⁾	Transformer voltage V_{tr} (kVRMS)	Output voltage V_o (kV)	Output current I_o (A)	Power output W_o (kW)
a	4.6	4.1	2.5	10.3
b	9.2	8.3	2.5	20.7
c	5.3	6.2	3.75	23.3
d	9.2	12.4	3.75	46.6
e	4.6	5.4	7.5	40.4
f	4.6	5.8	5.0	29
g	9.2	11.6	5.0	58

1) If the equipment is started not more than twice daily it is permitted to apply the high tension at a condensed mercury temperature of 20 °C.
 2) With natural cooling.
 3) For circuit see page 8 in front of this section.

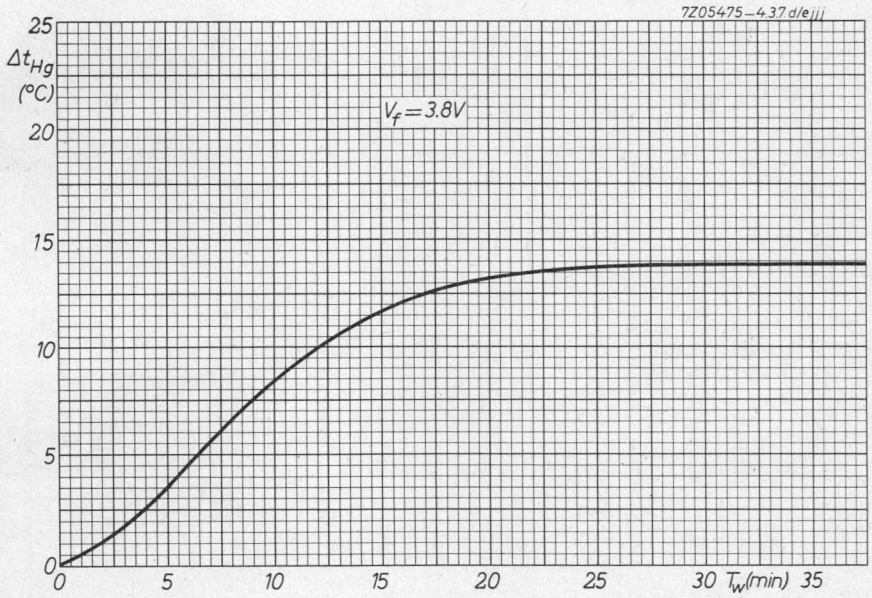

**HIGH-VOLTAGE
MERCURY-VAPOUR RECTIFYING TUBE**

DCG5/5000GB replaced by type ZY1000
DCG5/5000GS replaced by type ZY1001
DCG5/5000EG replaced by type ZY1002



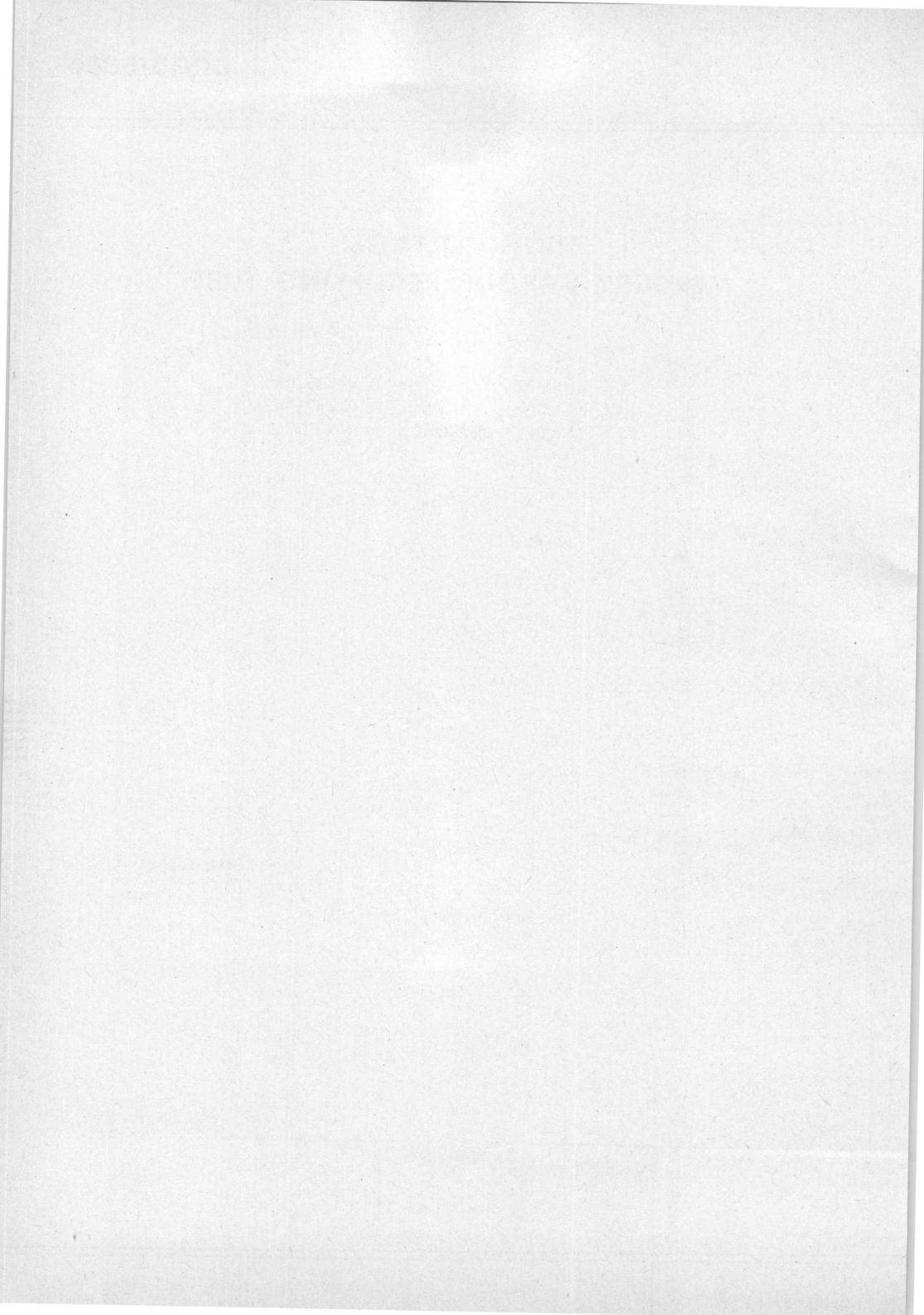

HIGH-VOLTAGE MERCURY-VAPOUR RECTIFYING TUBE

QUICK REFERENCE DATA

Peak inverse voltage	$V_{a\text{ invp}}$	= max. 15 kV	max. 2.5 kV
Output current	I_o	= max. 3 A	max. 5 A
Peak anode current	I_{ap}	= max. 12 A	max. 20 A

HEATING: direct; filament oxide-coated

Filament voltage	V_f	= 5 V
Filament current	I_f	= 11.5 A
Cathode heating time	T_w	= min. 60 s

Phase shift of $90^\circ \pm 30^\circ$ between V_a and V_f and use of a centre-tapped filament transformer is recommended.

After transport and after a long interruption of service a waiting time of at least 30 minutes between the switching on of the filament voltage and the switching on of the anode voltage should be observed.

TYPICAL CHARACTERISTICS

Arc voltage	V_{arc} ($I_a = 3\text{ A}$)	= 12 V
Equilibrium condensed mercury temperature rise over ambient temperature	no load	19 °C
	full load	21 °C

LIMITING VALUES (Absolute limits)

Peak inverse voltage (Frequency)	$V_{a\text{ invp}}$ f	= max. 15 kV = max. 150 Hz	max. 2.5 kV max. 150 Hz)
Output current (Averaging time)	I_o T_{av}	= max. 3 A = max. 10 s	max. 5 A max. 10 s)
Peak anode current	I_{ap}	= max. 12 A	max. 20 A
Surge current (Duration)	I_{surge} T	= max. 120 A = max. 0.1 s	max. 200 A max. 0.1 s)

LIMITING VALUES (Absolute limits) (continued)

Peak inverse voltage	$V_{a\ invp}$	15	10	2.5	kV
Condensed mercury temperature	t_{Hg} 1)	25-55	25-60	25-75	°C
Ambient temperature	t_{amb} 2)	15-35	15-40	15-55	°C

MECHANICAL DATA (Dimensions in mm)

Base : Super Jumbo with bayonet

Anode connector : 40619

Socket : 2422 511 01001

Net weight : 450 g

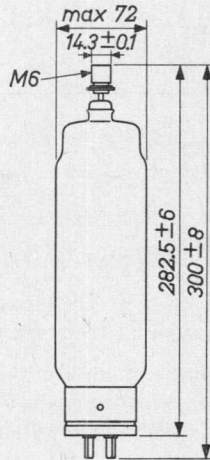
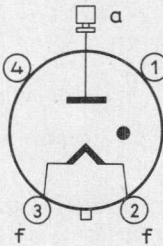

Mounting position: vertical with base down

1) If the equipment is started not more than twice daily, it is permitted to apply high tension at a condensed mercury temperature of 20 °C

2) With natural cooling

MAXIMUM OPERATING CONDITIONS

Transformer regulation and voltage drops in the tubes are neglected.

Peak inverse voltage $V_{a\text{ inv}_p} = 15 \text{ kV}$				
Circuit ¹⁾	Transformer voltage V_{tr} (kVRMS)	Output voltage V_o (kV)	Output current I_o (A)	Power output W_o (kW)
a	5.3	4.8	6	28.8
b	10.6	9.6	6	57.6
c	6.1	7.2	9	64.8
d	10.6	14.4	9	130
e	5.3	6.2	18	112
f	5.3	6.7	12	80.4
g	10.6	13.5	12	162

Peak inverse voltage $V_{a\text{ inv}_p} = 2.5 \text{ kV}$				
Circuit ¹⁾	Transformer voltage V_{tr} (kVRMS)	Output voltage V_o (kV)	Output current I_o (A)	Power output W_o (kW)
a	0.88	0.79	10	7.9
b	1.76	1.58	10	15.8
c	1.02	1.19	15	17.9
d	1.76	2.38	15	35.8
e	0.88	1.03	30	30.9
f	0.88	1.13	20	22.6
g	1.76	2.26	20	45.2

¹⁾ For circuits see page 8 in front of this section.

TYPICAL OPERATING CHARACTERISTICS

Peak inverse voltage $V_{a\text{ inv}_p} = \text{max. } 15 \text{ kV } ^2)$				
Circuit ¹⁾	Transformer voltage V_{tr} (kV _{RMS})	Output ³⁾ voltage V_o (kV)	Output current I_o (A)	Power output W_o (kW)
a	4.8	4.0	6	24
b	9.6	8.0	6	48
c	5.55	6.0	9	54
d	9.6	12.0	9	108
e	4.8	5.15	18	93
f	4.8	5.6	12	67
g	9.6	11.2	12	134

¹⁾ For circuits see page 8 in front of this section

²⁾ This value corresponds to a nominal peak inverse anode voltage of 13.6 kV, allowing a mains voltage fluctuation of $\pm 10 \%$

³⁾ Tube voltage drop and losses in transformer, filter, etc., amounting to 8% of the output voltage across the load, have already been deducted

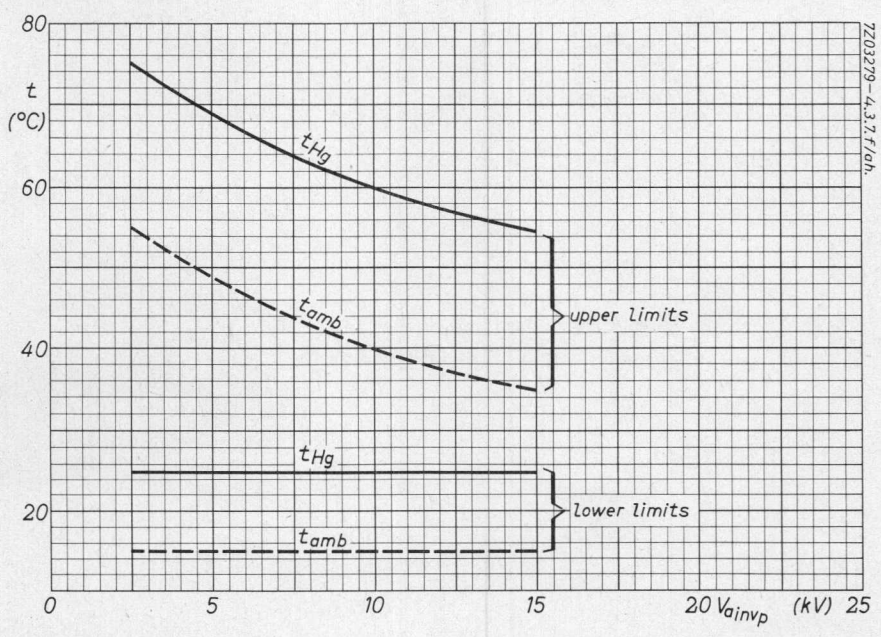
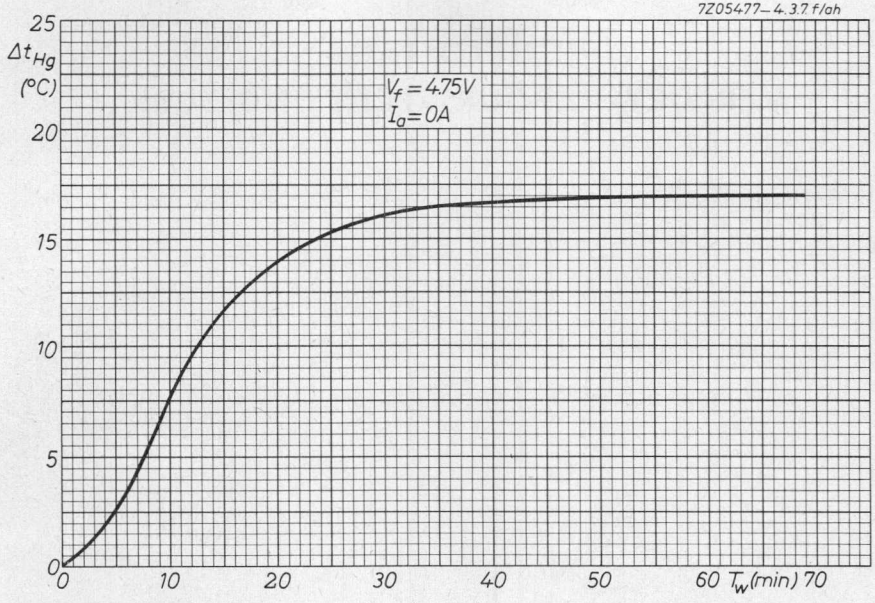

HIGH-VOLTAGE MERCURY-VAPOUR RECTIFYING TUBE

MECHANICAL DATA

Dimensions in mm

Base : Jumbo 4p with bayonet

Socket : 2422 511 02001

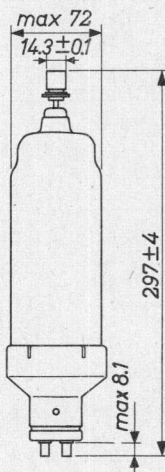
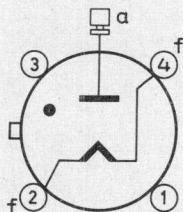
Anode
connector: 40619

For further data and curves of this type
please refer to type DCG6/18

GRID-CONTROLLED HIGH-VOLTAGE MERCURY-VAPOUR RECTIFYING TUBE

QUICK REFERENCE DATA

Peak inverse voltage	$V_{a\text{ inv}p}$	= max.	13 kV
Peak forward voltage	V_{ap}	= max.	13 kV
Output current	I_o	= max.	1 A
Peak anode current	I_{ap}	= max.	4 A
Negative grid voltage	$-V_g$	= max.	300 V
Peak grid current	I_{gp}	= max.	50 mA

HEATING: direct; filament oxide-coated

Filament voltage	V_f	=	5 V
Filament current	I_f	=	6.5 A
Cathode heating time	T_w	= min.	60 s

Phase shift of $90^\circ \pm 30^\circ$ between V_a and V_f and use of a centre-tapped filament transformer are recommended.

After transport and after a long interruption of service a waiting time of at least 60 minutes between the switching on of the filament voltage and the switching on of the anode voltage should be observed.

CAPACITANCES

Anode to grid	C_{ag}	=	3 pF
Grid to cathode	C_g	=	8 pF

TYPICAL CHARACTERISTICS

Arc voltage	V_{arc} ($I_a = 1 \text{ A}$)	=	12 V
Ionization time	T_{ion}	=	10 μs
Deionization time	T_{dion}	=	250 μs

LIMITING VALUES (Absolute limits)

When the anode voltage V_a is negative, the grid voltage must never be positive

Peak inverse voltage (Frequency	$V_{a\ invp}$ = max. 13 kV f = max. 150 Hz)
Peak anode voltage	V_{ap} = max. 13 kV
Output current (Averaging time	I_O = max. 1 A T_{av} = max. 10 s)
Peak anode current	I_{ap} = max. 4 A
Surge current (Duration	I_{surge} = max. 40 A T = max. 0.1 s)
Negative grid voltage ¹⁾	$-V_g$ = max. 300 V
Grid current (Averaging time	I_g = max. 10 mA T_{av} = max. 10 s)
Peak grid current	I_{gp} = max. 50 mA
{ Peak inverse voltage	$V_{a\ invp}$ = 13 kV
{ Condensed mercury temperature ²⁾	t_{Hg} = 25 to 55 °C
{ Ambient temperature ³⁾	t_{amb} = 15 to 30 °C
{ Peak inverse voltage	$V_{a\ invp}$ = 10 kV
{ Condensed mercury temperature ²⁾	t_{Hg} = 25 to 60 °C
{ Ambient temperature ³⁾	t_{amb} = 15 to 35 °C

¹⁾ Before conduction

²⁾ If the equipment is started not more than twice daily it is permitted to apply high tension at a condensed mercury temperature of 20°C

³⁾ With natural cooling

MECHANICAL DATA (Dimensions in mm)

Base : Super jumbo with bayonet

Socket : 2422 511 01001

Anode cap : 40616 1)

Net weight: 240 g

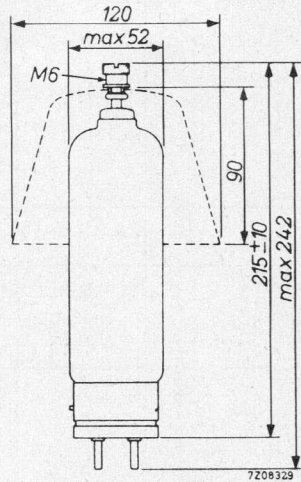
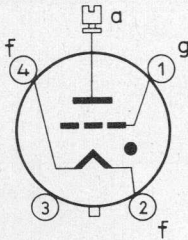

Mounting position: vertical with base down

1) This cap must always be mounted on the tube, thus also during preheating

OPERATING CONDITIONS

Transformer regulation and voltage drops in the tubes are neglected.

Grid voltage	$V_g (V_{a\text{ inv}_p} = 13\text{ kV}) = -100\text{ V}$
Grid voltage	$V_g (V_{a\text{ inv}_p} = 10\text{ kV}) = -50\text{ V}$
Grid current	$I_g = 1\text{ mA}$

Peak inverse voltage $V_{a\text{ inv}_p} = 13\text{ kV}$

Circuit ¹⁾	Transformer voltage V_{tr} (kVRMS)	Output voltage V_o (kV)	Output current I_o (A)	Power output W_o (kW)
a	4.6	4.1	2	8.3
b	9.2	8.3	2	16.6
c	5.3	6.2	3	18.6
d	9.2	12.4	3	37.2
e	4.6	5.4	6	32.4
f	4.6	5.8	4	23.4
g	9.2	11.7	4	46.8

Peak inverse voltage $V_{a\text{ inv}_p} = 10\text{ kV}$

Circuit ¹⁾	Transformer voltage V_{tr} (kVRMS)	Output voltage V_o (kV)	Output current I_o (A)	Power output W_o (kW)
a	3.5	3.2	2	6.4
b	7	6.4	2	12.8
c	4.1	4.8	3	14.4
d	7	9.6	3	28.8
e	3.5	4.1	6	24.8
f	3.5	4.5	4	18
g	7	9	4	36

¹⁾ For circuits see page 8 in front of this section

GRID-CONTROLLED HIGH-VOLTAGE MERCURY-VAPOUR RECTIFYING TUBE

QUICK REFERENCE DATA

Peak inverse voltage	$V_{a\text{ inv }p}$ = max.	15 kV
Peak forward voltage	$V_{a\text{ p}}$ = max.	15 kV
Output current	I_o = max.	10 A
Peak anode current	$I_{a\text{ p}}$ = max.	45 A
Peak grid voltage	$V_{g\text{ p}}$ = max.	600 V

CATHODE : oxide-coated

HEATING: indirect, cathode connected to heater

Heater voltage	V_f =	5 V
Heater current	I_f =	14 A
Cathode heating time	T_w = min.	10 min.

After transport and after a long interruption of service a waiting time of at least 45 minutes between the switching on of the heater voltage and the switching on of the anode voltage should be observed. Moreover, 10 minutes after having switched on the heater voltage, preheating of the anode must be started by connecting the anode to a supply voltage V_b = max. 500 V via a resistor limiting the current I_o to 6 A.

TYPICAL CHARACTERISTICS

Arc voltage	$V_{\text{arc}} (I_a = 15 \text{ A}) =$	12 V
Equilibrium condensed mercury temperature rise over ambient temperature	no load	27 °C
	full load	30 °C

LIMITING VALUES (Absolute limits)

Peak inverse voltage (Frequency	$V_{a\ inv p}$ = max. f = max.	15 kV 150 Hz)
Peak anode voltage	$V_{a p}$ = max.	15 kV
Output current for continuous operation (Averaging time	I_o = max. T_{av} = max.	10 A 10 s)
Output current for intermittent operation (Averaging time	I_o = max. T_{av} = max.	15 A 10 s)
Peak anode current	$I_{a p}$ = max.	45 A
Surge current (Duration	I_{surge} = max. T = max.	600 A 0.1 s)
Peak grid voltage	$V_{g p}$ = max.	600 V
Grid resistor	R_g = max.	20 k Ω
Peak inverse voltage	$V_{a\ inv p}$ =	15 10 kV
Condensed mercury temperature ¹⁾	t_{Hg} = 25 to 60	25 to 65 °C
Ambient temperature ²⁾	t_{amb} = 10 to 30	10 to 35 °C

¹⁾ If the equipment is started not more than twice daily it is permitted to apply high tension at a condensed mercury temperature of 20 °C.

²⁾ With natural cooling. The tube can be operated at higher ambient temperatures than the stated maxima, when the difference between the ambient and the condensed mercury temperature (30 °C with natural cooling) is reduced by an air flow directed at the bulb just above the base. A reduction to less than 10 °C can easily be obtained with a simple airjet.

MECHANICAL DATA

Dimensions in mm

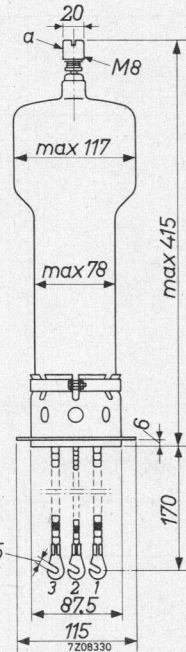
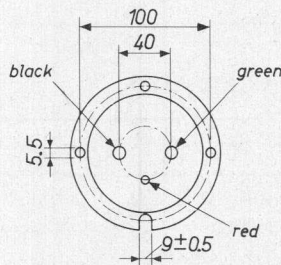
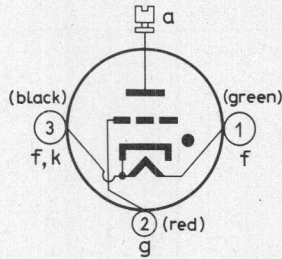
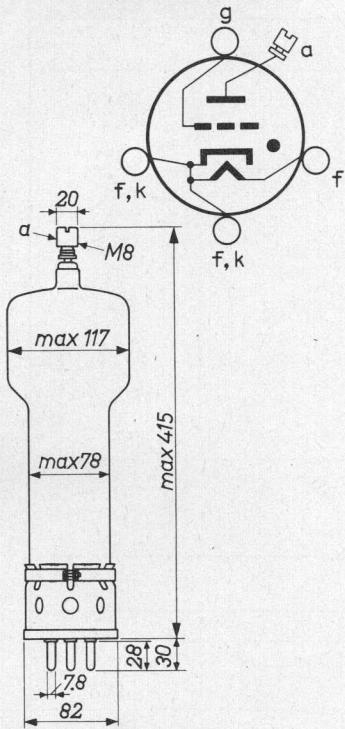

DCG7/100

DCG7/100B

Anode connector: 40620

Mounting position: vertical with anode terminal up

Net weight: 1200 g

MAXIMUM OPERATING CONDITIONS

Peak inverse voltage $V_{a\text{ inv}_p} = 15\text{ kV}^2)$				
Circuit ¹⁾	Transformer voltage V_{tr} (kVRMS)	Output voltage V_o (kV)	Output current I_o (A)	Power output W_o (kW)
a	5.3	4.8	20	96
b	10.6	9.6	20	192
c	6.1	7.2	30	216
d	10.6	14.4	30	432
e	5.3	6.2	60	372
f	5.3	6.7	40	268
g	10.6	13.5	40	540

TYPICAL OPERATING CONDITIONS

Peak inverse voltage $V_{a\text{ inv}_p} = 15\text{ kV}^3)$				
Circuit ¹⁾	Transformer voltage V_{tr} (kVRMS)	Output ⁴⁾ voltage V_o (kV)	Output current I_o (A)	Power output W_o (kW)
a	4.8	4	20	80
b	9.6	8	20	160
c	5.55	6	30	180
d	9.6	12	30	360
e	4.8	5.15	60	309
f	4.8	5.6	40	224
g	9.6	11.2	40	448

1) For circuits see page 8 in front of this section

2) Transformer regulation and voltage drops in the tubes are neglected

3) This value corresponds to a nominal peak inverse anode voltage of 13.6 kV, allowance being made for mains voltage fluctuations of $\pm 10\%$

4) Tube voltage drop and losses in transformer, filter, etc., amounting to 8% of the output voltage across the load, have already been deducted

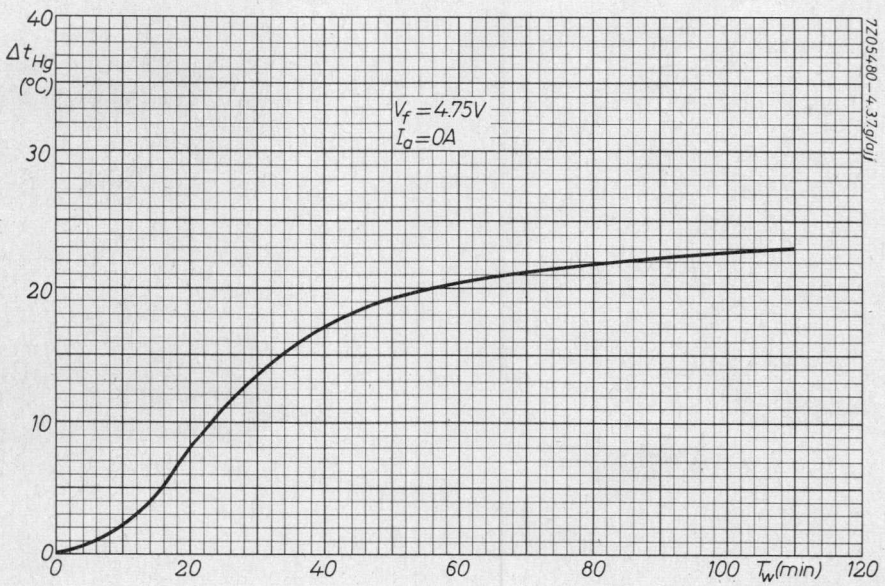
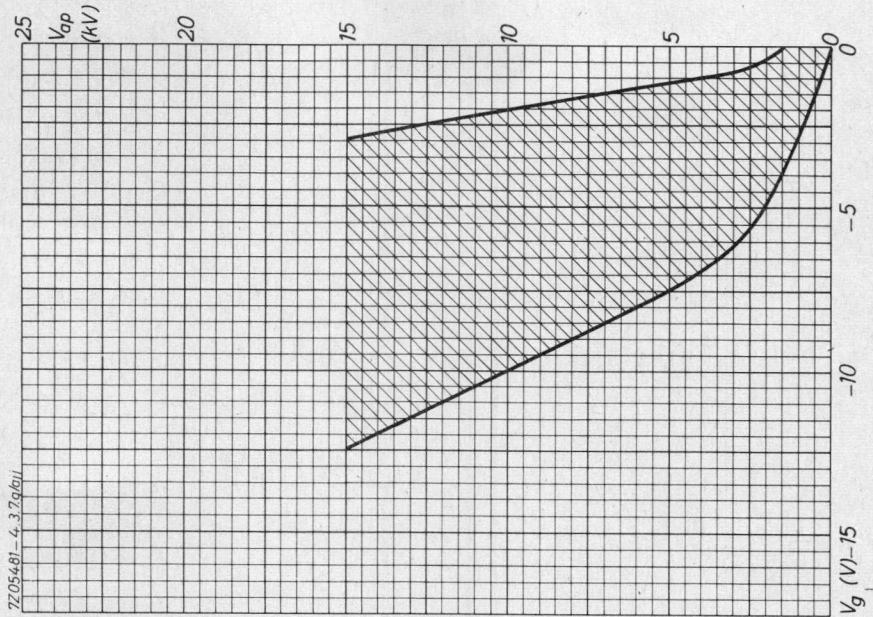

HIGH-VOLTAGE MERCURY-VAPOUR RECTIFYING TUBE

QUICK REFERENCE DATA

Peak inverse voltage	$V_{a\text{ inv}p} = \text{max. } 21 \text{ kV}$
Output current	$I_o = \text{max. } 2.5 \text{ A}$
Peak anode current	$I_{ap} = \text{max. } 10 \text{ A}$

HEATING: direct; filament oxide-coated

Filament voltage	$V_f = 5 \text{ V}$
Filament current	$I_f = 13.5 \text{ A}$
Cathode heating time	$T_w = \text{min. } 90 \text{ s}$

Phase shift of $90^\circ \pm 30^\circ$ between V_a and V_f and/or use of a centre-tapped filament transformer are recommended

After transport and after a long interruption of service a waiting time of at least 60 minutes between the switching on of the filament voltage and the switching on of the anode voltage should be observed

LIMITING VALUES (Absolute limits)

Peak inverse voltage	$V_{a\text{ inv}p} = \text{max. } 21$	15	10	kV
(Frequency)	$f = \text{max. } 150$	150	150	Hz)
Output current	$I_o = \text{max. } 2.5$	2.5	2.5	A
(Averaging time)	$T_{av} = \text{max. } 30$	30	30	s)
Peak anode current	$I_{ap} = \text{max. } 10$	10	10	A
Surge current	$I_{\text{surge}} = \text{max. } 100$	100	100	A
(Duration)	$T = \text{max. } 0.1$	0.1	0.1	s)
Condensed mercury temperature ¹⁾	$t_{\text{Hg}} =$	25-45	25-50	25-60 °C
Ambient temperature ²⁾	$t_{\text{amb}} =$	15-30	15-35	15-45 °C

¹⁾ If the equipment is started not more than twice daily it is permitted to apply high tension at a condensed mercury temperature of 20°C.

²⁾ With natural cooling

TYPICAL CHARACTERISTICS

Deionization time	T_{dion}	< 500 μ s
Ionization time	T_{ion}	< 10 μ s
Arc voltage	V_{arc} ($I_a = 2.5$ A)	= 12 V

MECHANICAL DATA Dimensions in mm

Anode connector:	40620
Anode cap	: 40616
Net weight	: 0.75 g

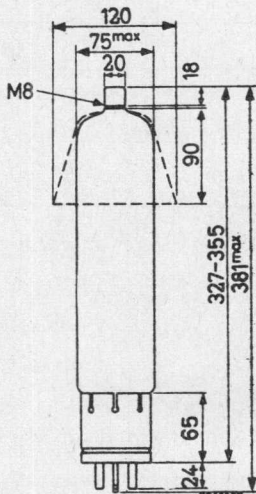
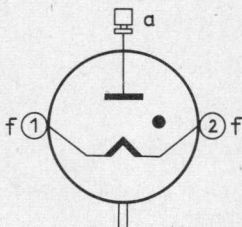
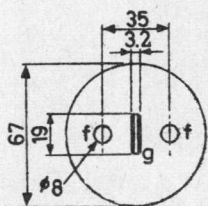

Mounting position: vertical with base down

The anode cap 40616 must always be mounted on the tube, thus also during pre-heating

OPERATING CONDITIONS

Transformer regulation and voltage drops in the tubes are neglected

Peak inverse voltage $V_{a inv_p} = 21$ kV				
Circuit ¹⁾	Transformer voltage V_{tr} (kVRMS)	Output voltage V_o (kV)	Output current I_o (A)	Power output W_o (kW)
a	7.4	6.7	5	33.5
b	14.8	13.4	5	67
c	8.6	10	7.5	75
d	14.8	20	7.5	150
e	7.4	8.7	15	130
f	7.4	9.5	10	95
g	14.8	19	10	190

¹⁾ For circuits see page 8 in front of this section

GRID-CONTROLLED HIGH-VOLTAGE MERCURY-VAPOUR RECTIFYING TUBE

QUICK REFERENCE DATA		
Peak inverse voltage	$V_{a\text{ inv}p}$	max. 27 kV
Peak forward voltage	V_{ap}	max. 27 kV
Output current	I_o	max. 2.5 A
Peak anode current	I_{ap}	max. 10 A
Negative grid voltage	$-V_g$	max. 300 V
Peak grid current	I_{gp}	max. 125 mA

HEATING: direct; filament oxide-coated

Filament voltage	V_f	5 V
Filament current	I_f	13.5 A
Cathode heating time	T_w	min. 90 s

Phase shift of $90^\circ \pm 30^\circ$ between V_a and V_f and use of a centre-tapped filament transformer are recommended

After transport and after a long interruption of service a waiting time of at least 60 minutes between the switching on of the filament voltage and the switching on of the anode voltage should be observed

CAPACITANCES

Anode to grid	C_{ag}	4 pF
Grid to cathode	C_g	13 pF

TYPICAL CHARACTERISTICS

Deionization time	T_{dion}	$< 500 \mu s$
Ionization time	T_{ion}	$< 10 \mu s$
Arc voltage	$V_{arc} (I_a = 2.5 A)$	12 V

LIMITING VALUES (Absolute limits)

When the anode voltage V_a is negative, the grid voltage must never be positive

Peak inverse voltage (Frequency)	$V_a \text{ inv}_p$ f	max. 27 kV max. 150 Hz)
Peak anode voltage	V_{a_p}	max. 27 kV
Output current (Averaging time)	I_o T_{av}	max. 2.5 A max. 30 s)
Peak anode current	I_{a_p}	max. 10 A
Surge current (Duration)	I_{surge} T	max. 100 A max. 0.1 s)
Negative grid voltage	$-V_g$	max. 300 V ¹⁾
Grid current (Averaging time)	I_g T_{av}	max. 25 mA max. 30 s)
Peak grid current	I_{g_p}	max. 125 mA

$V_a \text{ inv}_p$	27	21	15	13	10	kV
$t_{Hg} \text{ }^2)$	30-40	30-45	25-50	25-55	25-60	°C
$t_{amb} \text{ }^3)$	20-25	20-30	15-35	15-40	15-45	°C

1) Direct voltage; before conduction

2) If the equipment is started not more than twice daily it is permitted to apply high tension at a condensed mercury temperature which is 5 °C less than the values mentioned in the table

3) With natural cooling

MECHANICAL DATA (Dimensions in mm)

Anode connector: 40620

Anode cap : 40616

This cap must always be mounted on the tube, thus also during preheating

Net weight: 0.75 kg

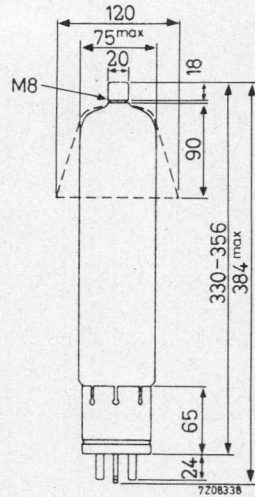
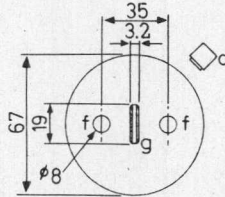
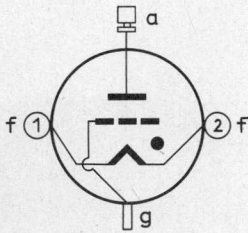

Mounting position: vertical with base down

OPERATING CONDITIONS

Transformer regulation and voltage drops in the tubes are neglected

Grid voltage	V_g ($V_a \text{ inv}_p = 27 \text{ kV}$)	-100 V
Grid voltage	V_g ($V_a \text{ inv}_p = 10 \text{ kV}$)	-50 V
Grid current	I_g	2 mA

Peak inverse voltage $V_a \text{ inv}_p = 27 \text{ kV}$				
Circuit 1)	Transformer voltage	Output voltage	Output current	Power output
	V_{tr} (kVRMS)	V_o (kV)	I_o (A)	W_o (kW)
a	9.5	8.6	5	43
b	19.1	17.2	5	86
c	11	12.9	7.5	97
d	19.1	25.8	7.5	194
e	9.5	11.2	15	168
f	9.5	12.1	10	121
g	19.1	24.3	10	243

1) For circuits see page 8 in front of this section

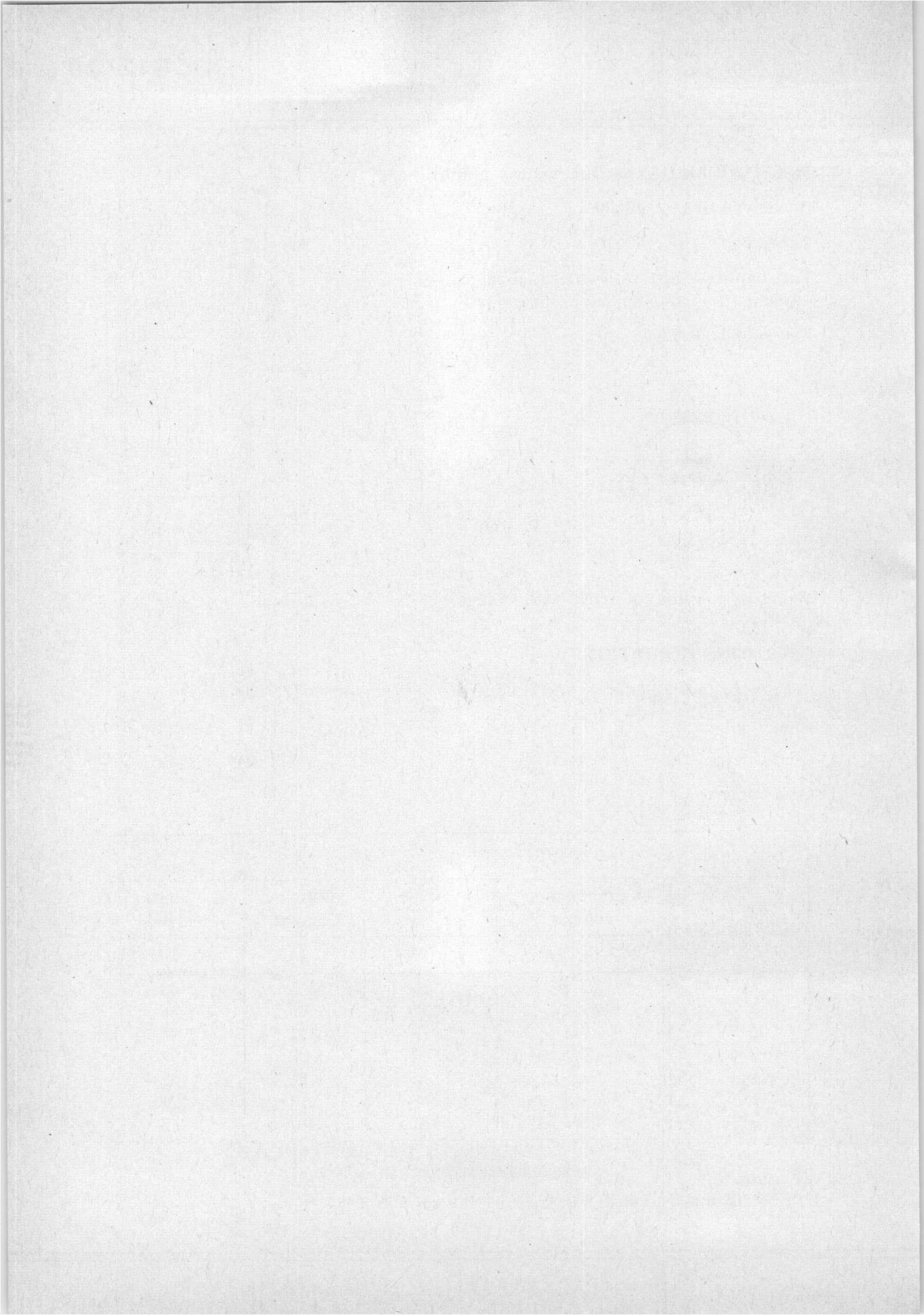

HIGH-VOLTAGE XENON-FILLED RECTIFYING TUBE

QUICK REFERENCE DATA

Peak inverse voltage	$V_{a\text{ invp}}$	max. 10 kV	max. 5 kV
Output current	I_o	max. 0.25 A	max. 0.5 A
Peak anode current	I_{ap}	max. 1 A	max. 2 A

HEATING: direct; filament oxide-coated

Filament voltage	V_f	2.5 V
Filament current	I_f	5 A
Cathode heating time	T_w	min. 10 s

Phase shift of $90^\circ \pm 30^\circ$ between V_a and V_f and use of a centre-tapped filament transformer are recommended. In order to obtain a low ignition voltage the voltage on pin 4 should be positive with respect to pin 1 at the moment of ignition.

TYPICAL CHARACTERISTICS

Arc voltage $V_{\text{arc}} (I_a = 0.5 \text{ A})$ 12 V

LIMITING VALUES (Absolute limits)

Peak inverse voltage (Frequency)	$V_{a\text{ invp}}$ f	max. 10 kV max. 150 Hz	max. 5 kV max. 500 Hz)
Output current (Averaging time)	I_o T_{av}	max. 0.25 A max. 15 s	max. 0.5 A max. 15 s)
Peak anode current	I_{ap}	max. 1 A	max. 2 A
Surge current (Duration)	I_{surge} T	max. 20 A max. 0.1 s	max. 20 A max. 0.1 s)
Ambient temperature	t_{amb}	-55 to +75 °C	-55 to +75 °C

MECHANICAL DATA (Dimensions in mm)

Base : medium 4p with bayonet

Anode

Connector : 40619

Net weight : 100 g

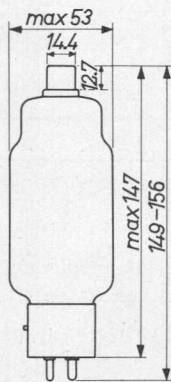
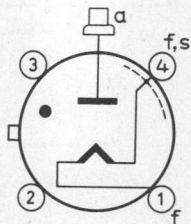

Mounting position : arbitrary



OPERATING CONDITIONS

Transformer regulation and voltage drops in the tubes are neglected.

Peak inverse voltage $V_{a\text{ inv}_p} = 10\text{ kV}$				
Circuit ¹⁾	Transformer voltage V_{Tr} (kVRMS)	Output voltage V_o (kV)	Output current I_o (A)	Power output W_o (kW)
a	3.5	3.2	0.5	1.6
b	7.1	6.4	0.5	3.2
c	4.1	4.8	0.75	3.6
d	7.1	9.6	0.75	7.2
e	3.5	4.1	1.5	6.2
f	3.5	4.5	1.0	4.5
g	7.1	9.0	1.0	9.0

Peak inverse voltage $V_{a\text{ inv}_p} = 5\text{ kV}$				
Circuit ¹⁾	Transformer voltage V_{Tr} (kVRMS)	Output voltage V_o (kV)	Output current I_o (A)	Power output W_o (kW)
a	1.8	1.6	1.0	1.6
b	3.5	3.2	1.0	3.2
c	2.0	2.4	1.5	3.6
d	3.5	4.8	1.5	7.2
e	1.8	2.1	3.0	6.2
f	1.8	2.2	2.0	4.5
g	3.5	4.5	2.0	9.0

¹⁾ For circuits see page 8 in front of this section

HIGH-VOLTAGE XENON-FILLED RECTIFYING TUBE

QUICK REFERENCE DATA

Peak inverse voltage	$V_{a\text{ inv}p}$	max.	10 kV
Output current	I_o	max.	1.25 A
Peak anode current	I_{ap}	max.	5 A

HEATING: direct; filament oxide-coated

Filament voltage	V_f	5 V
Filament current	I_f	7.1 A
Cathode heating time	T_w	min. 30 s

Phase shift of $90^\circ \pm 30^\circ$ between V_a and V_f and use of a centre-tapped filament transformer are recommended. In order to obtain a low ignition voltage the voltage on pin 4 should be positive with respect to pin 2 at the moment of ignition.

TYPICAL CHARACTERISTICS

Arc voltage $V_{arc} (I_a = 1.25 \text{ A})$ 12 V

LIMITING VALUES (Absolute limits)

Peak inverse voltage (Frequency)	$V_{a\text{ inv}p}$ f	max.	10 kV max. 150 Hz)
Output current (Averaging time)	I_o T_{av}	max.	1.25 A max. 15 s)
Peak anode current	I_{ap}	max.	5 A
Surge current (Duration)	I_{surge} T	max.	50 A max. 0.1 s)
Ambient temperature	t_{amb}		-55 to +70 °C

MECHANICAL DATA (Dimensions in mm)

Base : Jumbo 4p
 Socket : 2422 511 02001
 Anode connector: 40619
 Net weight : 190 g

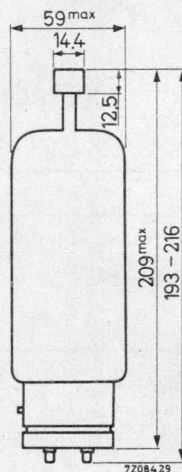
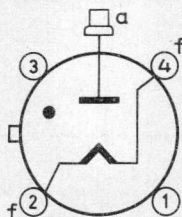

Mounting position: arbitrary

OPERATING CONDITIONS

Transformer regulation and voltage drops in the tubes are neglected.

Peak inverse voltage $V_{a\ inv p} = 10\text{ kV}$				
Circuit ¹⁾	Transformer voltage V_{tr} (kVRMS)	Output voltage V_o (kV)	Output current I_o (A)	Power output W_o (kW)
a	3.5	3.2	2.5	8
b	7.1	6.4	2.5	16
c	4.1	4.8	3.75	18
d	7.1	9.6	3.75	36
e	3.5	4.1	7.5	31
f	3.5	4.5	5.0	22.5
g	7.1	9.0	5.0	45

¹⁾ For circuits see page 8 in front of this section

GRID-CONTROLLED HIGH-VOLTAGE MERCURY-VAPOUR RECTIFYING TUBES

QUICK REFERENCE DATA				
Peak inverse voltage	$V_{a\ invp}$	max.	21 15	2.5 kV
Peak forward voltage	V_{ap}	max.	21 15	2.5 kV
Output current	I_o	max.	2.5 3	5 A
Peak anode current	I_{ap}	max.	10 12	20 A

HEATING : direct; filament oxide coated

Filament voltage	V_f	5 V	1)
Filament current	I_f	13 A	
Waiting time	T_w	min. 90 s	2)

TYPICAL CHARACTERISTICS

Deionization time	T_{dion}	< 500 μ s
Ionization time	T_{ion}	< 10 μ s
Arc voltage	V_{arc} ($I_o = 3$ A)	12 V

LIMITING VALUES (Absolute limits)

Peak inverse voltage	$V_{a\ invp}$	max. 21	15	2.5 kV	3)
Peak forward voltage	V_{ap}	max. 21	15	2.5 kV	
Output current	I_o	max. 2.5	max. 3	max. 5 A	4)
Peak anode current	I_{ap}	max. 10	max. 12	max. 20 A	
Surge current	I_{surge}	max. 100	max. 120	max. 200 A	5)
Negative grid voltage	$-V_g$	max. 300	max. 300	max. 300 V	6)
Grid circuit resistance	R_g	min. 10	min. 10	min. 10 k Ω	7)
		max. 100	max. 100	max. 100 k Ω	

1) 2) 3) 4) 5) 6) 7) See page 2

TEMPERATURE LIMITS (Absolute limits)

Peak inverse voltage	$V_a \text{ inv}_p$	21	15	10	2.5	kV
Condensed mercury temperature	t_{Hg}	25-45	25-55	25-60	25-75	°C ⁸⁾
Ambient temperature	t_{amb}	15-30	15-35	15-40	15-55	°C ⁹⁾

1) Phase shift of $90^\circ \pm 30^\circ$ between V_a and V_f and/or use of a centre-tapped filament transformer are recommended.

2) For average conditions, i.e. temperature within limits and proper distribution of mercury (see page 5).

After transport and also after a long interruption of service a longer waiting time is required before anode voltage is applied to ensure proper distribution of the mercury. In general, a time of 60 minutes will be sufficient.

3) f max. 150 Hz

4) T_{av} max. 30 s

5) T max. 0.1 s

6) Direct voltage; before conduction

7) Recommended value 33 k Ω

8) If the equipment is started not more than twice daily it is permitted to apply high tension at a condensed mercury temperature of 20 °C.

9) Approximate values with natural cooling.

The ambient temperature is defined as the temperature of the surrounding air and should be measured under the following conditions:

- normal atmospheric pressure
- the tube should be adjusted to the worst probable operating conditions
- the temperature should be measured when thermal equilibrium has been reached
- the distance of the thermometer from the envelope shall be 75 mm (measured in the plane perpendicular to the main axis of the tube at the height of the condensed mercury boundary)
- the thermometer shall be shielded to avoid direct heat radiation.

MECHANICAL DATA

Dimensions in mm

Net weight: 0.75 kg

ZT 1000

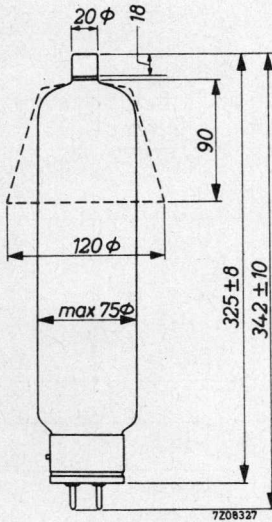

ZT 1001

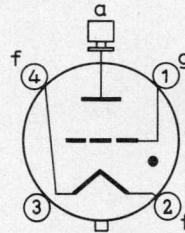
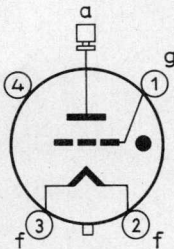
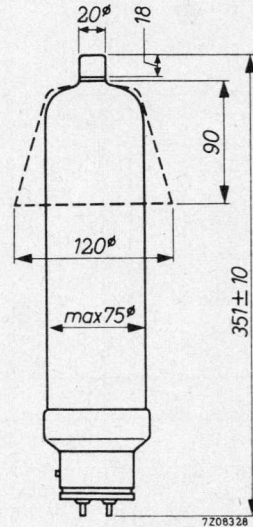

Base: Super Jumbo with bayonet

Socket : 2422 511 01001

Anode connector: 40620

Anode cap : 40616

Base: Jumbo 4p with bayonet

Socket : 2422 511 02001

Anode connector: 40620

Anode cap : 40616

Mounting position: vertical with base down

The anode cap 40616 is not delivered with the tube but must always be mounted on the tube, thus also during preheating.

OPERATING CONDITIONS

Transformer regulation and voltage drop in the tubes have been neglected

Grid voltage	V_g ($V_{a\ inv_p} = 21\ \text{kV}$)	-100 V
Grid voltage	V_g ($V_{a\ inv_p} = 10\ \text{kV}$)	-50 V
Grid current	I_g	2 mA

Peak anode inverse voltage $V_{a\ inv_p} = 21\ \text{kV}$				
Circuit 1)	Transformer voltage	Output voltage	Output current	Output power
	V_{tr} (kVRMS)	V_o (kV)	I_o (A)	W_o (kW)
a	7.4	6.7	5	33.5
b	14.8	13.4	5	67
c	8.5	10	7.5	75
d	14.8	20	7.5	150

Peak anode inverse voltage $V_{a\ inv_p} = 15\ \text{kV}$				
Circuit 1)	Transformer voltage	Output voltage	Output current	Output power
	V_{tr} (kVRMS)	V_o (kV)	I_o (A)	W_o (kW)
a	5.3	4.8	6	28.8
b	10.6	9.6	6	57.6
c	6.1	7.2	9	64.8
d	10.6	14.4	9	130

1) See page 8 in front of this section

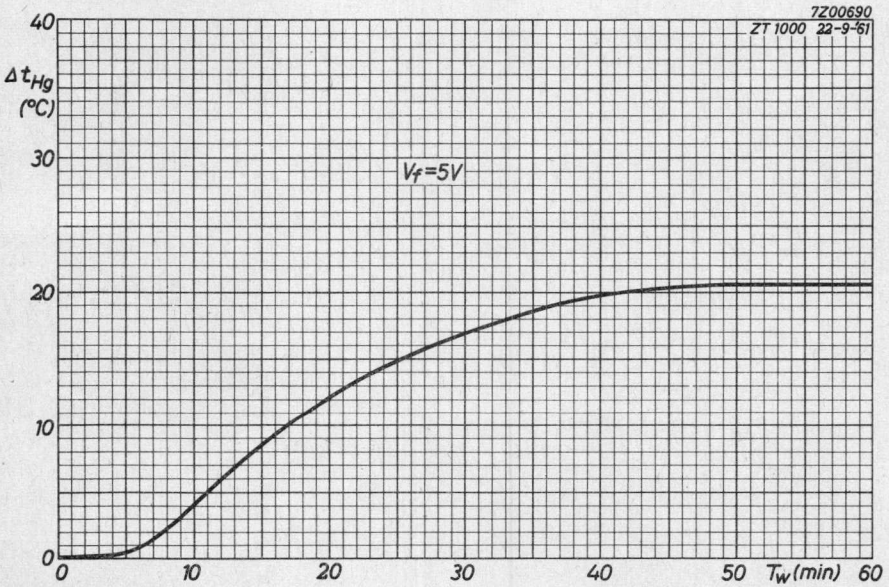
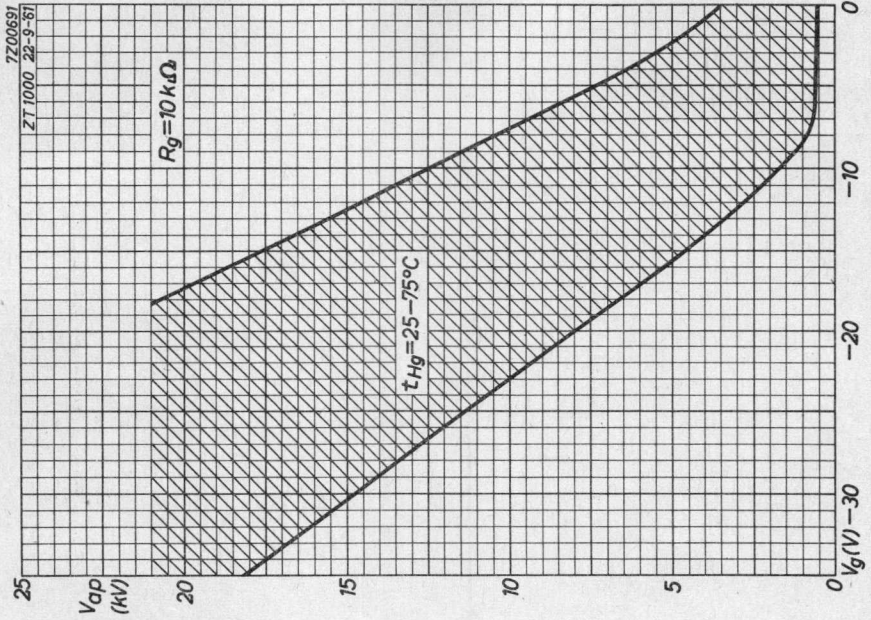

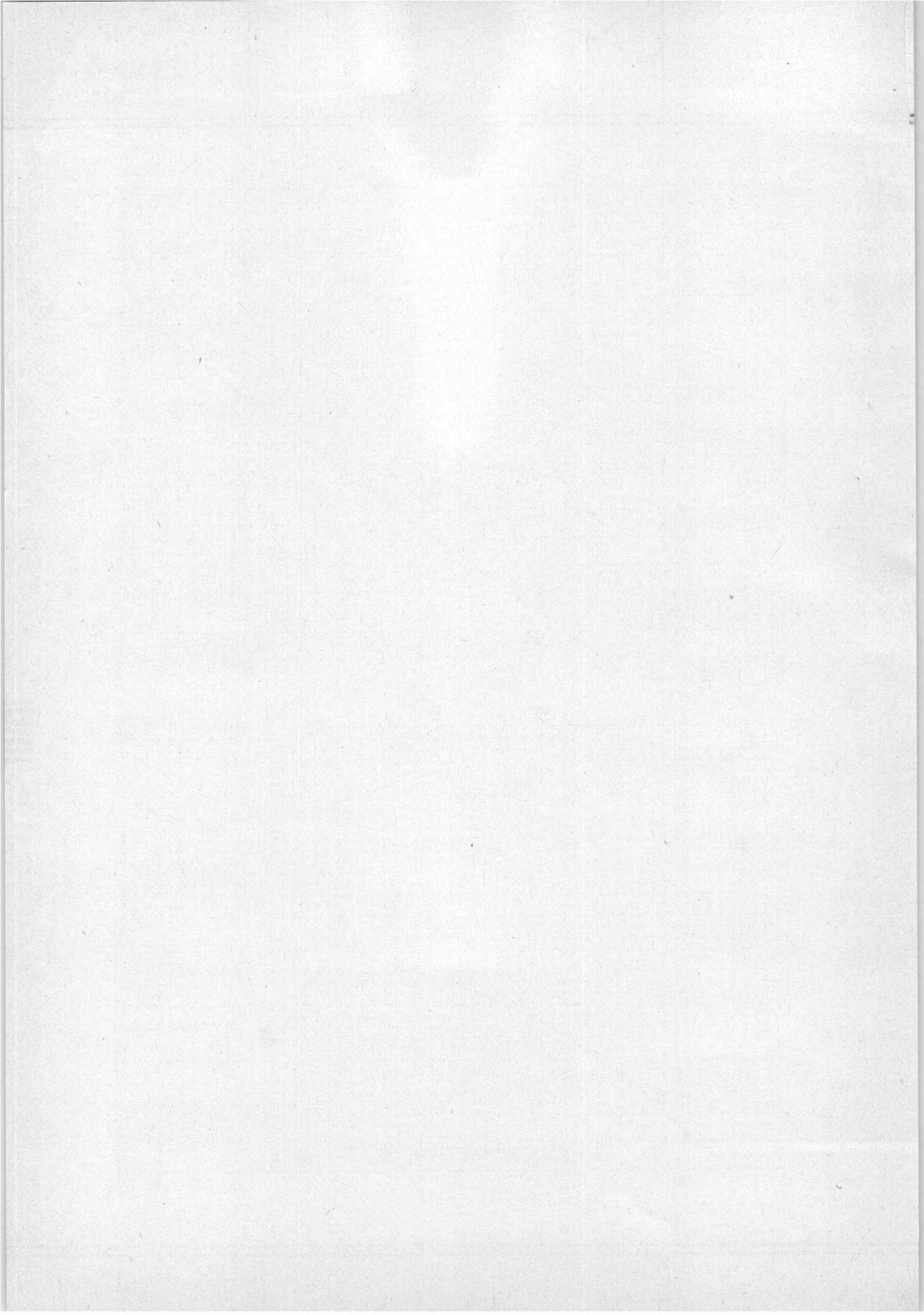

HIGH-VOLTAGE MERCURY-VAPOUR RECTIFYING TUBES

QUICK REFERENCE DATA

Peak inverse voltage	$V_{a \text{ invp}}$	max. 13.5	7 kV
Output current	I_o	max. 1.5	1.75 A
Peak anode current	I_{ap}	max. 6	7 A

HEATING: direct; filament oxide coated

Filament voltage	V_f	5 V
Filament current	I_f	7 A
Waiting time ($t_{Hg} > 25^\circ\text{C}$)	T_w	min. 30 s

A phase shift of $90^\circ \pm 30^\circ$ between V_a and V_f and the use of a centre-tapped filament transformer are recommended.

When the condensed mercury temperature $t_{Hg} < 25^\circ\text{C}$ the waiting time can be found with the aid of the curve on page A.

After transport or after long interruptions of operation the waiting time need not be prolonged.

TYPICAL CHARACTERISTICS

Arc voltage $V_{arc} (I_o = 1.5 \text{ A})$ 12 V

LIMITING VALUES (Absolute limits)

Mains frequency	f	up to 150	150 Hz
Peak inverse anode voltage	$V_{a\text{ invp}}$	max. 13.5	7 kV
Output current	I_o	max. 1.5	1.75 A
(Averaging time)	T_{av}	max. 10	10 s)
Peak anode current	I_{ap}	max. 6	7 A
Peak surge current	$I_{surge\ p}$	max. 50	50 A
(Duration)	T	max. 0.1	0.1 s)
Condensed mercury temperature	t_{Hg}	25 to 55	25 to 70 °C ¹⁾
Ambient temperature	t_{amb}	10 to 30	10 to 45 °C ²⁾

¹⁾ If the equipment is started not more than twice daily, it is permitted to apply the high tension at a condensed mercury temperature of 20 °C.

²⁾ Approximate values with natural cooling. The tube may be operated at higher ambient temperatures than the stated maxima, provided the difference between ambient and condensed mercury temperature (approximately 25 °C with natural cooling) is reduced by an air flow directed to the bulb just above the base. A reduction of the difference to less than 10 °C can easily be obtained with a simple air jet. Maximum life and best performance will be obtained when the condensed mercury temperature is kept at approx. 35 °C.

MECHANICAL DATA

Dimensions in mm

Net weight: 200 g

ZY1000

ZY1001

ZY1002

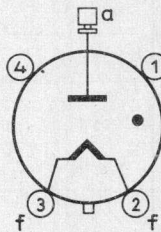
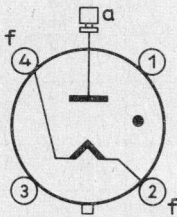
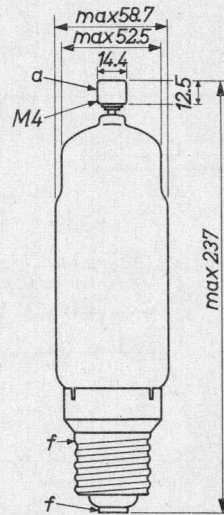
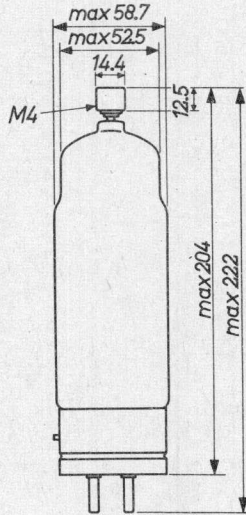
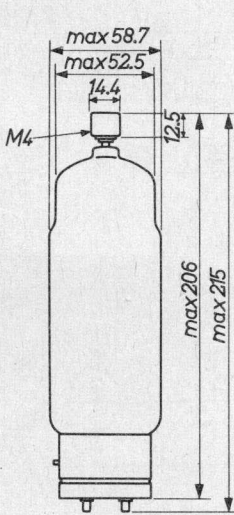

Base : Jumbo 4p with bayonet

Base : Super Jumbo with bayonet

Base : Goliath

Socket: 2422 511 02001

Socket: 2422 511 01001

Anode connector: 40619

Anode connector: 40619

Anode connector: 40619

Mounting position: vertical with base down

OPERATING CONDITIONS

Rectifier circuits

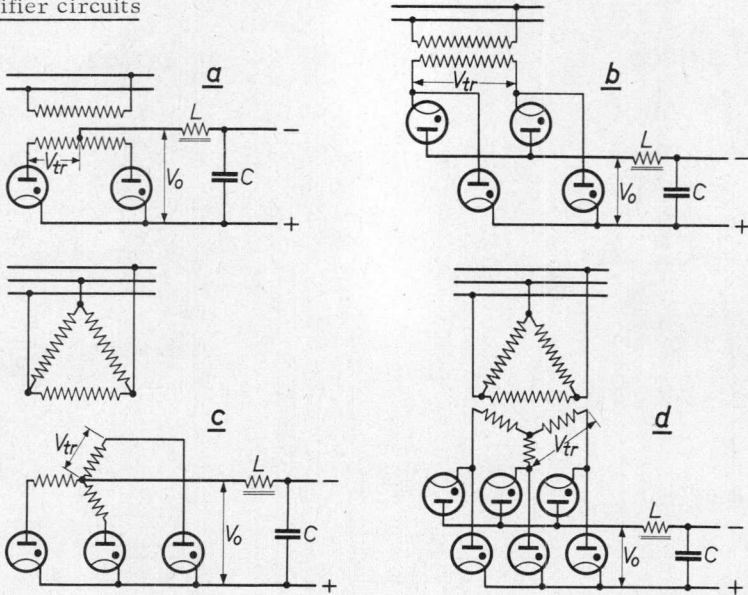

Maximum operating conditions

Transformer losses and voltage drops in the tubes have been neglected.

Peak inverse voltage $V_{a\ invp} = 13.5\text{ kV}$				
Circuit	Transformer voltage	Output voltage	Output current	Output power
	V_{tr} (kV, RMS)	V_o (kV)	I_o (A)	W_o (kW)
a	4.75	4.3	3.0	12.9
b	9.55	8.6	3.0	25.8
c	5.50	6.45	4.5	29
d	9.55	12.9	4.5	58

OPERATING CONDITIONS (continued)

Typical operating conditions

Peak inverse voltage $V_{a\text{ inv}p} = 12.3 \text{ kV (max. } 13.5 \text{ kV } ^1)$				
Circuit	Transformer voltage	Output voltage ²⁾	Output current	Output power
	V_{tr} (kV, RMS)	V_o (kV)	I_o (A)	W_o (kW)
a	4.35	3.6	3.0	10.8
b	8.7	7.2	3.0	21.6
c	5.0	5.4	4.5	24.3
d	8.7	10.8	4.5	48.6

¹⁾ Corresponding with mains voltage fluctuations of 10%

²⁾ Tube voltage drops and losses in transformer, filter, etc., amounting to 8% of the voltage across the load, have already been deducted.

ZY1000
ZY1001
ZY1002

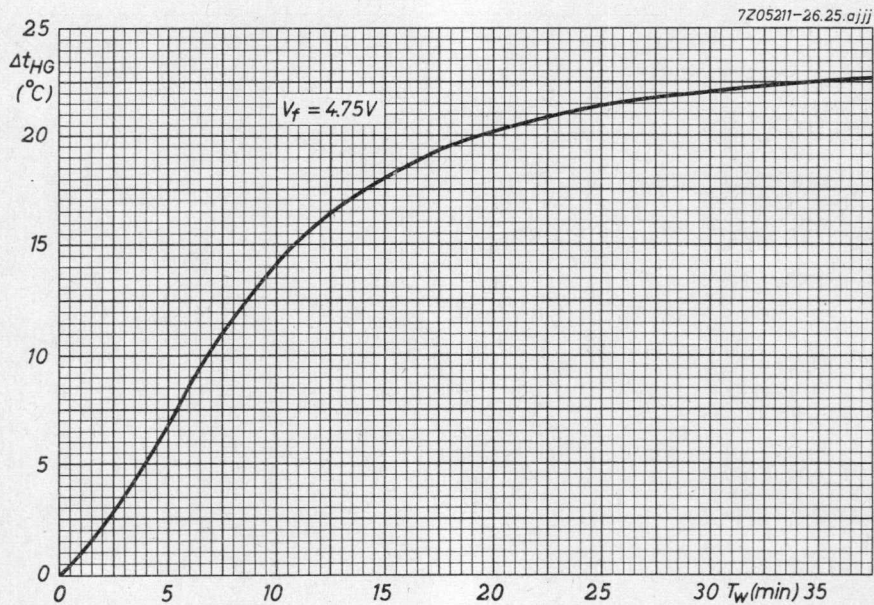

Associated accessories



COOLING WATER CONNECTION FOR IGNITRONS

TE1051b Cap nut (thread 3/8 in gas)

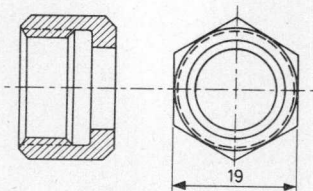

TE1051c Connection for 9 mm hose

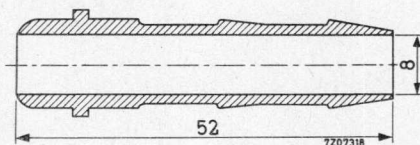

Material: brass

BIMETAL RELAY

Bimetal relay

QUICK REFERENCE DATA		
Heater current	I_R	85 to 115 mA
Timing		150 to 30 s

DIMENSIONS AND CONNECTIONS

Dimensions in mm

Base: A

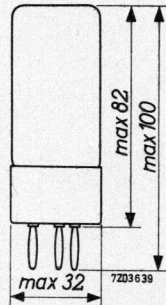
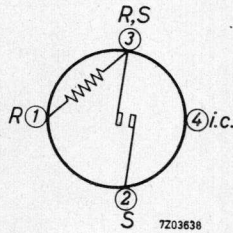

HEATING

Heater current	I_R	85 to 115 mA
At $t_{amb} < 25\text{ }^\circ\text{C}$ the recommended min. value is 95 mA		
Resistance of the heating element R	R	370 Ω

OPERATING CHARACTERISTICS at $t_{amb} = 25\text{ }^\circ\text{C}$

For dependency of temperature see page B

Heater current	I_R	85	95	115 mA
Timing		max. 150	55 to 85	min. 30 s

LIMITING VALUES (Absolute max. rating system)

Heater current	I_r	max.	125	mA
Ambient temperature	t_{amb}	max.	+60	°C
Current	t_{amb}	max.	-10	°C

Maximum current

	When switching on	When switching off
Mains voltage		
220 V=	1,5 A	250 mA
220 V~	1,5 A	250 mA
380 V~	0,7 A	75 mA

ACCESSORIES

Socket 2422 512 02001

40616

ANODE CAP

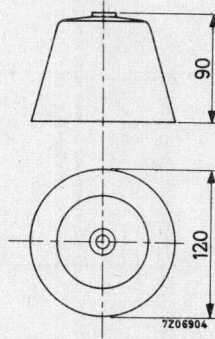

Material: phenolic

40619

TOP CAP CONNECTOR

for top caps with 14, 38 mm diameter (IEC 67-III-1b, type 3)

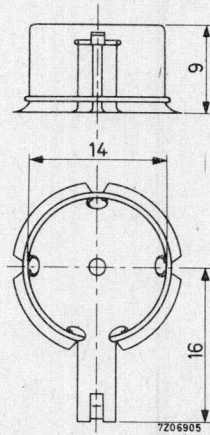

Material: brass, nickel plated

TOP CAP CONNECTOR

for top caps with 20, 32 mm diameter (IEC 67-III-1b, type 4)

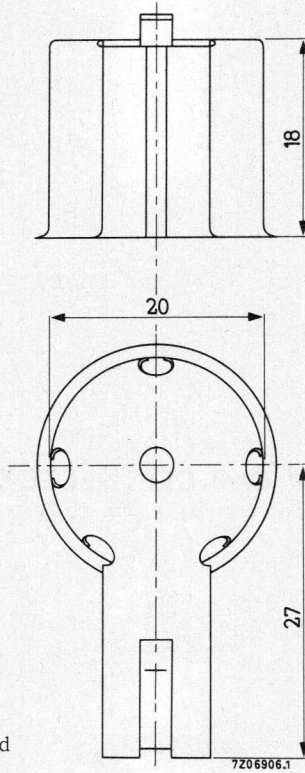

Material: brass, nickel plated

7206906.1

STRAP FOR THERMOSTAT

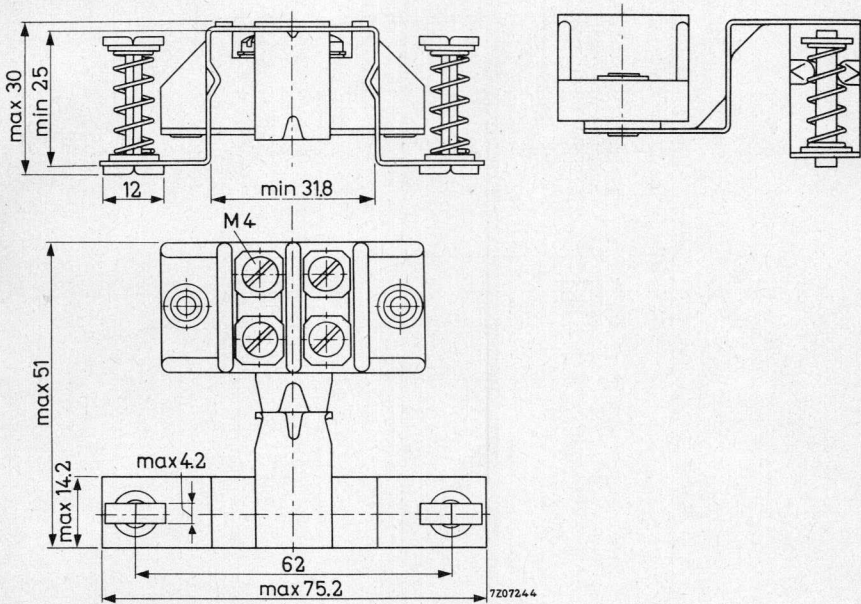

STRAP FOR THERMOSTAT

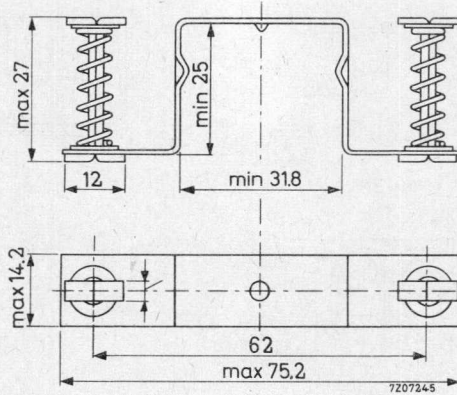

WATER SAVING THERMOSTAT

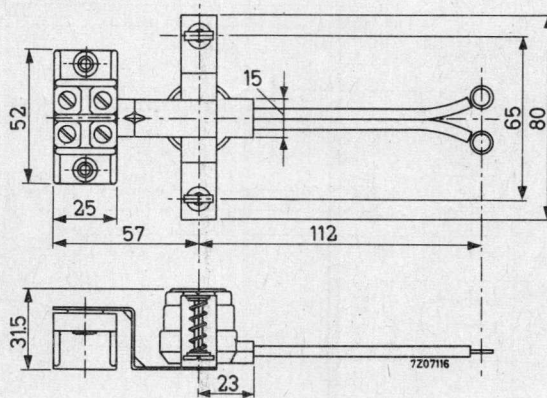

The thermostat has a normally open contact which closes at a typical plate temperature of 35 ± 3 °C and reopens at 30 ± 3 °C

Contact ratings

30	V _{dc}	10	A
125	V _{rms}	10	A
250	V _{rms}	8	A
600	V _{rms}	0.5	A

Max. voltage between ignitron and thermostat 600 V_{rms}

PROTECTING THERMOSTAT

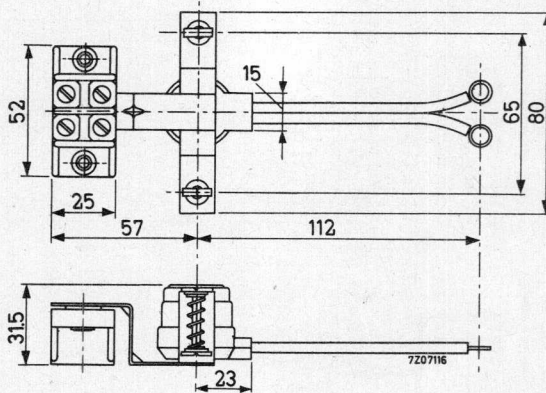

The thermostat has a normally closed contact which opens at a typical plate temperature of 52 ± 3 °C and recloses at 41 ± 3 °C

Contact ratings

30	V _{dc}	10	A
125	V _{rms}	10	A
250	V _{rms}	8	A
600	V _{rms}	0.5	A

Max. voltage between ignitron and thermostat 600 V_{rms}

WATER SAVING THERMOSTAT

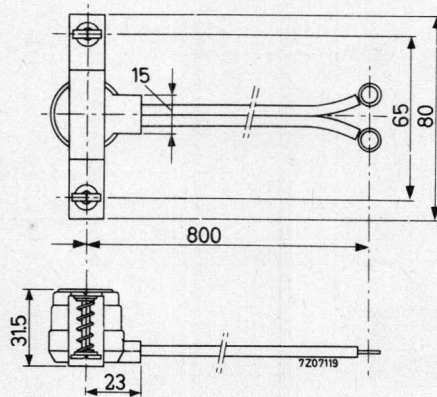

The thermostat has a normally open contact which closes at a typical plate temperature of 35 ± 3 °C and reopens at 30 ± 3 °C

Contact ratings

30	V _{dc}	10	A
125	V _{rms}	10	A
250	V _{rms}	8	A
600	V _{rms}	0.5	A

Max. voltage between ignitron and thermostat 600 V_{rms}

PROTECTING THERMOSTAT

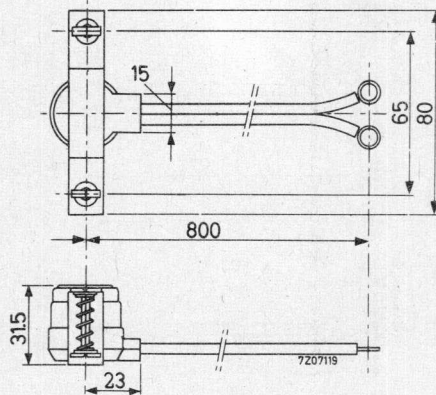

The thermostat has a normally closed contact which opens at a typical plate temperature of 52 ± 3 °C and recloses at 41 ± 3 °C

Contact ratings

30	V _{dc}	10	A
125	V _{rms}	10	A
250	V _{rms}	8	A
600	V _{rms}	0.5	A

Max. voltage between ignitron and thermostat 600 V_{rms}

IGNITOR CABLE

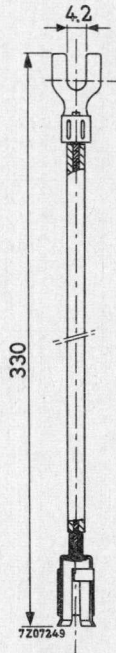

IGNITOR CONNECTOR

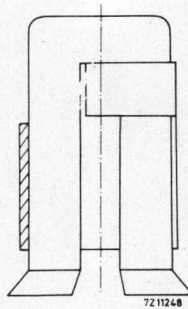

7211248

Index



INDEX OF TYPE NUMBERS

Type no.	Section	Type no.	Section	Type no.	Section
AGR9950	H. V.	TE1051c	Acc.	1174	I. R. T.
DCG4/1000	H. V.	ZT1000	H. V.	1176	I. R. T.
DCG4/5000	H. V.	ZT1001	H. V.	1177	I. R. T.
DCG5/5000	H. V.	ZX1051	Ign.	1710	I. R. T.
DCG6/18	H. V.	ZX1052	Ign.	1725A	I. R. T.
DCG6/18GB	H. V.	ZX1053	Ign.	1738	I. R. T.
DCG6/6000	H. V.	ZX1061	Ign.	1749A	I. R. T.
DCG7/100	H. V.	ZX1062	Ign.	1788	I. R. T.
DCG7/100B	H. V.	ZX1063	Ign.	1838	I. R. T.
DCG9/20	H. V.	ZX1081	Ign.	1849	I. R. T.
DCG12/30	H. V.	ZX1082	Ign.	1859	I. R. T.
DCX4/1000	H. V.	ZY1000	H. V.	4152/02	Acc.
DCX4/5000	H. V.	ZY1001	H. V.	40616	Acc.
PL2D21	Th.	ZY1002	H. V.	40619	Acc.
PL3C23A	Th.	328	I. R. T.	40620	Acc.
PL105	Th.	354	I. R. T.	40713	Acc.
PL255	Th.	367	I. R. T.	40714	Acc.
PL260	Th.	451	I. R. T.	55305	Acc.
PL1607	Th.	1010	I. R. T.	55306	Acc.
PL5544	Th.	1037	I. R. T.	55317	Acc.
PL5545	Th.	1039	I. R. T.	55318	Acc.
PL5551A	Ign.	1049	I. R. T.	55351	Acc.
PL5552A	Ign.	1054	I. R. T.	55357	Acc.
PL5553B	Ign.	1069K	I. R. T.		
PL5557	Th.	1110	I. R. T.		
PL5559	Th.	1119	I. R. T.		
PL5684/C3JA	Th.	1138	I. R. T.		
PL5727	Th.	1163	I. R. T.		
PL6574	Th.	1164	I. R. T.		
TE1051b	Acc.	1173	I. R. T.		

Acc. = Associated accessories
H. V. = High-voltage rectifying tubes
Ign. = Ignitrons

I. R. T. = Industrial rectifying tubes
Th. = Thyratrons

Thyratrons

Industrial rectifying tubes

Ignitrons

High - voltage rectifying tubes

Associated accessories

Index

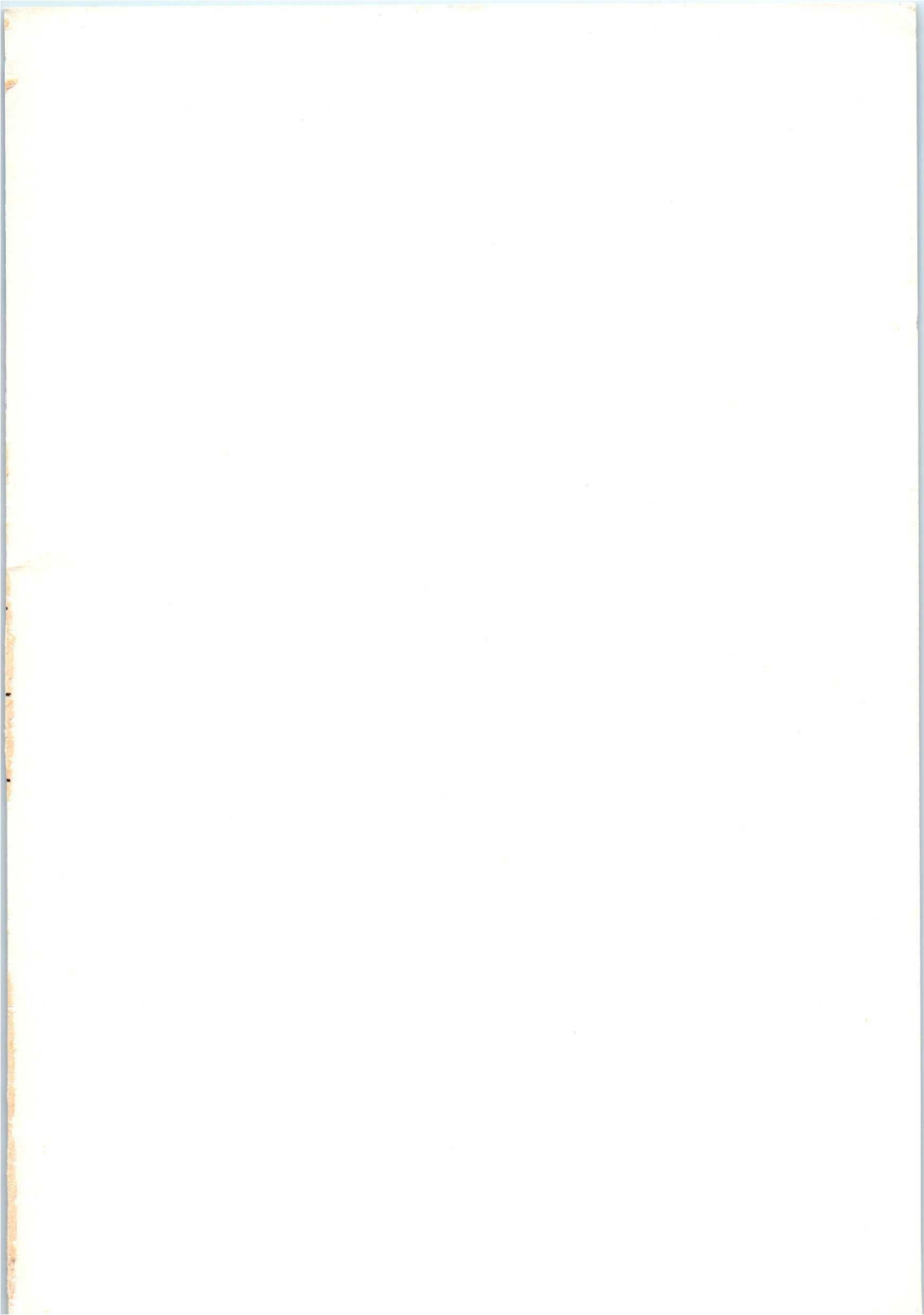

Electronic components and materials for professional, industrial and consumer uses from the world-wide Philips Group of Companies

- Argentina:** FAPESA I y C., Av. Crovara 2550, Tablada, Prov. de BUENOS AIRES, Tel. 652-7438/7478.
- Australia:** PHILIPS INDUSTRIES HOLDINGS LTD., Elcoma Division, 67 Mars Road, LANE COVE, 2066, N.S.W., Tel. 42 1261.
- Austria:** ÖSTERREICHISCHE PHILIPS BAUELEMENTE Industrie G.m.b.H., Triester Str. 64, A-1101 WIEN, Tel. 62 91 11.
- Belgium:** M.B.L.E., 80, rue des Deux Gares, B-1070 BRUXELLES, Tel. 523 00 00.
- Brazil:** IBRAPE, Caixa Postal 7383, Av. Paulista 2073-S/Loja, SAO PAULO, SP, Tel. 287-7144.
- Canada:** PHILIPS ELECTRONICS LTD., Electron Devices Div., 601 Milner Ave., SCARBOROUGH, Ontario, M1B 1M8, Tel. 292-5161.
- Chile:** PHILIPS CHILENA S.A., Av. Santa Maria 0760, SANTIAGO, Tel. 39-40 01.
- Colombia:** SADAPE S.A., P.O. Box 9805 Calle 13, No. 51 + 39, BOGOTA D.E. 1., Tel. 600 600.
- Denmark:** MINIWATT A/S, Emdrupvej 115A, DK-2400 KØBENHAVN NV., Tel. (01) 69 16 22.
- Finland:** OY PHILIPS AB, Elcoma Division, Kaivokatu 8, SF-00100 HELSINKI 10, Tel. 1 72 71.
- France:** R.T.C. LA RADIOTECHNIQUE-COMPELEC, 130 Avenue Ledru Rollin, F-75540 PARIS 11, Tel. 355-44-99.
- Germany:** VALVO, UB Bauelemente der Philips G.m.b.H., Valvo Haus, Burchardstrasse 19, D-2 HAMBURG 1, Tel. (040) 3296-1.
- Greece:** PHILIPS S.A. HELLENIQUE, Elcoma Division, 52, Av. Syngrou, ATHENS, Tel. 915 311.
- Hong Kong:** PHILIPS HONG KONG LTD., Comp. Dept., Philips Ind. Bldg., Kung Yip St., K.C.T.L. 289, KWAI SHUNG, N.T. Tel. 12-24 51 21.
- India:** PHILIPS INDIA LTD., Elcoma Div., Band Box House, 254-D, Dr. Annie Besant Rd., Prabhadevi, BOMBAY-25-DD, Tel. 457 311-5.
- Indonesia:** P.T. PHILIPS-RALIN ELECTRONICS, Elcoma Division, 'Timah' Building, Jl. Jen. Gatot Subroto, JAKARTA, Tel. 44 163.
- Ireland:** PHILIPS ELECTRICAL (IRELAND) LTD., Newstead, Clonskeagh, DUBLIN 14, Tel. 69 33 55.
- Italy:** PHILIPS S.P.A., Sezione Elcoma, Piazza IV Novembre 3, I-20124 MILANO, Tel. 2-6994.
- Japan:** NIHON PHILIPS CORP., Shuwa Shinagawa Bldg., 26-33 Takanawa 3-chome, Minato-ku, TOKYO (108), Tel. 448-5611.
(IC Products) SIGNETICS JAPAN, LTD., TOKYO, Tel. (03) 230-1521.
- Korea:** PHILIPS ELECTRONICS (KOREA) LTD., Philips House, 260-199 Itaewon-dong, Yongsan-ku, C.P.O. Box 3680, SEOUL, Tel. 44-4202.
- Mexico:** ELECTRONICA S.A. de C.V., Varsovia No. 36, MEXICO 6, D.F., Tel. 5-33-11-80.
- Netherlands:** PHILIPS NEDERLAND B.V., Afd. Elonco, Boschdijk 525, NL-4510 EINDHOVEN, Tel. (040) 79 33 33.
- New Zealand:** Philips Electrical Ind. Ltd., Elcoma Division, 70-72 Kingsford Smith Street, WELLINGTON, Tel. 873 156.
- Norway:** ELECTRONICA A/S., Vitaminveien 11, P.O. Box 29, Grefsen, OSLO 4, Tel. (02) 15 05 90.
- Peru:** CADESA, Jr. Ilo, No. 216, Apartado 10132, LIMA, Tel. 27 73 17.
- Philippines:** ELDAC, Philips Industrial Dev. Inc., 2246 Pasong Tamo, MAKATI-RIZAL, Tel. 86-89-51 to 59.
- Portugal:** PHILIPS PORTUGESA S.A.R.L., Av. Eng. Duharte Pacheco 6, LISBOA 1, Tel. 68 31 21.
- Singapore:** PHILIPS SINGAPORE PTE LTD., Elcoma Div., POB 340, Toa Payoh CPO, Lorong 1, Toa Payoh, SINGAPORE 12, Tel. 53 88 11.
- South Africa:** EDAC (Pty.) Ltd., South Park Lane, New Doornfontein, JOHANNESBURG 2001, Tel. 24/6701.
- Spain:** COPRESA S.A., Balmes 22, BARCELONA 7, Tel. 301 63 12.
- Sweden:** A.B. ELCOMA, Lidingövägen 50, S-10 250 STOCKHOLM 27, Tel. 08/67 97 80.
- Switzerland:** PHILIPS A.G., Elcoma Dept., Edenstrasse 20, CH-8027 ZÜRICH, Tel. 01/44 22 11.
- Taiwan:** PHILIPS TAIWAN LTD., 3rd Fl., San Min Building, 57-1, Chung Shan N. Rd, Section 2, P.O. Box 22978, TAIPEI, Tel. 5513101-5.
- Turkey:** TÜRK PHILIPS TICARET A.S., EMET Department, Gümüssuyu Cad. 78-80, Beyoğlu, ISTANBUL, Tel. 45 32 50.
- United Kingdom:** MULLARD LTD., Mullard House, Torrington Place, LONDON WC1E 7HD, Tel. 01-580 6633.
- United States:** (Active devices & Materials) AMPEREX SALES CORP., 230, Duffy Avenue, HICKSVILLE, N.Y. 11802, Tel. (516) 931-6200.
(Passive devices) MEPCO/ELECTRA INC., Columbia Rd., MORRISTOWN, N.J. 07960, Tel. (201) 539-2000.
(IC Products) SIGNETICS CORPORATION, 811 East Arques Avenue, SUNNYVALE, California 94086, Tel. (408) 739-7700.
- Uruguay:** LUZILECTRON S.A., Rondeau 1567, piso 5, MONTEVIDEO, Tel. 9 43 21.
- Venezuela:** IND. VENEZOLANAS PHILIPS S.A., Elcoma Dept., A. Ppal de los Ruices, Edif. Centro Colgate, Apdo 1167, CARACAS, Tel. 36 05 11.