

RCA RADIOTRON-
Cunningham
RADIO TUBE
- MANUAL -

TECHNICAL SERIES NO. RC-11

PRICE 25 CENTS

RCA RADIOTRON CO., Inc.

HARRISON, NEW JERSEY



Division Sales Offices

EASTERN

CAMDEN, N. J.
FRONT & COOPER STS.

WESTERN

CHICAGO, ILL.
520 N. MICHIGAN AVE.

DISTRICT SALES OFFICES IN PRINCIPAL CITIES



 **Radiotrons**

Cunningham
RADIO TUBES

THE

 **Radiotron-***Cunningham*
RADIO TUBES

MANUAL



TECHNICAL SERIES

RC-11

Copyright, 1933
by
RCA RADIOTRON CO., Inc.

Printed in U. S. A.

FOREWORD

The RCA RADIOTRON-CUNNINGHAM RADIO TUBE MANUAL, like its preceding editions, has been prepared especially to assist those who work or experiment with radio tubes and circuits.

The information and technical data presented in this book were selected only after careful consideration of their usefulness in the field of radio-tube applications. While the form, in general, follows that of the previous editions, it will be found that many additions and numerous revisions have been made.

Material on the individual tube types is arranged starting with the new three-symbol types in numerical-alphabetical sequence. Other two- and three-digit types follow in numerical sequence on the basis of the last two digits.

This Manual will be found valuable by radio service men, radio technicians, experimenters, radio amateurs, and by all others technically interested in radio tubes.

Commercial Engineering Section
RCA RADIOTRON CO., INC.

Harrison, New Jersey

The license extended to the purchaser of tubes appears in the License Notice accompanying them. Information contained herein is furnished without assuming any obligations.

CONTENTS

	PAGE
ELECTRONS AND ELECTRODES	1
Cathodes, Diodes, Triodes, Tetrodes, Pentodes, Multi-Electrode and Multi-Unit Tubes.	
RADIO TUBE CHARACTERISTICS	7
Static, Dynamic.	
RADIO TUBE APPLICATION	9
Amplification, Rectification, Detection, Automatic Volume Control, Automatic Noise Suppression, Oscillation, Frequency Conversion.	
RADIO TUBE INSTALLATION	23
Filament and Heater Circuits; Plate Voltage, Grid Voltage, and Screen Voltage Supply; Shielding; Filters; Output Coupling Devices.	
RADIO TUBE MANUFACTURE (VIEWS)	28
TECHNICAL DESCRIPTION BY TUBE TYPES	30
Additional types on page 143.	
RADIO TUBE TESTING	133
RADIO TUBE CIRCUITS	136
TABLE: TYPES 2A6, 2B7, 6B7, 55, 75, 77, 85	142
Operating Conditions for Resistance-Coupled A-F Amplifier Service.	
RADIO TUBE CHARACTERISTICS CHART	144
SOCKET CONNECTIONS	150
RADIO TUBE DIMENSIONS	151
INDEX	152





MANUAL

Electrons and Electrodes

The radio tube is a marvelous device. Although it appears to be a fragile affair constructed of metal and glass, in reality it is a rugged instrument that makes possible the performing of operations, amazing in conception, with a precision and a certainty that is astounding. It is an exceedingly sensitive and accurate instrument—the product of coordinated efforts of engineers and craftsmen. Its construction requires materials from every corner of the earth. Its use is world-wide. Its future possibilities, even in the light of present day accomplishments, are but dimly foreseen, for each development opens new fields of design and application.

ELECTRONS

A radio tube consists of a cathode and one or more additional electrodes—all enclosed in an evacuated glass bulb—with their electrical connections brought to exterior terminals. The cathode supplies electrons while the other electrodes control and collect them.

The importance of the radio tube lies in its ability to control almost instantly the flight of the millions of electrons supplied by the cathode. It accomplishes this with a minimum of control energy. Because it is almost instantaneous in its action, the radio tube can operate efficiently and accurately at electrical frequencies much higher than possible with rotating machines.

All matter exists in the solid, liquid, or gaseous state. These three forms of matter consist entirely of minute divisions known as molecules. Molecules are assumed to be composed of atoms. According to a present accepted theory, atoms have a nucleus which is a positive charge of electricity. Around this nucleus revolve tiny charges of negative electricity known as "electrons." Scientists have estimated that these invisible bits of electricity weigh only 1/46 billion, billion, billion, billionths of an ounce since they may travel at speeds of thousands of miles per second.

Electron movement may be accelerated by the addition of energy. Heat is one form of energy which can be conveniently used to speed up the electron. For example, if the temperature of a metal is gradually raised, the electrons gain velocity. When the metal becomes hot enough to glow, some electrons may acquire sufficient speed to break away from their nuclei. This action is utilized in the radio tube to produce the necessary electron supply.

CATHODES

A cathode is an essential part of a radio tube since it supplies the electrons necessary for tube operation. In general, heat is the form of energy applied to the cathode to release the electrons. The method of heating the cathode may be used to distinguish between the different forms of cathodes. For example, a **directly-heated cathode**, or filament-cathode, is a wire heated by the passage of an electric current. An **indirectly-heated cathode**, or heater-cathode, consists of a filament, or heater, enclosed in a metal sleeve. The sleeve carries the electron-emitting material on its outside surface and is heated by radiation and conduction from the heater.

A filament-, or **directly-heated cathode**, may be further classified by identifying the filament or electron-emitting material. The materials in regular use are tungsten, thoriated-tungsten, and metals which have been coated with alkaline-earth oxides. Tungsten filaments are made from pure metal. Since they must operate

THE RCA RADIOTRON-CUNNINGHAM RADIO TUBE MANUAL

at high temperatures (a dazzling white) to emit sufficient electrons, a relatively large amount of filament power is required. Thoriated-tungsten filaments are drawn from tungsten slugs which have been impregnated with thoria. Due to the thorium, these filaments liberate electrons at a more moderate temperature (a bright yellow) and are, therefore, much more economical of filament power than are pure tungsten filaments. Alkaline earths are usually applied by coating a nickel alloy wire or ribbon with a mixture containing the materials. This coating, which is dried in a substantial layer on the filament, requires only a very low temperature (a dull red) to produce a copious supply of electrons. Coated filaments operate very efficiently and require relatively little filament power. However, each of these cathode materials has special advantages which determine the choice for a particular application. In general, tubes made with filament-cathodes or heater-cathodes and designed for use in radio receivers, utilize the coated construction.

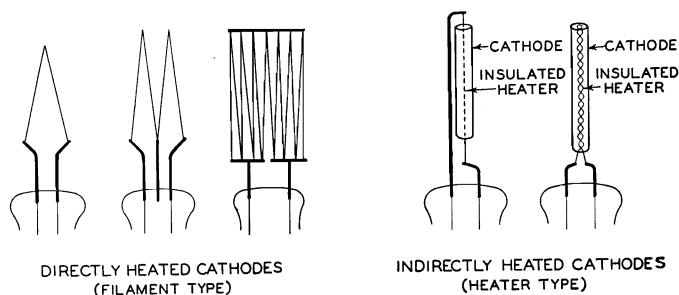

Filament-cathode types of tubes are particularly well suited for operation from a steady source of filament-supply voltage such as a battery. Tubes for this service can be designed with cathodes which give economical production of electrons and, consequently, economical set operation. Tubes constructed primarily for economical battery operation are not very satisfactory for use with alternating-current filament supply, due to the variation in electron emission and potential in the space-charge region which occurs with each alternation of the current. This variation is amplified by the tube and produces hum in the loudspeaker. When filament-cathode types of tubes are to be used on a-c filament supply, special precautions are taken in the design to reduce hum disturbances to a point where the hum will not be troublesome. These precautions include such features as the utilization of massive filaments which minimize temperature fluctuations, the use of filaments which have sufficient excess electron emission so that a very large temperature change is required to reduce the emission below the value needed for normal tube operation, and the proportioning of tube parts to minimize the electrostatic and magnetic effects produced by alternating current on the filament. The 26 is an example of a filament-cathode type of tube particularly useful for operation on alternating current.

Heater-, or **indirectly-heated cathodes**, comprise an assembly of a thin metal sleeve coated with active material and a heater contained within and separated from the sleeve. The heater is made of tungsten wire and is used only for the purpose of heating the sleeve and its coating to an electron-emitting temperature. The tungsten wire is operated at a moderate temperature and supplies the energy for heating the sleeve.

The heater-cathode construction is well adapted for use in radio tubes intended for operation from a-c power lines. The use of separate parts for emitter and heater functions, the electrical insulation of the heater from the emitter, and the shielding effect of the sleeve may all be utilized in the design of the tube to prevent the a-c heater supply from causing hum. Representative types are the 24-A, 57, and 78. From the viewpoint of circuit design, the heater-cathode construction offers advantages in connection flexibility due to the electrical separation of the heater from the sleeve and active cathode-surface.

DIODES

Electrons are of no value in a radio tube unless they can be put to work. A radio tube is designed with the necessary parts to provide and to utilize the electron flow. These parts consist of a cathode and one or more supplementary electrodes. The simplest form of radio tube contains two electrodes, a "cathode" and a "plate" and is often called a "diode," the family name for two-electrode tubes.

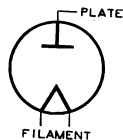

The electrodes are enclosed in a bulb with the necessary connections brought out through air-tight seals. The air is removed from the bulb to allow free movement of the electrons and to prevent injury to the emitting surface of the cathode. When the cathode is heated, electrons leave the cathode surface and form an invisible cloud in the space around it. Any positive electric potential within the evacuated bulb will offer a strong attraction to the electrons (unlike electric charges attract; like charges repel). In a diode, the positive potential is applied to the second electrode, known as the anode. The potential is supplied by a suitable electrical source connected between the plate terminal and a cathode terminal. Under the influence of the positive plate potential, electrons flow from the cathode to the plate and return through the external plate-battery circuit to the cathode, thus completing the circuit. This flow of electrons is known as the plate current and may be measured by a sensitive current-meter.

If a negative potential is supplied to the plate, the free electrons in the space surrounding the cathode will be forced back to the cathode, and no plate current will flow. Thus, the tube permits electrons to flow from the cathode to the plate but not from the plate to the cathode. If an alternating voltage is applied to the plate, the plate is alternately made positive and negative. Plate current flows only during the time when the plate is positive. This phenomenon makes the tube useful as a rectifier of alternating current, that is, to provide a current flow always in the same direction. Rectifying action is utilized in a-c receivers to convert a.c. to d.c. for supplying "B," "C" and screen voltages to the other tubes in the receiver circuit. Rectifier tubes may have one plate and one cathode. The '81 is of this form and is called a **half-wave rectifier**, since current can flow only during one-half of the alternating-current cycle. When two plates and one or more cathodes are used in the same tube, current may be obtained on both halves of the a-c cycle. The 80, 82, 83 and 5Z3 are examples of this type and are called **full-wave rectifiers**.

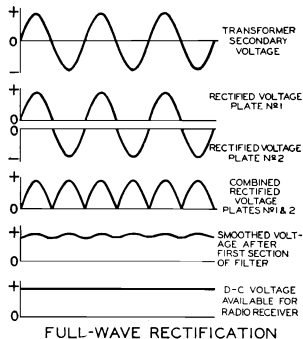

Not all of the electrons emitted by the cathode reach the plate. Some return to the cathode while others remain in the space between the cathode and plate for a brief period to form an effect known as **space-charge**. This charge has a repelling action on other electrons which leave the cathode surface, and impedes their passage to the plate. The extent of this action and the amount of space-charge is greatly dependent upon the cathode temperature and the plate potential. The higher the plate potential, the less is the tendency for the space electrons remaining to repel others. This effect may be noted by applying increasingly higher plate voltages to a tube operating at a fixed cathode voltage. Under these conditions, the maximum number of available electrons is fixed, but increasingly higher plate voltages will succeed in attracting a greater proportion of the free electrons.

Beyond a certain plate voltage, however, additional plate voltage has little effect in increasing the plate current because all of the electrons emitted by the cathode are being drawn to the plate. This maximum current is called **saturation current**, and because it is an indication of the total number of electrons emitted, it is also

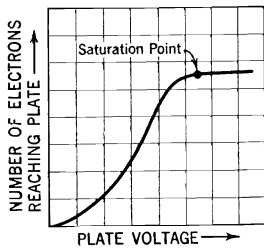

known as the **emission current**, or, simply, **emission**. In most types of tubes, it is impossible to obtain this value by measurement, since the current flow is sufficiently large to change the emitting conditions, or to damage the tube. As a result, emission values in practice are determined at some lower voltage which will not harm the tube. Different results will be obtained if a different cathode voltage or temperature is chosen, since the cathode temperature determines the number of available electrons.

If space-charge effects were not present, it follows that the same electron flow could be produced at a lower plate voltage. One method of reducing the space-charge effect is utilized in several types of rectifier tubes, represented by the mercury-vapor rectifier 82. This tube contains a small amount of mercury which is partially vaporized when the tube is operated. The mercury vapor consists of tiny mercury atoms permeating the space inside the bulb. These atoms are bombarded by the electrons on their way to the plate. If the electrons are moving at a sufficiently high speed, the collisions will tear off electrons from the mercury atoms. When this happens, the mercury atom is said to be "**ionized**," that is it has lost one or more electrons and, therefore, is charged positive. When ionization due to bombardment of mercury atoms by electrons leaving the filament occurs, the space-charge is neutralized by the positive mercury ions so that increased numbers of electrons are made available. A mercury-vapor rectifier has a small voltage drop between cathode and plate (about 15 volts). This drop is practically independent of current requirements up to the limit of emission of electrons from the filament but is dependent to some degree on bulb temperature.

TRIODES

When a third electrode, called the **grid**, is placed next to the cathode, the tube is known as a "triode." This is the family name for three-electrode types. The grid usually consists of a wire mesh or grating, the appearance of which suggests its name. Its construction allows practically unobstructed flight of the electrons from the cathode to the plate.

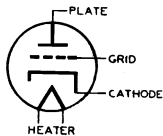

When the grid of a tube is made positive or negative with respect to the cathode, the plate current correspondingly increases or decreases. The grid is located much nearer the cathode than the plate so that a small voltage change on the grid will have the same effect on the plate current as a larger voltage change on the plate. A grid requires very little power, serving merely as a valve to control the plate current.

A negatively-charged grid tends to force the space electrons back toward the filament. This action decreases the plate current. Plate current, in fact, may be reduced to zero (**cut-off**) by making the negative grid-charge sufficiently large. On the other hand, when a positive charge is applied to the grid, the electrons are accelerated and increased plate current results.

It should be noted that this control action of the grid permits the use of the tube as an amplifier. A small grid-voltage change produces a much larger plate current variation than would the same change in plate voltage. Typical three-electrode tubes are the 30, 27, 56, and 2A3.

The **control-grid circuit (input circuit)** includes any device or devices connected between the control grid and cathode of a tube for the purpose of impressing an input or signal voltage on the control grid. It may consist of an antenna coupling-coil, a transformer secondary, or any unit having one or all the factors of inductance, resistance and capacity. Since it is usually desirable to maintain the grid at some negative voltage (called **grid bias**) with respect to the cathode, the grid circuit will, in such cases, also include a source of voltage supply for that purpose. The grid-bias supply (**C-supply**) may be a battery or other source of d-c voltage. The **output circuit** is considered to include the parts of the circuit connected between the plate and cathode.

The electrodes of a radio tube form an electrostatic system, each electrode acting as one plate of a small condenser. For a three-electrode tube the capacitances are known as **interelectrode capacitances** and are those existing between the grid and plate, the plate and cathode, and the grid and cathode. Of these, the capacity between the grid and plate is generally of most importance. In high-gain radio-frequency amplifier circuits, this capacity may act to produce undesired coupling between the input and output circuits and, thereby, cause uncontrolled regeneration

TETRODES

The effect of grid-plate capacitance in causing excess regeneration may be minimized or eliminated in a number of ways. One scheme requires the use of complicated circuit arrangements which set up counteracting effects to counterbalance the action of the grid-plate coupling. The second and preferable method is to eliminate as much as possible the grid-to-plate capacitance in the tube itself. This is accomplished by employing a fourth electrode in the tube which is known as the screen. The screen is placed between the plate and the grid and thus makes a four-electrode tube, or "tetrode." With this type of tube intricate circuits and balancing difficulties may be eliminated. Since the screen voltage largely determines the electron flow, small changes of plate voltage have little effect on plate current. This is desirable from the viewpoint of stability. The screen is constructed so that the flow of electrons is not materially obstructed, yet it serves to establish an electrostatic shield between the plate and grid. The screen is operated at some positive voltage lower than that of the plate and is bypassed to the cathode through a condenser. This by-pass condenser effectively grounds the screen for high-frequency currents and assists in reducing grid-plate capacitance to a minimum value. In general practice the grid-plate capacitance is reduced from an average of 8.0 micro-microfarads ($\mu\mu f$) for a triode to 0.01 $\mu\mu f$ or less for a screen grid tube. The reduction permits the attainment of stable amplification from screen grid tubes many times as high as that possible from three-electrode tubes. Tubes of this type are represented by the 24-A, 32 and 35.

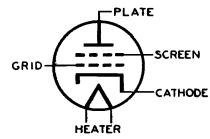

PENTODES

In all radio tubes, electrons striking the plate may, if moving at sufficient speed, dislodge other electrons. In two- and three-electrode types, these vagrant electrons usually cause no trouble because no positive electrode other than the plate itself is present to attract them so that they are eventually drawn back to the plate. Emission from the plate caused by bombardment of the plate by electrons from the cathode is called **secondary emission**, because the effect is secondary to the original cathode emission. In the case of screen grid tubes, the proximity of the positive screen to the plate offers a strong attraction to these secondary electrons and particularly so if the plate voltage swings lower than the screen voltage. This effect lowers the plate current and limits the permissible plate swing for tetrodes.

The plate current limitation is removed when a fifth electrode, known as the **suppressor**, is placed in the tube between the screen and plate. The family name for five-electrode types is "pentode." The suppressor is usually connected to the cathode. Because of its negative potential with respect to the plate, it retards the flight of secondary electrons and diverts them back to the plate, where they can cause no trouble.

The suppressor is utilized at the present time in pentodes designed for two different functions. In power output pentodes, the suppressor makes possible a large power output with high gain, due to the fact that the plate swing can be made very large. Tubes of this type are represented by the 33, 38, 47 and 2A5. In radio-frequency amplifier pentodes, the suppressor permits of obtaining a high voltage amplification at moderate values of plate voltage. In fact, the plate voltage may be as low as or lower than the screen voltage without serious loss in the gain capabilities of this type. Representative of this type are the 34 and 77. Further advantages in adaptability of tube design and application may be obtained by pro-

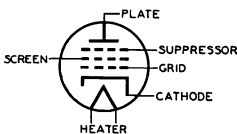

viding the suppressor with its own base terminal. With this arrangement, it is possible to obtain special control features by variation of the voltage applied to the suppressor. Typical tubes of this type are the 57 and 58.

MULTI-ELECTRODE and MULTI-UNIT TUBES

In the initial period of tube development and application, tubes were of the so-called "general purpose type;" that is, a single tube-type—a triode—was used as a radio-frequency amplifier, an intermediate-frequency amplifier, an audio-frequency amplifier, an oscillator, or as a detector. Obviously, with this diversity of application, one tube did not meet all requirements to the best advantage.

Later and present trends of tube design are the development of "specialty" types. These types are intended either to give optimum performance in a particular application or to combine in one bulb functions which formerly required two or more tubes. The first class of tubes includes such examples of specialty types as the 40, 71-A, 24-A, 35 and the 2A5. Types of this class, in general, require more than three electrodes to obtain the desired special characteristics. Thus, they may be broadly classed as multi-electrode types.

Tubes of the multi-electrode type often present interesting possibilities of application, since the electrodes may be connected in a number of ways for several different kinds of service. For example, the 46 can be used either as a Class A or Class B output amplifier triode. The 59, a triple-grid power amplifier, has not only these possibilities, but may also be used as a Class A amplifier pentode.

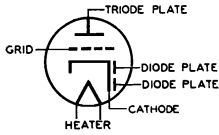

Duplex-Diode Triode

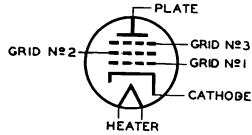

Triple-Grid Power Amplifier

The second class includes multiple-unit tubes such as the duplex-diode triodes 55, 75 and 85, as well as the duplex-diode pentodes 2B7 and 6B7 and the twin Class B amplifier types 53 and 79. These types all have two or more separate tube units. It is interesting to note that the 80 is one of the earliest illustrations of multi-unit tubes.

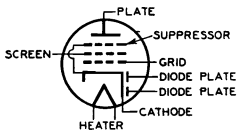

Duplex-Diode Pentode

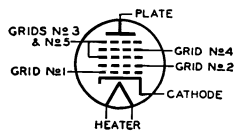

Pentagrid Converter

A third class combines features of each of the previous classes. Typical of this class are the 2A7 and the 6A7 pentagrid converter types. These are tubes having an unusually large number of electrodes (seven exclusive of heater) all of which affect the same electron stream and yet perform independently two operations (oscillator and mixer for superheterodyne circuits) simultaneously.

Radio Tube Characteristics

The term "CHARACTERISTICS" is used to identify the distinguishing electrical features and values of a radio tube. These values may be shown in curve form or they may be tabulated. When given in curve form, they are called characteristic curves and may be used for the determination of tube performance and the calculation of additional tube factors.

Tube characteristics are obtained from electrical measurements of a tube in various circuits under certain definite conditions of voltages. Characteristics may be further described by denoting the conditions of measurements. For example, **Static Characteristics** are the values obtained with different d-c potentials applied to the tube electrodes, while **Dynamic Characteristics** are the values obtained with an a-c voltage on the control grid under various conditions of d-c potentials on the electrodes. The dynamic characteristics, therefore, are indicative of the performance capabilities of a tube under actual working conditions.

Plate characteristic curves and transfer (mutual) characteristic curves both give information on static characteristics. These curves present the same information, but in two different forms to increase its usefulness. The plate characteristic curve is obtained by varying plate voltage and measuring plate current for different control-grid bias voltages, while the transfer characteristic curve is obtained by varying control-grid bias voltage and measuring plate current for different plate voltages. A plate characteristic family of curves is illustrated by Fig. 1. Fig. 2 gives the transfer characteristic family of curves for the same tube.

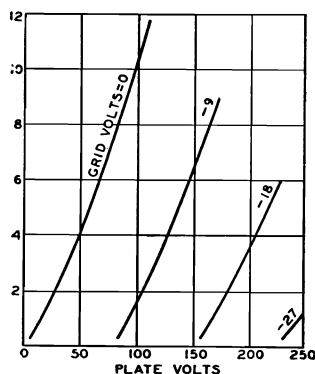

Fig. 1

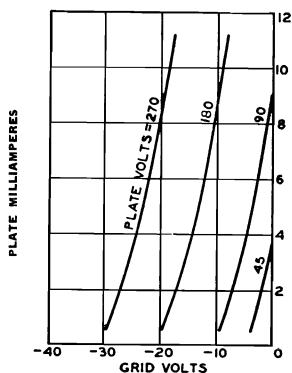

Fig. 2

Dynamic characteristics include amplification factor, plate resistance, mutual conductance, and certain detector characteristics, and may be shown in curve form for variations in tube operating conditions.

The **amplification factor**, or μ , is the ratio of the change in plate voltage to a change in control-electrode voltage in the opposite direction, under the condition that the plate current remains unchanged. For example, if the plate voltage is changed 30 volts and the grid voltage is changed 5 volts (in opposite polarity) in order to hold the plate current at a constant value, the amplification factor is 30 divided by 5, i. e., 6. In other words, a small voltage variation in the grid circuit of a tube has the same effect on the plate current as a large plate voltage change—the latter equal to the product of the grid voltage change and amplification factor. The μ of a tube is useful for calculating stage gain, as discussed on page 10.

The **plate resistance** (r_p) of a radio tube is the resistance of the path between cathode and plate to the flow of alternating current. It is the ratio of a small change in plate voltage to the corresponding change in plate current and is expressed in ohms, the unit of resistance. Thus, if a change of 0.001 ampere is produced by a plate voltage variation of 20 volts, the plate resistance is 20 divided by 0.001, i. e., 20000 ohms.

The **mutual conductance** (g_m), or grid-plate transconductance (s_m), is a factor which combines in one term the amplification factor and the plate resistance, and is the ratio of the first to the second. Mutual conductance may be more strictly defined as the ratio of a small change in plate current (amperes) to the small change in the control-grid voltage producing it, under the condition that all other voltages remain unchanged. Thus, if a grid-voltage change of 10 volts causes a plate-current change of 0.01 ampere (10 ma.) with all other voltages constant, the mutual conductance is 0.01 divided by 10, i. e., 0.001 mho. A "mho" is the unit of conductance and was named by spelling ohm backwards. For convenience, a millionth of a mho, or a micromho, is used to express mutual conductance. So, in the example, 0.001 mho times a million equals 1000 micromhos.

The mutual conductance characteristic of a tube is very useful when comparing its performance capabilities with those of the same type in similar applications. However, the usefulness of this characteristic is limited when comparing different types for any service. For example, the 112-A has a mutual conductance of 1800 micromhos at 180 volts on the plate and -13.5 volts on the grid, while the 71-A has a mutual conductance of 1700 micromhos at 180 volts on the plate and -40.5 volts on the grid. As a power amplifier, however, the 71-A is capable of furnishing three times as much undistorted power to a loud-speaker as the 112-A. On the other hand the 112-A is an excellent detector and voltage amplifier, services for which the 71-A is unsuitable.

Conversion transconductance (s_c) is a characteristic associated with the mixer (first detector) function of tubes and may be defined as the ratio of the intermediate-frequency (i-f) current in the primary of the i-f transformer to the applied radio-frequency (r-f) voltage producing it; or more precisely, it is the limiting value of this ratio as the r-f voltage and i-f current approach zero. When determining the performance of a frequency converter, conversion transconductance is used in the same way as mutual conductance is used in single-frequency amplifier computations.

The **maximum peak inverse voltage** characteristic of a rectifier tube is the highest peak voltage that a rectifier tube can safely stand in the direction opposite to that in which it is designed to pass current. In other words, it is the safe arc-back limit with the tube operating within the specified temperature range. Referring to Fig. 3, when plate A of a full-wave rectifier tube is positive, current flows from A to C, but not from B to C because B is negative. At the instant plate A is positive, the filament is positive (at high voltage) with respect to plate B. The voltage between the positive filament and the negative plate B is in inverse relation to that causing current flow. The peak value of this voltage is limited by the resistance and nature of the path between plate B and filament. The safe value of this voltage is that at which break-down does not occur and is known as maximum peak inverse voltage. In single-phase circuits of the full-wave type, the maximum peak inverse voltage is the transformer peak voltage less the voltage drop through the conducting half of the tube. With a sine-wave voltage across the electrodes of the non-conducting half, the peak inverse voltage is approximately 1.4 times the RMS voltage applied from plate to plate of the tube. In polyphase circuits, the peak inverse voltage must be determined vectorially.

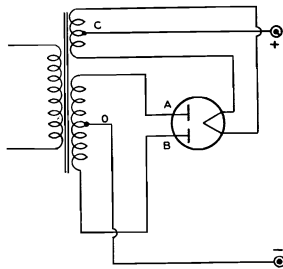

Fig. 3

The **maximum peak plate current** is the highest peak current that a rectifier tube can safely stand in the direction in which it is designed to pass current. The safe value of this peak current in hot-cathode types of rectifiers is determined by the available electron emission from the cathode and the geometrical spacing of the electrodes. In a given circuit, the actual value of peak plate current is largely determined by filter constants. If a large choke is used in the filter circuit next to the rectifier tube, the peak plate current is not much greater than the load current, but if a large condenser is used in the filter next to the rectifier tube, the peak current is often more than four times the load current.

Radio Tube Applications

The diversified applications of a radio tube may, within the scope of this chapter, be grouped broadly into five kinds of operation. These are: Amplification, rectification, detection, oscillation, and frequency conversion. Although these operations may take place at either radio- or audio-frequencies and may involve the use of different circuits and different supplemental parts, the general considerations of each kind of operation are basic.

AMPLIFICATION

The amplifying action of a radio tube was mentioned under TRIODES, page 4. A small change in the control-grid voltage for grid voltages less than the cut-off value produces a much larger plate-current change than would be produced by the same change in plate voltage. This action can be utilized in radio circuits in a number of ways, depending upon the results to be achieved. Three distinct classes of amplifier service, recognized by engineers, are covered by definitions standardized by the Institute of Radio Engineers. This classification depends primarily on the fraction of input cycle during which plate current is expected to flow under rated full-load conditions. The classes are Class A, Class B, and Class C.

A *Class A amplifier* is an amplifier in which the bias and exciting grid voltages are such that the plate current through the tube flows at all times. The ideal Class A amplifier is one in which the alternating component of the plate current is an exact reproduction of the form of the input signal, and the plate current flows during the 360 electrical degrees of the cycle. The characteristics of a Class A amplifier are low efficiency and output.

A *Class B amplifier* is an amplifier in which the grid bias is approximately equal to that required to cut off the plate current to approximately zero when no exciting grid voltage is applied, so that the plate current in a tube flows during approximately one-half of each cycle when an exciting grid voltage is applied. The ideal Class B amplifier is one in which the alternating component of plate current is an exact replica of the input signal for the half-cycle when the grid is positive with respect to the bias voltage and the plate current flows 180 electrical degrees. The characteristics of a Class B amplifier are medium efficiency and output.

A *Class C amplifier* is an amplifier in which the grid bias is appreciably more than necessary to cut off the plate current to zero when no exciting grid voltage is present, so that the plate current flows in a tube for appreciably less than one-half of each cycle when an exciting grid voltage is present. At the present time Class C amplifier application is confined to radio transmission where high plate circuit efficiency is a paramount requirement and where departures from linearity between input and output are permissible. The characteristics of a Class C amplifier are high plate circuit efficiency and high power output.

It is sometimes convenient to have terms to identify amplifier services when tubes are operated under conditions intermediate to those of Class A and Class B, or to those of Class B and Class C. The proposal has been made that such conditions be classified as Class AB and Class BC, respectively. It is sometimes also of interest to know whether grid current is expected to flow under rated full-load conditions. The proposals follow:

(1) A *Class AB amplifier* is one in which the bias and exciting grid voltages are such that the plate current flows during appreciably more than 180 electrical degrees yet less than 360 electrical degrees of the cycle. This has also been called Class "A prime." The characteristics of a Class AB amplifier are efficiency and output intermediate between a Class A and a Class B amplifier. The idle plate current and attendant dissipation may be made substantially less than is possible with Class A amplifiers.

(2) A *Class BC amplifier* is an amplifier in which the bias and exciting grid voltages are such that the plate current flows during less than 180 electrical degrees and yet for a considerable part of the cycle. The characteristics of a Class BC amplifier are efficiency and output intermediate between a Class B and a Class C amplifier. Class BC amplifiers are not in general use.

(3) To denote that grid current does not flow during any part of the input cycle, add the suffix 1 to the letter or letters of the class identification. The suffix 2 is used to denote that grid current flows during some part of the cycle.

For radio-frequency amplifiers which operate into a selective tuned circuit, as in radio transmitter applications, or under requirements where distortion is not an important factor, any of the above classes of amplifiers may be used, either with a

single tube or a push-pull stage. For audio-frequency amplifiers in which distortion is an important factor, only Class A amplifiers permit single-tube operation. In this case, operating conditions are chosen so that distortion is kept below the conventional 5% for triodes and the conventional 7-10% for tetrodes or pentodes. With Class A amplifiers, reduced distortion with improved power performance can be obtained by using a push-pull stage for audio service. With Class B amplifiers, a push-pull stage is required for audio service.

As a **Class A voltage amplifier**, a radio tube is used to reproduce grid voltage variations across an impedance or a resistance in the plate circuit. These variations are essentially of the same form as the input signal voltage impressed on the grid, but of increased amplitude. This is accomplished by operating the tube at a suitable grid bias so that the applied grid-input voltage produces plate-current variations proportional to the signal swings. Since the voltage variation obtained in the plate circuit is much larger than that required to swing the grid, amplification of the signal is obtained. Fig. 4 gives a graphical illustration of this method of amplification and shows, by means of the grid-voltage vs. plate-current characteristics, the effect of an input signal (S) applied to the grid of a tube. (O) is the resulting amplified plate-current variation.

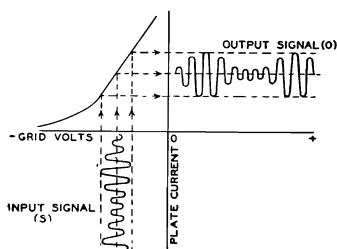

Fig. 4

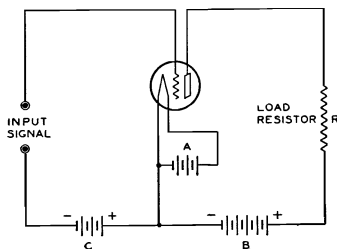

Fig. 5

The plate current flowing through the plate-load resistor (R) of Fig. 5 causes a voltage drop which varies directly with the plate current. The ratio of this voltage variation produced in the load resistor to the grid-input voltage is a measure of the voltage amplification, or **gain**, of the tube stage. This ratio is not the same as the amplification factor of the tube, but is determined by the combined effects of plate resistance, load resistance or impedance, and the amplification factor. The value depends on a number of factors. The load resistance required is the effective value. For example, in a resistance-coupled amplifier using a high resistance in the plate circuit, the effective value is also dependent on the resistance of the associated grid circuit of the next stage. The voltage amplification per stage due to the tube is expressed by the following convenient formulae:

$$\text{Voltage Amplification} = \frac{\text{Amplification factor} \times \text{Plate load resistance}}{\text{Plate load resistance} + \text{Plate resistance}} =$$

$$\frac{\text{Mutual conductance in micromhos} \times \text{Plate resistance} \times \text{Plate load resistance}}{1000000 \times (\text{Plate resistance} + \text{Plate load resistance})}$$

In the first formula, load resistance and plate resistance values should be expressed in the same units, either ohms or megohms. In the second formula, they must be expressed in ohms.

These formulae apply equally well to all types of amplifier tubes. If the load resistance is made increasingly larger, the voltage amplification per stage approaches the amplification factor of the tube as a limiting value. Fig. 6 shows that voltage amplification, or gain, increases with larger loads. Since increasing the size of the load resistor lowers the available plate voltage due to the drop through the resistor, the plate-voltage swing obtainable is likewise reduced. This drop may be avoided by

replacing the resistor with an inductance. An inductance can be designed to have a high impedance to the signal and also to have a low resistance to direct current. The inductance, depending upon circuit requirements, may be an air-core coil, an iron-core choke, or a transformer primary.

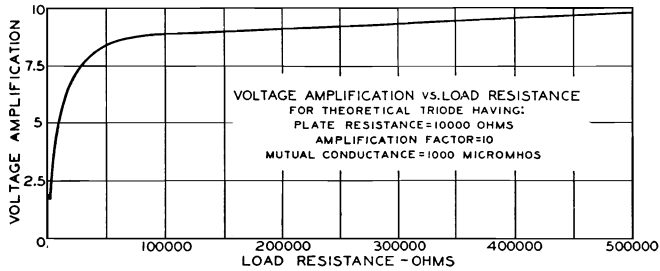

Fig. 6

The method of applying the input signal to the grid is important. If the grid of the tube in operation does not go positive, it is possible to use an input circuit of high impedance, since the grid-input impedance of radio tubes is very high as long as the grid bias is negative. If an input transformer is used, the secondary impedance is made as high as other design conditions permit. In resistance-coupled circuits, the grid resistors usually range in value from $\frac{1}{2}$ to 2 megohms, depending upon the type of tube and the circuit. Too high a resistance may result in instability, while too low a value of grid resistance may result in low gain. The most suitable value will usually be determined by experiment.

A *super-control amplifier* tube is a modified construction of a screen grid type and is designed to reduce modulation-distortion and cross-modulation in radio-frequency stages. **Cross-modulation** is the effect produced in a radio receiver by an interfering station "riding through" on the carrier of the station to which the receiver is tuned. **Modulation-distortion** is a distortion of the modulated carrier and appears as audio-frequency distortion in the output. This effect is produced by a radio-frequency amplifier stage operating on an excessively curved characteristic when the grid bias has been increased to reduce volume. The offending stage for cross-modulation is usually the first radio-frequency amplifier, while for modulation-distortion, the cause is usually

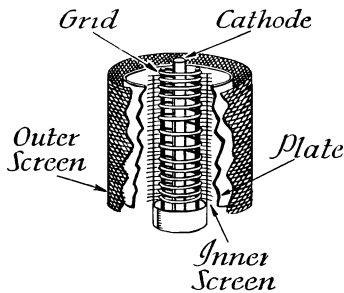

Fig. 7

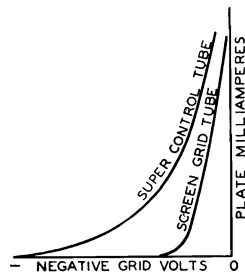

Fig. 8

the last intermediate-frequency stage. The characteristics of super-control types are such as to enable the tube to handle both large and small input signals with minimum distortion over a wide range. This feature is obtained by a special tube structure which makes possible variation in amplification factor with a change in grid bias. A cross-section of the structure of a typical super-control tube is shown in Fig. 7. This

type differs from other screen grid tubes chiefly in the construction of the control grid which is wound with coarse spacing at the middle and close spacing at the ends. When weak signals and low grid bias are applied to the tube, the effect of the non-uniform turn spacing of the grid on cathode emission and tube characteristics is essentially the same as for uniform spacing. As the grid bias is made more negative to handle larger input signals, the electron flow from the sections of the cathode enclosed by the ends of the grid is cut off. The plate current and other tube characteristics are then dependent on the electron flow through the coarse section of the grid. This action changes the gain of the tube so that large signals may be handled with minimum distortion due to cross-modulation and modulation effects. Fig. 8 shows typical grid-voltage vs. plate-current curves for a screen-grid and a super-control tube, respectively. It will be noted that while the curves are alike at small grid-bias voltages, the plate current of the super-control tube drops quite slowly with large values of bias voltage. This slow change makes it possible for the tube to handle large signals satisfactorily. Since super-control types can accommodate large and small signals, they are particularly suitable for use in sets having automatic volume control.

As a **Class A power amplifier**, a radio tube is used in the output stage of radio receivers to supply relatively large amounts of power to the loud speaker. For this application, large power output is of much greater importance than high-voltage amplification, so that gain possibilities are sacrificed in the design of power tubes to obtain power-handling capability. Power tubes of the triode type in Class A service are characterized by low power-sensitivity, low plate-power-efficiency, and low distortion. Power tubes of the pentode type are characterized by high power-sensitivity, high plate-power-efficiency, and relatively high distortion.

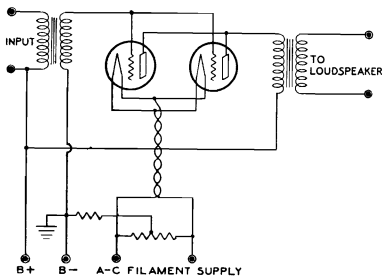

Fig. 9

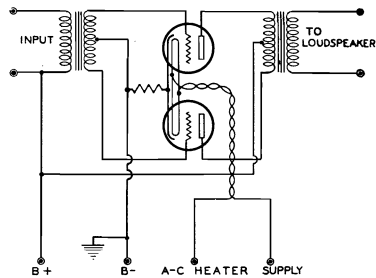

Fig. 10

A Class A power amplifier is also used as a driver to supply power to a Class B output stage. Either triodes or pentodes as driver tubes may be used, but triodes are usually preferable since they produce less distortion.

Either *push-pull* or *parallel operation* of power tubes may be employed with Class A amplifiers to obtain increased output. The parallel connection (Fig. 9) provides twice the output of a single tube with the same value of grid-signal voltage. The push-pull connection (Fig. 10) requires twice the input-signal voltage, but has, in addition to increase in power, a number of important advantages over single-tube operation. Distortion due to even-order harmonics and hum due to plate-supply-voltage fluctuations are either eliminated or decidedly reduced through cancellation. Since distortion is less than for single-tube operation, appreciably more than twice single-tube output can be obtained by decreasing the load resistance. For the same reason, economy of operation can be obtained by increasing the grid bias beyond the single-tube value and proportionately increasing the input signal.

Operation of power tubes so that the grids run positive is inadvisable except under conditions such as are discussed later in this section for Class B amplifiers.

Power amplifier output for triodes as Class A amplifiers can be calculated without serious error from the plate family of curves by assuming a resistance load. The proper plate current, grid bias, and optimum load resistance, as well as the per cent

second harmonic distortion, can also be determined. The calculations are made graphically and are illustrated by Fig. 11 for given conditions. The procedure is as follows: A straight line XY is drawn through the point P on the plate family of curves. This point is determined by the tentatively chosen values of plate voltage and plate current. The slope of the line XY corresponds to the value of load resistance tentatively chosen. The slope of XY is determined by adjusting a line through P so that the voltage value (at the intersection of the line with the zero-current axis) divided by the current value (at the intersection of the line with the zero-voltage axis) gives the desired trial load resistance. A more direct method is to draw any convenient line AB having the proper slope, and then to draw XY parallel to it and through P. To draw AB, choose any convenient voltage value on the zero-current axis. A line drawn through this point and given the proper slope must intersect the zero-voltage axis at a current value equal to the chosen voltage divided by the chosen resistance value.

In calculating power output, it is assumed that the peak alternating grid voltage is sufficient to swing the grid from the operating-bias value to zero bias on the positive swing and to a value twice the fixed bias on the negative swing. Identifying the maximum and minimum values of plate voltage and plate current for the grid-voltage swing as E max., E min., I max., I min., the power output is given by the formula:

$$\text{Power Output} = \frac{(I \text{ max.} - I \text{ min.}) \times (E \text{ max.} - E \text{ min.})}{8}$$

If E is in volts and I in milliamperes, power output is in milliwatts.

Per cent second harmonic distortion is given by the following formula in which I₀ is the trial value of d-c plate current.

$$\text{Per cent 2nd Harmonic Distortion} = \frac{I \text{ max.} + I \text{ min.}}{2} - I_0 \div (I \text{ max.} - I \text{ min.}) \times 100$$

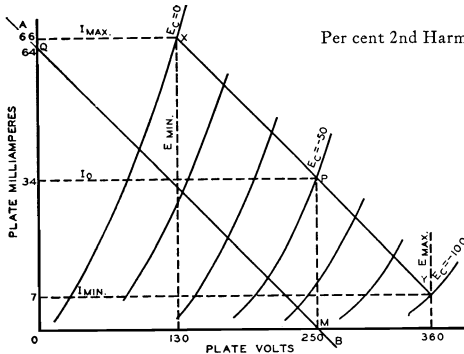

Fig. 11

Example: Determine the undistorted power output of a 3-electrode tube at a plate voltage of 250 volts, a plate current of 34 milliamperes, a negative grid voltage of 50 volts and a plate load of 3900 ohms; given the plate characteristic curves as shown.

Procedure: Draw through point (P) which represents proposed operating conditions, line XY with slope corresponding to 3900 ohm load. This may be done by drawing XY parallel to line AB. The line AB is drawn between point (M) at 250 volts and zero current, and point (Q) at zero volts and current equal to 250 volts divided by plate load of 3900 ohms, i.e., $250 \div 3900 = 0.064$ ampere or 64 milliamperes.

Substituting values from curves in above power formula:

$$\text{Power Output} = \frac{(66-7) \times (360-130)}{8} = 1700 \text{ milliwatts}$$

Substituting values from curves in above distortion formula:

$$\text{2nd Harmonic Distortion} = \frac{\frac{0.066 + 0.007}{2} - 0.034}{0.066 - 0.007} \times 100 = 4.2\%$$

It is customary to make the final selection of load resistance such that the distortion as calculated above does not exceed 5 per cent, a value which experience has shown to be permissible. Several approximations of load resistance may be necessary to obtain the optimum value for the trial value of plate current. Ordinarily, the plate load resistance for optimum conditions is approximately equal to twice the plate resistance.

To check the trial plate current, calculations should be made for d-c plate currents above and below the trial value. The most suitable value with its corresponding grid bias can then be selected, unless the value is higher than that recommended for the tube. In this event the maximum permissible value is chosen.

Class B power amplifiers for audio applications are of much interest where large power output is required. In Class B service the tube is operated so that the plate current is relatively low with no grid excitation. When a signal of sufficient magnitude is applied to the grid, there will be no plate-current flow over a substantial part of the negative half-cycle. In other words, plate current flows only during the least negative excursions of the signal voltage. A considerable amount of second and higher even-order-harmonic distortion is thus introduced into the power output of a single tube. However, with two tubes in a balanced push-pull circuit, the even harmonics are eliminated from the power output. In such a circuit, therefore, two tubes may be employed as Class B amplifiers to supply virtually undistorted output. Certain types such as the 19, 53, and 79 combine in one bulb two Class B amplifier triodes, so that only one tube is required for the last audio stage.

In Class B service it is possible to drive the grids of the two amplifier tubes positive by a certain amount and still obtain reasonably undistorted output, provided sufficient input power is available to supply the grid current required by the grids when positive. This power is conveniently supplied by a Class A power amplifier feeding the grids of the output tubes through a push-pull transformer having the proper characteristics. Usually this transformer has a step-down ratio.

By designing Class B amplifier tubes with a sufficiently high amplification factor, it is possible to operate them with zero grid bias, and so dispense with biasing resistors whose effect would be to produce considerable loss in sensitivity because of degeneration. Since provision for grid bias is unnecessary with such tubes, the entire voltage of the rectifier is available for plate supply.

Distinguishing features of this class of service are that very high output of good quality may be obtained with fairly small tubes operating at relatively low plate voltage; and that unusual overall economy of power consumption is possible because the plate current is low when no signal is applied to the grid. To give these advantages, the Class B amplifier circuit requires the use of two tubes in a balanced output stage preceded by a driver stage capable of delivering considerable undistorted power, and the use of a power supply capable of maintaining good voltage regulation regardless of the variation of average plate current with signal intensity. It should be noted that the distortion present in the power output of Class B amplifiers is usually somewhat higher for the ordinary range of signals than that obtained with Class A audio amplifiers employing much larger tubes capable of the same maximum power output.

The d-c plate current required in Class B circuits fluctuates under normal operating conditions. The power supply, therefore, should have good regulation to maintain proper operating voltages regardless of the current drain. For this purpose, a suitably designed power-unit should be employed. The rectifier tube should have reasonably good regulation over the operating range. In some circuit designs, a vacuum type of rectifier tube can be used, while in others a mercury-vapor type may be needed to provide the required regulation. As a factor in obtaining good regulation, the filter chokes and the transformer windings should have low resistance. In the design of a power supply for a Class B amplifier, consideration should be given to economical distribution of losses. Also, the power supply should be designed to take care of the average power requirements with sufficient regulation to meet the peak-power demands.

The grid (or grids) of a Class B amplifier tube is operated sufficiently positive to cause grid current to flow in its input circuit. This feature imposes a further requirement on the preceding amplifier stage which must supply not only the necessary input voltage to the output stage, but it must be capable of doing so under conditions where

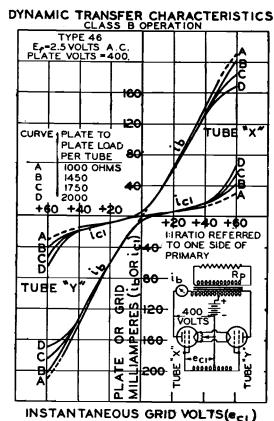

appreciable power is taken by the grid of the Class B amplifier tube. Since the power necessary to swing the grid positive is partially dependent on the plate load of the Class B tube, and since the efficiency of power transfer from the preceding stage is dependent on transformer design, it is apparent that the design of a Class B audio power amplifier requires that more than ordinary attention be given to the effects produced by the component parts of the circuit. For this reason, the design of a Class B audio amplifier with its driver stage is somewhat more involved than for a Class A system.

In the design of Class B amplifiers, the interstage transformer is the link interconnecting the driver and the Class B stage. It is usually of the step-down type, that is, the primary input voltage is higher than the secondary voltage supplied to the grids of the power output tubes. Depending upon conditions, the ratio of the primary of the interstage transformer to one-half of its secondary may range between 1.5 to 1 and 5.5 to 1. The transformer step-down ratio is dependent on the following factors: (1) Type of driver tube, (2) Type of power tube, (3) Load on power tube, (4) Permissible distortion, and (5) Transformer efficiency (peak power).

The primary impedance of the interstage transformer is essentially the same as if the transformer were to be operated with no load, that is, into an open grid. Since power is transferred, the transformer should have reasonable power efficiency. It should be noted that the power output and distortion are often critically dependent upon the circuit constants, which should therefore be made as nearly independent of frequency as possible. This applies particularly to the interstage coupling transformer and to the loudspeaker. Since it is difficult to compensate for leakage reactance of the coupling transformer without excessive loss of high-frequency response, the leakage reactance of this transformer should be as low as possible.

The type of driver tube chosen should be capable of handling sufficient power to operate the Class B amplifier stage. Allowance should be made for transformer efficiency. It is most important, if low distortion is desired, that the driver tube be worked into a load resistance higher than the normal value for optimum power output as a Class A power amplifier, since distortion produced by the driver stage as well as the power stage will be present in the output.

RECTIFICATION

The rectifying action of a tube is briefly described under DIODES, page 3. After an alternating voltage has been rectified by a diode and before the output can be used as a d-c high-voltage supply for a radio receiver, a filter circuit must be employed to smooth out the voltage fluctuations. The filter circuit generally consists of condensers, iron-core chokes, and the load. The chokes are in series with the load and offer a high impedance to the pulsating or ripple voltage. The condensers are in parallel with the load and act to store energy on the voltage peaks. This energy is released on the voltage dips and serves to equalize the output voltage. Filters may be of either a condenser-input or choke-input type.

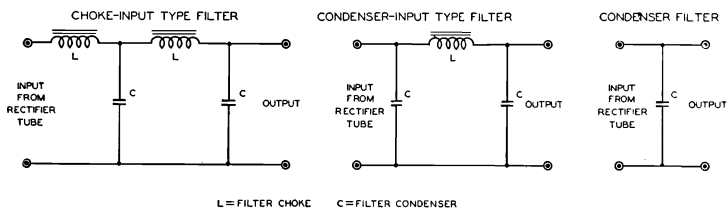

Fig. 12

If an input condenser is used, consideration must be given to the instantaneous peak value of the a-c input voltage. The peak value is about 1.4 times the RMS value as measured by an a-c voltmeter. Filter condensers, therefore, especially the input condenser, should have a rating high enough to withstand the instantaneous peak value, if breakdown is to be avoided. When the input-choke method is used, the available d-c output voltage will be somewhat lower than with the input-condenser method for a given a-c plate voltage. However, improved regulation together with lower peak current will be obtained.

A half-wave rectifier and a full-wave rectifier circuit are shown in Figs. 13 and 14, respectively. The full-wave form rectifies both halves of an alternating voltage, so that outputs of each half-cycle are supplied alternately to the filter circuit. This action occurs at twice the line frequency and thus makes filtering and regulation problems simpler to handle than for the half-wave circuit. Further rectifier operating information and circuits are given under each rectifier tube type and in the CIRCUIT SECTION.

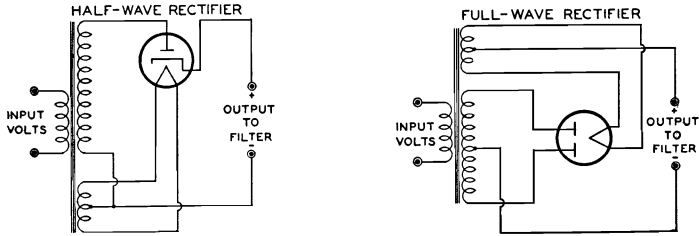

Fig. 13

TYPICAL FULL-WAVE RECTIFIER CIRCUIT

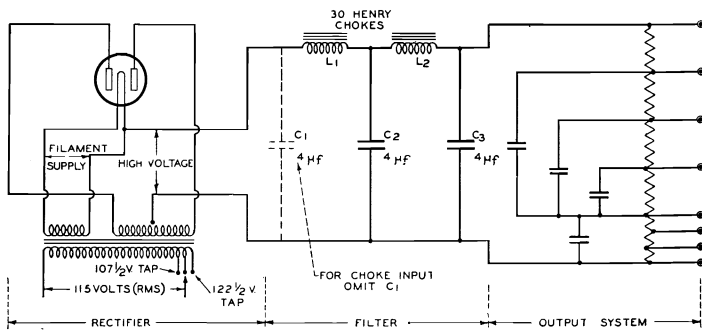

Fig. 14

A voltage-doubler rectifier circuit of simple form is shown in Fig. 15. The d-c voltage output of this circuit is approximately twice that obtainable from a half-wave rectifier operated on the same a-c voltage supply. In Fig. 15, two diodes are shown connected to two condensers. One diode is reversed electrically with respect to the other. This arrangement provides rectification of each half-cycle of the a-c supply. Furthermore, during the period that one diode is rectifying, the condenser across the other diode is discharging through the load and the conducting diode. As a result,

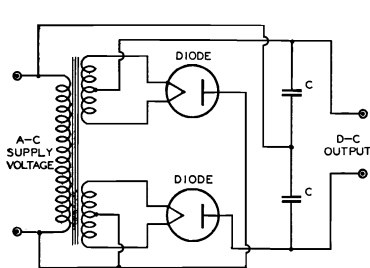
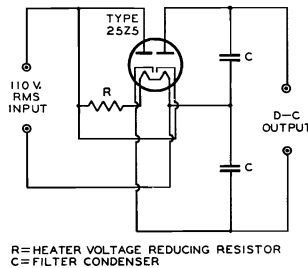

Fig. 15



R=HEATER VOLTAGE REDUCING RESISTOR
C=FILTER CONDENSER

Fig. 16

the voltage across the load is the sum of the d-c output voltage of the conducting tube and the discharge voltage of the condenser. Since the total d-c voltage across the load, therefore, is approximately twice the d-c voltage obtainable from a half-wave rectifier, this circuit is called a voltage-doubler. Like a full-wave rectifier circuit, filtering is simpler, since the doubler circuit gives an output having a ripple frequency twice that of the supply line. A tube specially designed for voltage-doubler requirements is the 25Z5. It contains in a single bulb two separate diodes of the heater-cathode type. Fig. 16 shows a circuit diagram employing this tube as a voltage doubler.

DETECTION

In radio-broadcast transmission, the radio-frequency carrier wave is modulated by the microphone pick-up at the studio. In reception, the operation of separating the audio component (speech and music) from the r-f wave is known as demodulation, or detection. The effect of modulation at the transmitter is to vary the amplitude of the carrier wave in proportion to the audio-input variations. Since the carrier wave is alternating, it may be considered to consist of two halves, a positive half and a negative half. Each of these halves is affected equally by the audio modulation. Unless a detector is used, the audio component in one-half of the carrier wave is continuously offset by the audio component in the other half of the wave at a rate equal to the carrier frequency, a frequency much too high to affect any audio system. If, however, one-half of the carrier wave can be eliminated, the audio variations in the other half of the carrier may be utilized to operate a pair of headphones or a loudspeaker (Fig. 17).

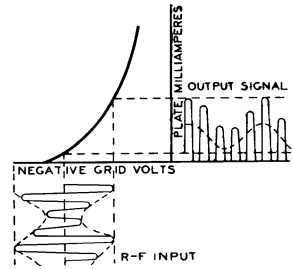

Fig. 17

The elimination (either partially or completely) of the neutralizing effect of one-half of the carrier wave is the function of the detector. It rectifies the carrier—permits a greater flow of current on the one-half than on the other half of the carrier wave—and extracts from the rectified output, the audio component or signal. The high-frequency radio component is usually by-passed from the plate circuit of the detector tube by means of a small condenser, while the audio component is fed to the audio-amplifier stage.

Three different methods of detection with radio tubes are commonly employed. These are known as the diode method, the grid-bias method, and the grid leak and condenser method.

The *diode method* makes use of the rectifying action of the diode. Although the diode does not amplify, its operating characteristics make it particularly suitable as a detector when freedom from distortion is desired. This suitability is due to the relatively low resistance of the diode in the direction of current flow and the consequent convenient size of the load resistance necessary to give the approximate linearity of the

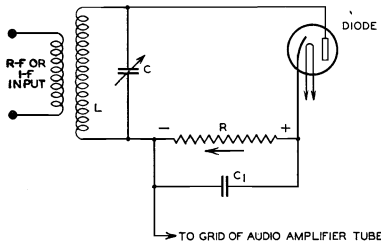

Fig. 18

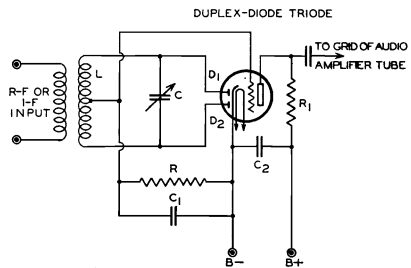

Fig. 19

dynamic characteristic required for low-distortion detecting action. Fig. 18 shows a half-wave diode detector circuit. The audio signal voltage is developed across the load resistance (R).

Two diodes may be used for full-wave rectification or their plates may be connected in parallel (with decreased tube resistance) for half-wave rectification. With full-wave rectification, the circuit may be balanced for carrier input so that no carrier frequency is supplied to the grid of the following amplifier and no carrier-frequency filtering is theoretically necessary. Half-wave rectification as compared with full-wave rectification provides approximately twice the signal output but requires carrier-frequency filtering. Figure 19 illustrates full-wave diode detection by means of a duplex-diode triode type, such as the 55. The two diodes are used as a full-wave detector feeding the triode unit as an audio amplifier. The triode is biased by the drop across R. This is known as "diode biasing" but is practical only when sufficient resistance is in the plate circuit of the triode unit to prevent excess plate current when the voltage across R drops to zero under conditions of no r-f input. If extremely strong signals are received with this circuit, the bias on the triode may be carried to cut-off. In general, the amplifier unit of duplex-diode types can be utilized just as though it were a separate tube.

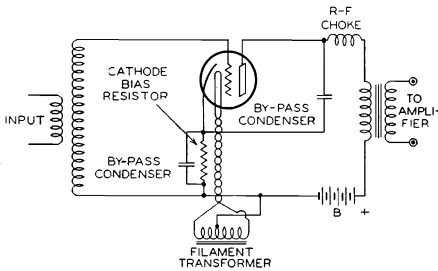

Fig. 20

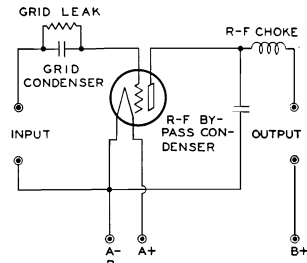

Fig. 21

The *grid-bias method* of detection makes use of a tube which is operated with a grid bias such that the plate current with no signal is practically zero. The bias may be obtained from a cathode resistor (self-bias method), a C-battery, or a bleeder circuit. When a signal is applied to the grid, rectification of the carrier occurs in the plate circuit, since only the positive half is amplified. The grid does not draw current with grid-bias detection, so the load on the input circuit is negligible. This is a desirable feature. Fig. 20 illustrates this circuit.

The *grid leak and condenser* method is somewhat more sensitive than the grid-bias method and gives its best results on weak signals. This method uses a grid leak and condenser in the grid circuit (as shown in Fig. 21). The grid leak regulates the grid bias to obtain rectification in the grid circuit while the condenser offers a low-resistance path to the grid for the radio-frequency input. The grid-leak-condenser method draws grid current and like the diode method places a load on the input circuit. Although a high value of grid resistor gives greatest selectivity and sensitivity, improved tone and stability are obtained with lower values.

AUTOMATIC VOLUME CONTROL

Automatic control of receiver volume generally utilizes a rectified voltage which is dependent on a radio-frequency or intermediate-frequency carrier signal. This voltage is utilized to regulate the gain of the r-f and/or i-f amplifier stages so as to maintain essentially constant-carrier input to the audio detector. The regulation of amplifier gain by means of the rectified voltage may be accomplished by a number of methods, differing chiefly in the means of applying the voltage to the various electrodes of the amplifier tubes. For example, the control voltage might be applied to the suppressor, plate and/or screen of an r-f pentode. A more familiar method is that in which the control voltage is applied to the grid of the r-f amplifier. In Fig. 18, current flows from plate to cathode, through R back to LC. This places the cathode end of

load resistor (R) at positive potential and the opposite end at negative potential. Negative voltage for biasing the grids of the r-f amplifiers may be obtained from the negative end of this resistor.

Assume that, for a given signal, the voltage drop across R is sufficient to bias the controlled tubes to a sensitivity consistent with desirable reception volume. A decrease in r-f signal input causes a decrease in voltage drop across R. This automatically lowers the bias on the controlled tubes so that the sensitivity of the receiver increases to maintain normal volume. Conversely, a stronger input signal increases the voltage drop across R, biases the control tubes more negatively so that the receiver sensitivity decreases to hold the receiver output at normal volume. This action is known as **automatic-volume-control, or a.v.c.**

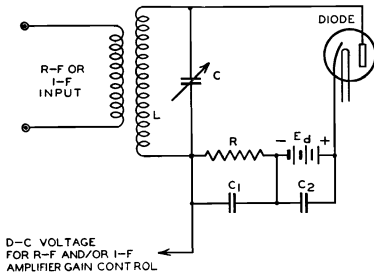

Fig. 22

The a.v.c. circuit just described starts to function as soon as any signal is received. It is sometimes desirable to delay the control action until a signal of a certain minimum amplitude is received. This is accomplished by applying a negative d-c voltage to the diode plate. In Fig. 22, a 10-volt value is shown. Under this condition, the positive swing of the peak signal must be slightly more than 10 volts before diode current flows in the circuit. Since a.v.c. action is delayed until a certain minimum signal is received, this system is known as **delayed a.v.c., or d.a.v.c.**

AUTOMATIC NOISE SUPPRESSION

Automatic suppression of receiver noise is generally accomplished by utilizing the rectifying action of a detector tube to supply control voltage to a separate control tube arranged so that the audio-frequency amplifier stages are cut out until a desired carrier signal is fully tuned in. This effect may be obtained by a change in voltage on control, screen, or suppressor grid of the audio-frequency amplifier tube. The use of the control grid is probably preferable, since the voltage required for the control operation is small and the current required for the desired voltage change is extremely small. The control tube is known as the **noise-suppression-control tube, n.s.c. tube, Q tube, or squeleh** tube. Amplification of detector output occurs when a carrier is tuned in; attenuation occurs due to "cut-off" and zero mutual conductance when the carrier input is lacking or small. Fig. 23 illustrates a simple scheme of securing automatic noise suppression when using a diode detector (V_1); a triode n.s.c. tube (V_2); and a controlled amplifier tube (V_3).

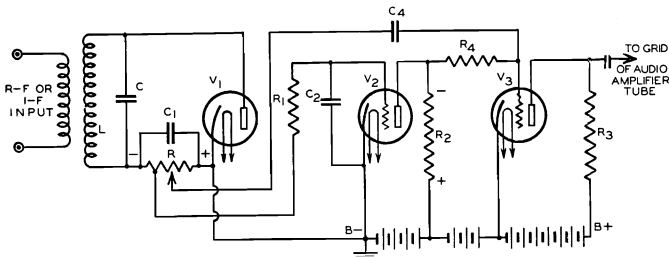

Fig. 23

When no signal is present in the input transformer, no plate current flows through V_1 . There is no bias voltage applied to the grid of V_2 , so maximum plate current flows through R_2 . The voltage developed across R_2 biases V_3 to cut-off so that it cannot amplify. The audio stages of the receiver are thus suppressed. When a signal voltage is developed across the input transformer, plate current flows through V_1 .

D-c and a-f voltages are produced across R. The d-c voltage is applied as negative bias to cut off V_2 . There is then no voltage drop across R_2 , so V_3 operates with minimum fixed bias. V_3 then functions as a regular amplifier for the a-f voltage applied through C_4 from R.

Fig. 24 shows a circuit employing the 55 and 57 arranged to take advantage of the combined features of diode detection, d.a.v.c., and n.s.c. The diodes, A and B, of the 55 are employed to secure these effects. Diode A is the d.a.v.c. unit; diode B is the detector. The triode is the n.s.c. unit. When a carrier signal is applied across the input transformer, plate current flows from diode A through R and R_1 back to A. The bleeder resistor (R) provides a negative bias of 14 volts to A in order to obtain delayed a.v.c. A.v.c. voltage is obtained across R_1 when the peak signal is slightly greater than 14 volts. At the same time, B also passes plate current which causes a drop through the diode-load resistors (R_3 and R_4) to provide negative d-c bias for the 55 triode and a-f voltage for the 57 a-f amplifier. Under signal conditions, the 55 triode is biased to cut-off. No current flows through load resistor R_5 so that the 57 operates at maximum plate current—limited of course by the minimum bias supplied by the bleeder R_7 . Under this condition, the 57 amplifies the a-f voltage from diode B and passes it on to the audio-frequency stages.

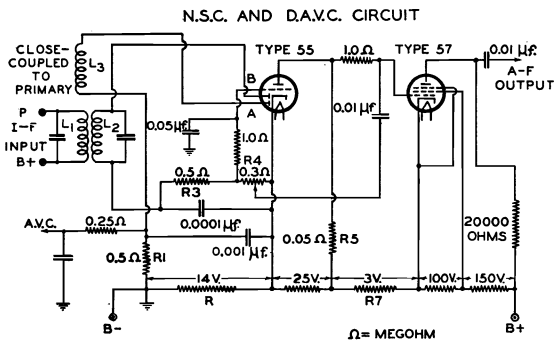

Fig. 24

When no carrier signal is present in the input transformer, no plate current flows through diodes A or B. There is no a.v.c. action since diode B is biased 14 volts negative. Under such conditions, maximum plate current flows through R_5 , causing cut-off of the 57. With the indicated voltages, plate current cut-off occurs at about -7 volts on the grid. No amplification of the audio signal occurs and the audio-frequency amplifier tubes receive no a-f voltage. Thus, the audio system is suppressed and no sound is heard from the loudspeaker.

For small degrees of detuning under conditions of signal input, the n.s.c. circuit will not function to suppress audio amplification until the a.v.c. circuit no longer acts to maintain the detector input constant. Thus, while noise suppression is obtained effectively when the receiver is considerably detuned, there is a tendency for some noise and carrier hiss to be heard when tuning is at or near the side-band limits. This makes it desirable to reduce the delay in noise suppression control to a minimum.

To obtain this, the a.v.c. tube and the n.s.c. tube must be controlled by signal voltages obtained from separate inputs, and for a small amount of detuning, the signal actuating the n.s.c. tube must be reduced more sharply than that supplying the a.v.c. tube. One convenient method is shown in Fig. 24. The overall selectivity at the secondary (L_2) of the input transformer is greater than at the secondary (L_3), so that, when detuning, the signal on diode B is reduced to a greater extent than the signal on diode A. The selectivity of the secondary (L_3) is less than that of L_2 because L_3 is more closely coupled to the primary (L_1). This arrangement can be utilized to provide the desired suppression appreciably before the a.v.c. action increases the receiver sensitivity to maximum.

OSCILLATION

As an oscillator, a radio tube can be employed to generate a continuously alternating voltage. In present-day radio broadcast receivers, this application is limited practically to superheterodyne receivers for supplying the heterodyning frequency. Several circuits (represented in Fig. 25) may be utilized, but they all depend on feeding more energy from the plate or output circuit to the grid or input circuit than is required to equal the power loss in the tube. Feed-back may be produced by electrostatic or

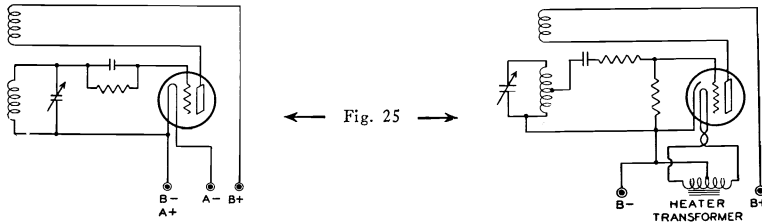

← Fig. 25 →

electromagnetic coupling between the input and output circuits. When sufficient feed-back occurs to more than equal the tube losses, the tube will oscillate. The action consists of regular surges of power between the plate and the grid circuit at a frequency dependent on the circuit constants of inductance and capacity. By properly choosing these values, the frequency may be adjusted over a very wide range.

FREQUENCY CONVERSION

In a superheterodyne receiver, the tubes and circuits used to generate the local frequency and to mix it with the incoming radio signal to produce an intermediate frequency, may be called a frequency-converter device.

The usual methods employ a mixer tube in which the radio signal and local frequency are applied to the same grid. The local frequency may be generated by a separate tube or it may be generated within the mixer tube. These methods generally depend on coupling the oscillator and mixer circuits by either capacitive or inductive means.

Another method of interest depends on the electron stream as a coupling agent instead of reactive coupling. This arrangement offers advantages in eliminating undesired intercoupling effects between signal, oscillator, and mixer circuit and in reduction of local-frequency radiation. Furthermore, not only simpler circuits can be utilized, but also freedom from the effects of variation in oscillator voltage can be obtained. A simple device depending on the electron stream as a coupling agent may be imagined in which the space current of the mixer tube is modulated by variation in cathode emission. Conceivably, the cathode current might be modulated by variation in cathode temperature produced by filament-current variation. Practically, however, this same effect can be accomplished by placing a grid and a supplementary anode-grid between the cathode and the control-grid and by using these electrodes in conjunction with the cathode to accomplish the modulation of the cathode current.

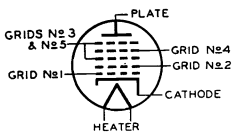
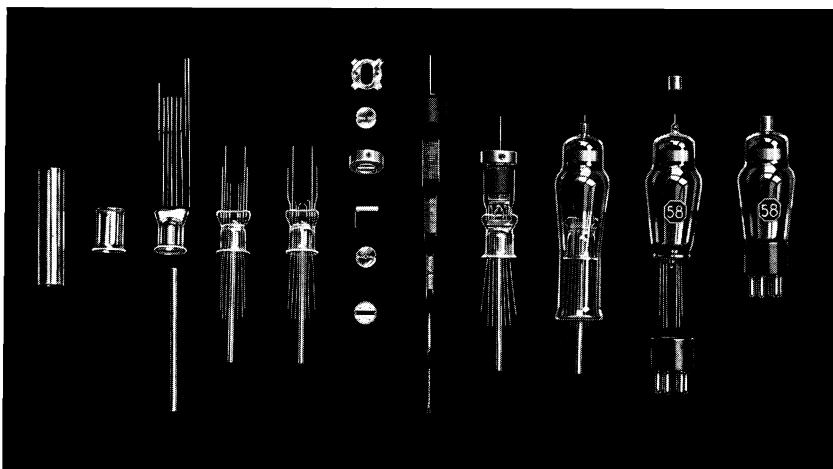

Fig. 26

With this latter arrangement, the cathode and the first two grids may be regarded theoretically as a composite cathode which supplies a modulated electron stream. This modulated cathode-stream may be further controlled and utilized by means of the addition of other grids and a plate, as for example in the pentagrid converters 2A7 and 6A7; see Fig. 26. Grid No. 1 is the control grid for the oscillator portion of the tube. Grid No. 2 is the anode for the oscillator. Grids No. 3 and No. 5, connected together within the tube, are used to accelerate the electron stream from the

cathode. In addition, grids No. 3 and No. 5 electrostatically shield the signal control grid No. 4 from the other electrodes. This shielding action increases the output impedance of the tube—a desirable characteristic from a gain standpoint.

In operation, the cathode, grid No. 1, and grid No. 2 form the oscillator portion of the tube. Electrons emitted from the cathode can be controlled in their flow to the oscillator-anode (grid No. 2) by grid No. 1. The oscillator-grid circuit, therefore, can be made to oscillate at any desired frequency so that the electron stream, in flowing through the No. 1 grid, will be modulated at this frequency. This modulated electron stream comes under the influence of grid No. 3 which is operated at a positive potential with respect to the cathode. As a result, the electron stream is accelerated toward the plate by this grid. The incoming radio-frequency signal, applied to grid No. 4, further modulates the electron stream (already modulated at the oscillator frequency), thus producing components of plate current, the frequencies of which are the various combinations of the oscillator and signal frequencies. Since the primary circuit of the first *i-f* stage is designed for resonance at the intermediate frequency (equal to the difference between the oscillator and signal frequencies), only the desired intermediate frequency will be present in the secondary of the *i-f* transformer.



Parts and Assembly of the 58

Radio Tube Installation

The installation of radio tubes requires care if high quality performance is to be obtained from the associated radio circuits. Installation suggestions and precautions which are generally common to all types of tubes are covered in this section. Careful observance of these suggestions will do much in helping the experimenter and radio technician to obtain the full performance capabilities of radio tubes and circuits. Additional and pertinent information is given under each tube type and in the **CIRCUIT SECTION**.

FILAMENT AND HEATER POWER SUPPLY

The design of radio tubes allows for some variation in the voltage and current supplied to the filament or heater, but most satisfactory results are obtained from operation at the rated values. When the voltage is low, the temperature of the cathode is below normal with the result that electron emission is limited. This may cause unsatisfactory operation and reduced tube life. On the other hand, high filament voltage causes rapid evaporation of cathode material and shortened life. To insure proper tube operation, the filament or heater voltage should be checked at the socket terminals by means of an accurate voltmeter while the receiver is in operation. In the case of series operation of heaters, correct adjustment can be checked by means of an ammeter in the heater circuit.

The filament or heater voltage supply may be a direct-current source (a battery or a d-c power line) or an alternating-current power line, depending on the type of service and type of tube. Frequently, a resistor (either variable or fixed) is used with a d-c supply to permit compensation for battery voltage variations or to adjust the tube voltage at the socket terminals to the correct value. Ordinarily, a step-down transformer is used with an a-c supply to provide the proper filament or heater voltage. Receivers, however, intended for operation on both d-c and a-c power lines have the heaters connected in series with a suitable resistor and supplied directly from the power line.

D-c filament or heater operation should be considered on the basis of the source of power. In the case of dry-battery supply, a variable resistor in series with the filament and the battery is required to compensate for battery variations. It is also recommended that an accurate voltmeter or milliammeter be permanently installed in the receiver to insure operation of the tubes at their rated filament voltage. Turning the set on and off by means of the rheostat is advised to prevent over-voltage conditions after an off-period. The voltage of dry-cells recuperates during off-periods. In the case of storage-battery supply, air-cell-battery supply, or d-c power supply, a non-adjustable resistor of suitable value may be used. It is well, however, to check operating conditions and, thus, the resistor value initially by means of a voltmeter or ammeter. A resistor is not required in some types of service, such as in the operation of the 2-volt series of tubes on a single storage-cell, and the 6.3-volt series of tubes from a 6-volt storage battery.

The *filament or heater resistor* required when heaters and/or filaments are operated in parallel can be determined easily by a simple formula derived from Ohm's law

$$\text{Required Resistance (ohms)} = \frac{\text{Supply volts} - \text{Rated volts of tube type}}{\text{Total rated filament current}}$$

Thus, if a receiver using three 32's, two 30's, and two 31's is to be operated from dry batteries, the series resistor is equal to 3 volts (the voltage from two dry cells in series) minus 2 volts (voltage rating for these tubes) divided by 0.56 ampere (the sum of 5×0.060 ampere $+ 2 \times 0.130$ ampere), i.e., approximately 1.8 ohms. Since this resistor should be variable to allow adjustment for battery depreciation, it is advisable to obtain the next larger commercial size, although any value between 2 and 3 ohms will be quite satisfactory. Where much power is dissipated in the resistor, the wattage rating should be sufficiently large to prevent overheating. The power dissipation in watts is equal to the voltage drop in the resistor multiplied by the total filament current in amperes. Thus, for the example above, $1 \times 0.56 = 0.56$ watts. In this case, the value is so small that any commercial rheostat having suitable resistance will be adequate.

For the case where the heaters and/or filaments of several tubes are operated in series, the resistor value is calculated by the following formula, also derived from Ohm's law.

$$\text{Required Resistance (ohms)} = \frac{\text{Supply volts} - \text{Total rated volts of tubes}}{\text{Rated amperes of tubes}}$$

Thus, if a receiver having one 78, one 77, one 43, and one 25Z5 is to be operated from a 120-volt power line, the series resistor is equal to 120 volts (the supply voltage) minus 62.6 volts (the sum of 2×6.3 volts + 2×25 volts) divided by 0.3 ampere (current rating of these tubes), i.e., approximately 191 ohms. The wattage dissipation in the resistor will be 120 volts minus 62.6 volts times 0.3 ampere, or approximately 17.2 watts. A resistor having a wattage rating in excess of this value should be chosen. It will be noted in the example for series operation that all tubes have the same current rating. If it is desired to connect in series tubes having different current ratings, tubes of the lower ratings should have shunt resistors placed across their heater terminals to pass the excess current. The required series resistor is then calculated on the basis of the tubes having the highest current rating.

A-c filament or heater operation should be considered on the basis of either a parallel or a series arrangement of filaments and/or heaters. In the case of the parallel arrangement, a step-down transformer is employed. Precautions should be taken to see that the line voltage is the same as that for which the primary of the transformer is designed. The line voltage may be determined by measurement with an a-c voltmeter (0-150 volts).

If the line voltage measures in excess of that for which the transformer is designed, a resistor should be placed in series with the primary to reduce the line voltage to the rated value of the transformer primary. Unless this is done, the excess input voltage will cause proportionally excessive voltage to be applied to the tubes. Any radio tube may be damaged or made inoperative by excessive operating voltages.

If the line voltage is consistently below that for which the primary of the transformer is designed, it may be necessary to install a booster transformer between the a-c outlet and the transformer primary. Before such a transformer is installed, the a-c line fluctuations should be very carefully noted. Many radio sets are equipped with a line voltage switch which permits adjustment of the power transformer primary to the line voltage. When this switch is properly adjusted, the series-resistor or booster-transformer method of controlling line voltage is seldom required.

In the case of the series arrangement of filaments and/or heaters, a voltage-dropping resistance in series with the heaters and the supply line is usually required. This resistance should be of such value that, for normal line voltage, tubes will operate at their rated heater or filament current. The method for calculating the resistor value is given above.

HEATER-TO-CATHODE CONNECTION

The cathodes of heater-type tubes when operated from a.c. should be connected either to the mid-tap on the heater-supply winding or to the mid-tap of a 50-ohm (approximate) resistor shunted across the winding. This practice follows the recommendation that no bias be applied between heater and cathode, and that the potential difference between them be kept as low as possible in order to prevent hum in the circuit. If the use of a large resistor is necessary between heater and cathode in some circuit designs, it should be by-passed by a suitable filter network or objectionable hum may develop. In the case of the 6.3-volt heater-cathode types when operated from a storage battery, the cathode circuit is tied in either directly or through biasing resistors to the negative battery terminal. When a series-heater arrangement is used, the cathode circuits should be tied in either directly or through biasing resistors to the negative side of the d-c plate supply, which is furnished either by the d-c power line or by the a-c power line by means of a rectifier.

PLATE VOLTAGE SUPPLY

The plate voltage for radio tubes is obtained from batteries, devices for rectifying a.c., direct-current power lines, and small local generators. Auto radios have caused the commercial development of a number of devices for obtaining a high-voltage d-c supply either from the car storage-battery or from a generator driven by the car engine.

The maximum plate voltage value for any tube type should not be exceeded if most satisfactory performance is to be obtained. Plate voltage should not be applied to a tube unless the corresponding recommended grid voltage is also supplied to the grid.

GRID VOLTAGE SUPPLY

The recommended grid voltages for different operating conditions have been carefully determined to give the most satisfactory performance. Grid voltage may be obtained from a separate C-battery, a tap on the voltage divider of the high-voltage d-c supply, or from the voltage drop across a resistor in the cathode circuit. This last is called the "self-bias" method, since the cathode current of the tube is utilized to produce the bias voltage. In any case, the object of the connection is to make the grid negative with respect to the cathode by the specified voltage. With C-battery supply, the negative battery terminal is connected to the grid return. The positive battery terminal is connected to the negative filament socket terminal, or to the cathode terminal if the tube is of the heater-cathode type. If the filament is supplied with alternating current, this connection is usually made to the center-tap of a low resistance (20-50 ohms) shunted across the filament terminals. This method reduces hum disturbances caused by the a-c supply. If bias voltages are obtained from the voltage divider of a high-voltage d-c supply, the grid return is tied into a more negative tap than the cathode.

The *self-biasing* method is accomplished by utilizing the voltage drop produced by the cathode current flowing through a resistor (Fig. 27) connected between the cathode and the negative terminal of the B-supply. The cathode current is, of course, equal to the plate current in the case of a triode, or to the sum of the plate and screen current in the case of a tetrode—or of a pentode. Since the voltage drop along the resistance is increasingly negative with respect to the cathode, the required negative grid-bias voltage can be obtained by connecting the grid return to the negative end of the resistance.

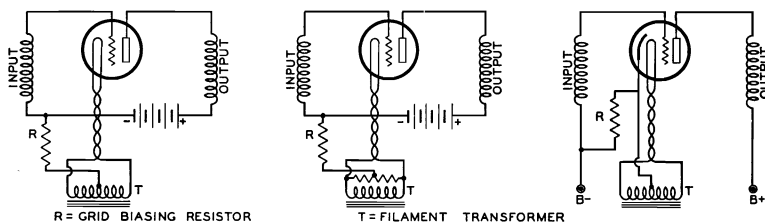

Fig. 27

The size of the resistance for self-biasing a single triode can be determined from the following formula:

$$\text{Resistance (ohms)} = \frac{\text{Desired grid bias voltage} \times 1000}{\text{Rated plate current in milliamperes}}$$

Thus, the resistance required to produce 9 volts bias for a triode which operates at 3 milliamperes plate current is $9 \times 1000 / 3 = 3000$ ohms. If the cathode current of more than one tube passes through the resistor, the size of the resistor will be determined by the total current. As indicated above for screen grid tubes or pentodes, the cathode current is the sum of the screen and the plate current.

Grid voltage variation for the r-f amplifier stages is a convenient and frequently used method for controlling receiver volume. The variable voltage supplied to the grid is obtained from a bleeder circuit by means of a potentiometer; by the self-bias method using a variable resistor; or, with automatic volume control (a.v.c.), from a bleeder circuit by means of changes in bleeder current caused by the a.v.c. tube. In any case, it is important that the control be arranged so that less than the minimum recommended grid-bias voltage cannot be applied to the grid. This requirement may be met by a stop on the potentiometer, by a fixed resistance in series with the variable section, or by a fixed cathode resistance in addition to the regulating resistor. See Figs. 28-30.

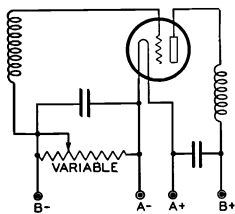

Fig. 28

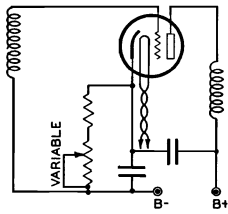

Fig. 29

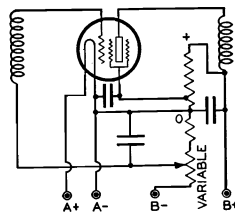

Fig. 30

SCREEN VOLTAGE SUPPLY

The positive voltage for the screen of a radio tube is usually obtained from a tap on the B-supply. For screen grid types of the four-electrode (or tetrode) construction, the screen voltage should be obtained by connecting the screen either direct to the proper voltage tap or through a potentiometer connected across the B-supply, but never through a series resistance to a high-voltage supply. This latter arrangement will not usually be satisfactory because of screen-current variations. Tubes of the pentode construction, however, may utilize the series-resistor arrangement, since this construction makes possible greater uniformity of the screen-current characteristic. See Fig. 31.

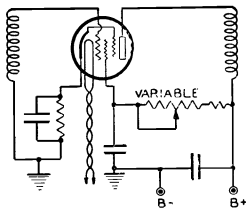

Fig. 31

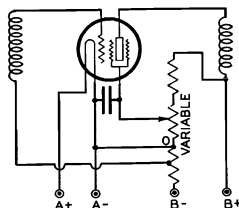

Fig. 32

Screen voltage variation for the r-f amplifier stages is sometimes used for volume control of the receiver. Reduced screen voltage lowers the mutual conductance of the tube and results in decreased gain per stage. The voltage variation is obtained by means of a potentiometer shunted across the screen voltage supply. See Fig. 32.

SHIELDING

Circuits employing tubes having high-gain capabilities, particularly screen grid types, require shielding by metal enclosures if stable operation and high-gain per stage is to be obtained. In multi-tube r-f amplifier circuits, it is necessary to shield completely and effectively each stage and to include within the stage shield the coupling device. Unless the coils and condensers of the various stages are shielded from each other, the amplification possibilities of the tubes and their circuits cannot be realized.

FILTERS

Since coupling between stages can occur not only from interaction of stage-coupling devices, but also from a common voltage-supply circuit, it is advisable to employ filters in all voltage-supply leads entering the stage shields. A filter, in order to be effective, should have a high impedance to the frequencies handled by the stage. Radio-frequency filters require the use of high-grade by-pass condensers for most satisfactory results. See Fig. 33 for various filter arrangements. Arrangements A and B are recommended where the current is small. Arrangements C and D are preferable for larger currents where voltage regulation is important.

OUTPUT-COUPLING DEVICES

An output-coupling device is used in the plate circuit of a power output tube to keep its comparatively high d-c plate current from the winding of an electro-magnetic speaker and, also, to transfer power efficiently from the output stage to a loudspeaker of either the electro-magnetic or dynamic type.

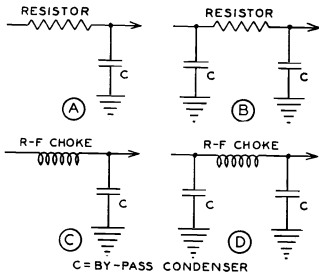

Fig. 33

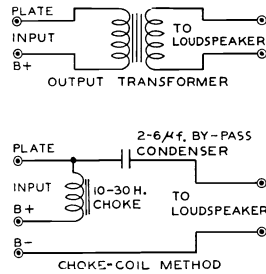

Fig. 34

Output-coupling devices are of two types, (1) choke-condenser and (2) transformer. The choke-condenser type consists of an iron-core choke with an inductance of not less than 10 henrys which is placed in series with the plate and B-supply. The choke offers a very low resistance to the d-c plate current component of the signal voltage but opposes the flow of the fluctuating component. A by-pass condenser of 2 to 6 μf supplies a path to the speaker winding for the signal voltage. The transformer type is constructed with two separate windings, a primary and a secondary wound on an iron core. This construction permits of designing each winding to meet the requirements of its position in the circuit. Typical arrangements of each type of coupling device are shown in Fig. 34. Examples of transformers for push-pull stages are shown in several of the circuits given in the CIRCUIT SECTION.



Assembling Radio Tubes

Radio Tube

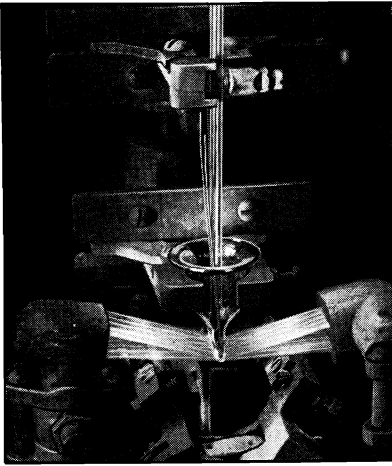

1.

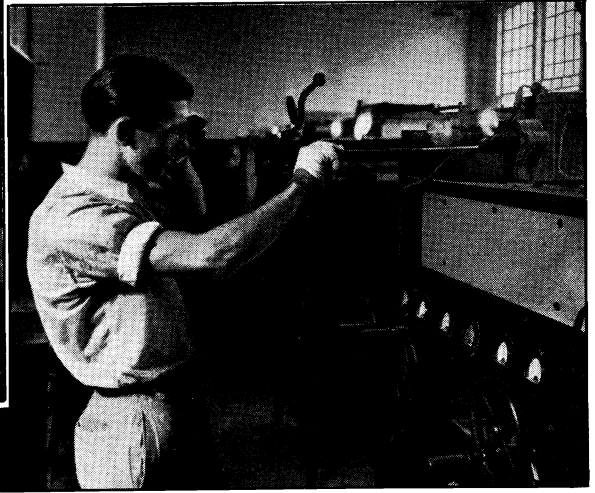

2.

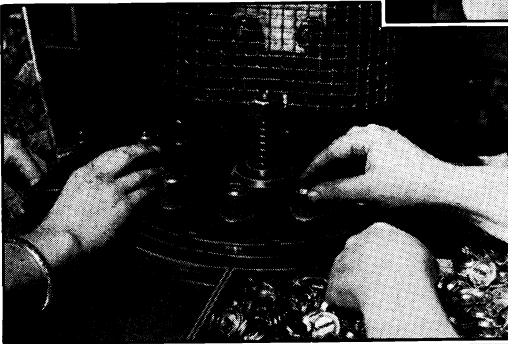

3.

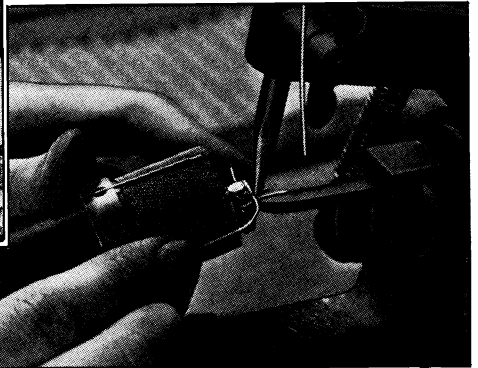

4.

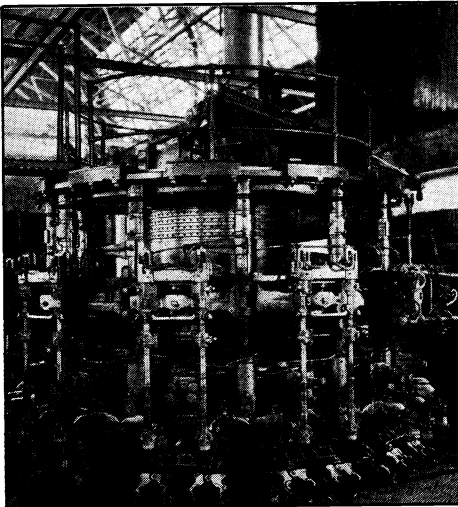

5.

(1) *Stem Making*—Metal jaws automatically press the molten glass around the lead-in wires to form an air-tight seal, or press.

(2) *Insulating Heater Wires*—Tiny heater filaments, freshly coated with insulating material are heated in extremely high-temperature furnaces to insure permanent insulation from the cathode sleeve.

(3) *Assembling External Screens*—Powerful presses gauge and mechanically unite external- and top-shield into one unit.

(4) *Spot Welding*—Every electrical connection inside of a radio tube is welded. This insures high electrical conductivity.

(5) *Bulb-making Machine*—Drawing molten glass automatically from an adjacent furnace, this mechanical giant shapes radio tube bulbs with amazing rapidity.

Manufacture

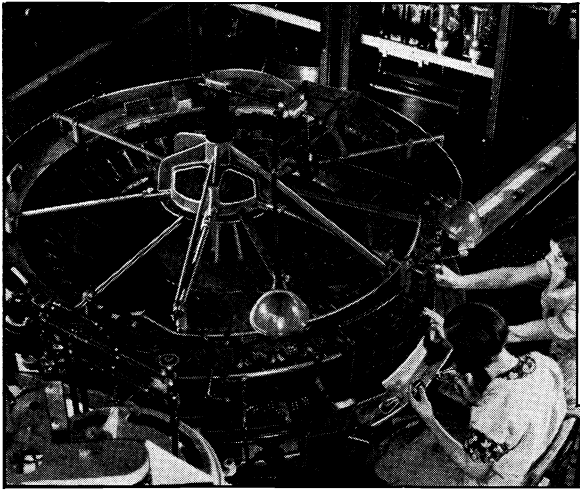

6.

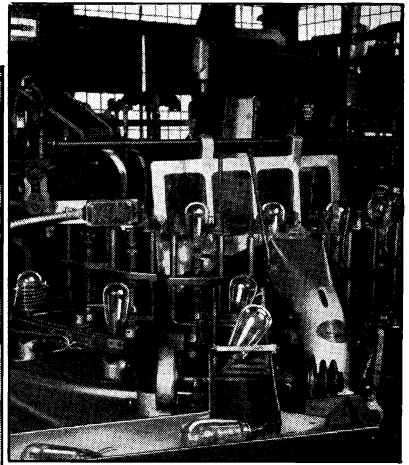

7.



9.

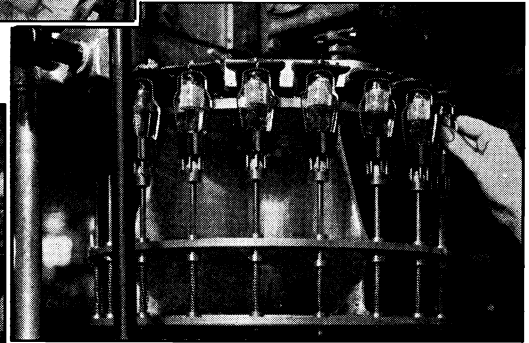

8.

(6) *Cementing Bases*—A base is lined with special cement and placed on the tube. The assembly passes through a rotary oven to set the cement.

(7) *Bulb-sealing and Exhausting*—This machine seals the bulb to the stem. The atmosphere is then drawn from the bulb by highly efficient pumps.

(8) *Capping Screen-grid Tubes*—The tiny cement-lined metal caps are placed over the grid-connection seal of the bulb. The bulb is rotated through an oven to fasten the cap firmly to the glass.

(9) *Seasoning Tubes*—The tube, before final inspection, is placed on a "seasoning" rack where it is operated for a length of time sufficient to stabilize its characteristics.

(10) *An Inspecting Operation*—Accurate instruments are used for inspection tests which include short- and open-circuit checks as well as plate current, cathode activity (emission), a-c output, gas, and leakage measurements.

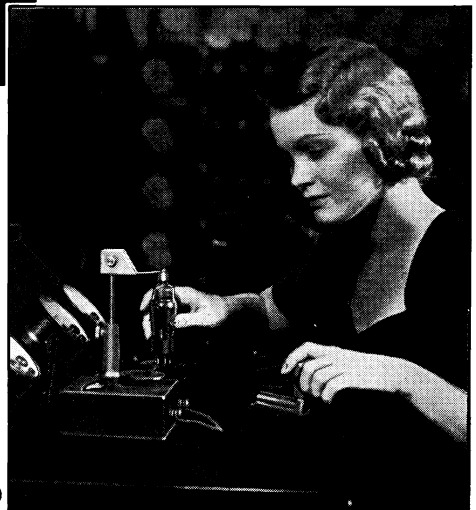

10



RCA Radiotron

**Cunningham
RADIO TUBES**

RCA-1A6

C-1A6

PENTAGRID CONVERTER

The 1A6 is a multi-electrode type of vacuum tube designed primarily to perform simultaneously the function of a mixer tube and of an oscillator tube in superheterodyne circuits. Through its use, the independent control of each function is made possible within a single tube. The 1A6 is designed especially for use in battery-operated receivers. In such service, this tube replaces the two tubes required in conventional circuits and gives improved performance. For general discussion of pentagrid types see Frequency Conversion, page 21.

CHARACTERISTICS

FILAMENT VOLTAGE (D. C.)	2.0	Volts
FILAMENT CURRENT	0.060	Ampere
DIRECT INTERELECTRODE CAPACITANCES (Approx.)		
Grid No. 4 to Plate (With shield-can)	0.25	$\mu\mu\text{f}$
Grid No. 4 to Grid No. 2 (With shield-can)	0.2	$\mu\mu\text{f}$
Grid No. 4 to Grid No. 1 (With shield-can)	0.1	$\mu\mu\text{f}$
Grid No. 1 to Grid No. 2	0.8	$\mu\mu\text{f}$
Grid No. 4 to all other Electrodes (R-F input)	10.5	$\mu\mu\text{f}$
Grid No. 2 to all other Electrodes (Osc. output)	6	$\mu\mu\text{f}$
Grid No. 1 to all other Electrodes (Osc. input)	5	$\mu\mu\text{f}$
Plate to all other Electrodes (Mixer output)	9	$\mu\mu\text{f}$
BULB (For dimensions, see Page 151, Fig. 7)		ST-12
CAP		Small Metal
BASE (For socket connections, see Page 150, Fig. 26)		Small 6-Pin

Converter Service

PLATE VOLTAGE	180 max.	Volts
SCREEN VOLTAGE (Grid Nos. 3 and 5)	67.5 max.	Volts
ANODE-GRID (Grid No. 2)	135 max.	Volts
CONTROL-GRID (No. 4)	-3 min.	Volts
TOTAL CATHODE CURRENT	9 max.	Milliamperes

TYPICAL OPERATION

Filament Voltage	2.0	2.0	Volts
Plate Voltage	135	180	Volts
Screen Voltage (Grid Nos. 3 and 5)	67.5	67.5	Volts
Anode-Grid (Grid No. 2)	135	135	Volts
Control-Grid (Grid No. 4)	-3	-3	Volts
Oscillator-Grid (Grid No. 1) Resistor	50000	50000	Ohms
Plate Current	1.2	1.3	Milliamperes
Screen Current	2.5	2.4	Milliamperes
Anode-Grid Current	2.3	2.3	Milliamperes
Oscillator-Grid Current	0.2	0.2	Milliampere
Total Cathode Current	6.2	6.2	Milliamperes
Plate Resistance	0.4	0.5	Megohm
Conversion Conductance	275	300	Micromhos
Conversion Conductance (at -22.5 volts on Grid No. 4)	4	4	Micromhos

INSTALLATION

The **base** pins of the 1A6 require the use of a standard six-contact socket which should be installed to operate the tube in a vertical position.

The coated **filament** of the 1A6 may be operated conveniently from dry-cells, from a single lead storage-cell, or from an air-cell battery. For dry-cell operation, a filament rheostat may be used together with a permanently installed voltmeter to insure the proper filament voltage. For operation from a 2-volt lead storage-cell, the 1A6 requires no filament resistor. Operation with an air-cell battery requires a fixed resistor in the filament circuit. This resistor should have a value such that with a new air-cell battery, the voltage applied across the filament terminals will not initially exceed 2.15 volts. *Series operation of the filament of the 1A6 with those of other two-volt battery types is not recommended.* Socket terminal No. 3 (see socket connections) should be connected to the positive battery terminal.

Complete **shielding** of the 1A6 is generally necessary to prevent intercoupling between its circuit and those of other stages.

APPLICATION

As a **frequency converter** in superheterodyne circuits, the 1A6 can supply the local oscillator frequency and at the same time mix it with the radio-input frequency to provide the desired intermediate frequency. For this service, design information is given under CHARACTERISTICS. It is important to note that the anode-grid voltage and the plate voltage must each be higher than the screen voltage.

For the oscillator circuit, the coils may be constructed according to conventional design, since the tube is not particularly critical. The voltage applied to the anode-grid (No. 2) should not exceed the maximum value of 135 volts, but should always be higher than the screen (grids No. 3 and No. 5) voltage. The anode-grid voltage may be obtained from a suitable tap on the B-battery or from the plate-supply tap through a voltage-dropping resistor of 20000 ohms shunted by a by-pass condenser of 0.1 μ f. The size of the resistor in the grid circuit of the oscillator is not critical but requires design adjustment depending upon the values of the anode-grid voltage and of the screen voltage. Adjustment of the circuit should be such that the cathode current is approximately 6 milliamperes. *Under no condition of adjustment should the cathode current exceed the recommended maximum value of 9 milliamperes.*

The bias voltage applied to grid No. 4 can be varied over relatively wide limits to control the translation gain of the tube. For example, with 67.5 volts on the screen (No. 3 and No. 5), the bias voltage may be varied from -3 to plate current cut-off (approximately -25 volts). With lower screen voltages, the cut-off point is proportionately less. The extended cut-off feature of the 1A6 in combination with the similar characteristics of super-control tubes can be utilized advantageously to adjust receiver sensitivity.

Since the capacity between grid No. 4 and plate is in a parallel path with the capacity and inductance of the plate load, it is important to use a load capacity of sufficient size to limit the magnitude of the r-f voltage built up across the load. If this is not done, r-f voltage feed-back will occur between plate and grid No. 4 to produce degenerative effects. For this reason, the size of the load condenser in the plate circuit should be not less than 50 μ f.

Converter circuits employing the 1A6 may easily be designed to have a translation gain of approximately 40. A typical circuit is shown which provides exceptionally uniform oscillator output over the entire grid-bias range. Refer to page 38 for details of oscillator coil assemblies.

TYPICAL PENTAGRID CONVERTER CIRCUIT

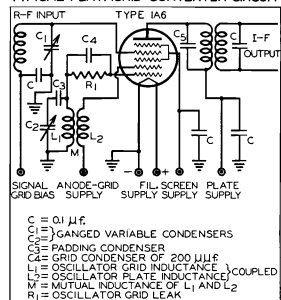

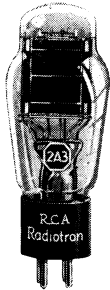

RCA Radiotron

**Cunningham
RADIO TUBES**

RCA-2A3

C-2A3

POWER AMPLIFIER TRIODE

The 2A3 is a three-electrode, high-vacuum type of power amplifier tube for use in the power-output stage of a-c operated receivers. It possesses unusual capabilities for delivering exceptionally large, undistorted power output. The exceptionally large power-handling ability of the 2A3 is the result of its design features. Among these are its extremely high mutual conductance and its highly efficient cathode which is composed of a large number of coated filaments arranged in series-parallel. This unusual feature provides a very large effective cathode area and thus makes possible the desirable characteristics of the 2A3.

CHARACTERISTICS

FILAMENT VOLTAGE (A. C. or D. C.)	2.5	Volts
FILAMENT CURRENT	2.5	Amperes
GRID-PLATE CAPACITANCE	13	$\mu\mu\text{f}$
GRID-FILAMENT CAPACITANCE	9	$\mu\mu\text{f}$
PLATE-FILAMENT CAPACITANCE	4	$\mu\mu\text{f}$
BULB (For dimensions, see Page 151, Fig. 13)		ST-16
BASE (For socket connections, see Page 150, Fig. 1)		Medium 4-Pin

As a Single-Tube Class A Amplifier

FILAMENT VOLTAGE (A. C.)	2.5	Volts
PLATE VOLTAGE	250 <i>max.</i>	Volts
GRID VOLTAGE*	-45	Volts
PLATE CURRENT	60	Milliamperes
PLATE RESISTANCE	800	Ohms
AMPLIFICATION FACTOR	4.2	
MUTUAL CONDUCTANCE	5250	Micromhos
LOAD RESISTANCE	2500	Ohms
UNDISTORTED POWER OUTPUT	3.5	Watts

As a Push-Pull Class A Amplifier (Two Tubes)

	<i>Fixed Bias</i>	<i>Self Bias</i>	
FILAMENT VOLTAGE (A. C.)	2.5	2.5	Volts
PLATE VOLTAGE	300 <i>max.</i>	300 <i>max.</i>	Volts
GRID VOLTAGE*	-62	-62	Volts
PLATE CURRENT (Per tube)	40	40	Milliamperes
LOAD RESISTANCE (Plate-to-plate)	3000	5000	Ohms
TOTAL HARMONIC DISTORTION	2.5	5	Per cent
POWER OUTPUT	15	10	Watts

* Grid volts measured from mid-point of a-c operated filament.

INSTALLATION

The **base** pins of the 2A3 fit the standard four-contact socket which may be installed to hold the tube either in a vertical or in a horizontal position. For horizontal operation, the socket should be positioned with the filament-pin openings one vertically above the other. Sufficient ventilation should be provided to prevent overheating.

The **filament** of this type is usually operated on a.c. See page 24.

APPLICATION

As a **power amplifier (Class A)**, the 2A3 is adaptable either singly or in push-pull combination to the power-output stage of a-c receivers. Recommended operating conditions are given under CHARACTERISTICS.

THE RCA RADOTRON-CUNNINGHAM RADIO TUBE MANUAL

The values recommended for push-pull operation are different than the conventional ones usually given on the basis of characteristics for a single tube. The values shown for Push-Pull Class A operation cover operation with fixed-bias and with self-bias, and have been determined on the basis of no grid current flow during the most positive swing of the input signal and of cancellation of second harmonic distortion by virtue of the push-pull circuit.

If a single 2A3 is operated self-biased, the self-biasing resistor should be approximately 700 ohms. This value is the same for two 2A3's in push-pull. In either case the resistor should preferably be shunted by a suitable filter network to minimize grid-bias variations produced by current surges in the biasing resistor.

Any conventional type of **input coupling** may be used provided the resistance added to the grid circuit by this device is not too high. *Transformers or impedances are recommended.* When self-bias is used, the d-c resistance in the grid circuit should not exceed 0.5 megohm. With fixed-bias, however, the d-c resistance should not exceed 10000 ohms.

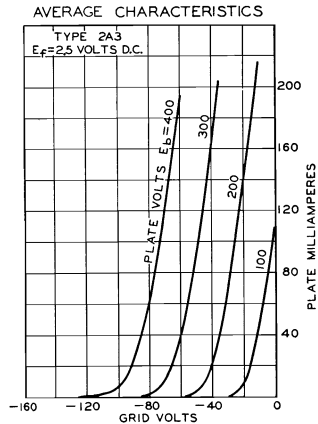
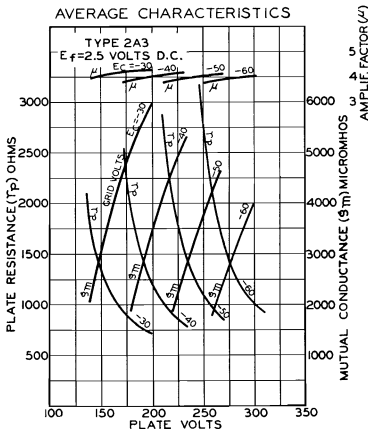
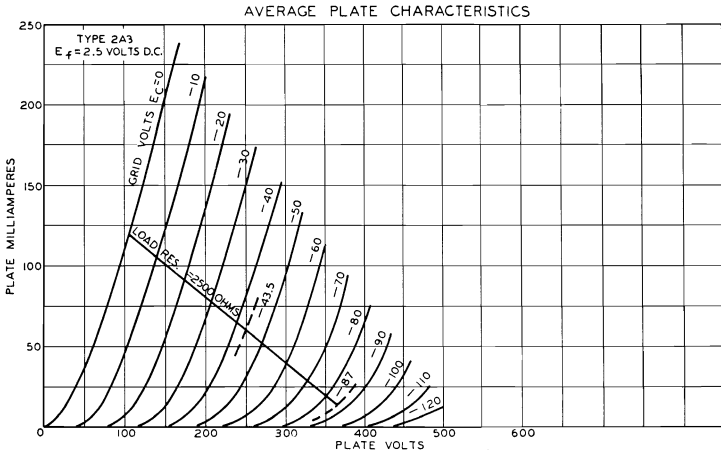



RCA Radiotron

**Cunningham
RADIO TUBES**

RCA-2A5

C-2A5

POWER AMPLIFIER PENTODE

The 2A5 is a power amplifier pentode of the heater-cathode type for use in the audio-output stage of a-c receivers. It is capable of giving large power output with a relatively small input-signal voltage. Because of the heater-cathode construction, a uniformly low hum-level is attainable in power-amplifier design.

The power-handling ability of the 2A5 is essentially the same as that of the 59 with pentode connection, but the latter type has a greater flexibility of application to power-amplifier design. The two types, however, are not directly interchangeable because of the difference in base connections.

CHARACTERISTICS

HEATER VOLTAGE (A. C. or D. C.).....	2.5	Volts
HEATER CURRENT.....	1.75	Amperes
PLATE VOLTAGE.....	250 <i>max.</i>	Volts
SCREEN VOLTAGE.....	250 <i>max.</i>	Volts
GRID VOLTAGE.....	-16.5	Volts
PLATE CURRENT.....	34	Milliamperes
SCREEN CURRENT.....	6.5	Milliamperes
PLATE RESISTANCE.....	100000 <i>approx.</i>	Ohms
AMPLIFICATION FACTOR.....	220 <i>approx.</i>	
MUTUAL CONDUCTANCE.....	2200	Micromhos
LOAD RESISTANCE.....	7000	Ohms
POWER OUTPUT (7% total harmonic distortion).....	3.0	Watts
BULB (For dimensions, see Page 151, Fig. 11).....		ST-14
BASE (For socket connections, see Page 150, Fig. 15A).....		Medium 6-Pin

INSTALLATION

The **base** pins of the 2A5 fit the standard six-contact socket which may be installed to hold the tube in any position.

The **bulb** of this tube will become very hot under certain conditions of operation. Sufficient ventilation should be provided to prevent overheating.

The **heater** is designed to operate at 2.5 volts. The transformer winding supplying the heater circuit should be designed to operate the heater at this recommended value for full-load operating conditions at average line voltage.

The **cathode** should preferably be connected directly to a mid-tap on the heater winding or to a center-tapped resistor across the heater winding. If this practice is not followed, the potential difference between heater and cathode should be kept as low as possible.

APPLICATION

As a **power amplifier (Class A)**, the 2A5 may be used either singly or in push-pull combination. Recommended operating conditions are given under CHARACTERISTICS.

If a single 2A5 is operated self-biased at a plate voltage of 250 volts, the self-biasing resistor should have a value of 410 ohms. This resistor should be shunted by a suitable filter network to avoid degenerative effects at low audio frequencies. The use of two 2A5's in push-pull eliminates the necessity for shunting the resistor. The value of the self-biasing resistor required for the push-pull stage is one-half that for a single stage.

THE RCA RADIOTRON-CUNNINGHAM RADIO TUBE MANUAL

Any conventional type of **input coupling** may be used provided the resistance added to the grid circuit by this device is not too high. Transformer or impedance coupling devices are recommended. If, however, resistance coupling is employed, the grid resistor should not exceed one megohm with self-bias provided the heater voltage does not rise more than 10% above the rated value under any conditions of operation; without self-bias, the value should be limited to 100000 ohms.

An **output transformer** should be used in order to transfer power efficiently to the speaker. The optimum value of load resistance for a single tube is given under **CHARACTERISTICS**. For push-pull operation, the plate-to-plate load resistance should be twice that for a single tube. For best results, the impedance in the plate circuit of the 2A5 should be as uniform as possible over the entire audio-frequency range.

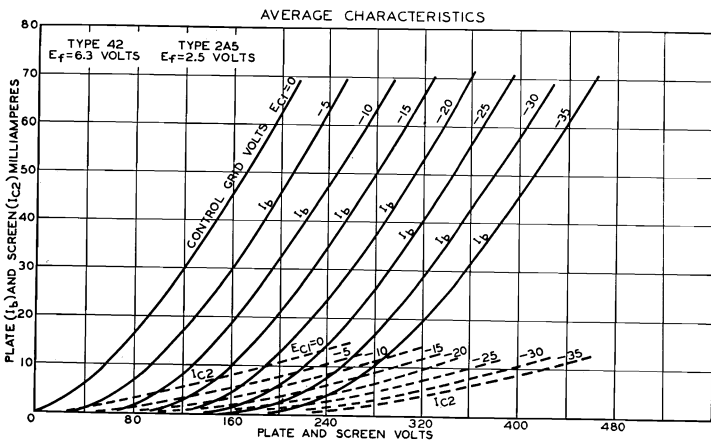
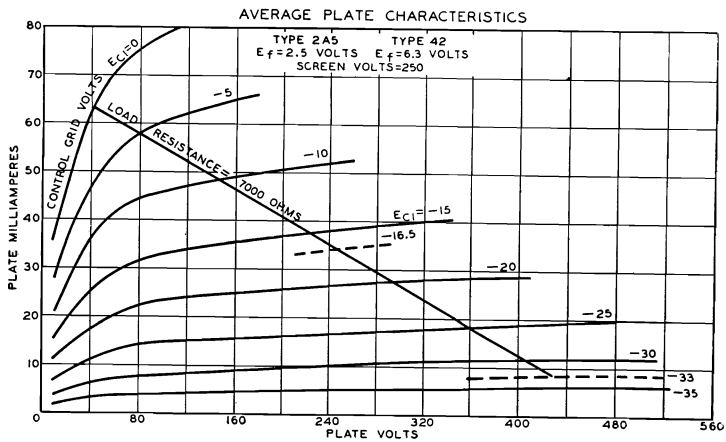



RCA-2A6

C-2A6

DUPLEX-DIODE HIGH-MU TRIODE

The 2A6 is a 2.5-volt heater type of tube consisting of two diodes and a high-mu triode in a single bulb. It is for use as a combined detector, amplifier, and automatic-volume-control tube in a-c receivers designed for its characteristics. For diode-detector considerations, refer to page 17.

CHARACTERISTICS

HEATER VOLTAGE (A. C. or D. C.).....	2.5	Volts
HEATER CURRENT.....	0.8	Ampere
GRID-PLATE CAPACITANCE.....	1.7	$\mu\mu\text{f}$
GRID-CATHODE CAPACITANCE.....	1.7	$\mu\mu\text{f}$
PLATE-CATHODE CAPACITANCE.....	3.8	$\mu\mu\text{f}$
BULB (For dimensions, see Page 151, Fig. 7).....		ST-12
CAP.....		Small Metal
BASE (For socket connections, see Page 150, Fig. 13).....		Small 6-Pin

Triode Unit—As Class A Amplifier

HEATER VOLTAGE.....	2.5	Volts
PLATE VOLTAGE.....	250 <i>max.</i>	Volts
GRID VOLTAGE.....	-2	Volts
AMPLIFICATION FACTOR.....	100	
PLATE RESISTANCE.....	91000	Ohms
MUTUAL CONDUCTANCE.....	1100	Micromhos
PLATE CURRENT.....	0.8	Milliampere

Diode Units

The two diode plates are placed around a cathode, the sleeve of which is common to the triode unit. Each diode plate has its own base pin. Operation curves for the diode units are given under type 2B7, page 41.

INSTALLATION

The **base** pins of the 2A6 fit the standard six-contact socket which may be installed to hold the tube in any position.

Heater operation and **cathode** connection are the same as for the 2A5.

APPLICATION

The 2A6 in many respects is similar in application to the 55. The outstanding difference, however, is that the 2A6 has a high-mu triode. For this reason, the tube is recommended for use only in resistance-coupled circuits. Furthermore, diode-biasing of the triode unit is not suitable because of the probability of triode plate-current cut-off, even with relatively small signal voltages applied to the diode circuit.

As an **amplifier** in resistance-coupled a-f circuits, the 2A6 may be operated under the conditions given on page 142. A family of average plate characteristics curves applicable to this type will be found under type 75, page 113.



RCA Radiotron

**Cunningham
RADIO TUBES**

RCA-2A7

C-2A7

PENTAGRID CONVERTER

The 2A7 is a multi-electrode type of vacuum tube designed primarily to perform simultaneously the functions of a mixer (first detector) tube and of an oscillator tube in superheterodyne circuits. Through the use of this type, the independent control of each function is made possible within a single tube. The 2A7 is intended especially for use in a-c receivers having a 2.5-volt heater supply.

CHARACTERISTICS

HEATER VOLTAGE (A. C. or D. C.).....	2.5	Volts
HEATER CURRENT.....	0.8	Ampere
DIRECT INTERELECTRODE CAPACITANCES (Approx.)		
Grid No. 4 to Plate (With shield-can)	0.3	$\mu\mu\text{f}$
Grid No. 4 to Grid No. 2 (With shield-can)	0.15	$\mu\mu\text{f}$
Grid No. 4 to Grid No. 1 (With shield-can)	0.15	$\mu\mu\text{f}$
Grid No. 1 to Grid No. 2.....	1.0	$\mu\mu\text{f}$
Grid No. 4 to all other Electrodes (R-F input)....	8.5	$\mu\mu\text{f}$
Grid No. 2 to all other Electrodes (Osc. output)..	5.5	$\mu\mu\text{f}$
Grid No. 1 to all other Electrodes (Osc. input)...	7.0	$\mu\mu\text{f}$
Plate to all other Electrodes (Mixer output).....	9.0	$\mu\mu\text{f}$
BULB (For dimensions, see Page 151, Fig. 7).....		ST-12
CAP.....		Small Metal
BASE (For socket connections, see Page 150, Fig. 20).....		Small 7-Pin

As Frequency Converter

PLATE VOLTAGE.....	250 max.	Volts
SCREEN VOLTAGE (Grids No. 3 and No. 5).....	100 max.	Volts
ANODE-GRID VOLTAGE (Grid No. 2).....	200 max.	Volts
ANODE-GRID SUPPLY VOLTAGE (Grid No. 2).....	250 max.	Volts
CONTROL-GRID VOLTAGE (Grid No. 4).....	-3 min.	Volts
TOTAL CATHODE CURRENT.....	14 max.	Milliamperes
TYPICAL OPERATION		
Plate Voltage.....	100	250 Volts
Screen Voltage (Grids No. 3 and No. 5) ..	50	100 Volts
Anode-Grid Voltage (Grid No. 2).....	100	200 Volts
Control-Grid Voltage (Grid No. 4).....	-1.5	-3 Volts
Oscillator-Grid (Grid No. 1) Resistor....	10000	50000 Ohms
Plate Current.....	1.3	3.5 Milliamperes
Screen Current.....	2.5	2.2 Milliamperes
Anode-Grid Current.....	3.3	4.0 Milliamperes
Oscillator-Grid Current.....	1.2	0.7 Milliamperes
Cathode Resistor.....	150	300 Ohms
Plate Resistance.....	0.6	0.36 Megohm
Conversion Conductance.....	350	520 Micromhos
Control-Grid Voltage (Conver. cond. = 2 μmhos).....	-20	-45 approx. Volts

INSTALLATION

The **base** pins of the 2A7 fit seven-contact (0.75 inch pin-circle diameter) sockets which may be installed to hold the tube in any position.

For **heater** operation and **cathode** connection, refer to the type 2A5.

Complete **shielding** of the 2A7 is generally necessary to prevent intercoupling between its circuit and the circuits of other stages.

APPLICATION

As a **frequency converter** in superheterodyne circuits, the 2A7 can supply the local oscillator frequency and at the same time mix it with the radio-input frequency to provide the desired intermediate frequency. For this service, design information is given under CHARACTERISTICS.

For the **oscillator** circuit, the coils may be constructed according to conventional design, since the tube is not particularly critical. The supply voltage applied to the anode-grid (No. 2) should not exceed the maximum value of 250 volts. In fact, from a performance standpoint, a lower value is to be preferred, because it will be adequate to provide for optimum translation gain. The size of the resistor in the grid circuit of the oscillator is not critical but requires design adjustment depending upon the values of the anode-grid voltage and of the screen voltage. Adjustment of the circuit should be such that the cathode current is approximately 11 milliamperes. Under no condition of adjustment should the cathode current exceed a recommended maximum value of 14 milliamperes. The following tabulation gives suitable values for different voltages on the electrodes.

PLATE VOLTAGE.....	100	250	250	Volts
SCREEN VOLTAGE (Grids No. 3 and No. 5)....	50	75	100	Volts
ANODE-GRID (No. 2) VOLTAGE.....	100	100	250*	Volts
GRID (No. 1) RESISTOR.....	10000-25000	25000-50000	50000-100000	Ohms

* Applied through resistor of 20000 ohms

The bias voltage applied to grid No. 4 can be varied from -3 volts to cut-off to control the translation gain of the tube. With lower screen voltages, the cut-off point is less remote. The extended cut-off feature of this tube in combination with the similar characteristic of super-control tubes can be utilized advantageously to adjust receiver sensitivity.

Since the capacity between grid No. 4 and plate is in a parallel path with the capacity and inductance of the plate load, it is important to use a load capacity of sufficient size to limit the magnitude of the r-f voltage built up across the load. If this is not done, r-f voltage feed-back will occur between plate and grid No. 4 to produce degenerative effects. For this reason, the size of the load condenser in the plate circuit should be not less than 50 μμf.

Converter circuits employing the 2A7 may easily be designed to have a translation gain of approximately 60.

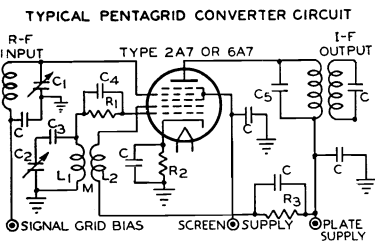

- C = 0.1 μμf.
- C1 = GANGED VARIABLE CONDENSERS
- C2 = PADDING CONDENSER
- C3 = GRID CONDENSER OF 200 μμf.
- L1 = OSCILLATOR GRID INDUCTANCE
- L2 = OSCILLATOR PLATE INDUCTANCE
- M = MUTUAL INDUCTANCE OF L1 & L2
- R1 = OSCILLATOR GRID LEAK
- R2 = SELF BIASING RESISTOR
- R3 = VOLTAGE REDUCING RESISTOR OF 20,000 OHMS (USED ONLY WHEN PLATE VOLTAGE IS OVER 200 VOLTS)

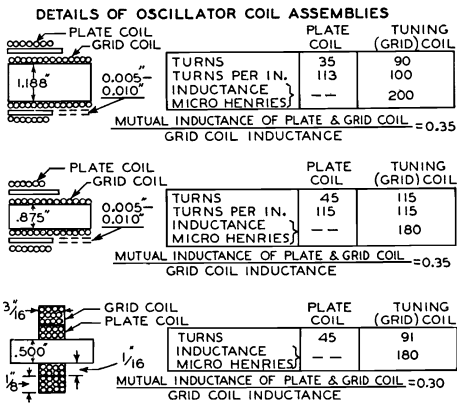

NOTE: EACH OF THESE COILS DESIGNED FOR AN INTERMEDIATE FREQUENCY OF 175 K.C. IN A BROADCAST-BAND RECEIVER



RCA-2B7

C-2B7

DUPLEX-DIODE PENTODE

The 2B7 is a heater type of tube consisting of *two diodes* and a *pentode* in a single bulb. It is recommended for service as a combined detector, amplifier (radio-frequency, intermediate-frequency or audio-frequency), and automatic-volume-control tube in radio receivers. The 2B7 is intended especially for use in a-c receivers having 2.5-volt heater supply.

In operation, the two diodes and the pentode in this tube are independent of each other except for the common cathode sleeve, which has one emitting surface for the diodes and another for the pentode. This independence of operation permits of desirable flexibility in circuit arrangement and design. The pentode unit of the 2B7 provides a means for obtaining high gain in the amplification of (1) the r-f or i-f input to the diode (s) or (2) the demodulated output of the diode (s).

CHARACTERISTICS

HEATER VOLTAGE (A. C. or D. C.).....	2.5	Volts
HEATER CURRENT.....	0.8	Ampere
BULB (For dimensions, see Page 151, Fig. 7).....		ST-12
CAP.		Small Metal
BASE (For socket connections, see Page 150, Fig. 21).....		Small 7-Pin

Pentode Unit—As Class A Amplifier

PLATE VOLTAGE.....	100	180	250	250 <i>max.</i>	Volts
SCREEN VOLTAGE.....	100	75	100	125 <i>max.</i>	Volts
GRID VOLTAGE.....	-3	-3	-3	-3	Volts
PLATE CURRENT.....	5.8	3.4	6.0	9.0	Milliamperes
SCREEN CURRENT.....	1.7	0.9	1.5	2.3	Milliamperes
PLATE RESISTANCE.....	0.3	1.0	0.8	0.65	Megohm
AMPLIFICATION FACTOR.....	285	840	800	730	
MUTUAL CONDUCTANCE.....	950	840	1000	1125	Micromhos
GRID VOLTAGE*.....	-17	-13	-17	-21 <i>approx.</i>	Volts

* For cathode-current cut-off.

Diode Units

Two diode plates are placed around a cathode, the sleeve of which is common to the pentode unit. Each diode plate has its own base pin.

INSTALLATION

The **base** pins of the 2B7 fit the seven-contact (0.75 inch pin-circle diameter) socket which may be installed to hold the tube in any position.

For **heater** operation and **cathode** connection, refer to type 2A5.

Complete **shielding** of detector circuits employing the 2B7 is generally necessary to prevent r-f or i-f coupling between the diode circuits and the circuits of other stages.

APPLICATION

The 2B7 is recommended for performing the simultaneous functions of automatic-volume-control, detection, and amplification.

For **detection**, the diodes of this tube may be utilized in a full-wave circuit or in a half-wave circuit. In the latter case, one plate only or the two plates in parallel may be employed. The use of the half-wave arrangement will provide approximately twice the rectified voltage as compared with the full-wave arrangement.

For **automatic-volume-control**, a rectified voltage which is dependent on the r-f or i-f carrier is usually employed. This voltage is utilized to regulate the gain of the r-f and/or i-f amplifier stages so as to maintain essentially constant-carrier input to the audio detector. Refer to discussion of automatic-volume-control methods on page 18.

The complex structure of the 2B7 permits of obtaining automatic-volume-control voltage in a number of ways. In one case, the required voltage is obtained from the detector circuit by utilizing the voltage drop caused by the rectified current flowing through a resistor in the detector circuit. In another case, the required voltage is obtained by utilizing one diode for the sole purpose of automatic-volume-control. This latter method is of particular interest since it confines the sensitivity and time-delay function to the a.v.c. circuit. Time-delay action is determined by the use of a resistance and condenser combination having the desired time constant. The a.v.c. action may be postponed by applying a negative voltage to the a.v.c. diode plate. Another a.v.c. arrangement capable of various adaptations is to use the pentode as a d-c amplifier to supply the regulating voltage.

For **r-f or i-f amplification**, the pentode unit of the 2B7 may be employed in conventional circuit arrangements. It is designed so that its cut-off is somewhat extended to permit of moderate gain control by grid-bias variation without introducing cross-modulation effects. The cut-off point and the ability to handle the larger signals may be altered by choice of screen voltage to suit the requirements of the circuit. To assist in making this choice, different operating conditions for representative screen voltages are given under CHARACTERISTICS.

For many types of circuits a convenient and practical method of obtaining the desired benefit of the extended cut-off is to supply the screen voltage from a high-voltage tap through a series resistor. This arrangement provides automatically an increase in the voltage applied to the screen as the grid-bias is made more negative, with the result that the maximum signal-handling ability is obtained. When this method is used, the voltage applied to the screen should be limited to 125 volts for -3 volts grid-bias and to 200 volts for more negative values of grid-bias.

For **a-f amplification**, the pentode unit of the 2B7 may be used in a resistance-coupled circuit arrangement to provide high gain. Typical operating conditions for such service are: Plate-supply voltage, 250 volts, applied through a load resistor of 0.2 megohm; screen voltage, 50 volts; grid-bias, -4.5 volts; and plate current, 0.65 milli-ampere. Grid-bias should be obtained from a fixed-voltage tap on the d-c power supply. The value of resistor in the grid-circuit should not exceed a maximum value of 1.0 megohm. Additional operating conditions are given on page 142.

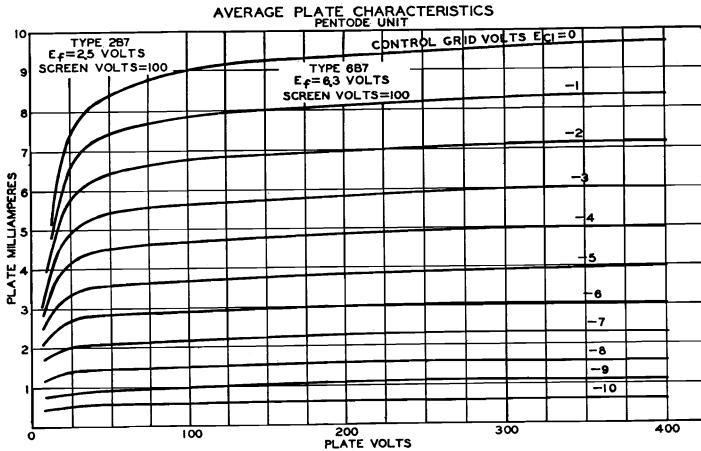

THE RCA RADOTRON-CUNNINGHAM RADIO TUBE MANUAL

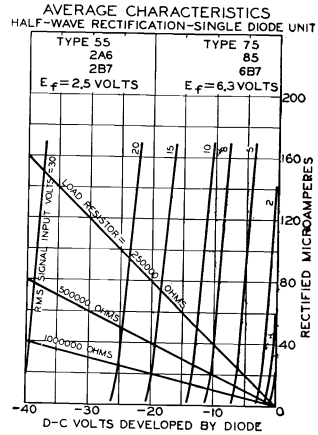
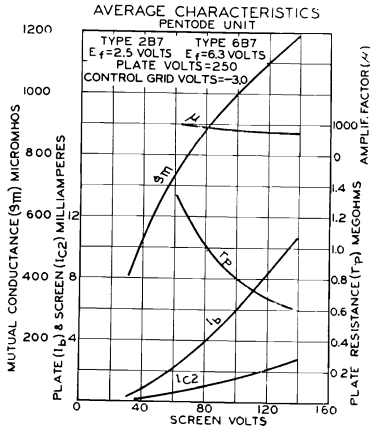

TYPICAL DUPLEX-DIODE PENTODE CIRCUITS USING TYPES 2B7 OR 6B7

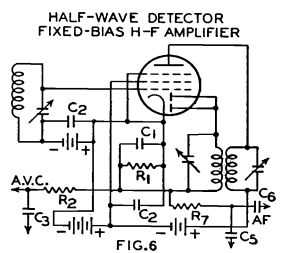
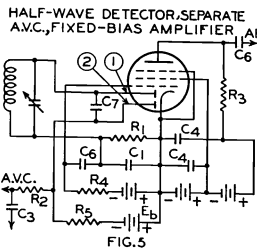
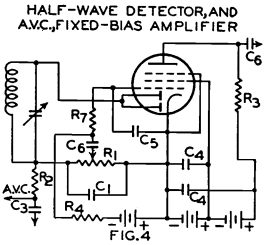
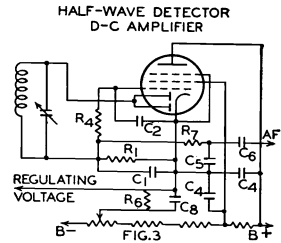
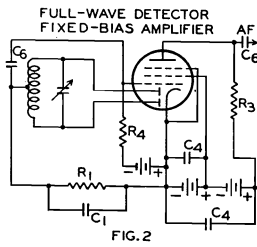
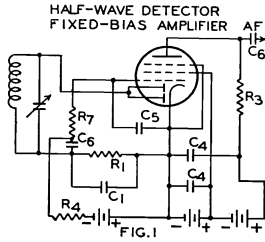

APPROXIMATE VALUES

- $C_1 = \sqrt{150 \mu\mu\text{F. FOR } 500-1500 \text{ KC.}}$
- $C_2 = 0.1 \mu\text{F.}$
- $C_3 = 0.1 \mu\text{F.}$
- $C_4 = 0.5 \mu\text{F. OR LARGER}$
- $C_5 = 0.0001 \mu\text{F. OR SMALLER}$
- $C_6 = 0.01 - 0.1 \mu\text{F.}$
- $C_7 = 0.0005 - 0.001 \mu\text{F.}$
- $C_8 = 0.1 \mu\text{F. OR LARGER}$

- $R_1 = 0.5 - 1.0 \text{ MEGOHM}$
- $R_2 = 1.0 - 1.5 \text{ MEGOHMS}$
- $R_3 = 0.1 - 0.2 \text{ MEGOHM}$
- $R_4 = 0.5 - 1.0 \text{ MEGOHM}$
- $R_5 = 1.0 \text{ MEGOHM}$
- $R_6 = 30000 - 100000 \text{ OHMS}$
- $R_7 = 0.1 - 0.2 \text{ MEGOHMS}$
- $E_b = \text{VOLTAGE FOR SENSITIVITY CONTROL}$

NOTE: SUPPRESSOR CONNECTED TO CATHODE WITHIN BULB



RCA Radiotron

**Cunningham
RADIO TUBES**

RCA-5Z3

C-5Z3

**HEAVY-DUTY FULL-WAVE
RECTIFIER**

The 5Z3 is a high-vacuum rectifier of the full-wave type intended for supplying rectified power to radio equipment having very large direct-current requirements.

CHARACTERISTICS

FILAMENT VOLTAGE (A. C.).....	5.0	Volts
FILAMENT CURRENT.....	3.0	Amperes
A-C VOLTAGE PER PLATE (RMS).....	500 <i>max.</i>	Volts
D-C OUTPUT CURRENT.....	250 <i>max.</i>	Milliamperes
BULB (For dimensions, see Page 151, Fig. 13).....		ST-16
BASE (For socket connections, see Page 150, Fig. 2).....		Medium 4-Pin

INSTALLATION

The **base** pins of the 5Z3 fit the standard four-contact socket which should be mounted preferably to hold the tube in a vertical position with the base down. If it is necessary to place the tube in a horizontal position, the socket should be mounted with the filament-pin openings either at the top or at the bottom so that the plane of each filament is vertical. Only a socket making very good filament contact and capable of carrying three amperes continuously should be used with the 5Z3. Provision should be made for adequate ventilation to prevent overheating.

The coated **filament** of the 5Z3 is intended to operate from the a-c line through a step-down transformer. The voltage applied to the filament terminals should be the rated value of 5.0 volts under operating conditions and average line voltage. The high current taken by the filament makes it imperative that all connections in the filament circuit be of low resistance and of adequate current-carrying capacity.

APPLICATION

As a **full-wave rectifier**, the 5Z3 may be operated with condenser-input or choke-input filter under conditions not to exceed the rating given under CHARACTERISTICS. Filter circuits are discussed on page 15.

As a **half-wave rectifier**, one or more 5Z3's may be operated with plates connected in parallel. For example, two 5Z3's so arranged in a full-wave circuit can supply twice the output current of a single tube. In this service, the plates of each 5Z3 are tied together at the socket. The allowable voltage and load conditions per tube are the same as for full-wave service.

OPERATION CHARACTERISTICS

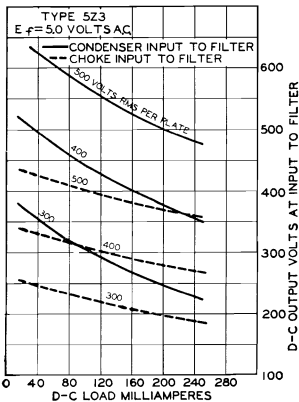



RCA-6A4

C-6A4

POWER AMPLIFIER PENTODE

The 6A4 is a power amplifier pentode of the 6.3-volt filament type for use in the audio output of automobile radio receivers and in other receivers employing a six-volt storage-battery filament supply. The 6A4 is interchangeable with type LA.

CHARACTERISTICS

FILAMENT VOLTAGE (A. C. or D. C.)					6.3	Volts
FILAMENT CURRENT					0.3	Ampere
PLATE VOLTAGE	100	135	165	180 <i>max.</i>	Volts	
SCREEN VOLTAGE	100	135	165	180 <i>max.</i>	Volts	
GRID VOLTAGE*	-6.5	-9	-11	-12	Volts	
PLATE CURRENT	9	14	20	22	Milliamperes	
SCREEN CURRENT	1.6	2.5	3.5	3.9	Milliamperes	
PLATE RESISTANCE	83250	52600	48000	45500 <i>approx.</i>	Ohms	
AMPLIFICATION FACTOR	100	100	100	100 <i>approx.</i>		
MUTUAL CONDUCTANCE	1200	1900	2100	2200	Micromhos	
LOAD RESISTANCE	11000	9500	8000	8000	Ohms	
POWER OUTPUT**	0.31	0.7	1.2	1.4	Watts	
BULB (For dimensions, see Page 151, Fig. 11)					ST-14	
BASE (For socket connections, see Page 150, Fig. 6)					Medium 5-Pin	

* Grid volts measured from negative end of d-c operated filament. If the filament is a-c operated, the tabulated values of grid bias should each be increased by 4.0 volts and be referred to the mid-point of filament.

** 9% total harmonic distortion.

INSTALLATION

The **base** pins of the 6A4 fit the standard five-contact socket which should be mounted preferably to hold the tube in a vertical position. If it is necessary to place the tube in a horizontal position, the socket should be mounted with its filament-pin openings one vertically above the other.

The coated **filament** of the 6A4 is primarily intended for operation from a six-volt storage battery. In such service, the filament terminals of the socket are connected directly across the battery. Socket terminal No. 3 (see socket connections) should be connected to the positive battery terminal.

APPLICATION

For the **power amplifier** stage, the 6A4 is recommended either singly or in push-pull combination. Transformer or impedance input-coupling devices are recommended. If, however, resistance coupling is employed, the grid resistor should not exceed 0.5 megohm. A family of plate characteristics for the 6A4 is shown on page 45.



RCA-6A7

C-6A7

PENTAGRID CONVERTER

The 6A7 is a multi-electrode type of vacuum tube designed primarily to perform simultaneously the functions of a mixer (first detector) tube and of an oscillator tube in superheterodyne circuits. Through the use of this type, the independent control of each function is made possible within a single tube. The 6A7 is especially suited for receivers of the automobile type, and for receivers in which the heaters are operated in series from the power line.

CHARACTERISTICS

HEATER VOLTAGE (A. C. or D. C.)	6.3	Volts
HEATER CURRENT	0.3	Ampere
DIRECT INTERELECTRODE CAPACITANCES, <i>Approx.</i>		
Grid No. 4 to Plate (With shield-can)	0.3	$\mu\mu\text{f}$
Grid No. 4 to Grid No. 2 (With shield-can)	0.15	$\mu\mu\text{f}$
Grid No. 4 to Grid No. 1 (With shield-can)	0.15	$\mu\mu\text{f}$
Grid No. 1 to Grid No. 2	1.0	$\mu\mu\text{f}$
Grid No. 4 to all other Electrodes (R-F input)	8.5	$\mu\mu\text{f}$
Grid No. 2 to all other Electrodes (Osc. output)	5.5	$\mu\mu\text{f}$
Grid No. 1 to all other Electrodes (Osc. input)	7.0	$\mu\mu\text{f}$
Plate to all other Electrodes (Mixer output)	9.0	$\mu\mu\text{f}$
BULB (For dimensions, see Page 151, Fig. 7)		ST-12
CAP		Small Metal
BASE (For socket connections, see Page 150, Fig. 20)		Small 7-Pin

As Frequency Converter

PLATE VOLTAGE	250	max.	Volts
SCREEN VOLTAGE (Grids No. 3 and No. 5)	100	max.	Volts
ANODE-GRID VOLTAGE (Grid No. 2)	200	max.	Volts
ANODE-GRID SUPPLY VOLTAGE (Grid No. 2)	250	max.	Volts
CONTROL-GRID VOLTAGE (Grid No. 4)	-3	min.	Volts
TOTAL CATHODE CURRENT	14	max.	Milliamperes
TYPICAL OPERATION			
Plate Voltage	100	250	Volts
Screen Voltage (Grids No. 3 and No. 5)	50	100	Volts
Anode-Grid Voltage (Grid No. 2)	100	200	Volts
Control-Grid Voltage (Grid No. 4)	-1.5	-3	Volts
Oscillator-Grid (Grid No. 1) Resistor	10000	50000	Ohms
Plate Current	1.3	3.5	Milliamperes
Screen Current	2.5	2.2	Milliamperes
Anode-Grid Current	3.3	4.0	Milliamperes
Oscillator-Grid Current	1.2	0.7	Milliamperes
Cathode Resistor	150	300	Ohms
Plate Resistance	0.6	0.36	Megohm
Conversion Conductance	350	520	Micromhos
Control Grid Voltage (Conver. cond. = 2 μmhos)	-20	-45	Volts

INSTALLATION

The **base** pins of the 6A7 fit the seven-contact (0.75 inch pin-circle diameter) socket which may be installed to hold the tube in any position.

The **heater** of the 6A7 is designed to operate on either d.c. or a.c. For operation on a.c. with a transformer, the winding which supplies the heater circuit should operate the heater at its recommended value for full-load operating conditions at average line voltage. For service in automobile receivers, the heater terminals of the 6A7 socket should be connected directly across a 6-volt battery. In receivers that employ a series-heater connection, the heater of the 6A7 may be operated in series with the heaters of other types having a 0.3 ampere rating. The current in the heater circuit should be adjusted to 0.3 ampere for the normal supply line voltage.

The **cathode** of the 6A7, when operated from a transformer, should preferably be connected directly to the electrical mid-point of the heater circuit. When it is operated in receivers employing a 6-volt storage battery for the heater supply, the cathode circuit is tied in either directly or through biasing resistors to the negative battery terminal. In "transformerless" receivers with a series-heater circuit, the cathode circuit of the 6A7 is tied in either directly or through biasing resistors to the negative side of the d-c plate supply which is furnished either by the d-c power line or by the a-c line by means of a rectifier. In circuits where the cathode is not directly connected to the heater, the potential difference between them should be kept as low as possible. If the use of a large resistor is necessary between the heater and cathode of the 6A7 in some circuit designs, it should be by-passed by a suitable filter network or objectionable hum may develop.

Complete **shielding** of the 6A7 is generally necessary to prevent intercoupling between its circuit and the circuits of other stages.

APPLICATION

Refer to APPLICATION on the 2A7.

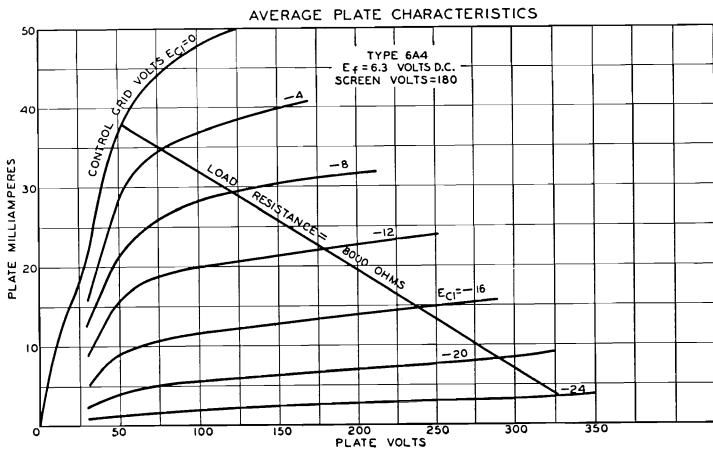

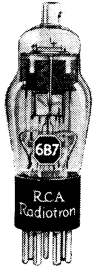

RCA Radiotron

Cunningham
RADIO TUBES

RCA-6B7

C-6B7

DUPLEX-DIODE PENTODE

The 6B7 is a heater type of tube consisting of *two diodes* and a *pentode* in a single bulb. It is recommended for service as combined detector, amplifier (radio-frequency, intermediate-frequency or audio-frequency), and automatic-volume-control tube in radio receivers.

The 6B7 is especially suited for receivers of the automobile type, and for receivers in which the heaters are operated in series from the power line. Except for the difference in heater voltage, this type is identical in design and application to the 2B7.

For diode-detector considerations, refer to page 17.

CHARACTERISTICS

HEATER VOLTAGE (A. C. or D. C.).....	6.3	Volts
HEATER CURRENT.....	0.3	Ampere
BULB (For dimensions, see Page 151, Fig. 7).....		ST-12
CAP.....		Small Metal
BASE (For socket connections, see Page 150, Fig. 21).....		Small 7-Pin

Pentode Unit—As Class A Amplifier

PLATE VOLTAGE.....	100	180	250	250 <i>max.</i>	Volts
SCREEN VOLTAGE.....	100	75	100	125 <i>max.</i>	Volts
GRID VOLTAGE.....	-3	-3	-3	-3	Volts
PLATE CURRENT.....	5.8	3.4	6.0	9.0	Milliamperes
SCREEN CURRENT.....	1.7	0.9	1.5	2.3	Milliamperes
PLATE RESISTANCE.....	0.3	1.0	0.8	0.65	Megohm
AMPLIFICATION FACTOR.....	285	840	800	730	
MUTUAL CONDUCTANCE.....	950	840	1000	1125	Micromhos
GRID BIAS VOLTAGE*.....	-17	-13	-17	-21 <i>approx.</i>	Volts

* For cathode current cut-off.

Diode Units

Two diode plates are placed around a cathode, the sleeve of which is common to the pentode unit. Each diode plate has its own base pin. Operation curves for the diode units are given under type 2B7, page 41.

INSTALLATION

Refer to INSTALLATION on the 6A7.

APPLICATION

Refer to APPLICATION on the 2B7.

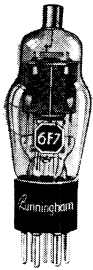

RCA-6F7

C-6F7

TRIODE-PENTODE

The 6F7 is a heater type of tube combining in one bulb a triode and an r-f pentode of the remote cut-off type. Since these two units are independent of each other except for the common cathode sleeve, the 6F7 may be adapted to circuit design in several ways.

CHARACTERISTICS

HEATER VOLTAGE (A. C. or D. C.).....	6.3	Volts
HEATER CURRENT.....	0.3	Ampere
DIRECT INTERELECTRODE CAPACITANCES		
<i>Triode Unit</i> —Grid to Plate.....	2.0	$\mu\mu\text{f}$
Grid to Cathode.....	2.5	$\mu\mu\text{f}$
Plate to Cathode.....	3.0	$\mu\mu\text{f}$
<i>Pentode Unit</i> —Grid to Plate (With shield-can)	0.008 max.	$\mu\mu\text{f}$
Input.....	3.2	$\mu\mu\text{f}$
Output.....	12.5	$\mu\mu\text{f}$
BULB (For dimensions see, Page 151, Fig. 7).....		ST-12
CAP.....		Small Metal
BASE (For socket connections, see Page 150, Fig. 27).....		Small 7-Pin

	<i>Triode Unit</i>	<i>Pentode Unit</i>	
PLATE VOLTAGE.....	100 max.	250 max.	Volts
SCREEN VOLTAGE.....	—	100 max.	Volts
GRID VOLTAGE.....	-3	-3 min.	Volts
AMPLIFICATION FACTOR.....	8	900	
PLATE RESISTANCE.....	17800	850000	Ohms
MUTUAL CONDUCTANCE.....	450	1100	Micromhos
MUTUAL CONDUCTANCE (At -35 volts bias)	—	10	Micromhos
PLATE CURRENT.....	3.5	6.5	Milliamperes
SCREEN CURRENT.....	—	1.5	Milliamperes

As a Frequency Converter

TYPICAL OPERATION

Plate Voltage.....	100 ^o	250	Volts
Screen Voltage.....	—	100	Volts
Grid Bias Voltage.....	†	-10*	Volts
Oscillator Peak Voltage Input.....	—	7	Volts
D-C Grid Current.....	0.15	0	Milliampere
D-C Plate Current††.....	2.4	2.8	Milliamperes
Screen Current.....	—	0.6	Milliampere
Plate Resistance.....	—	2.0	Megohms
Conversion Transconductance.....	—	300	Micromhos

^o May be obtained from 250-volt source through 60000-ohm dropping resistor.
 * Obtained by means of 1700-ohm self-biasing (cathode) resistor.
 † Obtained by 100000-ohm grid-leak resistor returned directly to cathode.
 †† Oscillator conditions should be adjusted so that plate current does not exceed maximum of 4 milliamperes.

INSTALLATION

Refer to APPLICATION on type 6A7.

APPLICATION

Being of the multi-unit type, the 6F7 is suitable for diversified applications. The triode unit and the pentode unit can be utilized independently of each other for performing any of the functions expected of single-unit types with similar characteristics. Circuit design for the 6F7, therefore, will follow conventional practice.

As a **frequency converter**, the 6F7 is used by employing the triode unit as oscillator and the pentode unit as mixer (first detector). The circuit should be adjusted so that the grid-bias voltage is approximately 3 volts greater than the peak oscillator voltage. In operation, the plate current of the oscillator should not exceed 4 milliamperes.

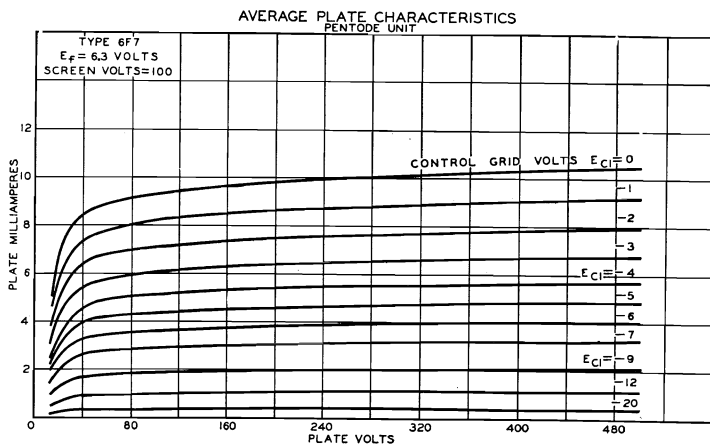
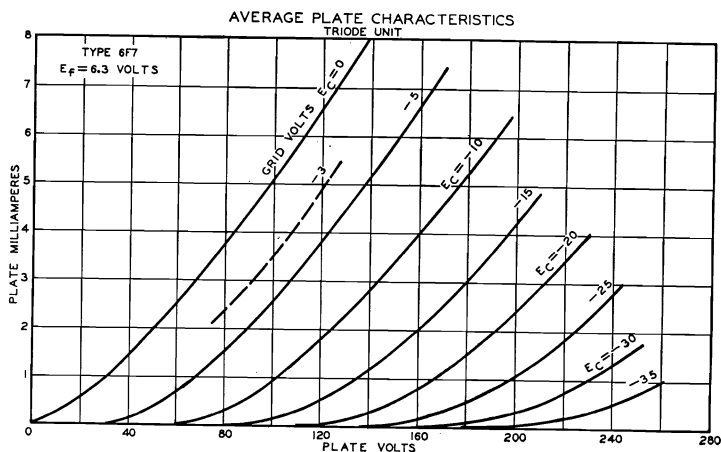



RCA-12Z3

C-12Z3

HALF-WAVE RECTIFIER

The 12Z3 is a half-wave, high-vacuum rectifier of the heater-cathode type for use in suitable circuits designed to supply d-c power from an a-c power line. It is well-suited for use in "transformerless" receivers of the "universal" (a.c.-d.c.) type. The adaptability of the 12Z3 to such receivers is facilitated by the heater design which permits of convenient series operation with other tube types.

CHARACTERISTICS

HEATER VOLTAGE (A. C. or D. C.).....	12.6	Volts
HEATER CURRENT.....	0.3	Ampere
A-C PLATE VOLTAGE (RMS).....	250 max.	Volts
D-C OUTPUT CURRENT.....	60 max.	Milliamperes
BULB (For dimensions, see Page 151, Fig. 6)		ST-12
BASE (For socket connections, see Page 150, Fig. 22).....		Small 4-Pin

INSTALLATION

The **base** pins of the 12Z3 fit the standard four-contact socket which may be mounted to hold the tube in any position. Sufficient ventilation should be provided to circulate air freely around the tube to prevent overheating.

The 12.6-volt **heater** of the 12Z3 is designed to operate under the normal conditions of line voltage variation without materially affecting the performance or serviceability of this tube. For operation of the 12Z3 in series with the heaters of other types having 0.3 ampere rating, the current in the heater circuit should be adjusted to 0.3 ampere for the normal supply voltage. The d-c potential difference between heater and cathode should be limited to 350 volts.

APPLICATION

As a **half-wave rectifier**, the 12Z3 is particularly useful in "transformerless" receivers of the "universal" type. Conditions for this service are given under CHARACTERISTICS.

A **filter** of the condenser-input type is recommended for use with this tube in order to obtain a d-c output voltage as high as possible. A large input capacitance in the order of 16 μ f is desirable. Typical output curves for several values of input condensers are shown in the accompanying diagram. As a supplement to the curves with a-c input voltage, a dashed curve is included to show the output when the receiver is operated from a d-c power line.

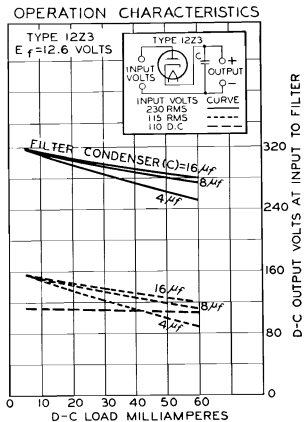



RCA-25Z5

C-25Z5

RECTIFIER-DOUBLER

The 25Z5 is a full-wave, high-vacuum rectifier of the heater-cathode type for use in suitable circuits designed to supply d-c power from an a-c power line. This tube is of particular interest because of its adaptability to the design of "transformerless" receivers of either the "universal (a.c.-d.c.)" type or the "a-c operated" type. In "universal" receivers, the 25Z5 may be used as a half-wave rectifier, while in the "a-c operated" type, it may be used as a voltage doubler to provide about twice the d-c output voltage obtainable from the half-wave arrangement. This two-fold application is made possible by the use of a separate base pin for each of the two cathodes. For voltage-doubler considerations, see page 16.

The heater of this tube has been designed to facilitate economical series operation with the heaters of other tubes in the radio set. The employment of a 25-volt heater permits the construction of a receiver with less heat dissipation in the fixed series-heater resistor. Furthermore, the heater-cathode design permits of close electrode spacing and provides high rectifying efficiency.

CHARACTERISTICS

HEATER VOLTAGE.....	25	Volts
HEATER CURRENT.....	0.3	Ampere
A-C VOLTAGE PER PLATE (RMS).....	125 <i>max.</i>	Volts
D-C OUTPUT CURRENT.....	100 <i>max.</i>	Milliamperes
BULB (For dimensions, see Page 151, Fig. 6).....		ST-12
BASE (For socket connections, see Page 150, Fig. 5).....		Small 6-Pin

INSTALLATION

The **base** pins of the 25Z5 fit the standard six-contact socket which may be mounted in any a position.

The **bulb** of this tube will become quite hot under certain conditions of operation. Sufficient ventilation should be provided to circulate air freely around the tube to prevent overheating.

The **heater** is designed to operate under the normal conditions of line voltage variation without materially affecting the performance or serviceability of this tube. The current in the heater circuit should be adjusted to 0.3 ampere for the normal supply voltage.

A **filter** of the condenser-input type is recommended for use with this tube in order to obtain a d-c output voltage as high as possible. A large input capacitance in the order of 16 μ f is desirable for half-wave rectifier service, while a higher value is advantageous for voltage-doubler circuits. Since the peak voltage applied to the input condenser(s) is relatively low, it is possible to use condensers of moderate voltage rating (sufficient only for the line voltage).

APPLICATION

As a **half-wave rectifier**, the 25Z5 is designed for service in "transformerless" receivers of the "universal" type. In such service, the two plates are connected together at the socket in order to act as a single plate; likewise, the cathodes are connected as a unit. Conditions for this method of operation are given under CHARACTERISTICS. Typical output curves for several values of input condensers are shown on page 51. As a supplement to the curves with a-c input voltage, a dotted curve is included to show the output when the receiver is operated from a d-c power line.

THE RCA RADIOTRON-CUNNINGHAM RADIO TUBE MANUAL

As a **voltage doubler**, the 25Z5 is adaptable to service in "transformerless" receivers of the "a-c operated" type and is capable of supplying approximately twice the d-c output voltage of the half-wave circuit. In voltage-doubling service, the two diode units of the tube are arranged as shown in the voltage-doubler circuit, below. Operating conditions for this type of service are the same as for half-wave service. Typical output curves for the voltage-doubler circuit are given on this page.

OPERATION CHARACTERISTICS
HALF-WAVE RECTIFIER

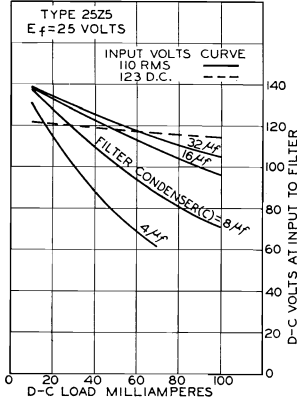

OPERATION CHARACTERISTICS
VOLTAGE DOUBLER

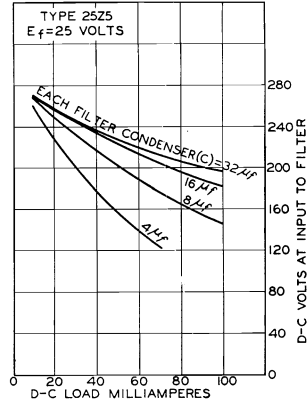

VOLTAGE-DOUBLER CIRCUIT

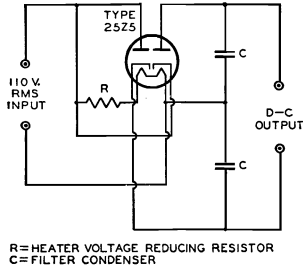



RCA Radiotron

Cunningham
RADIO TUBES

RCA-01A

C-01A

DETECTOR, AMPLIFIER

The 01-A is a three-electrode storage battery tube for use as a detector and as an amplifier.

CHARACTERISTICS

FILAMENT VOLTAGE (D. C.).....	5.0	Volts
FILAMENT CURRENT.....	0.25	Ampere
PLATE VOLTAGE.....	90	135 <i>max.</i> Volts
GRID VOLTAGE.....	-4.5	-9 Volts
PLATE CURRENT.....	2.5	3.0 Milliampere
PLATE RESISTANCE.....	11000	10000 Ohms
AMPLIFICATION FACTOR.....	8	8
MUTUAL CONDUCTANCE.....	725	800 Micromhos
GRID-PLATE CAPACITANCE.....	8.1	$\mu\mu\text{f}$
GRID-FILAMENT CAPACITANCE.....	3.1	$\mu\mu\text{f}$
PLATE-FILAMENT CAPACITANCE.....	2.2	$\mu\mu\text{f}$
BULB (For dimensions, see Page 151, Fig. 11).....		ST-14
BASE (For socket connections, see Page 150, Fig. 1).....		Medium 4-Pin

INSTALLATION

The base pins of the 01-A fit the standard four-contact socket. The socket should be installed so that the tube will operate in a vertical position. Cushioning of the socket in the detector stage may be desirable if microphonic disturbances are encountered.

The **filament** in the 01-A is intended for operation from a 6-volt storage battery. A fixed or variable resistor of suitable value is required to reduce the battery voltage to 5.0 volts across the filament terminals at the socket. At this voltage, the most satisfactory operating performance will be obtained.

APPLICATION

As a **detector**, the 01-A may be operated either with grid leak and condenser or with grid bias. The recommended plate voltage for the former method is 45 volts. A grid leak of from 0.25 to 5 megohms used with a grid condenser of 0.00025 μf is suitable. The grid-circuit return should be connected to the positive filament terminal. For grid-bias detection, plate voltages up to the maximum value of 135 volts may be used with the corresponding negative grid-bias voltage (13.5 volts approximately, at 135 volts).

As an **amplifier**, the 01-A is applicable to the audio- or the radio-frequency stages of a receiver. Plate voltages and the corresponding grid voltages for audio amplifier service should be determined from the tabulated characteristics and the curves in order to obtain optimum performance and freedom from distortion. The higher plate voltages will be found advantageous under conditions where the impressed signal is large or where maximum voltage output is desired.

When the 01-A is used as a radio-frequency amplifier, little is gained from the use of plate voltages exceeding 90 volts. The 01-A is well adapted for use as an inter-stage audio-frequency amplifier but a power output tube is recommended for the final audio stage.

Volume control of the receiver may be accomplished by variation of either the grid bias or the plate voltage applied to the radio-frequency stages.

Average plate characteristics curves are given on page 55.



RCA Radiotron

**Cunningham
RADIO TUBES**

RCA-1-v

C-1-v

HALF-WAVE RECTIFIER

The 1-v is a half-wave, high-vacuum rectifier tube employing a heater cathode. It is intended for use in radio equipment of either the "universal" or the automobile type designed for its characteristics. The low voltage drop of this tube makes it uniquely adapted to such service. The 1-v is interchangeable with Type 1.

CHARACTERISTICS

HEATER VOLTAGE (A. C. or D. C.).....	6.3	Volts
HEATER CURRENT.....	0.3	Ampere
A-C PLATE VOLTAGE (RMS).....	350 max.	Volts
D-C OUTPUT CURRENT.....	50 max.	Milliamperes
BULB (For dimensions, see Page 151, Fig. 6).....		ST-12
BASE (For socket connections, see Page 150, Fig. 22).....		Small 4-Pin

INSTALLATION

The **base** pins of the 1-v fit the standard four-contact socket which may be mounted to hold the tube in any position.

Heater operation is similar to that for Type 6A7.

APPLICATION

The **filter** may be either of the condenser-input or the choke-input type provided the recommended maximum plate voltage and output current ratings given under CHARACTERISTICS are not exceeded. The d-c potential difference between heater and cathode should never exceed 500 volts.

If the condenser-input type of filter is used, consideration must be given to the instantaneous peak value of the a-c input voltage which, for a sinusoidal wave, is about 1.4 times the RMS value as measured with an a-c voltmeter. It is important, therefore, that the filter condensers (especially the input condenser) have a sufficiently high breakdown rating to withstand this instantaneous peak value. Particular attention must be given to this point when the wave-shape input to the plates of the rectifier tube is non-sinusoidal.

When the input-choke method is used, the available d-c output voltage will be somewhat lower than with the input-condenser method for a given a-c plate voltage. However, improved regulation together with lower peak current will be obtained.

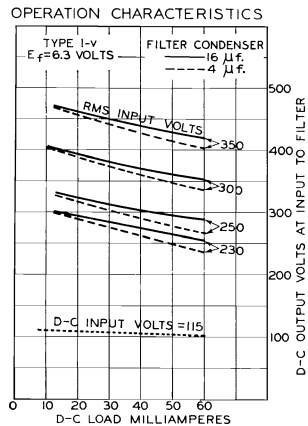



RCA-10

C-10

POWER AMPLIFIER, OSCILLATOR

The 10 is a three-electrode high-vacuum tube suitable for power amplifier use. As an audio-frequency amplifier, it is capable of delivering large undistorted output to the loudspeaker.

CHARACTERISTICS

FILAMENT VOLTAGE (A. C. or D. C.)	7.5	Volts
FILAMENT CURRENT	1.25	Amperes
PLATE VOLTAGE	250 350 425 max.	Volts
GRID VOLTAGE*	-22 -31 -39	Volts
PLATE CURRENT	10 16 18	Milliamperes
PLATE RESISTANCE	6000 5150 5000	Ohms
AMPLIFICATION FACTOR	8 8 8	
MUTUAL CONDUCTANCE	1330 1550 1600	Micromhos
LOAD RESISTANCE	13000 11000 10200	Ohms
UNDISTORTED POWER OUTPUT	0.4 0.9 1.6	Watts
GRID-PLATE CAPACITANCE	7	$\mu\mu\text{f}$
GRID-FILAMENT CAPACITANCE	4	$\mu\mu\text{f}$
PLATE-FILAMENT CAPACITANCE	3	$\mu\mu\text{f}$
BULB (For dimensions, see Page 151, Fig. 14)		S-17
BASE (For socket connections, see Page 150, Fig. 1)		Medium 4-Pin Bayonet

* Grid voltages are given with respect to the mid-point of filament operated on a.c. If d.c. is used, each stated value of grid voltage should be decreased by 3.75 volts and should be referred to the negative end of the filament.

INSTALLATION

The base pins of the 10 fit the standard four-contact socket. The socket should be installed so that the tube will operate in a vertical position with the base down.

The filament of the type 10 is usually operated from the a-c line through a step-down transformer. Most satisfactory operating performance of the tube will be obtained at the rated filament voltage.

With an a-c filament supply, the grid and the plate return should be brought either to a mid-tapped resistor of 20 to 40 ohms across the filament winding, or to a mid-tap on the filament winding itself. With a d-c filament supply, the grid and the plate return should be made to the negative filament terminal.

Grid bias for the type 10 may be obtained from a C-supply or by means of the voltage drop in a resistor connected in the negative plate-return lead. The latter method is known as the self-biasing method, since the plate current determines the drop. It is not, however, generally applicable to battery-operated receivers.

APPLICATION

As an audio power amplifier this tube should be operated under conditions as given under CHARACTERISTICS. To prevent overloading and distortion, the recommended grid bias should always be used. Average plate characteristics curves are given on the following page.

THE RCA RADIOTRON-CUNNINGHAM RADIO TUBE MANUAL

AVERAGE PLATE CHARACTERISTICS

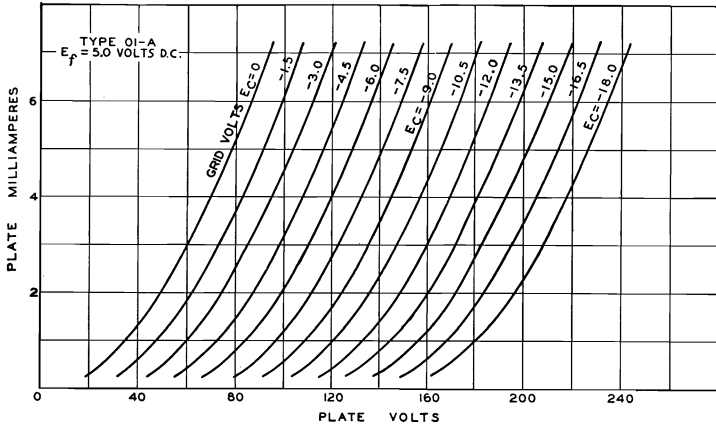

AVERAGE PLATE CHARACTERISTICS

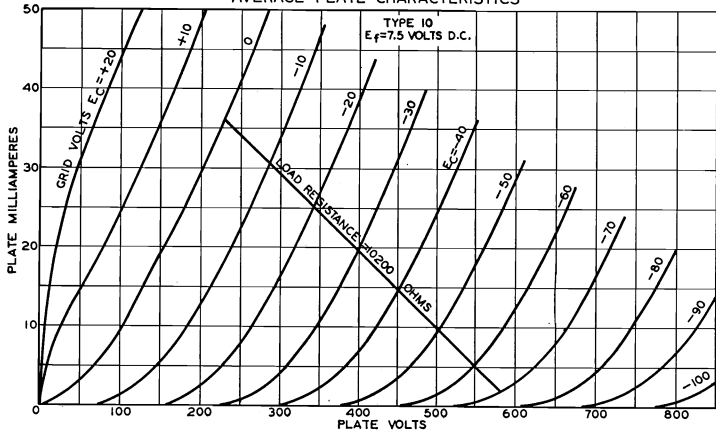

AVERAGE PLATE CHARACTERISTICS

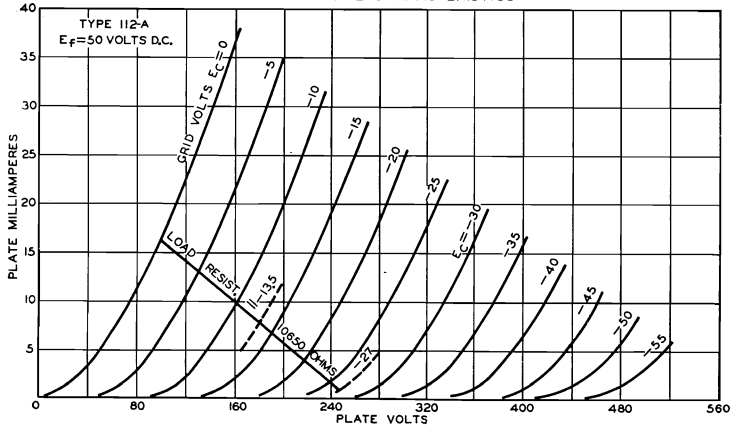

RCA Radiotron

**Cunningham
RADIO TUBES**



UX-112-A

CX-112-A

DETECTOR, AMPLIFIER

The 112-A is an improved storage battery tube. It is sensitive as a detector and excellent as a three-electrode radio-frequency and audio-frequency amplifier.

CHARACTERISTICS

FILAMENT VOLTAGE (D. C.).....		5.0		Volts
FILAMENT CURRENT.....		0.25		Ampere
PLATE VOLTAGE.....	90	135	180 <i>max.</i>	Volts
GRID VOLTAGE.....	-4.5	-9	-13.5	Volts
PLATE CURRENT.....	5.0	6.2	7.7	Milliamperes
PLATE RESISTANCE.....	5400	5100	4700	Ohms
AMPLIFICATION FACTOR.....	8.5	8.5	8.5	
MUTUAL CONDUCTANCE.....	1575	1650	1800	Micromhos
LOAD RESISTANCE.....	5000	9000	10650	Ohms
UNDISTORTED POWER OUTPUT.....	0.035	0.13	0.285	Watts
GRID-PLATE CAPACITANCE.....		8.5		$\mu\mu\text{f}$
GRID-FILAMENT CAPACITANCE.....		4.0		$\mu\mu\text{f}$
PLATE-FILAMENT CAPACITANCE.....		2.0		$\mu\mu\text{f}$
BULB (For dimensions, see Page 151, Fig. 9).....				S-14
BASE (For socket connections, see Page 150, Fig. 1).....				Medium 4-Pin

INSTALLATION

The **base** pins of the 112-A fit the standard four-contact socket. The socket should be installed so that the tube will operate in a vertical position. Cushioning of the socket in the detector stage may be desirable if microphonic disturbances are encountered.

The coated **filament** employed in the 112-A may be operated conveniently from a 6-volt storage battery. A fixed or variable resistor of suitable value is required to reduce the battery voltage to 5.0 volts across the filament terminals at the socket.

APPLICATION

As a **detector**, the 112-A may be operated either with grid leak and condenser or with grid bias. The recommended plate voltage for the former method is 45 volts. A grid leak of from 0.25 to 5 megohms used with a grid condenser of 0.00025 μf is suitable. The grid-circuit return should be connected to the positive filament terminal. For grid-bias detection, plate voltages up to the maximum value of 180 volts may be used. The corresponding grid bias should be adjusted so that the plate current, when no signal is being received, is about 0.2 milliampere. Usually, a plate voltage of 135 volts with a grid bias of approximately -15 volts will be satisfactory.

As an **amplifier**, the 112-A should be operated as shown under CHARACTERISTICS. Average plate characteristics curves are shown on the preceding page. When the 112-A is used as a radio-frequency amplifier, little is gained from plate voltages exceeding 90 volts. If the 112-A is substituted for the 01-A in radio-frequency circuits, it may be necessary to readjust the neutralizing condensers or to increase the value of the grid suppressor resistors to prevent oscillation.

Volume control of the receiver may be accomplished by variation of either the grid bias or the plate voltage applied to the radio-frequency stages.



RCA Radiotron

Cunningham
RADIO TUBES

RCA-19

C-19

CLASS B TWIN AMPLIFIER

The 19 combines in one bulb two high- μ triodes designed for Class B operation. It is intended for use in the output stage of battery-operated receivers and is capable of supplying approximately 2 watts of audio power. The triode units have separate external terminals for all electrodes except the filaments, so that circuit design is similar to that of Class B amplifiers utilizing individual tubes in the output stage.

CHARACTERISTICS

FILAMENT VOLTAGE (D. C.).....	2.0	Volts
FILAMENT CURRENT	0.26	Ampere
BULB (For dimensions, see Page 151, Fig. 6).....		ST-12
BASE (For socket connections, see Page 150, Fig. 25).....		Small 6-Pin

As Class B Power Amplifier

PLATE VOLTAGE.....	135 <i>max.</i>	Volts
DYNAMIC PEAK PLATE CURRENT (Per plate).....	50 <i>max.</i>	Milliamperes

TYPICAL OPERATION

Filament Voltage.....			2.0	Volts
Plate Voltage.....	135	135	135	Volts
Grid Voltage.....	-6	-3	0	Volts
Static Plate Current.....	1	4	10	Milliamperes
Load Resistance (Plate-to-plate)	10000	10000	10000	Ohms
Average Power Input*.....	95	130	170 <i>approx.</i>	Milliwatts
Nominal Power Output.....	1.6	1.9	2.1	Watts

* Applied between grids to give indicated values of power output.

INSTALLATION

The **base** pins of the 19 fit the standard six-contact socket. The socket should be installed so that the tube will operate in a vertical position. In some cases, cushioning of the socket may be found desirable.

For **filament** operation, refer to INSTALLATION for Type 1A6.

APPLICATION

As a **Class B power amplifier** in the output stage of battery-operated receivers, the 19 should be operated as shown under CHARACTERISTICS. In such service, it may be operated either with zero grid bias or with negative grid bias. The latter method may be of advantage in cases where plate-battery drain must be conserved even at some sacrifice in power output.

The type of driver tube chosen to precede the 19 should be capable of handling enough power to operate the Class B amplifier stage. Allowance should be made for

THE RCA RADIOTRON-CUNNINGHAM RADIO TUBE MANUAL

transformer efficiency. It is most important, if low distortion is desired, that the driver tube be worked well below its Class A undistorted output rating, since distortion produced by the driver stage and the power stage will be present in the output. A discussion of Class B amplifier features is given on page 14.

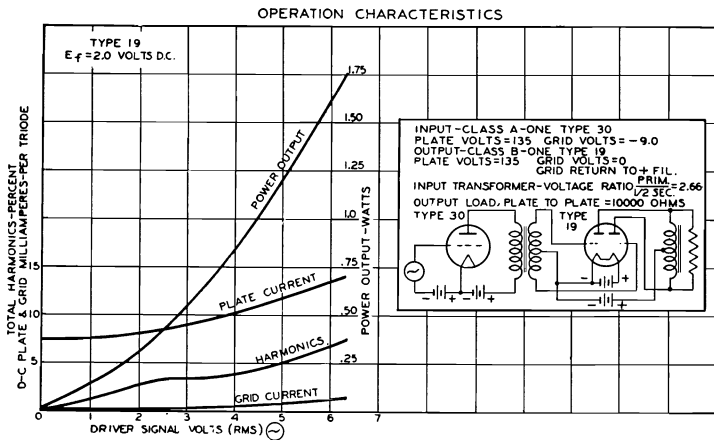
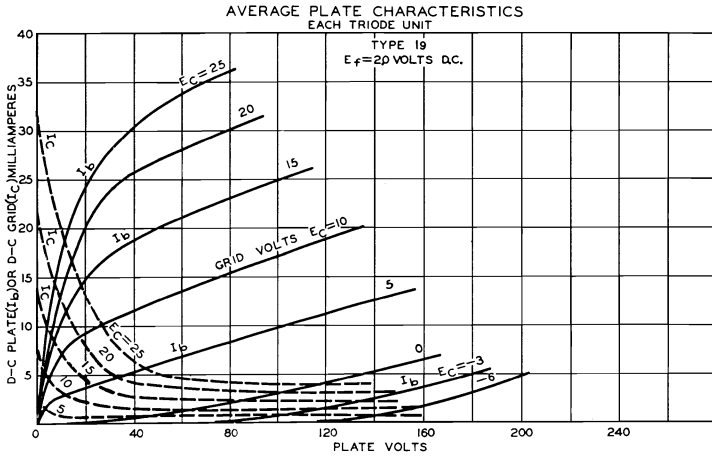



UX-120

CX-220

POWER AMPLIFIER

The '20 is a three-electrode, high-vacuum, power amplifier tube designed for operation from dry-cells. It is intended for use in the last audio stage of dry-battery-operated receivers using the '99 and/or 22.

CHARACTERISTICS

FILAMENT VOLTAGE (D. C.).....	3.0-3.3	Volts
FILAMENT CURRENT.....	0.125-0.132	Ampere
PLATE VOLTAGE.....	90 135 <i>max.</i>	Volts
GRID VOLTAGE.....	-16.5 -22.5	Volts
PLATE CURRENT.....	3.0 6.5	Milliamperes
PLATE RESISTANCE.....	8000 6300	Ohms
AMPLIFICATION FACTOR.....	3.3 3.3	
MUTUAL CONDUCTANCE.....	415 525	Micromhos
LOAD RESISTANCE.....	9600 6500	Ohms
UNDISTORTED POWER OUTPUT.....	0.045 0.11	Watts
GRID-PLATE CAPACITANCE.....	4.1	$\mu\mu\text{f}$
GRID-FILAMENT CAPACITANCE.....	2.0	$\mu\mu\text{f}$
PLATE-FILAMENT CAPACITANCE.....	2.3	$\mu\mu\text{f}$
BULB (For dimensions, see Page 151, Fig. 1).....		T-8
BASE (For socket connections, see Page 150, Fig. 1).....		Small 4-Pin

INSTALLATION

The **base** pins of the '20 fit the standard four-contact socket. The socket should be installed to operate the tube in a vertical position.

The **filament** in this tube is designed for operation with three No. 6 dry-cells connected in series. In multi-tube receivers the use of six or nine No. 6 dry-cells connected in series-parallel to give 4.5 volts will decrease the current drain per cell and give a more stable source of filament power. If storage-battery operation is preferred, a four-volt storage battery may be used. In any case, a filament rheostat should be provided to maintain the voltage applied to the filament within the stated range.

APPLICATION

For **power amplifier** service, the '20 will give greatest power output when operated at a plate voltage of 135 volts and the corresponding grid bias of -22.5 volts. At 90 volts on the plate and with a corresponding grid bias of -16.5 volts, good quality of reproduction may be obtained at a lower level of power output.

In receivers employing tubes of the 3.3-volt filament type, the use of the '20 in the output stage will be found desirable.



RCA Radiotron

**Cunningham
RADIO TUBES**

RCA-22

C-22

SCREEN GRID RADIO-FREQUENCY
AMPLIFIER

The 22 is a screen grid tube designed particularly for radio-frequency amplification in dry-battery-operated receivers employing 3.3-volt filament tubes.

CHARACTERISTICS

FILAMENT VOLTAGE (D. C.).....	3.3		Volts
FILAMENT CURRENT.....	0.132		Ampere
PLATE VOLTAGE.....	135	135 <i>max.</i>	Volts
SCREEN VOLTAGE.....	45*	67.5 <i>max.**</i>	Volts
GRID VOLTAGE.....	-1.5	-1.5	Volts
PLATE CURRENT.....	1.7	3.7	Milliamperes
SCREEN CURRENT.....	0.6	1.3	<i>max.</i> Milliamperes
PLATE RESISTANCE.....	725000	325000	Ohms
AMPLIFICATION FACTOR.....	270	160	
MUTUAL CONDUCTANCE.....	375	500	Micromhos
GRID-PLATE CAPACITANCE (With shield-can)	0.02	<i>max.</i>	$\mu\mu\text{f}$
INPUT CAPACITANCE.....	3		$\mu\mu\text{f}$
OUTPUT CAPACITANCE.....	12		$\mu\mu\text{f}$
BULB (For dimensions, see Page 151, Fig. 10)			S-14
CAP.....			Small Metal
BASE (For socket connections, see Page 150, Fig. 4)			Medium 4-Pin

* Maximum value of grid resistor is 5.0 megohms.

** Maximum value of grid resistor is 1.0 megohm.

INSTALLATION

The **base** pins of the 22 fit the standard four-contact socket. The socket should be installed to hold the tube in a vertical position. Cushioning of the socket may be desirable to avoid microphonic disturbances.

For **filament** operation, refer to INSTALLATION for type '20.

APPLICATION

As a **radio-frequency amplifier** in multi-stage circuits, it is necessary to shield carefully each stage and to include within the stage shield all of the component parts of that stage. Unless this is done, the amplification possibilities of the 22 cannot be realized.

As an **audio-frequency amplifier**, this tube may be operated with either the screen-grid or space-charge-grid connection. In either case, the value of plate-coupling resistor should be of from 100000 to 250000 ohms. With the screen-grid arrangement, a plate-supply voltage of 135 to 180 volts applied through the coupling resistor is recommended. Under these conditions, a screen voltage of 22.5 volts and a negative grid voltage of 0.75 to 1.5 volts are suitable. For the space-charge-grid connection, the inner grid is operated at 22.5 volts, while the outer grid becomes the control grid and is biased negatively by from 0 to 1.5 volts, depending upon conditions of operation.



RCA Radiotron

Cunningham
RADIO TUBES

RCA-24-A

C-24-A

SCREEN GRID RADIO-FREQUENCY
AMPLIFIER

The 24-A is a screen grid amplifier tube containing a 2.5-volt uni-potential heater-cathode which permits operation from alternating current. This tube is recommended for use primarily as a radio-frequency amplifier in carefully shielded circuits especially designed for it. The 24-A may also be used as a screen-grid detector or audio amplifier.

CHARACTERISTICS

HEATER VOLTAGE (A. C. or D. C.).....	2.5	Volts
HEATER CURRENT.....	1.75	Amperes
PLATE VOLTAGE*.....	180	250
GRID VOLTAGE.....	-3	-3
SCREEN VOLTAGE.....	90	90 <i>max.</i>
PLATE CURRENT.....	4	4
SCREEN CURRENT.....	1.7	1.7 <i>max.</i>
PLATE RESISTANCE.....	400000	600000
AMPLIFICATION FACTOR.....	400	630
MUTUAL CONDUCTANCE.....	1000	1050
GRID-PLATE CAPACITANCE (With shield-can)	0.007 <i>max.</i>	$\mu\mu\text{f}$
INPUT CAPACITANCE.....	5.3	$\mu\mu\text{f}$
OUTPUT CAPACITANCE.....	10.5	$\mu\mu\text{f}$
BULB (For dimensions, see Page 151, Fig. 12)		ST-14
CAP.....		Small Metal
BASE (For socket connections, see Page 150, Fig. 9)		Medium 5-Pin

* Maximum plate voltage = 275 volts.

INSTALLATION

The **base** pins of the 24-A fit the standard five-contact socket. The socket may be installed to operate the tube in any position.

The **heater** of the 24-A is intended for operation from a 2.5-volt winding of the power transformer. The voltage applied to the heater terminals should be the rated value of 2.5 volts under conditions of operating load and average line voltage.

The **cathode connection** to the heater should be made (1) to the movable arm of a potentiometer connected across the heater winding of the power transformer, or (2) to a mid-tapped resistor across the heater winding, or (3) to the mid-point of the heater winding itself. Recommended practice is to have no voltage difference between heater and cathode. If this practice is not followed, the potential difference between heater and cathode should be kept as low as possible.

The positive **screen voltage** for the 24-A may be obtained from a fixed or variable tap on a voltage divider across the high-voltage supply, or across a portion of the supply.

Complete **shielding** in all stages of the circuit is necessary if maximum gain per stage is to be obtained.

APPLICATION

As a **radio-frequency amplifier**, the 24-A should be operated at the voltages given under CHARACTERISTICS. Plate voltage and screen voltage are not critical. In general, properly designed radio-frequency transformers are preferable to inter-stage coupling impedances, especially in cases where a high impedance B-supply may cause oscillation below radio frequencies.

As a **detector**, the 24-A may be operated either with grid leak and condenser or with grid bias (see page 18). For grid-bias detection, suitable operating conditions are: Plate-supply voltage of 275 volts applied through a plate-coupling resistor of 250000 ohms, a positive screen voltage of 20 to 45 volts, and a negative grid bias (approximately 5 volts) so adjusted that a plate current of 0.1 milliampere is obtained with no input signal. For grid leak and condenser detection, suitable operating conditions are: Plate-supply voltage of 275 volts applied through a plate-coupling resistor of 250000 ohms, a positive screen voltage of 20 to 45 volts, a grid leak of 2 to 5 megohms, and a grid condenser of 0.00025 μf .

As a screen grid **audio-frequency amplifier** in resistance-coupled circuits, the 24-A may be operated under the following conditions: Plate-supply voltage of 250 volts, a negative grid bias of 1.0 volt, a positive screen voltage of 25 volts, a plate current of 0.5 milliampere (approximate), a plate load resistor of 0.1 to 0.25 megohm, and a grid resistor of 0.25 to 2.0 megohms.

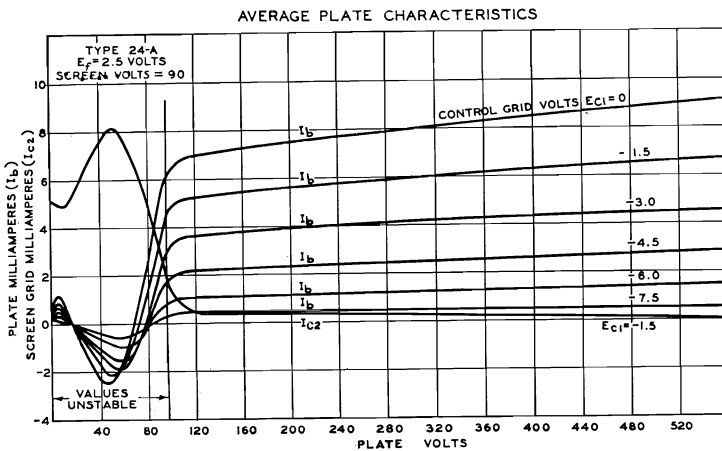



RCA Radiotron

Cunningham
RADIO TUBES

RCA-26

C-26

AMPLIFIER

The 26 is an amplifier tube containing a filament designed for operation on alternating current. It is useful as a radio-frequency amplifier and as a transformer-coupled audio-frequency amplifier. The 26 is not ordinarily suitable for use as a detector or power output tube.

CHARACTERISTICS

FILAMENT VOLTAGE (A. C. or D. C.).....	1.5			Volts
FILAMENT CURRENT.....	1.05			Amperes
PLATE VOLTAGE.....	90	135	180 <i>max.</i>	Volts
GRID VOLTAGE*.....	-7	-10	-14.5	Volts
PLATE CURRENT.....	2.9	5.5	6.2	Milliamperes
PLATE RESISTANCE.....	8900	7600	7300	Ohms
AMPLIFICATION FACTOR.....	8.3	8.3	8.3	
MUTUAL CONDUCTANCE.....	935	1100	1150	Micromhos
GRID-PLATE CAPACITANCE.....		8.1		$\mu\mu\text{f}$
GRID-FILAMENT CAPACITANCE.....		3.5		$\mu\mu\text{f}$
PLATE-FILAMENT CAPACITANCE.....		2.2		$\mu\mu\text{f}$
BULB (For dimensions, see Page 151, Fig. 11).....				ST-14
BASE (For socket connections, see Page 150, Fig. 1).....				Medium 4-Pin

* Grid voltage measured from mid-point of a-c operated filament.

INSTALLATION

The **base** pins of the 26 fit the standard four-contact socket. The socket should be installed so that the tube will operate in a vertical position.

The coated **filament** of the 26 should be operated at the rated voltage of 1.5 volts from the a-c line through a step-down transformer. For certain applications, it may be operated from a d-c filament power source.

When the filament is a-c operated, the plate and grid return lead should be brought (1) to the movable arm of a 20 to 40 ohm potentiometer across the filament winding, or (2) to the mid-tap of the filament winding itself. When d.c. is used to operate the filament, the grid and plate returns should be connected to the negative filament terminal.

APPLICATION

As an **audio-frequency amplifier**, the 26 should be used with transformer coupling in order to secure the greatest amplification per stage.

As a **radio-frequency amplifier**, the 26 may be operated at plate voltages as low as 90 volts with good results.

THE RCA RADIOTRON-CUNNINGHAM RADIO TUBE MANUAL

AVERAGE PLATE CHARACTERISTICS

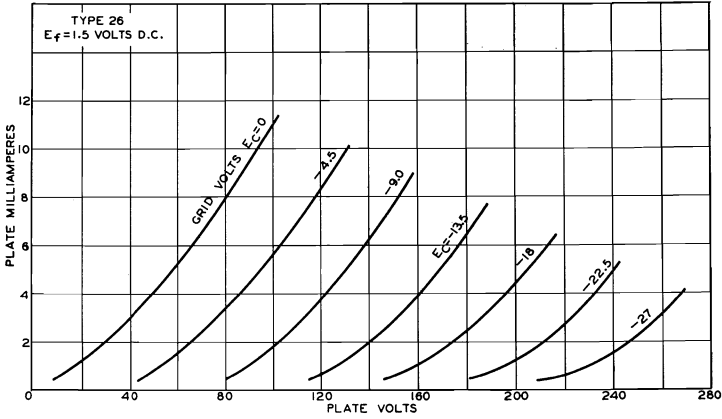

AVERAGE PLATE CHARACTERISTICS

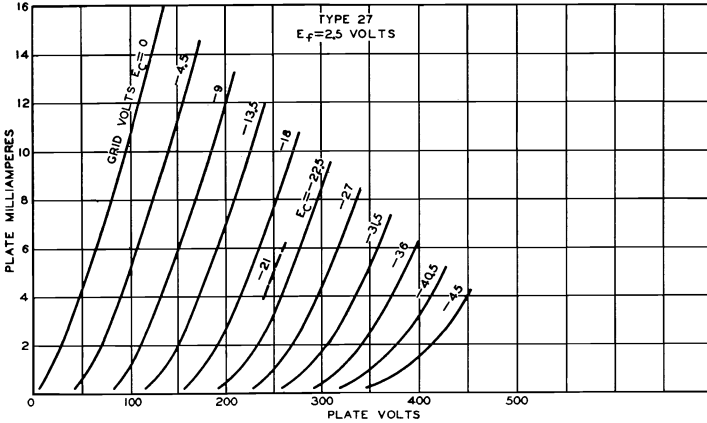

AVERAGE PLATE CHARACTERISTICS

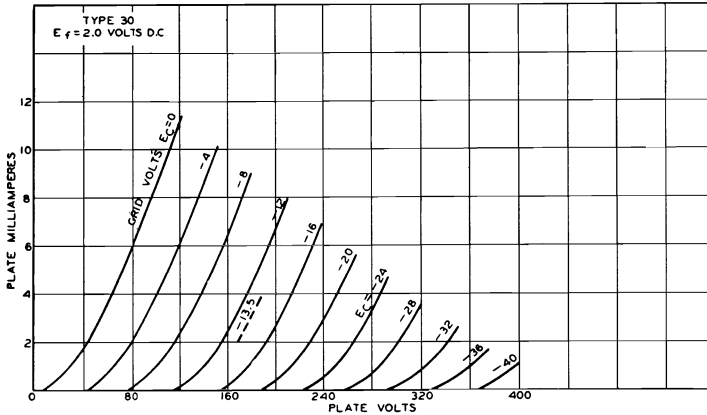

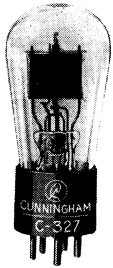

RCA Radiotron

Cunningham
RADIO TUBES

RCA-27

C-27

DETECTOR, AMPLIFIER

The 27 is a three-electrode general purpose tube containing a 2.5-volt heater-cathode of the equi-potential type which permits operation from alternating current.

CHARACTERISTICS

HEATER VOLTAGE (A. C. or D. C.).....		2.5				Volts
HEATER CURRENT.....					1.75	Amperes
PLATE VOLTAGE*.....	90	135	180	250		Volts
GRID VOLTAGE.....	-6	-9	-13.5	-21		Volts
PLATE CURRENT.....	2.7	4.5	5.0	5.2		Milliamperes
PLATE RESISTANCE.....	11000	9000	9000	9250		Ohms
AMPLIFICATION FACTOR.....	9	9	9	9		
MUTUAL CONDUCTANCE.....	820	1000	1000	975		Micromhos
GRID-PLATE CAPACITANCE....				3.3		$\mu\mu\text{f}$
GRID-CATHODE CAPACITANCE.				3.5		$\mu\mu\text{f}$
PLATE-CATHODE CAPACITANCE				3.0		$\mu\mu\text{f}$
BULB (For dimensions, see Page 151, Fig. 9).....						S-14
BASE (For socket connections, see Page 150, Fig. 8).....						Medium 5-Pin

* Maximum plate voltage = 275 volts.

INSTALLATION

The **base** pins of the 27 fit the standard five-contact socket. The socket may be mounted to hold the tube in any position.

The **heater** of the 27 is intended for operation from a 2.5-volt winding of the power transformer. The voltage applied to the heater terminals should be the rated value of 2.5 volts under conditions of operation and average line voltage.

The **cathode connection** to the heater should be made (1) to the movable arm of a potentiometer connected across the heater winding of the power transformer, or (2) to a mid-tapped resistor across the heater winding, or (3) to the mid-point of the heater winding itself. Recommended practice is to have no potential difference between heater and cathode. If this practice is not followed, the potential difference should be kept as low as possible.

APPLICATION

As an **amplifier**, the 27 is applicable to the audio- or the radio-frequency stages of a receiver. Recommended plate and grid voltages are shown under CHARACTERISTICS. A plate family for this type is given on the preceding page.

As a **detector**, the 27 may be operated either with grid leak and condenser or with grid bias. The recommended plate voltage for grid leak and condenser detection is 45 volts (see page 18). A grid leak of from 1 to 5 megohms used with a grid condenser of 0.00025 μf is suitable. For grid-bias detection, a plate voltage of 250 volts or less may be used. The corresponding grid bias should be adjusted so that the plate current, when no signal is being received, is approximately 0.2 milliamperes. For the condition of 250 volts on plate and transformer coupling, the grid bias will be approximately -30 volts.



RCA Radiotron

**Cunningham
RADIO TUBES**

RCA-30

C-30

DETECTOR, AMPLIFIER

The 30 is a detector and amplifier tube of the three-electrode type. It has a coated filament which takes as little power as possible consistent with satisfactory operating performance. This feature makes the 30 particularly suitable in battery-operated radio receivers where economy of filament-current drain is important.

CHARACTERISTICS

FILAMENT VOLTAGE (D. C.)	2.0			Volts
FILAMENT CURRENT	0.060			Ampere
PLATE VOLTAGE	90	135	180	Volts <i>max.</i>
GRID VOLTAGE	-4.5	-9	-13.5	Volts
PLATE CURRENT	2.5	3.0	3.1	Milliamperes
PLATE RESISTANCE	11000	10300	10300	Ohms
AMPLIFICATION FACTOR	9.3	9.3	9.3	
MUTUAL CONDUCTANCE	850	900	900	Micromhos
GRID-PLATE CAPACITANCE	6.0			$\mu\mu\text{f}$
GRID-FILAMENT CAPACITANCE	3.7			$\mu\mu\text{f}$
PLATE-FILAMENT CAPACITANCE	2.1			$\mu\mu\text{f}$
BULB (For dimensions, see Page 151, Fig. 6)				ST-12
BASE (For socket connections, see Page 150, Fig. 1)				Small 4-Pin

INSTALLATION

The **base** pins of the 30 fit the standard four-contact socket. The socket should be installed so that the tube will operate in a vertical position. Cushioning of the socket in the detector stage may be desirable if microphonic disturbances are encountered.

The coated **filament** of the 30 may be operated conveniently from dry-cells, from a single lead storage-cell, or from an air-cell battery. For dry-cell operation, a filament rheostat may be used together with a permanently installed voltmeter to insure the proper filament voltage. For operation from a 2-volt lead storage-cell, the 30 requires no filament resistor. Operation with an air-cell battery requires a fixed resistor in the filament circuit. This resistor should have a value such that with a new air-cell battery, the voltage applied across the filament terminals will not initially exceed 2.15 volts. Socket terminal No. 3 (see socket connections) should be connected to the positive battery terminal. *Series operation of the filaments of these tubes is not recommended.*

APPLICATION

As a **detector**, the 30 may be operated either with grid leak and condenser or with grid-bias. The plate voltage for the former method should preferably not be more than 45 volts. A grid leak of from 1 to 5 megohms used with a grid condenser of 0.00025 μf is satisfactory. The grid return should be connected to the positive filament socket terminal. For grid-bias detection, plate voltages up to the maximum value of 180 volts may be used. The corresponding grid-bias should be adjusted so that the plate current is about 0.2 milliamperes when no signal is being received.

As an **amplifier**, the 30 is applicable to the audio- and the radio-frequency stages of a receiver. Plate voltages and the corresponding grid voltages should be determined from the CHARACTERISTICS and the curves in order to obtain optimum performance and freedom from distortion. The plate family for this type is given on page 64.



RCA Radiotron

**Cunningham
RADIO TUBES**

RCA-31

C-31

POWER AMPLIFIER

The 31 is a power amplifier tube of the three-electrode type. It has a coated filament which takes as little power as possible consistent with satisfactory operating performance. This feature makes the 31 particularly suitable in battery-operated radio receivers where economy of filament-current drain is important.

CHARACTERISTICS

FILAMENT VOLTAGE (D. C.).....	2.0	Volts
FILAMENT CURRENT.....	0.130	Ampere
PLATE VOLTAGE.....	135 180 <i>max.</i>	Volts
GRID VOLTAGE.....	-22.5 -30	Volts
PLATE CURRENT.....	8.0 12.3	Milliamperes
PLATE RESISTANCE.....	4100 3600	Ohms
AMPLIFICATION FACTOR.....	3.8 3.8	
MUTUAL CONDUCTANCE.....	925 1050	Micromhos
LOAD RESISTANCE.....	7000 5700	Ohms
UNDISTORTED POWER OUTPUT.....	0.185 0.375	Watt
BULB (For dimensions, see Page 151, Fig. 6).....		ST-12
BASE (For socket connections, see Page 150, Fig. 1).....		Small 4-Pin

INSTALLATION

Refer to INSTALLATION on Type 30.

APPLICATION

As a **power amplifier**, the 31 should be operated as shown under CHARACTERISTICS. Grid voltage for the 31 may be obtained from a C-battery, or by use of the voltage drop in a resistor connected in the negative plate-return lead. The latter method is known as the self-biasing method and is required where a grid resistor (maximum value 1 megohm) is used. If more output is desired than can be obtained from a single 31, two 31's may be operated either in parallel or push-pull connection.

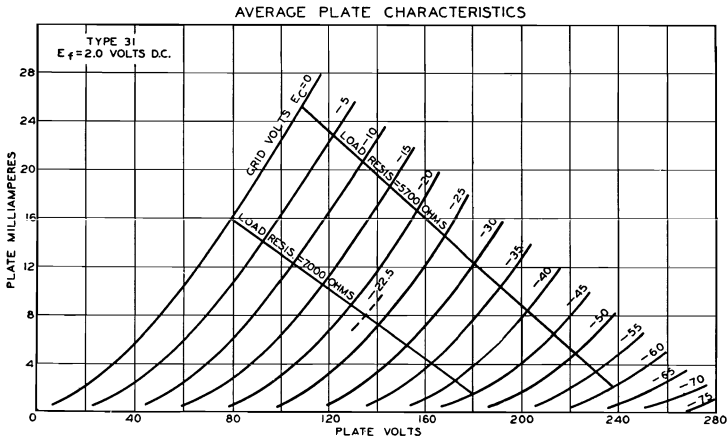

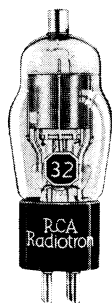

RCA-32

C-32

RADIO-FREQUENCY AMPLIFIER

The 32 is a screen grid tube recommended primarily for use as a radio-frequency amplifier. It contains a coated filament which takes as little power as possible consistent with satisfactory operating performance. This feature makes the 32 particularly suitable in battery-operated radio receivers where economy of filament-current drain is important.

CHARACTERISTICS

FILAMENT VOLTAGE (D. C.).....	2.0	Volts
FILAMENT CURRENT.....	0.060	Ampere
PLATE VOLTAGE.....	135	180 <i>max.</i> Volts
SCREEN VOLTAGE.....	67.5	67.5 <i>max.</i> Volts
GRID VOLTAGE.....	-3	-3 Volts
PLATE CURRENT.....	1.7	1.7 Milliampere
SCREEN CURRENT.....	0.4	0.4 <i>max.</i> Milliampere
PLATE RESISTANCE.....	950000	1200000 Ohms
AMPLIFICATION FACTOR.....	610	780
MUTUAL CONDUCTANCE.....	640	650 Micromhos
GRID-PLATE CAPACITANCE (With shield-can).....	0.015 <i>max.</i>	$\mu\mu\text{f}$
INPUT CAPACITANCE.....	6.0	$\mu\mu\text{f}$
OUTPUT CAPACITANCE.....	11.7	$\mu\mu\text{f}$
BULB (For dimensions, see Page 151, Fig. 12).....		ST-14
CAP.....		Small Metal
BASE (For socket connections, see Page 150, Fig. 4).....		Medium 4-Pin

INSTALLATION

For **socket** mounting and **filament** operation, refer to INSTALLATION for Type 30.

The positive **screen voltage** may be obtained from a tap on the plate battery or a bleeder circuit across the supply battery in part or in full. Never attempt to obtain the screen voltage for the 32 by connecting the screen through a series resistor to a high-voltage source. The results will not be satisfactory because of voltage-drop variation produced by the different screen currents of individual tubes.

Volume control may be effected by variation of the screen voltage between 0 and 67.5 volts. The variation must, however, be made by a potentiometer shunted across the screen-voltage supply and not by a high-resistance rheostat.

Complete **shielding** of all stages is recommended if maximum gain per stage is to be obtained.

APPLICATION

As a **radio-frequency amplifier**, the 32 is operated as shown under CHARACTERISTICS. Neither the plate voltage nor the screen voltage is critical. In general, properly designed radio-frequency transformers are preferable to interstage coupling impedances, especially in cases where a high impedance B-supply may cause oscillation below radio frequencies.

THE RCA RADOTRON-CUNNINGHAM RADIO TUBE MANUAL

As a **detector**, the 32 may be operated either with grid leak and condenser or with grid bias. For grid-bias detection, suitable operating conditions are: Plate-supply voltage, 135 volts applied through a plate-coupling resistance of 100000 ohms or an equivalent impedance; positive screen voltage, 67.5 volts; and a negative grid bias (approximately 6 volts) so adjusted that a plate current of 0.2 milliampere is obtained with no input signal. For grid leak and condenser detection, suitable operating conditions are: Plate-supply voltage, 135 volts applied through a plate-coupling resistor of 250000 ohms; a positive screen voltage up to 45 volts; a grid condenser of 0.00025 μ f; and a grid leak of 1 to 5 megohms.

In designing circuits to use the 32 as a detector, it is desirable to work from the detector stage directly into the power-output stage.

As an **audio-frequency amplifier** in resistance-coupled circuits, the 32 may be operated under the following conditions: Plate-supply voltage, 180 volts applied through a plate-coupling resistor of 100000 to 250000 ohms (or a 500-henry choke shunted by a 0.25 megohm resistor); plate current, 0.25 milliampere (approximate); grid voltage, -1 volt; and a grid resistor, 0.25 to 2.0 megohms.

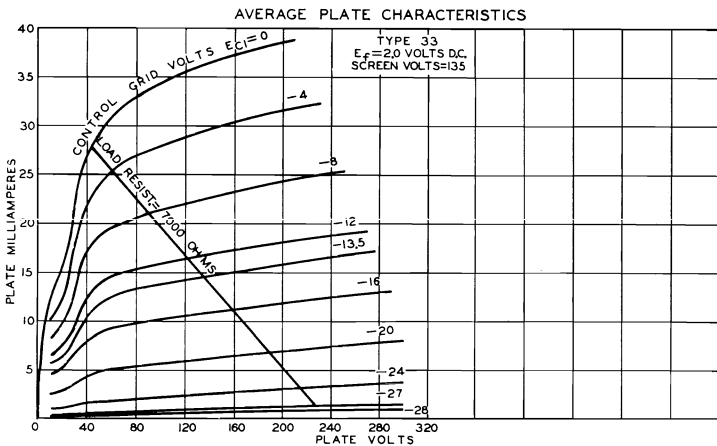
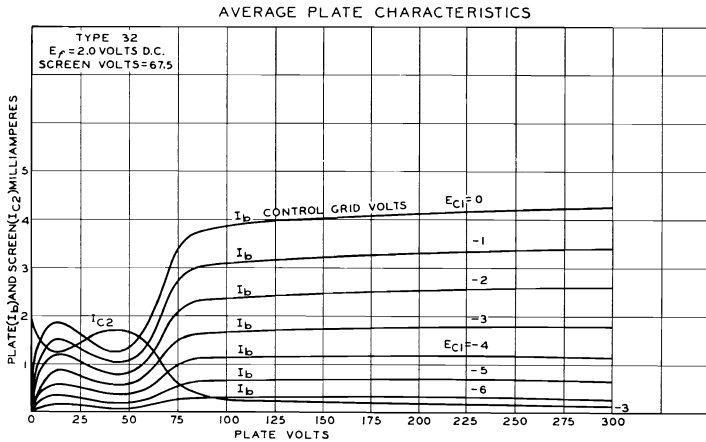

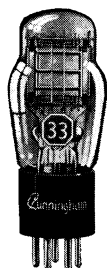

RCA Radiotron

**Cunningham
RADIO TUBES**

RCA-33

C-33

POWER AMPLIFIER PENTODE

The 33 is a power amplifier pentode for use in the output stage of battery-operated receivers. The low filament current required by the 33 makes this tube particularly applicable for use in radio sets where economy of battery consumption is important.

The 33 is capable of producing greater power output than three-electrode power amplifiers of the same plate-current drain. Furthermore, this tube has the design feature of greater amplification than is possible in a three-electrode amplifier tube without serious sacrifice in power output.

CHARACTERISTICS

FILAMENT VOLTAGE (D. C.)	2.0	Volts
FILAMENT CURRENT	0.260	Ampere
PLATE VOLTAGE	135 <i>max.</i>	Volts
SCREEN VOLTAGE	135 <i>max.</i>	Volts
GRID VOLTAGE	-13.5	Volts
PLATE CURRENT	14.5	Milliamperes
SCREEN CURRENT	3	Milliamperes
PLATE RESISTANCE	50000	Ohms
AMPLIFICATION FACTOR	70	
MUTUAL CONDUCTANCE	1450	Micromhos
LOAD RESISTANCE	7000	Ohms
POWER OUTPUT	0.7	Watt
BULB (For dimensions, see Page 151, Fig. 11)		ST-14
BASE (For socket connections, see Page 150, Fig. 6)		Medium 5-Pin

INSTALLATION

The **base** pins of the 33 fit the standard five-contact socket. The socket should be installed so that the tube will operate in a vertical position. In some cases, cushioning of the socket may be found desirable.

For **filament** operation, refer to INSTALLATION for Type 30.

APPLICATION

For the **power amplifier** stage of radio receivers, the 33 is recommended either singly or in push-pull combination. More than one audio stage preceding the 33 is undesirable because of the possibility of microphonic disturbances resulting from the high level of amplification. If a single 33 is operated self-biased, the self-biasing resistor should be approximately 770 ohms. This resistor should be shunted by a suitable filter network to avoid degenerative effects at low audio frequencies. The use of two 33's in push-pull eliminates the necessity for the network. The self-biasing resistor required for the push-pull stage is approximately 385 ohms. Transformer or impedance coupling devices are preferable. If resistance coupling is employed, the grid resistor should not exceed a value of more than 1.0 megohm under self-bias conditions; without self-bias, maximum value is 0.5 megohm.

An **output transformer** should be used to couple this tube to the winding of the reproducing unit. The optimum load resistance for the output device is 7000 ohms. For best results, the impedance in the plate circuit of the 33 should be as uniform as possible over the entire audio-frequency range.

The plate family of curves is given on the preceding page.



RCA-34

C-34

SUPER-CONTROL R-F AMPLIFIER PENTODE

The 34 is a super-control pentode recommended for use primarily as a radio-frequency amplifier and intermediate-frequency amplifier in battery-operated receivers where economy of filament-current drain is important.

The 34 is very effective in reducing cross-modulation and modulation-distortion over the usual range of signal voltages without the use of antenna potentiometers or auxiliary volume-control switches. (See Super-Control amplifier page 11.) This super-control characteristic makes the tube uniquely adaptable to the r-f and i-f stages of receivers employing automatic volume control.

CHARACTERISTICS

FILAMENT VOLTAGE (D. C.).....	2.0	Volts
FILAMENT CURRENT.....	0.060	Ampere
PLATE VOLTAGE.....	67.5** 135	180 <i>max.</i> Volts
SCREEN VOLTAGE (Maximum*)....	67.5 67.5	67.5 Volts
GRID VOLTAGE, Variable (Min.)....	-3 -3	-3 Volts
PLATE CURRENT.....	2.7 2.8	2.8 Milliamperes
SCREEN CURRENT.....	1.1 1.0	1.0 Milliamperes
PLATE RESISTANCE.....	0.4 0.6	1.0 Megohm
AMPLIFICATION FACTOR.....	224 360	620
MUTUAL CONDUCTANCE.....	560 600	620 Micromhos
MUTUAL CONDUCTANCE (At -22.5 volts bias).....	15 15	15 Micromhos
GRID-PLATE CAPACITANCE (With shield-can).....	0.015 <i>max.</i>	$\mu\mu\text{f}$
INPUT CAPACITANCE.....	6.0	$\mu\mu\text{f}$
OUTPUT CAPACITANCE.....	12.6	$\mu\mu\text{f}$
BULB (For dimensions, see Page 151, Fig. 12).....		ST-14
CAP.....		Small Metal
BASE (For socket connections, see Page 150, Fig. 4A).....		Medium 4-Pin

* Under conditions of maximum plate current. ** Recommended values for use in portable receivers.

INSTALLATION

The **base** pins of the 34 fit the standard four-contact socket. Although this tube is quite free from microphonic disturbances, cushioning of its socket may sometimes be desirable.

For **filament** operation, refer to INSTALLATION for Type 30.

The **screen voltage** may be obtained from a tap on the B-supply battery or from a bleeder circuit across the battery, as a whole or in part. Due to the screen current characteristics of the 34, a resistor in series with the B-supply may be employed, if desired, for obtaining the screen voltage, provided the maximum voltage between screen and filament does not exceed 100 volts under conditions of reduced plate current.

Stage **shielding** enclosing all the components of each stage is, in general, necessary for multi-stage amplifier circuits.

APPLICATION

As an **r-f** or **i-f amplifier**, the 34 is applicable in receivers designed for it. Plate, screen, and minimum grid voltages are given under CHARACTERISTICS for a number of operating conditions.

Volume control of the receiver is accomplished effectively by variation of the negative voltage applied to the grid. In order to obtain adequate volume control, an available grid-bias voltage of approximately -22.5 volts will be required. The exact value will depend upon the circuit design and operating conditions. This voltage may be obtained from a potentiometer, a bleeder circuit, or a separate source, depending on receiver requirements.

Owing to the fact that the super-control feature of the 34 requires a comparatively large grid-bias change, the screen and plate voltage may vary considerably for various volume settings depending on receiver design. It is recommended, therefore, that design features be incorporated in the receiver so that the screen voltage will not exceed 67.5 volts under conditions of minimum grid bias and maximum plate current. With a design arrangement of this kind, the screen voltage at decreased values of plate current may reach a value higher than 67.5 volts but should not exceed 100 volts. It should be recognized that under the condition of screen voltage above 67.5 volts at low plate current, an increase in the grid-bias voltage supply must be provided for adequate volume control.

As the **mixer** in superheterodyne circuits, the 34 may be utilized to advantage. In such service, the grid bias may or may not be made variable. With variable bias, the peak oscillator voltage should be preferably about one volt less than the lowest operating grid bias. This practice will eliminate the possibility of cross-modulation caused by the mixer drawing grid current. Without variable bias, the oscillator peak voltage should be considerably less than the grid bias to prevent grid current on very strong signal swings. It should be noted that by varying the grid bias on the mixer in conjunction with that on the radio-frequency and/or the intermediate-frequency stages, additional control of volume may be accomplished.

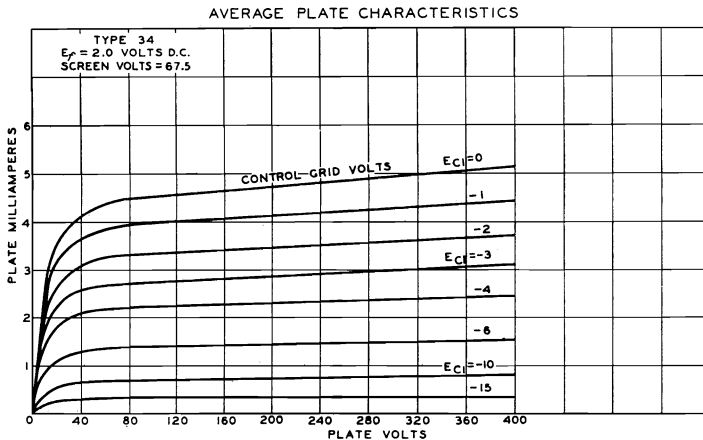



RCA Radiotron

Cunningham
RADIO TUBES

RCA-35

C-35

SUPER-CONTROL RADIO-FREQUENCY AMPLIFIER

The 35 is a super-control screen grid amplifier tube containing a 2.5-volt heater-cathode of the equi-potential type. It is recommended as a radio-frequency amplifier and an intermediate-frequency amplifier in a-c receivers. The 35 is very effective in reducing cross-modulation and modulation-distortion over the entire range of received signals. Its design is such as to permit easy control of a large range of signal voltages without the use of local-distance switches or antenna potentiometers. This super-control feature makes the tube adaptable to circuits incorporating automatic volume control. See page 11 for Super-Control feature.

CHARACTERISTICS

HEATER VOLTAGE (A. C. or D. C.).....	2.5	Volts
HEATER CURRENT.....	1.75	Amperes
PLATE VOLTAGE*.....	180 250	Volts
SCREEN VOLTAGE.....	90 max. 90 max.	Volts
GRID VOLTAGE, Variable (Minimum).....	-3 -3	Volts
PLATE CURRENT.....	6.3 6.5	Milliamperes
SCREEN CURRENT (Maximum).....	2.5 2.5	Milliamperes
PLATE RESISTANCE.....	300000 400000	Ohms
AMPLIFICATION FACTOR.....	305 420	
MUTUAL CONDUCTANCE.....	1020 1050	Micromhos
MUTUAL CONDUCTANCE (At -40 volts bias)	15 15	Micromhos
GRID-PLATE CAPACITANCE (With shield-can)	0.007 max.	$\mu\mu\text{f}$
INPUT CAPACITANCE.....	5.3	$\mu\mu\text{f}$
OUTPUT CAPACITANCE.....	10.5	$\mu\mu\text{f}$
BULB (For dimensions, see Page 151, Fig. 10).....		S-14
CAP.....		Small Metal
BASE (For socket connections, see Page 150, Fig. 9).....		Medium 5-Pin

* Maximum plate voltage = 275 volts.

INSTALLATION

The **base** pins of the 35 fit the standard five-contact socket. The socket may be mounted to hold the tube in any position.

The **heater** of the 35 is intended for operation from a 2.5-volt winding of the power transformer. The voltage applied to the heater terminals should be the rated value of 2.5 volts under operating conditions and with average line voltage.

The **cathode connection** to the heater should be made (1) to the movable arm of a potentiometer connected across the heater winding of the power transformer, or (2) to a mid-tapped resistor across the heater winding, or (3) to the mid-point of the heater winding itself. Recommended practice is to have no potential difference between heater and cathode. If this practice is not followed, the potential difference should be kept as low as possible.

The positive **screen voltage** for the 35 may be obtained from a fixed or variable cap on a voltage divider across the supply voltage or a portion of the supply.

Complete **shielding** for all stages of the circuit is necessary if maximum gain and the volume-control-range capabilities of this tube are to be realized.

APPLICATION

As a **radio-frequency** and **intermediate-frequency amplifier**, the 35 should be operated as shown under CHARACTERISTICS. In general, properly designed radio-frequency transformers are preferable to interstage coupling impedances, especially in cases where a high impedance B-supply may cause oscillation below radio frequencies.

Volume control of receivers designed for the 35 may be accomplished by variation of the negative grid bias of this tube. In order to utilize the full volume-control range of the 35, an available grid-bias voltage of approximately 50 volts will be required, depending upon the circuit design and operating conditions. This voltage may be obtained from a potentiometer, a bleeder circuit, or an adjustable cathode resistor.

As a **detector** working directly into an audio-frequency amplifier, the 35 is not ordinarily suited. However, this tube does have a very useful application as a mixer (first detector) in superheterodyne circuits. Suitable operating voltages for such service are: Plate voltage, 250 volts; screen voltage, 90 volts; and grid-bias, -7 volts with a 6-volt peak swing from the oscillator. By varying the grid-bias on the mixer in conjunction with that on the radio-frequency and/or the intermediate-frequency stages, additional control of volume may be accomplished.

As an **audio-frequency amplifier**, the 35 may be used in a single stage, resistance-coupled circuit when it is followed by not more than one amplifier stage. Additional stages of amplification are not recommended because of the possibility of noise and microphonic disturbances resulting from the high level of amplification. Suitable operating voltages for such service are: Plate-supply voltage, 180 to 250 volts, applied through a load resistor of 100000 to 200000 ohms; screen voltage, 25 volts; grid bias, -1 volt. In general, the higher value of load resistor will permit increased amplification but will give poorer fidelity. The higher plate-supply voltages allow increased signal swing without distortion but are not required where only small signals are to be amplified. In resistance-coupled circuits employing the 35, the grid resistor should have a value not exceeding 1.0 megohm.

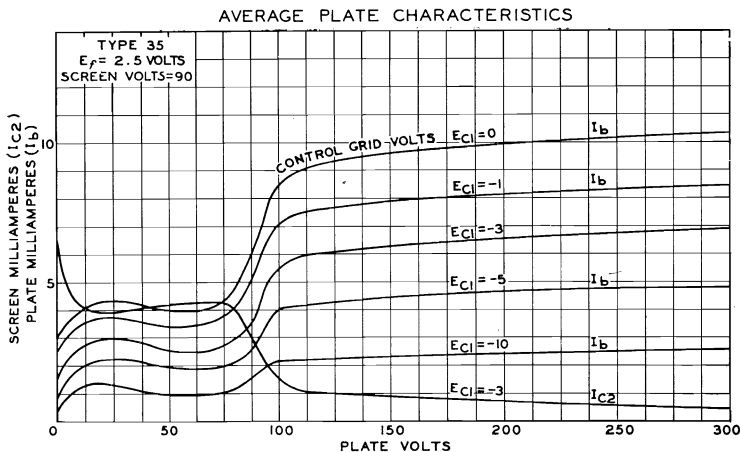



RCA-36

C-36

RADIO-FREQUENCY AMPLIFIER

The 36 is a heater-cathode type of screen grid tube intended for use as a radio-frequency amplifier, intermediate-frequency amplifier, and detector. Its heater-cathode construction permits of operation on either a-c or d-c power supply. The relatively low heater current of this type makes it suitable for automobile receivers and for power-line-operated sets, particularly those with a series-heater arrangement.

CHARACTERISTICS

HEATER VOLTAGE (A. C. or D. C.).....				6.3	Volts
HEATER CURRENT.....				0.3	Ampere
PLATE VOLTAGE.....	100	135	180	250 <i>max.</i>	Volts
SCREEN VOLTAGE.....	55	67.5	90 <i>max.</i>	90 <i>max.</i>	Volts
GRID VOLTAGE.....	-1.5	-1.5	-3	-3	Volts
PLATE CURRENT.....	1.8	2.8	3.1	3.2	Milliamperes
SCREEN CURRENT.....	—	—	—	1.7 <i>max.</i>	Milliamperes
PLATE RESISTANCE.....	0.55	0.475	0.5	0.55	Megohm
AMPLIFICATION FACTOR.....	470	475	525	595	
MUTUAL CONDUCTANCE.....	850	1000	1050	1080	Micromhos
GRID-PLATE CAPACITANCE (With shield-can).....				0.007 <i>max.</i>	$\mu\mu\text{f}$
INPUT CAPACITANCE.....				3.7	$\mu\mu\text{f}$
OUTPUT CAPACITANCE.....				9.2	$\mu\mu\text{f}$
BULB (For dimensions, see Page 151, Fig. 7).....					ST-12
CAP.....					Small Metal
BASE (For socket connections, see Page 150, Fig. 9).....					Small 5-Pin

INSTALLATION

The **base** pins of the 36 fit the standard five-contact socket which may be mounted to hold the tube in any position.

For **heater** operation and **cathode** connection, refer to INSTALLATION for Type 6A7.

The positive **screen voltage** for the 36 may be obtained from a section of the B-battery, or from a fixed or variable tap on a voltage divider connected across the supply voltage, or a portion of the supply. The impedance between the screen and cathode should be kept as low as possible by means of a suitable by-pass condenser.

Complete **shielding** of all stages of the circuit is necessary if maximum gain per stage is to be obtained.

APPLICATION

As a **radio-frequency amplifier**, the 36 should be operated as shown under CHARACTERISTICS. Neither the plate nor the screen voltage is critical. In general, properly designed radio-frequency transformers are preferable to interstage-coupling impedances, especially in cases where a high impedance B-supply may cause oscillation below radio frequencies

THE RCA RADIOTRON-CUNNINGHAM RADIO TUBE MANUAL

As a **detector**, the 36 may be operated either with grid leak and condenser or with grid bias. For grid-bias detection, suitable operating conditions are: Plate-supply voltage, 180 volts applied through a plate-coupling resistor of 250000 ohms; positive screen voltage, 67.5 volts; and negative grid bias, 6 volts (approx.), so adjusted that a plate current of 0.1 milliampere is obtained with no input signal. When grid leak and condenser detection is employed, a plate voltage of 135 volts applied through a plate-coupling resistor of 250000 ohms together with a positive screen voltage up to 45 volts will be satisfactory. A grid leak of 2 to 5 megohms and a grid condenser of 0.00025 μf will be suitable.

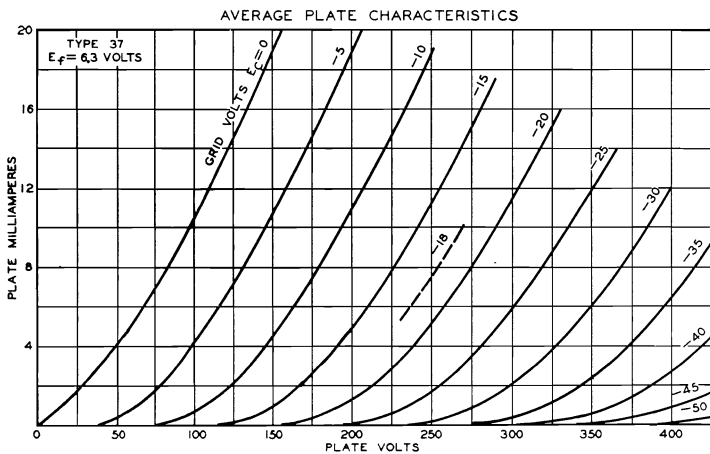
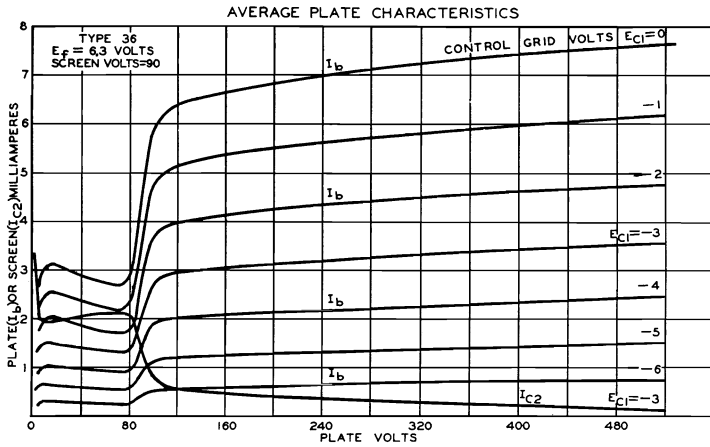



RCA Radiotron

Cunningham
RADIO TUBES

RCA-37

C-37

DETECTOR, AMPLIFIER

The 37 is a three-electrode, general purpose tube of the heater-cathode type. Its heater-cathode construction permits of operation on either a-c or d-c power supply. The relatively low heater current of this type makes it suitable for automobile receivers and for power-line-operated sets, particularly those with a series-heater arrangement.

CHARACTERISTICS

HEATER VOLTAGE (A. C. or D. C.).....	6.3	Volts
HEATER CURRENT.....	0.3	Ampere
PLATE VOLTAGE.....	90 135 180 250 <i>max.</i>	Volts
GRID VOLTAGE.....	-6 -9 -13.5 -18	Volts
PLATE CURRENT.....	2.5 4.1 4.3 7.5	Milliamperes
PLATE RESISTANCE.....	11500 10000 10200 8400	Ohms
AMPLIFICATION FACTOR.....	9.2 9.2 9.2 9.2	
MUTUAL CONDUCTANCE....	800 925 900 1100	Micromhos
GRID-PLATE CAPACITANCE...	2.0	$\mu\mu\text{f}$
GRID-CATHODE CAPACITANCE	3.5	$\mu\mu\text{f}$
PLATE-CATHODE CAPACITANCE	2.2	$\mu\mu\text{f}$
BULB (For dimensions, see Page 151, Fig. 6).....		ST-12
BASE (For socket connections, see Page 150, Fig. 8).....		Small 5-Pin

INSTALLATION

The **base** pins of the 37 fit the standard five-contact socket. The socket may be mounted to hold the tube in any position.

For **heater** operation and **cathode** connection, refer to INSTALLATION for Type 6A7.

APPLICATION

As a **detector**, the 37 may be operated with either grid leak and condenser or with grid bias. The recommended plate voltage for the grid leak and condenser method is 45 volts. A grid leak of from 1.0 to 5.0 megohms used with a grid condenser of 0.00025 μf is suitable.

For grid-bias detection a plate voltage of 135 volts together with a negative grid bias of approximately 15.5 volts may be used. The plate current should be adjusted to 0.2 milliamperes with no input signal. The grid-bias voltage may conveniently be obtained from the voltage drop in a resistor between the cathode and ground. The value of this self-biasing resistance is not critical, 75000 to 100000 ohms being suitable. The higher value will allow the use of a larger input signal.

As an **amplifier**, the 37 is applicable to the audio- or the radio-frequency stages of a receiver. Plate voltages and the corresponding grid voltages for amplifier service should be determined from CHARACTERISTICS and curves to obtain optimum performance and freedom from distortion. The plate family is given on the preceding page.



RCA-38

C-38

POWER AMPLIFIER PENTODE

The 38 is a power amplifier pentode of the heater-cathode type. Its heater-cathode construction permits of operation on either a-c or d-c power supply. The relatively low heater current of this type makes it suitable for automobile receivers and for power-line-operated sets, particularly those with a series-heater arrangement.

CHARACTERISTICS

HEATER VOLTAGE (A. C. or D. C.).....	6.3	Volts
HEATER CURRENT.....	0.3	Ampere
PLATE VOLTAGE.....	100 135 180	250 <i>max.</i> Volts
SCREEN VOLTAGE.....	100 135 180	250 <i>max.</i> Volts
GRID VOLTAGE.....	-9 -13.5 -18	-25 Volts
PLATE CURRENT.....	7 9 14	22 Milliamperes
SCREEN CURRENT.....	1.2 1.5 2.4 3.8	Milliamperes
PLATE RESISTANCE.....	0.14 0.13 0.11 0.10	Megohm
AMPLIFICATION FACTOR...	120 120 120 120	
MUTUAL CONDUCTANCE...	875 925 1050 1200	Micromhos
LOAD RESISTANCE.....	15000 13500 11600 10000	Ohms
POWER OUTPUT.....	0.27 0.55 1.0 2.5	Watts
BULB (For dimensions, see Page 151, Fig. 7).....		ST-12
CAP.....		Small Metal
BASE (For socket connections, see Page 150, Fig. 9A).....		Small 5-Pin

INSTALLATION

The **base** pins of the 38 fit the standard five-contact socket which may be installed to hold the tube in any position.

For **heater** operation and **cathode** connection, refer to INSTALLATION for Type 6A7.

APPLICATION

For the **power amplifier** stage of radio receivers, the 38 is recommended either singly or in push-pull combination. More than one audio stage preceding the 38 is undesirable because of the possibility of microphonic disturbances resulting from the high level of amplification. Transformer or impedance-coupling devices are preferable. If, however, resistance coupling is used, the grid resistor should be limited for a self-biased tube to 1.0 megohm with plate voltages up to 250 volts provided the heater voltage does not rise more than 10% above the rated value under any condition of operation. In the case of a fixed-bias tube, the grid resistor should be limited to 0.5 megohm for plate voltages of 100 to 135 volts, and to 0.1 megohm for 180 to 250 volts.

A family of plate characteristics for this type is given at the bottom of page 80.



RCA Radiotron

**Cunningham
RADIO TUBES**

RCA-39/44

C-39/44

SUPER-CONTROL R-F AMPLIFIER PENTODE

The 39/44 is a heater-cathode tube of the remote cut-off type suitable for use primarily as a radio-frequency amplifier, intermediate-frequency amplifier, and mixer in receivers designed for its characteristics. The 39/44 is effective in reducing cross-modulation and modulation-distortion over the usual range of signal voltages without the use of antenna potentiometers or auxiliary volume-control switches.

An explanation of the Super-Control feature is given on page 11.

CHARACTERISTICS

HEATER VOLTAGE (A. C. or D. C.).....		6.3	Volts
HEATER CURRENT.....		0.3	Ampere
PLATE VOLTAGE.....	90 180	250 <i>max.</i>	Volts
SCREEN VOLTAGE.....	90 90	90 <i>max.</i>	Volts
GRID VOLTAGE.....	-3 -3	-3 <i>min.</i>	Volts
PLATE CURRENT.....	5.6 5.8	5.8	Milliamperes
SCREEN CURRENT.....	1.6 1.4	1.4	Milliamperes
PLATE RESISTANCE.....	0.375 0.750	1.0	Megohm
AMPLIFICATION FACTOR.....	360 750	1050	
MUTUAL CONDUCTANCE.....	960 1000	1050	Micromhos
MUTUAL CONDUCTANCE (At -42.5 volts bias).....	2 2 2		Micromhos
GRID-PLATE CAPACITANCE (With shield-can).....		0.007 <i>max.</i>	$\mu\mu\text{f}$
INPUT CAPACITANCE.....		3.5	$\mu\mu\text{f}$
OUTPUT CAPACITANCE.....		10	$\mu\mu\text{f}$
BULB (For dimensions, see Page 151, Fig. 7).....			ST-12
CAP.....			Small Metal
BASE (For socket connections, see Page 150, Fig. 9A).....			Small 5-Pin

INSTALLATION

The **base** pins of the 39/44 fit the standard five-contact socket. The socket may be installed to hold the tube in any position.

For **heater** operation and **cathode** connection, refer to INSTALLATION for Type 6A7.

The positive **screen voltage** for the 39/44 may be obtained from a section of the B-battery, from a fixed or variable tap on a voltage divider across the supply voltage, or from a portion of the supply. Care should be taken to keep the impedance between the screen and cathode as low as possible.

When the 39/44 is self-biased, a resistor in series with the high voltage supply may be used for obtaining the screen voltage. This is possible because of the stable screen-current characteristic of the 39/44 pentode. The resistor method of securing the screen voltage is limited to circuits where the screen-voltage supply does not exceed 180 volts as a maximum. The value of this resistance should be such that under the conditions of minimum grid bias and maximum plate current the screen voltage will not exceed 90 volts. A resistance of approximately 80000 ohms will be suitable.

Complete **shielding** of all stages is necessary if maximum gain per stage is to be obtained.

APPLICATION

As a **radio-frequency** and **intermediate-frequency amplifier**, the 39/44 should be operated as shown under CHARACTERISTICS. In general, properly designed radio-frequency transformers are preferable to interstage coupling impedances, especially in cases where a high impedance B-supply may cause oscillation below radio frequencies.

THE RCA RADIOTRON-CUNNINGHAM RADIO TUBE MANUAL

Volume control of receivers designed for the 39/44 may be accomplished by variation of the negative grid bias of this tube. In order to obtain adequate volume control, an available grid-bias voltage of approximately 45 volts will be required. The exact value will depend upon the circuit design and operating conditions. This voltage may be obtained from a potentiometer, a bleeder circuit, a variable resistor in the cathode circuit, or from a separate source.

As a **detector** working directly into an audio-frequency amplifier, the 39/44 is not ordinarily suited. However, it does have a very useful application as the mixer in superheterodyne circuits and may be utilized to advantage in that position. Suitable operating voltages for such service are: Plate voltage, 90 to 250 volts; screen voltage, 90 volts; grid voltage, -7 volts (approx.). With variable bias on the mixer, the peak oscillator voltage should be preferably about one volt less than the minimum grid-bias (approximately 7 volts). This practice will eliminate the possibility of cross-modulation caused by the mixer drawing grid current. Without variable bias on the mixer, the oscillator peak voltage should be considerably less than the grid-bias to prevent grid current on very strong signal voltage swings.

AVERAGE PLATE CHARACTERISTICS

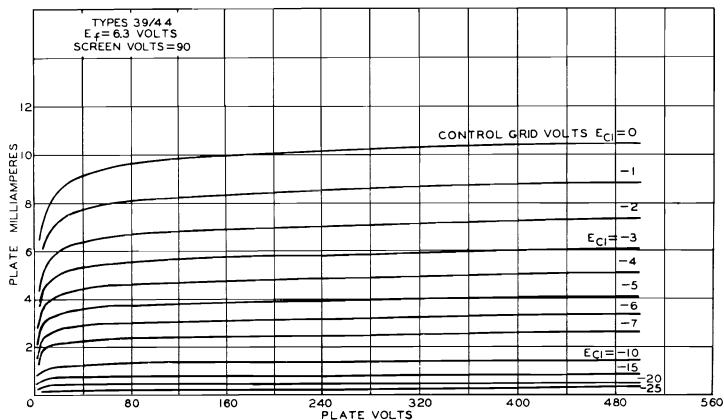

AVERAGE PLATE CHARACTERISTICS

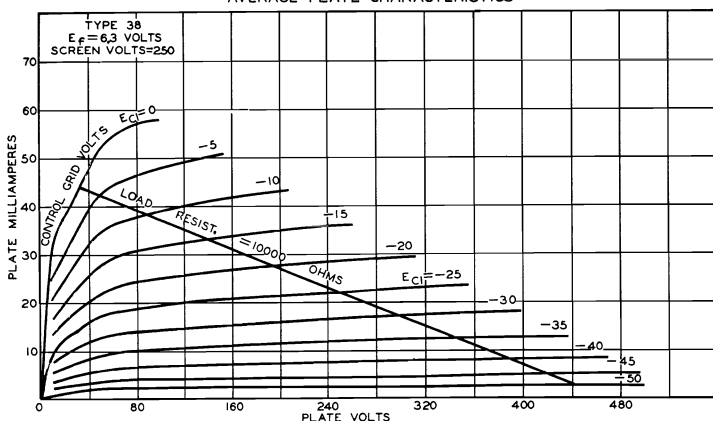



RCA-41

C-41

POWER AMPLIFIER PENTODE

The 41 is a power amplifier pentode of the heater-cathode type for use in the audio-output stage of radio receivers, especially those of the mobile type which obtain their heater-supply voltage from a storage battery. The tube is capable of giving a large power output with a relatively small input-signal voltage.

In comparison with other types for the output stage of automobile receivers, the 41 has greater power output capability than the 38 and has the same output as the 89 with the pentode connection. The 41 has higher power sensitivity than the 89 but lacks the 89's flexibility of application to Class A and to Class B Triode amplifier circuits. These three types are not interchangeable.

CHARACTERISTICS

HEATER VOLTAGE (A. C. or D. C.)	6.3	Volts
HEATER CURRENT	0.4	Ampere
PLATE VOLTAGE	100 135 180	250 <i>max.</i> Volts
SCREEN VOLTAGE	100 135 180	250 <i>max.</i> Volts
GRID VOLTAGE	-7 -10 -13.5	-18 Volts
PLATE CURRENT	9.0 12.5 18.5	32 Milliampere
SCREEN CURRENT	1.6 2.2 3.0	5.5 Milliampere
PLATE RESISTANCE	103500 94000 81000	68000 <i>approx.</i> Ohms
AMPLIFICATION FACTOR	150 150 150	150 <i>approx.</i>
MUTUAL CONDUCTANCE	1450 1600 1850	2200 Micromhos
LOAD RESISTANCE	12000 10400 9000	7600 Ohms
POWER OUTPUT	0.33 0.75 1.5 3.4	Watts
BULB (For dimensions, see Page 151, Fig. 6)		ST-12
BASE (For socket connections, see Page 150, Fig. 15A)		Medium 6-Pin

INSTALLATION

The **base** pins of the 41 fit the standard six-contact socket which may be installed to hold the tube in any position.

The **bulb** of this tube will become very hot under certain conditions of operation. Sufficient ventilation should be provided to prevent overheating.

The **heater** of the 41 is designed to operate directly from a 6-volt automobile storage battery despite the voltage fluctuations during the charge and discharge periods. If the heater is operated with a.c., the transformer winding which supplies the heater circuit should be designed to operate the heater at 6.3 volts for full-load operating conditions at average line voltage.

In a series-heater circuit employing several 6.3-volt types and one or more 41's, the heaters of the 41's should be placed on the positive side. Furthermore, since most 6.3-volt types have 0.3-ampere heaters, a bleeder circuit across these heaters is required to take care of the additional 0.1-ampere heater current of the 41. Each 6.3-volt tube of the 0.3-ampere type in the series circuit should, therefore, be shunted by a bleeder resistance of 63 ohms.

For **cathode** connection, refer to INSTALLATION for Type 6A7.

APPLICATION

For the **power amplifier** stage of automobile receivers and other receivers, the 41 may be used either singly or in push-pull combination. More than one audio stage preceding the 41 is undesirable because of the possibility of microphonic disturbances resulting from the high level of amplification.

If a single 41 is operated self-biased, the self-biasing resistor should be shunted by a suitable filter network to avoid degenerative effects at low audio frequencies. The use of two 41's in push-pull eliminates the necessity for shunting the resistor. The self-biasing resistor required for the push-pull stage is one-half that for a single stage.

Any conventional type of **input coupling** may be used provided the resistance added to the grid circuit by this device is not too high. Transformer or impedance coupling devices are recommended. If, however, resistance coupling is employed, the grid resistor should not exceed one megohm with self-bias, provided the heater voltage does not rise more than 10% above the rated value under any condition of operation. When self-bias is not used, the value should be limited to 100000 ohms.

An **output transformer** should be used to supply power to the winding of the reproducing unit. The optimum value of load resistance for a single tube is given under CHARACTERISTICS. For push-pull operation, the plate-to-plate load resistance should be twice that for a single tube. For best results, the impedance in the plate circuit of the 41 should be as uniform as possible over the entire audio-frequency range.

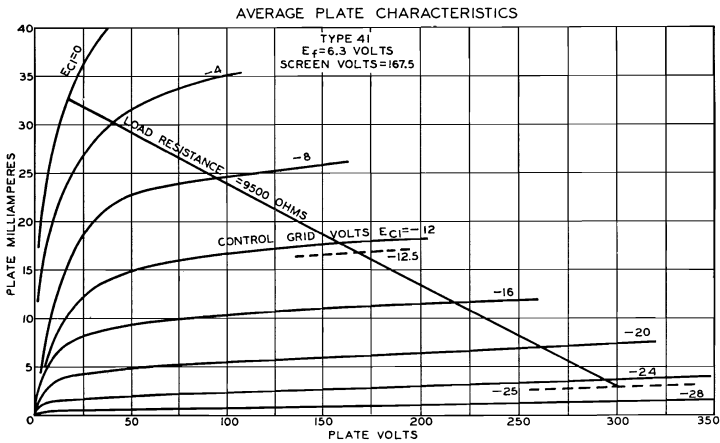



RCA Radiotron

**Cunningham
RADIO TUBES**

RCA-42

C-42

POWER AMPLIFIER PENTODE

The 42 is a power amplifier pentode of the heater-cathode type for use in the audio-output stage of a-c receivers. It is capable of giving large power output with a relatively small input-signal voltage. Because of the heater-cathode construction, a uniformly low hum-level is attainable in power amplifier design.

CHARACTERISTICS

HEATER VOLTAGE (A. C. or D. C.).....	6.3	Volts
HEATER CURRENT.....	0.7	Ampere
PLATE VOLTAGE.....	250 <i>max.</i>	Volts
SCREEN VOLTAGE.....	250 <i>max.</i>	Volts
GRID VOLTAGE.....	-16.5	Volts
PLATE CURRENT.....	34	Milliamperes
SCREEN CURRENT.....	6.5	Milliamperes
PLATE RESISTANCE.....	100000 <i>approx.</i>	Ohms
AMPLIFICATION FACTOR.....	220 <i>approx.</i>	
MUTUAL CONDUCTANCE.....	2200	Micromhos
LOAD RESISTANCE.....	7000	Ohms
POWER OUTPUT (7% total distortion).....	3.0	Watts
BULB (For dimensions, see Page 151, Fig. 11).....		ST-14
BASE (For socket connections, see Page 150, Fig. 15A).....		Medium 6-Pin

INSTALLATION

The **base** pins of the 42 fit the standard six-contact socket which may be installed to hold the tube either in a vertical or in a horizontal position. Sufficient ventilation should be provided to prevent overheating.

In a series-heater circuit employing several 6.3-volt types and one or more 42's, the heaters of the 42's should be placed on the positive side. Furthermore, since most 6.3-volt types have 0.3-ampere heaters, a bleeder circuit across these heaters is required to take care of the additional 0.4-ampere heater current of the 42. Each 6.3-volt tube of the 0.3-ampere type in the series circuit should, therefore, be shunted by a bleeder resistance of 16 ohms.

APPLICATION

As a **power amplifier (Class A)**, the 42 may be used either singly or in push-pull combination. Recommended operating conditions are given under CHARACTERISTICS. The plate family for this type is identical with that for the 2A5.

If a single 42 is operated self-biased, the self-biasing resistor should have a value of 410 ohms. This resistor should be shunted by a suitable filter network to avoid degenerative effects at low audio frequencies. The use of two 42's in push-pull eliminates the necessity for shunting the resistor. The self-biasing resistor required for the push-pull stage is one-half that for a single stage.

Transformer or impedance-input coupling devices are recommended. If, however, resistance coupling is employed, the grid resistor should not exceed one megohm with self-bias, provided the heater voltage does not rise more than 10% above the rated value under any condition of operation; without self-bias, the value should be limited to 100000 ohms.



RCA-43

C-43

POWER AMPLIFIER PENTODE

The 43 is a power amplifier pentode of the heater-cathode type for use in the output stage of radio receivers, especially those of the "d-c power line" type and the "universal (a.c.-d.c.)" type. In such applications, the 43 is capable of handling relatively large audio power at the low plate and screen voltage available. A single 43 in the output stage operating with 100 volts on plate and screen can deliver nearly one watt of audio power, while two 43's in push-pull arrangement with the same voltages can supply approximately two watts.

CHARACTERISTICS

HEATER VOLTAGE (A. C. or D. C.).....	25	Volts
HEATER CURRENT.....	0.3	Ampere
PLATE VOLTAGE..... 100	135 <i>max.</i>	Volts
SCREEN VOLTAGE..... 100	135 <i>max.</i>	Volts
GRID VOLTAGE..... -15	-20	Volts
PLATE CURRENT..... 20	34	Milliamperes
SCREEN CURRENT..... 4	7	Milliamperes
PLATE RESISTANCE..... 45000	35000	Ohms
AMPLIFICATION FACTOR..... 90	80	
MUTUAL CONDUCTANCE..... 2000	2300	Micromhos
LOAD RESISTANCE..... 4500	4000	Ohms
POWER OUTPUT..... 0.9	2.0	Watts
BULB (For dimensions, see Page 151, Fig. 11).....		ST-14
BASE (For socket connections, see Page 150, Fig. 15A).....		Medium 6-Pin

APPLICATION

The **base** pins of the 43 fit the standard six-contact socket which may be installed to hold the tube either in a vertical or in a horizontal position. Sufficient ventilation should be provided to circulate air freely around the tube to prevent overheating.

The 25-volt **heater** of the 43 is designed to operate under the normal conditions of line-voltage variation without materially affecting the performance or serviceability of this tube. For operation of the 43 in series with the heaters of other types having 0.3-ampere rating, the current in the heater circuit should be adjusted to 0.3 ampere for the normal supply voltage.

In a series-heater circuit of the "d-c power line" type employing several 0.3-ampere (6.3-volt) types and one or two 43's, the heaters of the 43's should be placed on the positive side of the line. Under these conditions, heater-cathode voltage of the 43 must not exceed the value given below under *cathode*. In a series-heater circuit of the "universal" type employing rectifier tube 25Z5, one or two 43's, and several 0.3-ampere (6.3-volt) types, it is recommended that the heater(s) of the 43('s) be placed in the circuit so that the higher values of heater-cathode bias will be impressed on the 43('s) rather than on the 6.3-volt types. This is accomplished by arranging the 43('s) on the side of the supply line which is connected to the cathode of the rectifier, i.e., the positive terminal of the rectified-voltage supply. Between this side of the line and the 43 ('s), any necessary auxiliary resistance and the heater of the 25Z5 are connected in series.

THE RCA RADOTRON-CUNNINGHAM RADIO TUBE MANUAL

The **cathode** circuit in "d-c power line" or "universal" receivers is tied in either directly or through biasing resistors to the negative side of the d-c plate supply which is furnished either by the d-c power line or by the a-c line by means of a rectifier. The potential difference thus introduced between heater and cathode of the 43 should not exceed 90 volts d.c., as measured between the negative heater terminal and the cathode.

INSTALLATION

As a **power amplifier (Class A)**, the 43 is recommended for use either singly or in push-pull combination in the power output stage of "d-c power line" and "universal" receivers. Recommended operating conditions are given under CHARACTERISTICS.

If a single 43 is operated self-biased, the self-biasing resistor should be approximately 625 ohms for the 100-volt condition and 490 ohms for the 135-volt condition. This resistor should be shunted by a suitable filter network to avoid degenerative effects at low audio frequencies. The use of two 43's in push-pull eliminates the necessity for shunting the resistor. The self-biasing resistor for the push-pull stage is half of the value given for single-tube operation.

If resistance coupling is used for the 43, the maximum grid resistor value is 0.25 megohm. Under operating conditions such that the heater voltage never exceeds 25 volts, a value of 0.5 megohm is permissible.

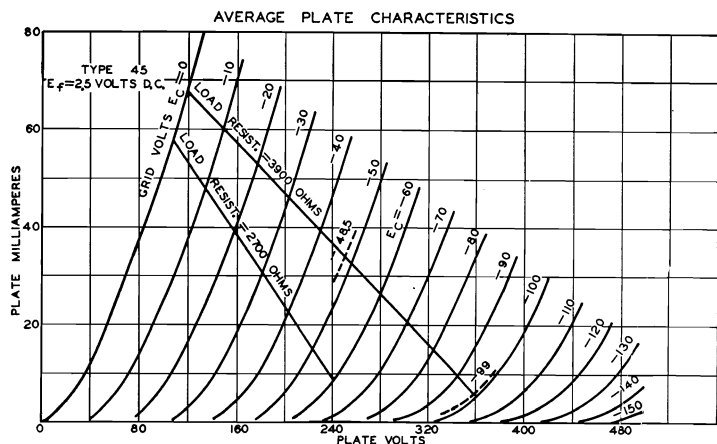
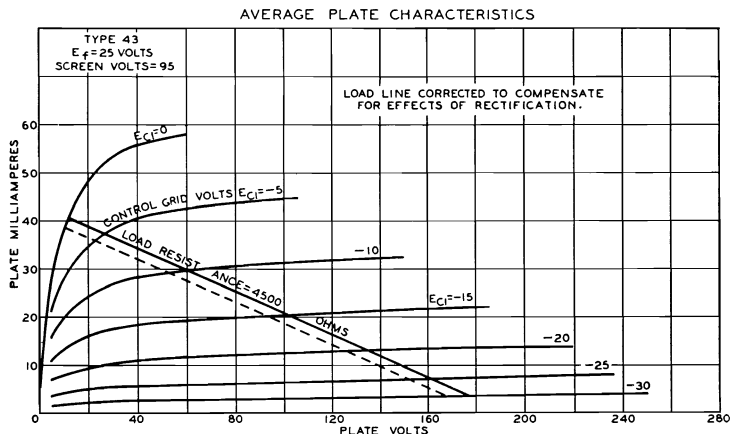



RCA Radiotron

Cunningham
RADIO TUBES

RCA-45

C-45

POWER AMPLIFIER

The 45 is a power amplifier tube for supplying large undistorted output to a loudspeaker. It is for use as an audio-frequency output tube in a-c receivers using 2.5-volt heater and filament-type tubes.

CHARACTERISTICS

FILAMENT VOLTAGE (A. C. or D. C.).....	2.5	Volts
FILAMENT CURRENT.....	1.5	Amperes
PLATE VOLTAGE.....	180 250 275 <i>max.</i>	Volts
GRID VOLTAGE*.....	31.5 -50 -56	Volts
PLATE CURRENT.....	31 34 36	Milliamperes
PLATE RESISTANCE.....	1650 1610 1700	Ohms
AMPLIFICATION FACTOR.....	3.5 3.5 3.5	
MUTUAL CONDUCTANCE.....	2125 2175 2050	Micromhos
LOAD RESISTANCE.....	2700 3900 4600	Ohms
UNDISTORTED POWER OUTPUT.....	0.83 1.6 2.0	Watts
BULB (For dimensions, see Page 151, Fig. 11).....		ST-14
BASE (For socket connections, see Page 150, Fig. 1).....		Medium 4-Pin

* Referred to mid-point of a-c operated filament. Self-bias is advisable in all cases and is required if a grid resistor (max. value of 1.0 megohm) is used.

INSTALLATION

The **base** pins of the 45 fit the standard four-contact socket which should be mounted preferably to hold the tube in a vertical position. If it is necessary to place the tube in a horizontal position, the socket should be mounted with the filament-pin holes vertically one above the other. This precaution locates the filament plane vertical for most satisfactory performance. Sufficient ventilation should be provided to prevent overheating.

The **filament** of this type is usually operated on a.c. See page 24.

APPLICATION

As a **power amplifier**, the 45 should be operated as indicated under CHARACTERISTICS. A plate family is given on the preceding page.

Grid bias for the 45 should be obtained by use of the voltage drop in a resistor connected in the negative plate-return lead. This scheme is known as the self-biasing method. The proper value of the resistor for a single 45 is 1550 ohms for a plate voltage of 275 volts; 1470 ohms for a plate voltage of 250 volts; and 1000 ohms for a plate voltage of 180 volts.

If more output is desired than can be obtained from a single 45, two 45's may be operated either in parallel or push-pull connection. See page 12. When two 45's are operated together in the same amplifier stage, the values of the self-biasing resistors will be approximately one-half the values given above for a single tube.

An **output device** should be used to transfer power to the winding of the reproducing unit.



RCA Radiotron

**Cunningham
RADIO TUBES**

RCA-46

C-46

DUAL-GRID POWER AMPLIFIER

The 46 is a double-grid power amplifier tube recommended especially for service in Class B amplifier circuits of suitable design. In such circuits an output stage is preceded by a power-amplifier stage designated as the "driver." A pair of 46's in a Class B output stage is capable of supplying an exceptionally large amount of virtually undistorted power; while a single 46, operated in the driver stage as a

Class A amplifier, can deliver sufficient power to drive the pair of 46's in the output stage.

The dual application of the 46 to Class B and to Class A amplifier service is made possible by different connections of the two grids incorporated in the tube's structure. Each grid terminates in its respective base pin. For Class B operation, the two grids must be tied together. This connection causes the tube to have an amplification factor so high that negative grid-bias is not required for its operation as a Class B amplifier. For Class A operation, the grid adjacent to the plate is tied to the plate in order that the tube will have a low amplification factor. In the latter case, negative grid-bias is required for proper operation of the tube. See page 14 for discussion of Class B operation.

CHARACTERISTICS

FILAMENT VOLTAGE (A. C. or D. C.).....	2.5	Volts
FILAMENT CURRENT.....	1.75	Amperes
BULB (For dimensions, see Page 151, Fig. 14)		S-17
BASE (For socket connections, see Page 150, Fig. 7)		Medium 5-Pin

As Class B Amplifier

PLATE VOLTAGE.....	400 max.	Volts
DYNAMIC PEAK PLATE CURRENT.....	200 max.	Milliamperes
AVERAGE PLATE DISSIPATION.....	10 max.	Watts
TYPICAL OPERATION (2 tubes)		
Filament Voltage (A. C.).....	2.5	Volts
Plate Voltage.....	300 400	Volts
Grid Voltage (Both grids tied together) ..	0 0	Volts
Static Plate Current (Per tube).....	4 6	Milliamperes
Load Resistance (Plate-to-plate).....	5200 5800	Ohms
Nominal Power Output (2 tubes).....	16* 20**	Watts

* With average power input of 950 milliwatts applied between grids.

** With average power input of 650 milliwatts applied between grids.

As Class A Amplifier

PLATE VOLTAGE.....	250 max.	Volts
GRID VOLTAGE (Grid adjacent to plate tied to plate) ..	-33	Volts
PLATE CURRENT.....	22	Milliamperes
PLATE RESISTANCE.....	2380	Ohms
AMPLIFICATION FACTOR.....	5.6	
MUTUAL CONDUCTANCE.....	2350	Micromhos
LOAD RESISTANCE (For max. undistorted power)*** ..	6400	Ohms
MAX. UNDISTORTED POWER OUTPUT.....	1.25	Watts

*** Approximately twice this value is recommended for load of this tube as driver for Class B stage.

INSTALLATION

The **base** of the 46 is of the medium five-pin type. Its pins fit the standard five-contact socket which may be installed to operate the tube either in a vertical or in a horizontal position. For horizontal operation, the socket should be positioned with the filament-pin openings one vertically above the other. Sufficient ventilation should be provided around the tube to prevent overheating.

The **filament** is designed to operate at 2.5 volts. The transformer winding that supplies the filament circuit should operate the filament at this recommended value for full-load operating conditions at average line voltage. The filament wiring should, insofar as possible, be isolated from the input circuit of the driver stage in order to avoid the possibility of hum caused by electrostatic induction from this wiring.

The grid and the plate return lead for the Class B stage should be connected to the mid-tap of the filament winding or to the center-tap of a 20-ohm resistor across the winding. The grid and plate return for the driver stage should be made to a variable center-tapped resistor across the filament supply for minimum hum adjustment. The use of a push-pull driver stage with either equi-potential or filament-type tubes will reduce hum resulting from the filament supply, but is required only in special applications.

APPLICATION

For **Class B audio power amplifier service**, the 46 is particularly recommended because of its design. In this type of service, the two grids in the tube are connected together and, thus, the signal voltage is applied to both simultaneously. Consideration of general Class B amplifier design features is given on page 14.

For **Class A operation** of the 46, the grid adjacent to the plate is connected to the plate. The grid next to the filament serves as the control grid. Operation of the tube is then similar to any Class A power amplifier triode. The operation of this tube connected as a Class A amplifier is not indicative of its performance in Class B circuits and should not be confused with the latter.

The intended application of the 46 as a Class A amplifier is for driving two 46's in a Class B amplifier circuit. The tube has been constructed for this dual service in order to reduce the number of tube types necessary in a receiver. The tabulated values for Class A operation of this type as given under CHARACTERISTICS are for its operation as a power output tube.

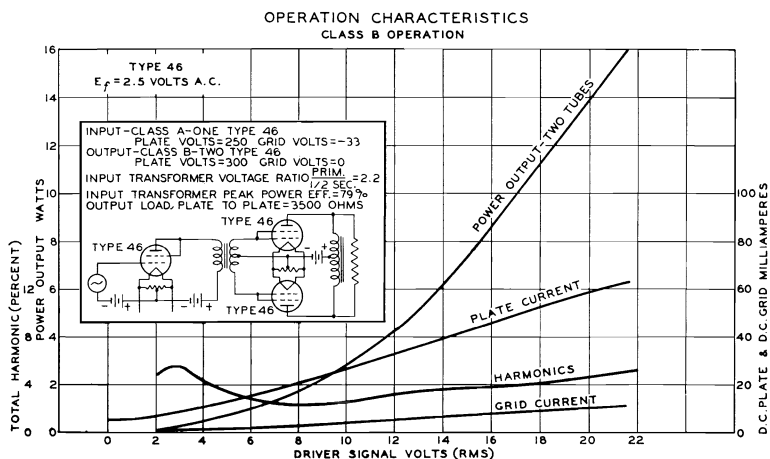

THE RCA RADOTRON-CUNNINGHAM RADIO TUBE MANUAL

AVERAGE PLATE CHARACTERISTICS
CLASS B OPERATION

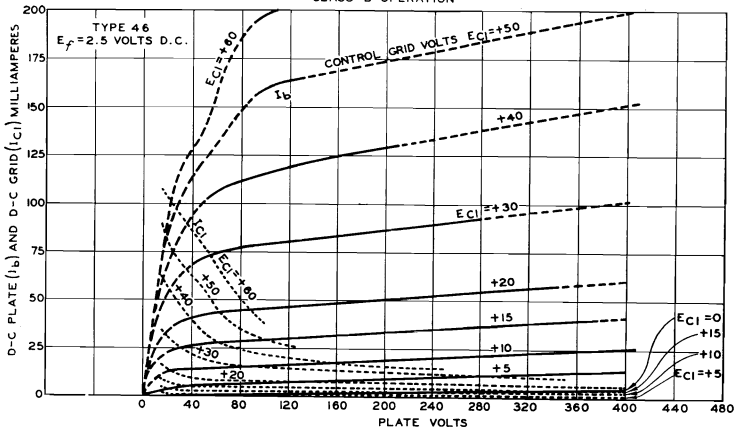

AVERAGE OPERATION CHARACTERISTICS
CLASS A OPERATION

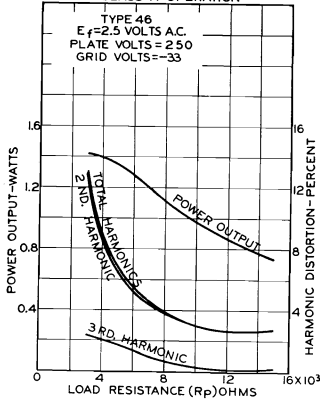

AVERAGE OPERATION CHARACTERISTICS
CLASS A OPERATION

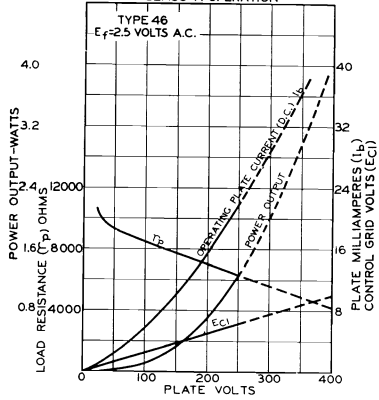

AVERAGE PLATE CHARACTERISTICS
CLASS A OPERATION

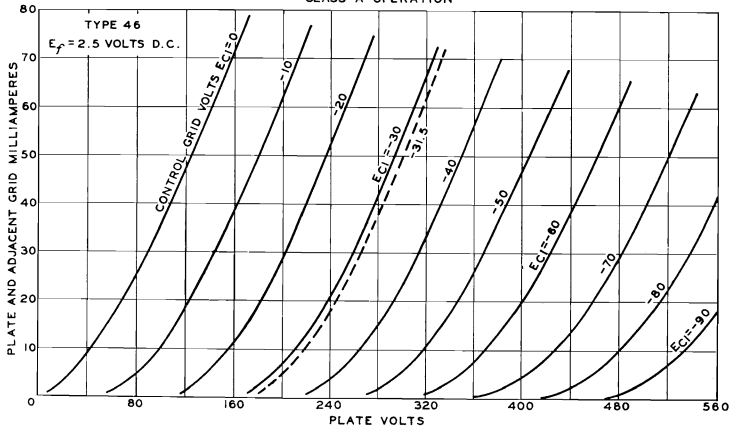

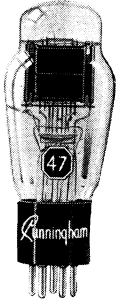

RCA Radiotron

**Cunningham
RADIO TUBES**

RCA-47

C-47

POWER AMPLIFIER PENTODE

The 47 is a power amplifier pentode for use in the audio output stage of a-c receivers. It is capable of giving large power output with a relatively small input-signal voltage. In comparison with three-electrode power amplifiers of the same plate dissipation, the 47 is capable of greater power output with the additional feature of higher amplification. This power-handling ability of the 47 is made possible by the addition of both a suppressor and a screen between the grid and plate.

CHARACTERISTICS

FILAMENT VOLTAGE (A. C. or D. C.)	2.5	Volts
FILAMENT CURRENT	1.75	Amperes
PLATE VOLTAGE	250 <i>max.</i>	Volts
SCREEN VOLTAGE	250 <i>max.</i>	Volts
GRID VOLTAGE*	-16.5	Volts
PLATE CURRENT	31	Milliamperes
SCREEN CURRENT	6.0	Milliamperes
PLATE RESISTANCE	60000	Ohms
AMPLIFICATION FACTOR	150	
MUTUAL CONDUCTANCE	2500	Micromhos
LOAD RESISTANCE	7000	Ohms
POWER OUTPUT	2.7	Watts
BULB (For dimensions, see Page 151, Fig. 13)		ST-16
BASE (For socket connections, see Page 150, Fig. 6)		Medium 5-Pin

* If filament is operated on d.c., grid bias should be -15.3 volts.

INSTALLATION

The **base** pins of the 47 fit the standard five-contact socket which should be mounted preferably to hold the tube in a vertical position. If it is necessary to place the tube in a horizontal position, the socket should be mounted with its filament-pin openings one vertically above the other. Sufficient ventilation should be provided around the tube to prevent overheating.

The filament of this type is usually operated on a.c. See page 24.

APPLICATION

For the **power amplifier** stage of radio receivers, the 47 is recommended either singly or in push-pull combination. More than one audio stage preceding the 47 is undesirable because of the possibility of microphonic disturbances resulting from the high level of amplification.

If a single 47 is operated self-biased, the self-biasing resistor should be approximately 450 ohms. This resistor should be shunted by a filter network to avoid degenerative effects at low audio frequencies. The use of two 47's in push-pull eliminates the necessity of the network and is, in addition, effective in reducing hum from filter circuits. The self-biasing resistor required for the push-pull stage is approximately 225 ohms.

THE RCA RADIOTRON-CUNNINGHAM RADIO TUBE MANUAL

Any conventional type of **input coupling** may be used, provided the resistance added to the grid circuit by this device is not too high. Transformer or impedance-coupling devices are preferable. If resistance coupling is used, a grid resistance not to exceed 0.5 megohm may be employed under the self-bias conditions. Without self-bias, the grid-leak resistance should not exceed 50000 ohms.

An **output transformer** should be used in order to supply power to the winding of the reproducing unit. The optimum value of load resistance for the output device is 7000 ohms. For best results, the impedance in the plate circuit of the 47 over the entire audio-frequency range should be as uniform as possible.

The blue glow which frequently appears on the inner surface of the 47 bulb is due to fluorescence caused by stray electrons from the filament which strike the interior of the getter-coated bulb. *This fluorescence is a natural effect and is in no manner an indication of the performance of the tube.*

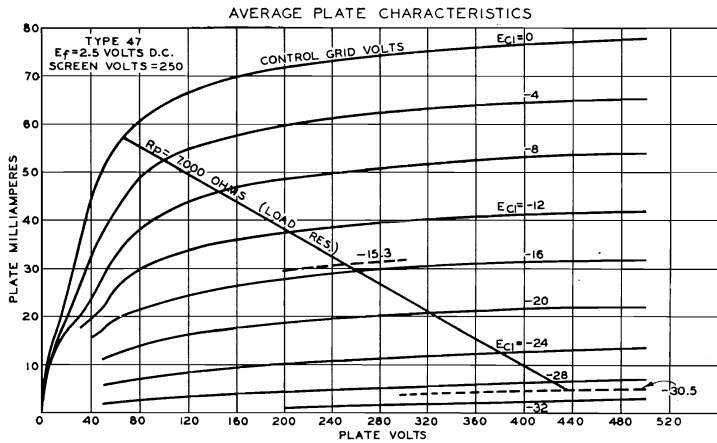

TYPICAL SUPERHETERODYNE RECEIVER FOR A-C OPERATION

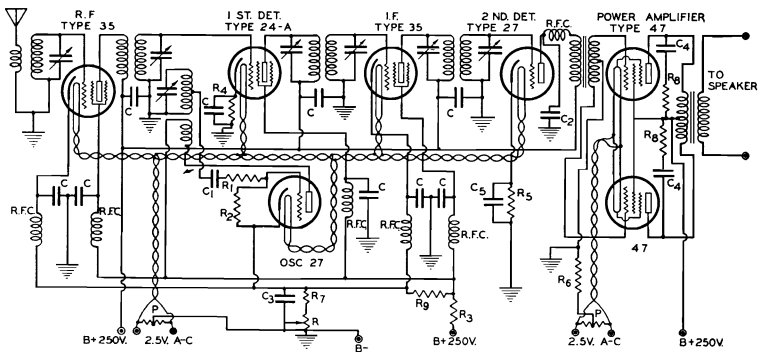

- C = R-F BY-PASS CONDENSER (0.1 μ f.)
- C₁ = OSC. GRID CONDENSER (0.00075 μ f.)
- C₂ = R-F BY-PASS CONDENSER (0.00025 μ f.)
- C₃ = R-F BY-PASS CONDENSER (0.5 μ f.)
- C₄ = CONDENSER (0.3 μ f. APPROX.)
- R = VOLUME CONTROL POTENTIOMETER (8 000 OHMS)
- R₁ = RESISTOR (6 000 OHMS)
- R₂ = OSCILLATOR GRID LEAK (40 000 OHMS)

- R₃ = RESISTOR (14 000 OHMS)
- R₄ = SELF-BIASING RESISTOR (1 500 OHMS)
- R₅ = SELF-BIASING RESISTOR (50 000 OHMS)
- R₆ = SELF-BIASING RESISTOR (225 OHMS)
- R₇ = PARTIAL SELF-BIAS RESISTOR (150 OHMS)
- R₈ = RESISTOR (10 000 OHMS APPROX.)
- R₉ = RESISTOR (8 000 OHMS)
- P = POTENTIOMETER (20 OHMS)
- C₅ = A-F BY-PASS CONDENSER (2-4 μ f.)

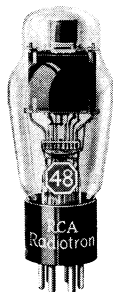

RCA-48

C-48

POWER AMPLIFIER TETRODE

The 48 is a power amplifier tetrode which has pentode characteristics when operated at the recommended screen and plate voltage. It is for use in the audio-output stage of receivers designed to operate from 115-volt d-c power lines. The 48 is exceptional in its ability to deliver power at the low plate and screen voltage obtainable in such service.

The large power-delivering ability of the 48 is made practical by the unique features of its electrical and structural design. Among these are the big cathode with its large emitting surface, the control-grid structure with its heat radiator, and the plate with a rib structure fastened to its inner surface. The rib structure serves to suppress the effects of secondary emission which limit the power output of four-electrode screen-grid types.

CHARACTERISTICS

HEATER VOLTAGE (D. C.).....	30.0	Volts
HEATER CURRENT.....	0.4	Ampere
PLATE VOLTAGE.....	95	125* max. Volts
SCREEN VOLTAGE.....	95	100 max. Volts
GRID VOLTAGE.....	-20	-22.5* Volts
PLATE CURRENT.....	47	50 Milliamperes
SCREEN CURRENT.....	9	9 Milliamperes
PLATE RESISTANCE.....	10000	10000 approx. Ohms
AMPLIFICATION FACTOR.....	28	28 approx.
MUTUAL CONDUCTANCE.....	2800	2800 Micromhos
LOAD RESISTANCE.....	2000	2000 Ohms
POWER OUTPUT.....	1.6	2.5 Watts
BULB (For dimensions, see Page 151 Fig. 13)		ST-16
BASE (For socket connections, see Page 150, Fig. 15)		Medium 6-Pin

* Suitable conditions for operation with auxiliary C-battery which permits utilization of full d-c power-line voltage (110-115 volts) for plate supply.

INSTALLATION

The **base** of the 48 fits the standard six-contact socket which may be installed to operate the tube either in a vertical or in a horizontal position. For horizontal operation, the socket should be positioned with the plate-pin opening at the top and the cathode-pin opening at the bottom or vice versa. Sufficient ventilation should be provided around the tube to prevent overheating.

The **heater** of the 48 is designed to operate at approximately 30 volts. Due to the heater-cathode design, the heater voltage may range between 26 and 34 volts during line-voltage fluctuations without greatly affecting the performance or serviceability of the tube.

In a series-heater circuit employing several 6.3-volt types and one or more 48's, the heaters of the 48's should be placed on the positive side. Furthermore, since the 6.3-volt types have 0.3-ampere heaters, a bleeder circuit across these heaters is required to take care of the additional 0.1-ampere heater current of the 48. Each 6.3-volt tube in the series circuit should, therefore, be shunted by a bleeder resistance of 63 ohms.

The **cathode** circuit in d-c receivers is tied in either directly or through biasing resistors to the negative side of the heater circuit. The potential difference thus introduced between heater and cathode of the 48 should not exceed 90 volts, as measured between the negative heater terminal and the cathode.

APPLICATION

As a **Class A power amplifier** tetrode in the output stage of d-c line receivers, the 48 is recommended for use either singly or in push-pull combination. Recommended operating conditions are given under CHARACTERISTICS.

When a single 48 is operated self-biased, the self-biasing resistor should be approximately 360 ohms. This resistor should be shunted by a suitable filter network to avoid degenerative effects at low audio frequencies. With two 48's in push-pull, the network may be omitted. The self-biasing resistor required for the push-pull stage is approximately 180 ohms.

Any conventional type of **input coupling** may be used, provided the resistance added to the grid circuit by this device is not too high. Transformer or impedance-coupling devices are preferable. In any case, the sum of the resistance of the coupling devices in the grid circuit and the resistance of the filter network (if used) should not exceed 10000 ohms.

An **output transformer** should be used in order to supply power to the winding of the reproducing unit. The optimum value of load resistance for a single tube is 2000 ohms. For push-pull operation, the plate-to-plate load resistance should be 4000 ohms. For best results, the impedance in the plate circuit of the 48 should be as uniform as possible over the entire audio-frequency range, as in the case of power amplifier pentodes.

As a **Class A amplifier triode**, the 48 may be used by connecting the screen to the plate at the socket. A pair of these tubes connected as triodes and operated with 105 volts on the plates and a grid-bias of -30 volts, are capable of approximately 2.0 watts output having a total harmonic distortion of less than two per cent. The plate-to-plate load for this condition is 1500 ohms.

The application of the 48 is limited to circuits having d-c heater supply. If the plate voltage is obtained from a 115-volt d-c power line, the negative grid-bias may be conveniently obtained from a small C-battery.

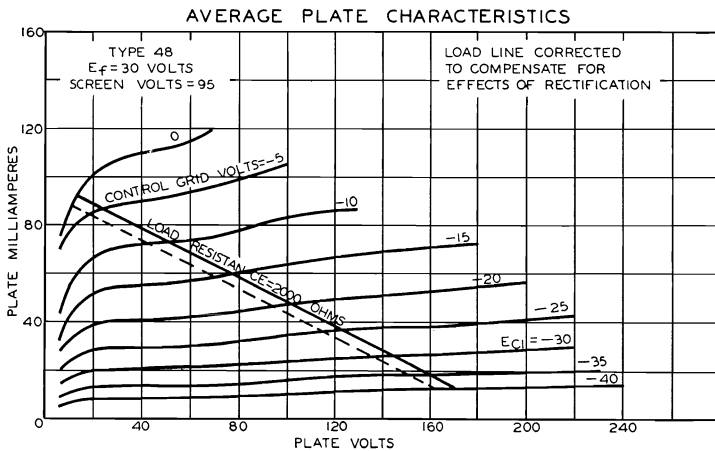

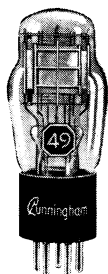

RCA Radiotron

**Cunningham
RADIO TUBES**

RCA-49

C-49

DUAL-GRID POWER AMPLIFIER

The 49 is a double-grid power-amplifier tube designed for use in battery-operated receivers employing 2-volt tubes. In such service, it may be used either as a Class B output tube or, by a change in socket connections, as a Class A driver tube.

CHARACTERISTICS

FILAMENT VOLTAGE (D. C.).....	2.0	Volts
FILAMENT CURRENT.....	0.12	Ampere
BULB (For dimensions, see Page 151, Fig. 11).....		ST-14
BASE (For socket connections, see Page 150, Fig. 7).....		Medium 5-Pin

As Class B Power Amplifier

PLATE VOLTAGE.....	180 <i>max.</i>	Volts
DYNAMIC PEAK PLATE CURRENT.....	50 <i>max.</i>	Milliamperes
TYPICAL OPERATION (2 tubes)		
Filament Voltage.....	2.0	Volts
Plate Voltage.....	180	Volts
Grid Voltage (Both grids tied together).....	0	Volts
Static Plate Current (Per tube).....	2	Milliamperes
Load Resistance (Plate-to-plate).....	12000	Ohms
Nominal Power Output (2 tubes).....	3.5	Watts

As Driver—Class A Amplifier

FILAMENT VOLTAGE.....	2.0	Volts
PLATE VOLTAGE.....	135 <i>max.</i>	Volts
GRID VOLTAGE (Grid adjacent to plate tied to plate).....	-20	Volts
PLATE CURRENT.....	5.7	Milliamperes
PLATE RESISTANCE.....	4000	Ohms
AMPLIFICATION FACTOR.....	4.5	
MUTUAL CONDUCTANCE.....	1125	Micromhos
LOAD RESISTANCE.....	11000*	Ohms
NOMINAL POWER OUTPUT.....	0.170	Watt

* Approximately twice this value is recommended for load of this tube as driver for Class B stage.

INSTALLATION

The **base** pins of the 49 fit the standard five-contact socket. The socket should be installed so that the tube will operate in a vertical position. In some cases, cushioning of the socket may be found desirable.

For **filament** operation, refer to INSTALLATION on Type 1A6.

APPLICATION

Class B amplifiers are discussed on page 14. Also refer to the Application section of the 46 on page 88.

THE RCA RADOTRON-CUNNINGHAM RADIO TUBE MANUAL

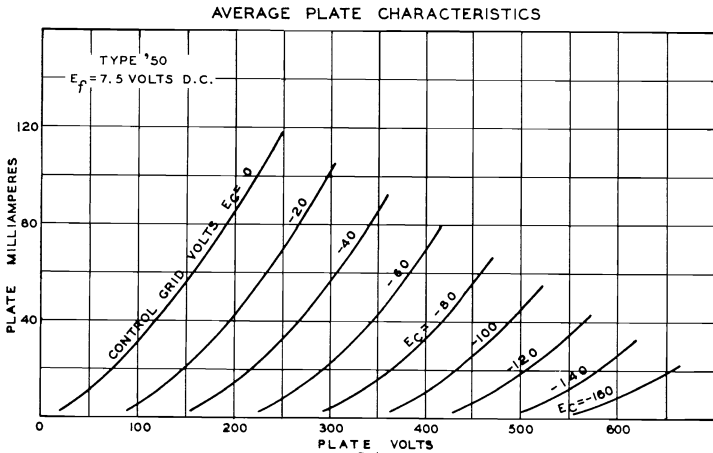
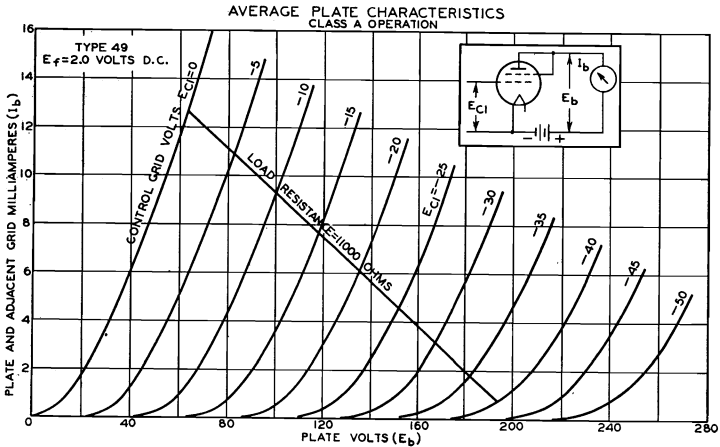
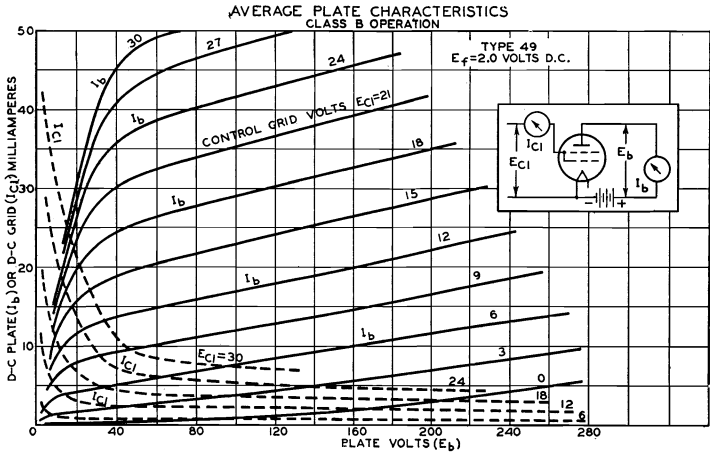

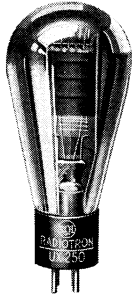

UX-250

CX-350

POWER AMPLIFIER

The '50 is a power amplifier tube designed for use primarily in the output stage of an audio-frequency amplifier employing transformer coupling. It is capable of delivering unusually large amounts of undistorted power.

CHARACTERISTICS

FILAMENT VOLTAGE (A. C. or D. C.).....	7.5	Volts
FILAMENT CURRENT.....	1.25	Amperes
PLATE VOLTAGE.....	350 400 450 <i>max.</i>	Volts
GRID VOLTAGE*.....	-63 -70 -84	Volts
PLATE CURRENT.....	45 55 55	Milliamperes
PLATE RESISTANCE.....	1900 1800 1800	Ohms
AMPLIFICATION FACTOR.....	3.8 3.8 3.8	
MUTUAL CONDUCTANCE.....	2000 2100 2100	Micromhos
LOAD RESISTANCE.....	4100 3670 4350	Ohms
UNDISTORTED POWER OUTPUT.....	2.4 3.4 4.6	Watts
BULB (For dimensions, see Page 151, Fig. 16).....		S-21
BASE (For socket connections see Page 150, Fig. 1).....		Medium 4-Pin Bayonet

* Measured from mid-point of a-c operated filament.

INSTALLATION

The **base** pins of the '50 fit the standard four-contact socket which should be mounted to hold the tube in a vertical position. Provision should be made for free circulation of air around the tube, since the bulb becomes quite hot during operation.

The coated **filament** is designed to operate from a 7.5-volt winding of a power transformer. However, if desirable, it may be operated equally as well from a d-c source. In either case the voltage applied to the filament terminals should be the rated value of 7.5 volts.

APPLICATION

As a **power amplifier**, the '50 should be operated as shown under CHARACTERISTICS. A plate family for the '50 is given on the preceding page. Grid-bias voltage may be conveniently obtained by means of the voltage drop through a resistor in the plate-return lead. The proper value of this resistor is 1400 ohms for a plate voltage of 350 volts; 1275 ohms for a plate potential of 400 volts; and 1530 ohms for a plate potential of 450 volts. The use of self-bias is advisable in all cases.

If more output is desired than can be obtained from a single '50, two '50's may be operated either in parallel or push-pull connection. See page 12. When two '50's are operated together in the same amplifier stage, the values of the self-biasing resistors will be approximately one-half those shown above for a single tube.

Any conventional type of input coupling may be used provided the resistance added to the grid circuit by this device does not exceed 10000 ohms. An output transformer should be connected in the plate circuit of the '50 in order to transfer power efficiently to the loudspeaker.

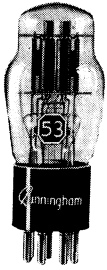

RCA Radiotron

Cunningham
RADIO TUBES

RCA-53

C-53

CLASS B TWIN AMPLIFIER

The 53 is a heater-cathode type of tube combining in one bulb two high-mu triodes designed for Class B operation. It is intended primarily for use in the output stage of a-c operated radio receivers. The triode units have separate external terminals for all electrodes except the cathodes and heaters, so that circuit design is similar to that of Class B amplifiers utilizing individual tubes in the output stage. The 53 may be used as a Class A amplifier (with triode units connected in parallel) to drive a 53 as a Class B amplifier in the output stage.

CHARACTERISTICS

HEATER VOLTAGE (A. C. or D. C.).....	2.5	Volts
HEATER CURRENT.....	2.0	Amperes
BULB (For dimensions, see Page 151, Fig. 11).....		ST-14
BASE (For socket connections, see Page 150, Fig. 24).....		Medium 7-Pin

As Class B Power Amplifier

PLATE VOLTAGE.....	300 <i>max.</i>	Volts
DYNAMIC PEAK PLATE CURRENT (Per plate).....	125 <i>max.</i>	Milliamperes
AVERAGE PLATE DISSIPATION.....	10 <i>max.</i>	Watts

TYPICAL OPERATION

Heater Voltage.....	2.5	Volts
Plate Voltage.....	250 300	Volts
Grid Voltage.....	0 0	Volts
Static Plate Current (Per plate).....	14 17.5	Milliamperes
Load Resistance (Plate-to-plate).....	8000 10000	Ohms
Nominal Power Output*.....	8 10	Watts

As Driver—Class A Amplifier

(Both grids connected together at socket; likewise both plates.)

HEATER VOLTAGE.....	2.5	Volts
PLATE VOLTAGE**.....	250 294	Volts
GRID VOLTAGE.....	-5 -6	Volts
AMPLIFICATION FACTOR.....	35 35	
PLATE RESISTANCE.....	11300 11000	Ohms
MUTUAL CONDUCTANCE.....	3100 3200	Micromhos
PLATE CURRENT.....	6 7	Milliamperes

*With average input of 350 milliwatts applied between grids.

** Maximum plate voltage = 300 volts.

INSTALLATION

The **base** pins of the 53 fit the seven-contact (0.855 inch pin-circle diameter) socket which may be installed to operate the tube in any position. Sufficient ventilation should be provided to circulate air freely around the tube to prevent overheating.

The **heater** is intended for a-c operation at 2.5 volts. The transformer winding supplying the heater circuit should be designed to operate the heater at this recommended value for full-load operating conditions at average line voltage.

The **cathode** should preferably be connected directly to a mid-tap on the heater winding. If this practice is not followed, the potential difference between heater and cathode should be kept as low as possible.

The **grids** for Class B and for Class A service should be connected so as to give resultant tube characteristics suited to the particular service. Detailed information on connections is given under APPLICATION.

APPLICATION

As a **Class B power amplifier**, the 53 is used in circuits similar in design to those utilizing individual tubes in the output stage. It requires no grid-bias, since the high- μ feature of the triode units reduces the steady plate current at zero bias to a relatively low value. Refer to page 14 for general Class B amplifier design considerations.

Two 53's can be operated in a Class B output stage with the two triode units of each 53 connected in parallel to give a power output of 20 watts, approximate, under conditions of 300 volts on the plates and of a 500-ohm plate-to-plate load.

As a **Class A amplifier triode**, the 53 may be employed in the driver stage of Class B amplifier circuits, and thus reduce the number of tube types necessary in a receiver. When operated in this way with a plate supply of 300 volts and corresponding grid-bias, the 53 is capable of supplying a power output upwards of 400 milliwatts. The load into which the driver works will depend largely on the design factors of the Class B amplifier. In general, however, the load will be between 20000 and 40000 ohms. For Class A amplifier-triode operation of the 53, the two grids are connected together at the socket; likewise, the two plates. These connections place the two triode units in parallel. Operation of the tube is then similar to any Class A power amplifier triode.

The d-c resistance in the grid circuit of the 53 when operated as a Class A amplifier may be as high as 0.5 megohm with self-bias. With fixed bias, however, the resistance should not exceed 0.1 megohm.

Among other and less conventional applications of the 53 are its use as (1) biased detector and one-stage a-f amplifier, (2) two-stage a-f amplifier, (3) amplifier and phase-inverter to supply resistance-coupled, push-pull output tubes, (4) two tube oscillator, and (5) oscillator and amplifier.

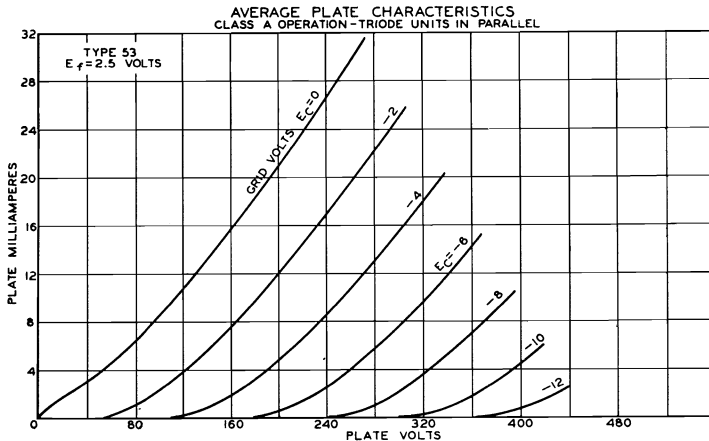

THE RCA RADIOTRON-CUNNINGHAM RADIO TUBE MANUAL

AVERAGE PLATE CHARACTERISTICS EACH TRIODE UNIT-CLASS B OPERATION

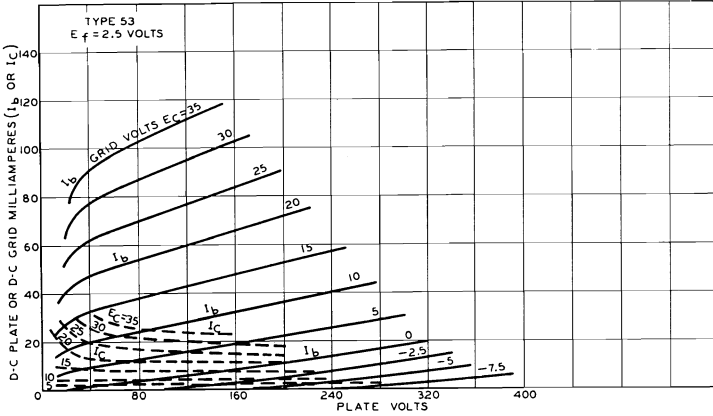

OPERATION CHARACTERISTICS

TYPE 53
 $E_f = 2.5$ VOLTS

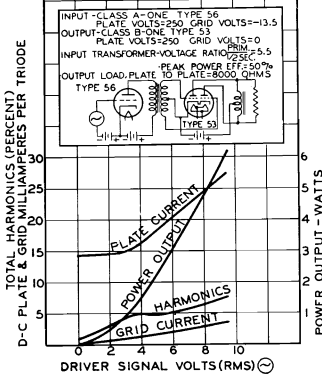

TWO STAGE A-F AMPLIFIER CIRCUIT

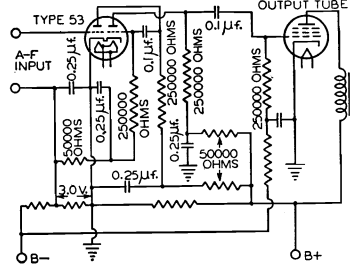
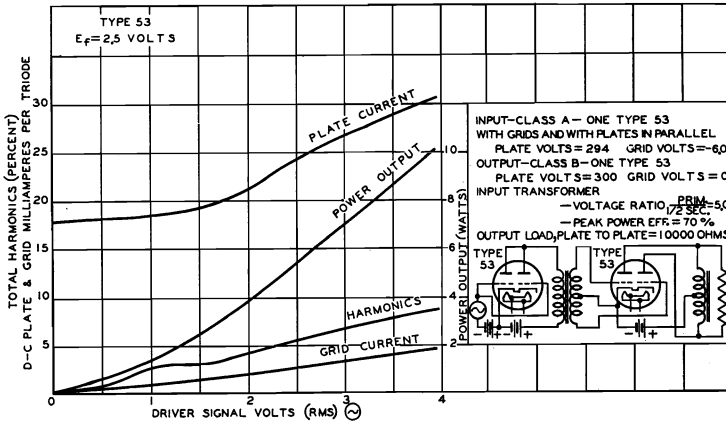

PLATE SUPPLY=250 VOLTS
GRID BIAS=-3 VOLTS
PLATE CURRENT (PER UNIT)=0.5 MILLIAMPERES (APPROX)
VOLTAGE AMPLIFICATION=26.8 PER UNIT
OVERALL VOLTAGE AMPLIFICATION=720
MAXIMUM A-F INPUT=0.08 VOLTS (RMS)
MAXIMUM A-F OUTPUT=57.5 VOLTS (RMS)
DISTORTION-NEGLIGIBLE

OPERATION CHARACTERISTICS





RCA-55

C-55

DUPLEX-DIODE TRIODE

The 55 is an a-c heater type of tube consisting of *two diodes* and a *triode* in a single bulb. It is recommended for service as a combined detector, amplifier and automatic-volume-control tube.

In operation, the two diodes and the triode are independent of each other except for the common cathode sleeve, which has one emitting surface for the diodes and another for the triode. This independence of operation permits of unusual flexibility in circuit arrangement and design. For example, the diodes of this tube can perform at the same time the functions of detection and of automatic volume-control (a.v.c.); while at the same time the triode may be used as an amplifier under its own optimum conditions. For diode-detector considerations, refer to page 17.

CHARACTERISTICS

HEATER VOLTAGE (A. C. or D. C.).....	2.5	Volts
HEATER CURRENT.....	1.0	Ampere
GRID-PLATE CAPACITANCE.....	1.5	$\mu\mu\text{f}$
GRID-CATHODE CAPACITANCE.....	1.5	$\mu\mu\text{f}$
PLATE-CATHODE CAPACITANCE.....	4.3	$\mu\mu\text{f}$
BULB (For dimensions, see Page 151, Fig. 7).....		ST-12
CAP.....		Small Metal
BASE (For socket connections, see Page 150, Fig. 13).....		Small 6-Pin

Triode Unit—As Class A Amplifier

HEATER VOLTAGE.....	2.5	Volts
PLATE VOLTAGE.....	135 180 250 <i>max.</i>	Volts
GRID VOLTAGE.....	-10.5 -13.5 -20.0	Volts
PLATE CURRENT.....	3.7 6.0 8.0	Milliamperes
PLATE RESISTANCE.....	11000 8500 7500	Ohms
AMPLIFICATION FACTOR.....	8.3 8.3 8.3	
MUTUAL CONDUCTANCE.....	750 975 1100	Micromhos
LOAD RESISTANCE.....	25000 20000 20000	Ohms
POWER OUTPUT.....	0.075 0.16 0.35	Watt

Diode Units

Two diode plates are placed around a cathode, the sleeve of which is common to the triode unit. Each diode plate has its own base pin. Operation curves for the diode units are given under Type 2B7.

INSTALLATION

The **base** pins of the 55 fit the standard six-contact socket which may be installed to operate the tube either in a vertical or in a horizontal position.

For **heater** operation and **cathode** connection, refer to INSTALLATION under Type 2A5.

Complete **shielding** of detector circuits employing the 55 is generally necessary to prevent r-f or i-f coupling between the diode circuits and the circuits of other stages.

APPLICATION

The 55 is recommended for performing the simultaneous functions of automatic volume-control, detection, and amplification.

For **detection**, the diodes may be utilized in a full-wave circuit or in a half-wave circuit. In the latter case, one plate only, or the two plates in parallel may be employed. The use of the half-wave arrangement will provide approximately twice the rectified voltage as compared with the full-wave arrangement.

For **automatic volume-control**, a rectified voltage which is dependent on the r-f or i-f carrier is usually employed. This voltage is utilized to regulate the gain of the r-f and/or i-f amplifier stages so as to maintain essentially constant-carrier input to the audio detector. The regulation of amplifier gain by means of the rectified voltage may be accomplished by a number of methods differing chiefly in the means of applying the voltage to the various electrodes of the amplifier tubes. As is well known, the regulating voltage may be applied to the control grids of the amplifier tubes. On the other hand, by less familiar methods, the voltage may, depending on the requirements of the designer, be applied to other electrodes. For example, the voltage may be applied to suppressor, plate and/or screen of an r-f pentode.

The complex structure of the 55 permits of obtaining automatic-volume-control voltage in a number of ways. In one case, the required voltage is obtained from the detector circuit by utilizing the voltage drop caused by the rectified current flowing through a resistor in the detector circuit. In another case, the required voltage is obtained by utilizing one diode for the sole purpose of automatic volume-control (a.v.c.). This latter method is of particular interest since it confines the sensitivity and time-delay function to the a.v.c. circuit. Time-delay action is, of course, determined by the use of a resistance and condenser combination having the desired time constant. The a.v.c. action may be postponed by applying a negative voltage to the a.v.c. diode plate. Another a.v.c. arrangement capable of various adaptations is to use the triode as a d-c amplifier to supply the regulating voltage. Additional information on automatic volume-control is given on page 18.

For **amplification**, the triode may be employed in conventional circuit arrangements. Representative conditions for resistance-coupled amplifier applications are given on page 142. Grid bias for the triode, depending upon circuit design, may be obtained from a fixed voltage tap on the d-c power supply or may be obtained by utilizing the variable voltage drop caused by the rectified current flowing through a resistor in the detector circuit. In this connection, it should be noted that the circuits on page 128 designate this latter arrangement as "Diode-Biased Amplifier." Diode biasing of the triode unit may be employed only when at least 20000 ohms resistance is used in the triode plate circuit.

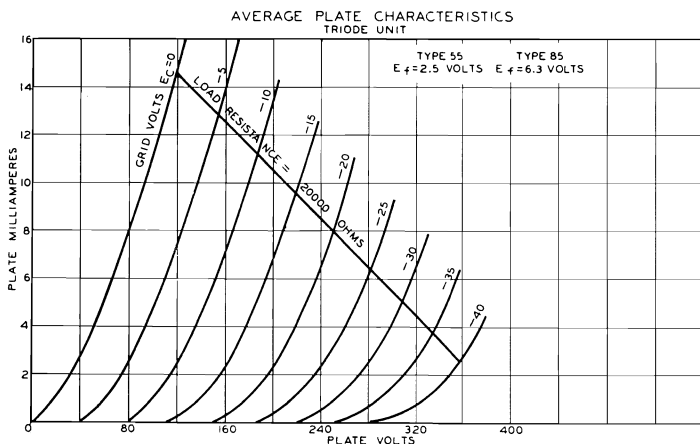

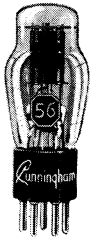

RCA Radiotron

**Cunningham
RADIO TUBES**

RCA-56

C-56

SUPER-TRIODE AMPLIFIER, DETECTOR

The 56 is a three-electrode tube of the uni-potential heater-cathode type recommended for use as detector, amplifier, or oscillator in a-c receivers designed for it. This tube is characterized by its high mutual conductance, and its comparatively high amplification factor. The 56 is useful in resistance-coupled audio-frequency amplifiers.

CHARACTERISTICS

HEATER VOLTAGE (A. C. or D. C.).....	2.5	Volts
HEATER CURRENT.....	1.0	Ampere
PLATE VOLTAGE.....	250 <i>max.</i>	Volts
GRID VOLTAGE*.....	-13.5	Volts
PLATE CURRENT.....	5	Milliamperes
PLATE RESISTANCE.....	9500	Ohms
AMPLIFICATION FACTOR.....	13.8	
MUTUAL CONDUCTANCE.....	1450	Micromhos
GRID-PLATE CAPACITANCE.....	3.2	$\mu\mu\text{f}$
GRID-CATHODE CAPACITANCE.....	3.6	$\mu\mu\text{f}$
PLATE-CATHODE CAPACITANCE.....	2.5	$\mu\mu\text{f}$
BULB (For dimensions, see Page 151, Fig. 6).....		ST-12
BASE (For socket connections, see Page 150, Fig. 8).....		Small 5-Pin

* If a grid coupling resistor is used, its maximum value should not exceed 1.0 megohm.

INSTALLATION

The **base** pins of the 56 fit the standard five-contact socket which may be installed to hold the tube either in a vertical or in a horizontal position.

The **bulb** of this tube will become very hot under certain conditions of operation. Sufficient ventilation should be provided to prevent overheating.

The **heater** is designed to operate at 2.5 volts. The transformer winding supplying the heater circuit should be designed to operate the heater at this recommended value for full-load operating conditions at average line voltage.

The **cathode** should preferably be connected directly to a mid-tap on the heater winding or to a center-tapped resistor across the heater winding. If this practice is not followed, the potential difference should be kept as low as possible.

APPLICATION

As an **amplifier**, the 56 is applicable either to radio-frequency or audio-frequency circuits. Recommended operating conditions for service using transformer coupling are given under CHARACTERISTICS. For circuits utilizing resistance coupling, typical operating conditions are as follows: Plate supply voltage, 250 volts; grid-bias voltage, -9 volts (approximate); plate load resistor, 50000 to 100000 ohms; and plate current, 1 to 2 milliamperes.

As a **detector**, the 56 may be of the grid leak and condenser or grid-bias type. The plate voltage for the grid leak and condenser method should be about 45 volts. A grid leak of from 1 to 5 megohms with a grid condenser of 0.00025 μf is satisfactory. For the grid-bias method of detection, the maximum plate-supply voltage of 250 volts may be used together with a negative grid-bias voltage of approximately 20 volts. The plate current should be adjusted to 0.2 milliamperes with no input signal voltage. The grid-bias voltage may be supplied from the voltage drop in a resistor between cathode and ground. The value of this self-biasing resistor is not critical, 100000 to 150000 ohms being suitable. The higher value will permit the application of a larger input signal.

THE RCA RADOTRON-CUNNINGHAM RADIO TUBE MANUAL

AVERAGE PLATE CHARACTERISTICS

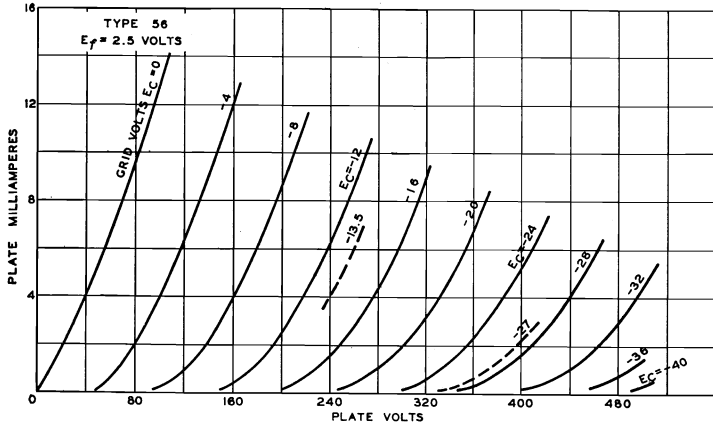

AVERAGE PLATE CHARACTERISTICS

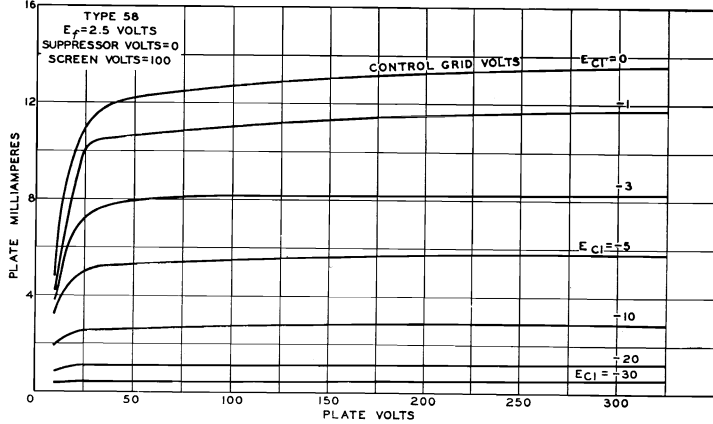

AVERAGE CHARACTERISTICS

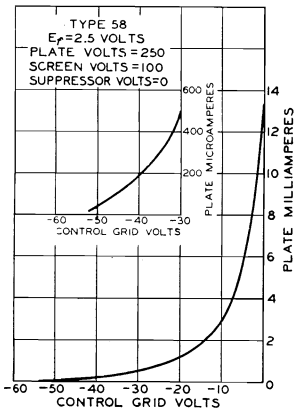

AVERAGE CHARACTERISTICS

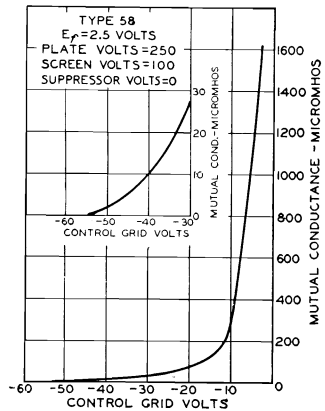



RCA-57

C-57

TRIPLE-GRID DETECTOR AMPLIFIER

The 57 is a triple-grid tube recommended especially for service as a biased detector in a-c receivers designed for its characteristics. In such service, this tube is capable of delivering a large audio-frequency output voltage with relatively small input voltage. Other applications of the 57 include its use as a low signal-input, screen grid amplifier tube and as an automatic-volume-control tube. Significant among its electrical features are its sharp plate current "cut-off" with respect to grid voltage, and its adaptability of electrode combinations to unusual circuit applications.

CHARACTERISTICS

HEATER VOLTAGE (A. C. or D. C.).....	2.5	Volts
HEATER CURRENT.....	1.0	Ampere
PLATE VOLTAGE.....	250 <i>max.</i>	Volts
SCREEN VOLTAGE.....	100 <i>max.</i>	Volts
GRID VOLTAGE.....	-3	Volts
SUPPRESSOR.....	Connected to cathode at socket	
PLATE CURRENT.....	2.0	Milliamperes
SCREEN CURRENT.....	0.5	Milliampere
PLATE RESISTANCE.....	Greater than 1.5	Megohms
AMPLIFICATION FACTOR.....	Greater than 1500	
MUTUAL CONDUCTANCE.....	1225	Micromhos
GRID VOLTAGE*.....	-7 <i>approx.</i>	Volts
GRID-PLATE CAPACITANCE (With shield-can).....	0.007 <i>max.</i>	$\mu\mu\text{f}$
INPUT CAPACITANCE.....	5.2	$\mu\mu\text{f}$
OUTPUT CAPACITANCE.....	6.8	$\mu\mu\text{f}$
BULB (For dimensions, see Page 151, Fig. 8).....		ST-12
CAP.....		Small Metal
BASE (For socket connections, see Page 150, Fig. 11).....		Small 6-Pin

* For cathode current cut-off.

INSTALLATION

The **base** pins of the 57 fit the standard six-contact socket which may be installed to hold the tube either in a vertical or in a horizontal position.

For **heater** operation and **cathode** connection, refer to INSTALLATION for Type 56.

The **screen** voltage may be obtained from a potentiometer or bleeder circuit across the B-supply source. Due to the screen current characteristics of the 57, the use of a resistor in series with the high-voltage supply may be employed for obtaining the screen voltage provided the cathode-resistor method of bias control is used. This method, however, is not recommended if the high-voltage B-supply exceeds 250 volts.

Complete **shielding** of detector circuits employing the 57 is generally necessary, since considerable voltage at carrier frequency is usually present in the plate circuit even though the latter is by-passed with a low impedance capacitor. Two-section filters in the plate circuit are frequently necessary to prevent radio-frequency feedback to the input of the detector.

In receivers employing a built-in loudspeaker, acoustic shielding may be necessary to prevent microphonic feed-back when a strong radio-frequency carrier voltage is present on the tube elements. It should be noted also that condenser plates may cause an audio howl due to mechanical feed-back from the speaker.

APPLICATION

As a **biased detector**, the 57 is particularly recommended because of its ability to deliver a large audio-frequency output voltage of good quality with a fairly small radio-frequency signal input. Recommended conditions for the 57 as a biased detector are as follows:

HEATER VOLTAGE.....				2.5	Volts
PLATE SUPPLY †.....	250	250	250	250	Volts
SCREEN VOLTAGE.....	50	33	100 max.	100 max.	Volts
GRID VOLTAGE.....	-2	-1.7	-3.9	-4.3	Volts
CATHODE RESISTOR.....	3000	8000	4000	10000	Ohms
SUPPRESSOR.....	Connected to cathode at socket				
CATHODE CURRENT (No signal).....	0.65	0.21	0.97	0.43	Milliamperes
PLATE RESISTOR.....	0.25	0.50	0.25	0.50	Megohm
BLOCKING CONDENSER.....	0.03	0.03	0.03	0.03	μf
GRID RESISTOR **.....	0.25	0.25	0.25	0.25	Megohm
R-F SIGNAL (RMS) °°.....	1.18	1.21	1.38	1.37	Volts

† Voltage at plate will be PLATE SUPPLY voltage minus voltage drop in plate resistor caused by plate current.

** For the following amplifier tube.

°° With these signal voltages modulated 20%, the voltage output under each set of operating conditions is 17 peak volts at the grid of the following amplifier, a value sufficient to insure full audio output from a type 2A5.

Detector bias may be obtained from a bleeder circuit, from a resistor in the cathode circuit, or from a partial self-biasing circuit. The cathode-resistor method permits of higher output at low percentage modulation since the input signal may be increased almost in inverse proportion to the modulation without resulting in objectionable distortion.

As an **audio-frequency amplifier** in resistance-coupled circuits, the 57 may be operated under the following conditions: Plate supply voltage, 250 volts, applied through a plate coupling resistor of 250000 ohms; screen voltage, 100 volts; plate current, 0.75 ma., approx.; grid voltage, -4.5 volts. The grid resistor should have a value not exceeding 1.0 megohm.

As a **radio-frequency amplifier**, the 57 may be used particularly in applications where the r-f signal applied to the grid is relatively low, that is, of the order of a few volts. In such cases either screen or control-grid voltage (or both) may be varied to control the receiver volume. When larger signals are involved, a super-control amplifier tube should be employed to prevent the occurrence of excessive cross-modulation and modulation-distortion. Recommended operating conditions for amplifier service are given under CHARACTERISTICS.

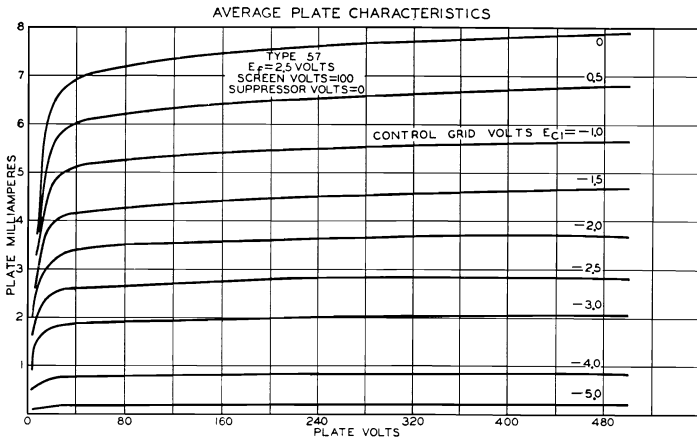



RCA Radiotron

Cunningham
RADIO TUBES

RCA-58

C-58

TRIPLE-GRID SUPER-CONTROL AMPLIFIER

The 58 is a triple-grid super-control amplifier tube recommended especially for service in the radio-frequency and intermediate-frequency stages of a-c receivers designed for its characteristics. Significant among its electrical features are the extended mutual conductance operating range and the adaptability of electrode combinations to various circuit applications. The ability of this tube to handle usual signal voltages without cross-modulation and modulation-distortion makes it adaptable to the r-f and i-f stages of receivers employing automatic volume-control.

When the suppressor is not connected directly to the cathode, its utility may be extended. The suppressor, in suitable circuits, provides a means for obtaining the desirable conditions of reduced selectivity for local reception. This operational characteristic makes possible improved loudspeaker response when the receiver is tuned to powerful nearby stations.

CHARACTERISTICS

HEATER VOLTAGE (A. C. or D. C.).....	2.5	Volts
HEATER CURRENT.....	1.0	Ampere
PLATE VOLTAGE.....	250 <i>max.</i>	Volts
SCREEN VOLTAGE.....	100 <i>max.</i>	Volts
GRID VOLTAGE.....	-3 <i>min.</i>	Volts
SUPPRESSOR.....	Connected to cathode at socket	
PLATE CURRENT.....	8.2	Milliamperes
SCREEN CURRENT.....	2.0	Milliamperes
PLATE RESISTANCE.....	800000	Ohms
AMPLIFICATION FACTOR.....	1280	
MUTUAL CONDUCTANCE.....	1600	Micromhos
MUTUAL CONDUCTANCE (At -40 volts bias).....	10	Micromhos
GRID-PLATE CAPACITANCE (With shield-can).....	0.007 <i>max.</i>	$\mu\mu\text{f}$
INPUT CAPACITANCE.....	5.2	$\mu\mu\text{f}$
OUTPUT CAPACITANCE.....	6.8	$\mu\mu\text{f}$
BULB (For dimensions, see Page 151, Fig. 8).....		ST-12
CAP.....		Small Metal
BASE (For socket connections, see Page 150, Fig. 11).....		Small 6-Pin

INSTALLATION

The **base** pins of the 58 fit the standard six-contact socket which may be installed to hold the tube either in a vertical or in a horizontal position.

For **heater** operation and **cathode** connections, refer to INSTALLATION for Type 56.

Control-grid bias variation will be found effective in changing the volume of the receiver. In order to obtain adequate volume control, an available grid-bias voltage of approximately 50 volts will be required. The exact value will depend upon the circuit design and operating conditions. This voltage may be obtained, depending on receiver requirements, from a potentiometer across a fixed supply voltage or by the use of a variable self-bias resistor in the cathode circuit.

The **screen** voltage may be obtained from a potentiometer or bleeder circuit across the B-supply source. Due to the screen current characteristics of the 58, a resistor in series with the high-voltage supply may be employed for obtaining the screen voltage provided the cathode-resistor method of bias control is used. This method, however, is not recommended if the high-voltage B-supply exceeds 250 volts. Furthermore, it should be noted that the use of a resistor in the screen circuit will have an effect on the change in plate resistance with variation in suppressor voltage in case the suppressor is utilized for control purposes.

The **suppressor** may be connected directly to the cathode or it may be made negative with respect to the cathode. For the latter condition, the suppressor voltage may be obtained from a potentiometer or bleeder circuit for manual volume- and selectivity-control, or from the drop in a resistor in the plate circuit of the automatic-volume-control tube.

Shielding requirements are similar to those for Type 57.

APPLICATION

As a **radio-frequency amplifier**, the 58 is especially applicable to radio receiver design because of its ability to reduce cross-modulation effects, its remote "cut-off" feature, and its flexible adaptability to circuit combinations and to receiver design. Recommended conditions for the 58 as an amplifier are given under CHARACTERISTICS. Characteristics curves are given at the bottom of page 103.

To realize the maximum benefit of the long "cut-off" feature of this tube, it is necessary to apply a variable grid bias and to maintain the screen at a constant potential with respect to the cathode. However, good results may be obtained by using a variable cathode resistance which, of course, reduces the screen potential with respect to the cathode by the same amount that the bias is increased, thus hastening the "cut-off" and reducing the ability of the tube to handle large signals. This undesirable effect may be nullified by means of a series resistor in the screen circuit.

The use of series resistors for obtaining satisfactory control of screen voltage in the case of four-electrode tubes is usually impossible because of secondary emission phenomena. In the 58, however, the suppressor practically removes these effects and it is therefore possible to obtain satisfactorily the screen voltage from the plate supply or from some high intermediate voltage providing these sources do not exceed 250 volts. With this method, the screen-to-cathode voltage will fall off very little from minimum to maximum value of cathode-control resistor. In some cases, it may actually rise. This rise of screen-to-cathode voltage above the normal maximum value is allowable because the screen and the plate current are reduced simultaneously by a sufficient amount to prevent damage to the tube. It should be recognized in general that the series-resistor method of obtaining screen voltage from a higher voltage supply necessitates the use of the variable cathode-resistor method of controlling volume. When screen and control-grid voltages are obtained in this manner, the remote "cut-off" advantage of the 58 may be fully realized.

As a **mixer** in superheterodyne circuits, the 58 may be used to advantage. It is capable of producing under the proper conditions of grid and local oscillator voltage, a gain in the mixer stage of about one-third that which can be obtained in an intermediate-frequency amplifier stage. In addition, this gain can be controlled as in the case of the radio-frequency amplifier by varying the grid bias either from a separate supply or from a variable resistor in the cathode circuit. This is a particularly desirable feature in receivers employing automatic volume-control, because it enables a much lower threshold input to be received without loss of amplification and permits the reception of high input voltages without loss of control. Recommended conditions for the 58 as a superheterodyne mixer follow: Plate voltage, 250 volts; screen voltage, 100 volts; suppressor, connected to cathode at socket; and grid-bias voltage, -10 volts minimum (with 9-volt oscillator peak swing). With an oscillator peak swing of 1 volt less than the grid-bias, these values are not critical and may be chosen to meet circuit design requirements.



RCA-59

C-59

TRIPLE-GRID POWER AMPLIFIER

The 59 is a triple-grid power amplifier tube of the heater-cathode type recommended for the use in the output stage of a-c operated receivers. The triple-grid construction of this tube, with external connections for each grid, makes possible its application as (1) a Class A Power Amplifier Triode, (2) a Class A Power Output Pentode, and (3) a Class B Power Output Triode.

CHARACTERISTICS

HEATER VOLTAGE (A. C. or D. C.).....	2.5	Volts
HEATER CURRENT.....	2.0	Amperes
BULB (For dimensions, see Page 151, Fig. 13).....		ST-16
BASE (For socket connections, see Page 150, Fig. 18).....		Medium 7-Pin

Class B Power Amplifier—Triode Connection

(Grids No. 1 and No. 2 tied together; grid No. 3 tied to plate)

PLATE VOLTAGE.....	400 max.	Volts
DYNAMIC PEAK PLATE CURRENT.....	200 max.	Milliamperes
AVERAGE PLATE DISSIPATION.....	10 max.	Watts
AVERAGE GRID DISSIPATION (Grids No. 1 and No. 2 together).....	1.5 max.	Watts
TYPICAL OPERATION (2 tubes)		
Heater Voltage.....	2.5	Volts
Plate Voltage.....	300 400	Volts
Grid Voltage (Grids No. 1 and No. 2 together).....	0 0	Volts
Static Plate Current (Per tube).....	10 13	Milliamperes
Load Resistance (Plate-to-plate).....	4600 6000	Ohms
Nominal Power Output (2 tubes).....	15 20	Watts

Class A Power Amplifier

	Triode ^o	Pentode ^{oo}	
HEATER VOLTAGE.....	2.5	2.5	Volts
PLATE VOLTAGE.....	250 max.	250 max.	Volts
SCREEN VOLTAGE (Grid No. 2).....	—	250 max.	Volts
GRID VOLTAGE (Grid No. 1).....	-28	-18	Volts
AMPLIFICATION FACTOR.....	6	100	
PLATE RESISTANCE.....	2400	40000	Ohms
MUTUAL CONDUCTANCE.....	2600	2500	Micromhos
PLATE CURRENT.....	26	35	Milliamperes
SCREEN CURRENT.....	—	9	Milliamperes
LOAD RESISTANCE.....	5000*	6000	Ohms
POWER OUTPUT.....	1.25	3.0**	Watts

^o Grids No. 2 and No. 3 tied to plate.

^{oo} Grid No. 3 tied to cathode.

* Optimum for maximum undistorted power output of 1.25 watts. Approximately twice this value is recommended for load of this type as driver for Class B stage.

** 7% total harmonic distortion.

INSTALLATION

The **base** of the 59 is of the medium 7-pin type. Its pins fit the seven-contact (0.855 inch pin-circle diameter) socket which may be installed to operate the tube in any position.

The **bulb** of this tube may become very hot under certain conditions of operation. Sufficient ventilation, therefore, should be provided to circulate air freely around the tube to prevent overheating.

For **heater** operation and **cathode** connection, refer to INSTALLATION for Type 56.

APPLICATION

For **Class A Triode Operation** of the 59, the two grids (No. 3 and No. 2) immediately adjacent to the plate are connected to the plate, while the third (No. 1) is employed for control purposes. Operation of the tube is then similar to any Class A power amplifier triode. The tabulated values for Class A operation of this type as given under CHARACTERISTICS, are for its operation as a power output tube. When it is used as the driver for a Class B stage, the load requirements are changed, as indicated in the note under CHARACTERISTICS. This change is recommended in order to minimize distortion due to the driver stage.

The d-c resistance in the grid circuit of the 59 operating as a Class A amplifier (either with triode or pentode connection) should not exceed 0.5 megohm if self-bias is used. Without self-bias, the resistance should not exceed 10000 ohms. The use of resistances higher than these may cause the tube to lose bias due to grid current with the result that the plate current will rise to a value sufficiently high to damage the tube.

For **Class A Pentode Operation** of the 59, the grid (No. 3) adjacent to the plate is tied to the cathode and thus serves as the suppressor, while the other two grids (No. 2 and No. 1) serve as the screen-grid and control-grid respectively. Operation of the tube is then similar to any Class A power output pentode.

For **Class B Triode Operation** of the 59, the grid (No. 3) adjacent to the plate is tied to the plate, while the other grids (No. 2 and No. 1) are connected together to serve as a single control-grid. No grid bias is necessary with this connection. This feature is particularly important because it prevents the variation of bias with applied signal which would otherwise exist if any self-bias arrangement were employed. A discussion of Class B design features is given on page 14.

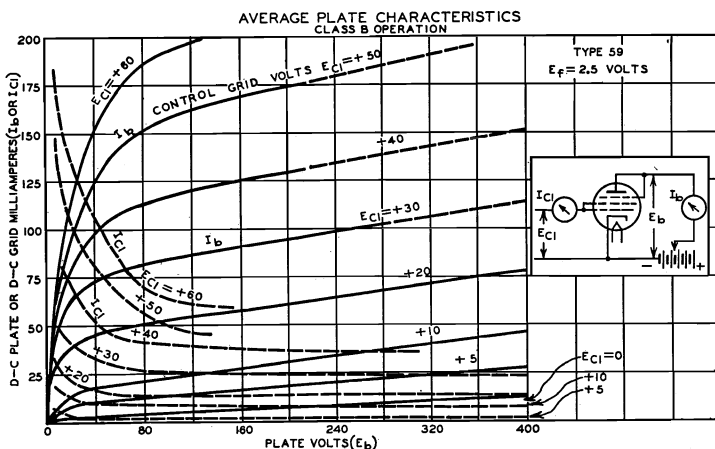

THE RCA RADIOTRON-CUNNINGHAM RADIO TUBE MANUAL

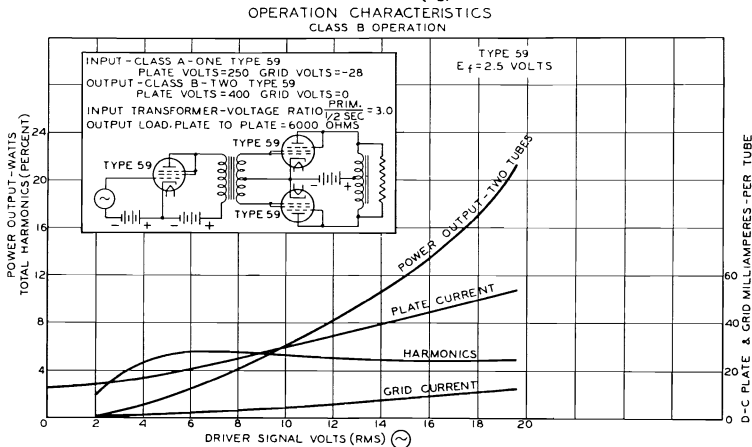
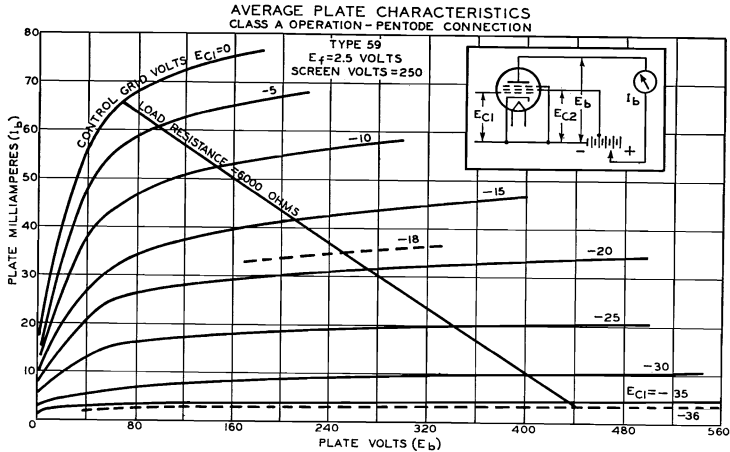
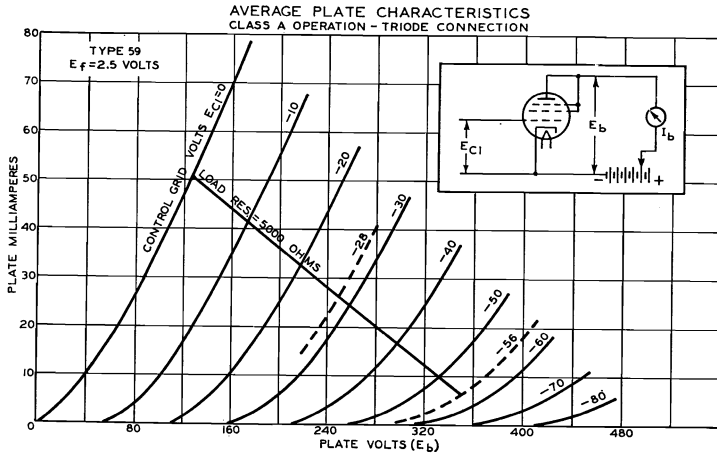

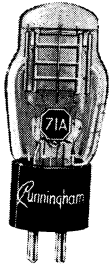

RCA Radiotron

**Cunningham
RADIO TUBES**

RCA-71-A

C-71-A

POWER AMPLIFIER

The 71-A is a power amplifier tube of low output impedance for use in the output stage of audio-frequency amplifiers.

CHARACTERISTICS

FILAMENT VOLTAGE (D. C.).....	5.0	Volts
FILAMENT CURRENT.....	0.25	Ampere
PLATE VOLTAGE.....	90 135 180 <i>max.</i>	Volts
GRID VOLTAGE*.....	-16.5 -27 -40.5	Volts
PLATE CURRENT.....	10 17.3 20	Milliamperes
PLATE RESISTANCE.....	2170 1820 1750	Ohms
AMPLIFICATION FACTOR.....	3 3 3	
MUTUAL CONDUCTANCE.....	1400 1650 1700	Micromhos
LOAD RESISTANCE.....	3000 3000 4800	Ohms
UNDISTORTED POWER OUTPUT.....	0.125 0.4 0.79	Watts
BULB (For dimensions, see Page 151, Fig. 11).....		ST-14
BASE (For socket connections, see Page 150, Fig. 1).....		Medium 4-Pin

* For operation on a-c filament supply, increase grid-bias voltage 2.5 volts.

INSTALLATION

The **base** pins of this tube fit the standard four-contact socket. The socket should be installed so that the tube will operate in a vertical position.

The coated **filament** of the 71-A may be operated from a storage battery or from the a-c line through a step-down transformer. For operation of this tube from a storage battery, a fixed or variable resistor of suitable value is required to reduce the battery voltage to 5.0 volts across the filament terminals at the socket.

APPLICATION

Operating conditions are given under CHARACTERISTICS for the use of this tube in the power output stage. A family of plate characteristics is given on page 113.

With a d-c filament supply, the grid- and the plate-return should be made to the negative filament terminal. For a-c filament supply, the plate- and the grid-return should be brought either to a mid-tapped resistor of 20 to 40 ohms across the filament winding, or to a mid-tap of the filament winding.

Grid bias for the 71-A may be obtained from a C-battery or by means of the voltage drop in a resistor connected in the negative plate-return lead. This second method is known as the self-biasing method, since the plate current determines the drop. It is not, however, generally applicable to battery-operated receivers. The proper value of this resistor for a plate voltage of 180 volts is 2150 ohms; for a plate voltage of 135 volts, 1700 ohms; and for 90 volts, 1600 ohms.

If more output is desired than can be obtained from a single 71-A, two 71-A's may be operated either in parallel or push-pull connection. When two 71-A's are operated together in the same amplifier stage, the values of the self-biasing resistors will be approximately one-half the values given above for a single tube.

An **output device** should be used to transfer power to the winding of the reproducing unit.

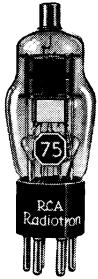

RCA-75

C-75

DUPLIX-DIODE HIGH-MU TRIODE

The 75 is a 6.3-volt heater type of tube consisting of two diodes and a high-mu triode in a single bulb. It is for use as a combined detector, amplifier, and automatic-volume-control tube in radio receivers designed for its characteristics. It is especially useful in automobile receivers where the heater supply is obtained from a storage battery. For diode-detector considerations, refer to page 17.

CHARACTERISTICS

Table with 3 columns: Characteristic, Value, and Unit. Includes Heater Voltage (6.3 Volts), Heater Current (0.3 Ampere), Grid-Plate Capacitance (1.7 μμf), Grid-Cathode Capacitance (1.7 μμf), Plate-Cathode Capacitance (3.8 μμf), Bulb (ST-12), Cap. (Small Metal), and Base (Small 6-Pin).

Triode Unit—As Class A Amplifier

Table with 3 columns: Characteristic, Value, and Unit. Includes Heater Voltage (6.3 Volts), Plate Voltage (250 max. Volts), Grid Voltage (-2 Volts), Amplification Factor (100), Plate Resistance (91000 Ohms), Mutual Conductance (1100 Micromhos), and Plate Current (0.8 Milliampere).

Diode Units

The two diode plates are placed around a cathode, the sleeve of which is common to the triode unit. Each diode plate has its own base pin. Operation curves for the diode units are given under Type 2B7, page 41.

INSTALLATION

The base pins of the 75 fit the standard six-contact socket which may be installed to hold the tube in any position.

Heater operation and cathode connection are the same as for the 6A7.

APPLICATION

The 75 in many respects is similar in application to the 55. The outstanding difference, however, is that the 75 has a high-mu triode. For this reason, the tube is recommended for use only in resistance-coupled circuits. Furthermore, diode-biasing of the triode unit is not suitable because of the probability of triode plate current cut-off even with relatively small signal voltages applied to the diode circuit.

As an amplifier in resistance-coupled a-f circuits the 75 may be operated under the conditions given on page 142. A family of plate characteristics is given on the next page.

THE RCA RADIOTRON-CUNNINGHAM RADIO TUBE MANUAL

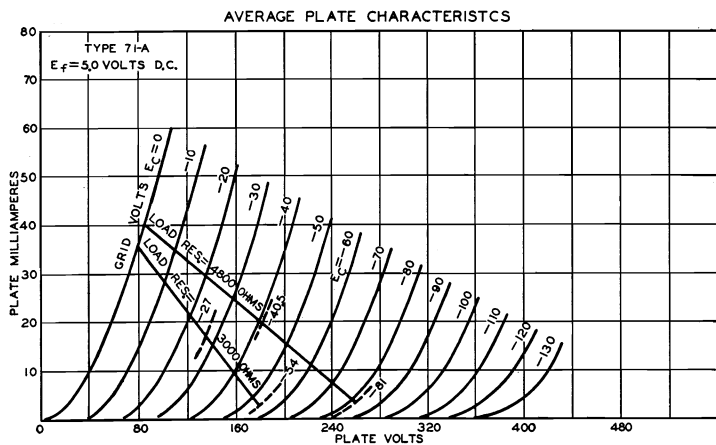
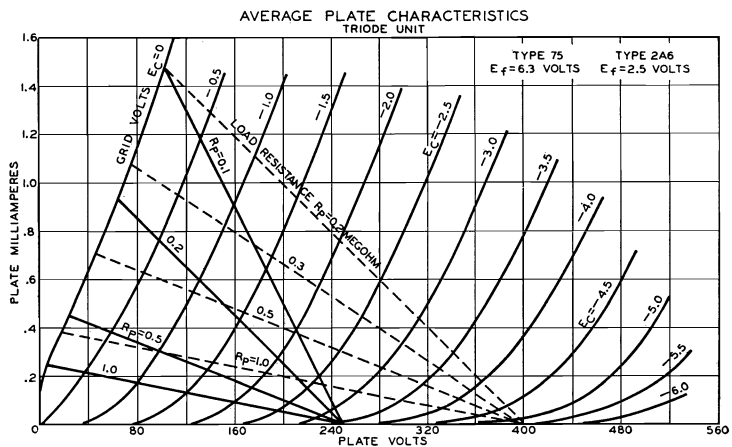



RCA Radiotron

**Cunningham
RADIO TUBES**

RCA-77

C-77

TRIPLE-GRID DETECTOR AMPLIFIER

The 77 is a triple-grid tube recommended especially for service as a biased detector in radio receiver designed for its characteristics, especially those of the mobile type employing a 6-volt heater supply. In such service, this tube is capable of delivering a large audio-frequency output voltage with relatively small input voltage.

Other applications of the 77 include its use as a low-signal-input screen-grid amplifier tube and as an automatic-volume-control tube.

CHARACTERISTICS

HEATER VOLTAGE (A. C. or D. C.).....	6.3	Volts
HEATER CURRENT.....	0.3	Ampere
PLATE VOLTAGE.....	100	250 <i>max.</i> Volts
SCREEN VOLTAGE.....	60	100 <i>max.</i> Volts
GRID VOLTAGE.....	-1.5	-3 Volts
SUPPRESSOR.....	Connected to cathode at socket	
PLATE CURRENT.....	1.7	2.3 Milliampere
SCREEN CURRENT.....	0.4	0.6 Milliampere
PLATE RESISTANCE.....	0.65	1.5 <i>approx.</i> Megohms
AMPLIFICATION FACTOR.....	715	1500 <i>approx.</i>
MUTUAL CONDUCTANCE.....	1100	1250 Micromhos
GRID VOLTAGE*.....	-5.5	-7.5 <i>approx.</i> Volts
GRID-PLATE CAPACITANCE (With shield-can).....	0.007 <i>max.</i>	$\mu\mu\text{f}$
INPUT CAPACITANCE.....	4.4	$\mu\mu\text{f}$
OUTPUT CAPACITANCE.....	10.6	$\mu\mu\text{f}$
BULB (For dimensions, see Page 151, Fig. 7).....		ST-12
CAP.....		Small Metal
BASE (For socket connections, see Page 150, Fig. 11).....		Small 6-Pin

* For cathode current cut-off.

INSTALLATION

The **base** pins of the 77 fit the standard six-contact socket which may be installed to hold the tube in any position.

For **heater** operation and **cathode** connection, refer to INSTALLATION under Type 6A7.

Shielding requirements are similar to those for the Type 57.

APPLICATION

As a biased **detector**, the 77 is particularly recommended because of its ability to deliver a large audio-frequency output voltage of good quality with a fairly small radio-frequency signal input. Recommended conditions for the 77 as a biased detector are as follows:

THE RCA RADOTRON-CUNNINGHAM RADIO TUBE MANUAL

HEATER VOLTAGE.....				6.3	Volts
PLATE SUPPLY †.....	100	250	250		Volts
SCREEN VOLTAGE.....	36	50	100 max.		Volts
GRID VOLTAGE.....	-2	-2	-4.3		Volts
CATHODE RESISTOR.....	12500	3000	10000		Ohms
SUPPRESSOR.....	Connected to cathode at socket				
CATHODE CURRENT (No signal).....	0.16	0.65	0.43		Milliampere
PLATE RESISTOR.....	0.25	0.25	0.50		Megohm
BLOCKING CONDENSER.....	0.01	0.03	0.03		μf
GRID RESISTOR **.....	0.25	0.25	0.25		Megohm
R-F SIGNAL (RMS) °°.....	1.88	1.18	1.37		Volts

† Voltage at plate will be PLATE SUPPLY voltage minus voltage drop in plate resistor caused by plate current.

** For the following amplifier tube.

°° With these signal voltages modulated 20%, the voltage output for the 100-volt plate supply is 14 peak volts at the grid of the following amplifier, a value sufficient to insure full audio output from a type 43; likewise, for the 250-volt conditions, 17 peak volts, a value sufficient to insure full audio output from a type 2A5.

Detector bias may be obtained from a bleeder circuit, from a resistor in the cathode circuit, or from a partial self-biasing circuit. The cathode-resistor method permits of higher output at low percentage modulation since the input signal may be increased almost in inverse proportion to the modulation without resulting in objectionable distortion.

As an **audio-frequency amplifier** in resistance-coupled circuits, the 77 may be operated as shown on page 142.

As a **radio-frequency amplifier**, the 77 may be used particularly in applications where the r-f signal applied to the grid is relatively low, that is, of the order of a few volts. In such cases either screen or control-grid voltage (or both) may be varied to control the receiver volume. When larger signals are involved, a super-control amplifier tube should be employed to prevent the occurrence of excessive cross-modulation and modulation-distortion. Recommended operating conditions for amplifier service are given under CHARACTERISTICS.

As a **mixer** in superheterodyne circuits, the 77 may be employed but a tube having super-control characteristics is to be preferred, especially if signals of large magnitude are to be received, and if supplementary volume control is to be obtained in this stage.

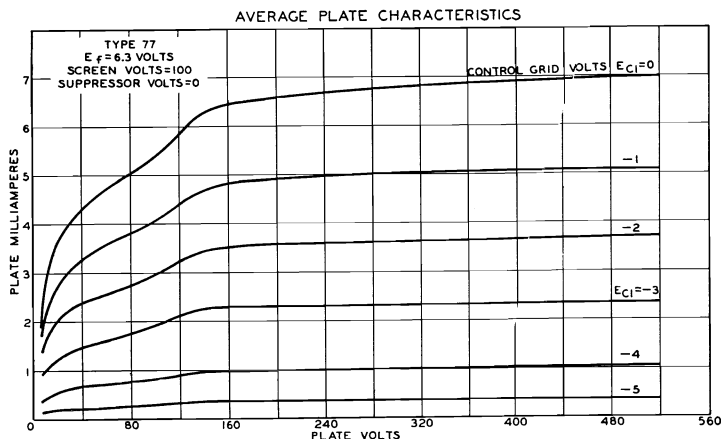



RCA-78

C-78

TRIPLE-GRID SUPER-CONTROL AMPLIFIER

The 78 is a triple-grid super-control amplifier tube recommended for service in the radio-frequency and intermediate-frequency stages of radio receivers designed for its characteristics, especially those of the mobile type employing a 6-volt heater supply. The ability of this tube to handle usual signal voltages without cross-modulation and modulation-distortion makes it adaptable to the r-f and i-f stages of receivers employing automatic volume-control. The internal shield around the plate of the 78 is connected to the cathode within the tube.

CHARACTERISTICS

HEATER VOLTAGE (A. C. or D. C.).....	6.3	Volts
HEATER CURRENT.....	0.3	Ampere
PLATE VOLTAGE.....	90 180 250	250 <i>max.</i> Volts
SCREEN VOLTAGE.....	90 75 100	125 <i>max.</i> Volts
GRID VOLTAGE.....	-3 -3 -3	-3 <i>min.</i> Volts
SUPPRESSOR.....	Connected to cathode at socket	
PLATE CURRENT.....	5.4 4.0 7.0 10.5	Milliamperes
SCREEN CURRENT.....	1.5 1.1 2.0 3.0	Milliamperes
PLATE RESISTANCE.....	0.315 1.0 0.8 0.6	Megohm
AMPLIFICATION FACTOR.....	400 1100 1160 990	
MUTUAL CONDUCTANCE.....	1275 1100 1450 1650	Micromhos
GRID VOLTAGE*.....	-38.5 -32.5 -42.5 -52.5	Volts
GRID-PLATE CAPACITANCE (With shield-can).....	0.007 <i>max.</i>	$\mu\mu\text{f}$
INPUT CAPACITANCE.....	4.4	$\mu\mu\text{f}$
OUTPUT CAPACITANCE.....	10.6	$\mu\mu\text{f}$
BULB (For dimensions, see Page 151, Fig. 7).....		ST-12
CAP.....		Small Metal
BASE (For socket dimensions, see Page 150, Fig. 11).....		Small 6-Pin

* For mutual conductance = 2 micromhos.

INSTALLATION

The **base** pins of the 78 fit the standard six-contact which may be installed to hold the tube in any position.

Heater operation and **cathode** connection are the same as for the 6A7.

Control-grid bias variation, **screen** voltage supply, and **suppressor** connection follow the methods given under INSTALLATION for the 58.

Shielding requirements are similar to the 57.

APPLICATION

As a **radio-frequency amplifier**, the 78 is especially applicable to radio receiver design because of its ability to reduce cross-modulation effects, its remote "cut-off" feature, and its flexible adaptability to circuit combinations and to receiver design. Recommended conditions for the 78 as an amplifier are given under CHARACTERISTICS.

THE RCA RADIOTRON-CUNNINGHAM RADIO TUBE MANUAL

To realize the maximum benefit of the long "cut-off" feature of this tube, it is necessary to apply a variable grid bias and to maintain the screen at a constant potential with respect to the cathode. However, good results may be obtained by using a variable cathode resistance which, of course, reduces the screen potential with respect to the cathode by the same amount that the bias is increased, thus hastening the "cut-off" and reducing the ability of the tube to handle large signals. This undesirable effect may be nullified by means of a series resistor in the screen circuit.

The use of series resistors for obtaining satisfactory control of screen voltage in the case of four-electrode tubes is usually impossible because of secondary emission phenomena. In the 78, however, the suppressor practically removes these effects and it is therefore possible to obtain satisfactorily the screen voltage from the plate supply or from some high intermediate voltage providing these sources do not exceed 250 volts. With this method, the screen-to-cathode voltage will fall off very little from minimum to maximum value of cathode-control resistor. In some cases, it may actually rise. This rise of screen-to-cathode voltage above the normal maximum value is allowable because the screen and the plate current are reduced simultaneously by a sufficient amount to prevent damage to the tube. It should be recognized in general that the series resistor method of obtaining screen voltage from a higher voltage supply necessitates the use of the variable cathode-resistor method of controlling volume. When screen and control-grid voltages are obtained in this manner, the remote "cut-off" advantage of the 78 may be fully realized.

As a **mixer** in superheterodyne circuits, the 78 may be used to advantage. It is capable of producing under the proper conditions of grid and local oscillator voltage, a gain in the mixer stage of about one-third that which can be obtained in an intermediate-frequency amplifier stage. In addition, this gain can be controlled as in the case of the radio-frequency amplifier by varying the grid bias either from a separate supply or from a variable resistor in the cathode circuit. This is a particularly desirable feature in receivers employing automatic volume-control, because it enables a much lower threshold input to be received without loss of amplification and permits the reception of high input voltages without loss of control. Recommended conditions for the 78 as a superheterodyne mixer follow: Plate voltage, 250 volts; screen voltage, 100 volts; suppressor, connected to cathode at socket; and grid-bias voltage, -10 volts minimum (with 9-volt oscillator peak swing). With an oscillator peak swing of 1 volt less than the grid bias, these values are not critical and may be chosen to meet circuit-design requirements.

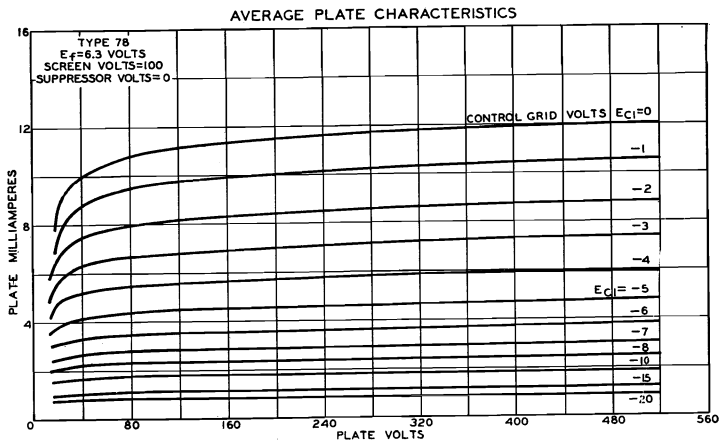

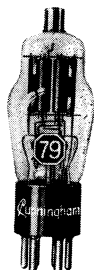

RCA-79

C-79

CLASS B TWIN AMPLIFIER

The 79 is a heater-cathode type of tube combining in one bulb two high-mu triodes designed for Class B operation. It is intended for use in the audio-output stage of radio receivers, especially those of the mobile type which obtain their heater-supply voltage from a storage battery. The triode units have separate external terminals for all electrodes except the cathode and heater so that circuit design employing the 79 is similar to that of Class B amplifiers utilizing individual tubes in the output stage

CHARACTERISTICS

HEATER VOLTAGE (A. C. or D. C.).....	6.3	Volts
HEATER CURRENT.....	0.6	Ampere
PLATE VOLTAGE.....	250 max.	Volts
DYNAMIC PEAK PLATE CURRENT (Per plate).....	90 max.	Milliamperes
AVERAGE PLATE DISSIPATION.....	11.5 max.	Watts

TYPICAL OPERATION

Heater Voltage.....	6.3	Volts
Plate Voltage.....	180 250	Volts
Grid Voltage.....	0 0	Volts
Static Plate Current.....	7.5 10.5	Milliamperes
Load Resistance (Plate-to-plate).....	7000 14000	Ohms
Nominal Power Output*.....	5.5 8.0	Watts

BULB (For dimensions, see Page 151, Fig. 7)	ST-12
CAP.	Small Metal
BASE (For socket connections, see Page 150, Fig. 19)	Small 6-Pin

* With average power input of 380 milliwatts applied between grids.

INSTALLATION

The **base** pins of the 79 fit the standard six-contact socket which may be installed to operate the tube either in a vertical or in a horizontal position. Sufficient ventilation should be provided to circulate air freely around the tube to prevent overheating.

The **heater** of the 79 is designed to operate on either d.c. or a.c. For operation on a.c. with a transformer, the winding which supplies the heater circuit should operate the heater at its recommended value for full-load operating conditions at average line voltage. For service in automobile receivers, the heater terminals of the 79 socket should be connected directly across a 6-volt battery. In receivers that employ a series-heater connection, the heater of the 79 may be operated in series with the heaters of other types having a 0.3-ampere rating. The current in the heater circuit should be adjusted to 0.3 ampere for the normal supply-line voltage.

The **cathode** of the 79 when operated from a.c., should preferably be connected directly to the electrical mid-point of the heater circuit. This practice follows the recommendation that no bias be applied between heater and cathode, and that the potential difference between them be kept as low as possible in order to prevent hum in the circuit. If the use of a large resistor is necessary between heater and cathode in some circuit designs, it should be by-passed by a suitable filter network or objectionable hum may develop. In the case of the 79 when it is operated in receivers employing a 6-volt storage battery for the heater supply, the cathode circuit is tied in either directly or through biasing resistors to the negative battery terminal.

In receivers employing a series-heater circuit, the cathode circuit of the 79 is tied in either directly or through biasing resistors to the negative side of the d-c plate supply which is furnished either by the d-c power line or by the a-c line through a rectifier

APPLICATION

As a **Class B power amplifier**, the 79 is used in circuits similar in design to those utilizing individual tubes in the output stage. It requires no grid-bias, since the high- μ feature of the triode units reduces the steady plate current at zero bias to only a few milliamperes. Refer to page 14 for general Class B amplifier design considerations.

As a **Class A amplifier**, the 79 may be used with grid-bias voltage for small input signals. Such applications include circuits employing the two triode units either in parallel or in push-pull connection.

In other applications, the two triode units of the 79 may be used in various circuits to combine the functions of oscillation, detection and/or amplification.

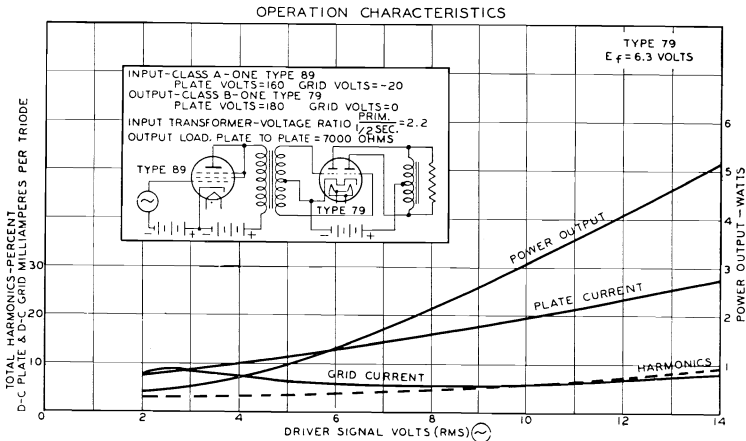
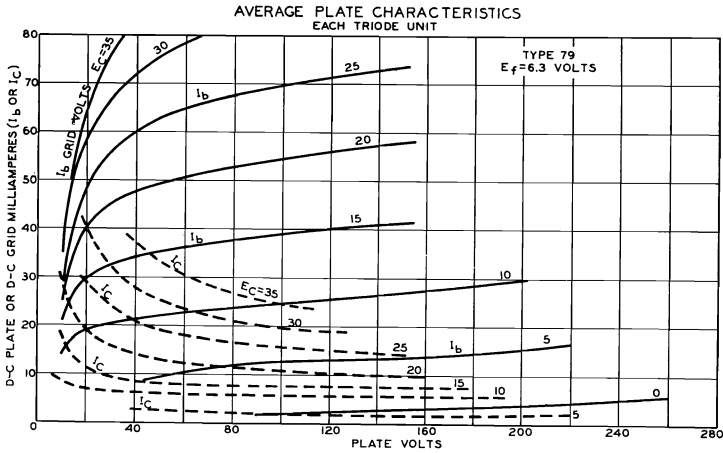

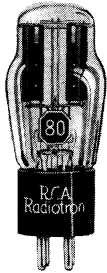

RCA Radiotron

**Cunningham
RADIO TUBES**

RCA-80

C-80

FULL-WAVE RECTIFIER

The 80 is a full-wave rectifying tube intended for use in d-c power supply devices which operate from the a-c supply line.

CHARACTERISTICS

FILAMENT VOLTAGE (A. C.)	5.0	Volts
FILAMENT CURRENT	2.0	Amperes
1 { A-C VOLTAGE PER PLATE (RMS)	350	Volts
{ D-C OUTPUT CURRENT	125 max.	Milliamperes
2 { A-C VOLTAGE PER PLATE (RMS)	400 max.	Volts
{ D-C OUTPUT CURRENT	110 max.	Milliamperes
3* { A-C VOLTAGE PER PLATE (RMS)	550 max.	Volts
{ D-C OUTPUT CURRENT	135 max.	Milliamperes
BULB (For dimensions, see Page 151, Fig. 11)		ST-14
BASE (For socket connections, see Page 150, Fig. 2)		Medium 4-Pin

* This rating is permissible only with filter circuits having an input choke of at least 20 henries.

INSTALLATION

The **base** pins of the 80 fit the standard four-contact socket which should be mounted preferably to hold the tube in a vertical position. If it is necessary to place the tube in a horizontal position, the socket should be mounted with both of the filament-pin openings, either at the top or at the bottom. This precaution locates the filament-plane vertical for most satisfactory performance. Provision should be made for free circulation of air around the bulb since it becomes quite hot during operation.

The coated **filament** of the 80 is designed to operate from the a-c line through a step-down transformer. The voltage applied to the filament terminals should be the rated value of 5.0 volts under operating conditions and average line voltage.

The approximate **d-c output voltage** of the 80 for various values of a-c input voltage may be obtained from the curves. For the d-c voltage available at the radio set, it is necessary to subtract the voltage drop across the filter from the value read from the curves.

APPLICATION

As a **full-wave rectifier**, the 80 may be operated with condenser-input or choke-input filter under conditions not to exceed the ratings given under CHARACTERISTICS.

As a **half-wave rectifier**, two 80's may be operated in a full-wave circuit with reasonable serviceability to deliver more d-c output current than can be obtained from one tube. For this use, the plates of each 80 are tied together at the socket. The allowable voltage and load conditions per tube are the same as for full-wave service.

The **filter** may be of either the condenser-input or choke-input type. If an input condenser is used, consideration must be given to the instantaneous peak value of the a-c input voltage. The peak value is about 1.4 times the RMS value as measured by most a-c voltmeters. Filter condensers, therefore, especially the input condenser, should have a rating high enough to withstand the instantaneous peak value, if breakdown is to be avoided. When the input-choke method is used, the available d-c output voltage will be somewhat lower than with the input-condenser method for a given a-c plate voltage. However, improved regulation together with lower peak current will be obtained.

THE RCA RADIOTRON-CUNNINGHAM RADIO TUBE MANUAL

**OUTPUT CHARACTERISTICS
(CHOKE INPUT TO FILTER)**

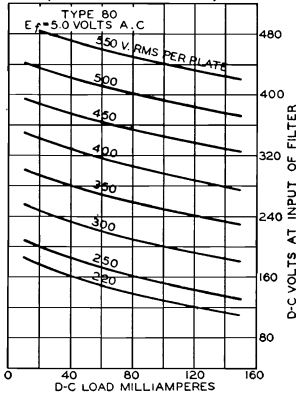

**OUTPUT CHARACTERISTICS
(CONDENSER INPUT TO FILTER)**

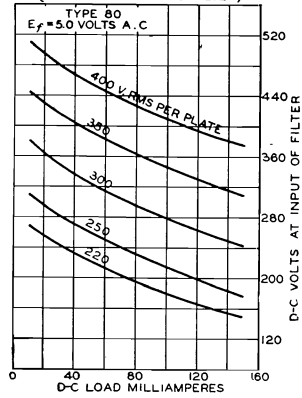

TYPICAL FULL-WAVE RECTIFIER CIRCUIT

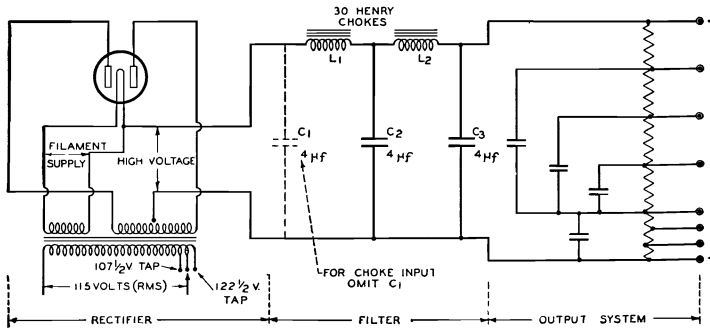

**OUTPUT CHARACTERISTICS
(CHOKE INPUT TO FILTER)**

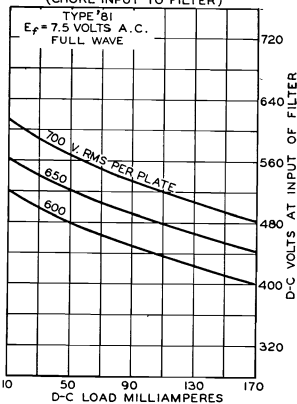

**OUTPUT CHARACTERISTICS
(CONDENSER INPUT TO FILTER)**

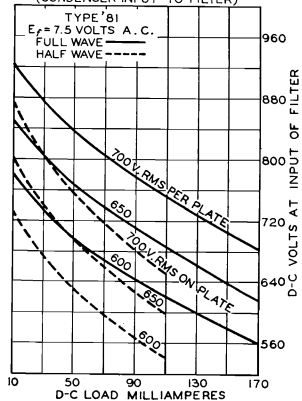

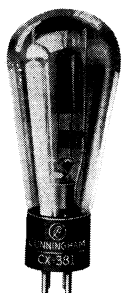

UX-281

CX-381

HALF-WAVE RECTIFIER

The '81 is a half-wave rectifier tube for use in d-c power-supply devices operating from the alternating-current supply line. Full-wave rectification may be accomplished by two '81's.

CHARACTERISTICS

FILAMENT VOLTAGE (A. C.)	7.5	Volts
FILAMENT CURRENT	1.25	Amperes
A-C PLATE VOLTAGE (RMS)	700 <i>max.</i>	Volts
D-C OUTPUT CURRENT	85 <i>max.</i>	Milliamperes
BULB (For dimensions, see Page 151, Fig. 15)		S-19
BASE (For socket connections, see Page 150, Fig. 3)		Medium 4-Pin

INSTALLATION

The **base** pins of the '81 fit the standard four-contact socket which should be mounted to hold the tube in a vertical position. Provision should be made for free circulation of air around the bulb since it becomes quite hot during operation.

The coated **filament** of the '81 is designed to operate from the a-c line through a step-down transformer. The voltage applied to the filament terminals should be the rated value of 7.5 volts under operating conditions and average line voltage.

The approximate **d-c output voltage** of the '81 in half-wave and full-wave connection for various values of a-c input voltage may be obtained from the curves. For the d-c voltage available at the radio set, it is necessary to subtract the voltage drop across the filter from the value read from the curves on preceding page.

APPLICATION

As a **half-wave rectifier**, the '81 may be operated under conditions not to exceed those given under CHARACTERISTICS.

In **full-wave** circuits, two '81's are required to rectify each half of the a-c voltage. Operating voltages per tube are the same as for the half-wave circuit, but twice the d-c output current may be obtained.

The **filter** may be of either the condenser-input or choke-input type. If an input condenser is used, consideration must be given to the instantaneous peak value of the a-c input voltage. The peak value is about 1.4 times the RMS value as measured by most a-c voltmeters. For this reason, filter condensers, especially the input condenser, should have a rating high enough to withstand the instantaneous peak value, if breakdown is to be avoided. When the input-choke method is used, the available d-c output voltage will be somewhat lower than with the input-condenser method for a given a-c plate voltage. However, improved regulation, together with lower peak current, will be obtained.

For **special applications**, it is possible to obtain a d-c output voltage approximately double that to be expected from conventional rectifier circuits, without exceeding the recommended maximum a-c input-voltage per tube. This is accomplished by means of a voltage-doubling system designed for each particular application. See page 16.

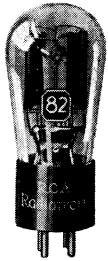

RCA Radiotron

**Cunningham
RADIO TUBES**

RCA-82

C-82

**FULL-WAVE MERCURY-VAPOR
RECTIFIER**

The 82 is a full-wave mercury-vapor rectifier tube of the hot-cathode type for use in suitable rectifying devices designed to supply d-c power of uniform voltage to receivers in which the direct-current requirements are subject to considerable variation. The excellent voltage-regulation characteristic of the 82 is due to its low and practically constant tube voltage drop (only about 15 volts) for any current drain up to the full emission of the filament (see page 4).

CHARACTERISTICS

FILAMENT VOLTAGE (A. C.).....	2.5	Volts
FILAMENT CURRENT.....	3.0	Amperes
A-C VOLTAGE PER PLATE (RMS).....	500 <i>max.</i>	Volts
PEAK INVERSE VOLTAGE.....	1400 <i>max.</i>	Volts
D-C OUTPUT CURRENT (CONTINUOUS).....	125 <i>max.</i>	Milliamperes
PEAK PLATE CURRENT.....	400 <i>max.</i>	Milliamperes
TUBE VOLTAGE DROP (APPROXIMATE).....	15	Volts
BULB (For dimensions, see Page 151, Fig. 9).....		S-14
BASE (For socket connections, see Page 150, Fig. 2).....		Medium 4-Pin

MERCURY-VAPOR RECTIFIER CONSIDERATIONS

The 82 has very low internal resistance, so that the current it delivers depends on the resistance of the load and the regulation of the power transformer. Sufficient protective resistance or reactance must always be used with this tube to limit its current to the recommended maximum value. If this value is exceeded, the tube voltage drop will increase rapidly and may permanently damage the filaments.

It is characteristic of mercury-vapor rectifiers that no appreciable plate current will flow until the plate voltage reaches a certain critical positive value. At this point the plate current rises steeply to a high value in a small fraction of a second. This surge of current re-occurring each time either plate becomes positive may excite circuits in the vicinity of the tube to damped oscillation and thus cause noisy radio receiver operation. It is usually necessary, therefore, to provide small radio-frequency chokes in series with each plate lead so that the slope of the current wave front to the filter is reduced sufficiently to eliminate impact excitation.

INSTALLATION

The base of the 82 is of the medium 4-pin type. Its pins fit the standard four-contact socket which should be installed to operate the tube in a vertical position with the base down. Only a socket making very good filament contact and capable of carrying 3 amperes continuously should be used. Poor contact at the filament pins will cause overheating at the pins and socket, lowered filament voltage, and also high internal tube drop with consequent injury to the tube.

The **bulb** becomes hot during continuous operation. Provision should be made, especially if shielding is employed, for adequate natural ventilation to prevent overheating.

The **filament** is of the coated type and is intended for a-c operation from one of the secondary windings of a power transformer. This winding, provided with a center-tap or center-tap-resistor, should supply at the filament terminals the rated operating voltage of 2.5 volts when average rated voltage is applied to the primary. The high current taken by the filament and the possibility of damage caused by applying plate voltage to the tube with its filament insufficiently heated make it imperative that all connections in the filament circuit be of low resistance and of adequate current-carrying capacity.

The **plate supply** is obtained from a center-tapped high-voltage winding designed so that the maximum a-c input voltage per plate will not exceed 500 volts RMS under varying conditions of supply-line voltage. The resistance of the transformer windings should, of course, be low if full advantage of the excellent regulation capabilities of this mercury-vapor rectifier is to be obtained. Since the drop through the tube is practically constant, any reduction in rectified voltage when the load is increased is due to the drop in the transformer and/or the filter windings. The return-lead from the plates, i.e., the positive bus of the filter and load circuit, should be connected to the center-tap of the filament winding.

Shielding of this tube, particularly in sensitive receivers, may be necessary to eliminate objectionable noise. Radio-frequency choke coils, connected in series with each plate lead and placed within the shielding if used, are usually necessary in receivers having high sensitivity. The inductance of the chokes should be one millihenry or more.

A **fuse** having a rating approximately 50% in excess of normal load requirements should be inserted in the primary of the power transformer to prevent damage in case of excessive current which may flow under abnormal conditions.

It is recommended that the entire equipment be disconnected from the a-c power supply whenever the 82 is removed from or installed in its socket.

APPLICATION

The 82 is recommended for supplying d-c power to receivers, particularly those in which the direct-current requirements cause considerable variation in the load impressed on the rectifier tube.

Filter circuits (page 15) of either the condenser-input or the choke-input type may be employed provided the maximum voltages and currents tabulated under CHARACTERISTICS are not exceeded. The choke-input type of circuit is to be preferred from the standpoint of obtaining the maximum continuous d-c output current from the 82 under the most favorable conditions.

As a **half-wave rectifier**, the 82 may be operated with plates connected in parallel. For example, two 82's so arranged in a full-wave circuit can supply twice the output current of a single tube. When the 82's plates are operated in parallel, a resistor of not less than 100 ohms should be connected in series with each plate in order that each plate will carry its proper share of the total load.

Under operating conditions, the 82 has a bluish-white glow filling the space within the plates and extending to some degree into the surrounding space outside the plates. This glow, caused by the mercury vapor, is an inherent operating characteristic of the 82.



RCA-83

C-83

FULL-WAVE MERCURY-VAPOR RECTIFIER

The 83 is a *heavy-duty*, full-wave, mercury-vapor rectifier tube of the hot-cathode type. It is intended for use in suitable rectifying devices designed to supply d-c power of uniform voltage to receivers. The excellent voltage regulation characteristic of the 83 is due to its low and practically constant tube voltage drop (only about 15 volts) for any current drain up to the full emission of its filaments.

For mercury-vapor rectifier considerations, refer to page 4.

CHARACTERISTICS

FILAMENT VOLTAGE (A. C.)	5.0	Volts
FILAMENT CURRENT	3.0	Amperes
A-C VOLTAGE PER PLATE (RMS)	500 <i>max.</i>	Volts
PEAK INVERSE VOLTAGE	1400 <i>max.</i>	Volts
D-C OUTPUT CURRENT (Continuous)	250 <i>max.</i>	Milliamperes
PEAK PLATE CURRENT	800 <i>max.</i>	Milliamperes
TUBE VOLTAGE DROP (Approximate)	15	Volts
BULB (For dimensions, see Page 151, Fig. 13)		ST-16
BASE (For socket connections, see Page 150, Fig. 2)		Medium 4-Pin

INSTALLATION

Installation of the 83 is similar to that of the 82.

APPLICATION

The 83 is intended for supplying large amounts of d-c power to receivers whose requirements are in excess of the rating of the 82. The 83 is recommended for heavy-drain receivers in which the direct-current requirements cause considerable variation in the load impressed on the rectifier tube.

Filter circuits (page 15) of either the condenser-input or the choke-input type may be employed provided the maximum voltages and currents tabulated under CHARACTERISTICS are not exceeded. The choke-input type of circuit is to be preferred from the standpoint of obtaining the maximum continuous d-c output current from the 83 under the most favorable conditions.

As a **half-wave rectifier**, the 83 may be operated with plates connected in parallel. For example, two 83's so arranged in a full-wave circuit can supply twice the output current of a single tube. When the 83's plates are operated in parallel, a resistor of not less than 50 ohms should be connected in series with each plate in order that each plate will carry its proper share of the total load. If the load is less than 75% of the total maximum current rating of the tube(s), the series plate resistors should be increased to 100 ohms each.

Under operating conditions, the 83 has a bluish-white glow filling the space within the plates and extending to some degree into the surrounding space outside the plates. This glow, caused by the mercury-vapor, is an inherent operating characteristic of the tube.



RCA Radiotron

**Cunningham
RADIO TUBES**

RCA-84

C-84

FULL-WAVE RECTIFIER

The 84 is a high-vacuum rectifier of the heater-cathode type intended for supplying rectified power to automobile-radio equipment designed for its characteristics. This type is interchangeable with the 6Z4.

CHARACTERISTICS

HEATER VOLTAGE (A. C. or D. C.).....	6.3	Volts
HEATER CURRENT.....	0.5	Ampere
A-C VOLTAGE PER PLATE (RMS).....	225 max.	Volts
D-C OUTPUT CURRENT.....	50 max.	Milliamperes
BULB (For dimensions, see Page 151, Fig. 6).....		ST-12
BASE (For socket connections, see Page 150, Fig. 23).....		Small 5-Pin

INSTALLATION

The **base** pins of the 84 fit the standard five-contact socket which may be mounted to hold the tube in any position.

The **bulb** of this tube will become very hot under certain conditions of operation. Adequate ventilation should be provided for cooling the tube by the use of chassis enclosures designed to radiate heat efficiently.

The **heater** is designed so that the normal voltage variation of 6-volt automobile batteries during charge and discharge will not materially affect the performance or serviceability of this tube. In such service, the heater terminals of the socket should be connected directly across a 6-volt battery. Leads to the battery should have as low resistance as practical.

APPLICATION

The 84 is well suited for supplying rectified power to radio equipment of the automobile type. In such equipment, the performance of this tube is similar to that of any other high-vacuum rectifier.

Filter circuits of the condenser-input or the choke-input type may be employed provided the recommended maximum plate voltage and output current given under **CHARACTERISTICS** are not exceeded. The d-c potential difference between heater and cathode should be limited to 300 volts.

For discussion of rectifiers and filter circuits, refer to page 15.

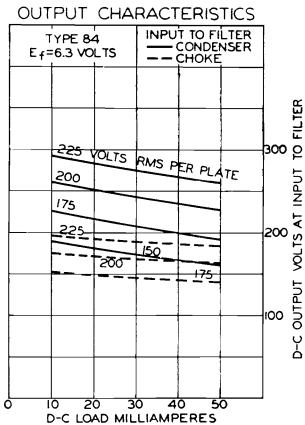



RCA-85

C-85

DUPLEX-DIODE TRIODE

The 85 is an a-c heater type of tube consisting of *two diodes* and a *triode* in a single bulb. It is for use as a combined detector, amplifier, and automatic-volume-control tube in radio receivers designed for its characteristics. The 85 is especially useful in automobile receivers where the heater-supply voltage is obtained from a storage battery.

The two diodes and the triode are independent of each other except for a common cathode sleeve which has one emitting surface for the diodes and another for the triode. The separate tube units permit of unusual flexibility in circuit arrangement and design. For example, the diodes of this tube can perform at the same time the functions of detection and of automatic volume-control; while at the same time the triode may be used as an amplifier under its own optimum conditions. For diode-detector considerations, refer to page 17.

CHARACTERISTICS

HEATER VOLTAGE (A. C. or D. C.).....	6.3	Volts
HEATER CURRENT.....	0.3	Ampere
GRID-PLATE CAPACITANCE.....	1.5	$\mu\mu\text{f}$
GRID-CATHODE CAPACITANCE.....	1.5	$\mu\mu\text{f}$
PLATE-CATHODE CAPACITANCE.....	4.3	$\mu\mu\text{f}$
BULB (For dimensions, see Page 151, Fig. 7).....		ST-12
CAP.....		Small Metal
BASE (For socket connections, see Page 150, Fig. 13).....		Small 6-Pin

Triode Unit—As Class A Amplifier

HEATER VOLTAGE.....		6.3	Volts	
PLATE VOLTAGE.....	135	180	250 <i>max.</i>	Volts
GRID VOLTAGE.....	-10.5	-13.5	-20	Volts
AMPLIFICATION FACTOR.....	8.3	8.3	8.3	
PLATE RESISTANCE.....	11000	8500	7500	Ohms
MUTUAL CONDUCTANCE.....	750	975	1100	Micromhos
PLATE CURRENT.....	3.7	6.0	8.0	Milliamperes
LOAD RESISTANCE.....	25000	20000	20000	Ohms
POWER OUTPUT.....	0.075	0.16	0.35	Watt

Diode Units

The two diode plates are placed around a cathode, the sleeve of which is common to the triode unit. Each diode plate has its own base pin. Operation curves for the diode units are given under Type 2B7, page 41.

INSTALLATION

The **base** pins of the 85 fit the standard six-contact socket which may be installed to hold the tube in any position.

Heater operation and **cathode** connection are the same as for the 77.

Complete **shielding** of detector circuits employing the 85 is generally necessary to prevent r-f or i-f coupling between the diode circuits and the circuits of other stages.

APPLICATION

The 85 is recommended for performing the simultaneous functions of detection, automatic volume-control, and amplification.

For **detection**, the diodes may be utilized in a full-wave circuit or in a half-wave circuit. In the latter case, one plate only or the two plates in parallel may be employed. The use of the half-wave arrangement will provide approximately twice the rectified voltage as compared with the full-wave arrangement.

For **automatic volume-control**, a rectified voltage which is dependent on the r-f or i-f carrier is usually employed as explained on page 101 for the 55.

For **amplification**, the triode may be employed in conventional circuit arrangements. Representative conditions for resistance-coupled amplifier applications are given on page 142. Grid-bias for the triode, depending upon circuit design, may be obtained from a fixed voltage tap on the d-c power supply or may be obtained by utilizing the variable voltage drop caused by the rectified current flowing through a resistor in the detector circuit. In this connection, it should be noted that the accompanying diagrams using types 85 or 55 designate this latter arrangement as "Diode-Biased Amplifier." Diode biasing of the triode unit may be employed only when at least 20000 ohms is used in the triode-plate circuit.

The plate family of characteristics for the triode unit is the same as that of the 55. See page 101 for these curves.

TYPICAL DUPLEX-DIODE TRIODE CIRCUITS

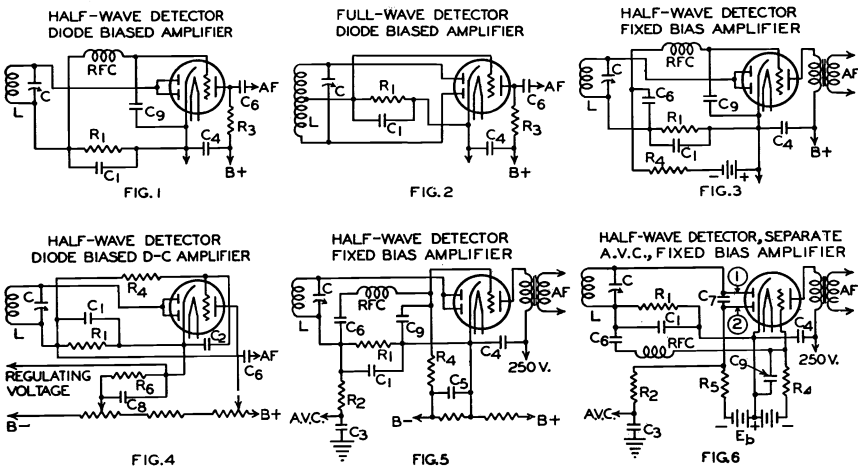

APPROXIMATE VALUES

- $C_1 = \begin{cases} 150 \mu\mu\text{f. FOR } 500-1500 \text{ KC.} \\ 450 \mu\mu\text{f. FOR } 175 \text{ KC.} \end{cases}$
- $C_2 = 0.1 \mu\text{f.}$
- $C_3 = 0.1 \mu\text{f.}$
- $C_4 = 0.5 \mu\text{f. OR LARGER}$
- $C_5 = 0.5 \mu\text{f. OR LARGER}$
- $C_6 = 0.01 - 0.1 \mu\text{f.}$
- $C_7 = 0.0005 - 0.001 \mu\text{f.}$
- $C_8 = 0.1 \mu\text{f. OR LARGER}$
- $C_9 = 0.0001 \mu\text{f. OR SMALLER}$
- $R_1 = 0.5 - 1.0 \text{ MEGOHM}$
- $R_2 = 1.0 - 1.5 \text{ MEGOHMS}$
- $R_3 = 0.1 \text{ MEGOHM}$
- $R_4 = 0.5 - 1.0 \text{ MEGOHM}$
- $R_5 = 1.0 \text{ MEGOHM}$
- $R_6 = 25000 - 75000 \text{ OHMS}$
- $E_b = \text{VOLTAGE FOR SENSITIVITY CONTROL}$



RCA Radiotron

**Cunningham
RADIO TUBES**

RCA-89

C-89

TRIPLE-GRID POWER AMPLIFIER

The 89 is a triple-grid power amplifier tube of the d-c heater-cathode type recommended for use in automobile receivers and other applications where d-c operation is desirable. The triple-grid construction of this tube, with external connections for each grid, makes possible its application as (1) a Class A Power Amplifier Triode, (2) a Class A Power Output Pentode, and (3) a Class B Power Output Triode.

CHARACTERISTICS

HEATER VOLTAGE (A. C. or D. C.).....	6.3	Volts
HEATER CURRENT.....	0.4	Ampere
BULB (For dimensions, see Page 151, Fig. 7).....		ST-12
CAP.....		Small Metal
BASE (For socket connections, see Page 150, Fig. 14).....		Small 6-Pin

Class B Power Amplifier—Triode Connection

(Grids No. 1 and No. 2 tied together; grid No. 3 tied to plate)

PLATE VOLTAGE.....	250 <i>max.</i>	Volts
DYNAMIC PEAK PLATE CURRENT.....	90 <i>max.</i>	Milliamperes
AVERAGE GRID DISSIPATION (Grids No. 1 and No. 2 together).....	0.35 <i>max.</i>	Watts
TYPICAL OPERATION (2 tubes)		
Heater Voltage.....	6.3	Volts
Plate Voltage.....	180	Volts
Grid Voltage (Grids No. 1 and No. 2 together)...	0	Volts
Static Plate Current (Per tube).....	3	Milliamperes
Load Resistance (Plate-to-plate).....	9400	Ohms
Nominal Power Output (2 tubes).....	3.5	Watts

Class A Power Amplifier—Triode Connection

(Grids No. 2 and No. 3 tied to plate)

HEATER VOLTAGE.....		6.3	Volts	
PLATE VOLTAGE.....	160	180	250 <i>max.</i>	Volts
GRID VOLTAGE (Grid No. 1).....	-20	-22.5	-31	Volts
AMPLIFICATION FACTOR.....	4.7	4.7	4.7	
PLATE RESISTANCE.....	3300	3000	2600	Ohms
MUTUAL CONDUCTANCE.....	1425	1550	1800	Micromhos
PLATE CURRENT.....	17	20	32	Milliamperes
LOAD RESISTANCE*.....	7000	6500	5500	Ohms
UNDISTORTED POWER OUTPUT.....	0.3	0.4	0.9	Watt

* Optimum for maximum undistorted power output. Approximately twice the value for any given set of conditions is recommended for load of this tube when used as driver for Class B stage.

Class A Power Amplifier—Pentode Connection

(Grid No. 3 tied to cathode)

HEATER VOLTAGE.....					6.3	Volts
PLATE VOLTAGE.....	100	135	180	250	<i>max.</i>	Volts
SCREEN VOLTAGE (Grid No. 2)...	100	135	180	250	<i>max.</i>	Volts
GRID VOLTAGE (Grid No. 1).....	-10	-13.5	-18	-25		Volts
AMPLIFICATION FACTOR.....	125	125	125	125		
PLATE RESISTANCE.....	104000	92500	80000	70000		Ohms
MUTUAL CONDUCTANCE.....	1200	1350	1550	1800		Micromhos
PLATE CURRENT.....	9.5	14	20	32		Milliamperes
SCREEN CURRENT.....	1.6	2.2	3.0	5.5		Milliamperes
LOAD RESISTANCE.....	10700	9200	8000	6750		Ohms
POWER OUTPUT ^o	0.33	0.75	1.5	3.4		Watts

^o 9% total harmonic distortion.

INSTALLATION

The **base** pins of the 89 fit the standard six-contact socket which may be installed to hold the tube in any position. Sufficient ventilation should be provided to circulate air freely around the tube to prevent overheating.

For **heater** operation, see Type 41; and for **cathode** connection refer to Type 6A7.

APPLICATION

For **Class A Triode Operation** of the 89, the two grids (No. 3 and No. 2) immediately adjacent to the plate are connected to the plate, while the third (No. 1) is employed for control purposes. Operation of the tube is then similar to any Class A Power Amplifier Triode. When it is used as the driver for a Class B stage, the load requirements are changed as indicated in the note under CHARACTERISTICS. This change is recommended in order to minimize distortion due to the driver stage.

The d-c resistance in the grid circuit of the 89 operating as a Class A amplifier (either with triode or pentode connection) should not exceed 1.0 megohm if self-bias is used. Without self-bias, the resistance should not exceed 0.5 megohm.

For **Class A Pentode Operation** of the 89, the grid (No. 3) adjacent to the plate is tied to the cathode and thus serves as the suppressor, while the other two grids (No. 2 and No. 1) serve as the screen-grid and control-grid respectively. Operation of the tube is then similar to any Class A power output pentode.

For **Class B Triode^o Operation** of the 89, the grid (No. 3) adjacent to the plate is tied to the plate, while the other two grids (No. 2 and No. 1) are connected together to serve as a single control-grid. A discussion of Class B design features is given on page 14.

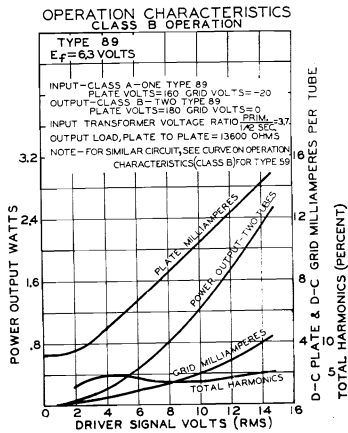

THE RCA RADOTRON-CUNNINGHAM RADIO TUBE MANUAL

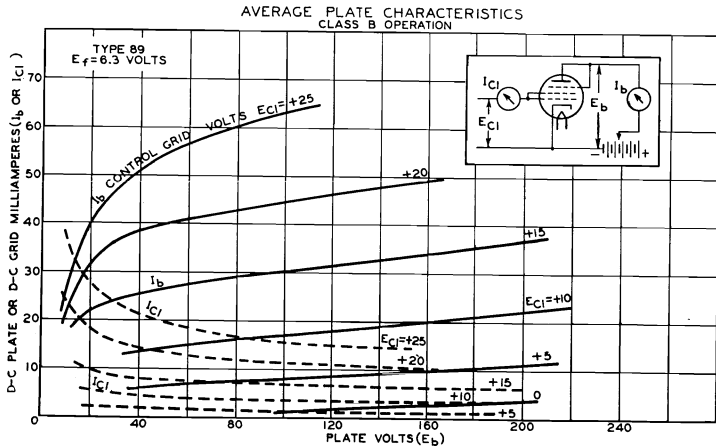
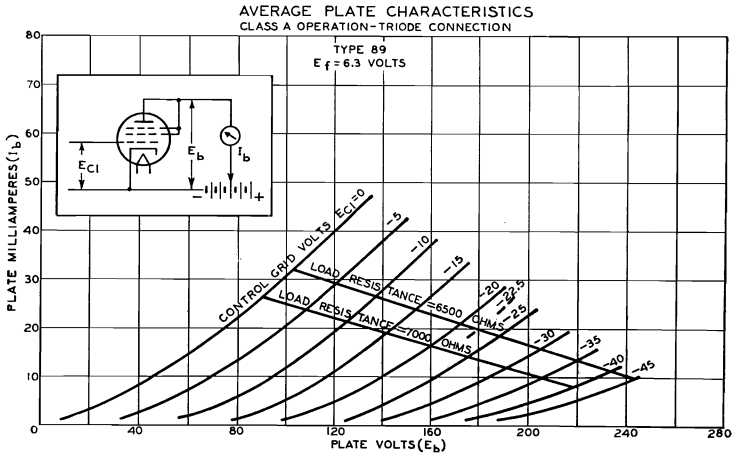
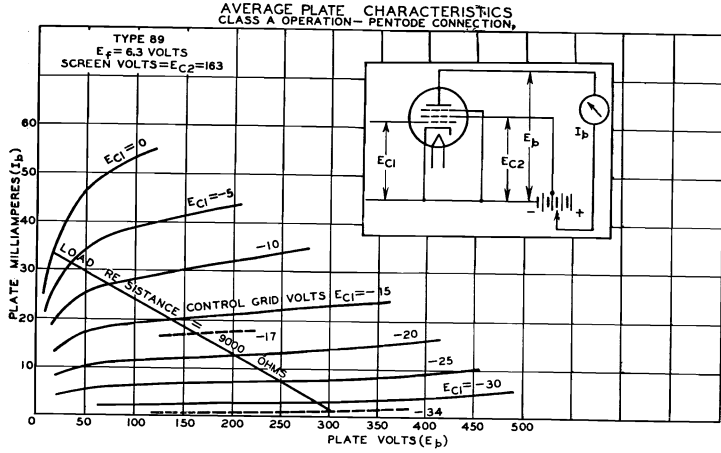



UV-199 AND UX-199

C-299 AND CX-299

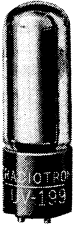

DETECTORS, AMPLIFIERS

The '99 types are three-electrode, general purpose tubes designed for dry-cell operation. The low power consumption of these tubes makes them applicable to portable receivers and services where power economy is important. The two types have different bases.

CHARACTERISTICS

FILAMENT VOLTAGE (D. C.).....	3.0-3.3	Volts
FILAMENT CURRENT.....	0.060-0.063	Ampere
PLATE VOLTAGE.....	90 <i>max.</i>	Volts
GRID VOLTAGE.....	-4.5	Volts
PLATE CURRENT.....	2.5	Milliamperes
PLATE RESISTANCE.....	15500	Ohms
AMPLIFICATION FACTOR.....	6.6	
MUTUAL CONDUCTANCE.....	425	Micromhos
GRID-PLATE CAPACITANCE.....	3.3	$\mu\mu\text{f}$
GRID-FILAMENT CAPACITANCE.....	2.5	$\mu\mu\text{f}$
PLATE-FILAMENT CAPACITANCE.....	2.5	$\mu\mu\text{f}$
	<i>Type '99</i>	<i>X-Type '99</i>
BULB (See Figs. on Page 151).....	T-8 (Fig. 3)	T-8(Fig. 1)
BASE.....	Small 4-Nub	Small 4-Pin

INSTALLATION

The **base** pins of the X-Type '99 fit the standard four-contact socket while the '99 fits only the small shell socket with bayonet slot. The socket should be installed so that the tubes will operate in a vertical position. Cushioning of the socket in the detector stage may be desirable if microphonic disturbances are encountered. For socket connections of X-Type '99 and of '99, see page 150, Fig. 1 and Fig. 10, respectively.

The **filaments** in these tubes are designed for operation with three No. 6 dry-cells connected in series. In multi-tube receivers the use of six or nine No. 6 dry-cells connected in series-parallel to give 4.5 volts will decrease the current drain per cell and give a more stable source of filament power. If storage-battery operation is preferred, a four-volt storage battery may be used. In any case, a filament rheostat should be provided so that the filament voltage can be adjusted to the recommended operating value.

APPLICATION

As **detectors**, '99's may be operated either with grid leak and condenser or with grid bias. The recommended plate voltage for the former method is 45 volts. A grid leak of from 1 to 5 megohms used with a grid condenser of 0.00025 μf is satisfactory. The grid-circuit return should be connected to the positive filament terminal. For grid-bias detection the maximum plate voltage of 90 volts may be used with the corresponding negative grid bias of 10.5 volts. The grid bias should be adjusted so that the plate current is 0.2 milliamperes with no input signal.

As **amplifiers**, '99's are applicable to the audio- or the radio-frequency stages of a receiver. Recommended plate and grid voltages are shown under CHARACTERISTICS.

Radio Tube Testing

The radio tube user—service man, experimenter, and non-technical radio listener—is interested in knowing the condition of his tubes, since they govern the performance of the device in which they are used. In order to determine the condition of a tube, some method of test is necessary.

Since the operating capabilities and design features of a tube are indicated and described by its electrical characteristics, a tube is tested by measuring its characteristics and comparing them with representative values established as standard for that type. Tubes which read abnormally high with respect to the standard for the type are subject to criticism just the same as tubes which are too low.

Certain practical limitations are placed on the accuracy with which a tube test can be correlated with actual tube performance. These limitations make it unnecessary for the service man and dealer to employ complex and costly testing equipment having laboratory accuracy.

Since the accuracy of the tube-testing device need be no greater than the accuracy of the correlation between test results and receiver performance, and since certain fundamental characteristics are virtually fixed by the manufacturing technique of leading tube manufacturers, it is possible to employ a relatively simple test in order to determine the serviceability of a tube.

In view of these factors, dealers and service men will find it economically expedient to obtain adequate accuracy and simplicity of operation by employing a device which indicates the status of a single characteristic. Whether the tube is satisfactory or unsatisfactory is judged from the test result of this single characteristic. Consequently, it is very desirable that the characteristic selected for the test be one which is truly representative of the tube's overall condition.

SHORT CIRCUIT TEST

The fundamental circuit of a short-circuit tester is shown in Fig. 35. While the circuit is suitable for tetrodes and types having less than four electrodes, tubes of more electrodes may be tested by adding more indicator lamps to the circuit. Voltages are applied between the various electrodes with lamps in series with the electrode leads. Any two shorted electrodes complete a circuit and light one or more lamps. Since two electrodes may be just touching to give a high-resistance short, it is desirable that the indicating lamps operate on very low current. It is also desirable to maintain the filament or heater of the tube at its operating temperature during the short-circuit test, because short-circuits in a tube may sometimes occur only when the electrodes are heated.

SELECTION OF A SUITABLE CHARACTERISTIC FOR TEST

Some characteristics of a tube are far more important in determining its operating worth than are others. The cost of building a device to measure any one of the more important characteristics may be considerably higher than that of a device which measures a less representative characteristic. Consequently, three methods of test will be discussed, ranging from relatively simple and inexpensive equipment to more elaborate, more accurate, and more costly devices.

An **emission test** is perhaps the simplest method of indicating a tube's condition. (Refer to DIODES, page 3 for a discussion of electronic emission.) Since emission falls off as the tube wears out, low emission is indicative of the end of tube serviceability. However, the emission test is subject to limitations because it tests the tube under static conditions and does not take into account the actual operation of the tube. On the one hand, coated filaments, or cathodes, often develop active spots from which the emission is so great that the relatively small grid area adjacent to these spots cannot control the electron stream. Under these conditions, the total emission may indicate the tube to be normal although the tube is unsatisfactory. On the other hand, coated types of filaments are capable of such large emission that the tube will often operate satisfactorily after the emission has fallen far below the original value.

Fig. 36 shows the fundamental circuit diagram for an emission test. All of the electrodes of the tube, except the cathode, are connected to the plate. The filament, or heater, is operated at rated voltage; a low positive voltage is applied to the plate.

After the tube has reached constant temperature, the electronic emission is read on the meter. Readings which are well below the average for a particular tube type indicate that the total number of available electrons has been so reduced that the tube is no longer able to function properly.

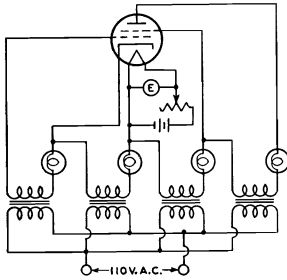

Fig. 35

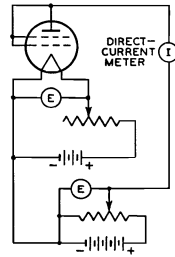

Fig. 36

A **mutual conductance test** takes into account a fundamental operating principle of the tube. (This will be seen from the definition of Mutual Conductance on page 8.) It follows that mutual conductance tests, when properly made, permit better correlation between test results and actual performance than does a straight emission test.

There are two forms of mutual conductance test which can be utilized in a tube tester. In the first form (illustrated by Fig. 37 giving a fundamental circuit with a tetrode under test), appropriate operating voltages are applied to the electrodes of the tube. A plate current, depending upon the electrode voltages, will then be indicated by the meter. If the bias on the grid is then shifted by the application of a different grid voltage, a new plate-current reading is obtained. The difference between the two plate-current readings is indicative of the mutual conductance of the tube. This method of mutual conductance testing is commonly called the "grid-shift" method, and depends on readings under static conditions. The fact that this form of test is made under static conditions imposes limitations not encountered in the second form of test made under dynamic conditions.

The dynamic mutual-conductance test illustrated in Fig. 38 gives a fundamental circuit with a tetrode under test. This method is superior to the static mutual-conductance test in that a-c voltage is applied to the grid. Thus, the tube is tested under

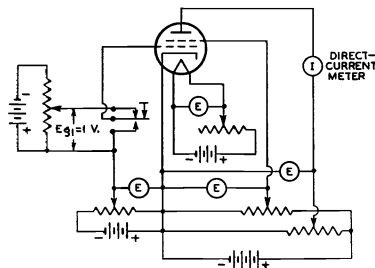

Fig. 37

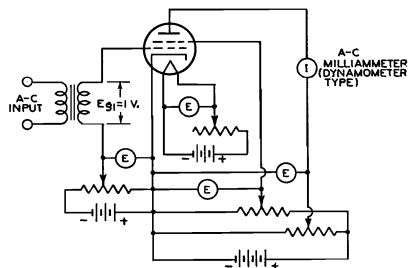

Fig. 38

conditions which approximate actual operating conditions. The alternating component of the plate current is read by means of an a-c ammeter of the dynamometer type. The mutual conductance of the tube is equal to the a-c plate current divided by the input signal voltage. If a one-volt RMS signal is applied to the grid, the plate-current-meter reading in milliamperes multiplied by one thousand is the value of mutual conductance in micromhos.

THE RCA RADIOTRON-CUNNINGHAM RADIO TUBE MANUAL

The **power output test** probably gives the best correlation between test results and actual operating performance of a tube. In the case of voltage amplifiers, the power output is indicative of the amplification and output voltages obtainable from the tube. In the case of power output tubes, the performance of the tube is closely checked. Consequently, although more complicated to set up, the power output test will give closer correlation with actual performance than any other single test.

Fig. 39 shows the fundamental circuit of a power output test for Class A operation of tubes. The diagram illustrates the method for a pentode. The a-c output voltage developed across the plate-load impedance (L) is indicated by the current meter. The current meter is isolated as far as the d-c plate current is concerned by the condenser (C). The power output can be calculated from the current reading and known load resistance. In this way, it is possible to determine the operating condition of the tube quite accurately.

Fig. 40 shows the fundamental circuit of a power output test for Class B operation of tubes. With a-c voltage applied to the grid of the tube, the current in the plate circuit is read on a d-c meter. The power output of the tube is approximately equal to:

$$\text{Power Output (watts)} = \frac{(\text{D-c current in amperes})^2 \times \text{Load resistance in ohms}}{0.405}$$

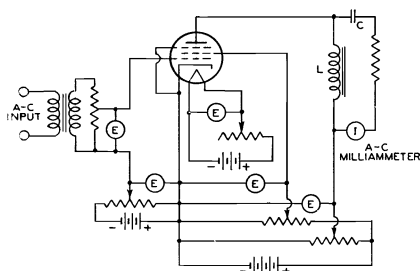

Fig. 39

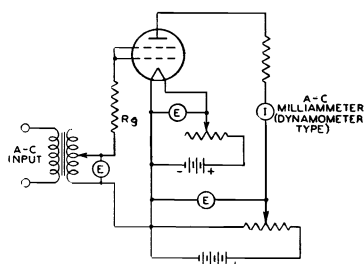

Fig. 40

ESSENTIAL TUBE TESTER REQUIREMENTS

1. It is desirable that the tester provide for a short-circuit test to be made prior to measurement of the tube's characteristics.
2. It is important that some means of controlling the voltages applied to the electrodes of the tube be provided. If the tester is a-c operated, a line-voltage control will permit of supplying proper electrode voltages.
3. It is essential that the rated voltage applied to the filament or heater be maintained accurately.
4. It is suggested that the characteristics test follow one of the methods described. The method selected and the quality of the parts used in the tester will depend upon the requirements of the user.

TUBE TESTER LIMITATIONS

A tube testing device can only indicate the difference between a given tube's characteristics and those which are standard for that particular type. Since the operating conditions imposed upon a tube of a given type may vary within wide limits, it is impossible for a tube testing device to evaluate tubes in terms of performance capabilities for all applications. The tube tester, therefore, cannot be looked upon as a final authority in determining whether or not a tube is always satisfactory. Actual operating tests in the equipment in which the tube is to be used will give the best possible indication of a tube's worth. Nevertheless, the tube tester is a most helpful device for indicating the serviceability of a tube.

Circuit Section

The circuit diagrams given on the following pages have been carefully chosen, not necessarily to illustrate commercial practice, but rather to show many different uses of radio tubes. All of the circuits are conservatively designed to give reliable and satisfactory performance. Although relatively few circuits are given, it is practical to use a portion of one circuit in combination with portions of other circuits to obtain one meeting the desired requirements. Information on the characteristics and the application features of each tube, given under each tube type, will prove of assistance in understanding and utilizing these circuits.

HIGH-QUALITY CLASS A AUDIO-FREQUENCY AMPLIFIER OUTPUT 12 WATTS

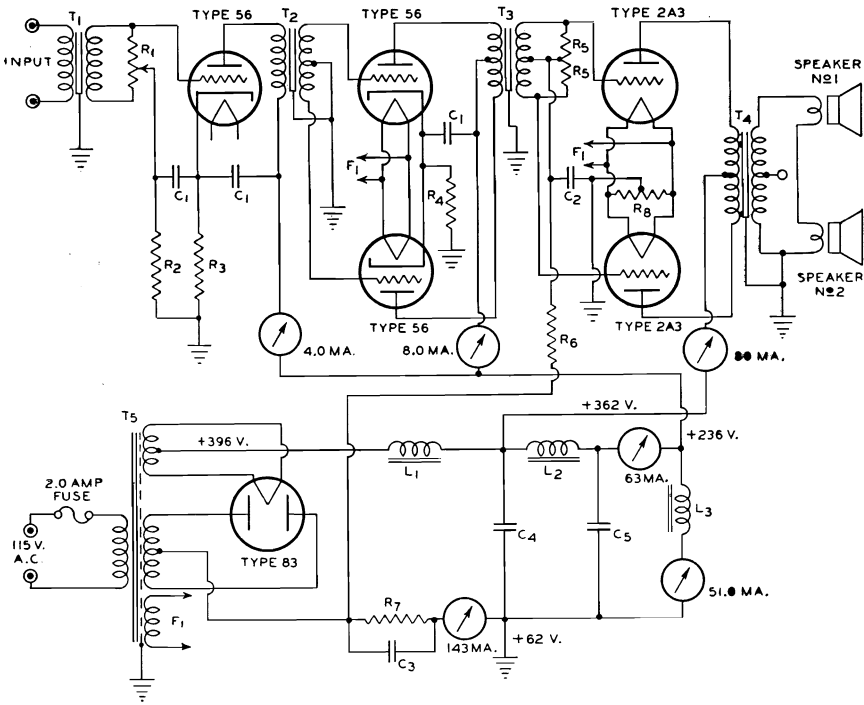

$C_1 = 1.0 \mu f. (200 V.)$
 $C_2 = 20.0 \mu f. (75 V.)$
 $C_3 = 10.0 \mu f. (75 V.)$
 $C_4 = 10.0 \mu f. (400 V.)$
 $C_5 = 4.0 \mu f. (300 V.)$
 $R_1 = 250000 \text{ OHMS (VOL. CONTROL)}$
 $R_2 = 100000 \text{ OHMS}$
 $R_3 = 2200 \text{ OHMS}$
 $R_4 = 1100 \text{ OHMS}$
 $R_5 = 0.5 \text{ MEGOHM}$
 $R_6 = 50000 \text{ OHMS}$
 $R_7 = 430 \text{ OHMS (1/2 WATT)}$
 $R_8 = 20 \text{ OHMS, CENTER TAPPED}$

$L_1 = \text{FILTER CHOKE; } 236 \text{ OHMS, } 12 \text{ HENRIES AT } 140 \text{ MA.}$
 $L_2 = \text{SPEAKER FIELD; } 125 \text{ VOLTS, } 2000 \text{ OHMS}$
 $L_3 = \text{SPEAKER FIELD; } 175 \text{ VOLTS, } 3400 \text{ OHMS}$
 $T_1 = \text{INPUT-TO-GRID TRANSFORMER}$
 $T_2 = \text{PLATE-TO-PUSH-PULL-GRID TRANSFORMER}$
 $T_3 = \text{PUSH-PULL-PLATE-TO-PUSH-PULL-GRID TRANSFORMER}$
 $T_4 = \text{OUTPUT TRANSFORMER; PLATE-TO-PLATE}$
 $\text{IMPEDANCE} = 4000 \text{ OHMS}$
 $T_5 = \text{POWER TRANSFORMER; SHOULD HAVE GOOD}$
 $\text{VOLTAGE REGULATION CHARACTERISTICS}$

NOTE: SPEAKERS ESPECIALLY DESIGNED FOR HIGH POWER ARE RECOMMENDED. CIRCUIT CONSTANTS SHOULD CLOSELY APPROXIMATE THOSE GIVEN ABOVE FOR SATISFACTORY RESULTS.

TYPICAL CLASS B AUDIO-FREQUENCY AMPLIFIER
OUTPUT 20 WATTS

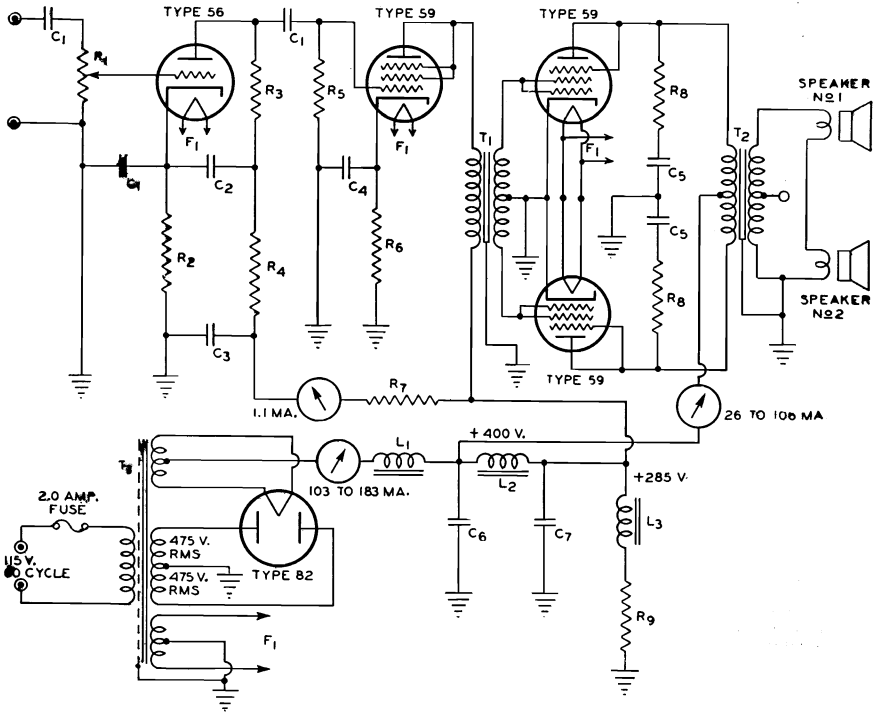

- C₁ = 0.1 μf.
- C₂ = 0.25 μf.
- C₃ = 1.0 μf.
- C₄ = 8.0 μf. (LOW VOLTAGE)
- C₅ = 0.06 μf.
- C₆ = 16 μf. (ELECTROLYTIC)
- C₇ = 8 μf. (ELECTROLYTIC)
- R₁ = 250000 OHMS (VOL. CONTROL)
- R₂ = 7000 OHMS
- R₃ = 100000 OHMS
- R₄ = 25000 OHMS
- R₅ = 250000 OHMS
- R₆ = 1100 OHMS

- R₇ = 25000 OHMS
- R₈ = 3500 OHMS
- R₉ = 3200 OHMS (10 WATT)
- T₁ = INPUT TRANSFORMER; PRIMARY TO 1/2 SECONDARY = 3:1
PRIMARY INDUCTANCE = 12 H. AT 26 MA.
- T₂ = OUTPUT TRANSFORMER; 6000 OHMS PLATE-TO-PLATE
- T₃ = POWER TRANSFORMER; SHOULD HAVE GOOD
VOLTAGE REGULATION CHARACTERISTICS
- L₁ = 15 HENRIES AT 100 MA.; 80 OHMS D-C
RESISTANCE, OR LESS
- L₂ = 1500 OHM SPEAKER FIELD, 115 VOLTS
- L₃ = 2500 OHM SPEAKER FIELD, 125 VOLTS

NOTE: SPEAKERS ESPECIALLY DESIGNED FOR HIGH POWER ARE RECOMMENDED. CIRCUIT CONSTANTS SHOULD CLOSELY APPROXIMATE THOSE GIVEN ABOVE FOR SATISFACTORY RESULTS.

CLASS B POWER AMPLIFIER CIRCUIT
USING 53 WITH TRIODE UNITS IN PARALLEL AS DRIVER

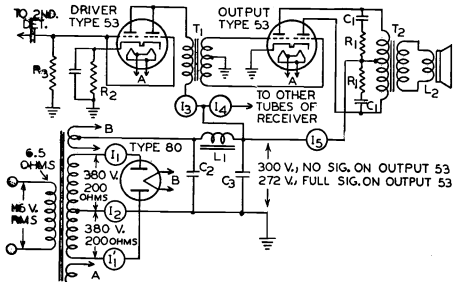

- R₁ = 7250 OHMS
- R₂ = 950 OHMS
- R₃ = 0.5 MEG. MAX.
- C₁ = 0.034 μf.
- C₂ = 2 TO 10 μf.
- C₃ = 10 μf.
- L₁ = 1000-OHM SPEAKER FIELD
- L₂ = 13-OHM SPEAKER VOICE COIL
- T₁ = INPUT TRANSFORMER
VOLTAGE RATIO $\frac{V_{PRIM}}{V_{SEC}} = 5.0$
- PEAK POWER EFF. = 70 %
- T₂ = OUTPUT TRANSFORMER
- I₁ = 1 = 85 MILLIAMPERES RMS
- I₂ = 130 MILLIAMPERES RMS
- I₃ = 7 MILLIAMPERES D.C.
- I₄ = 38 MILLIAMPERES D.C.
- I₅ = 35 TO 50 MILLIAMPERES D.C.

THE RCA RADOTRON-CUNNINGHAM RADIO TUBE MANUAL

TYPICAL TUNED RADIO-FREQUENCY CIRCUIT 2-VOLT FILAMENT TYPES

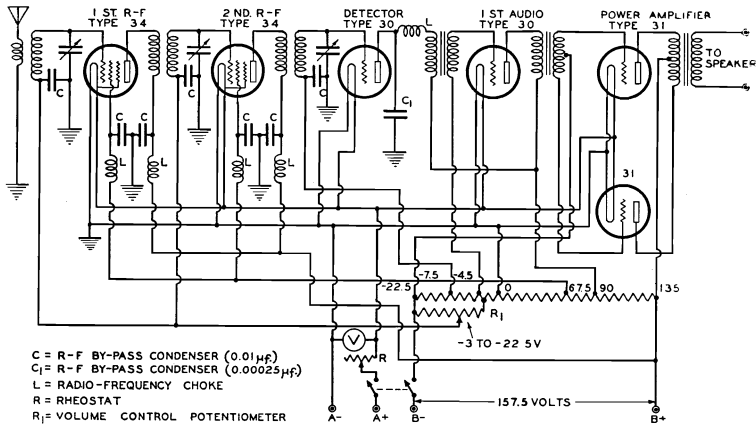

OPTIONAL DETECTOR AND AMPLIFIER—2-VOLT FILAMENT TYPES

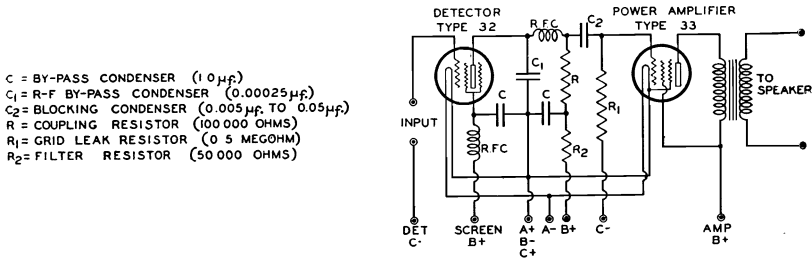

DIAGRAMMATIC SHORTWAVE RECEIVER USING 6.3-VOLT TUBES

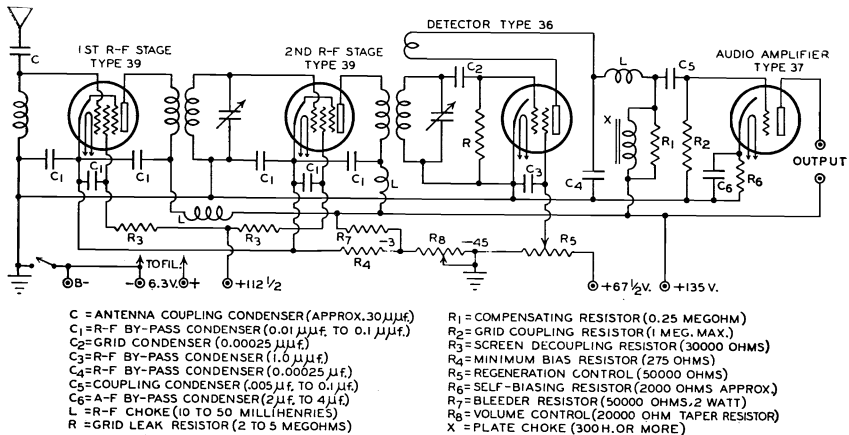

NOTE: TYPES 56, 57 AND 58 MAY BE USED IN THIS CIRCUIT IN PLACE OF THE 37, 36 AND 39 RESPECTIVELY, PROVIDED THAT THEY ARE OPERATED AT THEIR RECOMMENDED HEATER, SCREEN, PLATE AND GRID BIAS VOLTAGES. THE SUPPRESSOR GRID OF THE 57 AND 58 SHOULD BE TIED TO THE CATHODE AT THE SOCKET.

THE RCA RADIODRONE-CUNNINGHAM RADIO TUBE MANUAL

TYPICAL SUPERHETERODYNE RECEIVER CIRCUIT FOR A-C OPERATION

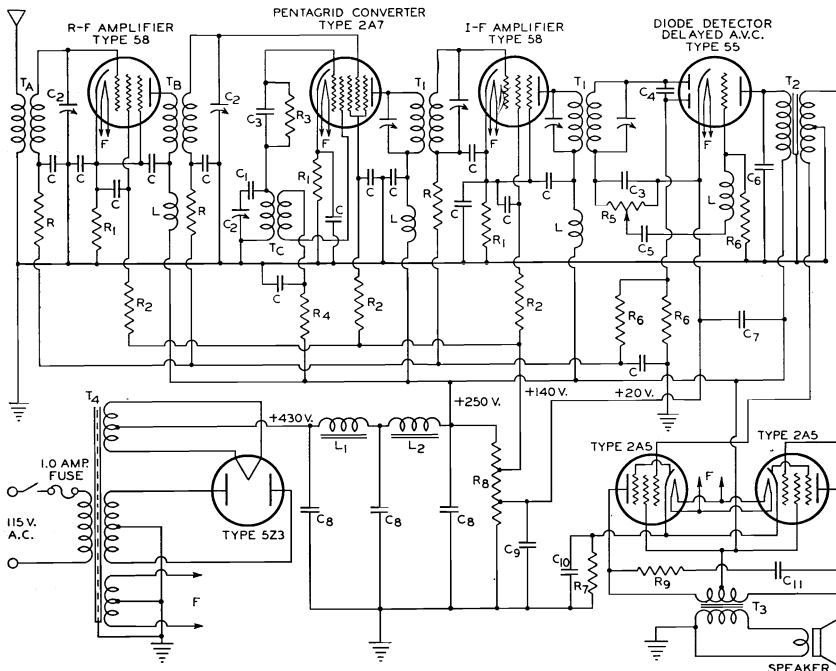

- R = 250000 OHMS
- R₁ = 300 OHMS
- R₂ = 20000 OHMS
- R₃ = 10000 TO 50000 OHMS
- R₄ = 25000 OHMS
- R₅ = 500000 OHMS (A-F VOL. CONTROL)
- R₆ = 1.0 MEGOHM
- R₇ = 205 OHMS (5 WATT)
- R₈ = 25000 OHMS (10 WATT)
- R₉ = 14000 OHMS
- L = R-F CHOKE
- L₁ = SPEAKER FIELD, 1000 OHMS
- L₂ = FILTER CHOKE, 600 OHMS, 20 TO 30 HENRIES
- C = 0.1 μf.
- C₁ = PADDING CONDENSER
- C₂ = GANGED VARIABLE CONDENSERS

- C₃ = 0.00025 μf.
- C₄ = 0.006 μf.
- C₅ = 0.01 μf.
- C₆ = 0.0005 μf.
- C₇ = 1.0 μf.
- C₈ = 8.0 μf. (500 V. ELECTROLYTIC)
- C₉ = 8.0 μf. (25 V. ELECTROLYTIC)
- C₁₀ = 0.25 μf.
- C₁₁ = 0.02 μf.
- T₁ = 175 K.C. I-F TRANSFORMER
- T₂ = PLATE-TO-PUSH-PULL-GRID TRANSFORMER
- T₃ = OUTPUT TRANSFORMER; PLATE-TO-PLATE IMPEDANCE 14000 OHMS
- T₄ = POWER TRANSFORMER; 400 R.M.S. VOLTS EACH SIDE OF CENTER, UNDER LOAD

NOTE: APPROXIMATE POWER OUTPUT OF 2A5 STAGE, 8.0 WATTS. THE CONSTANTS OF THE THREE R-F TRANSFORMERS T₁, T₂ AND T₃ WILL DEPEND UPON THE FREQUENCY RANGE AND GENERAL LAYOUT OF THE SET.

HIGH-GAIN AUDIO-FREQUENCY AMPLIFIER

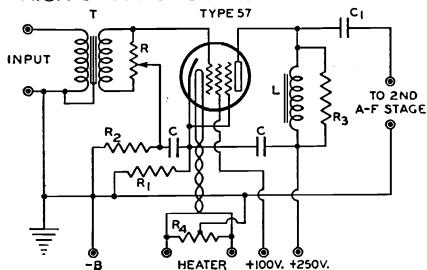

- C = A-F BY-PASS CONDENSER (0.5 μf)
- C₁ = COUPLING CONDENSER (0.01 μf)
- R = VOLUME CONTROL POTENTIOMETER (250000 OHMS)
- R₁ = SELF-BIASING RESISTOR (1000 OHM, 1 WATT)
- R₂ = DECOUPLING RESISTOR (250000 OHMS)
- R₃ = COMPENSATING RESISTOR (250000 OHMS)
- R₄ = CENTER-TAPPED RESISTOR (50 OHMS)
- T = INPUT TRANSFORMER
- L = 300 TO 500 HENRY CHOKE

RESISTANCE-COUPLED A-F AMPLIFIER

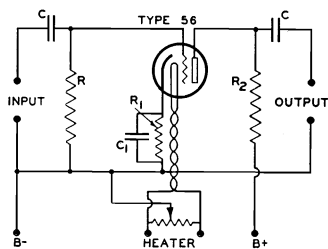

- R = GRID RESISTOR (1.0 MEGOHM, MAX)
- R₁ = SELF-BIASING RESISTOR (3000 OHMS)
- R₂ = COUPLING RESISTOR (50000 TO 100000 OHMS)
- C = COUPLING CONDENSER (0.1 μf - 1.0 μf)
- C₁ = BY-PASS CONDENSER (4 μf)

THE RCA RADIODRONE-CUNNINGHAM RADIO TUBE MANUAL

FIVE-TUBE SUPERHETERODYNE RECEIVER CIRCUIT FOR A-C AND D-C OPERATION

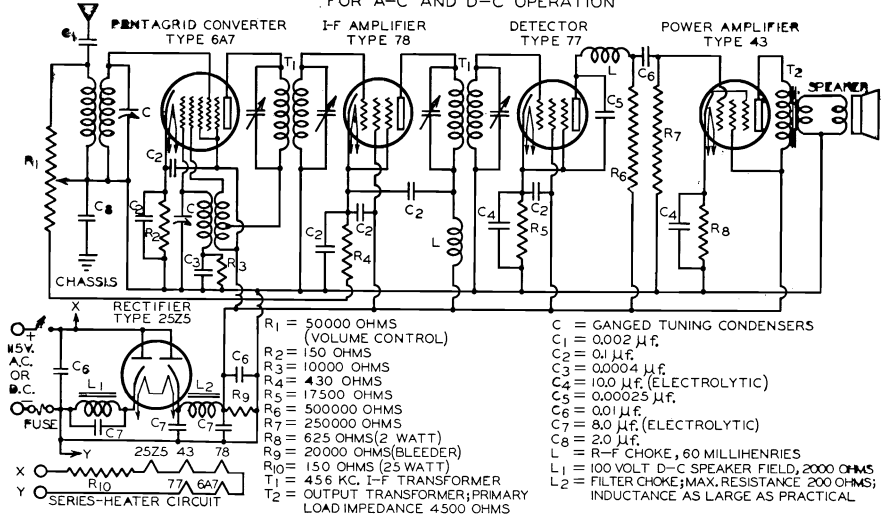

NOTE: THE MECHANICAL LAYOUT OF THE SET WILL DETERMINE TO A LARGE EXTENT THE MINIMUM SIZE OF FILTER CHOKE NECESSARY TO KEEP HUM AT A SATISFACTORY LEVEL.

CLASS A AUDIO AMPLIFIER FOR USE ON 115-VOLT D-C LINES

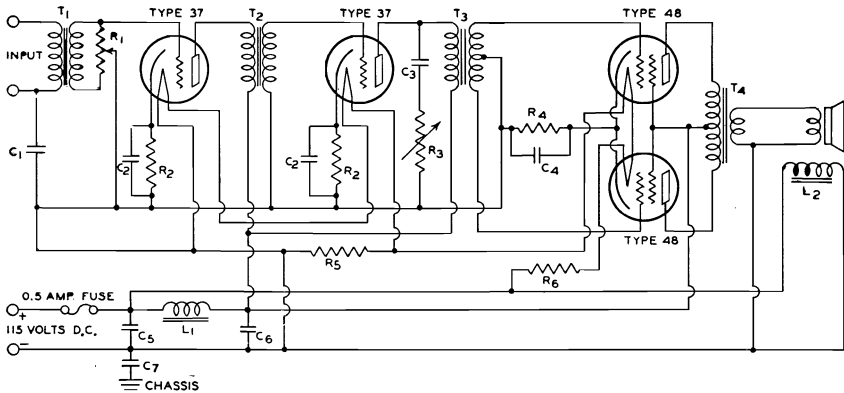

- $R_1 = 500000$ OHMS
- $R_2 = 2500$ OHMS (1 WATT)
- $R_3 = 100000$ OHMS (TONE CONTROL)
- $R_4 = 190$ OHMS (5 WATT)
- $R_5 = 125$ OHMS (2 WATT)
- $R_6 = 105$ OHMS (25 WATT)
- $C_1 = 1.0$ μ f (LOW VOLTAGE)
- $C_2 = 4.0$ μ f (LOW VOLTAGE)
- $C_3 = 0.03$ - 0.05 μ f
- $C_4 = 2.0$ μ f (LOW VOLTAGE)
- $C_5 = 2.0$ μ f (150 VOLTS)
- $C_6 = 4.0$ μ f (150 VOLTS)
- $C_7 = 2.0$ μ f (LOW VOLTAGE)
- $L_1 = 10$ HENRIES, 60 OHMS
- $L_2 = 110$ VOLT D-C SPEAKER FIELD
- $T_1 =$ INPUT-TO-GRID TRANSFORMER
- $T_2 =$ INTERSTAGE TRANSFORMER
- $T_3 =$ PLATE-TO-PUSH-PULL-GRID-TRANSFORMER
- $T_4 =$ OUTPUT TRANSFORMER; PLATE-TO-PLATE IMPEDANCE 4000 OHMS

THE RCA RADIOTRON-CUNNINGHAM RADIO TUBE MANUAL

SIX-TUBE SUPERHETERODYNE AUTOMOBILE RECEIVER CIRCUIT WITH AUTOMATIC VOLUME CONTROL

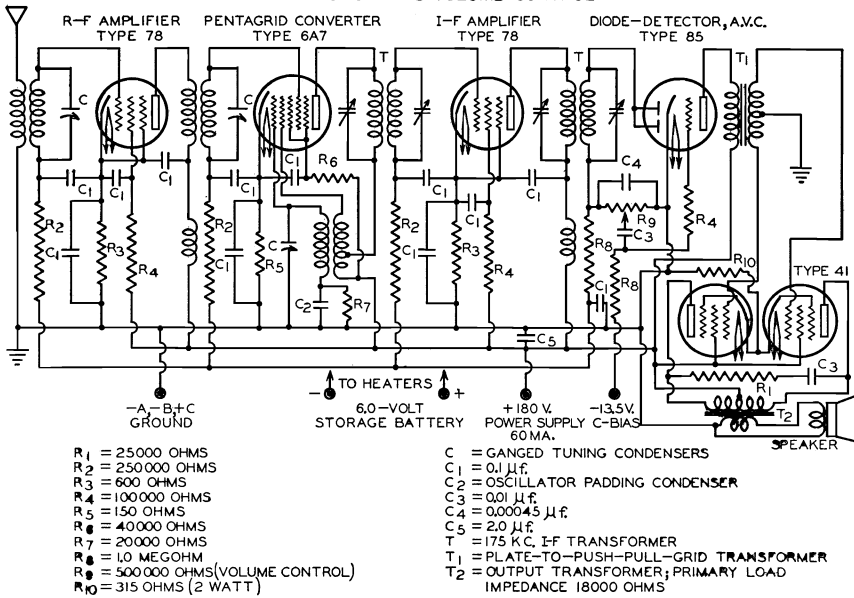

A TUNED RADIO-FREQUENCY RECEIVER CIRCUIT WITH DELAYED A.V.C. AND INTERCHANNEL NOISE SUPPRESSION

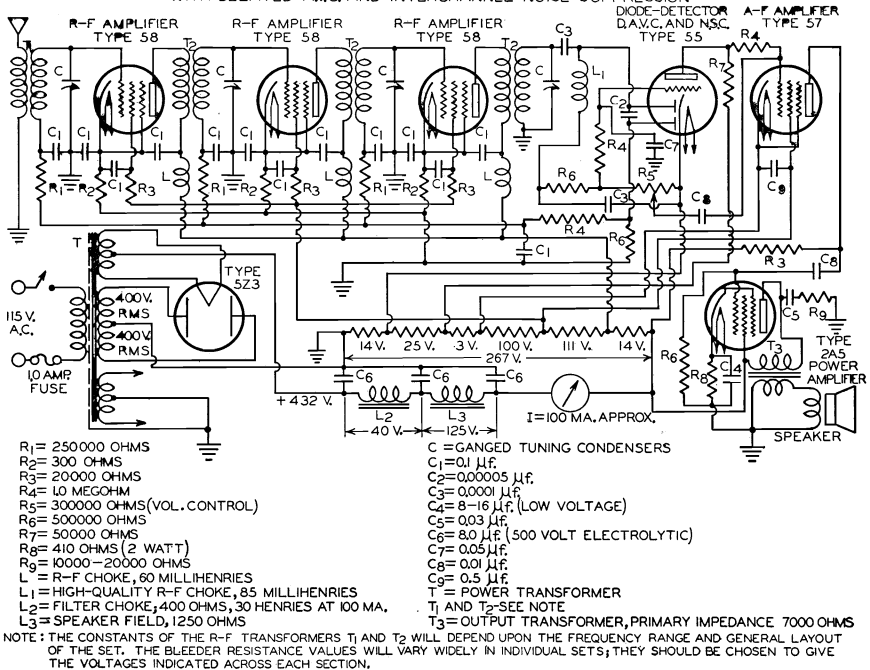

OPERATING CONDITIONS FOR RESISTANCE-COUPLED A-1 F AMPLIFIER SERVICE

Circuit Component	100				135				180				250			
	(Volts)	(Volts)	(Volts)	(Volts)	(Volts)	(Volts)	(Volts)	(Volts)	(Volts)	(Volts)	(Volts)	(Volts)	(Volts)	(Volts)	(Volts)	(Volts)
PLATE SUPPLY [∞]	-1.05	-1.05	-1.10	-1.05	-1.05	-1.10	-1.05	-1.10	-1.25	-1.20	-1.30	-1.30	-1.30	-1.30	-1.35	-1.35
SCREEN SUPPLY	10500	15400	11550	16000	6200	9150	5850	10000	4900	7100	5450	9000	3170	5200	3360	5600
GRID BIAS	0.25	0.50	0.25	0.50	0.25	0.50	0.25	0.50	0.25	0.50	0.25	0.50	0.25	0.50	0.25	0.50
CATHODE RESISTOR (Ohms)	0.25	0.25	0.50	0.50	0.25	0.25	0.50	0.50	0.25	0.25	0.50	0.50	0.25	0.25	0.50	0.50
PLATE RESISTOR (Megohm)	0.10	0.07	0.09	0.17	0.17	0.12	0.18	0.11	0.25	0.17	0.24	0.14	0.41	0.25	0.40	0.24
PLATE CURRENT (William.)	11-16	10-14	15-19	14-19	17-23	17-21	20-30	18-27	26-33	24-30	32-40	30-38	33-38	28-35	36-44	35-44
VOLT. OUTPUT* (Peak Volts)	30	29	36	37	42	38	50	48	48	46	56	55	51	48	59	58
VOLTAGE AMPLIFICATION																
PLATE SUPPLY [∞]	20	20	20	20	20	20	20	20	25	25	25	25	50	50	50	50
SCREEN SUPPLY	-2.0	-2.50	-2.15	-2.60	-1.80	-2.25	-1.95	-2.40	-2.10	-2.60	-2.10	-2.60	-4.5	-5.0	-4.5	-6.0
GRID BIAS	5550	12200	9350	19250	3800	6300	4850	10900	3700	7600	3500	7300	5600	11400	5600	11400
CATHODE RESISTOR (Ohms)	0.25	0.50	0.25	0.50	0.25	0.50	0.25	0.50	0.25	0.50	0.25	0.50	0.25	0.50	0.25	0.50
PLATE RESISTOR* (Megohm)	0.25	0.25	0.50	0.50	0.25	0.25	0.50	0.50	0.25	0.25	0.50	0.50	0.25	0.25	0.50	0.50
PLATE CURRENT (William.)	0.27	0.15	0.23	0.13	0.35	0.20	0.30	0.16	0.43	0.26	0.45	0.26	0.65	0.35	0.65	0.35
VOLT. OUTPUT* (Peak Volts)	28-30	25-27	36-38	32-33	38-40	32-35	48-50	42-44	50-53	45-48	65-68	64-66	55-65	65-60	65-70	65-75
VOLTAGE AMPLIFICATION	36	36	47	48	36	38	53	56	50	53	63	70	54	55	66	75
PLATE SUPPLY [∞]	-4.75	-3.75	-5.00	-5.50	-6.80	-4.75	-7.00	-7.00	-7.50	-7.00	-7.00	-7.50	-11	-10	-14	-12
SCREEN SUPPLY	16900	25800	21200	46000	21200	24300	22000	42500	16300	28000	14900	31200	17600	28500	25200	38600
GRID BIAS	0.25	0.50	0.25	0.50	0.25	0.50	0.25	0.50	0.25	0.50	0.25	0.50	0.25	0.50	0.25	0.50
CATHODE RESISTOR (Ohms)	0.25	0.25	0.50	0.50	0.25	0.25	0.50	0.50	0.25	0.25	0.50	0.50	0.25	0.25	0.50	0.50
PLATE RESISTOR (Megohm)	0.28	0.14	0.23	0.12	0.32	0.19	0.31	0.16	0.46	0.25	0.47	0.24	0.625	0.35	0.55	0.32
PLATE CURRENT (William.)	24-26	17-22	27-29	26-27	34-36	27-30	38-42	36-40	38-40	36-38	40-44	40-45	55-60	45-55	65-75	65-70
VOLT. OUTPUT* (Peak Volts)	6.1	6.0	6.6	6.2	6.1	6.1	6.5	6.3	6.4	6.4	6.7	6.5	6.4	6.3	6.7	6.6
VOLTAGE AMPLIFICATION																
PLATE SUPPLY [∞]	20	20	20	20	20	20	20	20	30	30	30	30	52	54	50	52
SCREEN SUPPLY	-1.10	-1.25	-1.05	-1.25	-1.20	-1.35	-1.25	-1.40	-1.25	-1.50	-1.30	-1.55	-2	-2.2	-2.1	-2.3
GRID BIAS	3760	6450	3400	7250	3100	5600	3750	6300	2180	4850	2600	4850	3100	5700	3500	6200
CATHODE RESISTOR (Ohms)	0.25	0.50	0.25	0.50	0.25	0.50	0.25	0.50	0.25	0.50	0.25	0.50	0.25	0.50	0.25	0.50
PLATE RESISTOR (Megohm)	0.25	0.25	0.50	0.50	0.25	0.25	0.50	0.50	0.25	0.25	0.50	0.50	0.25	0.25	0.50	0.50
PLATE CURRENT (William.)	0.22	0.14	0.23	0.13	0.29	0.18	0.25	0.17	0.43	0.25	0.38	0.24	0.52	0.31	0.48	0.295
VOLT. OUTPUT* (Peak Volts)	15-23	17-22	16-29	18-28	21-32	27-31	29-37	34-38	31-43	36-41	36-52	45-52	50-60	50-55	60-70	60-70
VOLTAGE AMPLIFICATION	40	39	54	53	54	52	61	62	76	65	92	93	80	75	100	110

[∞] Voltage at plate will be PLATE SUPPLY voltage minus voltage drop in plate resistor caused by plate current.

* For the following amplifier tube. The tabulated values illustrate design practice. For any particular set of conditions, however, the grid resistor for the following amplifier tube should conform to the recommendations given on the DATA page of the type involved.

** developed across plate resistor of inter-stage coupling circuit including grid resistor of following tube. Value to left is maximum undistorted output voltage obtainable; value to right is maximum output voltage obtainable with some distortion.

Note: In the above data, the use of a coupling condenser between the plate resistor and the grid resistor of the following tube is assumed. A 0.1 microfarad condenser is usually adequate to insure good low-frequency response.

ADDITIONAL TUBE TYPES

Supplementing those given on pages 30 to 132.

The **'00-A** is a three-electrode detector tube of the gas-filled type for use in storage-battery-operated receivers. As a grid-leak detector, this tube is especially effective on weak signals. See RADIO TUBE CHART for operating conditions.

The RCA Radiotron types **WD-11** and **WX-12** and the Cunningham types **C-11** and **CX-12**, are detector-amplifier tubes of the three-electrode construction for use in older types of dry-cell-operated receivers. Their electrical characteristics are identical. The 11, however, fits only the WD socket, while the 12 fits the standard four-contact socket. See RADIO TUBE CHART for characteristics.

The **'40** is a storage-battery tube of the three-electrode high-mu type designed for use in resistance- or impedance-coupled amplifier or detector circuits. See RADIO TUBE CHART for characteristics.

The RCA Radiotron **UX-874**, or the Cunningham **CX-374**, is a voltage-regulator tube designed to maintain constant d-c output voltage from rectifier devices for different values of d-c load current. In such devices, the 874, or 374, maintains an approximately constant d-c voltage of 90 volts across its terminals for any current from 10 to 50 milliamperes. This tube consists of two electrodes (a cathode and an anode) in a gas-filled bulb. It requires 125 volts for starting and shows a pronounced glow in operation. This type has an S-17 bulb (see page 151) and a medium 4-pin base. Socket connections with reference to Fig. 1 of RADIO TUBE CHART are as follows: Pin No. 1—Anode (+); Pin No. 2—Connected within base to Pin No. 4; Pin No. 3—Cathode (—); Pin No. 4—See Pin No. 2.

The RCA Radiotron **UV-876**, or the Cunningham **C-376**, is a current regulator designed for use in series with the primary of a power transformer to absorb the voltage variations normal to a-c power lines. The operating current of this tube is 1.7 amperes for a voltage range of 40 to 60 volts drop in the tube.

The RCA Radiotron **UV-886**, or the Cunningham **C-386**, is similar to the UV-876 and C-376. The operating current of this tube is 2.05 amperes for a voltage range of 40–60 volts drop in the tube.

The **RCA-868** is a sensitive phototube of the gaseous type. It is particularly well adapted for use with sound-moving pictures and for experiments with light because of its excellent response to incandescent lamp sources of light. See RADIO TUBE CHART for characteristics.

THE NEW TUBE-NUMBERING SYSTEM

Type numbers for new tubes are now being assigned in accordance with the new system adopted in the early part of 1933 by the Radio Manufacturers Association. A new system was required because practically all of the available two and three digit numbers had been utilized.

The new system, which provides for future expansion of tube types, ordinarily requires only three symbols to identify a tube. These symbols are arranged with a numeral first, then a letter, and finally, a numeral. An example of the new type designation is the 2A5.

New type numbers are formed according to the following simple rules. The first numeral indicates the filament voltage in steps of one volt. For instance, 1 is used for voltages below 2.1; 2 is used for voltages between 2.1 and 2.9 inclusive; 3 for voltages between 3.0 and 3.9, inclusive; et cetera. The digit 1, rather than the digit 2, is used for the 2.0-volt types in order to separate the 2.0- and 2.5-volt tubes. Thus, the 2.0-volt 1A6, and the 2.5-volt 2A5.

The letter is used to distinguish the tube type and is assigned, starting with A, in alphabetical sequence. In the case of rectifiers, however, the assignment is made, starting with Z, in reverse sequence.

The final numeral indicates the number of useful elements *brought out to terminals*. Thus, the 2A5 has five such elements; a heater, a cathode, two grids, and a plate.

While these rules assist to some extent in classifying tubes by filament voltage and function, the significance of the individual symbols will in most cases be inadequate to identify the specific features of a tube.

Radio Tube Chart ← RCA Radiotron

TYPE	NAME	BASE	SOCKET CONNECTIONS	DIMENSIONS MAXIMUM OVERALL LENGTH X DIAMETER	CATHODE TYPE ■	RATING			
						FILAMENT OR HEATER		PLATE	SCREEN
						VOLTS	AMPERES	MAX. VOLTS	MAX. VOLTS
RCA-1A6	PENTAGRID CONVERTER □	SMALL 6-PIN	FIG. 26	$4\frac{17}{32}'' \times 1\frac{9}{16}''$	D-C FILAMENT	2.0	0.06	180	67.5
RCA-2A3	POWER AMPLIFIER TRIODE	MEDIUM 4-PIN	FIG. 1	$5\frac{3}{8}'' \times 2\frac{1}{16}''$	FILAMENT	2.5	2.5	250	—
RCA-2A5	POWER AMPLIFIER PENTODE	MEDIUM 6-PIN	FIG. 15A	$4\frac{11}{16}'' \times 1\frac{13}{16}''$	HEATER	2.5	1.75	250	250
RCA-2A6	DUPLEX-DIODE HIGH-MU TRIODE	SMALL 6-PIN	FIG. 13	$4\frac{17}{32}'' \times 1\frac{9}{16}''$	HEATER	2.5	0.8	250	—
RCA-2A7	PENTAGRID CONVERTER □	SMALL 7-PIN	FIG. 20	$4\frac{17}{32}'' \times 1\frac{9}{16}''$	HEATER	2.5	0.8	250	100
RCA-2B7	DUPLEX-DIODE PENTODE	SMALL 7-PIN	FIG. 21	$4\frac{17}{32}'' \times 1\frac{9}{16}''$	HEATER	2.5	0.8	250	125
RCA-6A4 <i>also 6A</i>	POWER AMPLIFIER TRIODE	MEDIUM 5-PIN	FIG. 8	$4\frac{11}{16}'' \times 1\frac{13}{16}''$	FILAMENT	6.3	0.3	180	180
RCA-6A7	PENTAGRID CONVERTER □	SMALL 7-PIN	FIG. 20	$4\frac{17}{32}'' \times 1\frac{9}{16}''$	HEATER	6.3	0.3	250	100
RCA-6B7	DUPLEX-DIODE PENTODE	SMALL 7-PIN	FIG. 21	$4\frac{17}{32}'' \times 1\frac{9}{16}''$	HEATER	6.3	0.3	250	125
RCA-6F7	TRIODE- PENTODE	SMALL 7-PIN	FIG. 27	$4\frac{17}{32}'' \times 1\frac{9}{16}''$	HEATER	6.3	0.3	100 250	— 100
UX-200-A	DETECTOR TRIODE	MEDIUM 4-PIN	FIG. 1	$4\frac{11}{16}'' \times 1\frac{13}{16}''$	D-C FILAMENT	5.0	0.25	45	—
RCA-01-A	DETECTOR★ AMPLIFIER	MEDIUM 4-PIN	FIG. 1	$4\frac{11}{16}'' \times 1\frac{13}{16}''$	D-C FILAMENT	5.0	0.25	135	—
RCA-10	POWER AMPLIFIER TRIODE	MEDIUM 4-PIN	FIG. 1	$5\frac{3}{8}'' \times 2\frac{1}{16}''$	FILAMENT	7.5	1.25	425	—
□ Grids #3 and #5 are screen. Grid #4 is signal-input control-grid. ★ For Grid-leak Detection—plate volts 45, grid return to + filament or to cathode.									
WD-11	DETECTOR★ AMPLIFIER TRIODE	WD 4-PIN MEDIUM 4-PIN	FIG. 12 FIG. 1	$4\frac{1}{4}'' \times 1\frac{1}{16}''$ $4\frac{11}{16}'' \times 1\frac{13}{16}''$	D-C FILAMENT	1.1	0.25	135	—
UX-112-A	DETECTOR★ AMPLIFIER TRIODE	MEDIUM 4-PIN	FIG. 1	$4\frac{11}{16}'' \times 1\frac{13}{16}''$	D-C FILAMENT	5.0	0.25	180	—
RCA-19	TWIN AMPLIFIER	SMALL 6-PIN	FIG. 25	$4\frac{1}{4}'' \times 1\frac{9}{16}''$	D-C FILAMENT	2.0	0.26	135	—
UX-120	POWER AMPLIFIER TRIODE	SMALL 4-PIN	FIG. 1	$4\frac{1}{8}'' \times 1\frac{9}{16}''$	D-C FILAMENT	3.3	0.132	135	—
RCA-22	R-F AMPLIFIER TETRODE	MEDIUM 4-PIN	FIG. 4	$5\frac{1}{32}'' \times 1\frac{13}{16}''$	D-C FILAMENT	3.3	0.132	135	67.5
RCA-24-A	R-F AMPLIFIER TETRODE	MEDIUM 5-PIN	FIG. 9	$5\frac{1}{32}'' \times 1\frac{13}{16}''$	HEATER	2.5	1.75	275	90
RCA-26	AMPLIFIER TRIODE	MEDIUM 4-PIN	FIG. 1	$4\frac{11}{16}'' \times 1\frac{13}{16}''$	FILAMENT	1.5	1.05	180	—
RCA-27	DETECTOR★ AMPLIFIER TRIODE	MEDIUM 5-PIN	FIG. 8	$4\frac{11}{16}'' \times 1\frac{13}{16}''$	HEATER	2.5	1.75	275	—
RCA-30	DETECTOR★ AMPLIFIER TRIODE	SMALL 4-PIN	FIG. 1	$4\frac{1}{4}'' \times 1\frac{9}{16}''$	D-C FILAMENT	2.0	0.06	180	—
RCA-31	POWER AMPLIFIER TRIODE	SMALL 4-PIN	FIG. 1	$4\frac{1}{4}'' \times 1\frac{9}{16}''$	D-C FILAMENT	2.0	0.13	180	—
RCA-32	R-F AMPLIFIER TETRODE	MEDIUM 4-PIN	FIG. 4	$5\frac{1}{32}'' \times 1\frac{13}{16}''$	D-C FILAMENT	2.0	0.06	180	67.5
RCA-33	POWER AMPLIFIER PENTODE	MEDIUM 5-PIN	FIG. 6	$4\frac{11}{16}'' \times 1\frac{13}{16}''$	D-C FILAMENT	2.0	0.26	135	135
RCA-34	SUPER-CONTROL R-F AMPLIFIER PENTODE	MEDIUM 4-PIN	FIG. 4A	$5\frac{1}{32}'' \times 1\frac{13}{16}''$	D-C FILAMENT	2.0	0.06	180	67.5
RCA-35	SUPER-CONTROL R-F AMPLIFIER TETRODE	MEDIUM 5-PIN	FIG. 9	$5\frac{1}{32}'' \times 1\frac{13}{16}''$	HEATER	2.5	1.75	275	90
★ For Grid-leak Detection—plate volts 45, grid return to + filament or to cathode. ■ Either A. C. or D. C. may be used on filament or heater, except as specifically noted. For use of D. C. on A-C filament types, decrease stated grid volts by $\frac{1}{2}$ (approx.) of filament voltage.									

Cunningham → Radio Tube Chart

USE <small>Values to right give operating conditions and characteristics for indicated typical use</small>	PLATE SUPPLY VOLTS	GRID VOLTS	SCREEN VOLTS	SCREEN MILLI-AMP.	PLATE MILLI-AMP.	A-C PLATE RESISTANCE OHMS	MUTUAL CONDUCTANCE MICRO-MHOS	VOLT-AGE AMPLIFICATION FACTOR	LOAD FOR STATED POWER OUTPUT OHMS	POWER OUTPUT WATTS	TYPE
CONVERTER	180	-3.0 min.	67.5	2.4	1.3	500000	Anode-Grid (#2) 135 Max. Volts, 2.3 Ma. Oscillator Grid (#1) Resistor, 50000 Ohms. Conversion Conductance, 300 Micromhos.				C-1A6
CLASS A AMPLIFIER	250	-45			60.0	300	5250	4.2	2500	3.5	
PUSH-PULL AMPLIFIER	300 300	-62		Self-bias Fixed-bias	40.0 40.0	Power Output is for 2 tubes at stated load, plate-to-plate			5000 3000	10.0 15.0	C-2A3
CLASS A AMPLIFIER	250	-16.5	250	6.5	34.0	100000	2200	220	7000	3.0	C-2A5
TRIODE UNIT AS CLASS A AMPLIFIER	250*	-1.35			0.4			Gain per stage = 50-60			C-2A6
CONVERTER	250	-3.0	100	2.2	3.5	360000	Anode Grid (#2) 200 Max. Volts, 4.0 Ma. Oscillator Grid (#1) Resistor, 50000 Ohms. Conversion Conductance, 520 Micromhos.				C-2A7
PENTODE UNIT AS R-F AMPLIFIER	100 250	-3.0 -3.0	100 125	1.7 2.3	5.8 9.0	300000 650000	950 1125	285 730			C-2B7
PENTODE UNIT AS A-F AMPLIFIER	250†	-4.5	50		0.65						
CLASS A AMPLIFIER	100 180	-6.5 -12.0	100 180	1.6 3.9	9.0 22.0	83250 45500	1200 2200	100 100	11000 8000	0.31 1.40	C-6A4 <i>also LA</i>
CONVERTER	250	-3.0	100	2.2	3.5	360000	Anode Grid (#2) 200 Max. Volts, 4.0 Ma. Oscillator Grid (#1) Resistor, 50000 Ohms. Conversion Conductance, 520 Micromhos.				C-6A7
PENTODE UNIT AS R-F AMPLIFIER	100 250	-3.0 -3.0	100 125	1.7 2.3	5.8 9.0	300000 650000	950 1125	285 730			C-6B7
PENTODE UNIT AS A-F AMPLIFIER	250†	-4.5	50		0.65						
TRIODE UNIT AS AMPLIFIER	100	-3.0			3.5	17800	450	8			
PENTODE UNIT AS AMPLIFIER	250	-3.0	100	1.5	6.5	850000	1100	900			C-6F7
PENTODE UNIT AS MIXER	250	-10.0	100	0.6	2.8		Oscillator peak volts = 7.0. Conversion conductance = 300 micromhos.				
GRID LEAK DETECTOR	45		Grid Return to (-) Filament		1.5	30000	666	20			CX-300-A
CLASS A AMPLIFIER	90 135	-4.5 -9.0			2.5 3.0	11000 10000	725 800	8.0 8.0			C-01-A
CLASS A AMPLIFIER	350 425	-31.0 -39.0			16.0 18.0	5150 5000	1550 1600	8.0 8.0	11000 10200	0.9 1.6	C-10
† Applied through plate coupling resistor of 200000 ohms. * Applied through plate coupling resistor of 250000 ohms.											
CLASS A AMPLIFIER	90 135	-4.5 -10.5			2.5 3.0	15500 15000	425 440	6.6 6.6			C-11 CX-12
CLASS A AMPLIFIER	90 180	-4.5 -13.5			5.0 7.7	5400 4700	1575 1800	8.5 8.5			CX-112-A
CLASS B AMPLIFIER	135 135	0 -3.0				Power output value is for one tube at stated load, plate-to-plate.			10000 10000	2.1 1.9	C-19
CLASS A AMPLIFIER	90 135	-16.5 -22.5			3.0 6.5	8000 6300	415 525	3.3 3.3	9600 6500	0.045 0.110	CX-220
SCREEN GRID R-F AMPLIFIER	135 135	-1.5 -1.5	45 67.5	0.6* 1.3*	1.7 3.7	725000 325000	375 500	270 160			C-22
SCREEN GRID R-F AMPLIFIER	180 250	-3.0 -3.0	90 90	1.7* 1.7*	4.0 4.0	400000 600000	1000 1050	400 630			C-24-A
BIAS DETECTOR	275●	-5.0 approx.	20 to 45			Plate current to be adjusted to 0.1 milliamperes with no signal.					
CLASS A AMPLIFIER	90 180	-7.0 -14.5			2.9 6.2	8900 7300	935 1150	8.3 8.3			C-26
CLASS A AMPLIFIER	135 250	-9.0 -21.0			4.5 5.2	9000 9250	1000 975	9.0 9.0			C-27
BIAS DETECTOR	250	-30.0				Plate current to be adjusted to 0.2 milliamperes with no signal.					
CLASS A AMPLIFIER	90 135 180	-4.5 -9.0 -13.5			2.5 3.0 3.1	11000 10300 10300	850 900 900	9.3 9.3 9.3			C-30
CLASS A AMPLIFIER	135 180	-22.5 -30.0			8.0 12.3	4100 3600	925 1050	3.8 3.8	7000 5700	0.185 0.375	C-31
SCREEN GRID R-F AMPLIFIER	135 180	-3.0 -3.0	67.5 67.5	0.4* 0.4*	1.7 1.7	950000 1200000	640 650	610 780			C-32
BIAS DETECTOR	180♥	-6.0 approx.	67.5			Plate current to be adjusted to 0.2 milliamperes with no signal.					
CLASS A AMPLIFIER	135	-13.5	135	3.0	14.5	50000	1450	70	7000	0.7	C-33
SCREEN GRID R-F AMPLIFIER	135 180	{ -3.0 } min. }	67.5 67.5	1.0 1.0	2.8 2.8	600000 1000000	600 620	360 620			C-34
SCREEN GRID R-F AMPLIFIER	180 250	{ -3.0 } min. }	90 90	2.5* 2.5*	6.3 6.5	300000 400000	1020 1050	305 420			C-35
● Applied through plate coupling resistor of 250000 ohms or 500-henry choke shunted by 0.25 megohm resistor. ♥ Applied through plate coupling resistor of 100000 ohms. *Maximum.											

Radio Tube Chart (Continued) ← RCA Radiotron

TYPE	NAME	BASE	SOCKET CONNECTIONS	DIMENSIONS MAXIMUM OVERALL LENGTH X DIAMETER	CATHODE TYPE ■	RATING			
						FILAMENT OR HEATER		PLATE	SCREEN
						VOLTS	AMPERES	MAX. VOLTS	MAX. VOLTS
RCA- 36	R-F AMPLIFIER TETRODE	SMALL 5-PIN	FIG. 9	$4\frac{1}{2}'' \times 1\frac{9}{16}''$	HEATER	6.3	0.3	250	90
RCA- 37	DETECTOR+ AMPLIFIER TRIODE	SMALL 5-PIN	FIG. 8	$4\frac{1}{4}'' \times 1\frac{9}{16}''$	HEATER	6.3	0.3	250	—
RCA- 38	POWER AMPLIFIER PENTODE	SMALL 5-PIN	FIG. 9A	$4\frac{1}{2}'' \times 1\frac{9}{16}''$	HEATER	6.3	0.3	250	250
RCA-39-44	SUPER-CONTROL R-F AMPLIFIER PENTODE	SMALL 5-PIN	FIG. 9A	$4\frac{1}{2}'' \times 1\frac{9}{16}''$	HEATER	6.3	0.3	250	90
UX -240	VOLTAGE AMPLIFIER TRIODE	MEDIUM 4-PIN	FIG. 1	$4\frac{11}{16}'' \times 1\frac{13}{16}''$	D-C FILAMENT	5.0	0.25	180	—
RCA- 41	POWER AMPLIFIER PENTODE	SMALL 6-PIN	FIG. 15A	$4\frac{1}{8}'' \times 1\frac{9}{16}''$	HEATER	6.3	0.4	250	250
RCA- 42	POWER AMPLIFIER PENTODE	MEDIUM 6-PIN	FIG. 15A	$4\frac{11}{16}'' \times 1\frac{13}{16}''$	HEATER	6.3	0.7	250	250
RCA- 43	POWER AMPLIFIER PENTODE	MEDIUM 6-PIN	FIG. 15A	$4\frac{11}{16}'' \times 1\frac{13}{16}''$	HEATER	25.0	0.3	135	135
RCA- 45	POWER AMPLIFIER TRIODE	MEDIUM 4-PIN	FIG. 1	$4\frac{11}{16}'' \times 1\frac{13}{16}''$	FILAMENT	2.5	1.5	275	—
RCA- 46	DUAL-GRID POWER AMPLIFIER	MEDIUM 5-PIN	FIG. 7	$5\frac{5}{8}'' \times 2\frac{1}{16}''$	FILAMENT	2.5	1.75	250	—
								490	—
RCA- 47	POWER AMPLIFIER PENTODE	MEDIUM 5-PIN	FIG. 6	$5\frac{5}{8}'' \times 2\frac{1}{16}''$	FILAMENT	2.5	1.75	250	250
RCA- 48	POWER AMPLIFIER TETRODE	MEDIUM 6-PIN	FIG. 15	$5\frac{3}{8}'' \times 2\frac{1}{16}''$	D-C HEATER	30.0	0.4	125	100
*For Grid-leak Detection—plate volts 45, grid return to + filament or to cathode.									
RCA- 49	DUAL-GRID POWER AMPLIFIER	MEDIUM 5-PIN	FIG. 7	$4\frac{11}{16}'' \times 1\frac{13}{16}''$	D-C FILAMENT	2.0	0.120	135	—
								180	—
UX -250	POWER AMPLIFIER TRIODE	MEDIUM 4-PIN	FIG. 1	$6\frac{1}{4}'' \times 2\frac{11}{16}''$	FILAMENT	7.5	1.25	450	—
RCA- 53	TWIN-TRIODE AMPLIFIER	MEDIUM 7-PIN#	FIG. 24	$4\frac{11}{16}'' \times 1\frac{13}{16}''$	HEATER	2.5	2.0	300	—
RCA- 55	DUPLEX-DIODE TRIODE	SMALL 6-PIN	FIG. 13	$4\frac{17}{32}'' \times 1\frac{9}{16}''$	HEATER	2.5	1.0	250	—
RCA- 56	SUPER-TRIODE AMPLIFIER DETECTOR*	SMALL 5-PIN	FIG. 8	$4\frac{1}{4}'' \times 1\frac{9}{16}''$	HEATER	2.5	1.0	250	—
RCA- 57	TRIPLE-GRID AMPLIFIER DETECTOR	SMALL 6-PIN	FIG. 11	$4\frac{15}{16}'' \times 1\frac{9}{16}''$	HEATER	2.5	1.0	250	100
RCA- 58	TRIPLE-GRID SUPER-CONTROL AMPLIFIER	SMALL 6-PIN	FIG. 11	$4\frac{15}{16}'' \times 1\frac{9}{16}''$	HEATER	2.5	1.0	250	100
RCA- 59	TRIPLE-GRID POWER AMPLIFIER	MEDIUM 7-PIN#	FIG. 18	$5\frac{3}{8}'' \times 2\frac{1}{16}''$	HEATER	2.5	2.0	250	—
								250	250
								400	—
RCA- 71-A	POWER AMPLIFIER TRIODE	MEDIUM 4-PIN	FIG. 1	$4\frac{11}{16}'' \times 1\frac{13}{16}''$	FILAMENT	5.0	0.25	160	—
RCA- 75	DUPLEX-DIODE HIGH- μ TRIODE	SMALL 6-PIN	FIG. 13	$4\frac{17}{32}'' \times 1\frac{9}{16}''$	HEATER	6.3	0.3	250	—
RCA- 77	TRIPLE-GRID AMPLIFIER DETECTOR	SMALL 6-PIN	FIG. 11	$4\frac{15}{32}'' \times 1\frac{9}{16}''$	HEATER	6.3	0.3	250	100
RCA- 78	TRIPLE-GRID SUPER-CONTROL AMPLIFIER	SMALL 6-PIN	FIG. 11	$4\frac{17}{32}'' \times 1\frac{9}{16}''$	HEATER	6.3	0.3	250	125
<p>*For Grid-leak Detection—plate volts 45, grid return to + filament or to cathode. ■ Either A, C, or D, C, may be used on filament or heater, except as specifically noted. For use of D, C, on A-C filament types, decrease stated grid volts by $\frac{1}{2}$ (approx.) of filament voltage. # Requires different socket from small 7-pin.</p>									

Cunningham → Radio Tube Chart (Continued)

USE <small>Values to right give operating conditions and characteristics for indicated typical use</small>	PLATE SUPPLY VOLTS	GRID VOLTS	SCREEN VOLTS	SCREEN MILLI-AMP.	PLATE MILLI-AMP.	A-C PLATE RESISTANCE OHMS	MUTUAL CONDUCTANCE MICRO-MHOS	VOLT-AGE AMPLIFICATION FACTOR	LOAD FOR STATED POWER OUTPUT OHMS	POWER OUTPUT WATTS	TYPE
SCREEN GRID R-F AMPLIFIER	100 180 250	- 1.5 - 3.0 - 3.0	55 90 90	— — 1.7*	1.8 3.1 3.2	550000 500000 550000	850 1050 1080	470 525 595	— — —	— — —	C - 36
BIAS DETECTOR	100● 250●	- 5.0 - 8.0	55 90	—	Plate current to be adjusted to 0.1 milliampere with no signal.						
CLASS A AMPLIFIER	90 180 250	- 6.0 - 13.5 - 18.0	— — —	— — —	2.5 4.3 7.5	11500 10200 8400	800 900 1100	9.2 9.2 9.2	— — —	— — —	C - 37
BIAS DETECTOR	90 250	- 10.0 - 28.0	— —	— —	Plate current to be adjusted to 0.2 milliampere with no signal.						
CLASS A AMPLIFIER	100 180 250	- 9.0 - 18.0 - 25.0	100 180 250	1.2 2.4 3.8	7.0 14.0 22.0	140000 110000 100000	875 1050 1200	120 120 120	15000 11600 10000	0.27 1.06 2.50	C - 38
SCREEN GRID R-F AMPLIFIER	90 180 250	{ - 3.0 min. }	90 90 90	1.6 1.4 1.4	5.6 5.8 5.8	375000 750000 1000000	960 1000 1050	360 750 1050	— — —	— — —	
CLASS A AMPLIFIER	135× 180×	- 1.5 - 3.0	— —	— —	0.2 0.2	150000 150000	200 200	30 30	— —	— —	CX-340
CLASS A AMPLIFIER	100 180 250	- 7.0 - 13.5 - 18.0	100 180 250	1.6 3.0 5.5	9.0 18.5 32.0	103500 81000 68000	1450 1850 2200	150 150 150	12000 9000 7600	0.33 1.50 3.4c	
CLASS A AMPLIFIER	250	- 16.5	250	6.5	34.0	100000	2200	220	7000	3.00	C - 42
CLASS A AMPLIFIER	100 135	- 15.0 - 20.0	100 135	4.0 7.0	20.0 34.0	45000 35000	2000 2300	90 80	4500 4000	0.50 2.00	
CLASS A AMPLIFIER	180 250	- 31.5 - 50.0	180 250	— —	31.0 34.0	1650 1610	2125 2175	3.5 3.5	2700 3900	0.82 1.60	C - 45
CLASS A AMPLIFIER	275	- 56.0	275	—	36.0	1700	2050	3.5	4600	2.00	
CLASS A AMPLIFIER □	250	- 33.0	—	—	22.0	2380	2350	5.6	6400	1.25	C - 46
CLASS B AMPLIFIER ♦	300 400	0 0	— —	— —	Power output values are for 2 tubes at indicated plate-to-plate load.						
CLASS A AMPLIFIER	250	- 16.5	250	6.0	31.0	60000	2500	150	7000	2.7	C - 47
CLASS A AMPLIFIER	95 125	- 20.0 - 22.5	95 100	9.0 9.0	47.0 50.0	10000 10000	2800 2800	28 28	2000 2000	1.6 2.5	
● Applied through plate coupling resistor of 250000 ohms or 500-henry choke shunted by 0.25 megohm resistor. × Applied through plate coupling resistor of 250000 ohms. ♦ Two grids tied together. *Maximum.											
CLASS A AMPLIFIER □	135	- 20.0	—	—	5.7	4000	1125	4.5	11000	0.17	C - 49
CLASS B AMPLIFIER ♦	180	0	—	—	Power output values are for 2 tubes at indicated plate-to-plate load.						
CLASS A AMPLIFIER	300 400 450	- 54.0 - 70.0 - 84.0	— — —	— — —	35.0 55.0 55.0	2000 1800 1800	1900 2100 2100	3.8 3.8 3.8	4600 3670 4350	1.6 3.4 4.6	CX-350
CLASS B AMPLIFIER	250 300	0 0	— —	— —	Power output value is for one tube at stated load, plate-to-plate.						
TRIODE UNIT AS CLASS A AMPLIFIER	135 180 250	- 10.5 - 13.5 - 20.0	— — —	— — —	3.7 6.0 8.0	11000 8500 7500	750 975 1100	8.3 8.3 8.3	25000 20000 20000	0.075 0.160 0.350	C - 55
CLASS A AMPLIFIER	250	- 13.5	—	—	5.0	9500	1450	13.8	—	—	
BIAS DETECTOR	250	- 20.0	—	—	Plate current to be adjusted to 0.2 milliampere with no signal.						
SCREEN GRID R-F AMPLIFIER	250	- 3.0	100	0.5	2.0	exceeds 1.5 meg.	1225	exceeds 1500	—	—	C - 57
BIAS DETECTOR	250	- 3.9	100	Cathode current 0.97 ma.		—	Plate coupling resistor 250000 ohms. Grid coupling resistor 250000 ohms**.				
SCREEN GRID R-F AMPLIFIER	250	{ - 3.0 min. }	100	2.0	8.2	800000	1600	1280	—	—	C - 58
MIXER IN SUPERHETERODYNE AS TRIODE CLASS A AMPLIFIER	250	- 10.0	100	—	—	Oscillator peak volts = 7.0.					
AS PENTODE CLASS A AMPLIFIER	250	- 28.0	—	—	26.0	2400	2600	6.0	5000	1.25	C - 59
AS TRIODE CLASS B AMPLIFIER	300 400	0 0	— —	— —	Power output values are for 2 tubes at indicated plate-to-plate load.						
CLASS A AMPLIFIER	90 180	- 19.0 - 43.0	— —	— —	10.0 20.0	2170 1750	1400 1700	3.0 3.0	3000 4800	0.125 0.790	C - 71-A
TRIODE UNIT AS CLASS A AMPLIFIER	250×	- 1.35	—	—	0.4	—	—	—	Gain per stage = 50-60		
SCREEN GRID R-F AMPLIFIER	100 250	- 1.5 - 3.0	60 100	0.4 0.6	1.7 2.3	650000 1500000	1100 1250	715 1500	— —	— —	C - 77
BIAS DETECTOR	250	- 1.95	50	Cathode current 0.65 ma.		—	Plate coupling resistor 250000 ohms. Grid coupling resistor 250000 ohms**.				
SCREEN GRID R-F AMPLIFIER	90 180 250	{ - 3.0 min. }	90 100 125	1.5 1.0 3.0	5.4 4.0 7.0	315000 1000000 800000	1275 1100 1450	400 1100 1160	— — —	— — —	C - 78
BIAS DETECTOR	250	—	125	3.0	10.5	600000	1650	990	—	—	

■ Grid #1 is control grid. Grid #2 is screen. Grid #3 tied to cathode. ♦ Two grids tied together.
 † Grid #1 is control grid. Grids #2 and #3 tied to plate. × Applied through plate coupling resistor of 250000 ohms.
 ● Grids #1 and #2 connected together. Grid #3 tied to plate. **For grid of following tube.

Radio Tube Chart (Continued) ← RCA Radiotron

TYPE	NAME	BASE	SOCKET CONNEC-TIONS	DIMENSIONS MAXIMUM OVERALL LENGTH X DIAMETER	CATHODE TYPE ■	RATING			
						FILAMENT OR HEATER		PLATE	SCREEN
						VOLTS	AMPERES	MAX. VOLTS	MAX. VOLTS
RCA- 79	TWIN-TRIODE AMPLIFIER	SMALL 6-PIN	FIG. 19	$4\frac{3}{32}'' \times 1\frac{9}{16}''$	HEATER	6.3	0.6	250	—
RCA- 85	DUPLEX-DIODE TRIODE	SMALL 6-PIN	FIG. 13	$4\frac{1}{32}'' \times 1\frac{3}{16}''$	HEATER	6.3	0.3	250	—
RCA- 89	TRIPLE-GRID POWER AMPLIFIER	SMALL 6-PIN	FIG. 14	$4\frac{1}{32}'' \times 1\frac{9}{16}''$	HEATER	6.3	0.4	250	250
UV -199 UX -199	DETECTOR* AMPLIFIER TRIODE	SMALL 4-NUB SMALL 4-PIN	FIG. 10 FIG. 1	$3\frac{3}{8}'' \times 1\frac{1}{16}''$ $4\frac{1}{8}'' \times 1\frac{3}{16}''$	D-C FILAMENT	3.3	0.063	90	—
RCA-864	AMPLIFIER TRIODE	SMALL 4-PIN	FIG. 1	$4'' \times 1\frac{3}{16}''$	D-C FILAMENT	1.1	0.25	135	—

*For Grid-leak Detection—plate volts 45, grid return to + filament or to cathode.
 ■ Either A. C. or D. C. may be used on filament or heater, except as specifically noted. For use of D. C. on A-C filament types, decrease stated grid volts by $\frac{1}{2}$ (approx.) of filament voltage.

RECTIFIERS

RCA-5Z3	FULL-WAVE RECTIFIER	MEDIUM 4-PIN	FIG. 2	$5\frac{3}{8}'' \times 2\frac{1}{16}''$	FILAMENT	5.0	3.0	—	—
RCA-12Z3	HALF-WAVE RECTIFIER	SMALL 4-PIN	FIG. 22	$4\frac{1}{4}'' \times 1\frac{9}{16}''$	HEATER	12.6	0.3	—	—
RCA-25Z5	RECTIFIER- DOUBLER	SMALL 6-PIN	FIG. 5	$4\frac{1}{4}'' \times 1\frac{9}{16}''$	HEATER	25.0	0.3	—	—
RCA-1-v°	HALF-WAVE RECTIFIER	SMALL 4-PIN	FIG. 22	$4\frac{1}{4}'' \times 1\frac{9}{16}''$	HEATER	6.3	0.3	—	—
RCA- 80	FULL-WAVE RECTIFIER	MEDIUM 4-PIN	FIG. 2	$4\frac{11}{16}'' \times 1\frac{13}{16}''$	FILAMENT	5.0	2.0	—	—
UX -281	HALF-WAVE RECTIFIER	MEDIUM 4-PIN	FIG. 3	$6\frac{1}{4}'' \times 2\frac{7}{16}''$	FILAMENT	7.5	1.25	—	—
RCA- 82	FULL-WAVE RECTIFIER ▶	MEDIUM 4-PIN	FIG. 2	$4\frac{11}{16}'' \times 1\frac{13}{16}''$	FILAMENT	2.5	3.0	—	—
RCA- 83	FULL-WAVE RECTIFIER ▶	*MEDIUM 4-PIN	FIG. 2	$5\frac{3}{8}'' \times 2\frac{1}{16}''$	FILAMENT	5.0	3.0	—	—
RCA- 84 also 6Z4	FULL-WAVE RECTIFIER	SMALL 5-PIN	FIG. 23	$4\frac{1}{4}'' \times 1\frac{9}{16}''$	HEATER	6.3	0.5	—	—
RCA-866	HALF-WAVE ▶ RECTIFIER	MEDIUM 4-PIN	FIG. 3 See Note □	$6\frac{5}{8}'' \times 2\frac{7}{16}''$	FILAMENT	2.5	5.0	—	—

▶ Mercury Vapor Type. ° Interchangeable with type 1.

□ Plate connection made to top cap of tube.

PHOTOTUBES

RCA-868	PHOTOTUBE	SMALL 4-PIN	FIG. 1 See Note →	$4\frac{1}{8}'' \times 1\frac{3}{16}''$	Note: Pins No. 1 and No. 3—No Connections, Pin No. 2—Anode (+), Pin No. 4—Cathode (—).
---------	-----------	-------------	----------------------	---	--

INDEX OF TYPES BY USE AND BY CATHODE VOLTAGE

CATHODE VOLTS	POWER AMPLIFIERS	VOLTAGE AMPLIFIERS <i>Including Duplex-Diode Types</i>	CONVERTERS IN SUPERHETERODYNES
1.1	—	11, 12, 864	—
1.5	—	26	—
2.0	19, 31, 33, 49	30, 32, 34	1A6
2.5	2A3, 2A5, 45, 46, 47, 53, 59	2A6, 2B7, 24-A, 27, 35, 55, 56, 57, 58	2A7
3.3	'20	22, '99	—
5.0	112-A, 71-A	01-A, '40, 112-A	—
6.3	6A4, 38, 41, 42, 75, 89	6B7, 6F7, 36, 37, 39-44, 75, 77, 73, 85	6A7, 6F7
7.5	10, '50	—	—
12.6	—	—	—
25.0	43	—	—
30.0	48	—	—

Cunningham → Radio Tube Chart (Continued)

USE Values to right give operating conditions and characteristics for indicated typical use	PLATE SUP- PLY VOLTS	GRID VOLTS ■	SCREEN VOLTS	SCREEN MILLI- AMP.	PLATE MILLI- AMP.	A-C PLATE RESIS- TANCE OHMS	MUTUAL CON- DUC- TANCE MICRO- MHOS	VOLT- AGE AMPLI- FICATION FACTOR	LOAD FOR STATED POWER OUTPUT OHMS	POWER OUT- PUT WATTS	TYPE
CLASS B AMPLIFIER	180 250	0 0	—	—	Power output value is for one tube at stated load, plate-to-plate.				7000 14000	5.5 8.0	C - 79
TRIODE UNIT AS CLASS A AMPLIFIER	135 180 250	-10.5 -13.5 -20.0	—	—	3.7 6.0 8.0	11000 8500 7500	750 975 1100	8.3 8.3 8.3	25000 20000 20000	0.075 0.160 0.350	C - 85
AS TRIODE † CLASS A AMPLIFIER	160 180 250	-20.0 -22.5 -31.0	—	—	17.0 20.0 32.0	3300 3000 2600	1425 1550 1800	4.7 4.7 4.7	7000 6500 5500	0.300 0.400 0.900	C - 89
AS PENTODE ■■ CLASS A AMPLIFIER	100 180 250	-10.0 -18.0 -25.0	100 180 250	1.6 3.0 5.5	9.5 20.0 32.0	104000 80000 70000	1200 1550 1800	125 125 125	10700 8000 6750	0.33 1.50 3.40	
AS TRIODE ● CLASS B AMPLIFIER	180	0	—	—	Power output values are for 2 tubes operating at indicated plate-to-plate load.				13600 9400	2.50 3.50	
CLASS A AMPLIFIER	90	- 4.5	—	—	2.5	15500	425	6.6	—	—	C -299 CX-299
CLASS A AMPLIFIER	90 135	- 4.5 - 9.0	—	—	2.9 3.5	13500 12700	610 645	8.2 8.2	—	—	C -864
■■ Grid #1 is control grid. Grid #2 is screen. Grid #3 tied to cathode † Grid #1 is control grid. Grids #2 and #3 tied to plate. ● Grids #1 and #2 connected together. Grid #3 tied to plate.											
RECTIFIERS											
Maximum A-C Voltage per Plate.....										500 Volts, RMS	C - 523
Maximum D-C Output Current.....										250 Milliampères	
Maximum A-C Voltage per Plate.....										250 Volts, RMS	C-1223
Maximum D-C Output Current.....										60 Milliampères	
Maximum A-C Voltage per Plate.....										125 Volts, RMS	C-2525
Maximum D-C Output Current.....										100 Milliampères	
Maximum A-C Voltage per Plate.....										350 Volts, RMS	C-1V°
Maximum D-C Output Current.....										50 Milliampères	
A-C Voltage per Plate (Volts RMS).....										350 400 550	C - 80
D-C Output Current (Maximum MA.).....										125 110 135	
The 550 volt rating applies to filter circuits having an input choke of at least 20 henries.											
Maximum A-C Plate Voltage.....										700 Volts, RMS	CX-381
Maximum D-C Output Current.....										85 Milliampères	
Maximum A-C Voltage per Plate.....										500 Volts, RMS	C - 82
Maximum D-C Output Current.....										125 Milliampères	
Maximum Peak Inverse Voltage.....										1400 Volts	C - 83
Maximum Peak Plate Current.....										400 Milliampères	
Maximum A-C Voltage per Plate.....										500 Volts, RMS	C - 84 also 624
Maximum D-C Output Current.....										250 Milliampères	
Maximum Peak Inverse Voltage.....										1400 Volts	C - 866 (CX-366)
Maximum Peak Plate Current.....										0.6 Ampere	
PHOTOTUBES											
Max. Anode Supply Voltage, 90 Volts. Max. Anode Current, 20 Microampères. Static Sensitivity, 55 Microampères per Lumen. Dynamic Sensitivity, 50 and 48 Microampères per Lumen at 1000 and 5000 Cycles per second, respectively.											C - 868
INDEX OF TYPES BY USE AND BY CATHODE VOLTAGE											
DETECTORS			MIXER TUBES IN SUPERHETERODYNES				RECTIFIERS			CATHODE VOLTS	
11, 12, 864			—				—			1.1	
—			—				—			1.5	
30, 32			1A6, 34				—			2.0	
2A6, 2B7, 24-A, 27, 55, 56, 57			2A7, 35, 58				82, 866 (C-366)			2.5	
'99			—				—			3.3	
00-A, 01-A, '40, 112-A			—				523, 80, 83			5.0	
6B7, 6F7, 36, 37, 75, 77, 85			6A7, 6F7, 39-44, 78				1-v, 84			6.3	
—			—				'81			7.5	
—			—				1223			12.6	
—			—				2525			25.0	
—			—				—			30.0	

Tube Symbols and Bottom Views of Socket Connections

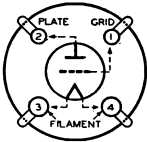

FIG. 1

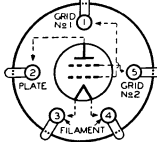

FIG. 7

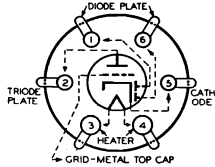

FIG. 13

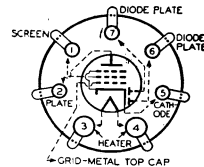

FIG. 21

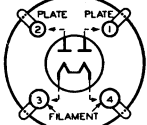

FIG. 2

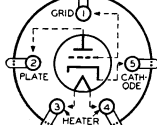

FIG. 8

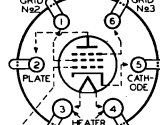

FIG. 14

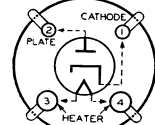

FIG. 22

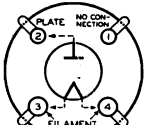

FIG. 3

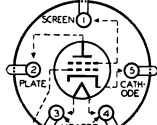

FIG. 9

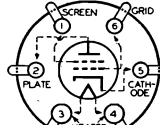

FIG. 15

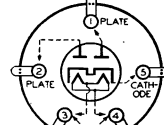

FIG. 23

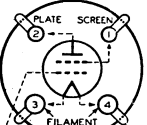

FIG. 4

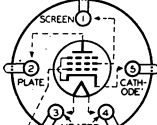

FIG. 9A

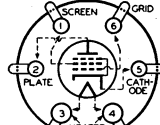

FIG. 15A

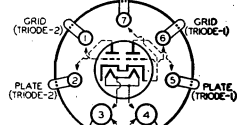

FIG. 24

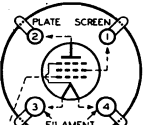

FIG. 4A

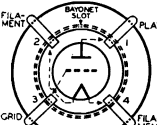

FIG. 10

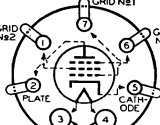

FIG. 18

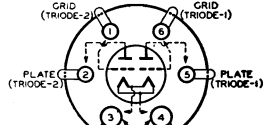

FIG. 25

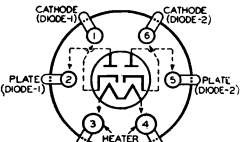

FIG. 5

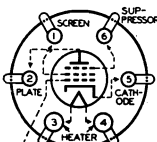

FIG. 11

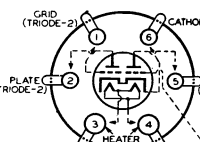

FIG. 19

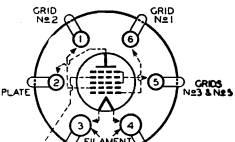

FIG. 26

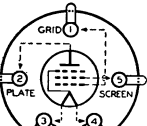

FIG. 6

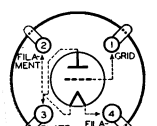

FIG. 12

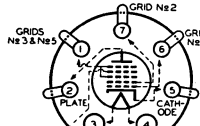

FIG. 20

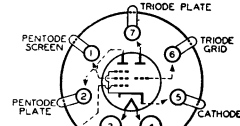

FIG. 27

Outline Dimensions of RCA Radiotron and Cunningham Radio Tube Types

This chart of tube dimensions is to be used in conjunction with the text. The bulb reference number for each tube is given under its CHARACTERISTICS.

The prefix letters of the bulb designation indicate the bulb shape; as S for "straight side," T for "tubular," ST for a combination of tubular and straight side, or "dome type." The suffix numbers of the bulb designations indicate the nominal maximum diameter of the bulb in eighths of inches, i.e., the diameter of the S-12 is 12 eighths, or $1\frac{1}{2}$ ".

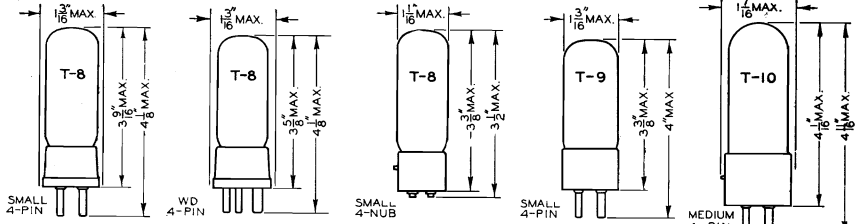

FIG. 1

FIG. 2

FIG. 3

FIG. 4

FIG. 5

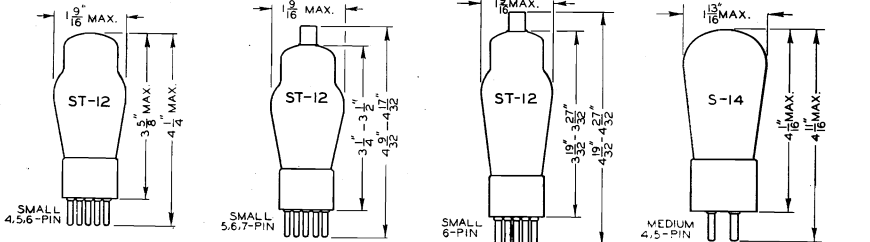

FIG. 6

FIG. 7

FIG. 8

FIG. 9

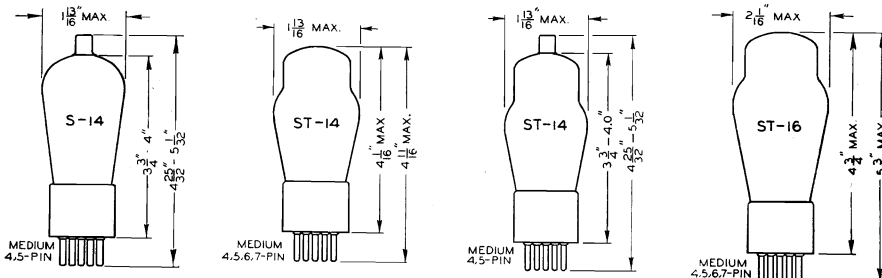

FIG. 10

FIG. 11

FIG. 12

FIG. 13

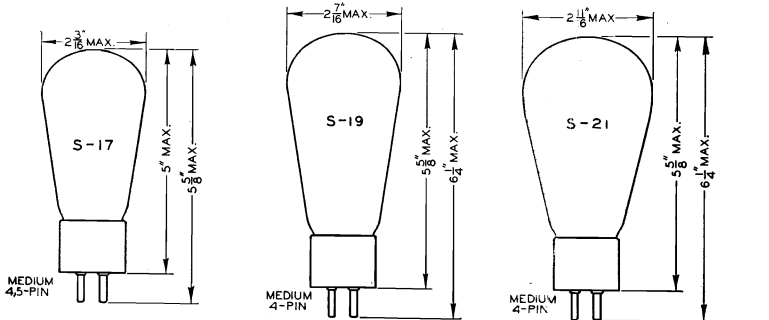

FIG. 14

FIG. 15

FIG. 16

INDEX

	Page		Page
Amplification Factor.....	7	D. A. V. C.....	19, 20
Amplifier:		Delayed Automatic Volume Control.....	19
audio-frequency.....	12	Demodulation.....	17
Class A.....	9, 12	Detection:	
Class B.....	9, 14	diode.....	17
Class C.....	9	grid-bias.....	18
radio-frequency.....	9	grid leak and condenser.....	18
resistance-coupled a-f conditions.....	142	Diode:	
parallel.....	12	biasing.....	18
push-pull.....	12	considerations.....	3
super-control.....	11	detection.....	17
voltage (Class A).....	10	load resistor.....	18
Anode.....	3	Driver Tube.....	14
Anode Grid.....	21	Duplex-Diode:	
Arc-Back.....	8	pentode.....	6
Audio-Frequency Component.....	17	triode.....	6, 18
Automatic Noise Suppression.....	19, 20	Electron:	
Automatic Volume Control.....	18, 20	considerations.....	1
A. V. C.....	18, 20	secondary.....	5
Bias:		Emission:	
battery.....	25	secondary.....	4
cathode.....	25	test.....	133
diode.....	18	Feed-Back.....	21
fixed.....	25	Filament: (see Heater and Cathode)	
self.....	25	operation.....	23
Bulb Dimensions Chart.....	151	resistor, power dissipation of.....	23
Calculation:		resistor, value of.....	23, 24
of amplification factor.....	7	series operation.....	24
" filament resistor power dissipation.....	23	supply voltage.....	23
" filament (or heater) resistor value.....	23, 24	Filter:	
" harmonic distortion, 2nd.....	13	choke-input.....	15
" heater-cathode resistor.....	24	condenser-input.....	15
" mutual conductance.....	8	radio-frequency.....	26
" plate resistance.....	7	rectifier circuits.....	16, 26
" power output (Class A).....	12	Formulas (see Calculation)	
" self-bias resistor.....	25	Frequency Conversion.....	21
" voltage amplification (gain).....	10	Gain.....	10
Carrier Wave.....	17	Grid:	
Cathode:		anode.....	21
coating.....	1	bias.....	4
connection.....	24	bias detection.....	18
current.....	25	circuit.....	4
directly heated.....	1	considerations.....	4
indirectly heated.....	1	condenser.....	18
resistor.....	25	current.....	14
Characteristics:		input impedance.....	11
amplification factor.....	7	leak and condenser detection.....	18
chart.....	144	resistor.....	11
conversion transconductance.....	8	voltage supply.....	25
dynamic.....	7	Grid-Plate Capacity.....	5
grid-plate transconductance.....	8	Grid-Plate Transconductance.....	8
mutual conductance.....	8	Harmonic Distortion:	
plate resistance.....	7	cancellation of 2nd.....	12, 14
static.....	7	determination of.....	13
Circuit Diagrams:		Heater:	
emission test.....	133	cathode.....	1
full-wave rectifier.....	16	cathode bias.....	24
mutual conductance test (dynamic).....	134	cathode connection.....	24
mutual conductance test (static).....	134	parallel operation.....	23
power amplifier (Class A).....	136, 139, 140	resistor power dissipation.....	23, 24
power amplifier (Class B).....	137	resistor value determination.....	23, 24
power output test.....	135	series operation.....	24
resistance-coupled a-f amplifier.....	99, 139	shunt resistor.....	24
short-circuit test.....	133	supply voltage.....	23
short-wave receiver.....	138	Interelectrode Capacity.....	5
superheterodyne receiver.....	91, 139, 140	Ionization.....	4
tuned r-f receiver.....	138, 141	Intermediate Frequency, production of.....	21
voltage doubler rectifier.....	16	Input Circuit.....	4
Condenser-Input Filter.....	15	Input Filter-Condenser.....	15
Conversion Transconductance.....	8	Input Filter-Choke.....	15
Cross-Modulation.....	11	Load:	
Current:		impedance.....	10
cathode.....	25	line.....	13
grid.....	14		
peak plate.....	8		
plate.....	3, 9		
Cut-off.....	4		

INDEX—(Continued)

	Page		Page
Mercury-Vapor Rectifier.....	3	types.....	30-132
Mho.....	8	1A6.....	30
Micromho.....	8	2A3.....	32
Mixer Tube.....	21	2A5.....	34
Modulation.....	17	2A6.....	36
Modulation Distortion.....	11	2A7.....	37
Mutual Conductance:		2B7.....	39
definition of.....	8	5Z3.....	42
dynamic test for.....	134	6A4.....	43
grid-shift test for.....	134	6A7.....	44
Noise Suppression Control-Tube.....	19	6B7.....	46
N. S. C.....	19	6F7.....	47
Oscillator.....	21	12Z3.....	49
Output:		25Z5.....	50
circuit.....	4	'00-A.....	143
coupling.....	27	01-A.....	52
plate load.....	10, 13	1-v.....	53
power.....	12, 134	10.....	54
Parallel Operation of Tubes.....	12	11.....	143
Peak Inverse Voltage.....	8	12.....	143
Peak Plate Current.....	8	112-A.....	56
Pentagrid Converter.....	6	19.....	57
Pentode Considerations.....	5	'20.....	59
Plate:		22.....	60
current.....	3	24-A.....	61
load.....	10, 13	26.....	63
resistance.....	7	27.....	65
voltage supply.....	24	30.....	66
Power Output:		31.....	67
Class A test for.....	135	32.....	68
Class B test for.....	135	33.....	70
calculation of.....	12	34.....	71
Push-Pull Operation of Tubes.....	12	35.....	73
Q Tube.....	19	36.....	75
Radio-Frequency:		37.....	77
amplifier.....	9, 11	38.....	78
filter.....	26	39/44.....	79
Rectifier:		'40.....	143
full-wave.....	3, 16	41.....	81
half-wave.....	3	42.....	83
voltage-doubler.....	16	43.....	84
Resistance Coupling.....	11	45.....	86
Resistor:		46.....	87
cathode.....	25	47.....	90
filament.....	23, 24	48.....	92
filter.....	27	49.....	94
grid.....	11	'50.....	96
plate load.....	10, 13	53.....	97
screen.....	26	55.....	100
self-biasing.....	24, 25	56.....	102
Saturation Current.....	3	57.....	104
Screen:		58.....	106
considerations.....	5	59.....	108
voltage supply.....	26	71-A.....	111
Self-Bias.....	25	75.....	112
Short-Circuit Test.....	133	77.....	114
Shielding.....	26	78.....	116
Socket Connections Chart.....	150	79.....	118
Space Charge.....	3	80.....	120
Squelch Tube.....	19	'81.....	122
Super-Control Tube.....	11	82.....	123
Suppressor.....	5	83.....	125
Symbols, Tube.....	150	84.....	126
Testing Radio Tubes.....	133	85.....	127
Tetrode Considerations.....	5	89.....	129
Transconductance:		'99.....	132
grid-plate.....	8	374.....	143
conversion.....	8	376.....	143
Triode Considerations.....	4	386.....	143
Tube:		864.....	148, 149
index by use and		866 (366).....	148, 149
by cathode voltage.....	148, 149	868.....	143
numbering system.....	143	874.....	143
symbols.....	150	876.....	143
testing.....	133	886.....	143
Voltage:		amplification.....	10
doubler rectifier.....	16	doubler rectifier.....	16
line, compensation of.....	24	line, compensation of.....	24
peak inverse.....	8	peak inverse.....	8
Volume Control:		automatic.....	18
automatic.....	18	by grid voltage variation.....	25
by grid voltage variation.....	25	by screen voltage variation.....	26
by screen voltage variation.....	26		

READING LIST

The following list of radio references gives texts of both elementary and advanced character. Obviously, the list is not inclusive, but it will guide the reader to other references.

CHAFFEE, E. L. *Theory of Thermionic Vacuum Tubes*. McGraw-Hill Book Co., Inc.

DUNCAN AND DREW. *Radio Telegraphy and Telephony*. John Wiley and Sons, Inc.

HENNEY, KEITH. *Principles of Radio*. McGraw-Hill Book Co., Inc.

HENNEY, KEITH. *Radio Engineering Handbook*. McGraw-Hill Book Co., Inc.

LAUER AND BROWN. *Radio Engineering Principles*. McGraw-Hill Book Co., Inc.

McILWAIN AND BRAINERD. *High-Frequency Alternating Currents*. John Wiley and Sons, Inc.

MORECROFT, J. H. *Elements of Radio Communication*. John Wiley and Son, Inc.

MORECROFT, J. H. *Principles of Radio Communication*. John Wiley and Son, Inc.

MOYER AND WOSTREL. *Radio Handbook*. McGraw-Hill Book Co., Inc.

MOYER AND WOSTREL. *Radio Receiving Tubes*. McGraw-Hill Book Co., Inc.

PETERS, LEO J. *Thermionic Vacuum Tube Circuits*. McGraw-Hill Book Co., Inc.

Proceedings of The Institute of Radio Engineers (a monthly publication).

TERMAN, FREDERICK E. *Radio Engineering*. McGraw-Hill Book Co., Inc.

The Radio Amateur's Handbook. American Radio Relay League.

VAN DER BIJL, H. J. *Thermionic Vacuum Tubes*. McGraw-Hill Book Co., Inc.

ZWORYKIN AND WILSON. *Photocells and Their Application*. John Wiley and Son, Inc.

To the Radio Amateur

The RCA Radiotron Co., Inc.
offers an extensive line of trans-
mitting tubes for amateur and
experimental use

Technical information on these
types may be obtained from

DeForest AMATEUR RADIO DIVISION
RCA RADIOTRON COMPANY, INC.
CAMDEN, NEW JERSEY

Radio amateurs are invited to
communicate with this division
which is devoted solely to
their interests

