



6146

6146

# VHF BEAM POWER AMPLIFIER

## GENERAL DATA

### Electrical:

Heater, for Unipotential Cathode:

Voltage . . . . . 6.3 ± 10% . . . . . ac or dc volts

Current . . . . . 1.25 . . . . . amp

Transconductance, for plate volts = 200, grid-No.2 volts = 200, and plate ma. = 100 . . . . .

7000 . . . . . μmhos

Mu-Factor, Grid No.2 to

Grid No.1 for plate volts = 200, grid-No.2 volts = 200, and plate ma. = 100 . . . . . 4.5

Direct interelectrode Capacitances:\*

Grid No.1 to Plate . . . . . 0.22 max. . . . . μmf

Input . . . . . 13.5 . . . . . μmf

Output . . . . . 8.5 . . . . . μmf

### Mechanical:

Mounting Position . . . . . Any

Overall Length . . . . . 3-11/16" ± 1/8"

Seated Length . . . . . 3-1/8" ± 1/8"

Maximum Diameter . . . . . 1-23/32"

Bulb . . . . . T-12

Cap. . . . . Small (JETEC No.C1-1)

Base . . . . . { Large-Wafer Octal 8-Pin Micanol with Sleeve No.R-6876 (JETEC No.88-86)

### BOTTOM VIEW

Pin 1 - Cathode,  
Grid No.3,  
Internal  
Shield

Pin 2 - Heater  
Pin 3 - Grid No.2

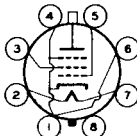

Pin 4 - Same as Pin 1  
Pin 5 - Grid No.1  
Pin 6 - Same as Pin 1  
Pin 7 - Heater  
Pin 8 - Base Sleeve  
Cap - Plate

Bulb Temperature (At hottest point) . . . . . 220 max. °C

### AF POWER AMPLIFIER & MODULATOR--Class AB<sub>1</sub>†

Triode Connection--Grid No.2 Connected to Plate

CCS\*

ICAS\*\*

### Maximum Ratings, Absolute Values:

DC PLATE VOLTAGE . . . . . 400 max. 400 max. volts

MAX.-SIGNAL DC

PLATE CURRENT\*\* . . . . . 90 max. 90 max. ma

MAX.-SIGNAL PLATE INPUT\*\* . . . . . 35 max. 35 max. watts

PLATE DISSIPATION\*\* . . . . . 20 max. 25 max. watts

\* with no external shielding and base sleeve connected to ground.

†, \*\*, \*\*: See next page.

6146



6146

## VHF BEAM POWER AMPLIFIER

	CCS <sup>•</sup>	ICAS <sup>••</sup>	
<b>PEAK HEATER-CATHODE VOLTAGE:</b>			
Heater negative with respect to cathode . . .	135 max.	135 max.	volts
Heater positive with respect to cathode . . .	135 max.	135 max.	volts

### Typical Operation:

*Values are for 2 tubes*

DC Plate Voltage . . . . .	250	400	400	volts
DC Grid-No.1 Voltage . . . . .	-50	-100	-100	volts
Peak AF Grid-No.1-to-Grid-No.1 Voltage <sup>o</sup> . . . . .	100	200	200	volts
Zero-Signal DC Plate Current . . . . .	110	80	80	ma
Max.-Signal DC Plate Current . . . . .	144	136	136	ma
Effective Load Resistance (Plate to plate) . . . . .	5000	8000	8000	ohms
Max.-Signal Driving Power (Approx.) . . . . .	0	0	0	watts
Total Harmonic Distortion . . . . .	5	4.6	4.6	%
Max.-Signal Power Output (Approx.) . . . . .	8	19	19	watts

### Maximum Circuit Values (CCS or ICAS Conditions):

<b>Grid-No.1-Circuit Resistance:<sup>oo</sup></b>			
With fixed bias . . . . .		0.1 max.	megohm
With cathode bias . . . . .		0.5 max.	megohm

### AF POWER AMPLIFIER & MODULATOR--Class AB<sub>1</sub><sup>†</sup>

#### Maximum Ratings, Absolute Values:

	CCS <sup>•</sup>	ICAS <sup>••</sup>	
DC PLATE VOLTAGE . . . . .	600 max.	750 max.	volts
DC GRID-No.2 (SCREEN) VOLTAGE . . . . .	250 max.	250 max.	volts
MAX.-SIGNAL DC PLATE CURRENT** . . . . .	125 max.	135 max.	ma
MAX.-SIGNAL PLATE INPUT** . . . . .	60 max.	85 max.	watts
MAX.-SIGNAL GRID-No.2 INPUT** . . . . .	3 max.	3 max.	watts
PLATE DISSIPATION** . . . . .	20 max.	25 max.	watts

† Subscript 1 indicates that grid-No.1 current does not flow during any part of the input cycle.

o The driver stage should be capable of supplying the No.1 grids of the class AB<sub>1</sub> stage with the specified driving voltage at low distortion.

•, ••, \*\*, oo: See next page.



6146

6146

## VHF BEAM POWER AMPLIFIER

	CCS <sup>•</sup>	ICAS <sup>••</sup>	
<b>PEAK HEATER-CATHODE VOLTAGE:</b>			
Heater negative with respect to cathode . . . .	135 max.	135 max.	volts
Heater positive with respect to cathode . . . .	135 max.	135 max.	volts
<b>Typical CCS Operation:</b>			
<i>Values are for 2 tubes</i>			
DC Plate Voltage . . . . .	400	500	600 volts
DC Grid-No.2 Voltage <sup>▲</sup> . . . . .	190	180	190 volts
DC Grid-No.1(Control-Grid)Voltage:			
<i>With fixed-bias source</i> . . . . .	-40	-40	-45 volts
Peak AF Grid-No.1-to-			
Grid-No.1 Voltage. . . . .	80	80	90 volts
Zero-Signal DC Plate Current . . .	86	70	60 ma
Max.-Signal DC Plate Current . . .	228	220	200 ma
Zero-Signal DC Grid-No.2 Current . .	2	1.4	1 ma
Max.-Signal DC Grid-No.2 Current . .	30	19.5	30.5 ma
Effective Load Resistance (Plate to plate) . . . . .	4000	5000	7500 ohms
Max.-Signal Driving Power (Approx.) . . . . .	0	0	0 watts
Total Harmonic Distortion. . . . .	8	8	8 %
Max.-Signal Power Output (Approx.) .	55	70	82 watts
<b>Typical ICAS Operation:</b>			
<i>Values are for 2 tubes</i>			
DC Plate Voltage . . . . .	600	750	volts
DC Grid-No.2 Voltage <sup>▲</sup> . . . . .	200	200	volts
DC Grid-No.1 (Control-Grid) Voltage:			
<i>From fixed-bias source</i> . . . . .	-50	-50	volts
Peak AF Grid-No.1-to-			
Grid-No.1 Voltage. . . . .	100	100	volts
Zero-Signal DC Plate Current . . . . .	52	57	ma
Max.-Signal DC Plate Current . . . . .	239	227	ma
Zero-Signal DC Grid-No.2 Current . . .	1.2	1	ma
Max.-Signal DC Grid-No.2 Current . . .	25.2	27.5	ma
Effective Load Resistance (Plate to plate) . . . . .	5500	8000	ohms
Max.-Signal Driving Power (Approx.) . .	0	0	watts
Total Harmonic Distortion. . . . .	7.5	5.7	%
Max.-Signal Power Output (Approx.) . .	94	120	watts
<b>Maximum Circuit Values (CCS or ICAS Conditions):</b>			
Grid-No.1-Circuit Resistance: <sup>••</sup>			
With fixed bias. . . . .		0.1 max.	megohm
With cathode bias. . . . .		Not recommended	

•, ••, •••, ••••, ▲: See next page.

MAY 1, 1952

TUBE DEPARTMENT

TENTATIVE DATA 2

RADIO CORPORATION OF AMERICA, HARRISON, NEW JERSEY



## VHF BEAM POWER AMPLIFIER

### AF POWER AMPLIFIER & MODULATOR--Class AB<sub>2</sub><sup>#</sup>

#### Maximum Ratings, Absolute Values:

	CCS <sup>•</sup>	ICAS <sup>••</sup>	
DC PLATE VOLTAGE . . . . .	600 max.	750 max.	volts
DC GRID-No.2 (SCREEN) VOLTAGE. . . . .	250 max.	250 max.	volts
MAX.-SIGNAL DC PLATE CURRENT** . . . . .	125 max.	135 max.	ma
MAX.-SIGNAL PLATE INPUT** . . . . .	62.5 max.	90 max.	watts
MAX.-SIGNAL GRID-No.2 INPUT** . . . . .	3 max.	3 max.	watts
PLATE DISSIPATION** . . . . .	20 max.	25 max.	watts
PEAK HEATER-CATHODE VOLTAGE:			
Heater negative with respect to cathode. . . . .	135 max.	135 max.	volts
Heater positive with respect to cathode. . . . .	135 max.	135 max.	volts

#### Typical CCS Operation:

Values are for 2 tubes

DC Plate Voltage . . . . .	400	500	600	volts
DC Grid-No.2 Voltage <sup>▲</sup> . . . . .	175	175	165	volts
DC Grid-No.1 (Control-Grid) Voltage:				
From fixed-bias source . . . . .	-40	-40	-45	volts
Peak AF Grid-No.1-to-Grid-No.1 Voltage. . . . .	86	87	99	volts
Zero-Signal DC Plate Current . . . . .	63	64	31	ma
Max.-Signal DC Plate Current . . . . .	232	242	207	ma
Zero-Signal DC Grid-No.2 Current . . . . .	1.5	1.2	0.7	ma
Max.-Signal DC Grid-No.2 Current . . . . .	28	26	31	ma
Max.-Signal DC Grid-No.1 Current . . . . .	0.3	0.3	0.5	ma
Effective Load Resistance (Plate to plate). . . . .	4000	5000	7500	ohms
Max.-Signal Driving Power (Approx.) <sup>◆</sup> . . . . .	0.01	0.01	0.02	watt
Total Harmonic Distortion. . . . .	9.7	9.7	9.7	%
Max.-Signal Power Output (Approx.). . . . .	60	81	90	watts

<sup>••</sup> Averaged over any audio-frequency cycle of sine-wave form.

<sup>••</sup> The type of input-coupling network used should not introduce too much resistance in the grid-No.1 circuit. Transformer or impedance coupling devices are recommended. When grid No.1 is operated in the negative region with fixed bias, the dc grid-No.1-circuit resistance should not exceed the specified value of 0.1 megohm. For higher values of dc grid-No.1-circuit resistance, cathode bias is required. Under no circumstances should the total dc grid-No.1-circuit resistance exceed the specified value of 0.5 megohm.

<sup>#</sup> Subscript 2 indicates that grid-No.1 current flows during some part of the input cycle.

•, ••, ▲, ◆: See next page.



6146

6146

# VHF BEAM POWER AMPLIFIER

## Typical ICAS Operation:

Values are for 2 tubes

DC Plate Voltage . . . . .	600	750	volts
DC Grid-No.2 Voltage <sup>▲</sup> . . . . .	185	165	volts
DC Grid-No.1 (Control-Grid) Voltage:			
From fixed-bias source . . . . .	-50	-45	volts
Peak AF Grid-No.1-to-			
Grid-No.1 Voltage. . . . .	113	101	volts
Zero-Signal DC Plate Current . . . . .	41	35	ma
Max.-Signal DC Plate Current . . . . .	270	240	ma
Zero-Signal DC Grid-No.2 Current . . . . .	0.9	0.6	ma
Max.-Signal DC Grid-No.2 Current . . . . .	29	21	ma
Max.-Signal DC Grid-No.1 Current . . . . .	0.8	0.7	ma
Effective Load Resistance			
(Plate to plate). . . . .	5500	8000	ohms
Max.-Signal Driving Power (Approx.) <sup>◆</sup> . . . . .	0.04	0.03	watt
Total Harmonic Distortion. . . . .	11	10	%
Max.-Signal Power Output (Approx.) . . . . .	115	130	watts

## Maximum Circuit Values (CCS or ICAS Conditions):

Grid-No.1-Circuit Resistance: <sup>◆</sup>			
With fixed bias. . . . .	30000	max.	ohms
With cathode bias. . . . .			Not recommended

## PLATE-MODULATED RF POWER AMPLIFIER--Class C Telephony

Carrier conditions per tube for use with a max. modulation factor of 1.0

CCS <sup>•</sup>	ICAS <sup>••</sup>
------------------	--------------------

## Maximum Ratings, Absolute Values:

DC PLATE VOLTAGE . . . . .	480 max.	600 max.	volts
DC GRID-No.2 (SCREEN)			
VOLTAGE. . . . .	250 max.	250 max.	volts
DC GRID-No.1 (CONTROL-			
GRID) VOLTAGE. . . . .	-150 max.	-150 max.	volts
DC PLATE CURRENT . . . . .	117 max.	125 max.	ma
DC GRID-No.1 CURRENT . . . . .	3.5 max.	4.0 max.	ma
PLATE INPUT. . . . .	45 max.	67.5 max.	watts
GRID-No.2 INPUT. . . . .	2 max.	2 max.	watts
PLATE DISSIPATION. . . . .	13.3 max.	16.7 max.	watts

▲ Preferably obtained from a separate source or from the plate-voltage supply with a voltage divider.

◆ Driver stage should be capable of supplying the specified driving power at low distortion to the No.1 grids of the AB<sub>2</sub> stage. To minimize distortion, the effective resistance per grid-No.1 circuit of the AB<sub>2</sub> stage should be held at a low value. For this purpose, the use of transformer coupling is recommended. In no case, however, should the total dc grid-No.1-circuit resistance exceed 30000 ohms when the 6146 is operated at maximum ratings. For operation at less than maximum ratings, the dc grid-No.1-circuit resistance may be as high as 100000 ohms.

•••: See next page.

6146



6146

## VHF BEAM POWER AMPLIFIER

CCS\*

ICAS\*\*

### PEAK HEATER-CATHODE

#### VOLTAGE:

Heater negative with respect to cathode . . . . .	135 max.	135 max.	volts
Heater positive with respect to cathode . . . . .	135 max.	135 max.	volts

### Typical Operation:

DC Plate Voltage . . . . .	400	475	600	volts
DC Grid-No.2 Voltage <sup>‡</sup> . . . . .	150	135	150	volts
<i>From a series resistor of . . . . .</i>				
DC Grid-No.1 Voltage <sup>‡</sup> . . . . .	21500	26500	37500	ohms
<i>From a grid resistor of . . . . .</i>				
Peak RF Grid-No.1 Voltage . . . . .	100	99	100	volts
DC Plate Current . . . . .	112	94	113	ma
DC Grid-No.2 Current . . . . .	11.6	12.8	12	ma
DC Grid-No.1 Current (Approx.) . . . . .	3	3	3	ma
Driving Power (Approx.) . . . . .	0.3	0.3	0.3	watt
Power Output (Approx.) . . . . .	34	33	52	watts

### Maximum Circuit Values (CCS or ICAS Conditions):

Grid-No.1-Circuit Resistance <sup>‡</sup> . . . . .	30000 max.	ohms
---	------------	------

### RF POWER AMPLIFIER & OSCILLATOR--Class C Telegraphy<sup>□</sup> and RF POWER AMPLIFIER--Class C FM Telephony

CCS\*

ICAS\*\*

### Maximum Ratings, Absolute Values:

DC PLATE VOLTAGE . . . . .	600 max.	750 max.	volts
DC GRID-No.2 (SCREEN) VOLTAGE . . . . .	250 max.	250 max.	volts
DC GRID-No.1 (CONTROL-GRID) VOLTAGE . . . . .	-150 max.	-150 max.	volts
DC PLATE CURRENT . . . . .	140 max.	150 max.	ma
DC GRID-No.1 CURRENT . . . . .	3.5 max.	4.0 max.	ma
PLATE INPUT . . . . .	67.5 max.	90 max.	watts
GRID-No.2 INPUT . . . . .	3 max.	3 max.	watts
PLATE DISSIPATION . . . . .	20 max.	25 max.	watts

<sup>‡</sup> Obtained preferably from a separate source modulated with the plate supply, or from the modulated plate supply through a series resistor.

\* Obtained from grid-No.1 resistor or from a combination of grid-No.1 resistor with either fixed supply or cathode resistor.

□ Key-down conditions per tube without amplitude modulation. Amplitude modulation essentially negative may be used if the positive peak of the audio-frequency envelope does not exceed 115% of the carrier conditions.

\*, \*\*, ‡: See next page.

MAY 1, 1952

TUBE DEPARTMENT

TENTATIVE DATA 3

RADIO CORPORATION OF AMERICA, HARRISON, NEW JERSEY



6146

6146

## VHF BEAM POWER AMPLIFIER

	CCS*		ICAS**		
PEAK HEATER-CATHODE VOLTAGE:					
Heater negative with respect to cathode . . . . .	135 max.		135 max.		volts
Heater positive with respect to cathode . . . . .	135 max.		135 max.		volts
<b>Typical Operation as Amplifier up to 60 Mc:</b>					
DC Plate Voltage . . . . .	500	600	600	750	volts
DC Grid-No.2 Voltage** . . . . .	170	150	180	160	volts
<i>From a series resistor of . . . . .</i>					
	29200	40200	28000	40100	ohms
DC Grid-No.1 Voltage <sup>■</sup> . . . . .	-85	-85	-85	-85	volts
<i>From a grid-No.1 resistor of . . . . .</i>					
	28300	28300	28300	28300	ohms
<i>From a cathode resistor of . . . . .</i>					
	570	670	510	620	ohms
Peak RF Grid-No.1 Voltage . . . . .	99	100	102	100	volts
DC Plate Current . . . . .	135	113	150	120	ma
DC Grid-No.2 Current . . . . .	11.3	11.2	15	14.7	ma
DC Grid-No.1 Current (Approx.) . . . . .	3	3	3	3	ma
Driving Power (Approx.) . . . . .	0.3	0.3	0.3	0.3	watt
Power Output (Approx.) . . . . .	50	52	69	69	watts

**Typical Operation as Amplifier at 175 Mc:**

DC Plate Voltage . . . . .	320		400		volts
DC Grid-No.2 Voltage** . . . . .	180		200		volts
<i>From a series resistor of . . . . .</i>					
	15500		22200		ohms
DC Grid-No.1 Voltage <sup>■</sup> . . . . .	-54		-54		volts
<i>From a grid resistor of . . . . .</i>					
	30000		30000		ohms
<i>From a cathode resistor of . . . . .</i>					
	360		335		ohms
Peak RF Grid-No.1 Voltage . . . . .	70		70		volts
DC Plate Current . . . . .	140		150		ma
DC Grid-No.2 Current . . . . .	9		9		ma
DC Grid-No.1 Current (Approx.) . . . . .	1.8		1.8		ma
Driving Power (Approx.) . . . . .	2		3		watts
Power Output (Approx.) . . . . .	25		35		watts

\* Continuous Commercial Service.

\*\* Intermittent Commercial and Amateur Service.

\*\* Obtained preferably from a separate source, or from the plate-supply voltage with a voltage divider, or through a series resistor. A series grid-No.2 resistor should be used only when the 6146 is used in a circuit which is not keyed. Grid-No.2 voltage must not exceed 400 volts under key-up conditions.

■ Obtained from fixed supply, by grid-No.1 resistor, by cathode resistor, or by combination methods.

†: See next page.

MAY 1, 1952

TUBE DEPARTMENT

TENTATIVE DATA 4

RADIO CORPORATION OF AMERICA, HARRISON, NEW JERSEY

6146

  
6146

## VHF BEAM POWER AMPLIFIER

### Maximum Circuit Values (CCS or ICAS Conditions):

Grid-No.1-Circuit Resistance<sup>†</sup> . . . . . 30000 max. ohms

### CHARACTERISTICS RANGE VALUES FOR EQUIPMENT DESIGN

(Preliminary)

	Note	Min.	Max.	
Heater Current . . . . .	1	1.175	1.325	amp
Grid-No.1-to-Plate Capacitance. . . . .	2	-	0.22	$\mu$ f
Input Capacitance. . . . .	2	11.1	15.9	$\mu$ f
Output Capacitance . . . . .	2	6.4	10.6	$\mu$ f
Plate Current. . . . .	3	45	83	ma
Grid-No.2 Current. . . . .	3	-	5	ma
Useful Power Output. . . . .	4	47.5	-	watts

Note 1: With 6.3 volts ac on heater.

Note 2: With no external shield. Base sleeve (pin No.8) is grounded.

Note 3: With 5.5 volts ac on heater, dc plate voltage of 300 volts, dc grid-No.2 voltage of 180 volts, grid-No.1 resistor of  $0.030 \pm 10\%$  megohm, max. dc plate current of 100 ma. to 112 ma., dc grid-No.1 current of 2 to 2.5 ma., and frequency of 15 Mc.

Note 4: In a single-tube self-excited oscillator circuit, and with 5.5 volts ac on heater, dc plate voltage of 600 volts, dc grid-No.2 voltage of 180 volts, grid-No.1 resistor of  $0.030 \pm 10\%$  megohm, max. dc plate current of 100 ma. to 112 ma., dc grid-No.1 current of 2 to 2.5 ma., and frequency of 15 Mc.

<sup>†</sup> When grid No.1 is driven positive and the 6146 is operated at maximum ratings, the total dc grid-No.1-circuit resistance should not exceed the specified value of 30000 ohms. If this value is insufficient to provide adequate bias, the additional required bias must be supplied by a cathode resistor or fixed supply. For operation at less than maximum ratings, the dc grid-No.1-circuit resistance may be as high as 100000 ohms.

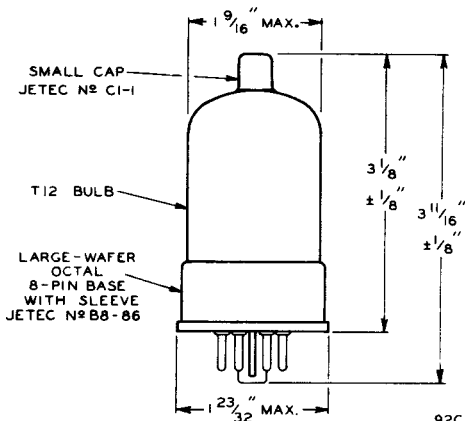

92CS-7700RI

MAY 1, 1952

TUBE DEPARTMENT

TENTATIVE DATA 4

RADIO CORPORATION OF AMERICA, HARRISON, NEW JERSEY





6146

# AVERAGE PLATE CHARACTERISTICS WITH $E_{c1}$ AS VARIABLE

6146

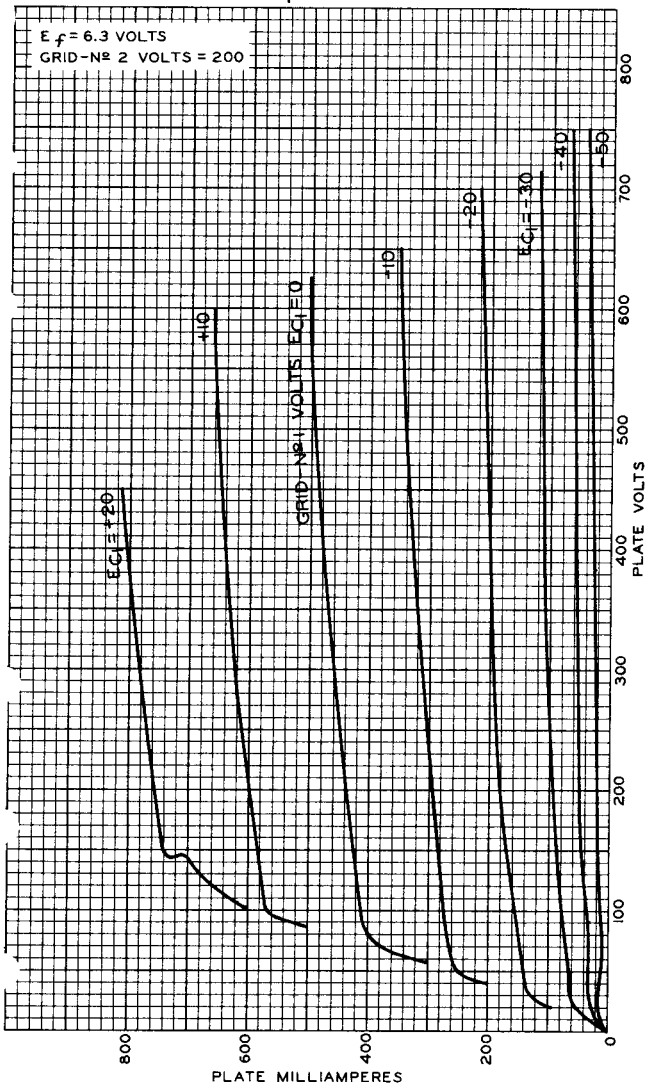

6146



6146

## AVERAGE CHARACTERISTICS

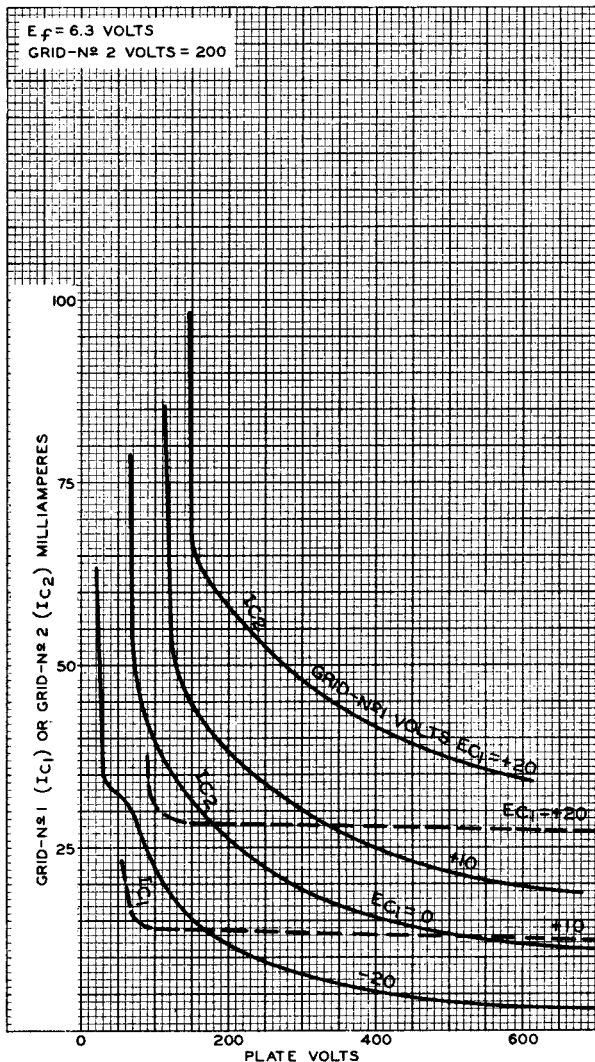



6146

6146

# MAXIMUM RATINGS VS OPERATING FREQUENCY CLASS C TELEGRAPHY

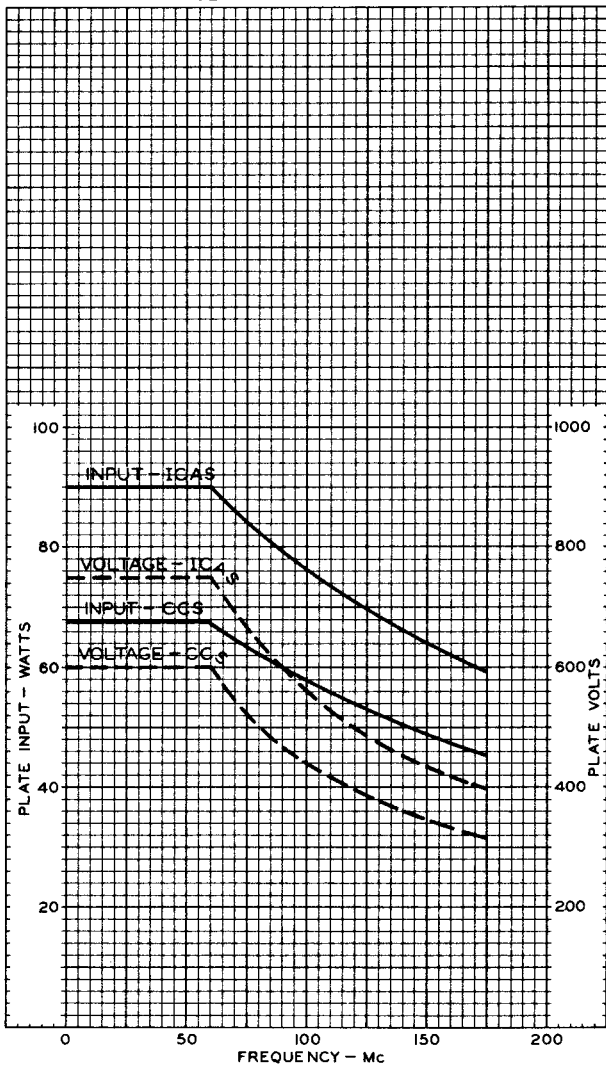

6/46



6146

# MAXIMUM RATINGS vs OPERATING FREQUENCY CLASS C TELEPHONY

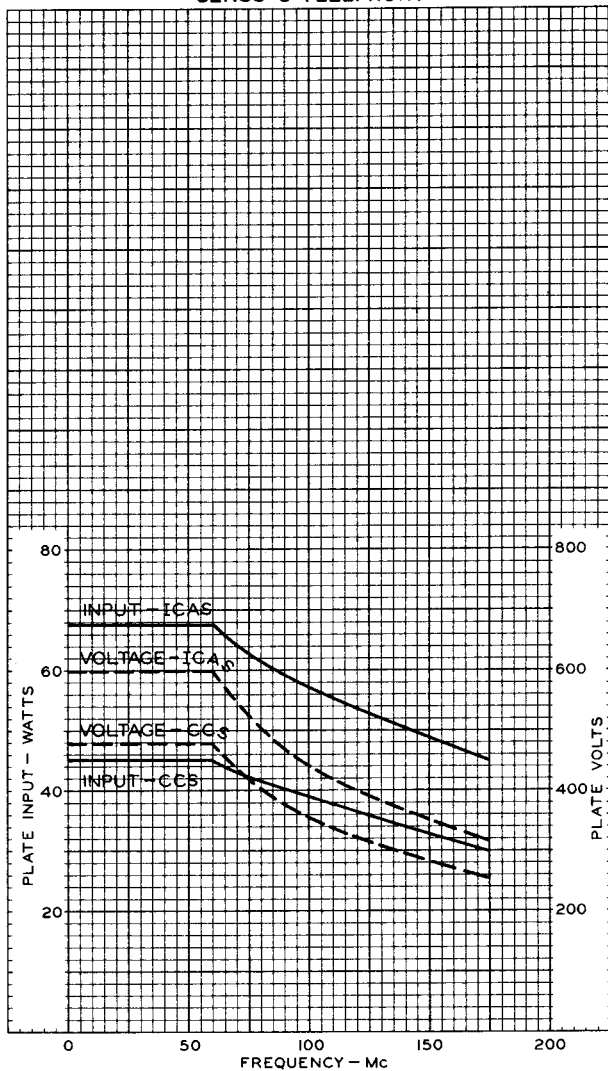

NOV. 27, 1951

TUBE DEPARTMENT  
RADIO CORPORATION OF AMERICA, HARRISON, NEW JERSEY

92CM-7712



6146

6146

### AVERAGE CHARACTERISTICS TRIODE CONNECTION

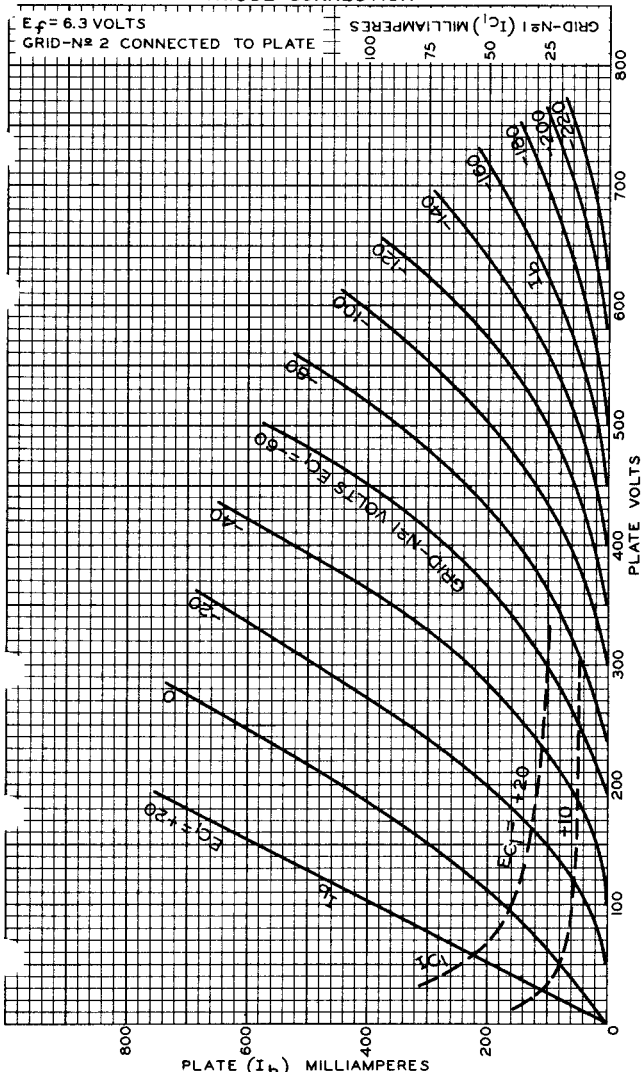

NOV. 27, 1951

PLATE ( $I_b$ ) MILLIAMPERES  
TUBE DEPARTMENT

RADIO CORPORATION OF AMERICA, HARRISON, NEW JERSEY

92CM-7711

## Beam Power Tube

HIGH POWER SENSITIVITY  
 90 WATTS CW INPUT (ICAS) UP TO 60 Mc  
 60 WATTS CW INPUT (ICAS) AT 175 Mc

## GENERAL DATA

## Electrical:

Heater, for Unipotential Cathode:		
Voltage (AC or DC) . . . . .	6.3 ± 10%	volts
Current at heater volts = 6.3 . . . . .	1.25	amp
Transconductance, for plate volts = 200, grid-No.2 volts = 200, and plate ma. = 100 . . . . .		
	7000	μmhos
Mu-Factor, Grid No.2 to Grid No.1 for plate volts = 200, grid-No.2 volts = 200, and plate ma. = 100. . . . .		
	4.5	
Direct Interelectrode Capacitances: <sup>a</sup>		
Grid No.1 to plate. . . . .	0.24 max.	pf ←
Grid No.1 to cathode & grid No.3 & internal shield, grid No.2, base sleeve, and heater . . . . .	13.0	pf
Plate to cathode & grid No.3 & internal shield, grid No.2, base sleeve, and heater . . . . .	8.5	pf ←

## Mechanical:

Operating Position. . . . .	Any
Maximum Overall Length. . . . .	3-13/16"
Seated Length . . . . .	3-1/8" ± 1/8"
Maximum Diameter. . . . .	1-23/32"
Weight (Approx.). . . . .	2.3 oz
Bulb. . . . .	T12
Cap . . . . .	Small (JEDEC No.C1-1)

## Bases (Alternates):

Large-Wafer Octal with Sleeve:

8-Pin (JEDEC Group 1, No.B8-86)

Large-Wafer with External Barriers and Sleeve:

8-Pin (JEDEC Group 1, No.B8-98)

Basing Designation for BOTTOM VIEW. . . . . 7CK

Pin 1 - Cathode,  
 Grid No.3,  
 Internal  
 Shield  
 Pin 2 - Heater  
 Pin 3 - Grid No.2  
 Pin 4 - Same as  
 Pin 1

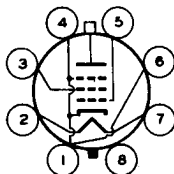

Pin 5 - Grid No.1  
 Pin 6 - Same as  
 Pin 1  
 Pin 7 - Heater  
 Pin 8 - Base Sleeve  
 Cap - Plate

← Indicates a change.



AF POWER AMPLIFIER & MODULATOR — Class AB<sub>1</sub><sup>b</sup>

## Maximum Ratings, Absolute-Maximum Values:

	CCS <sup>c</sup>	ICAS <sup>d</sup>	
DC PLATE VOLTAGE. . . . .	600 max.	750 max.	volts
DC GRID-NO.2 VOLTAGE. . . . .	250 max.	250 max.	volts
MAX.-SIGNAL DC PLATE CURRENT <sup>e</sup> . . . . .	125 max.	135 max.	ma
MAX.-SIGNAL PLATE INPUT <sup>e</sup> . . . . .	60 max.	85 max.	watts
MAX.-SIGNAL GRID-NO.2 INPUT <sup>e</sup> . . . . .	3 max.	3 max.	watts
PLATE DISSIPATION <sup>e</sup> . . . . .	20 max.	25 max.	watts
PEAK HEATER-CATHODE VOLTAGE:			
Heater negative with			
respect to cathode. . . . .	135 max.	135 max.	volts
Heater positive with			
respect to cathode. . . . .	135 max.	135 max.	volts
BULB TEMPERATURE (At hottest point on bulb surface). . . . .	220 max.	220 max.	°C

## Typical CCS Push-Pull Operation:

Values are for 2 tubes

DC Plate Voltage. . . . .	400	500	600	volts
DC Grid-No.2 Voltage <sup>f</sup> . . . . .	190	185	180	volts
DC Grid-No.1 Voltage:				
From fixed-bias source. . . . .	-40	-40	-45	volts
Peak AF Grid-No.1-to-Grid-No.1				
Voltage <sup>g</sup> . . . . .	80	80	90	volts
Zero-Signal DC Plate Current. . . . .	63	57	26	ma
Max.-Signal DC Plate Current. . . . .	228	215	200	ma
Zero-Signal DC Grid-No.2				
Current . . . . .	2.5	2	1	ma
Max.-Signal DC Grid-No.2				
Current . . . . .	25	25	23	ma
Effective Load Resistance				
(Plate to plate). . . . .	4000	5500	7000	ohms
Max.-Signal Driving				
Power (Approx.) . . . . .	0	0	0	watts
Max.-Signal Power Output				
(Approx.) . . . . .	55	70	82	watts

## Typical ICAS Push-Pull Operation:

Values are for 2 tubes

DC Plate Voltage. . . . .	600	750	volts
DC Grid-No.2 Voltage <sup>f</sup> . . . . .	200	195	volts
DC Grid-No.1 Voltage:			
From fixed-bias source. . . . .	-50	-50	volts
Peak AF Grid-No.1-to-Grid-No.1 Voltage <sup>g</sup> . . . . .			
. . . . .	100	100	volts
Zero-Signal DC Plate Current. . . . .	28	23	ma
Max.-Signal DC Plate Current. . . . .	229	220	ma
Zero-Signal DC Grid-No.2 Current. . . . .	1	1	ma
Max.-Signal DC Grid-No.2 Current. . . . .	27	26	ma
Effective Load Resistance			
(Plate to plate). . . . .	6000	8000	ohms
Max.-Signal Driving Power (Approx.) . . . . .			
. . . . .	0	0	watts
Max.-Signal Power Output (Approx.) . . . . .			
. . . . .	95	120	watts



**Maximum Circuit Values (CCS or ICAS):**Grid-No.1-Circuit Resistance under any condition:<sup>h</sup>

With fixed bias . . . . .	0.1 max.	megohm
With cathode bias . . . . .	Not recommended	

**AF POWER AMPLIFIER & MODULATOR — Class AB<sub>1</sub><sup>b</sup>***Triode Connection—Grid No.2 Connected to Plate*

	CCS	ICAS	
<b>Maximum Ratings, Absolute-Maximum Values:</b>			
DC PLATE VOLTAGE. . . . .	400 max.	400 max.	volts
MAX.—SIGNAL DC PLATE CURRENT <sup>e</sup> . . . . .	90 max.	90 max.	ma
MAX.—SIGNAL PLATE INPUT <sup>e</sup> . . . . .	35 max.	35 max.	watts
PLATE DISSIPATION <sup>e</sup> . . . . .	20 max.	25 max.	watts
PEAK HEATER-CATHODE VOLTAGE:			
Heater negative with respect to cathode. . . . .	135 max.	135 max.	volts
Heater positive with respect to cathode. . . . .	135 max.	135 max.	volts
BULB TEMPERATURE (At hottest point on bulb surface). . . . .	220 max.	220 max.	°C

**Typical Push-Pull Operation:***Values are for 2 tubes*

DC Plate Voltage. . . . .	250	400	400	volts
DC Grid-No.1 Voltage. . . . .	-50	-100	-100	volts
Peak AF Grid-No.1-to-Grid-No.1 Voltage <sup>g</sup> . . . . .	100	200	200	volts
Zero-Signal DC Plate Current. . . . .	120	40	40	ma
Max.—Signal DC Plate Current. . . . .	125	100	100	ma
Effective Load Resistance (Plate-to-plate). . . . .	5000	8000	8000	ohms
Max.—Signal Driving Power (Approx.) . . . . .	0	0	0	watts
Max.—Signal Power Output (Approx.) . . . . .	10	22	22	watts

**Maximum Circuit Values (CCS or ICAS):**Grid-No.1-Circuit Resistance under any condition:<sup>h</sup>

With fixed bias . . . . .	0.1 max.	megohm
With cathode bias . . . . .	0.5 max.	megohm

**AF POWER AMPLIFIER & MODULATOR — Class AB<sub>2</sub><sup>j</sup>****Maximum Ratings, Absolute-Maximum Values:**

	CCS	ICAS	
DC PLATE VOLTAGE. . . . .	600 max.	750 max.	volts
DC GRID-No.2 VOLTAGE. . . . .	250 max.	250 max.	volts
MAX.—SIGNAL DC PLATE CURRENT <sup>e</sup> . . . . .	125 max.	135 max.	ma
MAX.—SIGNAL PLATE INPUT <sup>e</sup> . . . . .	62.5 max.	90 max.	watts
MAX.—SIGNAL GRID-No.2 INPUT <sup>e</sup> . . . . .	3 max.	3 max.	watts
PLATE DISSIPATION <sup>e</sup> . . . . .	20 max.	25 max.	watts





	CCS	ICAS		
<b>PEAK HEATER-CATHODE VOLTAGE:</b>				
Heater negative with respect to cathode. . . . .	135 max.	135 max.		volts
Heater positive with respect to cathode. . . . .	135 max.	135 max.		volts
<b>BULB TEMPERATURE (At hottest point on bulb surface). . . . .</b>	220 max.	220 max.		°C

**Typical CCS Push-Pull Operation:***Values are for 2 tubes*

DC Plate Voltage. . . . .	400	500	600	volts
DC Grid-No.2 Voltage <sup>f</sup> . . . . .	175	175	165	volts
DC Grid-No.1 Voltage:				
→ From fixed-bias source. . . . .	-41	-44	-44	volts
Peak AF Grid-No.1-to-Grid-No.1 Voltage . . . . .	95	102	97	volts
Zero-Signal DC Plate Current. . . . .	33	27	22	ma
Max.-Signal DC Plate Current. . . . .	232	242	207	ma
Zero-Signal DC Grid-No.2 Current . . . . .	1.1	0.7	0.6	ma
Max.-Signal DC Grid-No.2 Current . . . . .	18	18	17	ma
Max.-Signal DC Grid-No.1 Current . . . . .	1.6	1.9	1.1	ma
Effective Load Resistance (Plate to plate). . . . .	3700	4600	6800	ohms
Max.-Signal Driving Power (Approx.) <sup>k</sup> . . . . .	0.2	0.3	0.2	watt
Max.-Signal Power Output (Approx.) . . . . .	62	83	90	watts

**Typical ICAS Push-Pull Operation:***Values are for 2 tubes*

DC Plate Voltage. . . . .		600	750	volts
DC Grid-No.2 Voltage <sup>f</sup> . . . . .		190	165	volts
DC Grid-No.1 Voltage:				
From fixed-bias source. . . . .		-48	-46	volts
Peak AF Grid-No.1-to-Grid-No.1 Voltage. . . . .		109	108	volts
Zero-Signal DC Plate Current. . . . .		28	22	ma
Max.-Signal DC Plate Current. . . . .		270	240	ma
Zero-Signal DC Grid-No.2 Current. . . . .		1.2	0.3	ma
Max.-Signal DC Grid-No.2 Current. . . . .		20	20	ma
Max.-Signal DC Grid-No.1 Current. . . . .		2	2.6	ma
Effective Load Resistance (Plate to plate). . . . .		5000	7400	ohms
→ Max.-Signal Driving Power (Approx.) <sup>k</sup> . . . . .		0.3	0.4	watt
Max.-Signal Power Output (Approx.) . . . . .		113	131	watts

**Maximum Circuit Values (CCS or ICAS):**Grid-No.1-Circuit Resistance:<sup>m</sup>

With fixed bias . . . . .	30000 max.	ohms
With cathode bias . . . . .	Not recommended	

→ Indicates a change.



## PLATE-MODULATED RF POWER AMPLIFIER — Class C Telephony

Carrier conditions per tube for use with a maximum modulation factor of 1 and at frequencies up to 60 Mc

CCS ICAS

### Maximum Ratings, Absolute-Maximum Values:

For maximum plate voltage and maximum plate input above 60 Mc, see Rating Chart 1

DC PLATE VOLTAGE. . . . .	480 max.	600 max.	volts
DC GRID-No.2 VOLTAGE. . . . .	250 max.	250 max.	volts
DC GRID-No.1 VOLTAGE. . . . .	-150 max.	-150 max.	volts
DC PLATE CURRENT. . . . .	117 max.	125 max.	ma
DC GRID-No.1 CURRENT. . . . .	3.5 max.	4 max.	ma
PLATE INPUT . . . . .	45 max.	67.5 max.	watts
GRID-No.2 INPUT . . . . .	2 max.	2 max.	watts
PLATE DISSIPATION . . . . .	13.3 max.	16.7 max.	watts
PEAK HEATER-CATHODE VOLTAGE:			
Heater negative with respect to cathode. . . . .	135 max.	135 max.	volts
Heater positive with respect to cathode. . . . .	135 max.	135 max.	volts
BULB TEMPERATURE (At hottest point on bulb surface). . . . .	220 max.	220 max.	°C

### Typical Operation:

DC Plate Voltage. . . . .	400	475	600	volts
DC Grid-No.2 Voltage: <sup>n</sup>				
From a grid-No.2 series resistor of:				
33000 ohms. . . . .	150	-	-	volts
51000 ohms. . . . .	-	135	-	volts
56000 ohms. . . . .	-	-	150	volts
DC Grid-No.1 Voltage: <sup>p</sup>				
From a grid-No.1 resistor of 27000 ohms . . . . .	-87	-77	-87	volts
Peak RF Grid-No.1 Voltage . . .	107	95	107	volts
DC Plate Current. . . . .	112	94	112	ma
DC Grid-No.2 Current. . . . .	7.8	6.4	7.8	ma
DC Grid-No.1 Current (Approx.).	3.4	2.8	3.4	ma
Driving Power (Approx.) . . . .	0.4	0.3	0.4	watt
Power Output (Approx.) . . . . .	32	34	52	watts

### Maximum Circuit Values (CCS or ICAS):

Grid-No.1-Circuit Resistance <sup>q</sup> . . . . .	30000 max.	ohms
---	------------	------



**RF POWER AMPLIFIER & OSCILLATOR — Class C Telegraphy<sup>r</sup>**  
**and**
**RF POWER AMPLIFIER — Class C FM Telephony**

CCS                      ICAS

**Maximum Ratings, Absolute-Maximum Values:**
*At frequencies up to 60 Mc. For maximum plate voltage and maximum plate input above 60 Mc, see Rating Chart II.*

DC PLATE VOLTAGE. . . . .	600 max.	750 max.	volts
DC GRID—No.2 VOLTAGE. . . . .	250 max.	250 max.	volts
DC GRID—No.1 VOLTAGE. . . . .	-150 max.	-150 max.	volts
DC PLATE CURRENT. . . . .	140 max.	150 max.	ma
DC GRID—No.1 CURRENT. . . . .	3.5 max.	4 max.	ma
PLATE INPUT . . . . .	67.5 max.	90 max.	watts
GRID—No.2 INPUT . . . . .	3 max.	3 max.	watts
PLATE DISSIPATION . . . . .	20 max.	25 max.	watts
<b>PEAK HEATER—CATHODE VOLTAGE:</b>			
Heater negative with respect to cathode. . . . .	135 max.	135 max.	volts
Heater positive with respect to cathode. . . . .	135 max.	135 max.	volts
BULB TEMPERATURE (At hottest point on bulb surface). . . . .	220 max.	220 max.	°C

**Typical Operation:**
*As amplifier up to 60 Mc*

DC Plate Voltage. . . . .	500	600	600	750	volts
DC Grid—No.2 Voltage: <sup>s</sup>					
From a grid—No.2 series resistor of:					
36000 ohms. . . . .	170	-	-	-	volts
51000 ohms. . . . .	-	150	-	-	volts
43000 ohms. . . . .	-	-	180	-	volts
56000 ohms. . . . .	-	-	-	160	volts
DC Grid—No.1 Voltage: <sup>t</sup>					
From a grid—No.1 resistor of:					
27000 ohms. . . . .	-66	-	-	-	volts
20000 ohms. . . . .	-	-58	-	-62	volts
24000 ohms. . . . .	-	-	-71	-	volts
From cathode resistor of:					
430 ohms. . . . .	-	-	-71	-	volts
470 ohms. . . . .	-66	-58	-	-62	volts
Peak RF Grid—No.1 Voltage . . . . .	84	73	91	79	volts
DC Plate Current. . . . .	135	112	150	120	ma
DC Grid—No.2 Current. . . . .	9	9	10	11	ma
DC Grid—No.1 Current (Approx.). . . . .	2.5	2.8	2.8	3.1	ma
Driving Power (Approx.) . . . . .	0.2	0.2	0.3	0.2	watt
Power Output (Approx.) . . . . .	48	52	66	70	watts

**Typical Operation:**
*As amplifier up to 175 Mc*

DC Plate Voltage. . . . .	320	400	volts
---------------------------	-----	-----	-------



DC Grid-No.2 Voltage:<sup>s</sup>

From grid-No.2 series resistor of:

13000 ohms. . . . .	180	-	volts
20000 ohms. . . . .	-	190	volts

DC Grid-No.1 Voltage:<sup>t</sup>

From a grid-No.1 resistor of:

27000 ohms. . . . .	-51	-	volts
24000 ohms. . . . .	-	-54	volts

From cathode resistor of

330 ohms. . . . .	-51	-54	volts
-------------------	-----	-----	-------

Peak RF Grid-No.1 Voltage . . . . . 64 68 volts

DC Plate Current. . . . . 140 150 ma

DC Grid-No.2 Current. . . . . 10 10.4 ma

DC Grid-No.1 Current (Approx.). . . . . 2 2.2 ma

Driving Power (Approx.). . . . . 3 3 watts

Power Output (Approx.). . . . . 25 35 watts

**Maximum Circuit Values (CCS or ICAS):**Grid-No.1 Circuit Resistance<sup>q</sup> . . . . . 30000 max. ohms<sup>a</sup> Without external shield.<sup>b</sup> Subscript 1 indicates that grid-No.1 current does not flow during any part of the input cycle.<sup>c</sup> Continuous Commercial Service.<sup>d</sup> Intermittent Commercial and Amateur Service.<sup>e</sup> Averaged over any audio-frequency cycle of sine-wave form.<sup>f</sup> Obtained preferably from a separate source or from the plate-voltage supply with a voltage divider.<sup>g</sup> The driver stage should be capable of supplying the No.1 grids of the class AB<sub>1</sub> stage with the specified driving voltage at low distortion.<sup>h</sup> The type of input coupling network used should not introduce too much resistance in the grid-No.1 circuit. Transformer or impedance coupling devices are recommended.<sup>j</sup> Subscript 2 indicates that grid-No.1 current flows during some part of the input cycle.<sup>k</sup> Driver stage should be capable of supplying the specified driving power at low distortion to the No.1 grids of the AB<sub>2</sub> stage.<sup>m</sup> To minimize distortion, the effective resistance per grid-No.1 circuit of the AB<sub>2</sub> stage should be held at a low value. For this purpose, the use of transformer coupling is recommended. In no case, however, should the total dc grid-No.1-circuit resistance exceed 30000 ohms when the 6146 is operated at maximum ratings. For operation at less than maximum ratings, the dc grid-No.1-circuit resistance may be as high as 100000 ohms.<sup>n</sup> Obtained preferably from a separate source modulated with the plate supply, or from the modulated plate supply through a series resistor.<sup>p</sup> Obtained from grid-No.1 resistor or from a combination of grid-No.1 resistor with either fixed supply or cathode resistor.<sup>q</sup> When grid No.1 is driven positive and the 6146 is operated at maximum ratings, the total dc grid-No.1-circuit resistance should not exceed the specified value of 30000 ohms. If this value is insufficient to provide adequate bias, the additional required bias must be supplied by a cathode resistor or fixed supply. For operation at less than maximum ratings, the dc grid-No.1-circuit resistance may be as high as 100000 ohms.<sup>r</sup> Key-down conditions per tube without amplitude modulation. Amplitude modulation essentially negative may be used if the positive peak of the audio-frequency envelope does not exceed 115 per cent of the carrier conditions.<sup>s</sup> Obtained preferably from separate source, or from the plate-supply voltage with a voltage divider, or through a series resistor. A series grid-No.2 resistor should be used only when the 6146 is used in a cir-

cult which is not keyed. Grid-No.2 voltage must not exceed 400 volts under key-up conditions.

<sup>t</sup> Obtained from fixed supply, by grid-No.1 resistor, by cathode resistor, or by combination methods.

### CHARACTERISTICS RANGE VALUES

	Note	Min.	Max.	
Heater Current . . . . .	1	1.175	1.325	amp
Direct Interelectrode Capacitances:				
Grid No.1 to plate . . . . .	2	-	0.24	pf
Grid-No.1 to cathode & grid No.3 & internal shield, base sleeve, grid No.2, and heater . . . . .	2	12.0	15.0	pf
Plate to cathode & grid No.3 & internal shield, base sleeve, grid No.2, and heater . . . . .	2	7.3	9.5	pf
Plate Current . . . . .	3	46	94	ma
Grid-No.2 Current . . . . .	3	-	5.5	ma
Dynamic Grid-No.2 Current . . . . .	4	3	21	ma
Useful Power Output . . . . .	4	47	-	watts

Note 1: With 6.3 volts ac on heater.

Note 2: Without external shield.

Note 3: With rated ac heater voltage, dc plate volts = 300, dc grid-No.2 volts = 200, and dc grid-No.1 volts = -33.

Note 4: In a single-tube, self-excited oscillator circuit, and with rated ac heater voltage, dc plate volts = 600, dc grid-No.2 volts = 180, grid-No.1 resistor (ohms) = 30000 ± 10%, dc plate ma. = 100 to 112, dc grid-No.1 ma. = 2 to 2.5, and frequency (Mc) = 15.

### MAXIMUM RATINGS vs OPERATING FREQUENCY

OPERATING FREQUENCY  Mc	MAXIMUM PERMISSIBLE PERCENTAGE OF MAXIMUM-RATED PLATE VOLTAGE & PLATE INPUT			
	TELEPHONY		TELEGRAPHY	
	Class C Plate-Modulated		Class C Unmodulated	
	Voltage	Input	Voltage	Input
60	100	100	100	100
80	84	92	84	92
125	65	78	65	78
150	58	72	58	72
160	56	70	56	70
175	53	67	53	67

→ Indicates a change.

## OPERATING CONSIDERATIONS

During standby periods in intermittent operation, it is recommended that the heater voltage be maintained at normal operating value when the period is less than 15 minutes, and that it be reduced to 80 percent of normal when the period is between 15 minutes and 2 hours. For longer periods, the heater voltage should be turned off.

The maximum-rated plate and grid-No. 2 voltages of this tube are extremely dangerous. Great care should be taken during the adjustment of circuits. The tube and its associated apparatus, especially all parts which may be at high potential above ground, should be housed in a protective enclosure. The protective housing should be designed with interlocks so that personnel can not possibly come in contact with any high-potential point in the electrical system. The interlock devices should function to break the primary circuit of the high-voltage supplies when any gate or door on the protective housing is opened, and should prevent the closing of the primary circuit until the door is again locked.

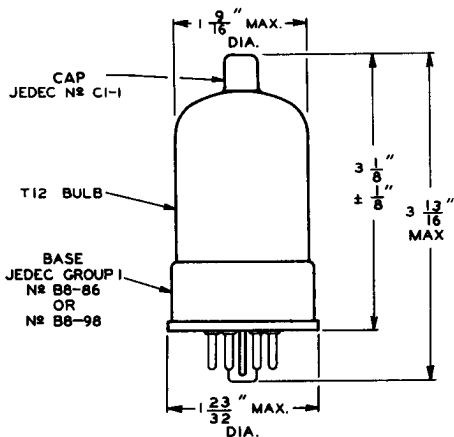

92CS-7700R4



# RATING CHART I

## Class C Telephony Service

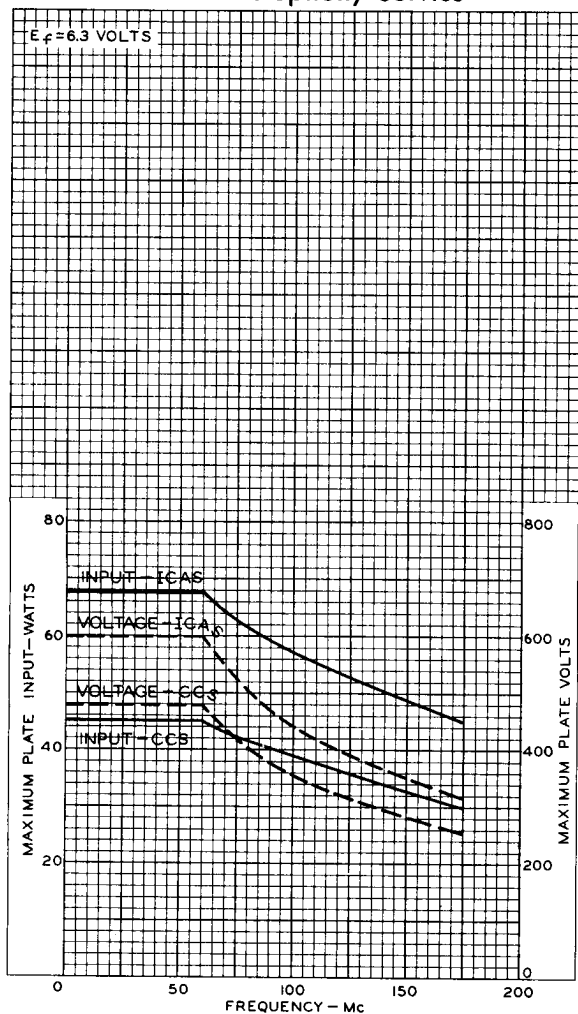

92CM-7712RI



## RATING CHART II

### Class C Telegraphy Service

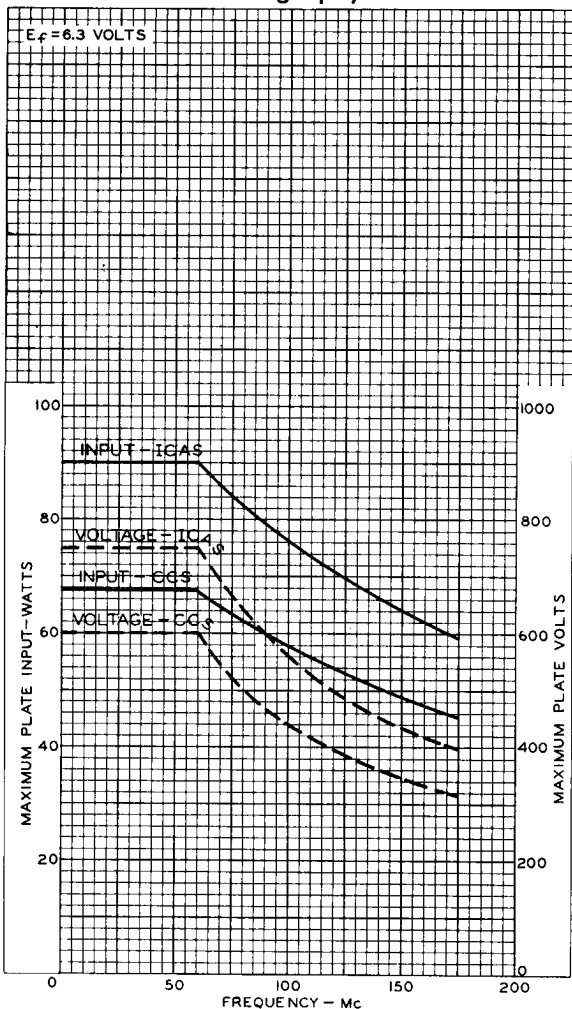

92CM-7709RI





## TYPICAL PLATE CHARACTERISTICS

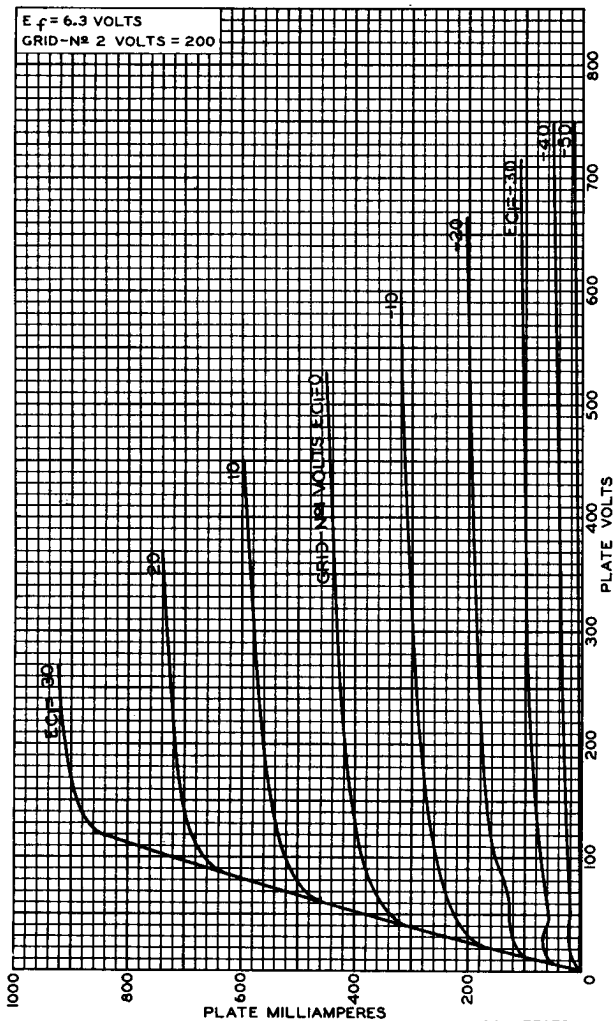

## TYPICAL CHARACTERISTICS

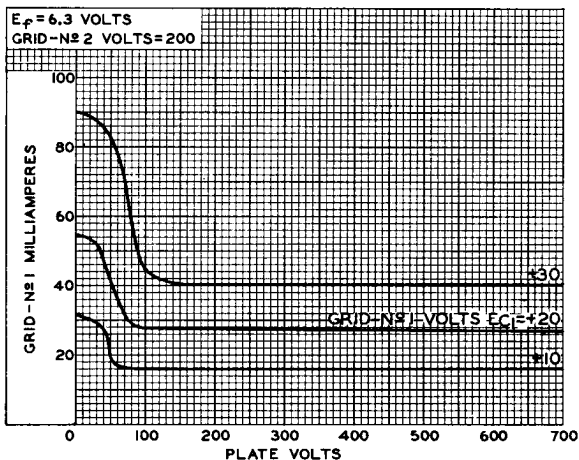

92CS-9617

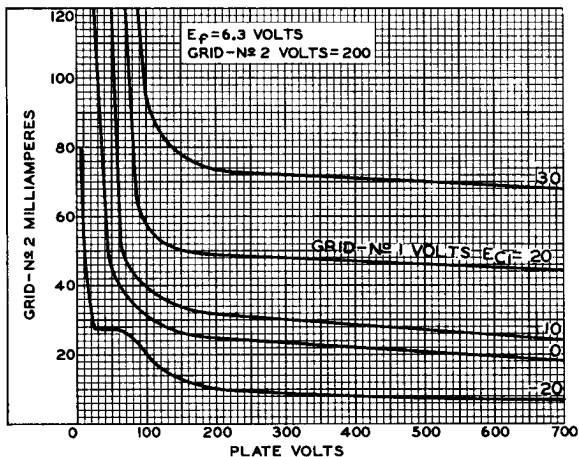

92CS-9618



## TYPICAL PLATE CHARACTERISTICS

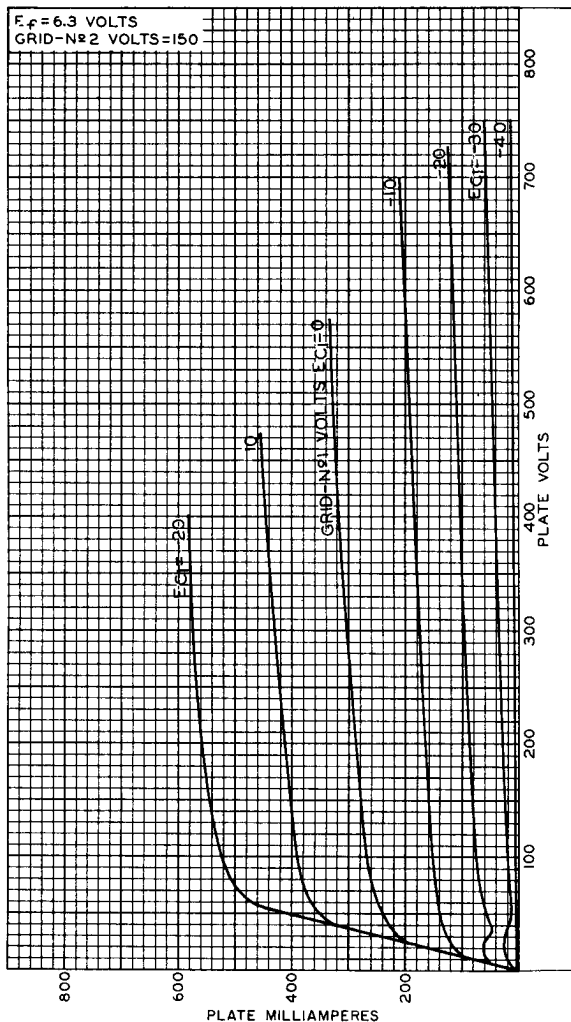

92CM-8145



## TYPICAL CHARACTERISTICS

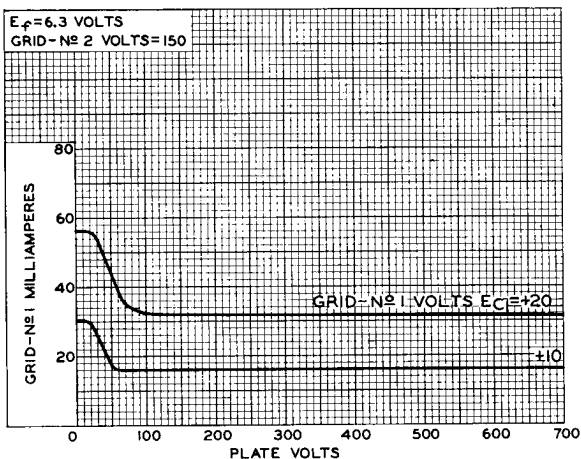

92CS-9619

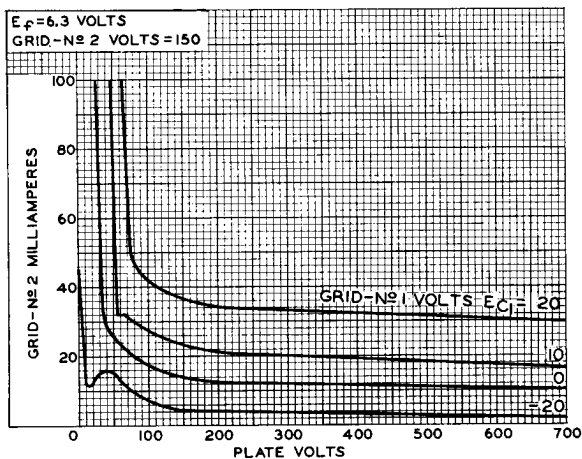

92CS-9620



# TYPICAL CHARACTERISTICS

## Triode Connection

