



# 7264

## MULTIPLIER PHOTOTUBE

1.68" Dia. Semitransparent Spherical Photocathode

14-Stage, Head-On Type, Spherical Faceplate S-11 Response Very-Short Time Resolution Capability

7.5" Max. Length 2.38" Max. Diameter Bidecal 20-Pin Base

TENTATIVE DATA

RCA-7264 is a head-on type of multiplier phototube intended for use in scintillation counters for the detection and measurement of nuclear radiation, and in applications involving the measurement of low-level light sources. Its fast response, high current gain, high peak-current capability, relative freedom from after-pulses, and extremely small spread in electron-transit time make it particularly useful for fast coincidence scintillation counting.

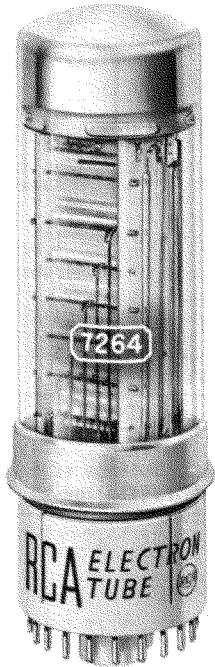

Design features of the 7264 include dynodes with stable high-current-carrying capability; focusing electrode with external connection for shaping the field which directs photoelectrons from the photocathode onto the first dynode; an accelerating electrode with external connection for minimizing

the space-charge effect in the region of dynode No.12; and a semitransparent photocathode on the inner surface of the spherical face end of the bulb.

The focusing electrode permits optimizing the magnitude, uniformity, or speed of the response in critical applications.

The spherical photocathode surface of the 7264 assures very good collection by dynode No.1 of electrons from all parts of the useful photocathode area, and thus makes possible a typical pulse-height resolution of about 8 per cent. The use of the spherical surface together with the electrode configuration employed in the 7264 results in extremely small variation in electron-transit time between the photocathode and dynode No.1.

The 7264 is capable of delivering pulse currents having magnitudes up to 0.5 ampere without appreciable deviation from linearity. Consequently, the need for an associated wide-band amplifier to amplify the output pulse is eliminated in many applications.

The spectral response of the 7264 covers the range from about 3000 to 6500 angstroms, as shown in Fig.1. Maximum response occurs at approximately 4400 angstroms. The 7264, therefore, has high sensitivity to blue-rich light and negligible sensitivity to red radiation.

The internal leads from dynode No.14 and anode to their respective base-pin terminals are short and direct. This arrangement makes possible the use of a load circuit having a short time constant--an essential feature in pulse service.

The 7264 is capable of multiplying feeble photoelectric current produced at the cathode by a median value of 12,500,000 times when operated with a supply voltage of 2000 volts. The output current of the 7264 is a linear function of the exciting illumination under normal operating conditions.

### DATA

#### General:

Spectral Response . . . . . S-11  
Wavelength of Maximum Response . . . 4400 ± 500 angstroms  
Cathode, Semitransparent:

Shape . . . . . Spherical  
Window:  
Area . . . . . 2.2 sq.in.  
Minimum diameter . . . . . 1.68 in.  
Index of refraction . . . . . 1.51

#### Direct Interelectrode Capacitances (Approx.):

Anode to dynode No.14 . . . . . 2.4 μμf  
Anode to all other electrodes . . . . . 5.5 μμf  
Dynode No.14 to all other electrodes . . . . . 7.5 μμf  
Maximum Overall Length . . . . . 7.5"  
Seated Length . . . . . 6.69" ± 0.19"  
Maximum Diameter . . . . . 2.38"  
Bulb . . . . . T-16  
Base . . . . Small-Shell Bidecal 20-Pin (JETEC No.B20-102)  
Socket . . Alden No.220FT with 20 Contacts, or equivalent



Operating Position . . . . . Any  
 Weight (Approx.) . . . . . 8 oz

**VERY-LOW-LIGHT-LEVEL, LOW-NOISE  
 HIGH-GAIN SERVICE**

*With Supply Voltage (E) Across Voltage Divider Providing Electrode Voltages Shown in Table I--Column A*

**Maximum Ratings, Absolute Values:**

|   |           |       |
|---|-----------|-------|
| SUPPLY VOLTAGE BETWEEN ANODE AND CATHODE (DC) . . . . .                       | 2400 max. | volts |
| SUPPLY VOLTAGE BETWEEN DYNODE No.14 AND ANODE (DC) . . . . .                  | 400 max.  | volts |
| SUPPLY VOLTAGE BETWEEN CONSECUTIVE DYNODES (DC) . . . . .                     | 500 max.  | volts |
| SUPPLY VOLTAGE BETWEEN ACCELERATING-ELECTRODE AND DYNODE No.13 (DC) . . . . . | ±500 max. | volts |
| DYNODE-No.1 SUPPLY VOLTAGE (DC) . . . . .                                     | 400 max.  | volts |
| FOCUSING-ELECTRODE SUPPLY VOLTAGE (DC) . . . . .                              | 400 max.  | volts |
| AVERAGE ANODE CURRENT . . . . .   | 2 max.    | ma    |
| AMBIENT TEMPERATURE . . . . .   | 75 max.   | °C    |

**Characteristics Range Values for Equipment Design:**

*With E = 2000 volts (except as noted) and Focusing-Electrode as well as Accelerating-Electrode Voltage adjusted to give maximum gain*

|   | <i>Min.</i> | <i>Median</i>           | <i>Max.</i>             |           |
|---|-------------|-------------------------|-------------------------|-----------|
| <b>Sensitivity:</b>   |             |                         |                         |           |
| Radiant, at 4400 angstroms . . . . .  | -           | 0.7                     | -                       | amp/μw    |
| Cathode Radiant, at 4400 angstroms . . . . .  | -           | 0.056                   | -                       | μa/μw     |
| <b>Luminous:#</b>   |             |                         |                         |           |
| At 0 cps . . . . .  | 120         | 875                     | 4500                    | amp/lumen |
| With dynode No.14 as output electrode† . . . . .  | -           | 612                     | -                       | amp/lumen |
| <b>Cathode Luminous:</b>  |             |                         |                         |           |
| With tungsten light source▲ . . . . .   | 50          | 70                      | -                       | μa/lumen  |
| With blue light source** . . . . .  | 0.05        | -                       | -                       | μa        |
| <b>Current Amplification . . . . .</b>  |             |                         |                         |           |
|   | -           | 12.5 x 10 <sup>6</sup>  | -                       |           |
| <b>Equivalent Anode-Dark-Current Input# . . . . .</b>   |             |                         |                         |           |
|   | -           | 5 x 10 <sup>-10</sup>   | 2 x 10 <sup>-9</sup>    | lumen     |
| <b>Equivalent Noise Input:★</b>   |             |                         |                         |           |
| At +250° C. . . . .   | -           | 3.3 x 10 <sup>-12</sup> | 1.5 x 10 <sup>-11</sup> | lumen     |
| At -50° C. . . . .  | -           | 9 x 10 <sup>-13</sup>   | -                       | lumen     |
| <b>Anode-Pulse Rise Time□ . . . . .</b>   |             |                         |                         |           |
|   | -           | 3                       | -                       | milliμsec |
| <b>Greatest Delay Between Anode Pulses:</b>   |             |                         |                         |           |
| Due to position from which electrons are simultaneously released within a circle centered on tube face and having a diameter of-- |             |                         |                         |           |
| 1.12" . . . . .   | -           | 0.5‡                    | -                       | milliμsec |
| 1.5" . . . . .  | -           | 1‡                      | -                       | milliμsec |

**HIGH-OUTPUT-PULSE SERVICE**

*With Supply Voltage (E) Across Voltage Divider Providing Electrode Voltages Shown in Table I--Column B*

**Maximum Ratings, Absolute Values:**

|  |           |       |
|--|-----------|-------|
| SUPPLY VOLTAGE BETWEEN ANODE AND CATHODE (DC) . . . . .      | 2800 max. | volts |
| SUPPLY VOLTAGE BETWEEN DYNODE No.14 AND ANODE (DC) . . . . . | 400 max.  | volts |

|   |           |       |
|---|-----------|-------|
| SUPPLY VOLTAGE BETWEEN CONSECUTIVE DYNODES (DC) . . . . .                     | 500 max.  | volts |
| SUPPLY VOLTAGE BETWEEN ACCELERATING-ELECTRODE AND DYNODE No.13 (DC) . . . . . | ±500 max. | volts |
| DYNODE-No.1 SUPPLY VOLTAGE (DC) . . . . .                                     | 400 max.  | volts |
| FOCUSING-ELECTRODE SUPPLY VOLTAGE (DC) . . . . .                              | 400 max.  | volts |
| AVERAGE ANODE CURRENT . . . . .   | 2 max.    | ma    |
| AMBIENT TEMPERATURE . . . . .   | 75 max.   | °C    |

**Characteristics Range Values for Equipment Design:**

*With E = 2400 volts (except as noted) and Focusing-Electrode as well as Accelerating-Electrode Voltage adjusted to give maximum gain*

|   | <i>Min.</i> | <i>Median</i>           | <i>Max.</i> |           |
|---|-------------|-------------------------|-------------|-----------|
| <b>Sensitivity:</b>                                   |             |                         |             |           |
| Radiant, at 4400 angstroms . . . . .                  | -           | 0.7                     | -           | amp/μw    |
| Cathode Radiant, at 4400 angstroms . . . . .          | -           | 0.056                   | -           | μa/μw     |
| <b>Luminous:#</b>                                     |             |                         |             |           |
| At 0 cps . . . . .                                    | -           | 875                     | -           | amp/lumen |
| With dynode No.14 as output electrode† . . . . .      | -           | 612                     | -           | amp/lumen |
| <b>Cathode Luminous:</b>                              |             |                         |             |           |
| With tungsten light source▲ . . . . .                 | 50          | 70                      | -           | μa/lumen  |
| With blue light source** . . . . .                    | 0.05        | -                       | -           | μa        |
| <b>Current Amplification . . . . .</b>                |             |                         |             |           |
|   | -           | 12.5 x 10 <sup>6</sup>  | -           |           |
| <b>Equivalent Anode-Dark-Current Input# . . . . .</b> |             |                         |             |           |
|   | -           | 1.1 x 10 <sup>-9</sup>  | -           | lumen     |
| <b>Equivalent Noise Input:★</b>                       |             |                         |             |           |
| At +250° C. . . . .                                   | -           | 4.6 x 10 <sup>-12</sup> | -           | lumen     |
| At -50° C. . . . .                                    | -           | 1.2 x 10 <sup>-12</sup> | -           | lumen     |

**TABLE I**

| VOLTAGE TO BE PROVIDED BY DIVIDER |  |   |
|-----------------------------------|--|---|
| Between                           | COLUMN A                                 | COLUMN B                                  |
|                                   | 5.4% of Supply Voltage (E) multiplied by | 2.75% of Supply Voltage (E) multiplied by |
| Cathode and Focusing Electrode    | ♣  | ♣   |
| Cathode and Dynode No.1           | 2  | 2   |
| Dynode No.1 and Dynode No.2       | 1  | 1   |
| Dynode No.2 and Dynode No.3       | 1  | 1   |
| Dynode No.3 and Dynode No.4       | 1  | 1   |
| Dynode No.4 and Dynode No.5       | 1  | 1   |
| Dynode No.5 and Dynode No.6       | 1  | 1   |
| Dynode No.6 and Dynode No.7       | 1  | 1.2                                       |
| Dynode No.7 and Dynode No.8       | 1  | 1.5                                       |
| Dynode No.8 and Dynode No.9       | 1  | 1.9                                       |
| Dynode No.9 and Dynode No.10      | 1  | 2.4                                       |
| Dynode No.10 and Dynode No.11     | 1  | 3.0                                       |
| Dynode No.11 and Dynode No.12     | 1.25                                     | 3.8                                       |
| Dynode No.12 and Dynode No.13     | 1.5                                      | 4.8                                       |
| Dynode No.13 and Dynode No.14     | 1.75                                     | 6   |
| Dynode No.14 and Anode            | 2  | 4.8                                       |
| Anode and Cathode                 | 18.5                                     | 36.4                                      |



- Averaged over any interval of 30 seconds maximum.
- # Under the following conditions: The light source is a tungsten-filament lamp operated at a color temperature of 2870° K. A light input of 0.1 microlumen is used. The load resistor has a value of 0.01 megohm.
- † An output current of opposite polarity to that obtained at the anode may be provided by using dynode No.14 as the output electrode. With this arrangement, the load is connected in the dynode-No.14 circuit and the anode serves only as collector.
- ▲ Under the following conditions: The light source is a tungsten-filament lamp operated at a color temperature of 2870° K. The value of light flux is 0.01 lumen and 200 volts are applied between cathode and all other electrodes connected together as anode. The load resistor has a value of 0.01 megohm.
- \*\* Under the following conditions: Light incident on the cathode is transmitted through a blue filter (Corning, Glass Code No.5113 polished to 1/2 stock thickness) from a tungsten-filament lamp operated at a color temperature of 2870° K. The value of light flux on the filter is 0.01 lumen. The load resistor has a value of 0.01 megohm and 200 volts are applied between cathode and all other electrodes connected together as anode.
- ⊕ Measured at a tube temperature of 25° C and with the supply voltage (E) adjusted to give a luminous sensitivity of 2000 amperes per lumen. Dark current caused by thermionic emission may be reduced by the use of a refrigerant.
- For maximum signal-to-noise ratio, operation with a supply voltage (E) below 2000 volts is recommended.
- ★ Under the following conditions: Supply voltage (E) is 2000 volts, 25° C tube temperature, external shield potential of -2000 volts, ac-amplifier bandwidth of 1 cycle per second, tungsten light source of 2870° K interrupted at a low audio frequency to produce incident radiation pulses alternating between zero and the value stated. The "on" period of the pulse is equal to the "off" period. The output current is measured through a filter which passes only the fundamental frequency of the pulses.
- Measured between 10 per cent and 90 per cent of maximum anode-pulse height. This anode-pulse rise time is determined primarily by transit-time variations in the multiplier stages and with an incident light spot approximately 1 millimeter in diameter centered on the photocathode.
- ‡ These values also represent the difference in time of transit between the photocathode and dynode No.1 for electrons simultaneously released from the center and from the periphery of the specified areas.
- ♣ Measured at a tube temperature of 25° C and with the supply voltage (E) adjusted to give a luminous sensitivity of 2000 amperes per lumen. Dark current caused by thermionic emission may be reduced by the use of a refrigerant.
- ⊕ For maximum signal-to-noise ratio, operation with a supply voltage (E) below 2300 volts is recommended.
- ★★ Same as (★) except the supply voltage (E) is 2400 volts, and the external shield potential is -2400 volts.
- ♣ Focusing electrode is connected to arm of potentiometer between cathode and dynode No.1. Focusing-electrode voltage is adjusted to give maximum gain.

### DEFINITIONS

- Radiant Sensitivity.** The quotient of output current by incident radiant power of a given wavelength, at constant electrode voltages.
- Cathode Radiant Sensitivity.** The quotient of current leaving the photocathode by incident radiant power of a given wavelength.
- Luminous Sensitivity.** The quotient of output current by incident luminous flux, at constant electrode voltages.
- Current Amplification.** Ratio of the output current to the photocathode current, at constant electrode voltages.
- Equivalent Anode-Dark-Current Input.** The quotient of the anode dark current by the luminous sensitivity.
- Equivalent Noise Input.** That value of incident luminous flux which when modulated in a stated manner produces an rms output current equal to the rms noise current within a specified bandwidth.
- Pulse Rise Time.** The time required for the instantaneous amplitude of the pulse to go from 10 per cent to 90 per cent of the peak value.

### OPERATING CONSIDERATIONS

The *maximum ratings* in the tabulated data are established in accordance with the following definition of the *Absolute-Maximum Rating System* for rating electron devices.

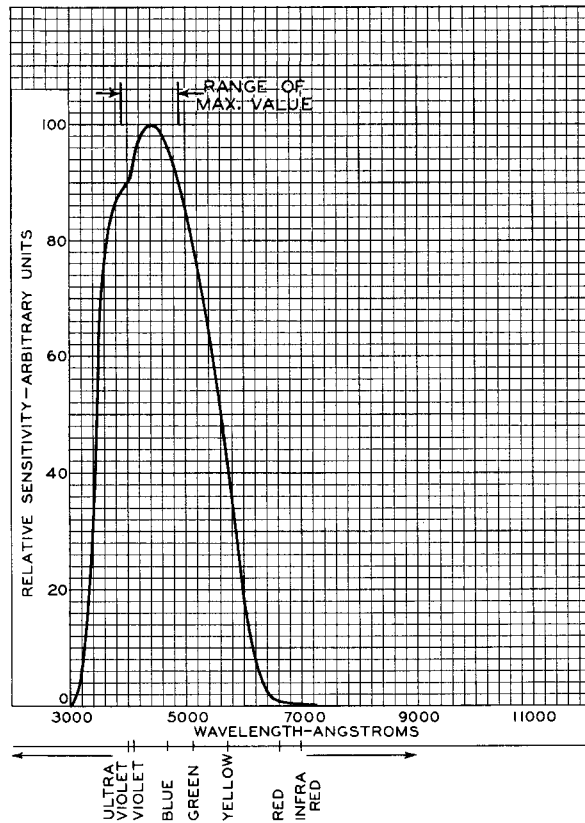

92CM-8601

Fig. 1 - Spectral Sensitivity Characteristic of Type 7264 which has S-11 Response. Curve is shown for Equal Values of Radiant Power at All Wavelengths.

Absolute-Maximum ratings are limiting values of operating and environmental conditions applicable to any electron device of a specified type as defined by its published data, and should not be exceeded under the worst probable conditions.

The device manufacturer chooses these values to provide acceptable serviceability of the device, taking no responsibility for equipment variations, environment variations, and the effects of changes in operating conditions due to variations in device characteristics.

The equipment manufacturer should design so that initially and throughout life no absolute-maximum value for the intended service is exceeded with any device under the worst probable operating conditions with respect to supply-voltage variation, equipment component variation,



equipment control adjustment, load variation, signal variation, environmental conditions, and variations in device characteristics.

In general, *supply voltages* for the electrodes of the 7264 should be provided as shown in Table I. For *applications involving very low*

in Fig.2, it will be seen that saturation occurs in the approximate range of 50 to 100 volts. With low operating voltage between dynode No.14 and anode, the dark current is reduced. As a result, the operating stability of the 7264 is improved without sacrifice in sensitivity. To obtain the

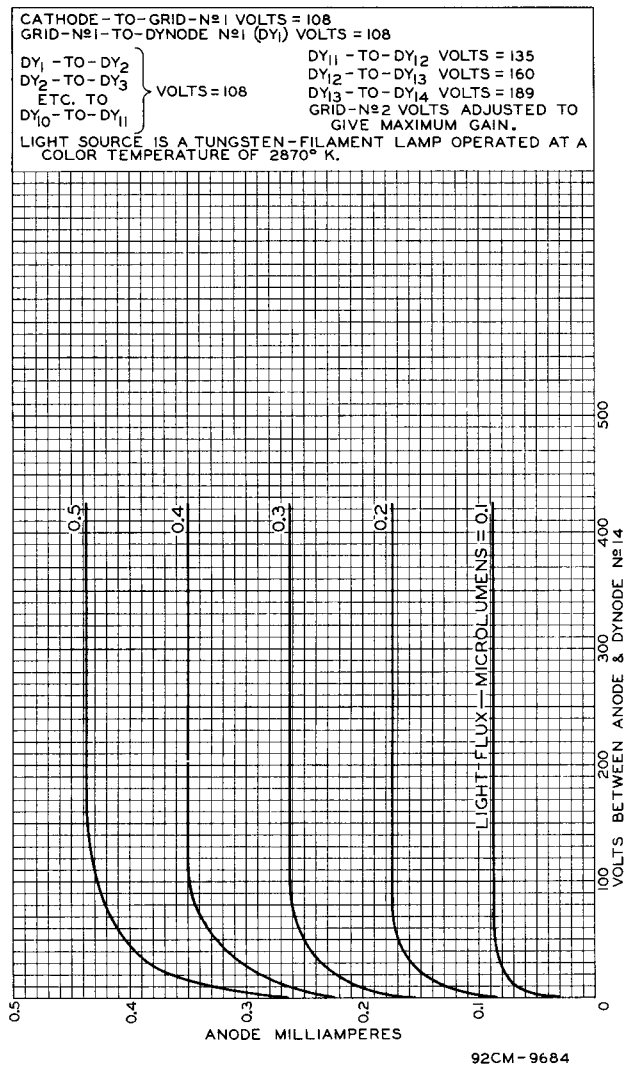

Fig.2 - Typical Anode Characteristics of Type 7264 Used in Low-Light-Level, Low-Noise, High-Gain Service.

light levels and requiring high signal-to-noise ratio and high gain, supply voltages should be provided as shown in Table I--Column A. For applications requiring high output pulses, higher operating voltages may be used as shown in Table I--Column B.

The operating voltage between dynode No.14 and anode should be kept as low as will permit operation with anode-current saturation. Referring to the anode characteristics curves, shown

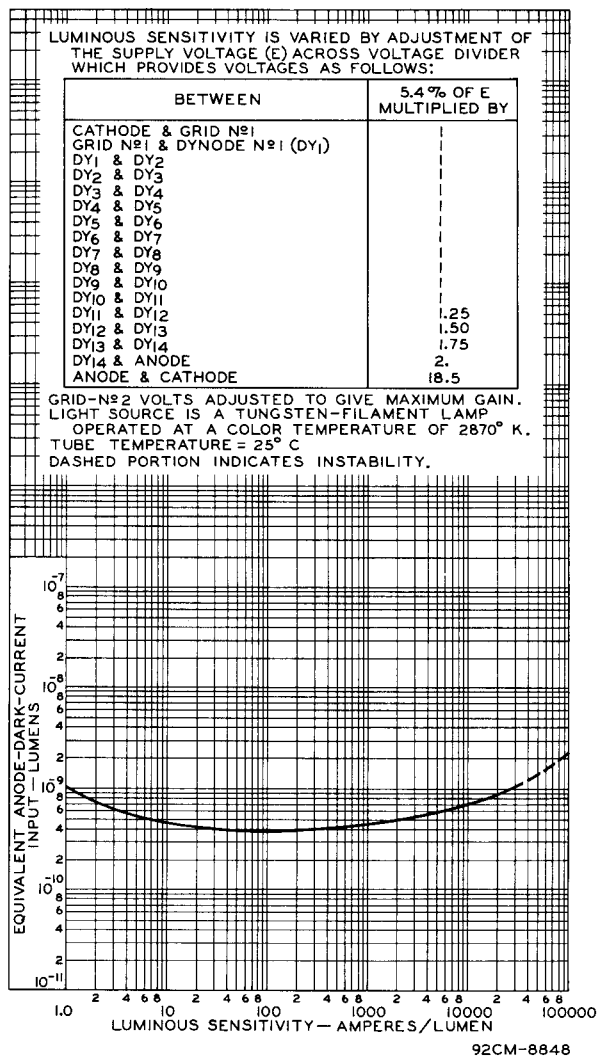

Fig.3 - Typical Anode-Dark-Current Characteristic of Type 7264 Used in Low-Light-Level, Low-Noise, High-Gain Service.

indicated operating voltage between dynode No.14 and anode, it will be necessary to increase the supply voltage between these electrodes above the operating voltage by an amount to allow for the signal-output voltage desired.

The *focusing-electrode potential* may be adjusted between that of the photocathode and that of dynode No.1 to optimize the magnitude, uniformity, or speed of the response. The voltage for the focusing electrode can be obtained by



connecting it to the arm of a potentiometer between cathode and dynode No. 1 in the voltage divider.

The *accelerating electrode*, when operated at a suitable potential with respect to dynode No. 13, serves to minimize the effect of space charge in the region of dynode No. 12. Provision should

distribution at the taps of the shunted section of the divider. Within the specified adjustment range, it will be found that the accelerating-electrode voltage may be adjusted to obtain either maximum gain or maximum peak output current. In general, the adjustment to apply the

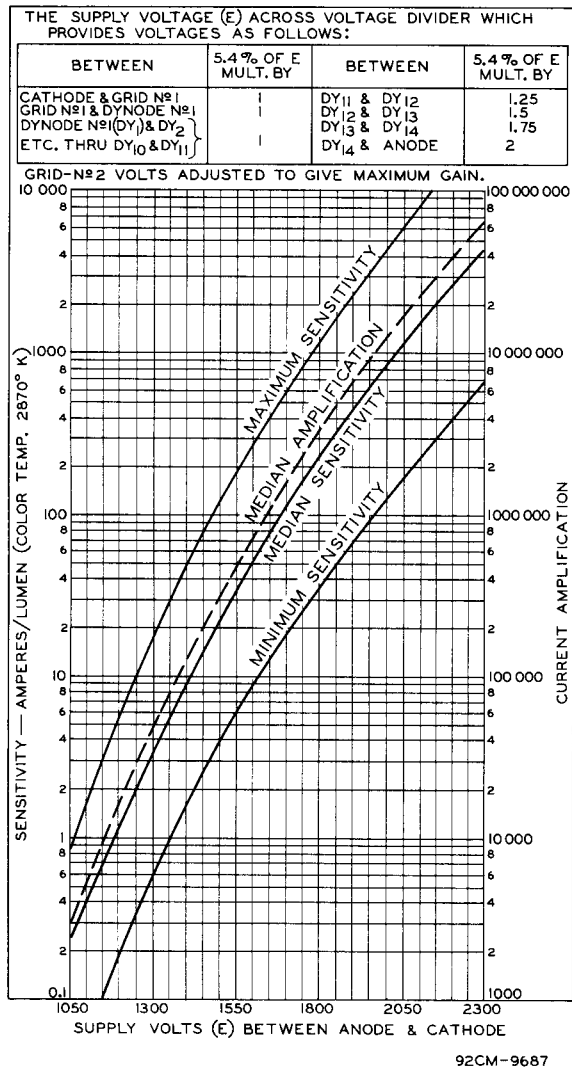

Fig. 4 - Characteristics of Type 7264 Used in Low-Light-Level, Low-Noise, High-Gain Service.

be made to adjust the accelerating-electrode voltage over a range extending from the value at which dynode No. 13 operates to that at which the anode operates. The adjustment may be accomplished by means of a high-resistance potentiometer connected between the voltage-divider tap for dynode No. 13 and the anode end of the voltage divider. Since the accelerating electrode draws at most only negligible current, the potentiometer can have sufficiently high resistance so that it will not substantially affect the voltage

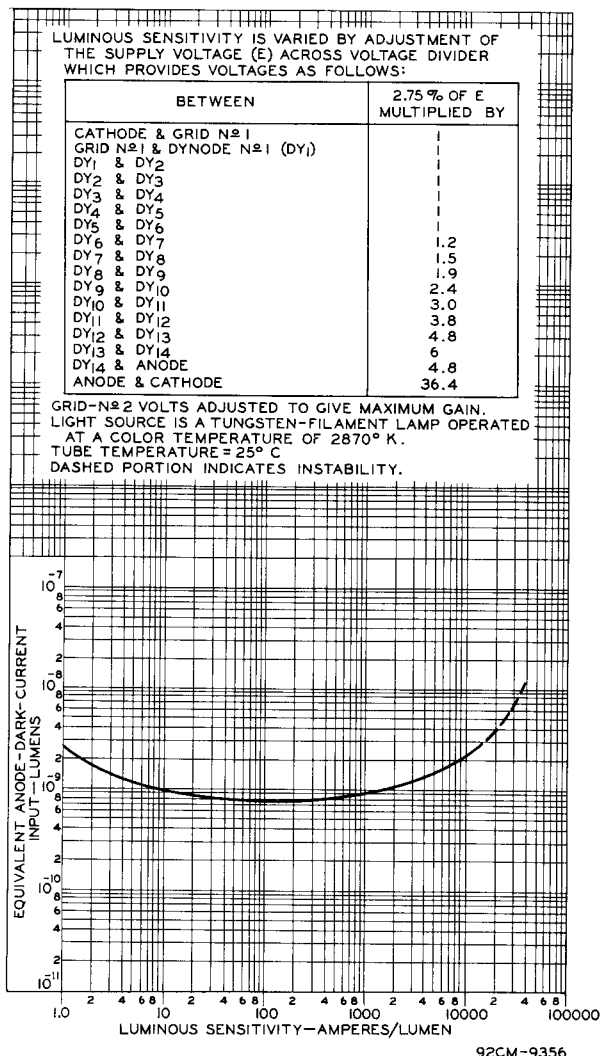

Fig. 5 - Typical Anode-Dark-Current Characteristic of Type 7264 Used in High-Output-Pulse Service.

highest voltage to the accelerating electrode will permit the highest peak current with some sacrifice in gain.

In applications where it is desired to keep the statistical fluctuations to a minimum, e.g., as in nuclear radiation spectroscopy, the potential between cathode and dynode No. 1 may be increased to the rated maximum value of 400 volts.

A very small *dark current* is observed when voltage is applied to the electrodes of the 7264



in complete darkness. This current has a component caused by leakage, and a component consisting of pulses produced by electrons thermionically released from the cathode, by secondary electrons released by ionic bombardment of the dynodes or cathode, or by cold emission from the electrodes.

of luminous sensitivity for the 7264 and the curve in Fig.4 or Fig.6 which shows luminous sensitivity as a function of the supply voltage. The voltage between dynode No.14 and the anode should be kept as low as will permit operation at a point just giving anode-current saturation.

In applications involving low-light-level pulsed excitation and ac coupling at the anode, the best signal-to-noise ratio is obtained with a supply voltage (E) in the range from 1500 to 2000 volts. Within this range, the noise at the anode is produced primarily by the statistical release of thermal electrons, and the noise power spectrum is essentially flat up to about 50 megacycles per second. Regenerative phenomena, which may occur at voltages above 2000 volts, contribute to the noise.

The noise spectrum of the 7264 is such that the threshold of pulse detection depends on the associated circuitry. The bandpass filter should be designed to pass only the frequency range of the exciting signal in order to eliminate as much noise as possible.

In applications where maximum gain with unusually low dark current is required, the use of a refrigerant, such as dry ice, to cool the bulb of the 7264 is recommended. The resulting reduction in thermionic emission from the cathode lowers the detection threshold to give improved operation.

Exposing the 7264 to strong ultraviolet radiation may cause an increase in anode dark current. After cessation of such irradiation, the dark current drops rapidly.

The operating stability of the 7264 is dependent on the magnitude of the anode current and its duration. When the 7264 is operated at high average values of anode current, a drop in sensitivity (sometimes called fatigue) may be expected. The extent of the drop below the tabulated sensitivity values depends on the severity of the operating conditions. After a period of idleness, the 7264 usually recovers a substantial percentage of such loss in sensitivity.

The use of an average anode current well below the maximum rated value of 2 milliamperes is recommended when stability of operation is important. When maximum stability is required, the anode current should not exceed 250 microamperes.

Electrostatic and/or magnetic shielding of the 7264 may be necessary. It is to be noted that the use of an external magnetic and/or electrostatic shield at high negative potential presents a safety hazard unless the shield is connected through a high impedance in the order of 10 megohms to the potential. If the shield is not so connected, extreme care should be observed in providing adequate safeguards to prevent personnel from coming in contact with the high potential of the shield.

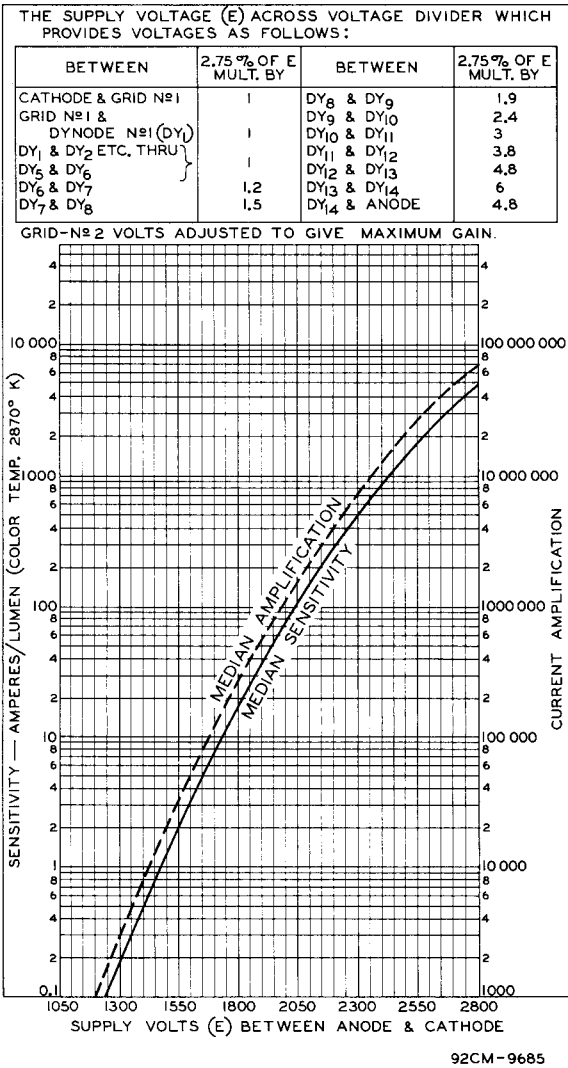

Fig.6 - Characteristics of Type 7264 Used in High-Output-Pulse Service.

The magnitude of the dark current establishes a limit below which the exciting radiation on the cathode can not be detected.

When the application utilizes continuous luminous excitation and dc anode current, and it is desired to have a high ratio of signal output to dark current, it is recommended that the operating supply voltage (E) be determined with reference to the curve in Fig.3 or Fig.5 which shows the equivalent anode-dark-current input as a function



Adequate *light shielding* should be provided to prevent extraneous light from reaching any part of the 7264. Although the metallic coating on the inner side wall of the glass bulb serves

The value should also be adequate to prevent variations of the dynode potentials by the signal current. In most applications, it is recommended that the positive high-voltage terminal be grounded

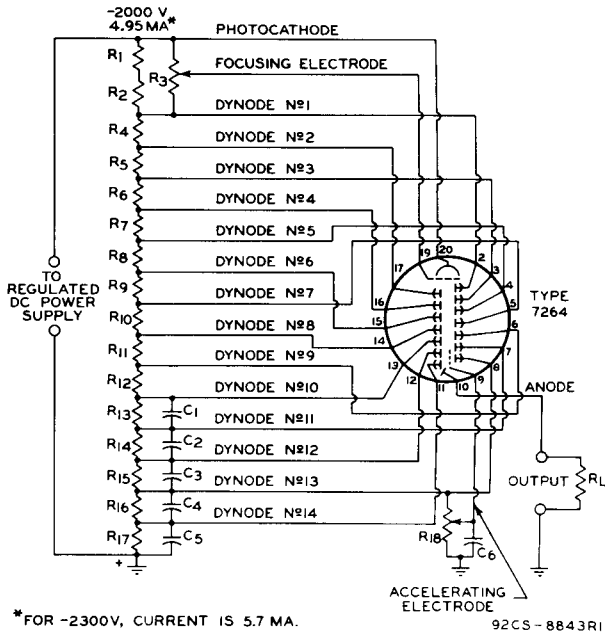

\* FOR -2300V, CURRENT IS 5.7 MA.

92CS-8843R1

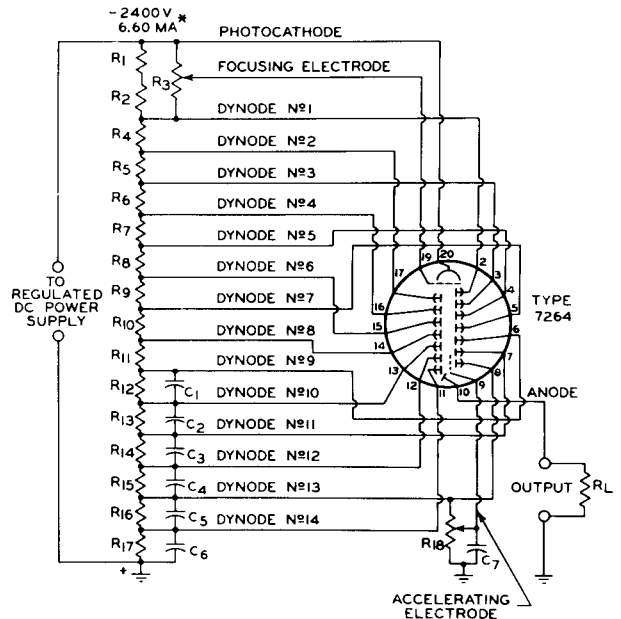

\* FOR -2800V, CURRENT IS 7.70 MA

92CS-9353

- C<sub>1</sub> = 25  $\mu\text{f}$ , disk ceramic, 600 volts (dc working)
- C<sub>2</sub> = 50  $\mu\text{f}$ , disk ceramic, 600 volts (dc working)
- C<sub>3</sub> = 100  $\mu\text{f}$ , disk ceramic, 600 volts (dc working)
- C<sub>4</sub> = 250  $\mu\text{f}$ , disk ceramic, 600 volts (dc working)
- C<sub>5</sub> = 500  $\mu\text{f}$ , disk ceramic, 600 volts (dc working)
- C<sub>6</sub> = 100  $\mu\text{f}$ , disk ceramic, 1000 volts (dc working)
- R<sub>1</sub> = 24000 ohms, 1 watt
- R<sub>2</sub> = 22000 ohms, 1 watt
- R<sub>3</sub> = 1 megohm, 2 watts, adjustable
- R<sub>4</sub> through R<sub>13</sub> = 22000 ohms, 1 watt
- R<sub>14</sub> = 27000 ohms, 2 watts
- R<sub>15</sub> = 33000 ohms, 2 watts
- R<sub>16</sub> = 39000 ohms, 2 watts
- R<sub>17</sub> = 43000 ohms, 2 watts
- R<sub>18</sub> = 10 megohms, 2 watts, adjustable

RL = Value will depend on magnitude of peak pulse voltage desired. For a peak pulse amplitude of 100 volts, the value is approximately 300 ohms.

Note: Capacitors C<sub>1</sub> through C<sub>6</sub> should be connected at tube socket.

Fig. 7 - Voltage-Divider Arrangement for Type 7264 Used in Low-Light-Level, Low-Noise, High-Gain Service.

to reduce the amount of extraneous light reaching the electrodes, it is inadequate to shield completely the entire structure from extraneous light.

The dc supply voltages for each dynode and for the anode can be supplied by spaced taps on a voltage divider across a regulated dc power supply. The current through the voltage divider will depend on the voltage regulation and the linearity required by the application. In general, the current in the divider should be several times the maximum value of anode current.

- C<sub>1</sub> = 25  $\mu\text{f}$ , disk ceramic, 600 volts (dc working)
- C<sub>2</sub> = 39  $\mu\text{f}$ , disk ceramic, 600 volts (dc working)
- C<sub>3</sub> = 150  $\mu\text{f}$ , disk ceramic, 600 volts (dc working)
- C<sub>4</sub> = 750  $\mu\text{f}$ , disk ceramic, 600 volts (dc working)
- C<sub>5</sub> = 4000  $\mu\text{f}$ , disk ceramic, 600 volts (dc working)
- C<sub>6</sub> = 40000  $\mu\text{f}$ , (4-10000  $\mu\text{f}$  disk ceramic, 600 volts (dc working) connected in parallel)

- C<sub>7</sub> = 150  $\mu\text{f}$ , disk ceramic, 1000 volts (dc working)
- R<sub>1</sub> = 10000 ohms, 1 watt
- R<sub>2</sub> = 10000 ohms, 1 watt
- R<sub>3</sub> = 1 megohm, 2 watts, adjustable
- R<sub>4</sub> through R<sub>8</sub> = 10000 ohms, 1 watt
- R<sub>9</sub> = 12000 ohms, 1 watt
- R<sub>10</sub> = 15000 ohms, 1 watt
- R<sub>11</sub> = 20000 ohms, 2 watts
- R<sub>12</sub> = 24000 ohms, 2 watts
- R<sub>13</sub> = 30000 ohms, 2 watts
- R<sub>14</sub> = 39000 ohms, 4 watts
- R<sub>15</sub> = 47000 ohms, 4 watts
- R<sub>16</sub> = 60000 ohms, 4 watts
- R<sub>17</sub> = 47000 ohms, 4 watts
- R<sub>18</sub> = 1 megohm, 2 watts, adjustable

RL = Value will depend on magnitude of peak pulse voltage desired. For a peak pulse amplitude of 100 volts, the value is approximately 200 ohms.

Note: Capacitors C<sub>1</sub> through C<sub>7</sub> should be connected at tube socket.

Fig. 8 - Voltage-Divider Arrangement for Type 7264 Used in High-Output-Pulse Service.

in order that the output signal will be produced between anode and ground. This method prevents power-supply fluctuations from being coupled directly into the signal-output circuit.

Typical voltage-divider arrangements for use with the 7264 are shown in Figs. 7 and 8.



The high voltages at which the 7264 is operated are very dangerous. Care should be taken in the design of apparatus to prevent the operator from coming in contact with these high voltages. Precautions should include the enclosure of high-potential terminals and the use of interlock switches to break the primary circuit of the high-voltage power supply when access to the apparatus is required.

In the use of the 7264, as with other tubes requiring high voltages, it should always be remembered that these high voltages may appear at points in the circuit which are normally at low potential, because of defective circuit parts or incorrect circuit connections. Therefore, before any part of the circuit is touched, the power-supply switch should be turned off and both terminals of any capacitors grounded.

### DIMENSIONAL OUTLINE

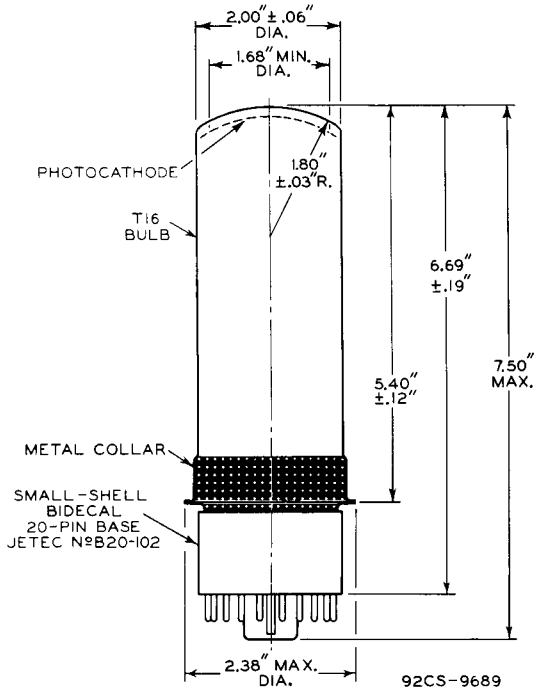

☉ OF BULB WILL NOT DEVIATE MORE THAN 2° IN ANY DIRECTION FROM THE PERPENDICULAR ERECTED AT THE CENTER OF THE BOTTOM OF THE BASE.

### SOCKET CONNECTIONS

#### Bottom View

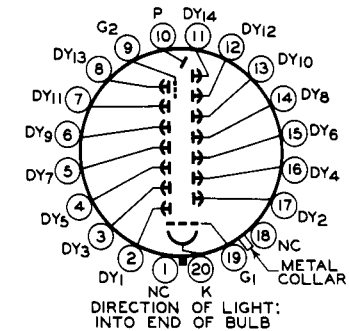

#### 20D

- PIN 1: NO CONNECTION
  - PIN 2: DYNODE No.1
  - PIN 3: DYNODE No.3
  - PIN 4: DYNODE No.5
  - PIN 5: DYNODE No.7
  - PIN 6: DYNODE No.9
  - PIN 7: DYNODE No.11
  - PIN 8: DYNODE No.13
  - PIN 9: GRID No.2 (ACCELERATING ELECTRODE)
  - PIN 10: ANODE
  - PIN 11: DYNODE No.14
  - PIN 12: DYNODE No.12
  - PIN 13: DYNODE No.10
  - PIN 14: DYNODE No.8
  - PIN 15: DYNODE No.6
  - PIN 16: DYNODE No.4
  - PIN 17: DYNODE No.2
  - PIN 18: NO CONNECTION
  - PIN 19: GRID No.1 (FOCUSING ELECTRODE)
  - PIN 20: PHOTOCATHODE
  - METAL COLLAR: NO CONNECTION.
- NOTE - If used, connect only to photocathode.

Devices and arrangements shown or described herein may use patents of RCA or others. Information contained herein is furnished without responsibility by RCA for its use and without prejudice to RCA's patent rights.