

**Röhrentype:** Triode-Hexode, Mischröhre für Überlagerungsempfänger.  
**Type de tube:** Triode-hexode, changeuse de fréquence pour superhétérodynes.  
**Type of tube:** Triode-hexode, frequency converter for superheterodyne receivers.

Heizung ind., Gleich- oder Wechselstrom, Serienspeisung  
 Chauffage ind., CA ou CQ, alimentation en série  
 Heating ind., A.C. or D.C., series heater supply

	Vf	20 V
	If	0,100 A

Kapazitäten  
 Capacités  
 Capacities

a) Hexodenteil	Cg1	6	µF	
Partie hexode	Ca	9	µF	
Hexode section	Cag1	<0,001	µF	
	Cg1f	<0,001	µF	
b) Triodenteil	Cg	4,6	µF	
Partie triode	Ca	2,5	µF	
Triode section	C&g	1,6	µF	
c) Zwischen Hexoden- und Triodenteil				
Entre les parties hexode et triode	CgTg1H	<0,2	µF	
Between hexode and triode section				

Betriebsdaten des Hexodenteiles als Mischröhre.  
 Caractéristiques de service de la partie hexode comme changeuse de fréquence.  
 Operating conditions for use of the hexode section as frequency converter.

a) Feste Schirmgitterspannung  
 Tension de grille-écran fixe  
 Fixed screen-grid voltage

Va	100		200		V	
Vg2,4	40		80		V	
Rk	250		250		Ω	
Rg3	50000		50000		Ω	
Ig3	100		160		µA	
Vg1	-11)	-7,5 <sup>2)</sup>	-8,5 <sup>3)</sup>	-21)	-12,5 <sup>2)</sup>	-14 <sup>3)</sup>
Ia	1,2	-	-	2,5	-	mA
Ig2+Ig4	1,5	-	-	3	-	mA
Sc	450	4,5	2,25	750	7,5	3,75
Ri	0,6	-	-	1	-	MΩ

b) Gleitende Schirmgitterspannung  
 Tension de grille-écran glissante  
 Sliding screen-grid voltage

Va	100		200		V
Rg2,4	40000		40000		Ω
Rk	250		250		Ω
Rg3	50000		50000		Ω
Ig3	100		160		µA

Vg <sub>1</sub>	-1 <sup>1)</sup>	-11,5 <sup>2)</sup>	-14,5 <sup>3)</sup>	-2 <sup>1)</sup>	-18,5 <sup>2)</sup>	-24 <sup>3)</sup>	V
Vg <sub>2,4</sub>	40	-	100	80	-	190	V
I <sub>a</sub>	1,2	-	-	2,5	-	-	mA
Ig <sub>2+Ig4</sub>	1,5	-	-	3	-	-	mA
Sc	450	4,5	1,1	750	7,5	1,9	μA/V
R <sub>i</sub>	0,6	-	-	1	-	-	MΩ

1) Im unregelmäßigen Zustand.

Tube non réglé par le C.A.V.  
Tube not controlled by A.V.C.

2) Für eine Regelung der Mischsteilheit 1:100.

Pour le réglage de la pente de conversion de 1:100.  
For a regulation of the conversion conductance of 1:100.

3) Grenze des optimalen Regelbereiches.

Limite de la plage de réglage optimum.  
Limit of the optimum regulation range.

Betriebsdaten des Triodenteiles als Oszillator.

Caractéristiques de service de partie triode, utilisation comme oscillatrice.

Operating conditions for use of the triode section as oscillator.

V <sub>b</sub>	200	-	200	V
V <sub>a</sub>	60	150	115	V
R <sub>a</sub>	30000	-	30000	Ω
I <sub>a</sub> (R <sub>g</sub> = 50.000 Ω, I <sub>g</sub> = 100 μA)	1,4	-	-	mA
I <sub>a</sub> (R <sub>g</sub> = 50.000 Ω, I <sub>g</sub> = 160 μA)	-	-	2,8	mA
S	-	3,4	-	mA/V
μ	-	17	-	

Grenzdaten des Hexodenteiles.

Limites fixées pour l'utilisation de la partie hexode.

Limiting values for operation of the hexode section.

V <sub>ao</sub>	max.	550	V
V <sub>a</sub>	max.	250	V
W <sub>a</sub>	max.	1,5	W
Vg <sub>2,4o</sub>	max.	550	V
Vg <sub>2,4</sub> (I <sub>a</sub> = 2,5 mA)	max.	125	V
Vg <sub>2,4</sub> (I <sub>a</sub> < 0,5 mA)	max.	250	V
Wg <sub>2,4</sub>	max.	0,5	W
Vg <sub>1</sub> (I <sub>g1</sub> = +0,3 μA)	max.	-1,3	V
Vg <sub>3</sub> (I <sub>g3</sub> = +0,3 μA)	max.	-1,3	V
I <sub>k</sub>	max.	15	mA
Rg <sub>1k</sub>	max.	3	MΩ
Rg <sub>3k</sub>	max.	100000	Ω
Rfk	max.	20000	Ω
Vfk	max.	200	V <sup>4)</sup>

4) Gleichspannung oder Effektivwert der Wechselspannung.

Tension continue ou valeur efficace de la tension alternative.

D.C. voltage or R.M.S. value of the A.C. voltage.

### Grenzdaten des Triodenteiles.

Limites fixées pour l'utilisation de la partie triode.

Limiting values for the triode section

V <sub>ao</sub>	max. 550 V
V <sub>a</sub>	max. 150 V
V <sub>a</sub>	max. 1 W
V <sub>g</sub> (I <sub>g</sub> = +0,3 μA)	max. -1,3 V
R <sub>gk</sub>	max. 1.00000 Ω

Elektrodenanordnung, Sockelanschlüsse und max. Abmessungen in mm.

Disposition des électrodes, connexions du culot et dimensions max. en mm.

Electrode arrangement, base connections and max. dimensions in mm.

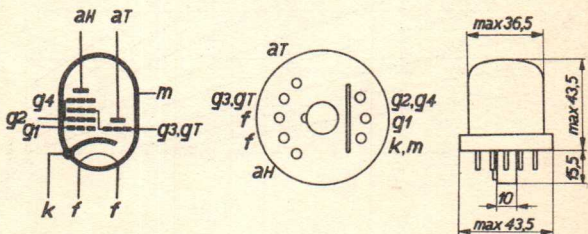

Grundsätzliche Betriebsschaltung.

Schema de principe d'utilisation.

Fundamental circuit diagram for operation.

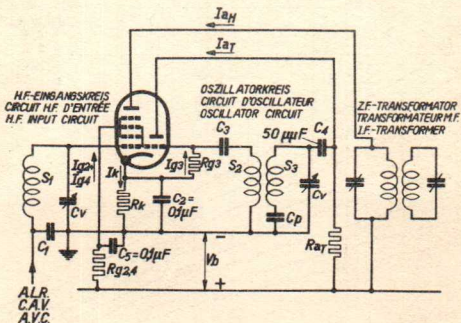

# UCH11 PHILIPS „MINIWATT”

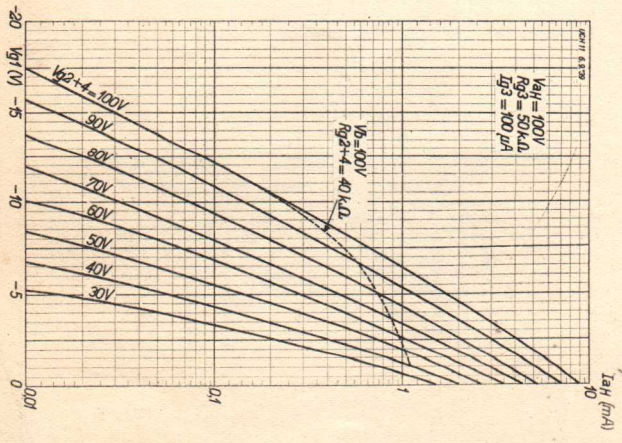
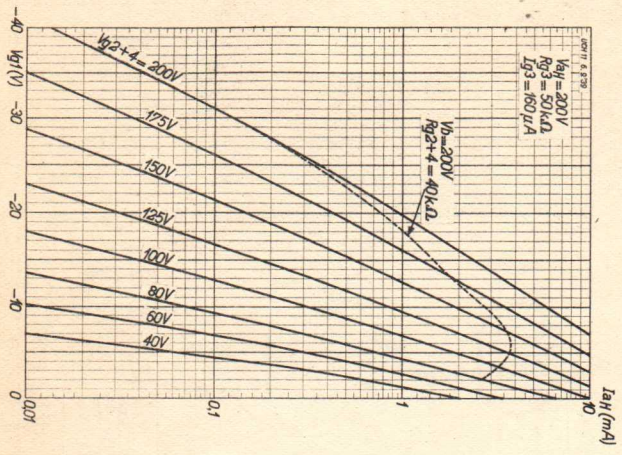

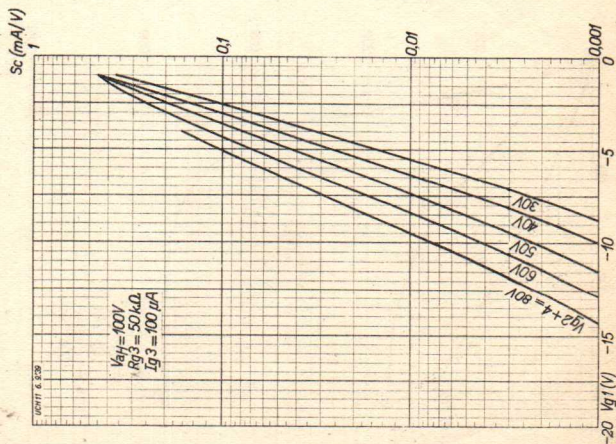
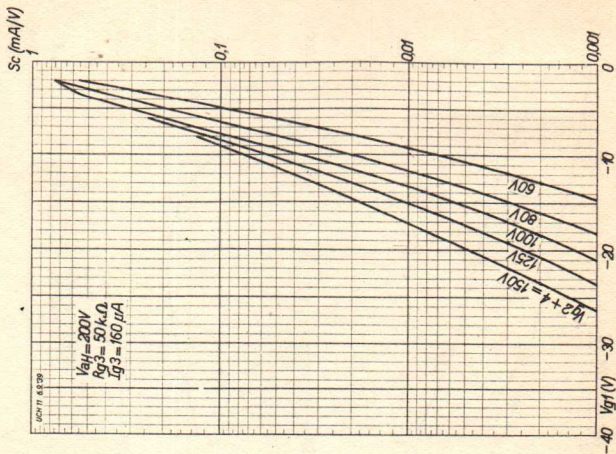

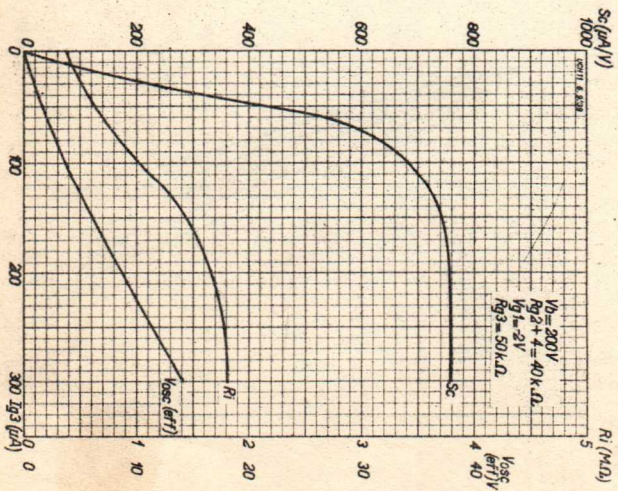
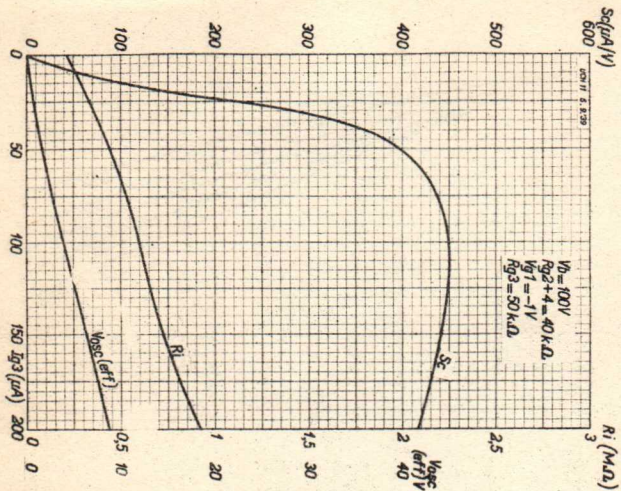

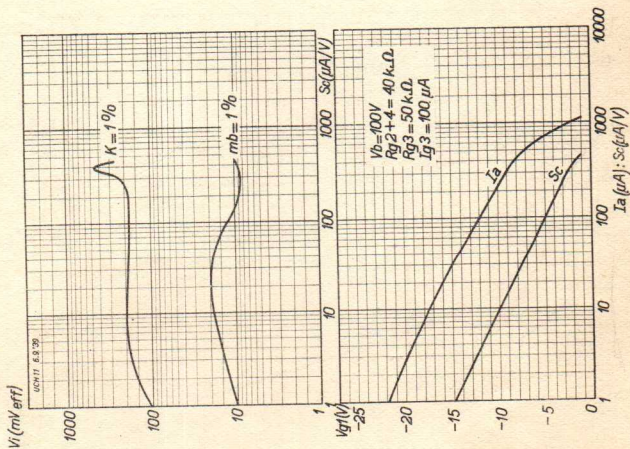
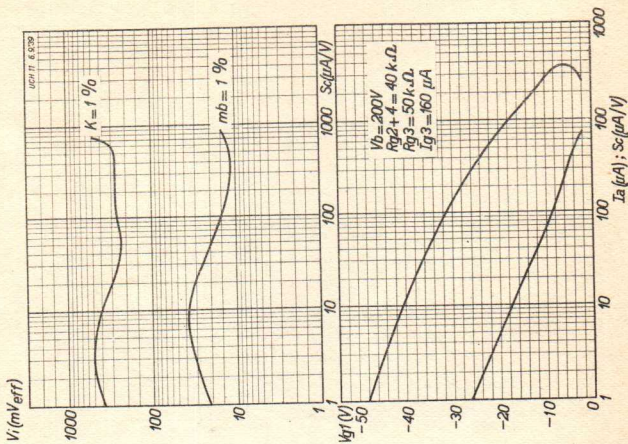

# UCH11 PHILIPS „MINIWATT”

